



**GASTROPARTS**

# Tecno MCM

- [EN]** Equipment
- [DE]** Geräte
- [ES]** Aparatos
- [FR]** Équipement
- [IT]** Attrezzature
- [PL]** Urządzenia
- [RU]** Оборудование

✉ [gastroparts@gastroparts.com](mailto:gastroparts@gastroparts.com)

☎ +48 56 657 00 66

📘 [fb.com/gastroparts.global](https://fb.com/gastroparts.global)

**GASTROPARTS.COM**





## heating elements

### heating elements for chicken rotisseries



1 			
<b>Part No.</b>	416856	<b>Ref. No.</b>	030137E
<b>description</b>	heating element 1100W 230V thread M4 L 864mm W 35mm H 44mm heating circuits 1 connection M4 dry heating element tube ø 10mm connection length 20mm		

1 			
<b>Part No.</b>	416857	<b>Ref. No.</b>	030120-E 030138-1
<b>description</b>	heating element 4800W 230V 2 hole fixing thread M14x1.25 L 860mm W 130mm H 42mm heating circuits 1 connection M5 dry heating element tube ø 10mm mounting distance 120mm for chicken rotisserie		

## switches and momentary switches

### rocker/momentary rocker switches

30x22mm

1 			
<b>Part No.</b>	301001	<b>Ref. No.</b>	06004
<b>description</b>	rocker switch mounting measurements 30x22mm red 2NO 250V 16A illuminated 0-I connection male faston 6.3mm ambient temperature max. 125/55°C protection IP65		
<b>accessories for</b>	301001		
1 			
<b>Part No.</b>	301036	<b>Ref. No.</b>	—
<b>description</b>	protective cover internal size 30x22mm for rocker switch mounting measurementsmm		

### cam switches

on/off

1 			
<b>Part No.</b>	300017	<b>Ref. No.</b>	030138E
<b>description</b>	cam switch 4 operating positions 4NO sequence 0-1-0-1 16A shaft ø 6x4.6mm shaft L 23mm connection male faston 6.3mm ceramic		

## transformers

### miscellaneous

1			
<b>Part No.</b>	400696	<b>Ref. No.</b>	020119
<b>description</b>	transformer		

## motors

### gear motors

for grills

1 			
<b>Part No.</b>	601126	<b>Ref. No.</b>	020112
<b>description</b>	gear motor 230V 50Hz 4.5rpm shaft ø 9x10mm L 120mm W 81mm H 66mm for chicken rotisserie type K80640 KELVIN		

1 			
<b>Part No.</b>	601127	<b>Ref. No.</b>	020118
<b>description</b>	gear motor 24V for chicken rotisserie		

### motors

universal

1 			
<b>Part No.</b>	500625	<b>Ref. No.</b>	140020
<b>description</b>	motor 60W 230V 50Hz 1 phase shaft ø 9mm flange ø 80mm 820rpm type 156C6 ø 110mm H 150mm L 170mm GMS 6-pole 0.06kW		





## gas taps

## COPRECI

## CAL-3200



1

<b>Part No.</b>	109097	<b>Ref. No.</b>	150015
<b>description</b>	gas tap COPRECI type CAL-3200 gas inlet M20x1.5 (tube $\varnothing$ 12mm) bypass nozzle $\varnothing$ 0.5mm gas outlet M20x1.5 (tube $\varnothing$ 12/10mm) thermocouple connection M9x1 pilot connection shaft $\varnothing$ 8x6.5mm shaft flat right shaft L 29/12mm with pipe outlet		
<b>spare parts for</b>	109097		
	<b>Part No.</b>	106173	<b>Ref. No.</b> —
	magnet unit L 43mm D1 $\varnothing$ 19mm D2 $\varnothing$ 15.5mm suitable for COPRECI		
<b>accessories for</b>	109097		
	<b>Part No.</b>	101273	<b>Ref. No.</b> —
	olive for pipe $\varnothing$ 12mm L 9.5mm brass Qty 1 pcs suitable for universal		

## CAL-5200



1



<b>Part No.</b>	107165	<b>Ref. No.</b>	030151
<b>description</b>	gas tap COPRECI type CAL-5200 gas inlet pipe flange $\varnothing$ 21mm bypass nozzle $\varnothing$ 1mm gas outlet M16x1.25 (tube $\varnothing$ 6mm) thermocouple connection M8x1 pilot connection shaft $\varnothing$ 8x6.5mm shaft L 27/12mm shaft flat left		





## STN3R



1

<b>Part No.</b>	101988	<b>Ref. No.</b>	150015-P
<b>description</b>	gas tap STN3R gas inlet M20x1.5 (tube $\varnothing$ 12mm) bypass nozzle $\varnothing$ 0mm gas outlet M20x1.5 (tube $\varnothing$ 12mm) thermocouple connection M9x1 pilot connection closed shaft $\varnothing$ 8x6mm shaft L 24/16.5mm shaft flat lower with pipe outlet suitable for TECNO MCM		
<b>spare parts for</b>	101988		
	<b>Part No.</b>	101058	<b>Ref. No.</b> —
	magnet unit L 39mm D1 $\varnothing$ 15.4mm D2 $\varnothing$ 13.5mm suitable for PEL22/EGA24197 standard		

<b>accessories for</b>	101988		
	<b>Part No.</b>	101251	<b>Ref. No.</b> —
	union nut thread M20x1.5 for pipe $\varnothing$ 12mm		
	<b>Part No.</b>	101273	<b>Ref. No.</b> —
	olive for pipe $\varnothing$ 12mm L 9.5mm brass Qty 1 pcs suitable for universal		





	<b>Part No.</b>	101962	<b>Ref. No.</b>	030112
<b>description</b>	gas tap STN3R gas inlet pipe flange bypass nozzle $\varnothing$ 0mm gas outlet M16x1.25 thermocouple connection M8x1 shaft $\varnothing$ 8x6.5mm shaft L 28/14mm shaft flat left suitable for TECNO MCM pipe outlet $\varnothing$ edge-flangemm			
<b>spare parts for</b>	101962			
	<b>Part No.</b>	101051	<b>Ref. No.</b>	—
	magnet unit L 27mm D1 $\varnothing$ 12.5mm D2 $\varnothing$ 8.5mm suitable for JUNKERS/EGA/MADEC/SABAF standard			
<b>accessories for</b>	101962			
	<b>Part No.</b>	101376	<b>Ref. No.</b>	—
	gasket ID $\varnothing$ 8mm ED $\varnothing$ 12mm H 3/5mm			
	<b>Part No.</b>	101964	<b>Ref. No.</b>	030113
	clamping bracket			

## MP

## gas taps



1

<b>Part No.</b>	106175	<b>Ref. No.</b>	030150
<b>description</b>	gas tap MP		
<b>accessories for</b>	106175		
	<b>Part No.</b>	101376	<b>Ref. No.</b> —
	gasket ID $\varnothing$ 8mm ED $\varnothing$ 12mm H 3/5mm		
	<b>Part No.</b>	101964	<b>Ref. No.</b> 030113
	clamping bracket		
	<b>Part No.</b>	111647	<b>Ref. No.</b> 030132
	knob switch zero mark $\varnothing$ 65mm shaft $\varnothing$ 8x6.5mm shaft flat lower black		
	<b>Part No.</b>	560085	<b>Ref. No.</b> —
	hexagonal screw thread M5 thread L 20mm SS WS 8 Qty 20 pcs DIN 933 / ISO 4017		



## ignition parts

### thermocouples

#### threaded thermocouples

#### threaded thermocouples standard

with socket with thread M8x1

SIT

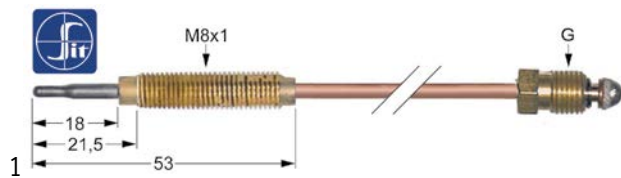

**Part No.** 107628 **Ref. No.** 030115

**description** thermocouple SIT M8x1 L 320mm M8x1

**accessories for** 107628



**Part No.** 102067 **Ref. No.** —  
nut thread M8x1 H 3mm brass Qty 1 pcs type SEF 1

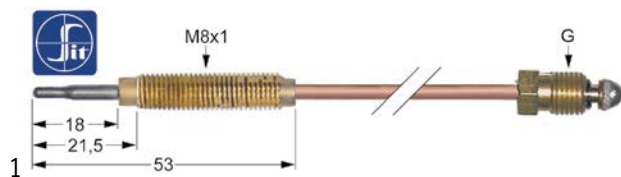

**Part No.** 107636 **Ref. No.** 150016

**description** thermocouple SIT M9x1 L 600mm M8x1

**accessories for** 107636



**Part No.** 102067 **Ref. No.** —  
nut thread M8x1 H 3mm brass Qty 1 pcs type SEF 1

## gas burners

### ceramic burners



**Part No.** 104596 **Ref. No.** 150000

**description** ceramic burner L 1090mm W 80mm firing range 1060x65mm 10400W

**spare parts for** 104596



**Part No.** 104459 **Ref. No.** 030009 (1100mm)  
sealing strip L 1090mm W 10mm thickness 4mm ceramic fibre



**Part No.** 104597 **Ref. No.** 23030  
ceramic plate L 102mm W 72mm H 13mm

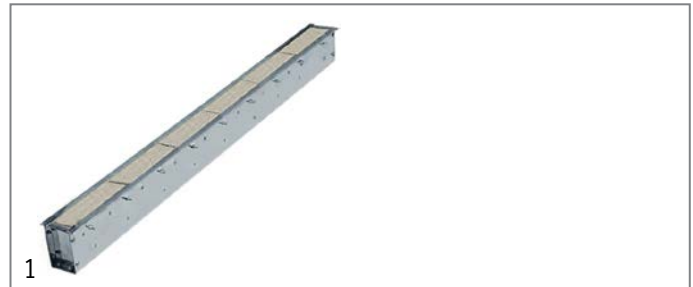

**Part No.** 107566 **Ref. No.** 030001 old

**description** ceramic burner L 900mm W 55mm 5300W with 6 ceramic plates edition until year of construction 2005 for chicken rotisserie

**spare parts for** 107566



**Part No.** 104594 **Ref. No.** 030102  
ceramic plate L 144mm W 47mm H 13mm



**Part No.** 104595 **Ref. No.** 030009 (900mm)  
sealing strip L 900mm W 10mm thickness 4mm ceramic fibre



**Part No.** 105585 **Ref. No.** 030001

**description** ceramic burner L 900mm W 67mm firing range 875x52mm 5300W with 5 ceramic plates edition since year of construction 2006 for chicken rotisserie

**spare parts for** 105585



**Part No.** 104595 **Ref. No.** 030009 (900mm)  
sealing strip L 900mm W 10mm thickness 4mm ceramic fibre



**Part No.** 106664 **Ref. No.** 030119

gas injector thread M8x1 WS 10 bore ø 1.2mm



**Part No.** 107567 **Ref. No.** 030054-1

ceramic plate L 173mm W 60mm



**Part No.** 107861 **Ref. No.** 030118

gas injector thread M8x1 WS 10 bore ø 1.9mm

#### accessories

#### sealing strips

1

**Part No.** 104458 **Ref. No.** 030009

**description** sealing strip L 10000mm W 10mm thickness 4mm ceramic fibre Qty 10m

1

**Part No.** 104459 **Ref. No.** 030009 (1100mm)

**description** sealing strip L 1090mm W 10mm thickness 4mm ceramic fibre



<b>Part No.</b>	104595	<b>Ref. No.</b>	030009 (900mm)
<b>description</b>	sealing strip L 900mm W 10mm thickness 4mm ceramic fibre		

### ceramic plates



<b>Part No.</b>	104597	<b>Ref. No.</b>	23030
<b>description</b>	ceramic plate L 102mm W 72mm H 13mm		



<b>Part No.</b>	104594	<b>Ref. No.</b>	030102
<b>description</b>	ceramic plate L 144mm W 47mm H 13mm		



<b>Part No.</b>	107567	<b>Ref. No.</b>	030054-1
<b>description</b>	ceramic plate L 173mm W 60mm		

## gas nozzles

### main nozzles

#### gas nozzles M8x1



<b>Part No.</b>	106664	<b>Ref. No.</b>	030119
<b>description</b>	gas injector thread M8x1 WS 10 bore ø 1.2mm		
<b>For models:</b>	2EG		



<b>Part No.</b>	107861	<b>Ref. No.</b>	030118
<b>description</b>	gas injector thread M8x1 WS 10 bore ø 1.9mm		

## auxiliary gas parts

### screw connections

#### olives



<b>Part No.</b>	102959	<b>Ref. No.</b>	030133
<b>description</b>	screw connection for pipe ø 8mm Qty 1 pcs thread M12x1		

## equipment-specific units

### for grills

#### glass panels



<b>Part No.</b>	693164	<b>Ref. No.</b>	040805
<b>description</b>	glass panel		

<b>Part No.</b>	693163	<b>Ref. No.</b>	040605
<b>description</b>	glass panel L 1160mm W 462mm for chicken rotisserie for model 6EE, 6EG, 6EEN, 6EEND		



1

<b>Part No.</b>	693153	<b>Ref. No.</b>	040405
<b>description</b>	glass panel L 799mm W 462mm thickness 5mm rectangular		

skewers

1

<b>Part No.</b>	693255	<b>Ref. No.</b>	160000
<b>description</b>	skewer		

spit clamp

1

<b>Part No.</b>	693258	<b>Ref. No.</b>	160015
<b>description</b>	clamp		

1

<b>Part No.</b>	693256	<b>Ref. No.</b>	160014
<b>description</b>	skewer clamp		

doors

1

<b>Part No.</b>	693259	<b>Ref. No.</b>	131000
<b>description</b>	glass door		

1

<b>Part No.</b>	693260	<b>Ref. No.</b>	130000
<b>description</b>	glass door		



## for chicken rotisserie

## motors

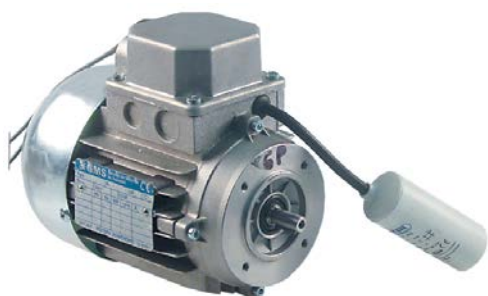

1

<b>Part No.</b>	500625	<b>Ref. No.</b>	140020
<b>description</b>	motor 60W 230V 50Hz 1 phase shaft $\varnothing$ 9mm flange $\varnothing$ 80mm 820rpm type 156C6 $\varnothing$ 110mm H 150mm L 170mm GMS 6-pole 0.06kW		

## skewers

1

<b>Part No.</b>	693141	<b>Ref. No.</b>	050001
<b>description</b>	skewer		

1

<b>Part No.</b>	693254	<b>Ref. No.</b>	050002
<b>description</b>	skewer complete for chicken rotisserie L 900mm thickness 12x12mm		

## spit clamp

1

<b>Part No.</b>	693143	<b>Ref. No.</b>	050110
<b>description</b>	skewer clamp crimping range 13x13mm <sup>2</sup> double for skewer 12x12mm mounting pos. inner skewer 2x60mm skewer $\varnothing$ 4mm		

1

<b>Part No.</b>	693142	<b>Ref. No.</b>	050107
<b>description</b>	skewer clamp single for skewer 12x12mm mounting pos. outer skewer 75mm skewer $\varnothing$ 4mm		

<b>accessories for</b>	693142		
------------------------	--------	--	--



<b>Part No.</b>	697481	<b>Ref. No.</b>	—
<b>description</b>	Thumb screw thread M6 thread L 8mm $\varnothing$ 14mm H 6mm SS		

## miscellaneous



1

<b>Part No.</b>	693145	<b>Ref. No.</b>	050112
<b>description</b>	cylindrical handle thread M10 $\varnothing$ 27mm L 101mm		

1

<b>Part No.</b>	693146	<b>Ref. No.</b>	050114
<b>description</b>	handle draw-off		



1

<b>Part No.</b>	693144	<b>Ref. No.</b>	050116
<b>description</b>	screw for skewer		

## for tilting bratt pans

## miscellaneous



1

<b>Part No.</b>	523510	<b>Ref. No.</b>	020105
<b>description</b>	deep-groove ball bearing type 6202-2RS shaft $\varnothing$ 15mm ED $\varnothing$ 35mm W 11mm with sealing discs deep-groove ball bearing DIN 625-1		

## for ovens

## glass panels



1

<b>Part No.</b>	693149	<b>Ref. No.</b>	040305
<b>description</b>	glass panel		





1	<b>Part No.</b>	693148	<b>Ref. No.</b>	040205
	<b>description</b>	glass panel L 463mm W 439mm thickness 5mm rectangular		

for pizza ovens

glass panels

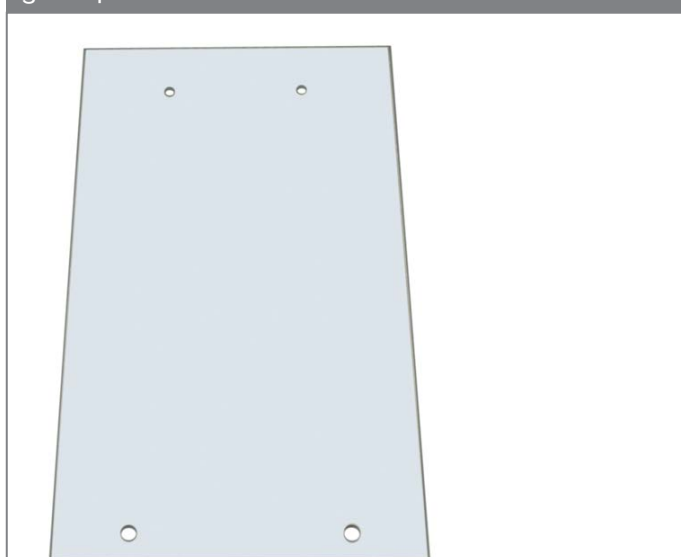

1	<b>Part No.</b>	693147	<b>Ref. No.</b>	040105
	<b>description</b>	glass panel		

knobs

producer-specific knobs

TECNO-MCM

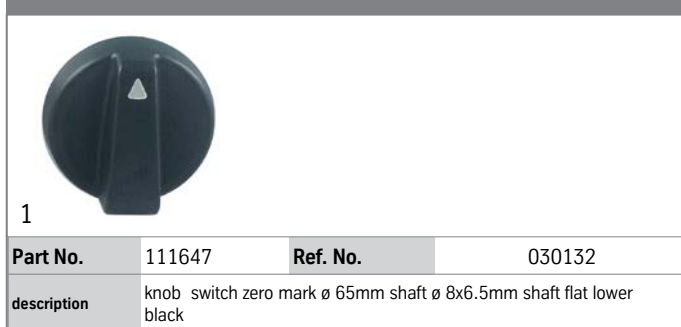

1	<b>Part No.</b>	111647	<b>Ref. No.</b>	030132
	<b>description</b>	knob switch zero mark ø 65mm shaft ø 8x6.5mm shaft flat lower black		

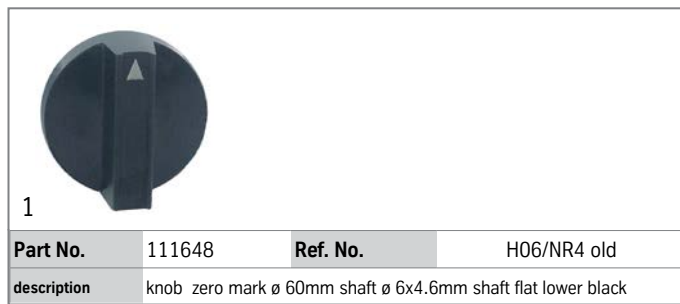

1	<b>Part No.</b>	111648	<b>Ref. No.</b>	H06/NR4 old
	<b>description</b>	knob zero mark ø 60mm shaft ø 6x4.6mm shaft flat lower black		

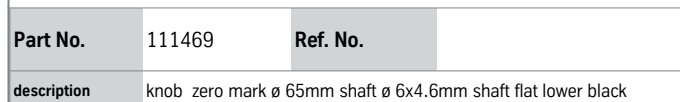

1	<b>Part No.</b>	111469	<b>Ref. No.</b>	
	<b>description</b>	knob zero mark ø 65mm shaft ø 6x4.6mm shaft flat lower black		

handles and hand wheels

cylindrical handles

fixed



1	<b>Part No.</b>	693145	<b>Ref. No.</b>	050112
	<b>description</b>	cylindrical handle thread M10 ø 27mm L 101mm		

transmission technology and ball bearings

ball bearings

deep-groove ball bearings 2RS

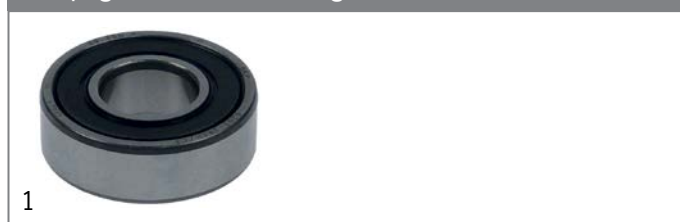

1	<b>Part No.</b>	523510	<b>Ref. No.</b>	020105
	<b>description</b>	deep-groove ball bearing type 6202-2RS shaft ø 15mm ED ø 35mm W 11mm with sealing discs deep-groove ball bearing DIN 625-1		





## fastening material

fasteners

retaining rings

DIN 472



<b>Part No.</b>	698003	<b>Ref. No.</b>	020122
<b>description</b>	retaining ring bore ø 35mm thickness 1.5mm steel DIN 472		

**GASTRO**PARTS.COM

