



GASTROPARTS

Technoblock

- [EN]** Equipment
- [DE]** Geräte
- [ES]** Aparatos
- [FR]** Équipement
- [IT]** Attrezzature
- [PL]** Urządzenia
- [RU]** Оборудование

✉ gastroparts@gastroparts.com

☎ +48 56 657 00 66

📘 fb.com/gastroparts.global

GASTROPARTS.COM





heating elements

heating elements for refrigeration

heating elements for defrosting



Part No.	420296	Ref. No.	3RST188 4RSBI003
description	heating element 1300W 230V L 1200mm W 60mm H 115mm cable length 2000mm tube ø 8.5mm immersion heater defrosting		

switches and momentary switches

push/momentary push switches

19x13mm



Part No.	347692	Ref. No.	3INT277 4INTS008
description	push switch mounting measurements 19x13mm green 1NO/indicator light 250V 15A lamp connection male faston 4.8mm ambient temperature max. 105/55°C protection IP65 with cover cap		



Part No.	347691 ¹	Ref. No.	3INT283 4INTS007
description	push switch mounting measurements 19x13mm green 2NO 250V 15A illuminated refrigeration connection male faston 4.8mm ambient temperature max. 105/55°C protection IP65 with cover cap		
spare parts for	347691		
	Part No.	301064	Ref. No. —
	protective cover for pressure switch external size 23.4x17.4mm internal size 19x13mm H 7.5mm clear mounting measurementsmm		

¹illuminated

contactors

ABB

power contactors



Part No.	381504	Ref. No.	3TLR271
description	power contactor resistive load 25A 230VAC (AC3/400V) 5.5kW main contacts 2NO connection screw type A11-30-10		

relays

power relays

with male contacts

female contact 6.3mm

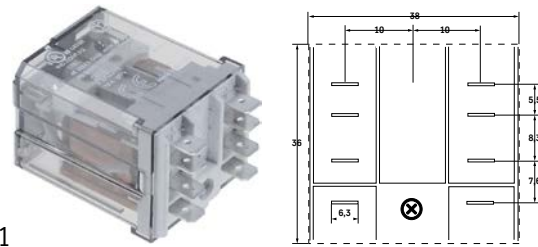

Part No.	380955	Ref. No.	3RLM076 4RELF003
description	relay FINDER 230VAC 16A 2CO connection F6.3 manuf. no. 62.82.8.230.0009 250V 2-pole connection male faston 6.3mmmm		

transformers

encapsulated transformers

PMA



Part No.	379054	Ref. No.	3TRF150 4TRFS022
description	transformer primary 230VAC secondary 12VAC 3VA secondary 0.25A H 40mm L 45mm W 50mm connection screw 50/60Hz type 153/M		



electronic controllers













DIXELL

refrigeration controllers

built-in version



1

Part No.	402144	Ref. No.	3CTL183
description	electronic controller DIXELL XR60CX -5NOC1 mounting measurements 71x29mm 230V voltage AC NTC/PTC relay outputs 3 NO-20A(8) CO-8A(3) NO-5A(2) NTC/PTC NTC/PTC DI -50 up to +150°C display 3½ digits		
accessories for	402144		
	Part No.	378194	Ref. No. —
	temperature probe NTC 10kOhm cable PVC probe -20 up to +80°C cable -10 up to 100°C probe ø7x24.5mm cable length 1.5m without screw connection 2-wire		
	Part No.	378551	Ref. No. —
	adapter for reducer mounting measurements 71x29mm		
	Part No.	379052	Ref. No. —
	temperature probe PTC 1kOhm cable silicone probe -50 up to +150°C cable -50 up to +180°C probe ø6x40mm cable length 1.5m without screw connection 2-wire		
	Part No.	379053	Ref. No. —
	temperature probe PTC 1kOhm cable PVC probe -50 up to +150°C cable -10 up to 100°C probe ø6x30mm cable length 3m without screw connection 2-wire		
	Part No.	379057	Ref. No. —
	temperature probe NTC 10kOhm cable PVC probe -20 up to +80°C cable -10 up to 100°C probe ø6x25mm cable length 3m 2-wire		
	Part No.	379064	Ref. No. —
	temperature probe PTC 1kOhm cable silicone probe -50 up to +150°C cable -50 up to +180°C probe ø6x40mm cable length 3m without screw connection 2-wire		
	Part No.	379160	Ref. No. 3SNS131 4SND5111
	temperature probe NTC 10kOhm cable thermoplastic probe -40 up to +110°C cable -40 up to +110°C probe ø6x14mm cable length 1.5m without screw connection 2-wire		
	Part No.	379161	Ref. No. —
	temperature probe NTC 10kOhm cable thermoplastic probe -40 up to +110°C cable -40 up to +110°C probe ø6x14mm cable length 3m without screw connection 2-wire		
	Part No.	379343	Ref. No. —
	temperature probe NTC 10kOhm cable silicone probe -40 up to +110°C cable -50 up to +180°C probe ø6x40mm cable length 3m 2-wire		
	Part No.	379458	Ref. No. —
	temperature probe NTC 10kOhm cable silicone probe -40 up to +110°C cable -50 up to +180°C probe ø6x40mm cable length 1.5m without screw connection 2-wire		
	Part No.	379782	Ref. No. —
	temperature probe PTC 1kOhm cable thermoplastic probe -50 up to +150°C cable -40 up to +110°C probe ø6x14mm cable length 3m 2-wire resistor 1kOhm		
	Part No.	402818	Ref. No. —
	programming key 4K for electronic controller DIXELL		

SHANGFANG

accessories



1

Part No.	379054	Ref. No.	3TRF150 4TRFS022
description	transformer primary 230VAC secondary 12VAC 3VA secondary 0.25A H 40mm L 45mm W 50mm connection screw 50/60Hz type 153/M		

probes

universal probes

temperature probes

1



Part No.	379160	Ref. No.	3SNS131 4SND5111
description	temperature probe NTC 10kOhm cable thermoplastic probe -40 up to +110°C cable -40 up to +110°C probe ø6x14mm cable length 1.5m without screw connection 2-wire		

electronics

PCBs



1

Part No.	402940	Ref. No.	3SCH173 4SCHS090
description	main PCB CSK 120 L 124mm W 100mm type MIR90		



compressors

SECOP DANFOSS

R404a/R507

HMBP monophase

High/Medium evaporation temperature above -20/-15 °C



1

Part No.	605113	Ref. No.	3CMP2154
description	compressor coolant R404a/R507 type SC18MLX.3 220-240V 50Hz HMBP 14kg 1HP cylinder capacity 17.68cm ³ CSR H 219mmWW 947W 1178W 1454W 1780W 2162W 2606WW test method ASHRAE (50Hz)		

fans

refrigeration fans

refrigeration motors universal

miscellaneous



1

Part No.	602186	Ref. No.	3MVN027 4MTNM051 4MTNM151
description	fan motor 83-18W 230V 50/60Hz cable length 1050mm 1350/1500rpm MA-VIB		

cold air circulating fans (complete)

ebm-papst

A4E series

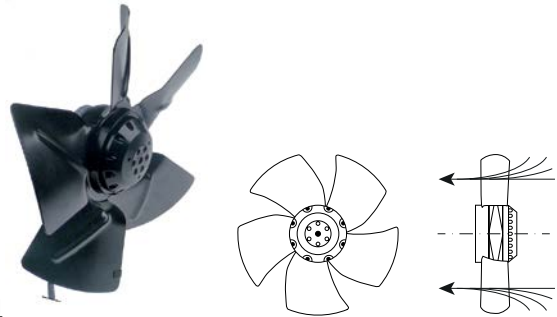

1

Part No.	601623	Ref. No.	3MOT049 4MTVZ004
description	fan A4E315-AC08-19 fan wheel ø 315mm blades 5 230V 50Hz 95W 1370rpm cable length 450mm ebm-papst sucking suitable capacitor 3µF		
accessories for	601623		
	Part No.	365137	Ref. No. —
description	capacitor capacity 3µF 450V tolerance 5% 50/60Hz ambient temperature max. -25 to +85°C ø 25mm L 56mm M8 plastic connection cable 250mm 416.17.77GF protection		

evaporators

for fridges

producer-specific



1

Part No.	750213	Ref. No.	3EVP416 4EVPX101
description	evaporator		

GASTROPARTS.COM

