



GASTROPARTS

Tecfrigo

- [EN]** Equipment
- [DE]** Geräte
- [ES]** Aparatos
- [FR]** Équipement
- [IT]** Attrezzature
- [PL]** Urządzenia
- [RU]** Оборудование

✉ gastroparts@gastroparts.com

☎ +48 56 657 00 66

📘 fb.com/gastroparts.global

GASTROPARTS.COM







heating elements

heating elements for griddles

1 			
Part No.	418014	Ref. No.	3024801
description	heating element 950W 230V heating circuits 1 L 1032mm W 85mm tube ø 8.5mm bracket mounting connection male faston 6.3mm hole ø M5mm connection length 71mm dry heating element lug length 40mm lug width 18mm		

heating elements for hot counters

1 			
Part No.	418015	Ref. No.	3914801
description	heating element 1600W 220V heating circuits 1 L 227mm W 313mm connection length 37mm tube ø 6.3mm connection male faston 6.3mm dry heating element bracket mounting hole distance 345mm hole ø 5mm lug length 35mm lug width 20mm		

1 			
Part No.	418013	Ref. No.	3014801
description	heating element 825W 230V heating circuits 1 L 826mm W 74mm connection length 70mm tube ø 8.5mm connection male faston 6.3mm dry heating element rectangular flange hole distance 100mm flange length 40mm flange width 18mm hole ø M5mm		

heating elements for refrigeration

heating elements for condensate evaporation

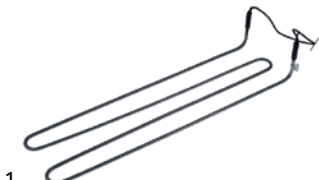
1 			
Part No.	418816	Ref. No.	7764819
description	heating element 500W 230V L 500mm W 130mm H 90mm cable length 1500mm connection distance 124mm tube ø 6mm		

foil heating elements

1 			
Part No.	418868	Ref. No.	2304802
description	foil heating element L 460mm W 270mm 600W 230V t.max.°C silicone cable length 2300mm thickness 1mm		

1 			
Part No.	418012	Ref. No.	3154802
description	foil heating element L 560mm W 360mm 400W 230V probe ø 6mm without temperature limiter plastic cable length 490mm thickness 0.5mm		

thermostats

control and safety thermostats

PRODIGY / FIRT

control thermostats

1 			
Part No.	375475	Ref. No.	A0103
description	thermostat t.max. 120°C temperature range 30-120°C 1-pole 1CO 16A probe ø 6mm probe L 105mm capillary pipe 1480mm capillary pipe isolated 100mm shaft ø 6x4.6mm shaft L 16mm shaft position lower° rotation 320°		



switches and momentary switches

rocker/momentary rocker switches

30x22mm



1

Part No.	301251	Ref. No.	A0304
description	rocker switch mounting measurements 30x22mm green 2NO 250V 16A illuminated lighting connection male faston 6.3mm ambient temperature max. 85°C protection IP40		



1

Part No.	346321	Ref. No.	A0303
description	rocker switch mounting measurements 30x22mm green 2NO 250V 16A illuminated lighting connection male faston 6.3mm ambient temperature max. 85°C protection IP40		

float switches



1

Part No.	401865	Ref. No.	C7301
description	float switch thread 10mm 1NO \varnothing 28mm L 80mm mounting \varnothing 10mm 240V 0.5A cable		

lamps

linear lamps

sockets for linear lamps

R7s

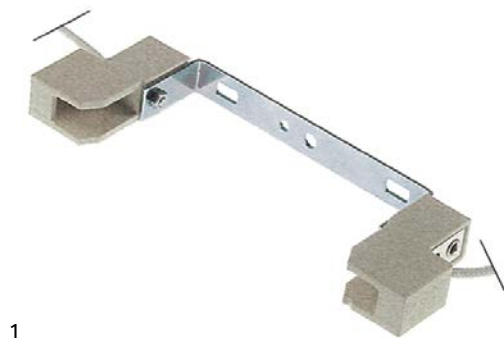

1

Part No.	359663	Ref. No.	D9501
description	lamp socket socket R7s 250V \varnothing mm for length of lamp 117.6mm H 47mm connection cable 150mm mounting distance 65mm holder length 140.5mm Qty 1 pcs		

fluorescent lamps

fluorescent lamps

G13



1

Part No.	359372	Ref. No.	B6303
description	fluorescent lamp socket G13 L 895mm 30W 230V Qty 1 pcs		

accessories

sockets



1

Part No.	550845	Ref. No.	0054804
description	socket socket G13 Qty 1 pcs		



1

Part No.	550846	Ref. No.	0054805
description	socket socket G13 Qty 1 pcs		

ballasts



1

Part No.	401142	Ref. No.	A6802
description	electrical ballast 30W for fluorescent lamps		

covers



1

Part No.	550844	Ref. No.	0064802
description	cover		



			
1			
Part No.	550847	Ref. No.	0064801
description	cover		

alarm devices

alarm units

			
1			
Part No.	350115	Ref. No.	C3601
description	alarm device 240VAC ø 40mm Hmm 1 hole fixing mounting thread M12 82dB protection IP54		

contactors

KEDU

power contactors

			
1			
Part No.	380873	Ref. No.	C3402
description	contactor resistive load 16A 230VAC (AC3/400V) 6.1A/2.2kW main contacts 2NO/2NC auxiliary contacts connection screw connection type JD6.01		

probes

universal probes

temperature probes

			
1			
Part No.	379064	Ref. No.	D7602
description	temperature probe PTC 1k0hm cable silicone probe -50 up to +150°C cable -50 up to +180°C probe ø6x40mm cable length 3m without screw connection 2-wire		

compressors

ACC/ZEL

R134A

HMBP monophase

High/Medium evaporation temperature above -20/-15 °C

			
1			
Part No.	605010	Ref. No.	B5228
description	compressor coolant R134a type GP12TB 220-240V 50Hz HMBP fully hermetic 11.2kg 3/8HP power input 661W cylinder capacity 12cm ³ CSIR H 203.6mmW 143W 194W 259W 339W 432W 539W 661W 796W test method ASHRAE ambient temperature max. 43°C		

fans

axial fans

ebm-papst

			
1			
Part No.	601089 ¹	Ref. No.	C5301
description	axial fan L 119mm W 119mm H 38mm 230VAC 50/60Hz 19W bearing slide bearing manuf. no. 4650N metal connection male faston 2.8mm ebm-papst fan wheel ø 110mm temp.-resist. 55°C		
accessories for	601089		
		Part No.	550898
		Ref. No.	—
		connecting cable cable length 2000mm connection F 2.8 connection distance 7.9mm for axial flow fan	
		Part No.	691104
		Ref. No.	—
		guard ø 115mm mounting distance 105mm for axial fan 119mm	

¹with slide bearings



cross flow fans

COPREL

with moulded coils



1

Part No.	601398	Ref. No.	B5102
description	cross flow fan COPREL TFL roller \varnothing 60mm roller length 180mm laminated core thickness 20mm motor position left 230V/50Hz 25W refrigeration bearing rubber connection cable 2400mm coil type impregnated -10 up to +60°C		

double fans



1

Part No.	601645	Ref. No.	B5105
description	cross flow fan COPREL FFD roller \varnothing 60mm roller length 2x180mm laminated core thickness 43mm motor position centre 230V/50-60Hz 43W refrigeration bearing rubber connection F6.3 coil type moulded airflow 280m ³ /h -10 up to +50°C		



1

Part No.	602108	Ref. No.	N/A
description	cross flow fan COPREL TFD roller \varnothing 60mm roller length 2x180mm laminated core thickness 30mm motor position centre 230V/50-60Hz 45W universal bearing silicone connection cable 1600mm airflow 280m ³ /h -10 up to +50°C		

hot air fans

miscellaneous

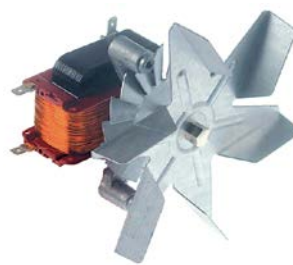

1

Part No.	601147	Ref. No.	D0702
description	hot air fan 220-240V 32W L1 65mm L2 10mm L3 20mm L4 87mm fan wheel \varnothing 150mm FIME type C20X0E173CLH		

motors

gear motors

miscellaneous



1

Part No.	499120	Ref. No.	B8301 X70001 X70006
description	gear motor MINGARDI type M02 130W 230V voltage AC 50Hz L 267mm W 85mm H 50mm for hood with holder		



1

Part No.	500913	Ref. No.	00807/1 X07003
description	gear motor type B4509UI-025 230V 50Hz 1.4rpm L 83mm W 75mm H 92mm for display refrigerator		



equipment-specific units

for fridges

housing and bezels

miscellaneous



1

Part No.	700909	Ref. No.	3590304
description	ventilation grille H 200mm L 558mm		

for display coolers

housing and bezels

lids

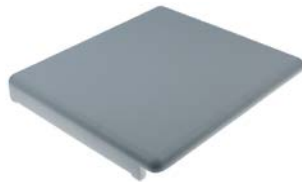

1

Part No.	696362	Ref. No.	2570220
description	lid for vitrine W 430mm D 380mm H 50mm		

glass panels

glass panels



1

Part No.	700910	Ref. No.	0270901
description	glass panel L 560mm W 555mm H 6mm thickness 6mm rectangular		

miscellaneous

with fixing plate

ø60mm



1

Part No.	700893	Ref. No.	C2407
description	swivel castor with swivel brake ø 60mm plates fixing 60x60mm housing gold-coloured hole distance 47mm H 92mm wheel width 22mm		



1

Part No.	700894	Ref. No.	A0814
description	swivel castor without brake ø 63mm plates fixing 60x60mm housing gold-coloured hole distance 47mm H 92mm wheel width 22mm		

shelves and shelf rails

grates

universal

without upstand



1

Part No.	970650	Ref. No.	7750802
description	grate W 650mm D 530mm GN 2/1 chrome-plated steel wire gauge frame 8mm lengthwise wires gauge 3mm crossing wires 2		

shelf rails and supports

producer-specific



1

Part No.	697950	Ref. No.	4100803
description	shelf support L 32mm W 15mm H 25mm plastic suitable for PRISMA400TNV-PF		



gaskets

refrigeration gaskets

plug-in gaskets

profile 9050

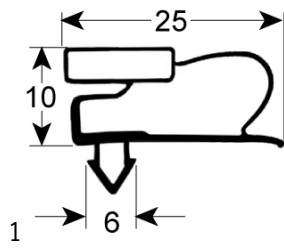

Part No.	902051	Ref. No.	8660401
description	refrigeration gasket profile 9050 W 700mm L 1505mm plug size		

profile 9151

We offer custom-made gaskets for this profile

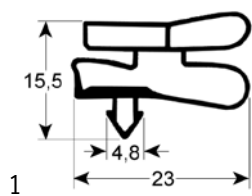

Part No.	901458	Ref. No.	8690415
description	refrigeration gasket profile 9151 W 535mm L 1690mm plug size		

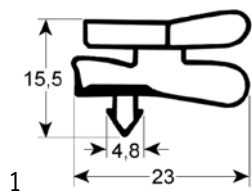

Part No.	901080	Ref. No.	8690406
description	refrigeration gasket profile 9151 W 558mm L 1713mm plug size L1 1703mm W1 548mm external size		

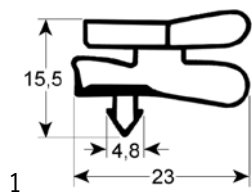

Part No.	901322	Ref. No.	8660402
description	refrigeration gasket profile 9151 W 717mm L 1515mm plug size L1 1505mm W1 707mm external size		

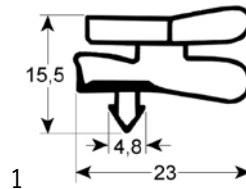

Part No.	901085	Ref. No.	8660403
description	refrigeration gasket profile 9151 W 730mm L 1550mm plug size L1 1540mm W1 720mm external size		

profile 9154

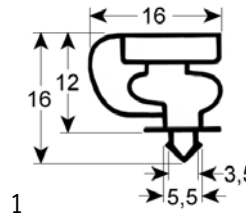

Part No.	901397	Ref. No.	0200401
description	refrigeration gasket profile 9154 W 368mm L 1105mm		

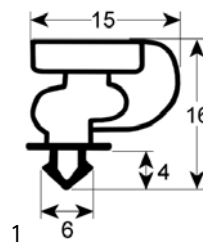

Part No.	901133	Ref. No.	0040401
description	refrigeration gasket profile 9154 W 379mm L 586mm plug size		

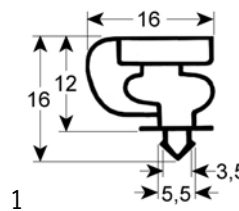

Part No.	901134	Ref. No.	4110404
description	refrigeration gasket profile 9154 W 531mm L 1221mm plug size		

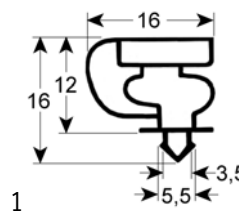

Part No.	901135	Ref. No.	0090401
description	refrigeration gasket profile 9154 W 648mm L 690mm plug size		



1

Part No.	902267	Ref. No.	N/A
description	refrigeration gasket profile 9154 Wmm L 2500mm		

springs

tension springs

1

Part No.	700425	Ref. No.	A2502
description	tension spring ø 12mm total length 244mm wire gauge ø 1.9mm		

condensors

condensors

1

Part No.	750285	Ref. No.	B7401
description	condenser W 285mm D 165mm H 250mm		

GASTROPARTS.COM

