



GASTROPARTS

SV-Italia

- [EN]** Equipment
- [DE]** Geräte
- [ES]** Aparatos
- [FR]** Équipement
- [IT]** Attrezzature
- [PL]** Urządzenia
- [RU]** Оборудование

✉ gastroparts@gastroparts.com

☎ +48 56 657 00 66

📘 fb.com/gastroparts.global



GASTROPARTS.COM







heating elements

heating elements for coffee machine

			
1			
Part No.	417415	Ref. No.	SV1GR002+SVTMG010
description	heating element 1800W 230V heating circuits 2 mounting \varnothing 39.5mm hole distance 58mm L 165mm W 27mm H 60mm L1 35mm L2 60mm L3 70mm H1 25mm H2 35mm hole \varnothing 10mm tube \varnothing 8mm connection M3 immersion heater 3 hole flange suitable for S.V. ITALIA		
accessories for	417415		
		Part No.	527169
		Ref. No.	—
	hexagonal nut thread M3 H 2.8mm WS 5.5 brass Qty 1 pcs		
		Part No.	528740
		Ref. No.	SVTMG010
	gasket ID \varnothing 44mm PTFE thickness 3.5mm hole \varnothing 9.5mm hole distance 58mm suitable for ITALCREM, VISACREM for heating element coffee machine parts		

			
1			
Part No.	417416	Ref. No.	SV2GR002 SV2GR002+SVTMG010
description	heating element 2500W 230V heating circuits 2 mounting \varnothing 39.5mm hole distance 57mm L 275mm W 35mm H 63mm L1 35mm L2 50mm L3 185mm H1 24mm H2 39mm hole \varnothing 10mm tube \varnothing 6.3mm connection M4 dry heating element 3 hole flange suitable for S.V. ITALIA with PTFE gasket		

			
1			
Part No.	417417	Ref. No.	SV2GR003 SV2GR003+SVTMG010
description	heating element 3000W 230V heating circuits 2 mounting \varnothing 39.5mm hole distance 57.5mm L 343mm W 34mm H 62mm L1 30mm L2 53mm L3 260mm H1 24mm H2 38mm hole \varnothing 10mm tube \varnothing 6.3mm connection M4 immersion heater 3 hole flange suitable for S.V. ITALIA with PTFE gasket		

			
1			
Part No.	417418	Ref. No.	SV3GR002
description	heating element 5000W 230V heating circuits 2 mounting \varnothing 39mm hole distance 57mm L 500mm W 34mm H 60mm L1 37mm L2 73mm L3 390mm H1 24mm H2 36mm hole \varnothing 10mm tube \varnothing 6.3mm connection M4 immersion heater 3 hole flange suitable for S.V. ITALIA		

accessories

flange gaskets

			
1			
Part No.	528740	Ref. No.	SVTMG010
description	gasket ID \varnothing 44mm PTFE thickness 3.5mm hole \varnothing 9.5mm hole distance 58mm suitable for ITALCREM, VISACREM for heating element coffee machine parts		

switches and momentary switches

rocker/momentary rocker switches

<h4>30x22mm</h4>			
			
1			
Part No.	301060	Ref. No.	SVTMI003
description	rocker switch mounting measurements 30x22mm red 2NO 250V 16A illuminated connection male faston 6.3mm ambient temperature max. 125/55°C protection IP40		

push/momentary push switches

<h4>28.5x28.5mm</h4>			
			
1			
Part No.	347319	Ref. No.	SVTMI002
description	push switch mounting measurements 28.5x28.5mm green/red 2NO 250V 16A cup connection male faston 6.3mm ambient temperature max. 150°C protection IP40 with indicator		
spare parts for	347319		
		Part No.	345604
		Ref. No.	—
	element holder single mounting measurements 28.5x28.5mm black for push buttons 25x23mm		
		Part No.	345720
		Ref. No.	—
	switch 2NO 250V 16A connection male faston 6.3mm		
		Part No.	346251
		Ref. No.	—
	rotary disc orange/green disc \varnothing 20.6mm		

\varnothing 25mm

			
1			
Part No.	346316	Ref. No.	SVMNI001
description	push switch mounting \varnothing 25mm black 2NO 250V 16A connection male faston 6.3mm ambient temperature max. 85°C protection IP40		



rotary switches

BREMAS

accessories



1

Part No.	111369	Ref. No.	SVTMM023
description	knob ø 28/48mm shaft ø 5x5mm black H 22mm L 40mm		

GIOVENZANA

rotary switches



1

Part No.	347648 ¹	Ref. No.	SVTMC012
description	rotary switch 3 0-1-2 sets of contacts 6 type CS20 690V 20A shaft ø 8x7mm shaft L 15mm shaft star-shaped connection screw		

¹incl. knob and dial plate

lamps

indicator lights

indicator light lenses

ø 6mm (type SQ-20)



1

Part No.	359803	Ref. No.	SVECG006
description	indicator light lens green Qty 1 pcs ø 6mm		



1

Part No.	359805	Ref. No.	SVECG003
description	indicator light lens red Qty 1 pcs ø 6mm		

indicator lights (complete)

ø 6mm



1

Part No.	357016	Ref. No.	SVECS010
description	indicator light ø 6mm 230V green connection grip connection temp.-resist. 120°C		



1

Part No.	357017	Ref. No.	SVECS011
description	indicator light ø 6mm 230V red connection grip connection temp.-resist. 120°C		

ø13mm

with plug-in socket



1

Part No.	357015	Ref. No.	SVTMS004
description	indicator light ø 13mm green 250V connection push-in		



1

Part No.	357018	Ref. No.	Z300E007
description	indicator light ø 13mm yellow 250V connection male faston 6.3mm temp.-resist. 120°C push-in		

relays

level relays

miscellaneous



1

Part No.	402668	Ref. No.	SVTMR015 SVTMR041
description	level controller 230V voltage AC 50/60Hz		

electronics

PCBs



1

Part No.	402665	Ref. No.	SVMND001
description	display suitable for S.V. ITALIA model ELLIPSE		

1

Part No.	402662	Ref. No.	SVMNP006
description	keypad PCB suitable for S.V. ITALIA buttons 1		



1

Part No.	402663	Ref. No.	SVMNP005
description	keypad PCB suitable for S.V. ITALIA buttons 2		

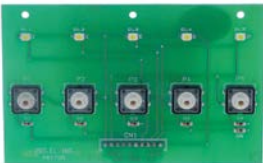

1

Part No.	402664	Ref. No.	SVMNP004
description	keypad PCB suitable for S.V. ITALIA buttons 5		

central units



1

Part No.	402669	Ref. No.	SVECC001
description	central unit 230V 50/60Hz 2 groups type SDE3C SV2A voltage AC		



1

Part No.	402670	Ref. No.	SVECC008
description	central unit 230V 50/60Hz 3 groups type SDE3C SV3A voltage AC		



1

Part No.	403077	Ref. No.	SVECC029
description	central unit 230V 50/60Hz 3 groups type SDE3D SV3LA voltage AC		



1

Part No.	402673	Ref. No.	SVMN3GC005
description	central unit 230V 50/60Hz 3 groups type SDE3S SV30A voltage 50/60		



1

Part No.	402672	Ref. No.	SVMN3GC003
description	central unit 230V 50/60Hz 3 groups type SDE3S SV3AA voltage AC		



1

Part No.	402671	Ref. No.	SV3GC012
description	central unit 230V 50/60Hz type SDE3D SV3A voltage AC		



keypads

front foils



1

Part No.	402658	Ref. No.	SVMNE005
description	keypad foil black/red suitable for S.V. ITALIA L 32.5mm W 19.5mm buttons 1		



1

Part No.	402657	Ref. No.	SVMNE004
description	keypad foil glue-on black/white suitable for S.V. ITALIA L 44mm W 20mm buttons 2		



1

Part No.	402659	Ref. No.	SVMNE003
description	keypad foil glue-on black/white/red suitable for S.V. ITALIA L 118mm W 19.5mm buttons 5		

keypad units



1

Part No.	402667	Ref. No.	SVTMP032
description	keypad unit buttons 5 silver/black L 120mm W 50mm		



1

Part No.	402666	Ref. No.	SVECP003
description	keypad unit buttons 6 silver/blue L 120mm W 50mm		

accessories



1

Part No.	402661	Ref. No.	SVMNT006
description	push button large black suitable for S.V. ITALIA		



1

Part No.	402660	Ref. No.	SVMNT002
description	push button small black suitable for S.V. ITALIA		

solenoid valves

solenoid valves (water)

metal

LUCIFER

2-way

121F series



1

Part No.	370599	Ref. No.	SVTME001
description	solenoid valve 2-ways 230VAC DN 3mm slide-on receptacle DIN -10 up to 140°C PARKER type series 121F coil type DZ06S6 membranes ruby p max 10bar 60Hz flange 32x32mm brass		



ODE

solenoid valves steam (water)

21A1 series



1

Part No.	370093	Ref. No.	SVTME001	
description	solenoid valve 2/2-ways 230VAC body 25-F39 DN 2.5mm slide-on receptacle DIN -10 up to 140°C ODE type series 21A1 coil type BDA membranes FKM p max 14bar 50/60Hz silicone flange 32x32mm			
spare parts for	370093			
	Part No.	371150	Ref. No.	—
	solenoid coil ODE 230VAC 16VA coil type BDV seat ø 13.5mm 7500hm			
accessories for	370093			
	Part No.	371090	Ref. No.	—
	power socket plug type DIN 43650A screw			



electrodes

1



Part No.	400790	Ref. No.	SVMNS009
description	level electrode 1/4" total length 125mm probe L 98mm insulated probe length 26mm connection male faston 6.3mm stainless steel ø 3mm rubber		

1



Part No.	401157	Ref. No.	SVTMS002
description	level electrode 1/4" total length 150mm probe L 122mm insulated probe length 26mm connection male faston 6.3mm stainless steel ø 2.5mm		

equipment-specific units

for espresso machines

filter holders

filter holders standard

filter holders (complete)

1



Part No.	525265	Ref. No.	SVTMP014
description	filter holder single suitable for S.V. ITALIA 1-way ID ø 61.6mm outlet distance mm mounting ø 83.3		

filters

for 1 cup

1



Part No.	525267	Ref. No.	SVTMF012
description	coffee filter ø 70mm mounting ø 60mm H 20.5mm cups 1 amount of coffee 6g perforation ø 0.25mm		

1



Part No.	525268	Ref. No.	SVTMF002
description	coffee filter ø 70mm mounting ø 60mm H 24.5mm cups 1 amount of coffee 7g perforation ø 0.3mm		

for 2 cups

1



Part No.	529014	Ref. No.	SVTMF011
description	coffee filter ø 70mm mounting ø 60mm H 21mm cups 2 amount of coffee 12g perforation ø 0.3mm round		

1



Part No.	525270	Ref. No.	SVTMF003
description	coffee filter ø 70mm mounting ø 60mm H 25mm cups 2 amount of coffee 14g perforation ø 0.3mm		

blind filters

1



Part No.	529102	Ref. No.	SVTMF004
description	blind filter ø 70mm mounting ø 60mm H 17mm		

brewing units

shower screens

flat

1



Part No.	529228	Ref. No.	SVECD001
description	shower screen ø 51.6mm hole ø 6.2mm		



with upstand



1

Part No.	529080	Ref. No.	SVTMD003
description	shower screen ø 58mm H 20mm		

filter holder gaskets

flat

with internal notch



1

Part No.	525257	Ref. No.	SVTMS013
description	filter holder gasket D1 ø 73.3mm D2 ø 57.3mm H 7.5mm with inside notch rubber Qty 1 pcs		



1

Part No.	525258	Ref. No.	SVTMS024
description	filter holder gasket D1 ø 73.3mm D2 ø 57.3mm H 8.1mm with inside notch Qty 1 pcs		

brewing units manual

components

gaskets



1

Part No.	526856	Ref. No.	SVTMP021
description	gasket D1 ø 13mm ID ø 4mm thickness 4mm Viton		

components

nozzles

with thread



1

Part No.	528486	Ref. No.	SVMNG005
description	nozzle bore ø 0.7mm thread M6x0.75 L 9mm WS 7		



1

Part No.	525250	Ref. No.	SVECG010
description	nozzle bore ø 0.8mm thread M6x0.75 L 9mm		



1

Part No.	525490	Ref. No.	TM-INIE707
description	nozzle bore ø 1.25mm thread M6x0.75 L 9mm		

screws



1

Part No.	560420	Ref. No.	ZVITE026
description	countersunk screw thread M5 L 14mm SS DIN 965/ISO 7046 Qty 1 pcs intake Phillips head ø 9mm		

gaskets

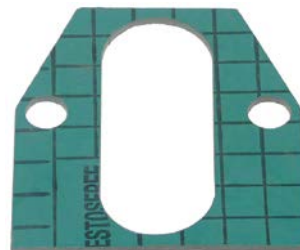

1

Part No.	525241	Ref. No.	SVTMG016
description	group gasket L 76mm W 70mm thickness 2mm aperture 10mm hole distance 54mm suitable for S.V. ITALIA fibre		

safety valves

safety valves

3/8"



1

Part No.	531210	Ref. No.	SVTMV007
description	safety valve connection 3/8" triggering pressure 1.5bar approval CE		



expansion valves

with hose connection

1 

Part No.	526452	Ref. No.	SVTMV009
description	expansion valve T1: 1/4" ET hose ø 9.5mm BL 42mm		

drain pans

drain pans

1 

Part No.	525262	Ref. No.	SVTMV010
description	drain pan rectangular suitable for S.V. ITALIA		

1 

Part No.	525263	Ref. No.	SVMNV002
description	drain pan round suitable for S.V. ITALIA		

aerators and air bleeders

1 

Part No.	527981	Ref. No.	SVTMV001
description	aerator and air bleeder connection 1/4"		

steam/water taps

steam/water taps

1 

Part No.	525245	Ref. No.	SVECC010
description	steam/water tap inlet 1/4" outlet 3/8" shaft 5.8 shaft L 16mm suitable for S.V. ITALIA		

1 

Part No.	525244	Ref. No.	SVTMR024
description	steam/water tap inlet 3/8" outlet 3/8" shaft 8x6 shaft L 26mm suitable for S.V. ITALIA		

components

gaskets

1 

Part No.	526856	Ref. No.	SVTMP021
description	gasket D1 ø 13mm ID ø 4mm thickness 4mm Viton		

pressure rings

1 

Part No.	525251	Ref. No.	RUBS/L-R001
description	press ring for steam-/water-tap D1 ø 10.7mm D2 ø 8.1mm thickness 2mm 3pcs		

springs

1 

Part No.	526443	Ref. No.	SVECM007
description	compression spring ø 12mm L 15.5mm wire gauge ø 1.5mm		



steam/water pipes

steam pipes



1

Part No.	525247	Ref. No.	SVECL003
-----------------	--------	-----------------	----------

description steam pipe thread 3/8" H 155mm L 205mm ϕ 14.3mm tube ϕ 10mm suitable for S.V. ITALIA

accessories for 525247

Part No.	525042	Ref. No.	SVTMP033
-----------------	--------	-----------------	----------

description tube handle for pipe ϕ 10mm ϕ 13.5mm L 50mm rubber



1

Part No.	525246	Ref. No.	SVTML003
-----------------	--------	-----------------	----------

description steam pipe thread 3/8" H 190mm L 220mm ϕ 14.3mm tube ϕ 10mm suitable for S.V. ITALIA

accessories for 525246

Part No.	525042	Ref. No.	SVTMP033
-----------------	--------	-----------------	----------

description tube handle for pipe ϕ 10mm ϕ 13.5mm L 50mm rubber

nozzles for water pipes

nozzles for water pipes



1

Part No.	525260	Ref. No.	SVECS015
-----------------	--------	-----------------	----------

description nozzle D1 ϕ 23.5mm H 30mm thread M10x1 suitable for S.V. ITALIA series JOLLY int. ϕ 1.9mm int. ϕ 2.14mm



1

Part No.	525095	Ref. No.	SVMNS015
-----------------	--------	-----------------	----------

description nozzle D1 ϕ 24mm H 30mm thread M10x1 int. ϕ 1.9mm

tap aerators



1

Part No.	529608	Ref. No.	SVTMS027
-----------------	--------	-----------------	----------

description tap aerator D1 ϕ 23mm H 15mm thread M22x1

water pipes



1

Part No.	525261	Ref. No.	SVECL001
-----------------	--------	-----------------	----------

description water pipe thread 1/4" ϕ 23.5mm L 103mm tube ϕ 8mm suitable for S.V. ITALIA

accessories

bushes



1

Part No.	529705	Ref. No.	SVTMS014
-----------------	--------	-----------------	----------

description bush D1 ϕ 8.3mm D2 ϕ 12mm H 6mm brass ID ϕ 7mm

gaskets



1

Part No.	526392	Ref. No.	SVTMO007
-----------------	--------	-----------------	----------

description flat gasket Viton ED ϕ 21mm ID ϕ 15mm thickness 2mm Qty 1 pcs



1

Part No.	528402	Ref. No.	SVTMG013
-----------------	--------	-----------------	----------

description O-ring Viton thickness 2.62mm ID ϕ 10.78mm Qty 1 pcs

tube handles



1

Part No.	525042	Ref. No.	SVTMP033
-----------------	--------	-----------------	----------

description tube handle for pipe ϕ 10mm ϕ 13.5mm L 50mm rubber

miscellaneous



1

Part No.	525254	Ref. No.	SVTMA008
-----------------	--------	-----------------	----------

description set for steam pipe bush, spring, gasket, O-ring, disc

fine filters

fine filters



1

Part No.	528357	Ref. No.	TM-FIL8522
-----------------	--------	-----------------	------------

description fine filter ϕ 8.5mm H 22mm



			
1			
Part No.	529979	Ref. No.	SVECF013
description	fine filter ø 8.8mm H 22mm		

intake valves

accessories

valves

			
1			
Part No.	525249	Ref. No.	SVTMA007
description	valve for filling valve L 60.5mm		

level glasses

level glasses

level glass pipes

			
1			
Part No.	525240	Ref. No.	SVTMV005
description	water level tube ø 11mm H 140mm ID ø 8mm marking Min/Max blue		

non-return valves

pistons

			
1			
Part No.	525248	Ref. No.	SVTMV011
description	piston for non-return valve triangular ø 13mm L 19.5mm		

knobs

steam/water taps

steam/water taps

			
1			
Part No.	111377	Ref. No.	SVECM008
description	knob ø 41mm L 50mm thread Tr18x2 black with rosette		

			
1			
Part No.	111381	Ref. No.	SVMNM002
description	knob ø 55mm L 56mm shaft ø 8.3mm black		

			
1			
Part No.	111378	Ref. No.	SVTMM004 SVTMM005
description	knob water ø 53mm L 53mm shaft flat upper black		

knob dial plates

			
1			
Part No.	111275	Ref. No.	SVECT047
description	symbol steam ø 32mm L 28mm		

miscellaneous

			
1			
Part No.	111369	Ref. No.	SVTMM023
description	knob ø 28/48mm shaft ø 5x5mm black H 22mm L 40mm		

accessories

button springs

			
1			
Part No.	111380	Ref. No.	SVTMC011
description	knob spring L 12mm W 8mm H 2mm Qty 1 pcs		

gaskets

O-rings

EPDM

			
1			
Part No.	510302	Ref. No.	SVECOR006
description	O-ring EPDM ID ø 12.42mm thickness 1.78mm Qty 1 pcs		

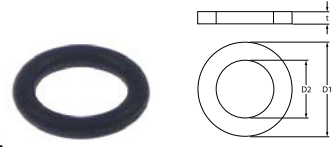
			
1			
Part No.	525255	Ref. No.	SVTM0001
description	O-ring EPDM thickness 1.9mm ID ø 7.2mm Qty 1 pcs		

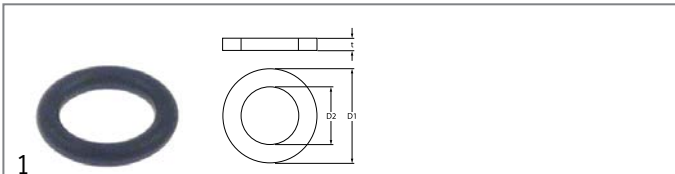
1

Part No.	525259	Ref. No.	SVECOR008
description	O-ring EPDM thickness 1.9mm ID \varnothing 7.6mm Qty 1 pcs		

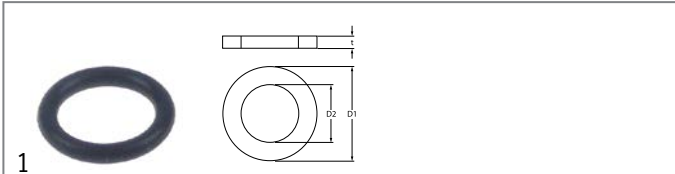

1

Part No.	525256	Ref. No.	SVTMO006
description	O-ring EPDM thickness 1.9mm ID \varnothing 9.2mm Qty 1 pcs		

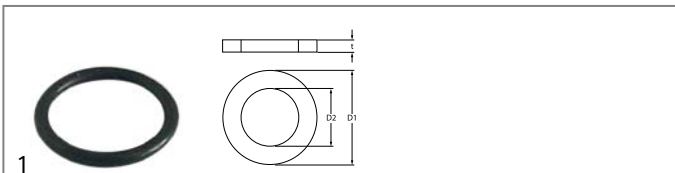

1

Part No.	504590	Ref. No.	SVMNO002
description	O-ring EPDM thickness 2.62mm ID \varnothing 18.72mm Qty 1 pcs		

Viton

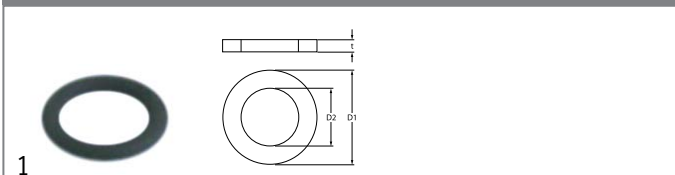

1

Part No.	528402	Ref. No.	SVTMG013
description	O-ring Viton thickness 2.62mm ID \varnothing 10.78mm Qty 1 pcs		

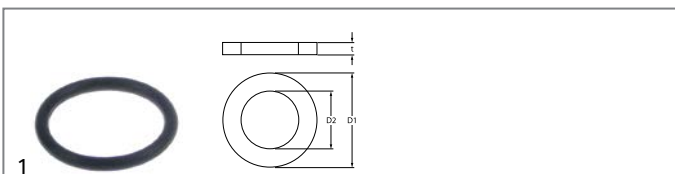

1

Part No.	532560	Ref. No.	TM-OR128
description	O-ring Viton thickness 2.62mm ID \varnothing 20.63mm Qty 1 pcs		

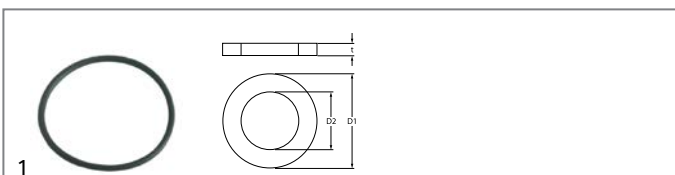

1

Part No.	528413	Ref. No.	SVECOR003
description	O-ring Viton thickness 2.62mm ID \varnothing 47.3mm Qty 1 pcs		

sealing washers

copper gaskets

DIN-7603-A



1

Part No.	528698	Ref. No.	RUBS/L-R003
description	flat gasket copper ED \varnothing 24mm ID \varnothing 20mm thickness 1mm		

PTFE gaskets



1

Part No.	525253	Ref. No.	SVTMG032
description	flat gasket PTFE ED \varnothing 18mm ID \varnothing 13mm thickness 2mm Qty 1 pcs		



1

Part No.	531198	Ref. No.	SVTMO007
description	flat gasket PTFE ED \varnothing 20.5mm ID \varnothing 15mm thickness 2mm Qty 1 pcs		



1

Part No.	525252	Ref. No.	SVECG009
description	flat gasket PTFE ED \varnothing 20mm ID \varnothing 16.5mm thickness 2mm Qty 1 pcs		



1

Part No.	525611	Ref. No.	TM-GUATF22172
description	flat gasket PTFE ED \varnothing 22mm ID \varnothing 17mm thickness 2mm Qty 1 pcs		



1

Part No.	526013	Ref. No.	SVECOR005
description	flat gasket PTFE ED \varnothing 22mm ID \varnothing 17mm thickness 2mm Qty 1 pcs		



1

Part No.	526014	Ref. No.	TM-GUATF35302
description	flat gasket PTFE ED \varnothing 35mm ID \varnothing 30mm thickness 2mm Qty 1 pcs		



Viton gaskets

			
1			
Part No.	526392	Ref. No.	SVTMO007
description	flat gasket Viton ED ø 21mm ID ø 15mm thickness 2mm Qty 1 pcs		

special gaskets

group gaskets

			
1			
Part No.	525241	Ref. No.	SVTMG016
description	group gasket L 76mm W 70mm thickness 2mm aperture 10mm hole distance 54mm suitable for S.V. ITALIA fibre		

springs

compression springs

			
1			
Part No.	525242	Ref. No.	SVMNM008
description	compression spring ø 10.8mm L 57mm wire gauge ø 1mm windings 11		

			
1			
Part No.	528284	Ref. No.	SVTMM024
description	compression spring ø 11mm L 26mm wire gauge ø 1.3mm		

			
1			
Part No.	525243	Ref. No.	SVTMM022
description	compression spring ø 12.5mm L 30mm wire gauge ø 1.8mm windings 7		

			
1			
Part No.	526443	Ref. No.	SVECM007
description	compression spring ø 12mm L 15.5mm wire gauge ø 1.5mm		

			
1			
Part No.	527992	Ref. No.	SVTMM020
description	compression spring ø 8mm L 32mm wire gauge ø 0.5mm		

manometers

			
1			
Part No.	541765	Ref. No.	SVTMM019
description	manometer double scale ø 63mm pressure range 0-2.5 / 0-15bar connection on the backside thread 1/8"		

			
1			
Part No.	531285	Ref. No.	SVTMM034
description	manometer ø 63mm pressure range 0-3 / 0-15bar connection on the backside thread 1/8"		

fastening material

screws

countersunk screws

			
1			
Part No.	560420	Ref. No.	ZVITE026
description	countersunk screw thread M5 L 14mm SS DIN 965/ISO 7046 Qty 1 pcs intake Phillips head ø 9mm		

GASTROPARTS.COM

