



GASTROPARTS

Studio 54

- [EN]** Equipment
- [DE]** Geräte
- [ES]** Aparatos
- [FR]** Équipement
- [IT]** Attrezzature
- [PL]** Urządzenia
- [RU]** Оборудование

✉ gastroparts@gastroparts.com

☎ +48 56 657 00 66

📘 fb.com/gastroparts.global

GASTROPARTS.COM





heating elements

heating elements for refrigeration

heating elements for defrosting



1

Part No.	419232	Ref. No.	64740405
description	heating element 150W 230V L 480mm W 60mm tube ø 8.5mm connection length 1450mm defrosting connection 3-wire with fuse t.max. 100°C		

compressors

EMBRACO / ASPERA

R134A

HBP monophase

High evaporation temperature above -15°C



1

Part No.	605189	Ref. No.	64850046
description	compressor coolant R134a type EMT6160Z 220-240V 50Hz HBP 7.8kg 1/4HP cylinder capacity 6.76cm ³ CSIR H 166mmWWW 325W 412W 513W 630W 762W 910W ambient temperature max. 45°C		



1

Part No.	605209	Ref. No.	64850086
description	compressor coolant R134a type NEK6187Z-A 220-240V 50Hz HBP 11kg 1/3HP cylinder capacity 10cm ³ CSIR H 200mmWWW 365W 482W 624W 791W 983W 1201W test method EN 12900 ambient temperature max. 55°C		



1

Part No.	605079	Ref. No.	64850040
description	compressor coolant R134a type NT6215Z 220-240V 50Hz HBP fully hermetic 17kg 1/2HP cylinder capacity 17.4cm ³ CSIR H 207mmWWW 484W 646W 843W 1071W 1326W 1606W test method EN 12900		

R404a/R507

LBP monophase

Lower evaporation temperature below -20°C



1

Part No.	605260	Ref. No.	64850045
description	compressor coolant R404a type NT2192GK 220/240V 50Hz LBP 17.5kg 1.1HP cylinder capacity 22.37cm ³ CSCR 815W 1066W 1361W 1701W 2085WWW		

fans

refrigeration fans

cold air circulating fans (complete)

ebm-papst

R2E series

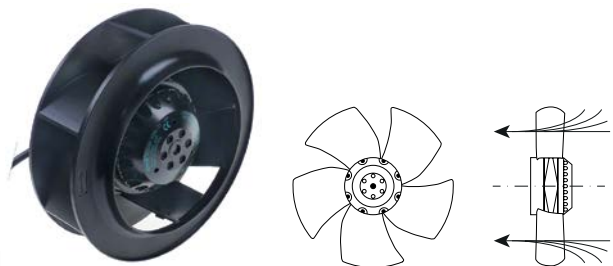

1

Part No.	601536	Ref. No.	64840010
description	fan R2E190-A026-73 fan wheel ø 190mm blades 6 230V 50/60Hz 58/75W ø 190mm H 70mm 2700rpm cable length 450mm rotation direction right ebm-papst sucking suitable capacitor 2µF		
spare parts for	601536		
Part No.	365170	Ref. No.	—
description	capacitor capacity 2µF 425V tolerance 5% 50/60Hz ambient temperature max. -25 to +85°C ø 25mm L 49mm M8 plastic connection cable 250mm 416.17.74 protection		



handles and hand wheels

bracket handles



1

Part No.	690451	Ref. No.	64700185
description	pull handle L 426mm H 40mm mounting distance 376mm black		

hinges

spring assisted hinges

universal

INTERKLIMAT

hinges



1

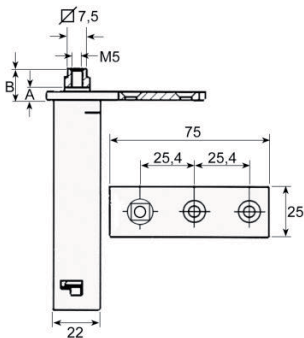

Part No.	690714	Ref. No.	64700125 64700128 64700160
description	spring assisted hinge series 28XC mounting pos. left/right L 75mm W 25mm H 103mm A 8mm B 11mm intake 7.5x7.5 refrigeration units mounting distance 25mm		

gaskets

refrigeration gaskets

plug-in gaskets

profile 9048

We offer custom-made gaskets for this profile

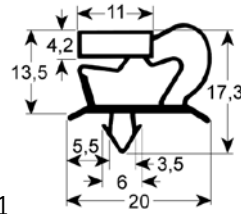

1

Part No.	901677	Ref. No.	64700010
description	refrigeration gasket profile 9048 W 650mm L 1550mm plug size		

profile 9703

We offer custom-made gaskets for this profile

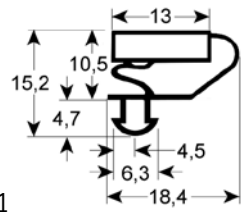

1

Part No.	901791	Ref. No.	64600000
description	refrigeration gasket profile 9703 W 659mm L 731mm plug size		

profile 9704

We offer custom-made gaskets for this profile

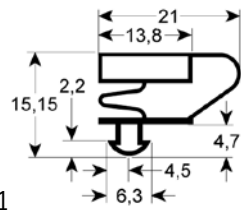

1

Part No.	902411	Ref. No.	64691036
description	refrigeration gasket profile 9704 W 285mm L 415mm plug size		

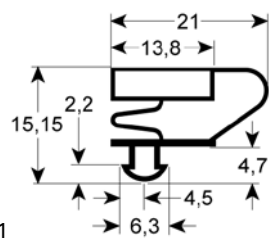

1

Part No.	901031	Ref. No.	N/A
description	refrigeration gasket profile 9704 W 295mm L 423mm plug size L1 414mm W1 286mm external size		

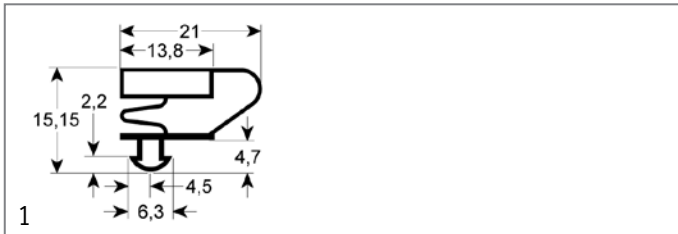

Part No.	902414	Ref. No.	64691084
description	refrigeration gasket profile 9704 W 395mm L 708mm plug size		

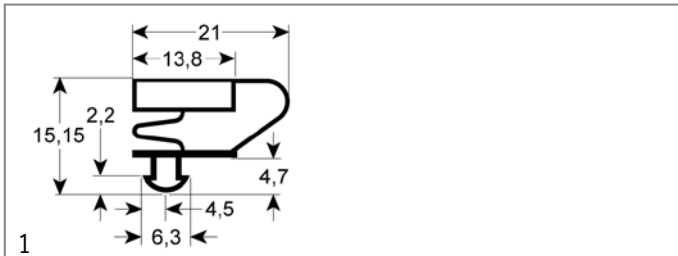

Part No.	901030	Ref. No.	64691002
description	refrigeration gasket profile 9704 W 423mm L 620mm plug size L1 611mm W1 414mm external size		

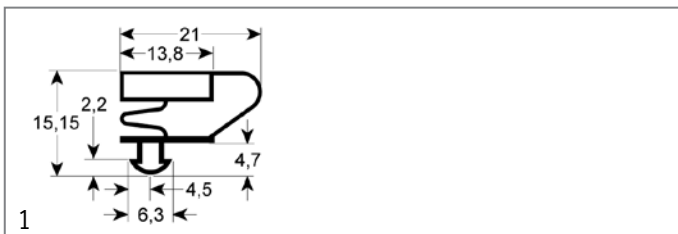

Part No.	902412	Ref. No.	64691020 64700055
description	refrigeration gasket profile 9704 W 454mm L 533mm plug size		

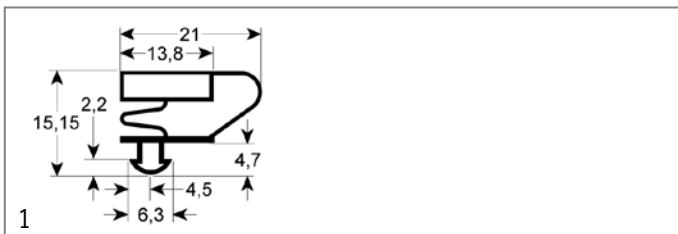

Part No.	902413	Ref. No.	64691004
description	refrigeration gasket profile 9704 W 475mm L 610mm plug size		

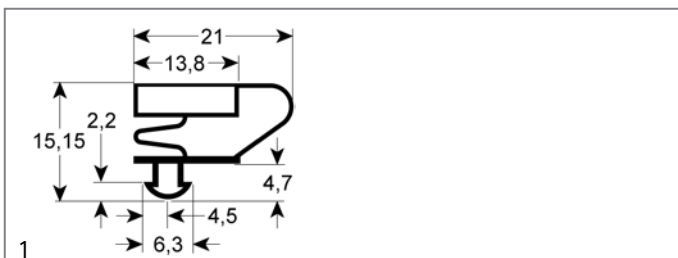

Part No.	902131	Ref. No.	N/A
description	refrigeration gasket profile 9704 W 669mm L 1552mm plug size		

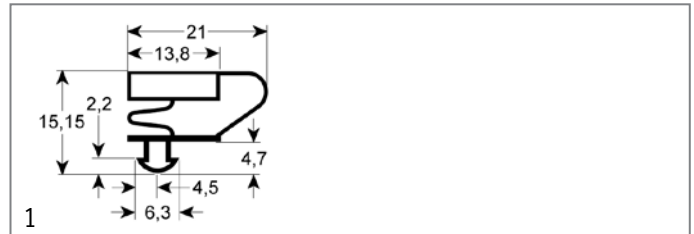

Part No.	902299	Ref. No.	N/A
description	refrigeration gasket profile 9704 Wmm L 2500mm		

profile 9753

We offer custom-made gaskets for this profile



Part No.	901032	Ref. No.	64691038 N/A
description	refrigeration gasket profile 9753 W 186mm L 423mm plug size		

evaporation and condensing trays

unheated condensing trays



Part No.	699209	Ref. No.	64860132
description	drip tray L 420mm W 85mm H 35mm for evaporator		

GASTROPARTS.COM

