



**GASTROPARTS**

# Staff Ice System

- [EN]** Equipment
- [DE]** Geräte
- [ES]** Aparatos
- [FR]** Équipement
- [IT]** Attrezzature
- [PL]** Urządzenia
- [RU]** Оборудование

✉ [gastroparts@gastroparts.com](mailto:gastroparts@gastroparts.com)

☎ +48 56 657 00 66

📘 [fb.com/gastroparts.global](https://fb.com/gastroparts.global)

**GASTROPARTS.COM**





## heating elements

### accessories

sealing washers

O-rings

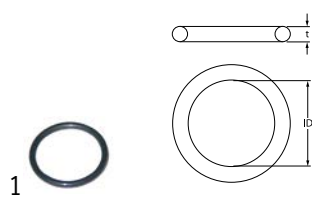

<b>Part No.</b>	510072	<b>Ref. No.</b>	RICG20141
<b>description</b>	O-ring EPDM thickness 3.53mm ID ø 32.93mm Qty 1 pcs		

## thermostats

### refrigeration thermostats

RANCO

K50 series



<b>Part No.</b>	390849	<b>Ref. No.</b>	SL300350467 SL37AAL3231
<b>description</b>	thermostat RANCO type K50-L3231/002 probe ø 1.9mm probe Lmm capillary pipe 1200mm		

K61 series



<b>Part No.</b>	390206	<b>Ref. No.</b>	4007015000
<b>description</b>	thermostat RANCO type K61L1501 probe ømm probe Lmm capillary pipe 1800mm		

## switches and momentary switches

### microswitches

lever actuated

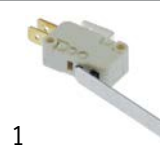

<b>Part No.</b>	347674	<b>Ref. No.</b>	3010314000 3010319000 3010320000 3010321000
<b>description</b>	microswitch 250V 3A 1CO connection male faston 6.3mm L 58mm ambient temperature max. 85°C mounting distance 22mm type D42X actuating force: 6g lever length 44mm		



<b>Part No.</b>	345368	<b>Ref. No.</b>	90/82010000
<b>description</b>	microswitch with lever 250V 10A 1CO connection male faston ambient temperature max. 85°C		

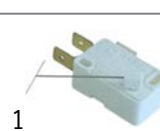

<b>Part No.</b>	345367	<b>Ref. No.</b>	30/10320000
<b>description</b>	microswitch with lever 250V 6A 1CO connection male faston 6.3mm L 113mm ambient temperature max. 85°C mounting distance 22mm actuating force: 40g		



### float switches



<b>Part No.</b>	379653	<b>Ref. No.</b>	3010024000 3010024500 9090611000
<b>description</b>	float switch 1CO L 90mm mounting ømm 250V 3A male faston 6.3mm cable lengthmm type D42X ambient temperature max. 85°C with float for MP		



			
1			
<b>Part No.</b>	347248	<b>Ref. No.</b>	90/90611000
<b>description</b>	microswitch 1CO 250V 3A connection male faston 6.3mm with float type D42X ambient temperature max. 85°C lever length 90mm for MP		

			
1			
<b>Part No.</b>	348026	<b>Ref. No.</b>	
<b>description</b>	float switch kit 1CO ø 25mm L 73mm mounting ø 12mm 250V 10A male faston 6.3mm cable length 1380mm		
<b>spare parts for</b>	348026		
	<b>Part No.</b>	380812	<b>Ref. No.</b> —
	power relays FINDER 230VAC 30A 2CO connection F6.3 bracket mounting manuf. no. 66.82.8.230.0000		

## floats

			
1			
<b>Part No.</b>	348191	<b>Ref. No.</b>	4063018500
<b>description</b>	float without magnet ø 56mm L 135mm W 56mm H 95mm		



			
1			
<b>Part No.</b>	348025	<b>Ref. No.</b>	90/20364000
<b>description</b>	float without magnet ømm L 84mm W 30mm H 25mm PVC		

## relays

## power relays

with male contacts

female contact 2.0mm

			
1			
<b>Part No.</b>	380494	<b>Ref. No.</b>	—
<b>description</b>	power relays FINDER 230VAC 7A 4CO connection F2 plug-in connection manuf. no. 55.34.8.230.0054 94.74/ZMD4 250V connection 2mm		
<b>accessories for</b>	380494		
	<b>Part No.</b>	380341	<b>Ref. No.</b> —
	relay socket 4-pole contacts 12 300V voltage AC 6A Italiana Relè manuf. no. ZMD4		
	<b>Part No.</b>	380399	<b>Ref. No.</b> —
	relay socket 4-pole dimensions 76.2x27x86.1mm 250V voltage AC 1A FINDER manuf. no. 94.94.3		

## electronics

## PCBs

			
1			
<b>Part No.</b>	403468	<b>Ref. No.</b>	30/50048000
<b>description</b>	control PCB ice maker MG14 L 49mm W 25mm suitable for STAFF ICE cable length 1400mm Qty 1 pcs		

## solenoid valves

## solenoid valves (water)

ELBI

spare parts and accessories

reducers









outlet side

			
1			
<b>Part No.</b>	371262	<b>Ref. No.</b>	4012008000
<b>description</b>	reducer ELBI type EATON (INVENSYS) flow rate 2.5l/min pressure range 0 up to 10bar tolerance ±15/25% orange		



			
1			
<b>Part No.</b>	371260	<b>Ref. No.</b>	40/12005000
<b>description</b>	reducer type ELBI flow rate 0.5l/min pressure range 0 up to 10bar tolerance ±15/25% red		

RPE			
			
1			
<b>Part No.</b>	374021	<b>Ref. No.</b>	4012022000
<b>description</b>	solenoid valve double straight 230VAC inlet 3/4" outlet 10mm DN10 RPE		

TP			
			
1			
<b>Part No.</b>	370017	<b>Ref. No.</b>	4012012000
<b>description</b>	solenoid valve single straight 230VAC inlet 3/4" outlet 11.5mm DN10 TP p max 10bar		
<b>spare parts for</b>	370017		
			
<b>Part No.</b>	371013	<b>Ref. No.</b>	—
<b>description</b>	solenoid coil TP 230VAC 50/60Hz		
<b>accessories for</b>	370017		
			
<b>Part No.</b>	371220	<b>Ref. No.</b>	—
<b>description</b>	reducer TP flow rate 3l/min red tolerance ±15%		
			
<b>Part No.</b>	371221	<b>Ref. No.</b>	—
<b>description</b>	reducer TP flow rate 5.5l/min yellow tolerance ±15%		
			
<b>Part No.</b>	371222	<b>Ref. No.</b>	—
<b>description</b>	reducer TP flow rate 6l/min grey tolerance ±15%		
			
<b>Part No.</b>	371223	<b>Ref. No.</b>	—
<b>description</b>	reducer TP flow rate 10l/min white tolerance ±15%		
			
<b>Part No.</b>	371224	<b>Ref. No.</b>	—
<b>description</b>	reducer TP flow rate 12l/min bronze tolerance ±15%		
			
<b>Part No.</b>	371225	<b>Ref. No.</b>	—
<b>description</b>	reducer TP flow rate 16l/min light brown tolerance ±15%		
			
<b>Part No.</b>	371226	<b>Ref. No.</b>	—
<b>description</b>	reducer TP flow rate 20l/min red tolerance ±15%		

<b>accessories for</b>	370017		
			
<b>Part No.</b>	371230	<b>Ref. No.</b>	—
<b>description</b>	reducer TP flow rate 0.25l/min red tolerance ±25%		
			
<b>Part No.</b>	371231	<b>Ref. No.</b>	—
<b>description</b>	reducer TP flow rate 0.35l/min violet tolerance ±25%		
			
<b>Part No.</b>	371232	<b>Ref. No.</b>	—
<b>description</b>	reducer TP flow rate 0.5l/min orange tolerance ±25%		
			
<b>Part No.</b>	371233	<b>Ref. No.</b>	—
<b>description</b>	reducer TP flow rate 0.8l/min white tolerance ±25%		
			
<b>Part No.</b>	371234	<b>Ref. No.</b>	—
<b>description</b>	reducer TP flow rate 1l/min light blue tolerance ±25%		
			
<b>Part No.</b>	371235	<b>Ref. No.</b>	4012006000
<b>description</b>	reducer TP flow rate 1.2l/min brown tolerance ±25%		
			
<b>Part No.</b>	371236	<b>Ref. No.</b>	—
<b>description</b>	reducer TP flow rate 1.5l/min light brown tolerance ±25%		
			
<b>Part No.</b>	371237	<b>Ref. No.</b>	—
<b>description</b>	reducer TP flow rate 2.5l/min yellow tolerance ±25%		
			
<b>Part No.</b>	371238	<b>Ref. No.</b>	—
<b>description</b>	reducer TP flow rate 3.4l/min dark green tolerance ±25%		
			
<b>Part No.</b>	371239	<b>Ref. No.</b>	—
<b>description</b>	reducer TP flow rate 5l/min black tolerance ±25%		
			
<b>Part No.</b>	371240	<b>Ref. No.</b>	—
<b>description</b>	reducer TP flow rate 8l/min blue tolerance ±20%		

spare parts and accessories			
reducers			
outlet side			
			
1			
<b>Part No.</b>	371235	<b>Ref. No.</b>	4012006000
<b>description</b>	reducer TP flow rate 1.2l/min brown tolerance ±25%		



metal

CEME

accessories



1

<b>Part No.</b>	371154	<b>Ref. No.</b>	951342 SL300951342
<b>description</b>	solenoid coil connection male faston 6.3mm CEME 50Hz 230V H 30mm seat ø 10mm voltage AC		

## solenoid valves (refrigeration)

various

valve bodies



1

<b>Part No.</b>	381437	<b>Ref. No.</b>	4011020000
<b>description</b>	solenoid valve body single type CLS 2.5 p maxbar pressure rangebar connection 6mm		

## pressure switches

for refrigeration

SAGI NO MIYA



1

<b>Part No.</b>	541479	<b>Ref. No.</b>	4006013000
<b>description</b>	pressure control HD reset automatic refrigeration type HTB-X114 connection 2.4mm		

## fans

refrigeration fans

refrigeration motors universal

accessories

fan wheels

aluminium



1

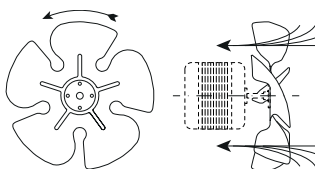

<b>Part No.</b>	601387	<b>Ref. No.</b>	000233
<b>description</b>	fan wheel sucking ø 254mm fan wheel mounting 25.4mm blade angle 34° W 50mm aluminium		

## motors

gear motors

for ice-cube maker

for paddles



1

<b>Part No.</b>	500416	<b>Ref. No.</b>	90/82013000
<b>description</b>	gear motor		

1

<b>Part No.</b>	500415	<b>Ref. No.</b>	90/82014000
<b>description</b>	gear motor FIBER type G0251AMAKOO 12V 50/60Hz 30rpm shaft ø 12mm L 76mm W 52mm H 37mm motor type M51BJOR0000		





1

<b>Part No.</b>	501549	<b>Ref. No.</b>	9082010500
<b>description</b>	gear motor MECHTEX type GB5F 15 230V 50Hz 40rpm shaft ø 12mm rotation direction clockwise		





1

<b>Part No.</b>	500991	<b>Ref. No.</b>	3004010000
<b>description</b>	gear motor FIBER type GE15JAMAD00 3.9W 230V 50/60Hz 50rpm shaft ø 12mm for ice-cube maker motor type M51BJOR0000		
<b>accessories for</b>	500991		
	<b>Part No.</b>	<b>Ref. No.</b>	90/20372000
	500418		
	bracket for gear motor		



1

<b>Part No.</b>	501451	<b>Ref. No.</b>	90/82011000 908201100
<b>description</b>	motor FIBER type G025JAMAF00 3.9W 230V 50/60Hz 40rpm shaft ø 12mm for ice-cube maker motor type M51BJOR0000		
<b>accessories for</b>	501451		
	<b>Part No.</b>	<b>Ref. No.</b>	90/20372000
	500418		
	bracket for gear motor		



1

<b>Part No.</b>	500420	<b>Ref. No.</b>	90/82012000
<b>description</b>	gear motor FIBER type W0100ALAD00 230V 50Hz 5rpm shaft ø 12mm L 52mm W 76mm H 52mm motor type M353		

for sumps



1

<b>Part No.</b>	500402	<b>Ref. No.</b>	90/82020000
<b>description</b>	gear motor KENTA type IC9113065 69W 230V 50Hz 2rpm shaft ø 14mm W 60mm H 150mm L 150mm		



1

<b>Part No.</b>	501550	<b>Ref. No.</b>	9082013500
<b>description</b>	gear motor MECHTEX type GB5F 12X 3.9W 230V 50Hz 50rpm shaft ø 12mm for ice-cube maker		

miscellaneous



1

<b>Part No.</b>	500403	<b>Ref. No.</b>	90/82016000
<b>description</b>	gear motor AUTOM 230V 50Hz shaft ø 8mm L 240mm W 130mm H 60mm		



1 electric components

for drink dispensers



1

<b>Part No.</b>	499305	<b>Ref. No.</b>	950212 SL300950212
<b>description</b>	gear motor ELCO 70/60W 230V voltage AC 50/60Hz 32/38rpm shaft ø 6x12mm L 225mm W 75mm H 100mm for drink dispenser		

doors

doors



1

<b>Part No.</b>	694708	<b>Ref. No.</b>	90/90852700
<b>description</b>	door for ice maker W 275mm H 223mm thickness 29mm black		

pumps

pumps for ice machines



1

<b>Part No.</b>	501465	<b>Ref. No.</b>	30/02021000 9082101000
<b>description</b>	pump FIR type 4262/48 110W 230V 50/60Hz inlet ø 17mm outlet ø 17mm L 210mm capacitor 5µF		

pan mechanics

spare parts and accessories



1

<b>Part No.</b>	694707	<b>Ref. No.</b>	90/20317000
<b>description</b>	lever for sump L 235mm W 40mm H 74mm suitable for STAFF ICE		

equipment-specific units

for ice-cube maker

gearboxes

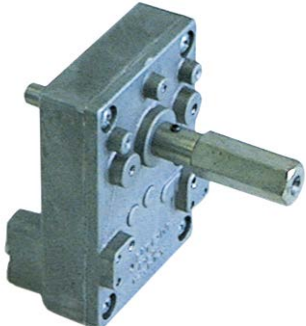

1

<b>Part No.</b>	500404	<b>Ref. No.</b>	30/05900000
<b>description</b>	gearbox		



1

<b>Part No.</b>	695001	<b>Ref. No.</b>	90/70331500
<b>description</b>	paddle with spindle		



1

<b>Part No.</b>	695002	<b>Ref. No.</b>	90/70331700
<b>description</b>	paddle with spindle		









1

<b>Part No.</b>	695003	<b>Ref. No.</b>	70331800
<b>description</b>	paddle with spindle		



mechanics for evaporators			
miscellaneous			
			
1			
<b>Part No.</b>	696722	<b>Ref. No.</b>	951752 SL300951752
<b>description</b>	bush for evaporator		

hoses			
hose connectors			
with thread			
			
1			
<b>Part No.</b>	695052	<b>Ref. No.</b>	40/41319000
<b>description</b>	hose connector		
<b>spare parts for</b>	695052		
			
<b>Part No.</b>	516026	<b>Ref. No.</b>	—
<b>description</b>	O-ring EPDM thickness 2.62mm ID ø 17.86mm Qty 1 pcs		
			
<b>Part No.</b>	516109	<b>Ref. No.</b>	—
<b>description</b>	drain fitting ID ø 23mm		
			
<b>Part No.</b>	516110	<b>Ref. No.</b>	—
<b>description</b>	hose connector hose ø 23mm		

floats			
float containers			
			
1			
<b>Part No.</b>	695073	<b>Ref. No.</b>	90/87016000
<b>description</b>	float container		
<b>spare parts for</b>	695073		
			
<b>Part No.</b>	346872	<b>Ref. No.</b>	—
<b>description</b>	microswitch with lever 250V 0.1A 1CO connection male faston 6.3mm L 50mm ambient temperature max. 85°C mounting distance 22mm type D41X actuating force: 6g lever length 36mm		

miscellaneous			
			
1			
<b>Part No.</b>	694709	<b>Ref. No.</b>	90/20352000
<b>description</b>	bracket for ice maker W 18mm H 27mm hole ø 8mm		

			
1			
<b>Part No.</b>	695043	<b>Ref. No.</b>	90/20319000 90/78054000
<b>description</b>	lever		

## for drink dispensers

bushes			
			
1			
<b>Part No.</b>	650245	<b>Ref. No.</b>	SL340001653
<b>description</b>	bush for evaporator H 30mm ø 35.5mm D2 ø 21mm		

gaskets			
			
1			
<b>Part No.</b>	650220	<b>Ref. No.</b>	SL300951857 SL320001630
<b>description</b>	gasket for auger D1 ø 34.5mm D2 ø 26mm ID ø 20mm H 19mm rubber		

			
1			
<b>Part No.</b>	650164	<b>Ref. No.</b>	950070 SL3GS36007B
<b>description</b>	gasket for evaporator D1 ø 170mm ID ø 160mm H 13mm silicone		

			
1			
<b>Part No.</b>	650163	<b>Ref. No.</b>	SL300950258 SL3GS12044A SL3GS24044A
<b>description</b>	gasket for outlet tap D1 ø 25mm D2 ø 16mm H 21mm silicone		



for dishwashers

door mechanics

locks



1

<b>Part No.</b>	507011	<b>Ref. No.</b>	20/62150000
<b>description</b>	door catch complete door locking catch		

hinges

door bearing



1

<b>Part No.</b>	701167	<b>Ref. No.</b>	9016047900
<b>description</b>	bearing block L 67mm W 22mm H 8.5mm mounting pos. bottom right thickness 1mm		

gaskets

O-rings

EPDM

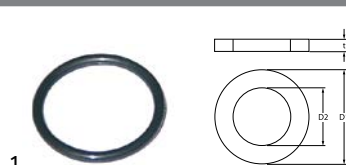

1

<b>Part No.</b>	510072	<b>Ref. No.</b>	RICG20141
<b>description</b>	O-ring EPDM thickness 3.53mm ID $\phi$ 32.93mm Qty 1 pcs		

silicone

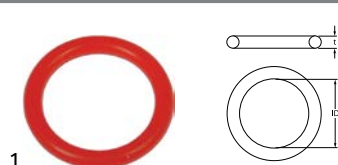

1

<b>Part No.</b>	532250	<b>Ref. No.</b>	950194 SL300950194
<b>description</b>	O-ring silicone thickness 2.62mm ID $\phi$ 17.13mm Qty 10 pcs		

transmission technology and ball bearings

ball bearings

miscellaneous

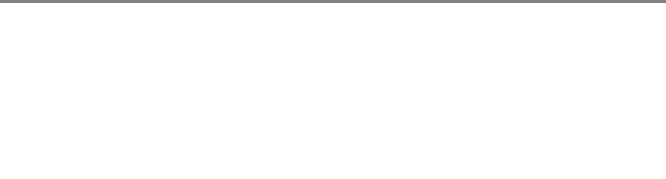

1

<b>Part No.</b>	691226	<b>Ref. No.</b>	20/08105000
<b>description</b>	ball bearing		



1

<b>Part No.</b>	691227	<b>Ref. No.</b>	20/08110000
<b>description</b>	ball bearing		

drive belts

V-belts

profile Z/10



1

<b>Part No.</b>	697686	<b>Ref. No.</b>	20/05010000
<b>description</b>	V-belt belt width 10mm L 520mm H 6mm CODE Z20 1/2 profile Z/10		



1

<b>Part No.</b>	691224	<b>Ref. No.</b>	20/05011000
<b>description</b>	V-belt belt width 10mm L 635mm H 6mm CODE Z25 profile Z/10		



1

<b>Part No.</b>	691225	<b>Ref. No.</b>	20/05012000
<b>description</b>	V-belt belt width 10mm L 710mm H 6mm CODE Z28 profile Z/10		



## fastening material

fasteners			
retaining rings			
DIN 471			
			
1			
<b>Part No.</b>	523107	<b>Ref. No.</b>	SL300950254
<b>description</b>	retaining ring shaft ø 11mm thickness 1mm SS DIN 471		

**GASTRO**PARTS.COM

