



GASTROPARTS

Simag

- [EN]** Equipment
- [DE]** Geräte
- [ES]** Aparatos
- [FR]** Équipement
- [IT]** Attrezzature
- [PL]** Urządzenia
- [RU]** Оборудование

✉ gastroparts@gastroparts.com

☎ +48 56 657 00 66

📘 fb.com/gastroparts.global

GASTROPARTS.COM





thermostats

control and safety thermostats

RANCO

safety thermostats

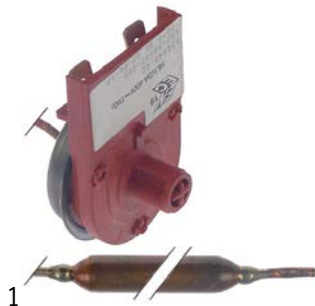

Part No.	375832	Ref. No.	62044300 62044302
description	safety thermostat t.max. 70°C temperature range 0-70°C 1-pole 1N0 16A probe ø 8mm probe L 60mm capillary pipe 870mm capillary pipe isolatedmm gland nut shaft ømm shaft Lmm shaft position rotation° probe material copper switch-off temp. 70°C		
For models:	SD18, SD22, SD23, SD30, SDN25		

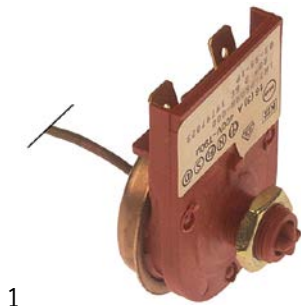

Part No.	390583	Ref. No.	CM19797023
description	safety thermostat t.max. 80°C temperature range°C 1-pole 1NC 16A probe ø 9mm probe L 50mm capillary pipe 800mm capillary pipe isolatedmm gland nut shaft ømm shaft Lmm shaft position rotation° probe material copper with coiled probe screw connection M10x0.75 switch-off temp. 80°C		

refrigeration thermostats

universal with housing



Part No.	390536	Ref. No.	Z1EL042
description	thermostat temperature range -35 up to +35°C probe ø6x110mm capillary pipe 1500mm PRODIGY at 400V 16A 1CO type TR/711-N		

DANFOSS

service thermostats DANFOSS

All Danfoss thermostats are supplied with fastening material application:
 390552 - **fridges
 390553 - **Refrigerators with defrosting push button 390554 -
 /Refrigerators with automatic defrosting 390555 -
 absorption refrigerators
 390557 - Deep cooler with active signal
 390558 - Freezing with passive signal
 390559 - bottle cooler 390559



Part No.	390559	Ref. No.	CM19797007 CM19797012
description	thermostat type 077B7008 capillary pipe 2000mm temperature range -8.5 up to +11.5°C probe ømm probe Lmm		

RANCO

K22 series



Part No.	390201	Ref. No.	Z1EL012
description	thermostat RANCO type K22L2021 probe ømm probe Lmm capillary pipe 2500mm temperature range -16°C		





Part No.	390207	Ref. No.	1EL011 62026414 Z1EL011
description	thermostat RANCO type K22L2030 probe ø 2mm probe Lmm capillary pipe 2000mm temperature range -13 up to -4°C		
For models:	SD22, SD23, SD40		

1 

Part No.	390646	Ref. No.	620263.03
description	thermostat RANCO type K22-L1075 capillary pipe 2900mm probe ø9.5x107mm		



1 

Part No.	390209	Ref. No.	62020100
description	thermostat RANCO type K22L1020 probe ø 9mm probe L 40mm capillary pipe 2000mm temperature range -20.5 up to -1.5°C		
For models:	SD22, SD23, SD30, SDN25		



1 

Part No.	390737	Ref. No.	620201.01
description	thermostat RANCO type K22-L1074 probe ø 9mm probe L 42mm capillary pipe 1450mm temperature range -19 up to -1°C		



1 

Part No.	390277	Ref. No.	630038.00
description	thermostat RANCO type K22L3020 probe ø 9mm probe L 40mm capillary pipe 1600mm temperature range -26.5 up to -19.5°C		



1 

Part No.	390279	Ref. No.	62012900
description	thermostat RANCO type K22L3022 probe ø 9mm probe L 35mm capillary pipe 1600mm		

K50 series



1 

Part No.	390254	Ref. No.	620209.00
description	thermostat RANCO type K50P1135 probe ømm probe Lmm capillary pipe 2500mm T cold 1.5°C		
For models:	SD18, SD22, SD23, SD30		



1 

Part No.	390581	Ref. No.	CM19797026
description	thermostat RANCO type K50-S3595 probe ø 2mm probe Lmm capillary pipe 2000mm		

K55 series



1 

Part No.	390210	Ref. No.	62026302 Z1EL010
description	thermostat RANCO type K55L1042 capillary pipe 1100mm temperature range +1.7 up to +9.5°C probe ø10x110mm		
For models:	SD23		





1 

Part No.	390283	Ref. No.	CM19797017
description	thermostat RANCO type K55L5081 capillary pipe 1100mm temperature range°C probe ø10x110mm		



			
1			
Part No.	390284	Ref. No.	CM19797018
description	thermostat RANCO type K55L5082 capillary pipe 1500mm temperature range°C probe ø10x110mm		

			
1			
Part No.	379516	Ref. No.	620264.02 62026415 62026416
description	thermostat RANCO type K61L1508 probe ø 2mm probe Lmm capillary pipe 1800mm		

K61 series			
			
1			
Part No.	390212	Ref. No.	620264.01 620264.10
description	thermostat RANCO type K61L1500 probe ømm probe Lmm capillary pipe 750mm T war -11.5°C T cold 22°C		

			
1			
Part No.	390591	Ref. No.	62026415
description	thermostat RANCO type K61L1509 probe ø 2mm probe Lmm capillary pipe 2250mm		
For models:	SD18		

			
1			
Part No.	390206	Ref. No.	620264.00
description	thermostat RANCO type K61L1501 probe ømm probe Lmm capillary pipe 1800mm		

switches and momentary switches

rocker/momentary rocker switches

30x11mm

			
1			
Part No.	301013	Ref. No.	62044201 62044202
description	rocker switch mounting measurements 30x11mm black 1CO 250V 16A connection male faston 6.3mm ambient temperature max. 85/125°C protection IP40		
For models:	SD18, SD22, SD23, SD30, SDN25		

			
1			
Part No.	390586	Ref. No.	620264.11
description	thermostat RANCO type K61L1504 probe ø 2mm probe Lmm capillary pipe 1800mm T war 11.5°C T cold 22°C		

push/momentary push switches

19x13mm

			
1			
Part No.	347079 ¹	Ref. No.	620487.00
description	push switch mounting measurements 19x13mm green 2NO 250V 16A illuminated connection male faston 6.3mm ambient temperature max. 125°C protection IP65 with cover cap		

¹illuminated



toggle switches

M12x0.75



Part No.	346526	Ref. No.	1200042601 620033 01 62003302 Z1EL031
description	toggle switch thread M12x0.75 1CO 250V 15A ON-ON male faston 6.3mm		

microswitches

lever actuated



Part No.	345345	Ref. No.	CM19410207 CM25474578
description	microswitch with lever 250V 16A 1CO connection male faston 6.3mm L 78mm ambient temperature max. 85°C mounting distance 22mm type X662-88-J27 actuating force: 40g lever length 69mm		



Part No.	345361	Ref. No.	CM19410205
description	microswitch with lever 250V 5A 1NO/1NC connection soldering connection ambient temperature max. 85°C type 83109004 lever length 43mm		

roller-lever actuated

microswitches



Part No.	345253	Ref. No.	CM19410209
description	microswitch with handle with a switch 250V 15A 1CO connection male faston 6.3mm L 28mm L1 37mm ambient temperature max. 125°C mounting distance 22mm type RL6-1-F-GE-P12-5-L actuating force: 80g grey lever length 28mm		

heavy duty version



Part No.	346874	Ref. No.	CM19410300
description	microswitch with handle with a switch 250V 16A 1CO connection screw L 29mm L1 49mm ambient temperature max. 85°C mounting distance 26mm type Z-15GW22-B actuating force: 120g lever length 25mm		

with mounting components



Part No.	346876	Ref. No.	CM19410208
description	microswitch with handle with a switch 250V 16A 1CO connection male faston L 35mm L1 28mm ambient temperature max. 125°C mounting distance 22mm type V-166-1CR5 actuating force: 86g		

float switches



Part No.	345365	Ref. No.	CM81409179
description	float switch 250V 16A 1CO male faston 6.3mm L 150mm ambient temperature max. 125°C mounting distance 23mm type EF83161.5 actuating force: 5g black		



Part No.	347088	Ref. No.	CM81449091
description	float switch with plunger 250V 16A 1CO male faston 6.3mm L 130mm ambient temperature max. 125°C mounting distance 23mm type EF83161.5 actuating force: 5g black		

floats



Part No.	695036	Ref. No.	66058500 783127.00
description	float for ice maker ø 75mm L 115mm H 40mm plastic		
For models:	SP405, SPR80		

touch sensitive light switches



Part No.	402039	Ref. No.	78508600 78508602R
description	light barrier		



1

Part No.	402043	Ref. No.	650674.01 65067402 785086.00
description	light barrier L 180mm W 35mm H 46mm		
For models:	SP405, SPR80		



1

Part No.	402009	Ref. No.	650674.00 650674.05 783167.01
description	light barrier L 310mm W 35mm H 47mm		

magnetic switches

36x13mm



1

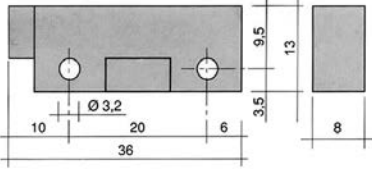

Part No.	345118 ¹	Ref. No.	CM33210019
description	magnetic switch L 36mm W 13mm 1NO 250V 1A P max. 50W connection cable cable length 980mm		
accessories for	345118		
	Part No.	345399	Ref. No. CM193550007 CM19355004
	magnet ø 3.3mm L 40mm H 8mm W 13mm hole distance 30mm M3		

¹with coded connector

accessories

magnets



1

Part No.	347059	Ref. No.	CM19355007
description	magnet L 40mm H 8mm W 13.2mm hole distance 30mm		

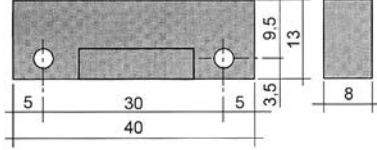
1

Part No.	345399	Ref. No.	CM193550007 CM19355004
description	magnet ø 3.3mm L 40mm H 8mm W 13mm hole distance 30mm M3		

lamps

indicator lights

indicator lights (complete)

ø13mm

with plug-in socket



1

Part No.	359141	Ref. No.	630091.11 630091.14
description	indicator light ø 13mm red 230V connection male faston 6.3mm temp.-resist. 120°C Qty 1 pcs		

timers

programme timers



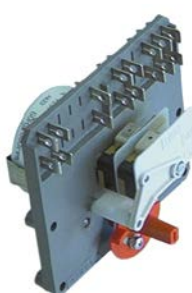

1

Part No.	360163	Ref. No.	620244.02
description	timer FIBER P23 engines 1 chambers 1 operation time 15min 230V shaft L 30mm manuf. no. P235JR1J706 motor type M51BJ0R6400		
spare parts for	360163		
	Part No.	360673	Ref. No. —
	motor kit pinion ø 6.8mm teeth 15 230V voltage AC 50/60Hz turn direction clockwise motor ø 48mm H 18.5mm motor type UDS-4ONE1RNZ165 cable length 150mm with holder		





1

Part No.	360162	Ref. No.	620244.09
description	timer FIBER P23 engines 1 chambers 2 operation time 12min 230V manuf. no. P235JR2J501 motor type M51BJOR6400		
spare parts for	360162		
	Part No.	360673	Ref. No. —
	motor kit pinion \varnothing 6.8mm teeth 15 230V voltage AC 50/60Hz turn direction clockwise motor \varnothing 48mm H 18.5mm motor type UDS-40NE1RNZ165 cable length 150mm with holder		



1

Part No.	360051	Ref. No.	62043100
description	timer FIBER P36 engines 1 chambers 2 operation time 15min 230V shaft \varnothing mm shaft Lmm manuf. no. P365JR2J717 motor type M51BJOR6400		
spare parts for	360051		
	Part No.	360673	Ref. No. —
	motor kit pinion \varnothing 6.8mm teeth 15 230V voltage AC 50/60Hz turn direction clockwise motor \varnothing 48mm H 18.5mm motor type UDS-40NE1RNZ165 cable length 150mm with holder		



1

Part No.	360371	Ref. No.	620441.02
description	timer FIBER P36 engines 1 chambers 2 operation time 8min 230V shaft \varnothing mm shaft Lmm manuf. no. P365JR2J236 motor type M51BJOR6400		
For models:	SD30		
spare parts for	360371		
	Part No.	360673	Ref. No. —
	motor kit pinion \varnothing 6.8mm teeth 15 230V voltage AC 50/60Hz turn direction clockwise motor \varnothing 48mm H 18.5mm motor type UDS-40NE1RNZ165 cable length 150mm with holder		

relays

power relays

with bracket mounting



1

Part No.	380312	Ref. No.	62023702 CM19620107 Z1EL004
description	power relays FINDER 230VAC 10A 3CO connection male faston 4.8mm bracket mounting dimensions 52x32.2x36.5mm manuf. no. 60.63.8.230.0000		



1

Part No.	380185	Ref. No.	CM19620103
description	power relays Italiana Relè 230VAC 30A 1NO connection F6.3 bracket mounting dimensions 36.5x32.2x51.8mm manuf. no. A10-230AC-FA		

time relays

time relays



1

Part No.	360161	Ref. No.	Z1EL051
description	time relay FIBER R1655M607VO time range 0-6min 220VAC 6A/2A		





probes

producer-specific probes

probes

			
1			
Part No.	379628	Ref. No.	02003410.21
description	temperature probe 2x NTC 10K cable PVC probe -40 up to +110°C cable -10 up to 100°C connection coded plug thread probe ø6.5x45mm cable length 0.4/0.55m		

			
1			
Part No.	381337	Ref. No.	620519 01
description	temperature probe NTC 10kOhm cable PVC probe -40 up to +110°C cable -10 up to 100°C connection plug thread probe ø5x40mm cable length 1.5m		

			
1			
Part No.	402006	Ref. No.	620404.06 CM33580065
description	temperature probe PTC 2kOhm cable PVC probe -50 up to +150°C cable -10 up to 100°C connection plug thread probe ø5x60mm cable length 1.5m		

			
1			
Part No.	402007	Ref. No.	62040401
description	temperature probe PTC 2kOhm cable PVC probe -50 up to +150°C cable -10 up to 100°C connection plug thread probe ø5x60mm cable length 1.8m		

			
1			
Part No.	402008	Ref. No.	62040402
description	temperature probe PTC 2kOhm cable PVC probe -50 up to +150°C cable -10 up to 100°C connection plug thread probe ø6x50mm cable length 1.2m		

			
1			
Part No.	402191	Ref. No.	62040401 62040411 62040418
description	temperature probe PTC 2kOhm cable TPE probe -50 up to +150°C cable -40 up to +110°C connection plug thread probe ø5x20mm cable length 1.8m		
For models:	SP405, SPR80		

			
1			
Part No.	402005	Ref. No.	620404.00 62040410
description	temperature probe PTC 2kOhm cable TPE probe -50 up to +150°C cable -40 up to +110°C connection plug thread probe ø6x50mm cable length 1.6m		
For models:	SP405, SPR80		

Hall sensors

			
1			
Part No.	402044	Ref. No.	62040403
description	Hall sensor L 29mm W 26mm H 26mm mounting distance 10mm cable length 1250mm		
For models:	SP405, SPR80		

accessories



miscellaneous

			
1			
Part No.	402040	Ref. No.	62040404 62040413
description	cable for level electrode cable length 1800mm		
For models:	SP405, SPR80		

electronics

housing for PCBs

			
1			
Part No.	695663	Ref. No.	660546.00 CM29070021
description	housing PCB L 230mm W 142mm H 57mm		
For models:	SP405		

			
1			
Part No.	694206	Ref. No.	660547.00 660547.01 660547.02 CM19190403
description	lid PCB L 180mm W 110mm H 9mm		
For models:	SP405		
accessories for	694206		
	Part No.	694205	Ref. No.
			—
	 housing PCB L 180mm W 110mm H 40mm		

1

Part No.	694796	Ref. No.	CM29015057
description	lid PCB L 205mm W 125mm H 14mm plastic		

PCBs

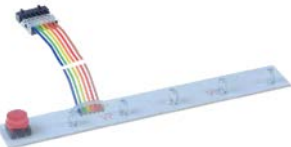

1

Part No.	401805	Ref. No.	CM33580151
description	display PCB ice maker N201/N301//N501 L 170mm W 25mm		

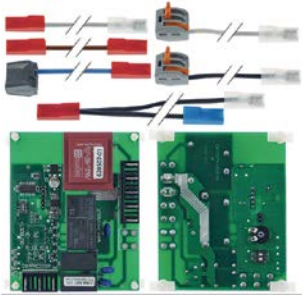

1

Part No.	403687	Ref. No.	06076900 62044100
description	electronic timer for ice maker Simag mounting measurements 90x70mm 230		
For models:	SD22, SD23, SD30, SDN25		



1

Part No.	403486	Ref. No.	62050700
description	electronic timer L 73mm W 73mm suitable for Simag H 30mm timer		

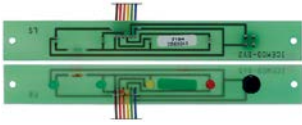

1

Part No.	401801	Ref. No.	CM33580024
description	keypad PCB ice maker N200/N300/N500		



1

Part No.	403499	Ref. No.	CM33580173
description	PCB 230V L 90mm W 60mm for ice maker		



1

Part No.	402137	Ref. No.	02003707.21 11000539.21 11000539.51
description	PCB for float switch		



1

Part No.	402003	Ref. No.	620403.05 620403.16 620403.17
description	PCB ice maker AC045/055		



1

Part No.	403478	Ref. No.	620507-01
description	PCB ice maker L 90mm W 72mm suitable for Simag H 30mm		







1

Part No.	401799	Ref. No.	CM33580150	
description	PCB ice maker N201/N301//N501 230V			
accessories for	401799			
	Part No.	701450	Ref. No.	—
	connection cable L 1300mm 2-pole level sensor suitable for ice maker connection plug plug type coded plug			



			
1			
Part No.	403881	Ref. No.	620462 11 620462 20
description	PCB L 200mm W 135mm		

central units

			
1			
Part No.	402004	Ref. No.	06711.10 620403.09 62040303 620456.02 620462.02
description	control box		
For models:	SP405, SPR80		
accessories for	402004		
	Part No.	Ref. No.	620404.00 62040410
	402005		temperature probe PTC 2kOhm cable TPE probe -50 up to +150°C cable -40 up to +110°C connection plug thread probe ø6x50mm cable length 1.6m
	Part No.	Ref. No.	62040403
	402044		Hall sensor L 29mm W 26mm H 26mm mounting distance 10mm cable length 1250mm
	Part No.	Ref. No.	62040401 62040411 62040418
	402191		temperature probe PTC 2kOhm cable TPE probe -50 up to +150°C cable -40 up to +110°C connection plug thread probe ø5x20mm cable length 1.8m

			
1			
Part No.	401841	Ref. No.	0A037703.21 12002543.21 12002543.24 12002838.21 12002838.22 12002838.23 12002838.24 17002389.01
description	control box for ice-cube maker 24V 50-60Hz		

			
1			
Part No.	403836	Ref. No.	81414543/0 CM81414543/0
description	control box ice maker suitable for ICEMATIC/SCOTSMAN/SIMAG		

			
1			
Part No.	403837	Ref. No.	81400264/0 CM81400264/0
description	control box ice maker suitable for ICEMATIC/SCOTSMAN/SIMAG		

			
1			
Part No.	402042	Ref. No.	001028.09 001028.09R 028640.98 060711.00 620403.01 620403.18 620403.20 620456.00 620462.00 620462.06
description	control box suitable for SFT 012		

			
1			
Part No.	401832	Ref. No.	060711.30 785104.02R
description	control box with housing for ice-cube maker 230V		



solenoid valves

solenoid valves (water)

ELBI



1

Part No.	370431	Ref. No.	CM19865518
-----------------	--------	-----------------	------------

description	solenoid valve single straight 230VAC inlet 3/4" outlet 11.5mm input/min output 2l/min DN10 t.max. 90°C ELBI plastic		
--------------------	--	--	--



1

Part No.	370414	Ref. No.	650105.54 CM19865502 Z1ID003
-----------------	--------	-----------------	------------------------------------

description	solenoid valve single straight 230VAC inlet 3/4" outlet 11.5mm output 2l/min 50/60Hz t.max. 90°C ELBI plastic flow regulating valve outlet white		
--------------------	--	--	--



1

Part No.	370459	Ref. No.	Z1ID003
-----------------	--------	-----------------	---------

description	solenoid valve single straight 230VAC inlet 3/4" outlet 11.5mm output 2l/min DN10 t.max. 90°C ELBI plastic flow regulating valve outlet white		
--------------------	---	--	--



1

Part No.	370421	Ref. No.	Z1CW030
-----------------	--------	-----------------	---------

description	solenoid valve double straight 230VAC inlet 3/4" outlet 11.5mm input 5.5l/min output 1/-l/min DN10 t.max. 90°C ELBI plastic flow regulating valve inlet yellow output A 2l/min flow regulating valve outlet A white		
--------------------	---	--	--

For models:	SD23		
--------------------	------	--	--



1

Part No.	370461	Ref. No.	CM19865509
-----------------	--------	-----------------	------------

description	solenoid valve double straight 230VAC inlet 3/4" outlet 11.5mm input/min output -/4,7l/min DN10 t.max. 90°C ELBI plastic output B 4.7l/min flow regulating valve outlet B grey output A w/t membrane (constantly open)		
--------------------	--	--	--



1

Part No.	370433	Ref. No.	650105.62 650105.70 65010551
-----------------	--------	-----------------	------------------------------------

description	solenoid valve double straight 230VAC inlet 3/4" outlet 11.5mm input/min output 2/2.5l/min DN10 t.max. 90°C ELBI plastic output A 2l/min output B 2.5l/min flow regulating valve outlet A white flow regulating valve outlet B orange		
--------------------	---	--	--

For models:	SD18, SD22, SD23, SD30, SDN25		
--------------------	-------------------------------	--	--

spare parts and accessories

reducers

outlet side



1

Part No.	371261	Ref. No.	650105.20
-----------------	--------	-----------------	-----------

description	reducer ELBI type EATON (INVENSYS) flow rate 1.2l/min pressure range 0 up to 10bar tolerance ±15/25% clear		
--------------------	--	--	--

For models:	SD23, SD30		
--------------------	------------	--	--





1

Part No.	371061	Ref. No.	640022.02
-----------------	--------	-----------------	-----------

description	reducer ELBI type EATON (INVENSYS) flow rate 1.4l/min ø 7.2mm pressure range 0 up to 10bar tolerance ±15/25% clear		
--------------------	--	--	--





			
1			
Part No.	371262	Ref. No.	650105.21
description	reducer ELBI type EATON (INVENSYS) flow rate 2.5l/min pressure range 0 up to 10bar tolerance ±15/25% orange		
For models:	SD23, SD30		

			
1			
Part No.	371263	Ref. No.	650105.22
description	reducer ELBI type EATON (INVENSYS) flow rate 4.7l/min pressure range 0 up to 10bar tolerance ±15/25% grey		

			
1			
Part No.	371295	Ref. No.	640022.01
description	reducer flow rate 0.8l/min ø 7.2mm pressure range 0 up to 10bar tolerance ±15/25% black		

			
1			
Part No.	371062	Ref. No.	640022.00
description	reducer flow rate 1.8l/min		

			
1			
Part No.	371063	Ref. No.	640022.03 640022.04
description	reducer flow rate 2.5l/min ø 7.2mm pressure range 0 up to 10bar tolerance ±15/25% clear		

			
1			
Part No.	371057	Ref. No.	650105.23
description	reducer type EATON (INVENSYS) flow rate 2l/min pressure range 0 up to 10bar tolerance ±15/25% white		

ROBERTSHAW/INVENSYS

medium temperature:	90°C	90°C	60°C
ambient temperature:	60°C	25°C	60°C
duty cycle:	40%	100%	100%

various

			
1			
Part No.	371259	Ref. No.	198655.98 640406.01 CM19865532
description	solenoid valve single angled 230VAC inlet 11.5 outlet 11.5mm DN7 plastic		

RPE

special outlet

			
1			
Part No.	370453	Ref. No.	060564.00 620460.00 620460.01 CM19865598
description	solenoid valve single angled 230VAC inlet 11.5mm outlet 11.5mm RPE		

TP



















			
1			
Part No.	370015	Ref. No.	620213.00
description	solenoid valve single angled 230VAC inlet 3/4" outlet 11.5mm DN10 TP		
accessories for	370015		
	Part No.	371220	Ref. No. —
	reducer TP flow rate 3l/min red tolerance ±15%		

Table continues overleaf



accessories for		370015		
Part No.		371221	Ref. No.	—
	reducer TP flow rate 5.5l/min yellow tolerance ±15%			
	reducer TP flow rate 6l/min grey tolerance ±15%			
	reducer TP flow rate 10l/min white tolerance ±15%			
	reducer TP flow rate 12l/min bronze tolerance ±15%			
	reducer TP flow rate 16l/min light brown tolerance ±15%			
	reducer TP flow rate 20l/min red tolerance ±15%			
	reducer TP flow rate 0.25l/min red tolerance ±25%			
	reducer TP flow rate 0.35l/min violet tolerance ±25%			
	reducer TP flow rate 0.5l/min orange tolerance ±25%			
	reducer TP flow rate 0.8l/min white tolerance ±25%			
	reducer TP flow rate 1l/min light blue tolerance ±25%			
	reducer TP flow rate 1.2l/min brown tolerance ±25%			
	reducer TP flow rate 1.5l/min light brown tolerance ±25%			
	reducer TP flow rate 2.5l/min yellow tolerance ±25%			
	reducer TP flow rate 3.4l/min dark green tolerance ±25%			
	reducer TP flow rate 5l/min black tolerance ±25%			
	reducer TP flow rate 8l/min blue tolerance ±20%			

solenoid valves with reducers



1

Part No.	370452	Ref. No.	481928128177 481928128226
description	solenoid valve double angled 230VAC inlet 3/4" input 5.5l/min t.max. 90°C TP plastic flow regulating valve inlet yellow outlet 11.5mm output A 1.5l/min output B 1.5l/min flow regulating valve outlet A light brown flow regulating valve outlet B light brown		



1

Part No.	370416	Ref. No.	CM19865530
description	solenoid valve double straight 230VAC inlet 3/4" input/min output 1.2/1.2l/min DN10 t.max. 90°C TP plastic outlet 11.5mm output A 1.2l/min output B 1.2l/min flow regulating valve outlet A dark brown flow regulating valve outlet B dark brown		



1

Part No.	370422	Ref. No.	65010570
description	solenoid valve double straight 230VAC inlet 3/4" t.max. 90°C TP plastic outlet 11.5mm output A 2.5l/min flow regulating valve outlet A yellow flow regulating valve outlet B brown		

various







1

Part No.	370496	Ref. No.	CM19865525
description	solenoid valve straight 220VAC outlet 14mm plastic inlet 14mm		



metal			
PARKER			
spare parts and accessories			
solenoid coils			
			
1			
Part No.	371098	Ref. No.	62030628 62030648 63030628.01
description	solenoid coil 220-230VAC 50/60Hz seat ø 14mm cable length 1000mm 14W		
For models:	SD18, SD22, SD23, SD30, SDN25		

accessories for	370382		
	Part No.	371090	Ref. No. —
	power socket plug type DIN 43650A screw		
	Part No.	371301	Ref. No. —
	solenoid coil CASTEL 110VAC 8VA 50/60Hz seat ø 11.5mm connection DIN 43650A type HF2		
	Part No.	371314	Ref. No. —
	solenoid coil CASTEL 240VAC 8VA 50/60Hz seat ø 11.5mm		
	Part No.	371321	Ref. No. —
	solenoid coil CASTEL 12/24VAC 50/60Hz seat ø 11.5mm connection DIN 43650A type HF2		

drain valves



			
1			
Part No.	371106	Ref. No.	11000514.30 1100514.01
description	drain solenoid valve 208/230V single inlet 17.5mm outlet 16mm EATON (INVENSYS) plastic		

			
1			
Part No.	370691	Ref. No.	CM81454760
description	solenoid valve angled 220-240V kit inlet 17.5mm outlet 16mm		

solenoid valves (refrigeration)

CASTEL			
valve bodies			
STANDARD series			



suitable for refrigerants R22, R134a, R404A, R407C, R410A, R507

			
1			
Part No.	370382	Ref. No.	CM19863034
description	solenoid valve body NC type 1028/M10S p max 45bar connection 10mm soldering connection DN 3mm -35 up to +105°C L 125mm refrigeration straight CASTEL		
accessories for	370382		
	Part No.	371084	Ref. No. —
	solenoid coil CASTEL 230VAC 8VA 50/60Hz connection cable 1000mm type CM2		

PARKER valves

			
1			
Part No.	370415	Ref. No.	CM19863032 CM19863033
description	solenoid valve straight 230V pressure range 0-10bar DN2.5 connection 4mm soldering connection PARKER refrigeration		
accessories for	370415		
	Part No.	371033	Ref. No. —
	solenoid coil PARKER 230VAC 9VA coil type YB09 with cable seat ø 14mm		

valve bodies

			
1			
Part No.	370536	Ref. No.	620306.07
description	solenoid valve body p max 35bar connection 3/8" US PARKER for ice maker tube ø 10mm hot gas		
accessories for	370536		
	Part No.	371098	Ref. No. 62030628 62030648 63030628.01
	solenoid coil 220-230VAC 50/60Hz seat ø 14mm cable length 1000mm 14W		



various

valves

1

Part No.	370425	Ref. No.	Z1FR047
description	solenoid valve angled DN1.9 connection 6mm 230V		

valve bodies

1

Part No.	370429	Ref. No.	62030627
description	solenoid valve body angled DN 2.5mm connection 6mm soldering connection refrigeration		
accessories for	370429		
	Part No.	371098	Ref. No.
			62030628 62030648 63030628.01
	solenoid coil 220-230VAC 50/60Hz seat ø 14mm cable length 1000mm 14W		

1

Part No.	370458	Ref. No.	62030614
description	solenoid valve body connection 6mm soldering connection refrigeration angled 90°		
For models:	SD22, SD23, SD30, SDN25		

1

Part No.	370424	Ref. No.	62030622
description	solenoid valve body DN 1.9mm connection 6mm soldering connection refrigeration angled 90°		
For models:	SD23, SD30		



1

Part No.	370454	Ref. No.	620306.46
description	solenoid valve body DN 3mm connection 6mm soldering connection refrigeration angled 90°		
accessories for	370454		
	Part No.	371033	Ref. No.
			—
	solenoid coil PARKER 230VAC 9VA coil type YB09 with cable seat ø 14mm		

pressure switches

for refrigeration

SAGI NO MIYA

1

Part No.	539002	Ref. No.	620075.02
description	pressure control switch pressure 16bar reset automatic type HTB-3UA12 connection 2.4mm		

JOHNSON CONTROLS

1

Part No.	541116	Ref. No.	62007500 62007505 62049901 Z1EL005
description	pressure control HD switch pressure 10bar reset automatic switching diff. 1.1bar pressure range 7-29bar p max 38bar refrigeration type P20EA-9950C connection soldering connection 6.35mm CO JOHNSON CONTROLS pressure connection soldering connection 6.35mm		
For models:	SD18, SD22, SD23, SD30, SDN25		

1

Part No.	541117	Ref. No.	620231.00 620231.01
description	pressure control HD switch pressure 24bar reset manual switching diff. 4.7bar pressure range 7-29bar p max 38bar refrigeration type P20GA-9950T connection male faston 6.3mm CO JOHNSON CONTROLS pressure connection soldering connection 6.35mm		



compressors

ACC/ZEL

R134A

HMBP monophase

High/Medium evaporation temperature above -20/-15 °C



1

Part No.	605012	Ref. No.	670100.02 670105.07 CM19165497
description	compressor coolant R134a type GL45TB 220-240V 50Hz HMBP fully hermetic 8.4kg 1/6HP power input 342W cylinder capacity 4.5cm ³ CSIR H 175.5mmW 76W 101W 134W 175W 223W 278W 342W 413W test method ASHRAE ambient temperature max. 43°C		
For models:	SD18		

L'UNITE HERMETIQUE / TECUMSEH

R404A

LBP 3-phase

Lower evaporation temperature below -20°C



1

Part No.	605187	Ref. No.	670099.15
description	compressor coolant R404A type TAJ2464Z 400V 50/60Hz LBP 22.5kg 1.5HP cylinder capacity 34.4cm ³ TRI H 282mm 1108W 1579W 1850W 2317W 2855W test method EN 12900		

HMBP monophase

High/Medium evaporation temperature above -20/-15 °C



1

Part No.	605065	Ref. No.	670099.05
description	compressor coolant R404A type CAJ4519Z 220-240V 50Hz HMBP 24kg 1.5HP cylinder capacity 34.4cm ³ CSR H 282mmWWW 1769W 2353W 3009W 3756W 4360W 5200W		
For models:	SP405		

fans

refrigeration fans





refrigeration motors universal

ELCO

N series - multi fit







1

Part No.	601427	Ref. No.	62041902
description	fan motor ELCO 10W 230V 50/60Hz bearing slide bearing L1 49mm L2 59mm L3 86.5mm W 83mm connection cable 500mm 1300/1550rpm 5 mounting options VNT10-20/028		
For models:	SD18, SD22, SD23, SD30, SDN25, SPR80		
spare parts for	601427		
	Part No.	560140	Ref. No. —
	hexagonal nut thread M4 H 4.8mm SS WS 7 Qty 20 pcs DIN/ISO DIN 985 self-locking		
	Part No.	560332	Ref. No. —
	plain washer ID ø 4.3mm ED ø 9mm thickness 0.8mm SS Qty 1 pcs		
	Part No.	560340	Ref. No. —
	hexagonal nut thread M4 H 3.2mm WS 7 SS DIN/ISO DIN 934 / ISO 4032/8673 Qty 1 pcs		
	Part No.	601413	Ref. No. —
	fixing plate suitable for fanwheel ED ø 32mm shaft ø 7 mounting distance 26mm		



1

Part No.	601430	Ref. No.	620419.00 CS1761101602
description	fan motor ELCO 5W 230V 50/60Hz bearing slide bearing L1 48mm L2 52mm L3 79.5mm W 83mm connection cable 500mm 1300/1550rpm 5 mounting options VNT5-13/027		
spare parts for	601430		
	Part No.	560140	Ref. No. —
	hexagonal nut thread M4 H 4.8mm SS WS 7 Qty 20 pcs DIN/ISO DIN 985 self-locking		
	Part No.	560332	Ref. No. —
	plain washer ID \varnothing 4.3mm ED \varnothing 9mm thickness 0.8mm SS Qty 1 pcs		
	Part No.	560340	Ref. No. —
	hexagonal nut thread M4 H 3.2mm WS 7 SS DIN/ISO DIN 934 / ISO 4032/8673 Qty 1 pcs		
	Part No.	601413	Ref. No. —
	fixing plate suitable for fanwheel ED \varnothing 32mm shaft \varnothing 7 mounting distance 26mm		

IMPORT

multi fit fan motors



1

Part No.	601023	Ref. No.	620233.00 620419.04
description	fan motor 16W 230V 50-60Hz L1 45mm L2 61mm L3 92mm W 84mm cable length 500mm 1300rpm YZF16-25-18/26 5 mounting options bearing slide bearing		
For models:	SP405		

miscellaneous



1

Part No.	601431	Ref. No.	60413.00 620300.06 620419.06 620419.07
description	fan motor 35W 230V		
For models:	SP405		



1

Part No.	601524	Ref. No.	CM18562524
description	fan motor 35W 230V 50/60Hz L3 153mm W 83mm cable length 1600mm 1300rpm with capacitor capacitor 2.5 μ F		

accessories

fan wheels

aluminium

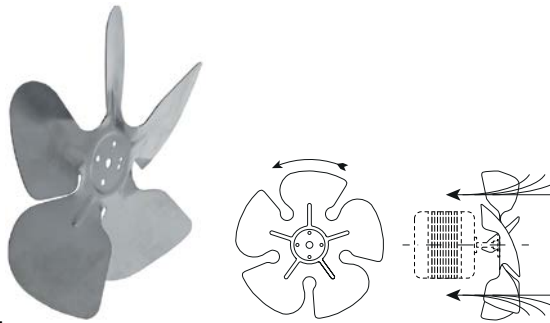

1

Part No.	601070	Ref. No.	620007.05 620419.31
description	fan wheel sucking \varnothing 200mm fan wheel mounting 25.4mm blade angle 28° W 38mm aluminium		



1

Part No.	601282	Ref. No.	62041932
description	fan wheel sucking ø 200mm fan wheel mounting 25.4mm blade angle 34° W 44mm aluminium		
For models:	SD22, SD23, SD30, SDN25, SPR80		

1

Part No.	601387	Ref. No.	620419.34
description	fan wheel sucking ø 254mm fan wheel mounting 25.4mm blade angle 34° W 50mm aluminium		
For models:	SP405		

1

Part No.	601071	Ref. No.	62041931
description	fan wheel sucking ø 230mm fan wheel mounting 25.4mm blade angle 25° W 37mm aluminium		

1

Part No.	601410	Ref. No.	6200000.03 620419.36
description	fan wheel sucking ø 300mm fan wheel mounting 25.4mm blade angle 28° W 45mm aluminium		

1

Part No.	601283	Ref. No.	620419.33
description	fan wheel sucking ø 230mm fan wheel mounting 25.4mm blade angle 28° W 41mm aluminium		

cooling motors (complete)

1

Part No.	500674	Ref. No.	Z1FR009
description	fan		
For models:	SD23		



cold air circulating fans (other)



1

Part No.	601554	Ref. No.	620273.00 620273.03 620490.00
description	fan motor 230V 50-60Hz 100W W 105mm H 105mm D 220mm shaft L 80mm shaft \varnothing 12mm EURO MOTORS type 10111-40100 cable length 1500mm 1100rpm		

motors

gear motors

for ice-cube maker

for paddles



1

Part No.	501472	Ref. No.	IOM916103101
description	gear motor CROUZET type SP-1905-40 3W 230V 50-60Hz 2rpm shaft \varnothing 5x4mm groove width 17mm shaft \varnothing 4.7mm icemaker		



1

Part No.	500407	Ref. No.	CM19440059
description	gear motor LIP type 123MR 8W 220/240V voltage AC 50/60Hz 50rpm turn direction counterclockwise shaft \varnothing 4mm shaft intake \varnothing 6.2mm groove width 2.3mm shaft L 8mm shaft \varnothing 4mm W 74mm		

for sumps



1

Part No.	500410	Ref. No.	CM19440065
description	float motor LIP 11W 230V 50Hz 0.7rpm shaft \varnothing 7mm shaft length 20mm W 72mm H 110mm O10		



1

Part No.	500786	Ref. No.	CM81404024
description	float motor LIP 11W 230V 50Hz 1rpm shaft \varnothing 8mm W 100mm H 90mm for ice maker L 130mm		
spare parts for	500786		
	Part No.	695670	Ref. No. CM25260000
	disc for pan tilting \varnothing 100mm shaft intake \varnothing 7mm		



1

Part No.	500409	Ref. No.	CM19440063
description	float motor LIP type 001 11W 220/240V voltage 50/60 0.7rpm shaft \varnothing 7mm shaft length 20mm W 71mm H 62mm L 110mm		



1

Part No.	500411	Ref. No.	CM19440057
description	gear motor BITRON type 97103 11W 230V 50Hz 0.7rpm shaft \varnothing 7mm shaft length 30mm W 72mm H 60mm L 116mm		

1

Part No.	500412	Ref. No.	CM19440073
description	gear motor LIP type 021B 11W 230V 50Hz 1rpm shaft ø 7mm shaft length 20mm W 74mm D 67mm H 110mm for sump		



1

Part No.	500752	Ref. No.	62043002
description	pump GRE 60W 230V 60Hz inlet ø 16mm outlet ø 21mm L 110mm rotation direction right for ice maker		

miscellaneous



1

Part No.	499077	Ref. No.	79422513R
description	gear motor type 794225 220V voltage AC 50/60Hz shaft ø 22.2mm L 260mm W 150mm H 245mm for ice maker 120W		
For models:	SPR80		



1

Part No.	500045	Ref. No.	060491.03 301001 62041500 Z11D009 Z11D039
description	pump GRE type 100W 230V 50Hz inlet ø 24mm outlet ø 21mm L 150mm rotation direction left for ice-cube maker total length 230mm		
For models:	SD23		
spare parts for	500045		
	Part No.	532082	Ref. No. —
	O-ring EPDM thickness 2.62mm ID ø 61.6mm Qty 10 pcs		
accessories for	500045		
	Part No.	695417	Ref. No. Z11D043
	insulation for pump		

pumps

pumps for ice machines



1

Part No.	695417	Ref. No.	Z11D043
description	insulation for pump		
For models:	SD23		



1

Part No.	501470	Ref. No.	620423.00
description	pump GRE type 100W 230V 50Hz outlet ø 13mm L 137mm rotation direction left icemaker		



1

Part No.	500200	Ref. No.	Z11D005
description	pump GRE 100W 230V 50Hz inlet ø 24mm outlet ø 23mm L 145mm rotation direction right		

1

Part No.	500597	Ref. No.	62043003
description	pump GRE type MH50F 60W 230V 50Hz outlet ø 21mm L 110mm rotation direction right for ice maker		



1

Part No.	500772	Ref. No.	12002586.25
description	pump HARTELL type U21B 230V 50/60Hz outlet ø 19mm L 120mm rotation direction right for ice-cube maker 1/30HP		



1

Part No.	500047	Ref. No.	62043300 793113.00 793113.27
description	pump REBO type MH30F1 30W 230V 50Hz outlet ø 12.7mm L 135mm rotation direction left		
For models:	SD18, SD22, SD23, SD30, SDN25		



1

Part No.	500761	Ref. No.	620433.02 620433.07 793113.09
description	pump REBO type MH30F1 30W 230V 50Hz outlet ø 13mm L 135mm rotation direction right for ice maker		



1

Part No.	501471	Ref. No.	793113.24R
description	pump REBO type MH50F 60W 220-240V 50Hz outlet ø 18.5mm L 136mm rotation direction left icemaker		



1

Part No.	500204	Ref. No.	67000206
description	pump REBO type MH50F 60W 230V 50Hz inlet ø 19mm outlet ø 19mm L 125mm rotation direction right for ice-cube maker		



1

Part No.	500048	Ref. No.	793113.03 793113.03R
description	pump REBO type MH50F 60W 230V 50Hz outlet ø 18mm L 137mm rotation direction right for ice maker		



1

Part No.	500746	Ref. No.	620430.06
description	pump REBO type MH50F 60W 230V 50Hz outlet ø 20mm L 110mm rotation direction right for ice-cube maker		



1

Part No.	500203	Ref. No.	060523.00 620430.00 670002.12 793146.00
description	pump REBO type MH50F 60W 230V 50Hz outlet ø 21mm L 110mm rotation direction right for ice maker		



			
1			
Part No.	500046	Ref. No.	0A030625.02 670036.06
description	pump REBO type NR40 40W 230V 50Hz inlet ø 12mm outlet ø 12mm L 75mm rotation direction right for ice-cube maker		

condensators & interference suppression filters

operating capacitors

plastic			
			
1			
Part No.	365018	Ref. No.	620167.24 620167.54
description	operating capacitor capacity 35µF 400V tolerance 5%Hz ambient temperature max. -25 to +85°C ø 45mm L 95mm M8 plastic connection male faston 6.3mm protection		
For models:	SP405		

			
1			
Part No.	365031	Ref. No.	62029204
description	operating capacitor capacity 4µF 450V tolerance 5% 50/60Hz ambient temperature max. -25 to +85°C ø 31mm L 58mm M8 plastic connection male faston 6.3mm protection		
For models:	SPR80		

equipment-specific units

for ice-cube maker

drain systems

drain fittings

			
1			
Part No.	696583	Ref. No.	CM 25685311
description	drain fitting ø 50mm thread 3/4 hose ø 21mm L 55mm straight for ice-cube maker		

filters			
			
1			
Part No.	695769	Ref. No.	02002809.01 660211.01
description	drain filter thread 7/8" ø 32mm H 10mm		
For models:	SD18, SD23, SD30, SDN25, SPR80		

overflow pipes			
			
1			
Part No.	696609	Ref. No.	66060100
description	overflow pipe for ice maker tube ø 20mm pipe length 24mm ED ø 24.5mm L 109mm		

			
1			
Part No.	695047	Ref. No.	660219.01
description	overflow pipe L 78mm straight		
For models:	SD18, SD22, SD23, SD30, SPR80		

ice breakers			
			
1			
Part No.	696436	Ref. No.	060293.02 060720.00 670041.00 754001.01 754001.02
description	ice breaker ID ø 26mm ED ø 51mm H 59mm brass with ball bearing		
For models:	SPR80		

ice chutes			
			
1			
Part No.	695595	Ref. No.	CM25250099
description	ice chute for door L 345mm W 205mm white		



slide grates

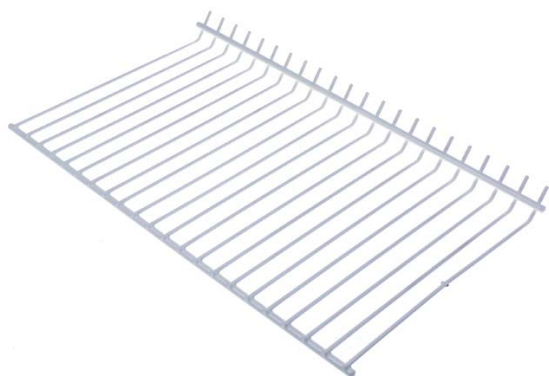

1

Part No.	694273	Ref. No.	Z1AC003
description	slide grate for ice maker L 395mm W 235mm H 30mm		



1

Part No.	694145	Ref. No.	65070500 Z1AC050
description	slide grate for ice-cube maker L 250mm W 170mm H 25mm		
For models:	SD18, SD22, SD23, SDN25		

ice scoops



1

Part No.	695244	Ref. No.	650146.00 65092300
description	ice scoop L 220mm W 114mm H 55mm		

spare parts and accessories



1

Part No.	695020	Ref. No.	CM25654016
description	disc for pan tilting		

probes



1

Part No.	694715	Ref. No.	12002760.21 IOM1011380.78
description	level electrode for ice-cube maker 1-pole cable length 100mm		



1

Part No.	401764	Ref. No.	CM81453007 CM81453114 CM81453434
description	probe for ice thickness		



1

Part No.	694714	Ref. No.	02003409.21 0S37728.21 11000540.21
description	probe for water level 2-pole		



1

Part No.	401837	Ref. No.	CM81453590 CM81453796
description	probe for water level 2-pole cable length 85mm		

spray systems

SIMAG

spray arms



1

Part No.	695480	Ref. No.	65066503
description	spray arm for ice maker		



			
1			
Part No.	695418	Ref. No.	4114654 65066518 Z1ZA043
description	spray arm L 242mm nozzles 6 for ice maker		
For models:	SD18, SD22, SD23		

			
1			
Part No.	695463	Ref. No.	65066501
description	spray arm L 242mm nozzles 6 for ice maker		

			
1			
Part No.	695850	Ref. No.	69573900
description	spray arm L 367mm nozzles 4 for ice maker		

			
1			
Part No.	695420	Ref. No.	65056520 Z1ZA045
description	spray arm L 385mm nozzles 10 for ice maker		

			
1			
Part No.	695422	Ref. No.	65066504 Z1ZA051
description	spray arm L 385mm nozzles 10 for ice maker		



			
1			
Part No.	695419	Ref. No.	65066502 Z1A044
description	spray arm L 385mm nozzles 8 for ice maker		

			
1			
Part No.	695421	Ref. No.	65066505 Z1ZA048
description	spray arm L 385mm nozzles 8 for ice maker		

			
1			
Part No.	695477	Ref. No.	65066523
description	spray arm L 420mm nozzles 8 for ice maker		

			
1			
Part No.	695478	Ref. No.	65066524
description	spray arm L 420mm nozzles 8 for ice maker		

			
1			
Part No.	695065	Ref. No.	793127.00
description	spray arm L 435mm nozzles 4 for ice maker		

			
1			
Part No.	695424	Ref. No.	65066506 Z1ZA049
description	spray arm L 570mm nozzles 12 for ice maker		
accessories for	695424		
	Part No.	695000	Ref. No.
			660558.00 Z1ID026
	nozzle for ice-cube maker		

			
1			
Part No.	695423	Ref. No.	65066508 Z1ZA046
description	spray arm L 570mm nozzles 15 for ice maker		

spray units

			
1			
Part No.	695442	Ref. No.	793129.05
description	spray system L 273mm W 147mm nozzles 6 complete for ice maker		

			
1			
Part No.	695443	Ref. No.	793129.04
description	spray system L 273mm W 180mm nozzles 6 complete for ice maker		
spare parts for	695443		
	Part No.	695063	Ref. No.
			—
	nozzle cap set 3-piece L 111mm W 30mm H 12mm		

1 mechanical components, equipment accessories





			
1			
Part No.	695444	Ref. No.	793117.00 793129.01
description	spray system L 285mm W 210mm nozzles 6 complete for ice maker		

accessories			
			
1			
Part No.	695068	Ref. No.	11D010 66055700
description	end cap for ice maker insertion size 13x13mm		
For models:	SD18, SD22, SD23, SD30, SD40, SDN25		

			
1			
Part No.	695060	Ref. No.	660155.03
description	nozzle for ice maker thread 3/8" ø 19.5mm H 13mm		

			
1			
Part No.	695000	Ref. No.	660558.00 Z11D026
description	nozzle for ice-cube maker		
For models:	SD18, SD22, SD23, SD30, SDN25		

			
1			
Part No.	695115	Ref. No.	060529.00 060529.01 660519.01 660519.02 660519.03
description	nozzle cap set for ice maker 3-piece L 110mm W 30mm H 12mm		

			
1			
Part No.	695066	Ref. No.	660475.00
description	spray arm holder for ice maker H 150mm shaft ø 15mm		

			
1			
Part No.	695061	Ref. No.	660296.02
description	swirl ice cube maker plastic ø 15mm Lmm Wmm H 3.4mm shaft ømm black		

doors			
bushes			
			
1			
Part No.	695782	Ref. No.	660286.00
description	bush for door ED ø 12.5mm ID ø 8.2mm L 10.8mm plastic		

doors			
			
1			
Part No.	695743	Ref. No.	CM81460184 CM81460326
description	door for ice maker W 1080mm H 275mm thickness 16mm		

			
1			
Part No.	695458	Ref. No.	782078.00R
description	door for ice-cube maker W 345mm H 195mm thickness 14mm		

			
1			
Part No.	695459	Ref. No.	782079.05R 782079.06
description	door for ice-cube maker W 420mm H 200mm thickness 18mm		

			
1			
Part No.	695457	Ref. No.	781503.00R 792011.02R 79201101
description	door for ice-cube maker W 505mm H 270mm thickness 21mm		





1

Part No.	695461	Ref. No.	060517.04 060517.05
description	door kit for ice-cube maker W 655mm H 260mm thickness 19mm		



1

Part No.	696473	Ref. No.	782009.07 792009.09R
description	door W 600mm H 260mm thickness 17mm		



1

Part No.	695460	Ref. No.	060517.00 060517.01
description	door with door guide for ice-cube maker W 485mm H 260mm thickness 19mm		

door guides



1

Part No.	695448	Ref. No.	660523.01
description	door guides mounting pos. left L 215/240mm W 14mm		



1

Part No.	695447	Ref. No.	660523.00
description	door guides mounting pos. right L 215/240mm W 14mm		

curtains

without holder



1

Part No.	695726	Ref. No.	CM81401600
description	curtain for ice maker W 250mm H 70mm shaft length 270mm shaft ø 6mm		



1

Part No.	695429	Ref. No.	78317100R
description	curtain for ice maker W 250mm H 70mm shaft length 280mm shaft ø 6mm		
For models:	SD18, SD22, SDN25		



1

Part No.	695076	Ref. No.	784169.09 78416909R
description	curtain for ice maker W 284mm H 83mm		



1

Part No.	695438	Ref. No.	78445700R
description	curtain for ice maker W 293mm H 115mm shaft length 350mm shaft ø 6mm		



1

Part No.	695075	Ref. No.	784169.01 784169.01R
description	curtain for ice maker W 305mm H 115mm shaft length 323mm shaft ø 6mm		



			
1			
Part No.	695077	Ref. No.	784169.05 784250.03 784250.03R
description	curtain for ice maker W 570mm H 115mm shaft length 610mm shaft ø 6mm		

accessories

holders

			
1			
Part No.	695080	Ref. No.	66038800
description	curtain holder for ice maker W 15mm H 80mm left		
For models:	SD18, SD22, SD23, SD30, SDN25		

			
1			
Part No.	695079	Ref. No.	66038801
description	curtain holder for ice maker W 15mm H 80mm right		
For models:	SD18, SD22, SD23, SD30, SDN25		

lamellas

			
1			
Part No.	695081	Ref. No.	66062900 Z1AC027
description	lamella for ice maker W 28mm H 71mm ø 6mm		
For models:	SD23		

pan mechanics

sumps

			
1			
Part No.	695014	Ref. No.	CM81403005
description	sump complete for ice maker L 180mm W 125mm H 80mm shaft L 205mm N20 blue		

			
1			
Part No.	696414	Ref. No.	CM81401621
description	sump complete for ice maker L 180mm W 125mm H 80mm shaft L 210mm N25 blue		

			
1			
Part No.	695015	Ref. No.	CM81403007
description	sump complete for ice maker L 225mm W 165mm H 80mm shaft L 255mm for modell N30/N35 white		

			
1			
Part No.	695017	Ref. No.	CM81413001
description	sump complete for ice maker L 275mm W 220mm H 75mm ICEMATIC white		

			
1			
Part No.	695016	Ref. No.	CM81414519 CM81423003
description	sump complete for ice maker L 275mm W 220mm white		

			
1			
Part No.	695019	Ref. No.	CM81442008
description	sump complete for ice maker L 690mm W 230mm H 65mm ICEMATIC		

			
1			
Part No.	695018	Ref. No.	CM81423002
description	sump complete L 455mm W 180mm H 60mm ICEMATIC		





			
1			
Part No.	695662	Ref. No.	CM25820125
description	water container for ice maker L 697mm W 260mm H 148mm white		

spare parts and accessories

			
1			
Part No.	695646	Ref. No.	CM25726279
description	bracket for inner door L 44mm W 20mm H 18mm shaft intake ø 6.3mm mounting distance 30mm		

			
1			
Part No.	695651	Ref. No.	CM25525419
description	bracket for pulser L 34mm W 15mm H 60mm		

			
1			
Part No.	695415	Ref. No.	CM25726122
description	bracket for sump mounting pos. right ICEMATIC		

			
1			
Part No.	695009	Ref. No.	CM25726115
description	bracket paddle L 50mm W 17mm H 23mm shaft intake ø 6.5mm mounting distance 30mm		

			
1			
Part No.	695681	Ref. No.	CM25110914
description	bush for spindle ED ø 10mm ID ø 6.2mm L 20mm plastic ICEMATIC		

			
1			
Part No.	695670	Ref. No.	CM25260000
description	disc for pan tilting ø 100mm shaft intake ø 7mm		

			
1			
Part No.	695479	Ref. No.	CM81413043
description	disc for pan tilting ø 100mm shaft ø 7mm		

			
1			
Part No.	695023	Ref. No.	CM25325953
description	guide for lever L 30mm W 12mm H 15mm		

			
1			
Part No.	695025	Ref. No.	CM25440110 CM81403011
description	lever for sump L 143mm W 29mm H 37mm shaft intake ø 10mm plastic ICEMATIC		

			
1			
Part No.	695027	Ref. No.	CM25545520
description	paddle ø 145mm shaft intake ø 6mm		

			
1			
Part No.	696527	Ref. No.	CM25545521
description	paddle ø 145mm shaft intake ø 6mm shaft lengthmm 1		

			
1			
Part No.	695026	Ref. No.	CM25560256
description	pin for lever L 38mm ø 4.5mm metal		

			
1			
Part No.	695024	Ref. No.	CM25110911
description	roller for pan tilting ø 26.7mm shaft intake ø 8.1mm		

			
1			
Part No.	695035	Ref. No.	CM25725433 CM25725439
description	shaft intake for paddle motor L 30mm W 17mm H 60mm shaft intake ø 4mm mounting distance 17mm		



1

Part No.	695004	Ref. No.	CM25030006
description	spindle for ice maker ø 6mm L 165mm SS		

1

Part No.	695005	Ref. No.	CM25030007
description	spindle for ice maker ø 6mm L 206mm		

1

Part No.	695006	Ref. No.	CM25030010
description	spindle for ice maker ø 6mm L 315mm SS		

1

Part No.	695007	Ref. No.	CM25030011
description	spindle for paddle L 495mm		

1

Part No.	695021	Ref. No.	cm25474600
description	torsion spring ø 20.8mm L1 23.2mm L2 37mm wire gauge ø 2.3mm for ice maker		

1

Part No.	695022	Ref. No.	CM25474602
description	torsion spring ø 21.2mm L1 26mm L2 37mm wire gauge ø 2.6mm for ice maker		

gear wheels



1

Part No.	691787	Ref. No.	651157.00
description	gear wheel ø 27/101mm shaft intake ø 13mm teeth 15/94		
For models:	SP405		

suction system

intake filters



1

Part No.	695416	Ref. No.	Z1AC012
description	intake filter ø 36mm H 25mm		
For models:	SD23		

drive technology

gear wheels



1

Part No.	694780	Ref. No.	651158.00
description	gear wheel ø 135mm shaft ø 25mm W 19mm teeth 83		
For models:	SP405		



1

Part No.	695582	Ref. No.	65115600
description	gear wheel teeth 65 tooth width 14.5mm ED ø 74mm H 72mm shaft ø 12.7mm		
For models:	SP405		

gaskets

shaft gaskets



1

Part No.	695589	Ref. No.	0200130021 64004000
description	shaft sealing ED ø 48mm ID ø 25mm H 22mm suitable for augers		
For models:	SPR80		



1

Part No.	695428	Ref. No.	650402.00
description	shaft sealing for auger ED ø 45mm ID ø 30mm		
For models:	SP405		



miscellaneous

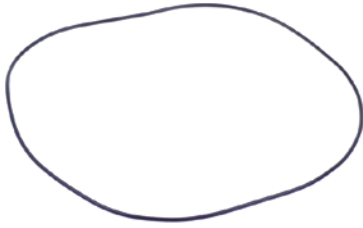

1

Part No.	697879	Ref. No.	0a026103.01 13000617.38
description	O-ring NBR thickness 2.62mm ID ø 219mm Qty 1 pcs		
For models:	SP405		

insulation



1

Part No.	694112	Ref. No.	060551.01 660509.02 660509.03
description	insulation for discharge chute L 190mm W 200mm H 175mm		

flaps



1

Part No.	696392	Ref. No.	CM81453130
description	flap for ice maker W 493mm L 423mm for evaporator		



1

Part No.	696610	Ref. No.	CM81453131
description	sump for ice maker W 500mm H 70mm L 540mm for evaporator		

mechanics for evaporators

holders



1

Part No.	694437	Ref. No.	060527.00 060688.00 754008.01
description	bearing block for evaporator kit with holder mounting pos. lower		
For models:	SP405		

gear motors

gearboxes



1

Part No.	695607	Ref. No.	3212002
description	housing for gearbox		

hoses

formed hoses

form L



1

Part No.	695089	Ref. No.	Z1CE015
description	formed hose L-shape for ice-cube maker ID ø 12.5/22mm ED ø 18.5/27mm L 300mm W 30mm		





			
1			
Part No.	695092	Ref. No.	Z1CE016
description	formed hose L-shape for ice-cube maker ID \varnothing 13/21mm ED \varnothing 18/27mm L 345mm W 80mm		

			
1			
Part No.	695091	Ref. No.	61018901 Z1ID007
description	formed hose L-shape for ice-cube maker ID \varnothing 24mm ED \varnothing 27mm L 130mm W 105mm		

form S

			
1			
Part No.	695090	Ref. No.	Z1ID038
description	formed hose S-shape for ice-cube maker ID \varnothing 16/20mm ED \varnothing 21/25mm L 110mm W 75mm		
For models:	SD23		

			
1			
Part No.	695094	Ref. No.	61021500 Z1ID006
description	formed hose S-shape for ice-cube maker ID \varnothing 16/20mm ED \varnothing 21/26mm L 130mm W 70mm		

			
1			
Part No.	695093	Ref. No.	Z1ID037
description	formed hose S-shape for ice-cube maker ID \varnothing 20/23mm ED \varnothing 26/29mm L 115mm W 90mm		
For models:	SD23		

hose connectors

with thread

			
1			
Part No.	695051	Ref. No.	Z1AC028
description	hose connector		

			
1			
Part No.	695045	Ref. No.	660224.00
description	hose connector 3-way ID \varnothing 15mm ED \varnothing 21mm L 91mm		
For models:	SD18, SD22, SD23, SD30, SP405, SPR80		

			
1			
Part No.	695048	Ref. No.	Z1ID025
description	hose connector for ice-cube maker		
For models:	SD23		

			
1			
Part No.	695049	Ref. No.	Z1AD011
description	hose connector for ice-cube maker		
For models:	SD23		

			
1			
Part No.	695109	Ref. No.	Z1AC030
description	hose connector for ice-cube maker		
For models:	SD23		

			
1			
Part No.	695112	Ref. No.	Z1AC029
description	hose connector for ice-cube maker		
For models:	SD23		

			
1			
Part No.	695053	Ref. No.	66029100
description	hose connector for ice-cube maker straight grommet \varnothing 11.5mm grommet length 16mm WS 27 thread L 15mm plastic T1: 3/4" T2: 5/8" UNF (3/8" SAE)		

			
1			
Part No.	695095	Ref. No.	Z1AC029
description	hose connector thread M22 hose \varnothing 16mm plastic for ice-cube maker ID \varnothing 16mm ED \varnothing 22mm L 45mm		





without thread			
			
1			
Part No.	695050	Ref. No.	CM25690806
description	hose connector straight plastic L 70mm ø 21mm		

miscellaneous			
			
1			
Part No.	520447	Ref. No.	733204.00
description	double nipple thread 3/8" - 3/4" L1 24mm L2 12mm		
For models:	SP405, SPR80		

floats			
container lids			
			
1			
Part No.	695038	Ref. No.	66036300
description	lid L 150mm W 102mm for float container		
For models:	SP405, SPR80		

float containers			
			
1			
Part No.	695037	Ref. No.	793126.01 793126.03
description	float container for ice maker plastic		
For models:	SP405, SPR80		

miscellaneous			
			
1			
Part No.	691665	Ref. No.	CM25726473
description	bracket for evaporator flap		

			
1			
Part No.	695630	Ref. No.	06035900 06035902 65041200
description	coupling set ø 37mm		

			
1			
Part No.	696607	Ref. No.	660483.00
description	flange icemaker H 20mm ED ø 60mm plastic		

			
1			
Part No.	695660	Ref. No.	CM25300000
description	inlet spout for ice maker ICEMATIC		

			
1			
Part No.	695417	Ref. No.	Z11D043
description	insulation for pump		
For models:	SD23		

			
1			
Part No.	695046	Ref. No.	66053500
description	nut H 5mm thread M24x1.5 plastic		
For models:	SD18, SD22, SD23, SD30, SP405, SPR80		

			
1			
Part No.	695113	Ref. No.	Z1AC014
description	plain washer for ice-cube maker plastic D1 ø 32mm D2 ø 25mm thickness 2mm		
For models:	SD23		



1

Part No.	695110	Ref. No.	Z1AC013
description	plain washer for ice-cube maker plastic \varnothing 19mm		
For models:	SD23		



1

Part No.	695764	Ref. No.	72421506
description	probe L 100mm ED \varnothing 4mm thread M3		
For models:	SP405, SPR80		

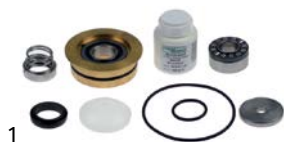

1

Part No.	695587	Ref. No.	001028.08 060692.01
description	repair kit for ice maker		

spare parts for 695587



Part No.	695588	Ref. No.	—
description	bushing complete H 31.5mm ID \varnothing 30mm ED \varnothing 89mm mounting pos. lower		

valves

intake valves



1

Part No.	696608	Ref. No.	IOM9131111.01
description	intake valve icemaker thread 14 plastic hose \varnothing 35mm W 76mm		



1

Part No.	695685	Ref. No.	02002217.02 19864010
description	intake valve thread M11 L 130mm \varnothing 37mm plastic		

for dishwashers

door mechanics

door shafts



1

Part No.	695575	Ref. No.	Z1AM017
description	door shaft \varnothing 10mm L 458mm icemaker		

hinges

piano hinges

producer-specific

CASTEL



1

Part No.	701030	Ref. No.	CM19120045
description	hinge controllable L 43mm W 37mm hole \varnothing 4mm for ice container mounting distance 26/32mm plastic		

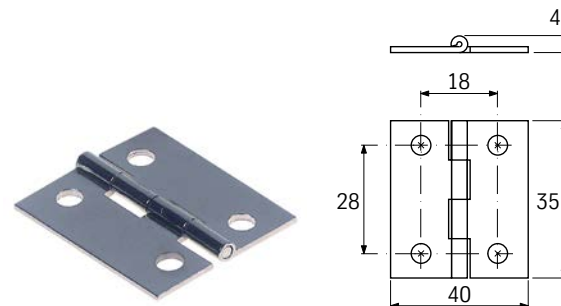

1

Part No.	691804	Ref. No.	CM19120050
description	hinge L 40mm W 35mm H 4mm mounting distance 28mm hole \varnothing 5mm thickness 1.3mm brass ICEMATIC		

filters

air filters



1

Part No.	694183	Ref. No.	02003485.01
description	air filter L 500mm W 500mm H 20mm		



equipment feet and end caps

end caps and plugs

for square pipes

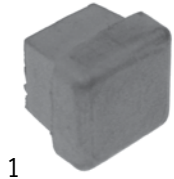

1

Part No.	695068	Ref. No.	1ID010 66055700
description	end cap for ice maker insertion size 13x13mm		
For models:	SD18, SD22, SD23, SD30, SD40, SDN25		

gaskets

refrigeration gaskets

plug-in gaskets

profile 9151

We offer custom-made gaskets for this profile

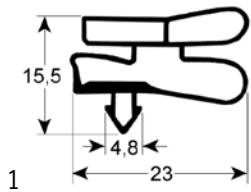

1

Part No.	900368	Ref. No.	CM28175017
description	refrigeration gasket profile 9151 W 715mm L 1580mm plug size L1 1570mm W1 705mm external size		

O-rings

EPDM

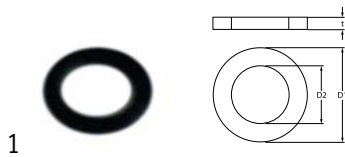

1

Part No.	528485	Ref. No.	640100.00
description	O-ring EPDM thickness 1.78mm ID \varnothing 6.07mm Qty 1 pcs		
For models:	SP405, SPR80		

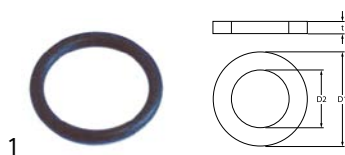

1

Part No.	507309	Ref. No.	640081.00 940081.00
description	O-ring EPDM thickness 2.62mm ID \varnothing 17.13mm Qty 1 pcs		

1

Part No.	510769	Ref. No.	640041.01
description	O-ring EPDM thickness 2.62mm ID \varnothing 25.07mm Qty 1 pcs		
For models:	SPR80		

1

Part No.	532486	Ref. No.	Z1ID042
description	O-ring EPDM thickness 2.62mm ID \varnothing 61.6mm Qty 1 pcs		
For models:	SD23		

1

Part No.	511395	Ref. No.	13000617.54
description	O-ring EPDM thickness 2.62mm ID \varnothing 71.12mm Qty 1 pcs		

1

Part No.	361085	Ref. No.	CM41020448
description	O-ring EPDM thickness 2mm ID \varnothing 8mm Qty 1 pcs		

1

Part No.	511518	Ref. No.	3186143
description	O-ring EPDM thickness 3.53mm ID \varnothing 23.4mm Qty 10 pcs		

1

Part No.	510895	Ref. No.	640093.02
description	O-ring EPDM thickness 3.53mm ID \varnothing 34.52mm Qty 1 pcs		
For models:	SP405		

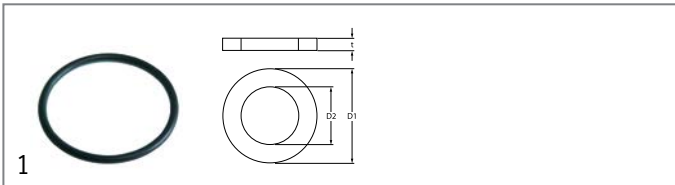
Part No.	532114	Ref. No.	64004138
description	O-ring EPDM thickness 3.53mm ID ø 50.8mm Qty 10 pcs		

silicone

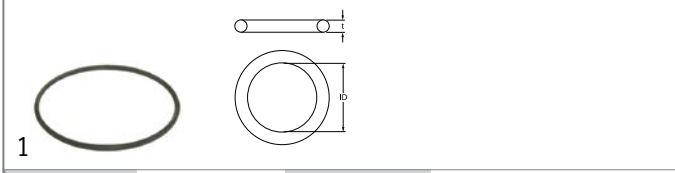

Part No.	695064	Ref. No.	640041.20
description	O-ring silicone thickness 2mm ID ø 66.4mm Qty 1 pcs		

NBR

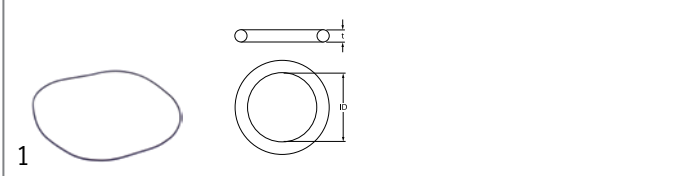

Part No.	697879	Ref. No.	0a026103.01 13000617.38
description	O-ring NBR thickness 2.62mm ID ø 219mm Qty 1 pcs		
For models:	SP405		

sealing washers

rubber gaskets



Part No.	520054 ¹	Ref. No.	640076.13
description	flat gasket rubber ED ø 23.5mm ID ø 14mm thickness 2.3mm Qty 10 pcs		
For models:	SD23		

¹Qty 10 pieces

foam rubber gaskets



Part No.	508418	Ref. No.	CM19350201
description	foam rubber gasket W 15mm thickness 8mm self-adhesive Qty 1m		



Part No.	901292	Ref. No.	13000595.00
description	foam rubber gasket W 15mm thickness 8mm self-adhesive Qty supplied by meter		

shaft gaskets

shaft gaskets

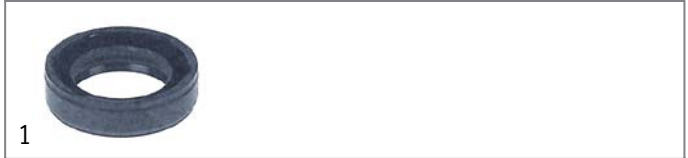

Part No.	698239	Ref. No.	02003969.01 640083.00
description	shaft seal ID ø 11.91mm ED ø 18.24mm thickness 5mm		
For models:	SPR80		



Part No.	511532	Ref. No.	02001606.00
description	shaft seal ID ø 15mm ED ø 25.5mm thickness 6.5mm for ice-cube maker		



Part No.	511534	Ref. No.	64001901
description	shaft seal ID ø 22mm ED ø 32mm thickness 5.5mm		
For models:	SPR80		



Part No.	511533	Ref. No.	02002853.01
description	shaft seal ID ø 25mm ED ø 34mm thickness 5mm for ice maker		



refrigeration cycle components

cooling water regulators

JOHNSON CONTROLS



1

Part No.	541483	Ref. No.	62011100 79305600R CM19865611 Z1CW018
description			
For models:	SP405, SPR80		

valves

expansion valves

DANFOSS

valves

type TS2/TE2



1

Part No.	750014	Ref. No.	CM81453620
description	expansion valve DANFOSS type TS2 coolant R404a/R507 angled 90° thermostatically controlled inlet 3/8" SAE outlet 1/2" SAE p max 34bar -40 up to +10°C capillary pipe 1500mm		
accessories for	750014		
	Part No.	750020	Ref. No. —
	nozzle insert size 0X type 068-2002 T/TE 2 DANFOSS		
	Part No.	750021	Ref. No. —
	nozzle insert size 00 type 068-2003 T/TE 2 DANFOSS		
	Part No.	750022	Ref. No. —
	nozzle insert size 01 type 068-2010 T/TE 2 DANFOSS		
	Part No.	750023	Ref. No. —
	nozzle insert size 02 type 068-2015 T/TE 2 DANFOSS		
	Part No.	750024	Ref. No. —
	nozzle insert size 03 type 068-2006 T/TE 2 DANFOSS		
	Part No.	750483	Ref. No. —
	nozzle insert size 04 type 068-2007 T2/TE2 DANFOSS		
	Part No.	750484	Ref. No. —
	nozzle insert size 05 type 068-2008 T2/TE2 DANFOSS		

accessories for	750014		
	Part No.	750485	Ref. No. —
	nozzle insert size 06 type 068-2009 T2/TE2 DANFOSS		

HONEYWELL

valves



1

Part No.	750445	Ref. No.	62042755
description	expansion valve HONEYWELL type AMVX coolant R404a/R507 nozzle ø 2.5mm inlet 5/8" UNF (3/8" SAE) outlet 3/4" UNF (1/2" SAE) 7/16" UNF (1/4" SAE) p max 3bar capillary pipe 1200mm		

evaporators

for ice-cube maker

for flake ice maker



1

Part No.	695752	Ref. No.	79430201R
description	evaporator for flake ice maker H 247mm ø 73mm		
For models:	SPR80		

accessories

housings

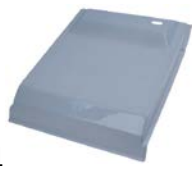

1

Part No.	696383	Ref. No.	CM25820123/0
description	lid for evaporator for ice maker for N120 L 422mm W 336mm H 60mm		

1 mechanical components, equipment accessories



condensers

condensers



1

Part No.	750527	Ref. No.	19177073
description	condenser for ice maker W 525mm D 62mm H 490mm		



1

Part No.	750125	Ref. No.	62043900
description	condenser W 290mm D 85mm H 260mm		

transmission technology and ball bearings

ball bearings

ball bearings inch



1

Part No.	523001	Ref. No.	02000417.00 02000417.20 02000417.21 670011.01
description	ball bearing type SR14-2RS shaft \varnothing 7/8"mm ED \varnothing 1 7/8"mm W 3/8"mm		
For models:	SPR80		

miscellaneous



1

Part No.	523514	Ref. No.	651058.00
description	ball bearing type L/3350 shaft \varnothing 25mm ED \varnothing 52mm W 33mm stainless steel		
For models:	SP405		

springs

torsion springs



1

Part No.	695021	Ref. No.	cm25474600
description	torsion spring \varnothing 20.8mm L1 23.2mm L2 37mm wire gauge \varnothing 2.3mm for ice maker		



1

Part No.	695022	Ref. No.	CM25474602
description	torsion spring \varnothing 21.2mm L1 26mm L2 37mm wire gauge \varnothing 2.6mm for ice maker		



hoses

drain hoses

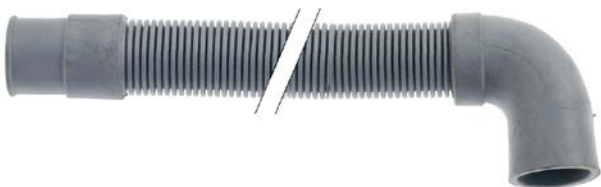

1

Part No.	530473	Ref. No.	06051301 CM19810114
description	drain hose DN19 L 1900mm straight ø inside 19mm straight ext. ø 25mm elbow ø inside 23mm elbow ext. ø 27mm outer hose ø 24mm for ice maker		

fittings, hose and pipe connectors

fittings

double nipples



1

Part No.	520447	Ref. No.	733204.00
description	double nipple thread 3/8" - 3/4" L1 24mm L2 12mm		
For models:	SP405, SPR80		

hose connectors

producer-specific



1

Part No.	695053	Ref. No.	66029100
description	hose connector for ice-cube maker straight grommet ø 11.5mm grommet length 16mm WS 27 thread L 15mm plastic T1: 3/4" T2: 5/8" UNF (3/8" SAE)		



1



Part No.	695050	Ref. No.	CM25690806
description	hose connector straight plastic L 70mm ø 21mm		

push-in fittings

JOHN GUEST



1

Part No.	440652	Ref. No.	651224 04	
description	push-in fitting John Guest straight pipe connection 1/4" - 5/16"			
accessories for	440652			
	Part No.	520976	Ref. No.	—
	hose 0,17" ext. ø 1/4" John Guest LLDPE blue			
	Part No.	520977	Ref. No.	—
	hose ID ø 5mm ED ø 8mm John Guest thickness 1.5mm LLDPE blue			

fastening material

nuts

hexagonal nuts

hexagonal nuts metric (without norm)



1

Part No.	695111	Ref. No.	Z1AC016
description	nut thread M18x1.5 H 7mm WS 27 brass Qty 1 pcs		
For models:	SD23		



1

Part No.	695114	Ref. No.	Z1AC017
description	nut thread M24x1.5 H 7mm WS 30 brass Qty 1 pcs		
For models:	SD23		

washers

washers

miscellaneous



1

Part No.	695113	Ref. No.	Z1AC014
description	plain washer for ice-cube maker plastic D1 ø 32mm D2 ø 25mm thickness 2mm		
For models:	SD23		



1

Part No.	695110	Ref. No.	Z1AC013
description	plain washer for ice-cube maker plastic ø 19mm		
For models:	SD23		

consumables

lubricants

machine lubricants



1

Part No.	890029	Ref. No.	060294.01
description	machine lubricant Mobilux EP004 can 500g for gearbox -25 up to +120°C		
description	<p>Mobilux EP004 - can 500g</p> <p>Suitable for lubricating enclosed gears and bearings in poorly sealed gear cases with the exception of electric motor bearings. Can also be used for many other industrial applications, e.g. gear cases and chains, in which conventional gear oils would escape due to leaks caused by worn or missing seals. Meets requirements of SEW 1008 hour gear test, DR.EM.2003 mod.</p> <p>Temperature resistance: -25°C to +120°C</p>		
For models:	SP405		

cleaning agents

descalers



1

Part No.	802164	Ref. No.	100902
description	descaler 4.8l phosphoric acid for ice maker		

GASTROPARTS.COM

