



GASTROPARTS

Scholl

- [EN]** Equipment
- [DE]** Geräte
- [ES]** Aparatos
- [FR]** Équipement
- [IT]** Attrezzature
- [PL]** Urządzenia
- [RU]** Оборудование

✉ gastroparts@gastroparts.com

☎ +48 56 657 00 66

📘 fb.com/gastroparts.global

GASTROPARTS.COM





heating elements

heating elements for bain maries

Part No.	420290	Ref. No.	71,01,35
description	heating element 1000W 230V heating circuits 1 L 415mm W 198mm connection M4 tube ø 8.5mm 2 hole fixing thread M14x1.5 immersion heater mounting distance 190mm		

Part No.	415635	Ref. No.	71,20,06
description	heating element 1000W 230V heating circuits 1 L 455mm W 210mm connection ø4 tube ø 6.5mm 2 hole fixing thread M14x1.5 dry heating element mounting distance 202mm		
spare parts for	415635		
	Part No.	510417	Ref. No. —
	flat gasket fibre ED ø 20mm ID ø 14mm thickness 2mm Qty 1 pcs		
accessories for	415635		
	Part No.	520228	Ref. No. —
	tooth lock washer ID ø 15.3mm ED ø 24mm steel Qty 1 pcs for thread M14		
	Part No.	520230	Ref. No. —
	nut thread M14x1.5 H 5mm WS 19 zinc-coated steel Qty 1 pcs		
	Part No.	521101	Ref. No. —
	nut thread M14x1.5 H 5mm WS 19 SS Qty 1 pcs		
	Part No.	550262	Ref. No. —
	flat gasket copper ED ø 20mm ID ø 14mm thickness 2mm		
	Part No.	550354	Ref. No. —
	terminal bore ø 4.1mm Qty 10 pcs		

Part No.	415750	Ref. No.	71,20,70
description	heating element 1500W 230V heating circuits 1 L 245mm W 235mm connection plug-in connection 4mm tube ø 6.3mm 2 hole fixing thread M14x1.5 immersion heater H 21mm mounting distance 34mm		
spare parts for	415750		
	Part No.	510417	Ref. No. —
	flat gasket fibre ED ø 20mm ID ø 14mm thickness 2mm Qty 1 pcs		

accessories for 415750





	Part No.	520228	Ref. No.	—
	tooth lock washer ID ø 15.3mm ED ø 24mm steel Qty 1 pcs for thread M14			
	Part No.	520230	Ref. No.	—
	nut thread M14x1.5 H 5mm WS 19 zinc-coated steel Qty 1 pcs			
	Part No.	521101	Ref. No.	—
	nut thread M14x1.5 H 5mm WS 19 SS Qty 1 pcs			
	Part No.	550262	Ref. No.	—
	flat gasket copper ED ø 20mm ID ø 14mm thickness 2mm			
	Part No.	550354	Ref. No.	—
	terminal bore ø 4.1mm Qty 10 pcs			

Part No.	418342	Ref. No.	71,01,71 71,20,23
description	heating element 2000W 230V heating circuits 1 L 207mm W 413mm connection length 25mm connection M4 tube ø 8.7mm 2 hole fixing thread M14x1.5 dry heating element mounting distance 404mm		
accessories for	418342		
	Part No.	510417	Ref. No. —
	flat gasket fibre ED ø 20mm ID ø 14mm thickness 2mm Qty 1 pcs		
	Part No.	520228	Ref. No. —
	tooth lock washer ID ø 15.3mm ED ø 24mm steel Qty 1 pcs for thread M14		
	Part No.	520230	Ref. No. —
	nut thread M14x1.5 H 5mm WS 19 zinc-coated steel Qty 1 pcs		
	Part No.	521101	Ref. No. —
	nut thread M14x1.5 H 5mm WS 19 SS Qty 1 pcs		
	Part No.	550262	Ref. No. —
	flat gasket copper ED ø 20mm ID ø 14mm thickness 2mm		

Part No.	415751	Ref. No.	VZ 12806 71,20,71
description	heating element 2200W 230V heating circuits 1 L 251mm W 245mm connection length 21mm tube ø 6.5mm 2 hole fixing thread M14x1.5 immersion heater H 23mm mounting distance 45.5mm		
accessories for	415751		
	Part No.	510417	Ref. No. —
	flat gasket fibre ED ø 20mm ID ø 14mm thickness 2mm Qty 1 pcs		

Table continues overleaf



accessories for 415751			
	Part No.	520228	Ref. No. —
tooth lock washer ID ø 15.3mm ED ø 24mm steel Qty 1 pcs for thread M14			
	Part No.	520230	Ref. No. —
nut thread M14x1.5 H 5mm WS 19 zinc-coated steel Qty 1 pcs			
	Part No.	521101	Ref. No. —
nut thread M14x1.5 H 5mm WS 19 SS Qty 1 pcs			
	Part No.	550262	Ref. No. —
flat gasket copper ED ø 20mm ID ø 14mm thickness 2mm			

heating elements for hot counters

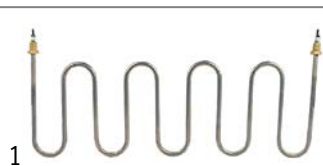

Part No.	418327	Ref. No.	71,01,72 71,20,24
description	heating element 2800W 230V dry heating element hot bar 2 hole fixing		

heating elements for plate warmers



Part No.	418304	Ref. No.	71,20,40
description	heating element 400W 230V 2 hole fixing thread M14x1.25 L 132mm W 126mm H 46mm heating circuits 1 connection male faston 6.3mm L1 110mm L2 22mm immersion heater tube ø 8mm mounting distance 100mm		
accessories for 418304			
	Part No.	521101	Ref. No. —
nut thread M14x1.5 H 5mm WS 19 SS Qty 1 pcs			



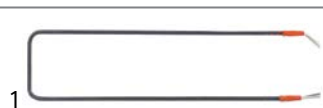

heating elements for heating bridges

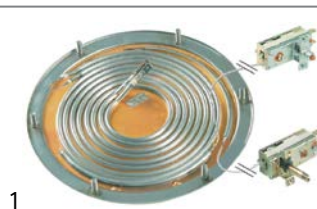

Part No.	418241	Ref. No.	71,01,11 71,20,02
description	heating element 500W 230V heating circuits 1 L 385mm W 105mm tube ø 6.3mm cable length 145mm dry heating element		





bottom heaters



Part No.	418242	Ref. No.	71,01,90 71,30,01
description	bottom heater 1800W 230V heating circuits 2 ø 196mm safety thermostat 250°C thermostat 117°C M5 mounting distance 180mm		
spare parts for 418242			
	Part No.	375792	Ref. No. —
thermostat t.max. 117°C temperature range 30-117°C 1-pole 1NO 16A probe ø 3.03mm probe L 178mm capillary pipe 990mm capillary pipe isolatedmm gland nut shaft ø 6x4.6mm shaft L 23mm shaft position rotation 270° probe material SS with curved probe			
	Part No.	375793	Ref. No. —
safety thermostat switch-off temp. 250°C 1-pole 16A probe ø 3.03mm probe L 160mm capillary pipe 990mm capillary pipe isolated 800mm gland nut probe SS with curved probe			
accessories for 418242			
	Part No.	520323	Ref. No. 71,01,73 71,30,02
gasket ID ø 160mm ED ø 200mm hole distance 90/180mm hole ø 7mm silicone for bottom heaters			
	Part No.	520324	Ref. No. —
counterflange ID ø 160mm ED ø 200mm hole distance 90/180mm hole ø 7mm SS for bottom heaters			

immersion heating elements



Part No.	418341	Ref. No.	71,20,26
description	heating element 1500W 230V heating circuits 1 L 325mm W 260mm 2 hole fixing thread M14x1.5 mounting distance 251mm connection M4 tube ø 8.8mm connection length 27mm		
spare parts for 418341			
	Part No.	510417	Ref. No. —
flat gasket fibre ED ø 20mm ID ø 14mm thickness 2mm Qty 1 pcs			
accessories for 418341			
	Part No.	520228	Ref. No. —
tooth lock washer ID ø 15.3mm ED ø 24mm steel Qty 1 pcs for thread M14			
	Part No.	520230	Ref. No. —
nut thread M14x1.5 H 5mm WS 19 zinc-coated steel Qty 1 pcs			
	Part No.	521101	Ref. No. —
nut thread M14x1.5 H 5mm WS 19 SS Qty 1 pcs			
	Part No.	550262	Ref. No. —
flat gasket copper ED ø 20mm ID ø 14mm thickness 2mm			



foil heating elements

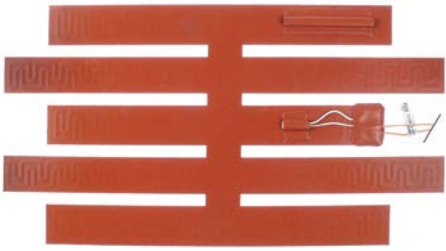

1

Part No.	420273	Ref. No.	71,21,16 71,21,17
description	foil heating element L 450mm W 238mm 1000W 230V silicone cable length 2000mm thickness 1mm connection cable		

accessories

flange gaskets



1

Part No.	520323	Ref. No.	71,01,73 71,30,02
description	gasket ID ø 160mm ED ø 200mm hole distance 90/180mm hole ø 7mm silicone for bottom heaters		

thermostats

bi-metal thermostats

bi-metal thermostats



1

Part No.	390525	Ref. No.	70,01,16 70,10,11
description	bi-metal thermostat hole distance 25mm switch-off temp. 105°C 1NC 1-pole connection F6.3 2 hole fixing		

control and safety thermostats

EGO

control thermostats

55.13_ series



1

Part No.	375705	Ref. No.	70,10,02
description	thermostat t.max. 110°C temperature range 30-110°C 1-pole 1NO 16A probe ø 6mm probe L 115mm capillary pipe 1430mm capillary pipe isolatedmm gland nut M9x1 shaft ø ø6x4.6mm shaft L 23mm shaft position upper rotation 270°		



1

Part No.	375744	Ref. No.	70,10,30
description	thermostat t.max. 120°C temperature range 30-120°C 1-pole 1NO 16A probe ø 6mm probe L 85mm capillary pipe 2970mm capillary pipe isolated 2950mm gland nut shaft ø ø6x4.6mm shaft L 18mm shaft position° shaft position upper rotation 270°		

55.34_ series



1

Part No.	375143	Ref. No.	70,01,05 70,10,05
description	thermostat t.max. 110°C temperature range 32-110°C 3-pole 3NO 16A probe ø 6mm probe L 138mm capillary pipe 1480mm capillary pipe isolated 1100mm gland nut M9x1 shaft ø ø6x4.6mm shaft L 23mm shaft position upper rotation 270°		



E-G-O



Part No.	375022	Ref. No.	70,01,04 70,10,04
description	thermostat t.max. 180°C temperature range 95-180°C 3-pole 3NO 16A probe ø 6mm probe L 133mm capillary pipe 1780mm capillary pipe isolated 1400mm gland nut M9x1 shaft ø 6x4.6mm shaft L 23mm rotation 270°		

safety thermostats

55.11_ series

E-G-O



Part No.	390878	Ref. No.	70.01.07 70.10.07
description	safety thermostat switch-off temp. 80°C 1-pole 1NC 16A probe ø 4mm probe L 89mm capillary pipe 195mm capillary pipe isolatedmm gland nut probe		

switches and momentary switches

rocker/momentary rocker switches

30x11mm



Part No.	301012	Ref. No.	73,15,05
description	rocker switch mounting measurements 30x11mm green 1NO/ indicator light 250V 16A 0-I connection male faston 6.3mm ambient temperature max. 85/125°C protection IP40		



Part No.	346423	Ref. No.	73,15,07
description	rocker switch mounting measurements 30x11mm green 1NO/ indicator light 250V 16A 0-I connection male faston 6.3mm ambient temperature max. 85°C/145°C protection IP65 with cover cap		
accessories for	346423		
	Part No.	301035	Ref. No. —
	protective cover mounting measurements 30x11mm		

float switches



Part No.	401442	Ref. No.	72,01,21 72,30,04
description	float switch thread 1/4" 1NO ø 28mm L 70mm mounting ø 1/4"mm voltage 25VAC/60VDC 0.5A cable cable length 2100mm		

cam switches

with potentiometer



Part No.	345119	Ref. No.	94010000
description	cam switch 2 operating positions 2NO sequence 0-1 16A shaft ø 6x4.6mm shaft L 23mm connection soldering connection operation switch cable lengthmm 10kOhm plastic with potentiometer		
accessories for	345119		
	Part No.	301214	Ref. No. —
	cam switch 2 operating positions operation switch 16A sequence 0-1 shaft ø 6x4.6mm shaft L 33mm connection male faston 6.3mm plastic ambient temperature max. 150°C		

rotary switches

MOELLER/EATON



Part No.	346419	Ref. No.	72,01,67 72,41,07
description	rotary switch 4 0-1-2-3 sets of contacts 4 type T0-2-171/E 400V 16A shaft ø 5.8x6.9mm connection screw		

encoders and potentiometers



Part No.	345119	Ref. No.	94010000
description	cam switch 2 operating positions 2NO sequence 0-1 16A shaft ø 6x4.6mm shaft L 23mm connection soldering connection operation switch cable lengthmm 10kOhm plastic with potentiometer		
accessories for	345119		
	Part No.	301214	Ref. No. —
	cam switch 2 operating positions operation switch 16A sequence 0-1 shaft ø 6x4.6mm shaft L 33mm connection male faston 6.3mm plastic ambient temperature max. 150°C		



lamps

indicator lights

ø16.2mm



1

Part No.	359070	Ref. No.	73,10,07
description	indicator light lens yellow		



1

Part No.	359060	Ref. No.	73,10,04
description	lamp socket mounting measurements ø16.2mm socket E10 connection screw		

indicator lights (complete)

30x11mm



1

Part No.	359160	Ref. No.	73,10,19
description	indicator light mounting measurements 30x11mm 230V green connection male faston 6.3mm rectangular temp.-resist. 125°C		

screw-on/push-on fit

halogen lamp

for socket E14 / E27



1

Part No.	359683	Ref. No.	71,40,14
description	halogen lamp socket E27 240V 60W ø 31mm lens L 58mm L 94mm temp.-resist. 300°C Qty 1		

linear lamps

infrared lamps

with base type R7s



1

Part No.	359331	Ref. No.	1R192405 71.50.32
description	infrared lamp socket R7s L 220mm 230V 300W IMPORT		



1

Part No.	359693	Ref. No.	71,50,31
description	infrared lamp socket R7s L 220mm 230V 400W IMPORT		



1

Part No.	361989 ¹	Ref. No.	71.50.35
description	infrared lamp socket R7s L 218mm 240V 400W		

¹with double glass

quartz lamps



1

Part No.	359692	Ref. No.	B0703 B0705
description	infrared lamp 230V 400W L 320mm H 32mm W 60mm		

sockets for linear lamps

R7s



1

Part No.	359445	Ref. No.	3B0700ET TB-000243
description	bracket for halogen lamp L 46mm W 25mm thickness 1mm edition since year of construction 2005 mounting distance 36mm		



1

Part No.	359399	Ref. No.	73,20,00
description	lamp socket socket R7s		



1

Part No.	359726	Ref. No.	73,20,00
description	lamp socket socket R7s 250V ø 18mm Lmm H 28mm connection cable 230mm mounting distancemm mounting thread M14x1 cable material silicone Qty 1 pcs		



1

Part No.	359675	Ref. No.	73,20,01 TB-000365
description	lamp socket socket R7s with 2 hole fixing cable length 500mm L 28mm		

hard-glass infrared lamps



1

Part No.	358097	Ref. No.	71,01,65 71.40.06
description	infrared lamp socket E27 240V 250W ø 125mm L 173mm type BR125 clear hard glas		



1

Part No.	359463	Ref. No.	71,40,05
description	infrared lamp socket E27 240V 250W ø 125mm L 173mm type BR125 red hard glas		

fluorescent lamps

fluorescent lamps

G5



1

Part No.	359384	Ref. No.	71,45,01
description	fluorescent lamp socket G5 L 287mm 8W 230V Qty 1 pcs		

G13



1

Part No.	359372	Ref. No.	71,45,03 71,45,08
description	fluorescent lamp socket G13 L 895mm 30W 230V Qty 1 pcs		

accessories

sockets



1

Part No.	359681	Ref. No.	73,20,22
description	lamp socket socket G13 for fluorescent lamps		



1

Part No.	359682	Ref. No.	73,20,23
description	lamp socket socket G13 for fluorescent lamps		



1

Part No.	359684	Ref. No.	73,20,20
description	lamp socket socket G5 for fluorescent lamps		

starter holders



1

Part No.	380466	Ref. No.	73,20,21
description	starter holder		

ballasts



1

Part No.	401141	Ref. No.	72,43,12
description	electrical ballast 30W 230V for fluorescent lamps Qty 1 pcs		



			
1			
Part No.	401449	Ref. No.	72,43,11
description	electrical ballast 30W for fluorescent lamps		

			
1			
Part No.	401448	Ref. No.	72,43,10
description	electrical ballast 8W for fluorescent lamps		

oven lamps

lamps

halogen lamps

for socket E14 / E27

			
1			
Part No.	359683	Ref. No.	71,40,14
description	halogen lamp socket E27 240V 60W ø 31mm lens L 58mm L 94mm temp.-resist. 300°C Qty 1		

sockets

E27

			
1			
Part No.	359680	Ref. No.	73,20,05
description	lamp socket socket E27		

timers

audible timers

			
1			
Part No.	350087	Ref. No.	72,01,48 72,20,01
description	audible timer operation time 60min ø 47mm shaft ø 6x4.6mm shaft L 20mm mounting distance 28mm		

alarm devices

buzzers

			
1			
Part No.	350050	Ref. No.	72,01,30 72,30,10
description	buzzer 230VAC connection male faston 6.3mm screw mounting thread M4 60dB		

contactors

BENEDIKT & JÄGER

power contactors

			
1			
Part No.	380679	Ref. No.	35500005 88,11,58
description	power contactor resistive load 25A 230VAC (AC3/400V) 12A/5.5kW main contacts 3NO auxiliary contacts 1NO connection screw connection type K2-12A01230		

relays

miscellaneous

			
1			
Part No.	380491	Ref. No.	72,42,05
description	installation relay 1NO/1NC 230V voltage AC 12A DIN rail protection IP20		



electronic controllers

STÖRK-TRONIC

universal controllers

built-in version



1

Part No.	379599	Ref. No.	70,10,20
-----------------	--------	-----------------	----------

description

probes

producer-specific probes

probes

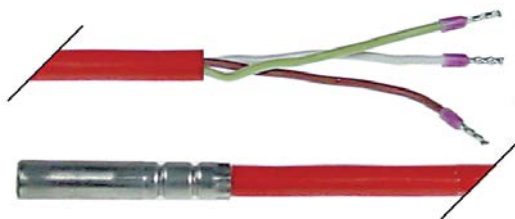

1

Part No.	379405	Ref. No.	70,30,03
-----------------	--------	-----------------	----------

description temperature probe Pt100 cable silicone probe -50 up to +200°C cable -50 up to +180°C connection 3-wire thread probe \varnothing 6x35mm cable length 2m

fans

cross flow fans

ebm-papst



1

Part No.	601274	Ref. No.	72,10,11
-----------------	--------	-----------------	----------

description cross flow fan roller \varnothing 60mm roller length 2x180mm motor position centre 36W universal bearing silicone connection 200 230V cable length 200mm 50Hz



1

Part No.	601279	Ref. No.	72,10,07 73,01,18
-----------------	--------	-----------------	----------------------

description cross flow fan roller \varnothing 60mm roller length 60mm motor position right universal bearing silicone connection male faston 6.3mm 220-240V 50Hz

electric accessories

terminals

connection terminals with screw connection



1

Part No.	508356	Ref. No.	733030
-----------------	--------	-----------------	--------

description connection terminal 3-pole max 400V cross section 4mm²

knobs

universal knobs



1

Part No.	111861	Ref. No.	70,01,18 70,20,05
-----------------	--------	-----------------	----------------------

description knob thermostat 1-10 t.max.°C \varnothing 50mm shaft \varnothing 6x4.6mm shaft flat upper

producer-specific knobs

SCHOLL



1

Part No.	111861	Ref. No.	70,01,18 70,20,05
-----------------	--------	-----------------	----------------------

description knob thermostat 1-10 t.max.°C \varnothing 50mm shaft \varnothing 6x4.6mm shaft flat upper



handles and hand wheels

handle bars

handle bars



1

Part No. 690442 **Ref. No.** 96,20,08

description handle rod tube ø 25mm thickness 1.5mm L 500mm SS

consoles



1

Part No. 690329 **Ref. No.** 74,40,01
79,01,64

description console pair for handle rod Qty 2 pcs

STEINCO

with fixing plate

plastic



1

Part No. 700227¹ **Ref. No.** 75,01,37
75,20,03

description swivel castor with swivel brake ø 125mm plate fixing housing plastic plate size 95x70mm hole distance 75x50mm capacity 100kg bearing ball bearing wheel body polyamide tread TPE tyres H 161mm wheel width 32mm Qty 1 pcs

¹with swivel brake

bumper angles

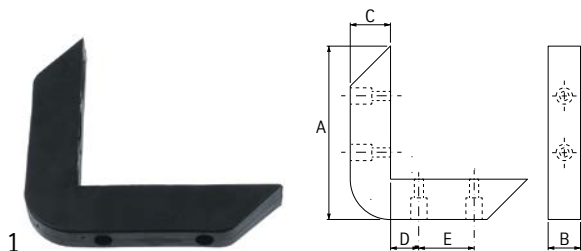

1

Part No. 690378¹ **Ref. No.** 75,90,04

description bumper angle outer length 165mm inner length 130mm W 40mm H 30mm mounting distance 50/63mm hole distance 19/32mm hole ø 7mm plastic black

accessories for 690378



Part No. 690902 **Ref. No.** —
plug for bumper angle ø 10mm L 8mm grey Qty 1 pcs

¹suitable plug 690902

valves and tank inlets

ball valves

producer-specific

SCHOLL



1

Part No. 514333 **Ref. No.** 76,20,14

description ball valve connection 1/2" IT - 1/2" ET spout ø 8mm



1

Part No. 514364 **Ref. No.** 76,20,17

description ball valve handle ø 27mm inlet 1/2" ET wing handle grommet ø 12mm grommet length 76mm outlet ø 12mm

GASTROPARTS.COM

