



GASTROPARTS

Salvis

- [EN]** Equipment
- [DE]** Geräte
- [ES]** Aparatos
- [FR]** Équipement
- [IT]** Attrezzature
- [PL]** Urządzenia
- [RU]** Оборудование

✉ gastroparts@gastroparts.com

☎ tel. +48 56 657 00 66

📘 fb.com/gastroparts.global

GASTROPARTS.COM





heating elements

heating elements for chip scuttles

			
Part No.	418465	Ref. No.	178980 1G592028
description	heating element 800W 230V heating circuits 1 L 370mm W 95mm connection male faston 6.3mm tube ø 6.3mm dry heating element connection distance 89mm		

heating elements for fryers

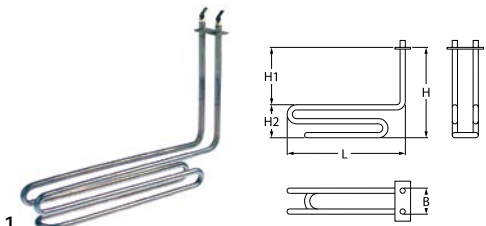
			
Part No.	418460	Ref. No.	178613 1G592018
description	heating element 2000W 230V heating circuits 1 L 280mm W 42mm H 200mm rectangular flange connection male faston 6.3mm H1 146mm H2 54mm hole ø 5mm flange length 48mm flange width 18mm fryer		

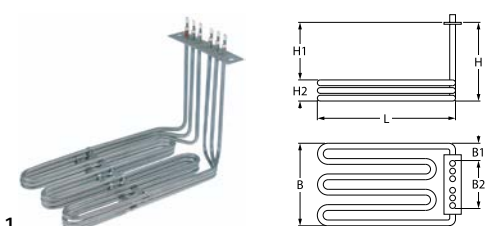
			
Part No.	418474	Ref. No.	1G564035 689297
description	heating element 6000W 230/400V heating circuits 3 L 285mm W 155mm H 173mm rectangular flange connection male faston 6.3mm immersion heater W1 32.5mm W2 90mm H1 151mm H2 22mm hole distance 124mm hole ø 8mm flange length 136mm flange width 30mm tube ø 6.5mm connection length 33mm		

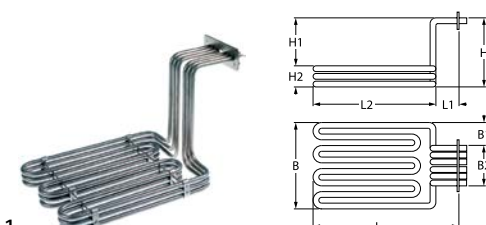
			
Part No.	418461	Ref. No.	178871
description	heating element 6000W 230/400V heating circuits 3 L 357mm W 208mm H 210mm L1 77mm L2 283mm W1 67mm W2 74mm H1 178mm H2 32mm windings 9 flange length 100mm flange width 40mm hole distance 83mm connection male faston 6.3mm mounting thread M5 tube ø 8.5mm rectangular flange immersion heater		

heating elements for griddles

			
Part No.	418575	Ref. No.	1V421471
description	heating element 100W 230V heating circuits 1 L 94mm W 68mm tube ø 6.5mm cable length 70mm connection length 20mm dry heating element		

			
Part No.	418463	Ref. No.	1G563025
description	heating element 3300W 400V heating circuits 1 L 420mm W 255mm H 45mm tube ø 6.5mm cable length 450mm connection length 23mm connection distance 249mm dry heating element		

			
Part No.	418435	Ref. No.	178859 1G70069 1G870069
description	heating element 3500W 230V heating circuits 1 L 460mm W 233mm H 73mm tube ø 6.3mm cable length 1050mm connection length 25mm griddle dry heating element		

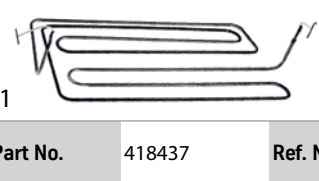
			
Part No.	418437	Ref. No.	178996 1G870136
description	heating element 3500W 380V heating circuits 1 L 478mm W 250mm H 70mm tube ø 6.3mm cable length 115mm mounting pos. right griddle dry heating element		

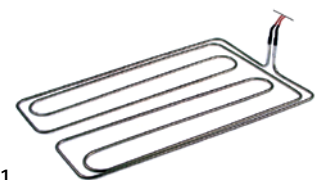
			
Part No.	418434	Ref. No.	178993 1G870133
description	heating element 3500W 380V heating circuits 1 L 480mm W 310mm H 70mm tube ø 6.5mm cable length 550mm connection length 35mm griddle dry heating element		



			
Part No.	418406	Ref. No.	178857 1G870071
description	heating element 3500W 400V heating circuits 1 L 455mm W 287mm H 77mm tube ø 6.5mm cable length 1100mm dry heating element		

			
Part No.	418436	Ref. No.	178995 1G870135 BK178995
description	heating element 3500W 400V heating circuits 1 L 480mm W 250mm H 70mm tube ø 6.5mm cable length 115mm mounting pos. left griddle dry heating element		

			
Part No.	419015	Ref. No.	1G592028
description	heating element 800W 230V heating circuits 1 L 365mm W 108mm tube ø 6.5mm connection male faston 6.3mm connection length 20mm connection distance 102mm dry heating element		

heating elements for large hobs

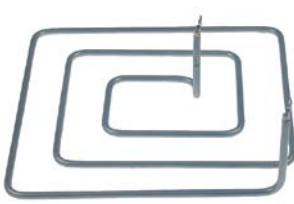
			
Part No.	418485	Ref. No.	1G532081
description	heating element 1100W 400V L 258mm W 258mm H 82mm heating circuits 1 tube ø 6.5mm mounting pos. centre/inside connection length 20mm connection M4 dry heating element		

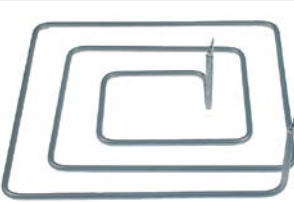
			
Part No.	418484	Ref. No.	1G532080
description	heating element 1300W 400V L 284mm W 284mm H 81mm heating circuits 1 tube ø 6.5mm mounting pos. centre/outside connection length 20mm connection M4 dry heating element		

			
Part No.	418483	Ref. No.	1G532079
description	heating element 650W 400V L 315mm W 315mm H 80mm heating circuits 1 tube ø 6.5mm mounting pos. outer connection length 20mm connection M4 dry heating element		

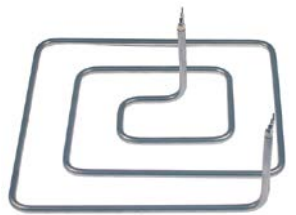
			
Part No.	418486	Ref. No.	1G532082
description	heating element 900W 400V L 230mm W 230mm H 81mm heating circuits 1 tube ø 6.5mm mounting pos. inner connection length 20mm connection M4 dry heating element		

heating elements for salamanders/toast-

			
Part No.	419184	Ref. No.	1E409100
description	heating element 2000W 230V heating circuits 1 L 205mm W 262mm W2 305mm flange length 26mm flange width 11mm tube ø 4mm connection length 36mm dry heating element connection F6.3 salamander grill H 4mm		

			
Part No.	415541	Ref. No.	10279801
description	heating element 2000W 230V heating circuits 1 mounting pos. left L 250mm W 210mm H 120mm W2 170mm connection distance 164mm tube ø 6.3mm cable length 500mm dry heating element salamander grill		

1

Part No.	415540	Ref. No.	10279802
description	heating element 2000W 230V heating circuits 1 mounting pos. right L 250mm W 210mm H 120mm W2 170mm connection distance 164mm tube ø 6.5mm cable length 500mm dry heating element salamander grill		

bottom heaters





1

Part No.	390410	Ref. No.	1G963100
description	bi-metal safety thermostat hole distance 24mm switch-off temp. 200°C 1NC 1-pole 16A connection F6.3 2 hole fixing		



1

Part No.	418429	Ref. No.	1G564207	
description	bottom heater 1800W 230V heating circuits 1 ø 196mm safety thermostat 250°C M5 mounting distance 180mm			
spare parts for	418429			
	Part No.	375137	Ref. No.	—
	safety thermostat switch-off temp. 250°C 1-pole 16A probe ø 3.03mm probe L 160mm capillary pipe 880mm capillary pipe isolated 800mm gland nut probe SS with curved probe			







1

Part No.	418473	Ref. No.	1G963111
description	bottom heater 1800W 230V heating circuits 1 ø 196mm safety thermostat°C M5 mounting distance 180mm		





1



Part No.	418466	Ref. No.	1G963110	
description	bottom heater 1800W 230V heating circuits 1 ø 196mm thermostat 128°C M5 mounting distance 180mm			
spare parts for	418466			
	Part No.	375782	Ref. No.	—
	thermostat t.max. 128°C temperature range 30-128°C 1-pole 1NO 16A probe ø 3.03mm probe L 178mm capillary pipe 870mm capillary pipe isolated 800mm gland nut shaft ømm shaft L 23mm shaft position upper rotation 270° outer switch 2NO with curved probe			
	Part No.	520323	Ref. No.	1G963116 721921 963116
	gasket ID ø 160mm ED ø 200mm hole distance 90/180mm hole ø 7mm silicone for bottom heaters			
accessories for	418466			
	Part No.	520323	Ref. No.	1G963116 721921 963116
	gasket ID ø 160mm ED ø 200mm hole distance 90/180mm hole ø 7mm silicone for bottom heaters			





1

Part No.	418467	Ref. No.	1G564199 726672	
description	bottom heater 1800W 230V heating circuits 2 ø 196mm safety thermostat 250°C thermostat 105°C M5 mounting distance 180mm			
spare parts for	418467			
	Part No.	375137	Ref. No.	—
	safety thermostat switch-off temp. 250°C 1-pole 16A probe ø 3.03mm probe L 160mm capillary pipe 880mm capillary pipe isolated 800mm gland nut probe SS with curved probe			
	Part No.	375794	Ref. No.	—
	thermostat t.max. 105°C temperature range 30-105°C 1-pole 1NO 16A probe ø 3.03mm probe L 178mm capillary pipe 870mm capillary pipe isolated 800mm gland nut shaft ø6x4.6mm shaft L 23mm shaft position upper rotation 270° outer switch 2NO with curved probe			
accessories for	418467			
	Part No.	520323	Ref. No.	1G963116 721921 963116
	gasket ID ø 160mm ED ø 200mm hole distance 90/180mm hole ø 7mm silicone for bottom heaters			



			
1			
Part No.	418482	Ref. No.	1G564209
description	bottom heater 2000W 400V heating circuits 1 \varnothing 196mm safety thermostat 250°C thermostat 128°C M5 H 5mm mounting distance 180mm connection male faston 6.3mm		
spare parts for	418482		
	Part No.	375137	Ref. No. —
	safety thermostat switch-off temp. 250°C 1-pole 16A probe \varnothing 3.03mm probe L 160mm capillary pipe 880mm capillary pipe isolated 800mm gland nut probe SS with curved probe		
	Part No.	375782	Ref. No. —
	thermostat t.max. 128°C temperature range 30-128°C 1-pole 1NO 16A probe \varnothing 3.03mm probe L 178mm capillary pipe 870mm capillary pipe isolated 800mm gland nut shaft \varnothing mm shaft L 23mm shaft position upper rotation 270° outer switch 2NO with curved probe		







			
1			
Part No.	419008	Ref. No.	1G564319 834963
description	bottom heater 3000W 400V heating circuits 2 \varnothing 196mm safety thermostat 250°C thermostat 128°C M5 H 180mm		
spare parts for	419008		
	Part No.	375137	Ref. No. —
	safety thermostat switch-off temp. 250°C 1-pole 16A probe \varnothing 3.03mm probe L 160mm capillary pipe 880mm capillary pipe isolated 800mm gland nut probe SS with curved probe		
	Part No.	375782	Ref. No. —
	thermostat t.max. 128°C temperature range 30-128°C 1-pole 1NO 16A probe \varnothing 3.03mm probe L 178mm capillary pipe 870mm capillary pipe isolated 800mm gland nut shaft \varnothing mm shaft L 23mm shaft position upper rotation 270° outer switch 2NO with curved probe		

heating plates

			
1			
Part No.	418438	Ref. No.	178987 1G592036 BK178987
description	hot plate 700W 230V heating circuits 1 cable length 750mm L 480mm W 80mm		

heating elements for convection

			
1			
Part No.	419052	Ref. No.	10177222
description	heating element 1600W 230V heating circuits 1 ID \varnothing 220mm ED \varnothing 250mm L 345mm L1 100mm thread M10x1 connection male faston 6.3mm tube \varnothing 6.5mm convection heating element for combi-steamer		

			
1			
Part No.	418690	Ref. No.	10295641
description	heating element 2000W 230V L 90mm W 390mm connection F 6.3 tube \varnothing 8.5mm M14x1.5 mounting distance 390mm		
accessories for	418690		
	Part No.	510417	Ref. No. —
	flat gasket fibre ED \varnothing 20mm ID \varnothing 14mm thickness 2mm Qty 1 pcs		
	Part No.	520228	Ref. No. —
	tooth lock washer ID \varnothing 15.3mm ED \varnothing 24mm steel Qty 1 pcs for thread M14		
	Part No.	520230	Ref. No. —
	nut thread M14x1.5 H 5mm WS 19 zinc-coated steel Qty 1 pcs		
	Part No.	521101	Ref. No. —
	nut thread M14x1.5 H 5mm WS 19 SS Qty 1 pcs		
	Part No.	550262	Ref. No. —
	flat gasket copper ED \varnothing 20mm ID \varnothing 14mm thickness 2mm		

radiation heaters

			
1			
Part No.	490148	Ref. No.	1G962926
description	radiation heater rectangular 2500W 400V without pan detection L 300mm W 570mm heating circuits 2 EGO		

			
1			
Part No.	490147	Ref. No.	1G962922
description	radiation heater rectangular 3500W 230V with pan detection L 300mm W 570mm heating circuits 2 EGO		

1

Part No.	490198	Ref. No.	1E409101 409.101
description	radiation heater rectangular flange 2300W 230V L 320mm W 230mm H 35mm heating circuits 1 EGO		

1-circuit



1

Part No.	490131	Ref. No.	1G962948
description	radiation heater ø 250mm 2500W 400V heating circuits 1 energy regulation with temperature signalization with ribbon heater connections 2+2 connection type male faston 6.3mm EGO		

foil heating elements



1

Part No.	418472	Ref. No.	1G962947 689653
description	foil heating element L 400mm W 230mm 175W 230V aluminium cable length 490mm thickness 3mm		

accessories

flange gaskets



1

Part No.	520324	Ref. No.	1G963115	
description	counterflange ID ø 160mm ED ø 200mm hole distance 90/180mm hole ø 7mm SS for bottom heaters			
accessories for	520324			
	Part No.	520323	Ref. No.	1G963116 721921 963116
	gasket ID ø 160mm ED ø 200mm hole distance 90/180mm hole ø 7mm silicone for bottom heaters			



1

Part No.	520323	Ref. No.	1G963116 721921
description	gasket ID ø 160mm ED ø 200mm hole distance 90/180mm hole ø 7mm silicone for bottom heaters		

counterflanges



1

Part No.	520324	Ref. No.	1G963115	
description	counterflange ID ø 160mm ED ø 200mm hole distance 90/180mm hole ø 7mm SS for bottom heaters			
accessories for	520324			
	Part No.	520323	Ref. No.	1G963116 721921 963116
	gasket ID ø 160mm ED ø 200mm hole distance 90/180mm hole ø 7mm silicone for bottom heaters			

energy regulators

EGO

1-circuit



1

Part No.	380015	Ref. No.	1G962529 314544
description	energy regulator 230V 13A single-circuit turn direction right shaft ø 6x4.6mm shaft L 23mm mounting thread M4 power release 6-100% no. 50.57021.010		

thermostats

bi-metal thermostats

safety bi-metal thermostats



1

Part No.	390410	Ref. No.	1G963100
description	bi-metal safety thermostat hole distance 24mm switch-off temp. 200°C 1NC 1-pole 16A connection F6.3 2 hole fixing		



bi-metal thermostats

			
1			
Part No.	390592	Ref. No.	1V421472
description	bi-metal thermostat hole distance 24mm switch-off temp. 100°C 1NC 1-pole 2 hole fixing		



control and safety thermostats

EGO

control thermostats

55.13_ series

			
1			

Part No.	375007	Ref. No.	178983
description	thermostat t.max. 110°C temperature range 30-110°C 1-pole 1NO 16A probe ø 6mm probe L 113mm capillary pipe 870mm capillary pipe isolatedmm gland nut M9x1 shaft L 25mm shaft position upper rotation 270°		
accessories for	375007		
	Part No.	110119	Ref. No. —
	knob thermostat t.max. 110°C ø 50mm shaft ø 6x4.6mm shaft flat upper black temperature range 30-110°C rotation 270°		
	Part No.	110241	Ref. No. —
	knob thermostat t.max. 110°C ø 50mm shaft ø 6x4.6mm shaft flat upper black temperature range 30-110°C		

safety thermostats

55.11_ series

			
1			

Part No.	375790	Ref. No.	178610 178882 BK178610
description	safety thermostat switch-off temp. 273°C 1-pole 16A probe ø 6mm probe L 77mm capillary pipe 400mm capillary pipe isolatedmm gland nut probe SS		

55.13_ series

			
1			

Part No.	375784	Ref. No.	178982
description	safety thermostat switch-off temp. 140°C 1-pole 16A probe ø 6mm probe L 77mm capillary pipe 870mm capillary pipe isolated 790mm gland nut probe SS		

55.32_ series

			
1			

Part No.	375787	Ref. No.	1G962526
description	safety thermostat switch-off temp. 380°C 2-pole 20A probe ø 4mm probe L 163mm capillary pipe 1190mm capillary pipe isolated 800mm gland nut probe SS		

			
1			

Part No.	375681	Ref. No.	619221
description	safety thermostat switch-off temp. 520°C 3-pole 20A probe ø 3.9mm probe L 228mm capillary pipe 890mm capillary pipe isolated 400mm gland nut		



55.33_series



Part No.	375781	Ref. No.	1G962532 689300
description	safety thermostat switch-off temp. 275°C 3-pole 20A probe ø 4mm probe L 157mm capillary pipe 870mm capillary pipe isolated 350mm gland nut probe SS		

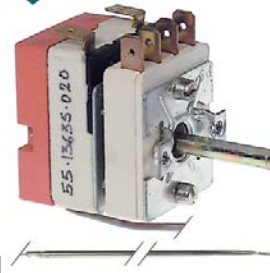

Part No.	375780	Ref. No.	1G962531
description	thermostat temperature range 120-190°C 1-pole 1NO 16A probe ø 3mm probe L 248mm capillary pipe 1730mm capillary pipe isolated 1660mm gland nut shaft ø 6x4.6mm shaft L 23mm shaft position upper rotation 270° outer switch 2NO		

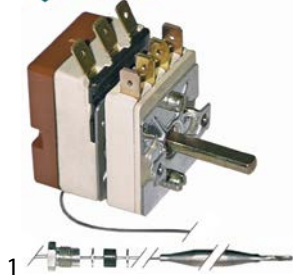

control thermostats with operation switch

55.13_series



Part No.	375406	Ref. No.	1G873027
description	thermostat t.max. 110°C temperature range 30-110°C 1-pole 1CO 16A probe ø 6mm probe L 113mm capillary pipe 2380mm capillary pipe isolated 1700mm gland nut M9x1 shaft ø 6x4.6mm shaft L 18mm shaft position upper rotation 270° outer switch 2NO		

accessories for 375406

	Part No.	110545	Ref. No.	—
	knob dial plate silver thermostat t.max. 110°C 30-110°C rotation 310° ED ø 59mm ID ø 45.5mm			
	Part No.	112173	Ref. No.	—
	knob universal ø 62mm black without adaptor/dial plate			
	Part No.	112311	Ref. No.	—
	knob adapter shaft ø 6x4.6mm L 0mm with spring			

55.34_series

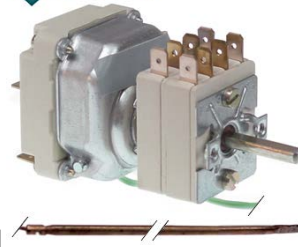

Part No.	375691	Ref. No.	619248
description	thermostat t.max. 390°C temperature range 60-390°C 3-pole 3NO 16A probe ø 3.9mm probe L 228mm capillary pipe 1110mm capillary pipe isolated 600/700mm gland nut shaft ø 6x4.6mm shaft L 23mm shaft position upper rotation 270° outer switch 2NO/2NO		



Part No.	375570	Ref. No.	179312
description	thermostat t.max. 470°C temperature range 100-470°C 1-pole 1NO 16A probe ø 3.9mm probe L 228mm capillary pipe 1110mm capillary pipe isolated 600mm gland nut shaft ø 6x4.6mm shaft L 24mm shaft position upper rotation 270° outer switch 2NO		

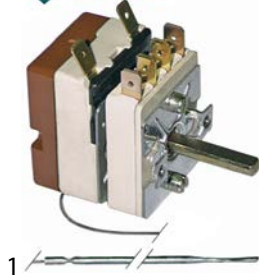

Part No.	375408	Ref. No.	1G873056 689599
description	thermostat t.max. 320°C temperature range 50-320°C 1-pole 1NO 16A probe ø 3.03mm probe L 160mm capillary pipe 1150mm capillary pipe isolatedmm gland nut shaft ø 6x4.6mm shaft L 23mm shaft position upper rotation 270° outer switch 2NO		



Part No.	375140	Ref. No.	179302
description	thermostat t.max. 650°C temperature range 50°C/50-600°C/70-650°C 3-pole 3NO 16A probe ø 4mm probe L 228mm capillary pipe 1200mm capillary pipe isolated 1200mm gland nut shaft ø 6x4.6mm shaft L 23mm shaft position left rotation 318° outer switch 2NO		



switches and momentary switches

rocker/momentary rocker switches

30x22mm



1

Part No.	346899	Ref. No.	1V420303
description	rocker switch mounting measurements 30x22mm yellow 2NO 230V 16A illuminated 0-1 connection male faston 6.3mm ambient temperature max. 125/55°C protection IP65 with rubber collar		

push/momentary push switches

ø12mm



1

Part No.	346594	Ref. No.	1G564257
description	momentary push switch mounting ø 12mm black 1NO 250V 4A connection male faston 6.3mm ambient temperature max. 85°C protection IP40		



1

Part No.	346583	Ref. No.	178883
description	push switch mounting ø 12mm black 1NO 250V 6A connection male faston 4.8mm ambient temperature max. 100/55°C protection IP40		

microswitches

pin-plunger actuated

M10



1

Part No.	348013	Ref. No.	10279075 279-075
description	microswitch with plunger thread M10x0.75 thread L 20mm 250V 6A 1NO connection cable stroke 5.8mm mounting distance 22mm ambient temperature max. 125°C for door actuating force: 360g		

mercury tilt switches



1

Part No.	346582	Ref. No.	178612 1G594020
description	mercury tilt switch		

cam switches

on/off

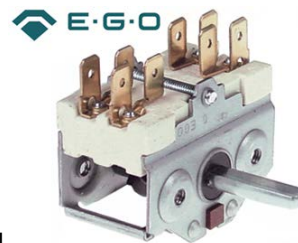

1

Part No.	300074	Ref. No.	178843 1G960702
description	cam switch 4 operating positions 2NO sequence 0-1-0-1 16A shaft ø 6x4.6mm shaft L 23mm connection male faston 6.3mm ceramic		

7-position



1

Part No.	300025	Ref. No.	178851
description	cam switch 7 operating positions 1NO/2CO sequence 0-1-2-3-4-5-6 16A shaft ø 6x4.6mm shaft L 23mm connection screw 7-position ceramic		

accessories for

	Part No.	112172	Ref. No.	—
	knob universal ø 70mm black without adaptor/dial plate			
	Part No.	112213	Ref. No.	—
	knob dial plate silver switch 7-position t.max.°C ED ø 63mm ID ø 45.5mm			
	Part No.	112311	Ref. No.	—
	knob adapter shaft ø 6x4.6mm L 0mm with spring			



5 operating positions

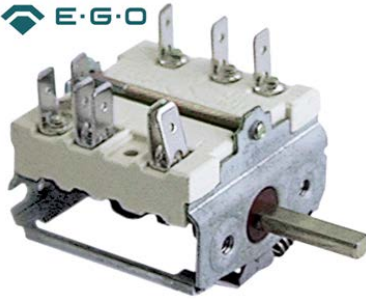

1

Part No.	345199	Ref. No.	10279800 720534
description	cam switch 5 operating positions 2NO/1CO sequence 0-1-2-3-4 16A shaft ø 6x4.6mm shaft L 23mm connection male faston 6.3mm		

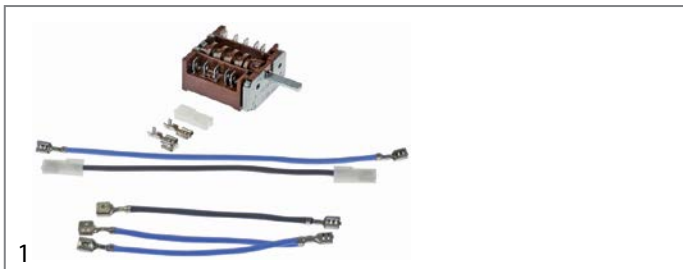

1

Part No.	347708	Ref. No.	1E409312
description	cam switch shaft ø 6x4.6mm shaft L 23.5mm connection male faston 6.3mm 3-pole conversion kit		
spare parts for	347708		
	Part No.	301319	Ref. No.
			1E409103 409103
description	cam switch 16A shaft ø 6x4.6mm shaft L 23mm connection male faston 6.3mm plastic		

10 operating positions



1

Part No.	348183	Ref. No.	1G960000
description	cam switch 10 operating positions sequence 0-1-2-3-4-5-6-7-8-9 16A shaft ø 6x4.6mm shaft L 23mm connection male faston 6.3mm		

miscellaneous



1

Part No.	301319	Ref. No.	1E409103
description	cam switch 16A shaft ø 6x4.6mm shaft L 23mm connection male faston 6.3mm plastic		

control equipment

lamps



1

Part No.	359896	Ref. No.	1G887026
description	neon light bulb socket Ba9s 230V green ø 10mm L 28mm		

lamps

indicator lights

indicator lights 3-piece (housing, lens and bulb)

ø18.2mm



1

Part No.	359855	Ref. No.	178839
description	indicator light housings mounting measurements ø18.2mm socket Ba9s green		

lamps

neon light bulbs



1

Part No.	359896	Ref. No.	1G887026
description	neon light bulb socket Ba9s 230V green ø 10mm L 28mm		

indicator lights (complete)

ø10mm

with plug-in socket



1

Part No.	359139	Ref. No.	10177681 177.681
description	indicator light ø 10mm green 230V connection male faston 6.3mm Qty 1 pcs		



1

Part No.	359138	Ref. No.	10177680
description	indicator light ø 10mm red 230V connection male faston 6.3mm Qty 1 pcs		



ø16mm

with plug-in socket



1

Part No.	359909	Ref. No.	178985 1G887032 BK178985
description	indicator light ø 16mm 230V green cable length 200mm cable material silicone wire		



1

Part No.	359908	Ref. No.	178999
description	indicator light ø 16mm 230V yellow cable length 200mm cable material silicone wire		



1

Part No.	359094	Ref. No.	1G962017
description	indicator light ø 16mm 400V yellow cable length 200mm cable material silicone wire		

screw-on/push-on fit

neon light bulbs



1

Part No.	359896	Ref. No.	1G887026
description	neon light bulb socket Ba9s 230V green ø 10mm L 28mm		

timers

mechanical timers



1

Part No.	360534	Ref. No.	1E409147 409.147
description	timer 600 with bell 2-pole operation time 15min impulse mechanical 2NO at 250V 16A shaft ø 6x4.6mm shaft L 22mm with bell mounting distance 29mm connection male faston 6.3mm DIEHL ambient temperature max. 85°C		

audible timers



1

Part No.	350014	Ref. No.	10279803
description	audible timer operation time 15min ø 56mm shaft ø 6x4.6mm shaft L 24mm mounting distance 28mm		

contactors

ABB

power contactors



1

Part No.	380104	Ref. No.	10279788 523909
description	power contactor resistive load 25A 230VAC (AC3/400V) 9A/4kW main contacts 3NO auxiliary contacts 1NO connection screw connection type A9-30-10		

solid state relays

CRYDOM



1

Part No.	401563	Ref. No.	1G533279
description	solid state relay CRYDOM 1 phase 50A 600V 4-32VDC L 59mm W 46mm screw type HD4850-10		
accessories for	401563		
	Part No.	401564	Ref. No.
			1G946000 946000
	heat-conducting foil L 62mm W 45mm for solid state relay		



heat-conducting foils



1

Part No.	401564	Ref. No.	1G946000
description	heat-conducting foil L 62mm W 45mm for solid state relay		

relays

power relays

with bracket mounting



1

Part No.	380403	Ref. No.	1G962019
description	power relays FINDER 230VAC 16A 3CO connection F6.3 bracket mounting manuf. no. 62.83.8.230.0500		



1

Part No.	380185	Ref. No.	1V420302
description	power relays Italiana Relè 230VAC 30A 1NO connection F6.3 bracket mounting dimensions 36.5x32.2x51.8mm manuf. no. A10-230AC-FA		

electronic controllers

LAE

refrigeration controllers

built-in version



1

Part No.	379852	Ref. No.	1K267923
description	electronic controller LAE type AT1-5AS4D-G mounting measurements 71x29mm 12V voltage AC/DC NTC/PTC relay outputs 2 NO-16A(5) NO-4A(1) NTC/PTC front measurements 77x35mm built-in depth 70mm protection IP55 accuracy 1% defr. funct. -50 to +120°C display 3 digits		



1

Part No.	378043	Ref. No.	1K267923 old
description	electronic controller LAE type SDU12T0RD mounting measurements 71x29mm 12V voltage AC/DC PTC relay outputs 1 relay protection IP54 -19 up to +99°C compressor relay 5A		

probes

universal probes

temperature probes



1

Part No.	379860	Ref. No.	1V421494
description	temperature probe NTC 10kOhm cable PVC probe -20 up to +80°C cable -10 up to 100°C probe ø6x40mm cable length 1.5m without screw connection 2-wire		

producer-specific probes

probes



1



Part No.	379880	Ref. No.	178881
description	temperature probe NTC 900kOhm cable silicone probe -40 up to +150°C cable -50 up to +180°C connection male faston thread probe ø6x80/170mm cable length 0.4m		



1

Part No.	379879	Ref. No.	178611 BK178611
description	temperature probe NTC 900kOhm cable silicone probe -40 up to +150°C cable -50 up to +180°C connection male faston thread probe ø6x80/170mm cable length 0.65m		



			
1			
Part No.	379882	Ref. No.	1G943000
description	temperature probe thermocouple K (NiCr-Ni) cable glass fibre probe -50 up to 1150°C cable -50 up to +350°C connection 2-wire probe ø4x20mm		
accessories for	379882		
	Part No.	379881	Ref. No. 1G534536 534536
	bayonet adapter L 66mm thread M6x1 ID ø 7/4mm ED ø 12mm		

accessories

adapters

			
1			
Part No.	379881	Ref. No.	1G534536
description	bayonet adapter L 66mm thread M6x1 ID ø 7/4mm ED ø 12mm		

electronics

PCBs

			
1			
Part No.	401516	Ref. No.	178616 BK178616
description	keypad PCB L 250mm W 75mm		

			
1			
Part No.	401562	Ref. No.	1G534537
description	PCB		

			
1			
Part No.	400411	Ref. No.	179303
description	PCB pyroceram range CH 40/45/80 230V		

solenoid valves

solenoid valves (water)

metal			
ASCO			
spare parts and accessories			
solenoid coils			

			
1			
Part No.	371113	Ref. No.	278270 BK278270
description	solenoid coil Asco 230VAC 50Hz coil type 400526-117 seat ø 16mm		

fans

cross flow fans

ebm-papst			
			
1			
Part No.	601437	Ref. No.	1V422429
description	cross flow fan ebm-papst QLZ06/1800-2518 roller ø 60mm roller length 180mm laminated core thickness 18mm motor position right 230V/50Hz 28W refrigeration bearing rubber connection male faston 6.3mm airflow 130m³/h 0 up to +60°C		



hot air motors

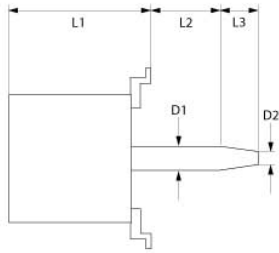

1

Part No.	499186	Ref. No.	293474 BK293474
description	fan motor 230V 1 phase 50Hz 0.32kW 1320rpm L1 170mm L2 33mm L3 34mm M10x1.5 2.3A suitable capacitor 25µF D1 ø 17mm D2 ø 13.5mm with plug		

hot air fans

miscellaneous



1

Part No.	500128	Ref. No.	295.101 BK295101
description	hot air fan 230V 120W 0.53A 2000rpm L2 135mm L3 35mm L4 40mm fan wheel ø 180mm ebm-papst type R2E180-AI01-12		
spare parts for	500128		
	Part No.	365170	Ref. No. —
	capacitor capacity 2µF 425V tolerance 5% 50/60Hz ambient temperature max. -25 to +85°C ø 25mm L 49mm M8 plastic connection cable 250mm 416.17.74 protection		

fuses

thermal fuses



1

Part No.	358298	Ref. No.	1V421473
description	thermal fuse switch-off temp. 128°C nominal 10A		

electric accessories

terminals

connection terminals with faston connections



1

Part No.	550953	Ref. No.	1V420304
description	connection terminal 6-pole max. 20A max 450V connection F6.3/F6.3 temp.-resist. 90°C		



1

Part No.	550954	Ref. No.	1V421490
description	connection terminal 9-pole max. 20A max 450V connection F6.3/F6.3 temp.-resist. 90°C		

electronic components

varistors



1

Part No.	401565	Ref. No.	1G946001
description	varistor		

resistors



1

Part No.	359502	Ref. No.	16-888002 178853 BK178853
description	resistor 120KOhm 3W		



1

Part No.	359503	Ref. No.	178854 1G888001
description	resistor 680KOhm		



miscellaneous

battery holders

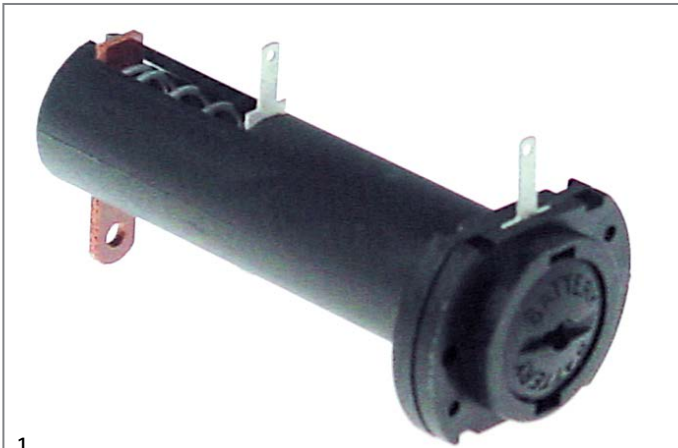

1

Part No.	102909	Ref. No.	1G564255
description	battery holder for battery type AA 1.5V mounting ø 19mm connection male faston 2.8mm		

gas taps

PEL

22S/O series













1

Part No.	106056	Ref. No.	178901 1G820096 BK178901
-----------------	--------	-----------------	--------------------------------

description gas tap PEL type 22S/O gas inlet M20x1.5 (tube ø 12mm) bypass nozzle ø 0.35mm gas outlet M20x1.5 (tube ø 12/10mm) thermocouple connection M10x1 pilot connection M10x1 shaft ø 6x4.6mm shaft L 45/20mm shaft flat left

spare parts for 106056

	Part No.	101058	Ref. No.	—
	magnet unit L 39mm D1 ø 15.4mm D2 ø 13.5mm suitable for PEL22/EGA24197 standard			
	Part No.	101213	Ref. No.	—
	gas tap front part shaft ø 6x4.6mm shaft L 45/20mm shaft flat right/left suitable for PEL22			
	Part No.	101240	Ref. No.	—
	gas connection thread M20x1.5 tube ø 12/10mm for PEL gas taps with gasket and screws horizontal			
	Part No.	101290	Ref. No.	—
	thermocouple nut T1: M10x1 T2: M18x1 suitable for PEL20/21			
	Part No.	101460	Ref. No.	—
	O-ring ø 12.37mm D1 ø 2.62mm suitable for PEL22			
	Part No.	101461	Ref. No.	—
	screw kit suitable for PEL22 Qty 4 pcs			
accessories for	106056			
	Part No.	100908	Ref. No.	—
	union screw thread M10x1 for pipe ø 4mm Qty 1 pcs			

accessories for	106056			
	Part No.	100909	Ref. No.	—
	union screw thread M10x1 for pipe ø 6mm Qty 1 pcs			
	Part No.	101241	Ref. No.	—
	gas connection thread M20x1.5 tube ø 12/10mm for PEL gas taps vertical			
	Part No.	101246	Ref. No.	—
	olive for pipe ø 4mm Qty 1 pcs			
	Part No.	101248	Ref. No.	—
	olive for pipe ø 12mm Qty 1 pcs suitable for PEL			
	Part No.	101249	Ref. No.	—
	olive for pipe ø 10mm Qty 1 pcs			
	Part No.	101250	Ref. No.	—
	union nut thread M20x1.5 for pipe ø 10mm			
	Part No.	101251	Ref. No.	—
	union nut thread M20x1.5 for pipe ø 12mm			
	Part No.	101286	Ref. No.	—
	olive ID ø 6mm Qty 1 pcs			
	Part No.	110080	Ref. No.	—
	knob ø 70mm shaft ø 10x8mm shaft flat universal			
	Part No.	112206	Ref. No.	—
	knob dial plate silver gas tap PEL21/22/23 t.max.°C ED ø 63mm ID ø 45.5mm			

ignition parts



pilot burners

AEM

pilot burners



1

Part No.	102906	Ref. No.	1G564253	
description	pilot burner 1 flame gas connection 6mm mounting thread M5			
accessories for	102906			
	Part No.	106427	Ref. No.	—
	pilot burner nozzle natural/liquid gas bore ø 0.3mm code 30 thread 7/32" (28G) WS 6			
	Part No.	106428	Ref. No.	—
	pilot burner nozzle LPG bore ø 0.25mm code 25 thread 7/32" (28G) WS 6			
	Part No.	106429	Ref. No.	—
	pilot burner nozzle natural gas bore ø 0.35mm thread M5x0.75 WS 6			

producer-specific pilot burners

SALVIS

Combilline series



1

Part No.	107293	Ref. No.	1G820042
description	knurled nut for pilot burner nozzle M10x0.9		



1

Part No.	102902	Ref. No.	178897 1G820051
description	pilot burner 2 flames		





1

Part No.	107292	Ref. No.	1G820043	
description	pilot burner bottom part M10x0.9			
accessories for	107292			
	Part No.	107293	Ref. No.	1G820042 820042
	knurled nut for pilot burner nozzle M10x0.9			

Smartline series



1

Part No.	102906	Ref. No.	1G564253	
description	pilot burner 1 flame gas connection 6mm mounting thread M5			
accessories for	102906			
	Part No.	106427	Ref. No.	—
	pilot burner nozzle natural/liquid gas bore \varnothing 0.3mm code 30 thread 7/32" (28G) WS 6			
	Part No.	106428	Ref. No.	—
	pilot burner nozzle LPG bore \varnothing 0.25mm code 25 thread 7/32" (28G) WS 6			
	Part No.	106429	Ref. No.	—
	pilot burner nozzle natural gas bore \varnothing 0.35mm thread M5x0.75 WS 6			

electrodes

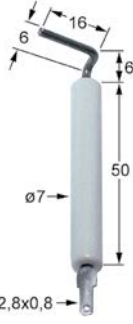

1

Part No.	102907	Ref. No.	1G564251
description	ignition electrode D1 \varnothing 7mm connection F 2.8x0.8mm L1 6mm L2 6mm L3 16mm BL1 50mm to clip		

ignition units

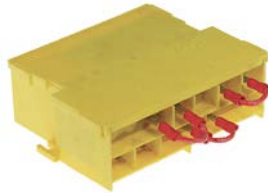

1

Part No.	102908	Ref. No.	1G564254
description	ignition unit outputs 8 1.5 V/DC inlet F6.3x0.8 outlet F2.8x0.8 mounting \varnothing 103mm		

ignition switches



1

Part No.	102909	Ref. No.	1G564255
description	battery holder for battery type AA 1.5V mounting \varnothing 19mm connection male faston 2.8mm		

thermocouples

plug-in thermocouples
 plug-in thermocouples standard
 with barrel socket \varnothing 6mm
 type Junkers with aluminised tip



1

Part No.	102229	Ref. No.	178899
description	thermocouple M10x1 L 1000mm plug connection \varnothing 6.0mm		

with barrel socket $\varnothing 6(6.5)$ mm

thermocouples SIT

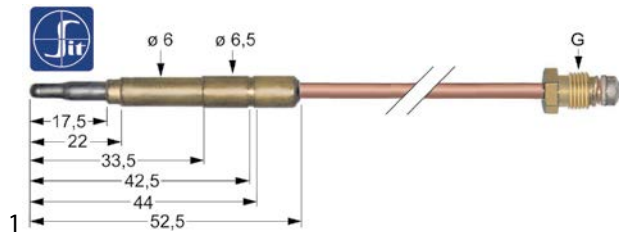

Part No.	107604	Ref. No.	1G564261
description	thermocouple SIT M8x1 L 1200mm plug connection $\varnothing 6.0(6.5)$ mm		

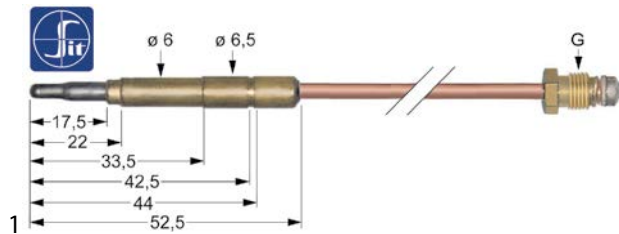

Part No.	107601	Ref. No.	1G564250
description	thermocouple SIT M8x1 L 600mm plug connection $\varnothing 6.0(6.5)$ mm		

accessories

screws



Part No.	100920	Ref. No.	1G820069
description	thermocouple fitting thread M8x1 / M9x1 Qty 1 pcs		

gas burners

hob burners

producer-specific hob burners

FRANKE/SALVIS

Combine series



Part No.	108032	Ref. No.	178908 1G820047
description	burner cap $\varnothing 50$ mm		



Part No.	108010	Ref. No.	178907
description	burner cap $\varnothing 78$ mm		

accessories for	108010			
	Part No.	108003	Ref. No.	178891
	burner head for burner cap $\varnothing 78$ mm seat $\varnothing 35$ mm ID $\varnothing 30$ mm ED $\varnothing 83$ mm			



Part No.	108033	Ref. No.	178890 1G820084
description	burner head for burner cap $\varnothing 50$ mm		



Part No.	108003	Ref. No.	178891
description	burner head for burner cap $\varnothing 78$ mm seat $\varnothing 35$ mm ID $\varnothing 30$ mm ED $\varnothing 83$ mm		

accessories for	108003			
	Part No.	108004	Ref. No.	—
	burner cap $\varnothing 78$ mm 5kW mounting $\varnothing 72$ mm			



Part No.	108034	Ref. No.	178889 1G820013
description	burner lower part $\varnothing 35$ mm for burner cap $\varnothing 50/78$ mm L 100mm		

Smartline series



Part No.	108035	Ref. No.	1G564260 835307
description	burner cap $\varnothing 50$ mm		



Part No.	108038	Ref. No.	1G564259 835293
description	burner cap $\varnothing 78$ mm		

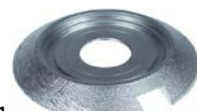

Part No.	108036	Ref. No.	1G564261 835315
description	burner head $\varnothing 111$ mm for burner cap $\varnothing 78$ mm		



1

Part No.	108039	Ref. No.	1G564262 835323
description	burner head ø89mm for burner cap ø50mm		



1

Part No.	108037	Ref. No.	1G564263 835331
description	burner lower part complete		

gas nozzles

pilot burner nozzles

pilot burner nozzles JUNKERS

CB 50203_/503_ series



1

Part No.	100222	Ref. No.	178895 1G820090
description	pilot burner nozzle LPG gas pressure 50mbar code 5 Qty 1 pcs suitable for JUNKERS CB50203_		

equipment-specific units

for convection ovens/combi-steamers

injection pipes



1

Part No.	692838	Ref. No.	1C753793
description	injection pipe for combi-steamer straight ED ø 12mm ID ø 8mm L 180mm -		

glass panels



1

Part No.	691256	Ref. No.	1L295582
description	glass panel L 755mm W 690mm thickness 4mm		

cleaning system

cleaning arms



1

Part No.	542416	Ref. No.	1C775177
description	mounting flange ø55mm hub with gasket for wash arm suitable for ELOMA combi-steamer		

door mechanics

locking mechanism



1

Part No.	692714	Ref. No.	791652
description	disc for catch ø44mm hole ø6x8mm		

knobs

producer-specific knobs

SALVIS



1

Part No.	112040	Ref. No.	178844 1G864061 BK178844
description	knob switch 0-1-0-1 ø55mm shaft ø6x4.6mm shaft flat upper black		



1

Part No.	112052	Ref. No.	278457 688940 946.273
description	knob switch zero mark t.max.°C temperature range°C ø 54mm shaft ø 6x4.6mm shaft flat upper black		



1

Part No.	112038	Ref. No.	179305 1G594095
description	knob thermostat 1-6 ø 54mm shaft ø 6x4.6mm shaft flat upper		



1

Part No.	112041	Ref. No.	178838 1G864059 BK178838
description	knob thermostat Min/Max ø 55mm shaft ø 6x4.6mm shaft flat upper		



1

Part No.	111967	Ref. No.	178856 1G864058
description	knob thermostat t.max. 300°C temperature range 50-300°C ø 54mm shaft ø 6x4.6mm shaft flat lower black		



1

Part No.	112039	Ref. No.	179314 1G594074
description	knob thermostat t.max. 300°C temperature range 50-300°C ø 55mm shaft ø 6x4.6mm shaft flat upper rotation 270° black		



1

Part No.	112060	Ref. No.	1G914236
description	knob switch zero mark ø 52mm shaft ø 6x4.6mm shaft flat upper black		



1

Part No.	112061	Ref. No.	1G534227 1G534514
description	knob dial plate 1-10		

locks

edgemount latches

handle latches

RAHRBACH

6188 ERGO series

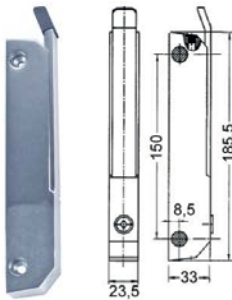

1

Part No.	690808	Ref. No.	1C565458
description	handle latch L 185mm mounting distance 150mm chrome-plated non lockable for headed units 6188 type ERGO		

accessories for 690808

	Part No.	690110	Ref. No.	—
	base plate H 1mm L 38mm W 11mm mounting distance 26mm plastic			

	Part No.	690111	Ref. No.	—
	base plate H 2mm L 38mm W 11mm mounting distance 26mm plastic			

	Part No.	690114	Ref. No.	—
	base plate H 3.5mm L 185mm W 30mm mounting distance 150mm with inclination thread M5			

	Part No.	700082	Ref. No.	—
	door catch L 38mm W 18mm mounting distance 26mm			

pullouts

frame



1

Part No.	695464	Ref. No.	1V421650
description	frame for pullout size 1/1 L 660mm		



1

Part No.		Ref. No.	1V421651
description	frame fortelescopic rail size 1/1 L 660mm capacity 120kg		



1

Part No.		Ref. No.	1V421653
description	frame fortelescopic rail size 2/1 L 760mm capacity 120kg		



1

Part No.		Ref. No.	1V421652
description	frame fortelescopic rail size 2/1 L 760mm capacity 70kg		

rails

Part No.		Ref. No.	1V421658
description	rail L 660mm size 1/1 fortelescopic rail capacity 120kg		

Part No.	695466	Ref. No.	1V421682
description	rail L 660mm size 1/1 fortelescopic rail capacity 70kg		

Part No.		Ref. No.	1V421659
description	rail L 760mm size 2/1 fortelescopic rail capacity 120kg		

Part No.		Ref. No.	1V421683
description	rail L 760mm size 2/1 fortelescopic rail capacity 70kg		

drawer slides

producer-specific

Part No.		Ref. No.	1V421655
description	pullout size 1/1 L 660mm capacity 120kg		

Part No.	695465	Ref. No.	1V421654
description	pullout size 1/1 L 660mm capacity 70kg		



1

Part No.		Ref. No.	1V421657
description	pullout size 2/1 L 760mm capacity 120kg		

1

Part No.		Ref. No.	1V421656
description	pullout size 2/1 L 760mm capacity 70kg		

baskets

fryer baskets

SALVIS



1

Part No.	970493	Ref. No.	178618 178862 BI371740 CA50006
description	fryer basket L1 260mm W1 220mm H1 105mm		

shelves and shelf rails

grates

universal

without upstand



1

Part No.	970122	Ref. No.	BI177994
description	grate W 325mm D 530mm GN 1/1 H 8mm stainless steel wire gauge frame 7mm lengthwise wires gauge 4mm crossing wires 1		
accessories for	970122		
	Part No.	690330	Ref. No. —
	rack L 1000mm W 22mm H 4mm aperture 3x8mm hole distance 12.5mm stainless steel		
	Part No.	694700	Ref. No. —
	shelf support L 31/28mm W 22mm H 18mm SS Qty 12 pcs		
	Part No.	694701	Ref. No. —
	shelf support L 31/28mm W 22mm H 17mm SS with hook Qty 12 pcs		

gaskets

refrigeration gaskets

plug-in gaskets

profile 9162

Salvis series 1999

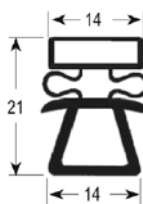

1

Part No.	900640	Ref. No.	1V420000
description	refrigeration gasket profile 9162 W 385mm L 184mm external size		

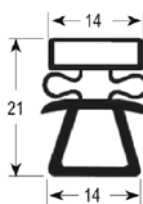

1

Part No.	900641	Ref. No.	1V420001
description	refrigeration gasket profile 9162 W 385mm L 206mm external size		

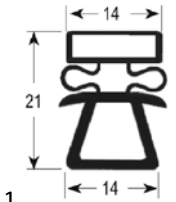

Part No.	900642	Ref. No.	1V420002
description	refrigeration gasket profile 9162 W 385mm L 229mm external size		

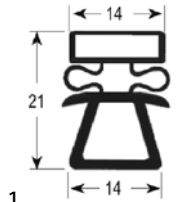

Part No.	900648	Ref. No.	1V420008
description	refrigeration gasket profile 9162 W 385mm L 651mm external size		

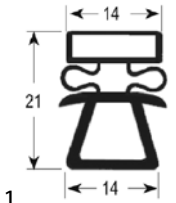

Part No.	900643	Ref. No.	1V420003
description	refrigeration gasket profile 9162 W 385mm L 314mm external size		

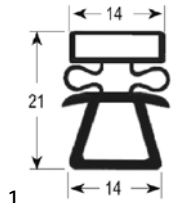

Part No.	900649	Ref. No.	1V420009
description	refrigeration gasket profile 9162 W 385mm L 781mm external size		

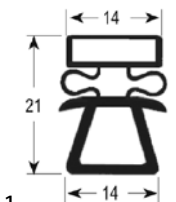

Part No.	900644	Ref. No.	1V420004
description	refrigeration gasket profile 9162 W 385mm L 321mm external size		

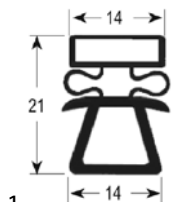

Part No.	900650	Ref. No.	1V420010
description	refrigeration gasket profile 9162 W 585mm L 184mm external size		

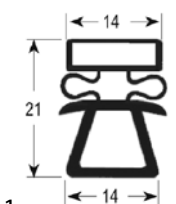

Part No.	900645	Ref. No.	1V420005
description	refrigeration gasket profile 9162 W 385mm L 359mm external size		

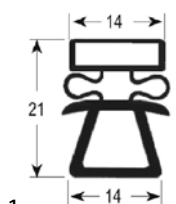

Part No.	900651	Ref. No.	1V420011
description	refrigeration gasket profile 9162 W 585mm L 206mm external size		

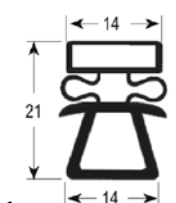

Part No.	900647	Ref. No.	1V420007
description	refrigeration gasket profile 9162 W 385mm L 451mm external size		

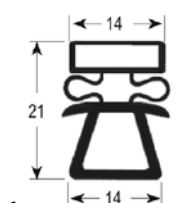

Part No.	900652	Ref. No.	1V420012
description	refrigeration gasket profile 9162 W 585mm L 229mm external size		

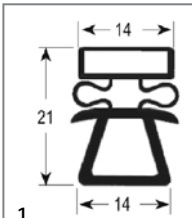

Part No.	900653	Ref. No.	1V420013
description	refrigeration gasket profile 9162 W 585mm L 314mm external size		

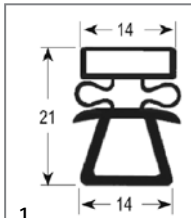

Part No.	900658	Ref. No.	1V420018
description	refrigeration gasket profile 9162 W 585mm L 651mm external size		

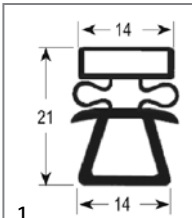

Part No.	900654	Ref. No.	1V420014
description	refrigeration gasket profile 9162 W 585mm L 321mm external size		

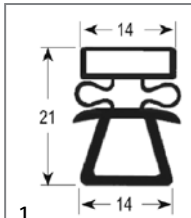

Part No.	900659	Ref. No.	1V420019
description	refrigeration gasket profile 9162 W 585mm L 781mm external size		

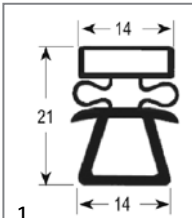

Part No.	900655	Ref. No.	1V420015
description	refrigeration gasket profile 9162 W 585mm L 359mm external size		

Salvis series 2000



Part No.	900660	Ref. No.	1V421560
description	refrigeration gasket profile 9162 W 385mm L 185mm external size		

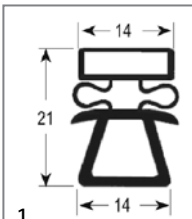

Part No.	900656	Ref. No.	1V420016
description	refrigeration gasket profile 9162 W 585mm L 406mm external size		

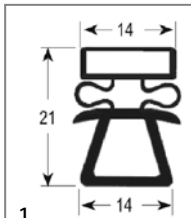

Part No.	900661	Ref. No.	1V421561
description	refrigeration gasket profile 9162 W 385mm L 206mm external size		

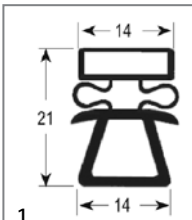

Part No.	900657	Ref. No.	1V420017
description	refrigeration gasket profile 9162 W 585mm L 451mm external size		

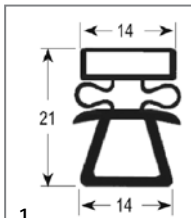

Part No.	900662	Ref. No.	1V421562
description	refrigeration gasket profile 9162 W 385mm L 224mm external size		

Part No.	900663	Ref. No.	1V421563
description	refrigeration gasket profile 9162 W 385mm L 309mm external size		

Part No.	900668	Ref. No.	1V421568
description	refrigeration gasket profile 9162 W 385mm L 445mm external size		

Part No.	900664	Ref. No.	1V421564
description	refrigeration gasket profile 9162 W 385mm L 318mm external size		

Part No.	900669	Ref. No.	1V421569
description	refrigeration gasket profile 9162 W 385mm L 642mm external size		

Part No.	900665	Ref. No.	1V421565
description	refrigeration gasket profile 9162 W 385mm L 320mm external size		

Part No.	900670	Ref. No.	1V421570
description	refrigeration gasket profile 9162 W 385mm L 772mm external size		

Part No.	900666	Ref. No.	1V421566
description	refrigeration gasket profile 9162 W 385mm L 354mm external size		

Part No.	900671	Ref. No.	1V421580
description	refrigeration gasket profile 9162 W 585mm L 188mm external size		

Part No.	900667	Ref. No.	1V421567
description	refrigeration gasket profile 9162 W 385mm L 405mm external size		

Part No.	900672	Ref. No.	1V421581
description	refrigeration gasket profile 9162 W 585mm L 206mm external size		

Part No.	900673	Ref. No.	1V421582
description	refrigeration gasket profile 9162 W 585mm L 224mm external size		

Part No.	900678	Ref. No.	1V421587
description	refrigeration gasket profile 9162 W 585mm L 406mm external size		

Part No.	900674	Ref. No.	1V421583
description	refrigeration gasket profile 9162 W 585mm L 309mm external size		

Part No.	900679	Ref. No.	1V421588
description	refrigeration gasket profile 9162 W 585mm L 442mm external size		

Part No.	900675	Ref. No.	1V421584
description	refrigeration gasket profile 9162 W 585mm L 318mm external size		

Part No.	900680	Ref. No.	1V421589
description	refrigeration gasket profile 9162 W 585mm L 642mm external size		

Part No.	900676	Ref. No.	1V421585
description	refrigeration gasket profile 9162 W 585mm L 321mm external size		

Part No.	900681	Ref. No.	1V421590
description	refrigeration gasket profile 9162 W 585mm L 772mm external size		

Part No.	900677	Ref. No.	1V421586
description	refrigeration gasket profile 9162 W 585mm L 354mm external size		

gaskets for heated units

door seals

Part No.	900100	Ref. No.	1L295594 384410
description	door seal profile 2070 W 460mm L 645mm external size Qty 1 6 x 1/1		

Part No.	900101	Ref. No.	1L295593 382310
description	door seal profile 2070 W 645mm L 700mm external size Qty 1 10 x 1/1		

Part No.	900497	Ref. No.	1C742376
description	door seal profile 2449 W 520mm L 775mm Qty 1		

springs

torsion springs

Part No.	692911	Ref. No.	791520
description	torsion spring ø 27mm wire gauge ø 2.3mm mounting pos. door handle L1 11mm Qty 1 pcs		

fastening material

nuts

hexagonal nuts

hexagonal nuts metric (without norm)



Part No.	101860	Ref. No.	1G820049
description	nut thread M10x1 H 4mm WS 14 chrome-plated brass Qty 1 pcs		

consumables

fuses

thermal fuses



Part No.	358298	Ref. No.	1V421473
description	thermal fuse switch-off temp. 128°C nominal 10A		

GASTROPARTS.COM

