



GASTROPARTS

Royal

- [EN]** Equipment
- [DE]** Geräte
- [ES]** Aparatos
- [FR]** Équipement
- [IT]** Attrezzature
- [PL]** Urządzenia
- [RU]** Оборудование

✉ gastroparts@gastroparts.com

☎ tel. +48 56 657 00 66

📘 fb.com/gastroparts.global

GASTROPARTS.COM







heating elements

heating elements for coffee machine



1

Part No.	417277	Ref. No.	5050009
description	heating element 1300W 220V heating circuits 1 thread 1¼" L 97mm W 26mm H 26mm tube ø 6.5mm connection M4 immersion heater flange with thread WS 37		
accessories for	417277		
	Part No.	Ref. No.	2001010
	flat gasket PTFE ED ø 57mm ID ø 42mm thickness 3mm Qty 1 pcs equiv. no. 12001/W10470 suitable for		



1

Part No.	417276	Ref. No.	5050100
description	heating element 2000W 230V heating circuits 1 thread 1¼" L 145mm W 26mm H 28mm tube ø 8.3mm connection M4 immersion heater flange with thread WS 37		



1

Part No.	417273	Ref. No.	5050710
description	heating element 2400W 230V heating circuits 2 mounting ø 42mm hole distance 74mm L 210mm W 35mm H 27mm hole ø 9.5mm thermostat sleeves ø 7mm length thermostat sleeves 195mm number of thermostat sleeves 1 thermostat sleeve bottom/centre tube ø 8.3mm connection M6 immersion heater 2 hole flange		



1

Part No.	417275	Ref. No.	5050205
description	heating element 2500W 230V heating circuits 2 thread 1¼" L 285mm W 35mm H 24mm tube ø 8.3mm thermostat sleeves ø 7mm length thermostat sleeves 160mm number of thermostat sleeves 1 thermostat sleeve centre connection M6 immersion heater connection length 30mm flange with thread WS 37		



1

Part No.	417274	Ref. No.	5050220
description	heating element 3300W 230V heating circuits 2 thread 1¼" L 370mm W 35mm H 24mm tube ø 8.3mm thermostat sleeves ø 7mm length thermostat sleeves 160mm number of thermostat sleeves 1 thermostat sleeve centre connection M6 immersion heater flange with thread WS 37		



1

Part No.	417272	Ref. No.	5050720 5050720+2001010
description	heating element 3500W 230V heating circuits 2 mounting ø 42mm hole distance 74mm L 335mm W 35mm H 60mm L1 25mm L2 60mm L3 250mm H1 27mm H2 23mm hole ø 9.5mm tube ø 8.3mm thermostat sleeves ø 7mm length thermostat sleeves 195mm thermostat sleeve centre number of thermostat sleeves 1 connection M6 immersion heater 2 hole flange		



1

Part No.	417270	Ref. No.	5050230
description	heating element 4000W 230V heating circuits 2 thread 1¼" L 495mm W 35mm H 22mm tube ø 8.3mm thermostat sleeves ø 7mm length thermostat sleeves 160mm number of thermostat sleeves 1 thermostat sleeve centre connection M6 immersion heater flange with thread		



1

Part No.	417271	Ref. No.	5050730
description	heating element 5250-6250W 220-240V heating circuits 2 mounting ø 42mm hole distance 74mm L 515mm W 35mm H 60mm L1 25mm L2 60mm L3 430mm H1 27mm H2 23mm hole ø 9.5mm tube ø 8.3mm thermostat sleeves ø 7mm length thermostat sleeves 195mm thermostat sleeve centre number of thermostat sleeves 1 connection M6 immersion heater 2 hole flange		



1

Part No.	417269	Ref. No.	5050740
description	heating element 5500W 230V heating circuits 2 mounting ø 42mm hole distance 74mm L 655mm W 35mm H 50mm L1 25mm L2 60mm L3 570mm H1 27mm H2 23mm hole ø 9.5mm tube ø 8.3mm thermostat sleeves ø 7mm length thermostat sleeves 195mm number of thermostat sleeves 1 connection 2 immersion heater 2 hole flange		

accessories

sealing washers

PTFE gaskets

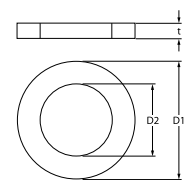
1

Part No.	528022	Ref. No.	2001001
description	flat gasket PTFE ED ø 52mm ID ø 41mm thickness 2mm size 1¼" Qty 1 pcs suitable for CARIMALI, FAEMA, MARZOCCO, PAVONI		

1

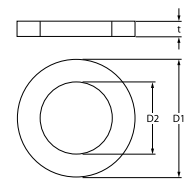
Part No.	528002	Ref. No.	2001010
description	flat gasket PTFE ED ø 57mm ID ø 42mm thickness 3mm Qty 1 pcs equiv. no. 12001/W10470 suitable for		



thermostats

bi-metal thermostats

safety bi-metal thermostats



Part No.	390690	Ref. No.	5013030
description	bi-metal thermostat switch-off temp. 200°C 1NC 1-pole 10A connection F6.3 thread M4 mounting ø 16mm		

bi-metal thermostats



Part No.	390323	Ref. No.	5013025
description	bi-metal thermostat hole distance mm switch-off temp. 145°C 1NC 1-pole 16A connection F6.3 M4		

control and safety thermostats

PRODIGY / FIRT

control thermostats

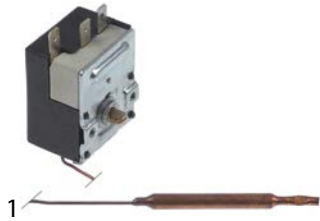

Part No.	390691	Ref. No.	5013010
description	thermostat t.max. 180°C 1-pole 1CO 16A probe ø 6mm probe L 70mm capillary pipe 360mm shaft ø 6x4.6mm shaft L 6mm shaft position upper rotation 270°		

various

safety thermostats



Part No.	375494	Ref. No.	5013005
description	safety thermostat switch-off temp. 155°C 2-pole 2NC 20A probe ø 6mm probe L 92mm capillary pipe 980mm capillary pipe isolated 500mm		

switches and momentary switches

rocker/momentary rocker switches

30x22mm



Part No.	347207	Ref. No.	5003240
description	rocker switch mounting measurements 30x22mm white 2NO 250V 20A illuminated 0-I connection male faston 6.3mm ambient temperature max. 120/55°C protection IP65 with rubber collar		



Part No.	301001	Ref. No.	5003080
description	rocker switch mounting measurements 30x22mm red 2NO 250V 16A illuminated 0-I connection male faston 6.3mm ambient temperature max. 125/55°C protection IP65		

accessories for	301001			
	Part No.	301036	Ref. No.	—
	protective cover internal size 30x22mm for rocker switch mounting measurements mm			



Part No.	347318	Ref. No.	5003010(Vapore)
description	momentary rocker switch mounting measurements 30x22mm red 2NO 250V 16A steam connection male faston 6.3mm ambient temperature max. 125/55°C protection IP40		



Part No.	346049	Ref. No.	5003040
description	rocker switch mounting measurements 30x22mm red 2NO 250V 16A illuminated cup connection male faston 6.3mm ambient temperature max. 125/55°C protection IP40		

push/momentary push switches

20.6x16.4mm



Part No.	347205	Ref. No.	5003035
description	push switch mounting measurements 20.6x16.4mm chrome 2NO 250V 16A connection male faston 6.3mm ambient temperature max. 85°C protection IP40		



28.5x28.5mm

			
1			
Part No.	345142	Ref. No.	5003230
description	push switch mounting measurements 28.5x28.5mm red/green 2NO 250V 16A connection male faston 6.3mm ambient temperature max. 150°C protection IP40 with indicator		

			
1			
Part No.	347206	Ref. No.	5003235
description	push switch mounting measurements 28.5x28.5mm grey 2NO 250V 16A with indicator connection male faston 6.3mm ambient temperature max. 85°C mounting ø 24mm		

ø25mm



			
1			
Part No.	345160 ¹	Ref. No.	5003210
description	push switch mounting ø 25mm red 2NO 250V 16A illuminated connection male faston 6.3mm ambient temperature max. 85°C protection IP40		

¹illuminated

toggle switches

M12x0.75

			
1			
Part No.	346520	Ref. No.	5003100
description	toggle switch thread M12x0.75 2CO 250V 15A ON-OFF-ON male faston 6.3mm with neutral position t.max. 85/55°C		

				
1				
Part No.	346519	Ref. No.	5003045	
description	toggle switch thread M12x0.75 2NO 250V 15A ON-OFF male faston 6.3mm			
accessories for	346519			
	Part No.	346525	Ref. No.	—
	protection cap L 23.5mm W 17.3mm protection cap rubber thread M11			
	Part No.	347197	Ref. No.	—
	bezel ON-OFF for toggle switch M12			

microswitches

pin-plunger actuated

			
1			
Part No.	347211	Ref. No.	5003301
description	microswitch with plunger thread M10x0.75 250V 16A 1CO connection male faston 6.3mm ambient temperature max. 125°C		

			
1			
Part No.	345325	Ref. No.	5003301
description	microswitch with plunger thread M10x0.75 thread L 14mm 250V 10A 1CO connection male faston 6.3mm stroke 7.5mm mounting distance 22mm L 28mm ambient temperature max. 125°C type NR6K5 actuating force: 260g		

roller actuated

			
1			
Part No.	345639	Ref. No.	5003310
description	microswitch with roller plunger 230V 16A 1CO connection solder/screw connection L1 49mm ambient temperature max. 125°C thread L 14mm thread M10 mounting distance 25mm actuating force: 300g type MS15-1		

rotary switches

BREMAS

A1700 series

			
1			
Part No.	347198 ¹	Ref. No.	5005105
description	rotary switch 2 0-1 sets of contacts 4 type CA0200004V 400V 20A shaft ø 5x5mm shaft L 19mm shaft square connection screw		

¹incl. rubber protective sleeve

			
1			
Part No.	346100	Ref. No.	5005035
description	rotary switch 3 1-0-2 sets of contacts 8 type CS0177412 400V 20A shaft ø 5x5mm shaft L 21mm shaft square connection screw		



A2500 series



1

Part No.	346101	Ref. No.	5005040
description	rotary switch 3 1-0-2 sets of contacts 8 type CS0257412 600V 32A shaft ø 5x5mm shaft L 21mm shaft square connection screw		

KRAUS & NAIMER

rotary switches



1

Part No.	347209 ¹	Ref. No.	5005020 5005025
description	rotary switch 3 0-1-2 sets of contacts 6 type CA20-ATX12X018 400V 25A shaft ø 22.5mm connection screw code 97/000400 marking I-3461*06		

accessories for 347209



Part No.	347214	Ref. No.	5005200
description	knob shaft ø 6mm shaft L 20mm complete mounting ø 22mm lever length 35mm		



Part No.	347215	Ref. No.	5005210
description	knob complete 2 shaft ø 6mm shaft L 20mm complete L 48mm mounting ø 22mm W 48mm mounting distance 36mm		

¹incl. collar

1

Part No.	347210	Ref. No.	5005028
description	rotary switch sets of contacts 6 type CA25-AT09X016 490V 30A connection screw code I-3461*05		

accessories for 347210



Part No.	347214	Ref. No.	5005200
description	knob shaft ø 6mm shaft L 20mm complete mounting ø 22mm lever length 35mm		



Part No.	347215	Ref. No.	5005210
description	knob complete 2 shaft ø 6mm shaft L 20mm complete L 48mm mounting ø 22mm W 48mm mounting distance 36mm		

accessories



1

Part No.	347215	Ref. No.	5005210
description	knob complete 2 shaft ø 6mm shaft L 20mm complete L 48mm mounting ø 22mm W 48mm mounting distance 36mm		



1

Part No.	347214	Ref. No.	5005200
description	knob shaft ø 6mm shaft L 20mm complete mounting ø 22mm lever length 35mm		

lamps

indicator lights

indicator lights (complete)

ø10mm

with screw socket



1

Part No.	359476	Ref. No.	5010030
description	indicator light ø 10mm 110/250V red connection male faston 6.3mm		



1

Part No.	359475	Ref. No.	5010003
description	indicator light ø 10mm 125V green connection male faston 6.3mm		

ø16mm

with plug-in socket



1

Part No.	359474	Ref. No.	5010006
description	indicator light ø 16mm 230V green connection male faston 6.3mm		

spare parts for 359474



Part No.	345601	Ref. No.	—
description	indicator lamp holder V ø 11mm		









Part No.	359132	Ref. No.	—
description	indicator lamp green 250V connection male faston 6.3mm protection IP54 ambient temperature max. 85°C		



Part No.	359247	Ref. No.	—
description	indicator light lens ø 12.2mm green		



 <p>1</p>			
Part No.	359472	Ref. No.	5010036
description	indicator light ø 16mm 230V red connection male faston 6.3mm		
spare parts for	359472		
	Part No.	345601	Ref. No. —
	indicator lamp holder V ø 11mm		
	Part No.	359130	Ref. No. —
	indicator lamp 230V clear connection male faston 6.3mm ø 8mm		
	Part No.	359245	Ref. No. —
	indicator light lens ø 12.2mm red		

 <p>1</p>			
Part No.	359473	Ref. No.	5010033
description	indicator light ø 16mm 230V yellow connection male faston 6.3mm		
spare parts for	359473		
	Part No.	345601	Ref. No. —
	indicator lamp holder V ø 11mm		
	Part No.	359130	Ref. No. —
	indicator lamp 230V clear connection male faston 6.3mm ø 8mm		

solid state relays

miscellaneous

 <p>1</p>			
Part No.	403541	Ref. No.	5012005
description	solid state relay GEFRAN 1 phase 50A 480V 3-32VDC L 58mm W 45mm screw type GQ-50-48-D-1-3		

relays

level relays

GICAR

 <p>1</p>			
Part No.	402103	Ref. No.	5030363
description	level controller 230/240V voltage AC 50/60Hz connection F6.3 type NRL30/1E-2C/F		

 <p>1</p>			
Part No.	402234	Ref. No.	5030320
description	level controller 230V voltage AC connection F6.3 type RL30/3ES/F/G		

electronics

PCBs

 <p>1</p>			
Part No.	402235	Ref. No.	5029103
description	display L 117mm W 45mm		

 <p>1</p>			
Part No.	402246	Ref. No.	5029110
description	display L 135mm W 44mm		



			
1			
Part No.	402259	Ref. No.	5029105
description	display L 135mm W 44mm		

central units

			
1			
Part No.	402261	Ref. No.	5030010
description	central unit 230V 50/60Hz 5/10A type 30μZ R/E voltage AC		

			
1			
Part No.	402245	Ref. No.	5030011 old version
description	central unit 230V 50/60Hz type 30μZ R/E		

			
1			
Part No.	403926	Ref. No.	5030011
description	central unit kit 230V 50/60Hz		

			
1			
Part No.	402233	Ref. No.	5030110
description	control box 1-group for coffee machine 230V manual type DOS MAN 1GR NO TEA		

			
1			
Part No.	402232	Ref. No.	5030115
description	control box 2-group for coffee machine 230V manual type DOS MAN 2GR NO TEA		

			
1			
Part No.	402241	Ref. No.	5030100
description	control box 3-group for coffee machine 230V type 3d5 MAESTRO DELUXE 6T		

dosing electronics

GICAR

			
1			
Part No.	402262	Ref. No.	5030120
description	dosing electronics 2-group 230V 50/60Hz 2.1A type DELUXE		

			
1			
Part No.	402231	Ref. No.	5030080
description	dosing electronics 3-group 230V voltage AC 50/60Hz type 3d5 3GRCTZ XLC (SC) DPG 96 C		



keypads

keypad units



1

Part No.	402260	Ref. No.	5031380 5031410
description	keypad unit buttons 1 white L 35mm W 26mm		



1

Part No.	402238	Ref. No.	5031340
description	keypad unit buttons 4 L 135mm W 44mm		



1

Part No.	402239	Ref. No.	5031350
description	keypad unit buttons 6 L 135mm W 44mm		



1

Part No.	402240	Ref. No.	5031333
description	keypad unit buttons 6 L 135mm W 44mm with holder		



1

Part No.	402244	Ref. No.	5031011
description	keypad unit buttons 6 L 88mm W 60mm		



1

Part No.	402236	Ref. No.	5031015
description	keypad unit coffee machine buttons 5 L 88mm W 60mm		



1

Part No.	402237	Ref. No.	5031210
description	keypad unit coffee machine Classica/Diadema 2-3-4 gr. buttons 2 L 88mm W 60mm		



1

Part No.	402258	Ref. No.	5031305
description	keypad unit espresso machine DeLux/Imola/Marenello/Monza 2-3-4 gr. buttons 6 L 135mm W 44mm		



1

Part No.	402257	Ref. No.	5031280 5301280
description	keypad unit espresso machine Lira 1-2-3-4 gr. buttons 6 L 135mm W 44mm		



solenoid valves

solenoid valves (water)

metal

LUCIFER

spare parts and accessories

valve bodies



1

Part No.	370061	Ref. No.	BFC01 BFC02
description	solenoid valve body LUCIFER-PARKER 3-ways outer cone		



ODE

solenoid valves steam (water)

21A1 series



1

Part No.	370093	Ref. No.	5020115
description	solenoid valve 2/2-ways 230VAC body 25-F39 DN 2.5mm slide-on receptacle DIN -10 up to 140°C ODE type series 21A1 coil type BDA membranes FKM p max 14bar 50/60Hz silicone flange 32x32mm		
spare parts for	370093		
	Part No.	371150	Ref. No. —
	solenoid coil ODE 230VAC 16VA coil type BDV seat ø 13.5mm 750Ohm		
accessories for	370093		
	Part No.	371090	Ref. No. —
	power socket plug type DIN 43650A screw		

31A1 series



1

Part No.	370572	Ref. No.	5020055
description	solenoid valve brass 3-ways 230VAC DN 1.5mm -10 up to 140°C coil type ADA membranes ruby p max 15bar p min 0bar flange 32x32mm		







PARKER

spare parts and accessories

valve bodies



1

Part No.	370062	Ref. No.	BFC01 BFC02
description	solenoid valve body PARKER 3-ways outer cone		
accessories for	370062		
	Part No.	371029	Ref. No. —
	solenoid coil PARKER 230VAC 9VA coil type ZB09 seat ø 14mm H 33mm W 34mm D 43mm		
	Part No.	371030	Ref. No. —
	solenoid coil 24VDC 12VA coil type ZB12 seat ø 14mm		
	Part No.	371033	Ref. No. —
	solenoid coil PARKER 230VAC 9VA coil type YB09 with cable seat ø 14mm		
	Part No.	371036	Ref. No. —
	solenoid coil 24VAC 9VA coil type ZB09 seat ø 14mm		
	Part No.	371095	Ref. No. —
	O-ring Viton thickness 1.78mm ID ø 6.07mm Qty 1 pcs		
	Part No.	371100	Ref. No. —
	O-ring silicone thickness 1.78mm ID ø 6.07mm Qty 1 pcs		

pressure switches

for coffee machines

miscellaneous



1

Part No.	541690	Ref. No.	5006070
description	pressure control pressure range 1.1bar connection 1/4" 16A 1-pole type 250V pressure connection 1/4"		

electrodes



1

Part No.	401365	Ref. No.	4550005
description	level electrode 1/4" total length 172mm probe L 145mm insulated probe length 26mm connection male faston 6.3mm stainless steel ø 2.5mm		



equipment-specific units

for espresso machines

filter holders

filter holders standard

filter holder without spout



1

Part No.	525975	Ref. No.	N/A
description	filter holder suitable for BFC/ROYAL1 without outlet mounting \varnothing 83mm outlet 3/8" ID \varnothing 62mm wedge height 10mm wedge position horizontal number of wedges 2 lever inclined		



1

Part No.	525976	Ref. No.	N/A
description	filter holder suitable for BFC/ROYAL1/RANCILIO without outlet mounting \varnothing 82mm outlet 3/8" ID \varnothing 62mm wedge height 10mm wedge position horizontal number of wedges 2 lever straight		

filter holders short



1

Part No.	526528	Ref. No.	4650100
description	filter holder mounting \varnothing 82mm outlet 3/8" ID \varnothing 62mm handle M12x1.75 wedge height 10mm wedge position horizontal number of wedges 2 lever straight chrome-plated brass		



1

Part No.	529050	Ref. No.	4650100
description	filter holder mounting \varnothing 82mm outlet 3/8" ID \varnothing 62mm handle M12x1.75 wedge height 10mm wedge position horizontal number of wedges 2 lever straight chrome-plated brass		
accessories for	529050		
	Part No.	529045	Ref. No.
			—
	handle \varnothing 35mm thread M12x1.75 thread L 15mm L 125mm black		



1

Part No.	526527	Ref. No.	4650108
description	filter holder mounting \varnothing 83mm outlet 3/8" ID \varnothing 62mm handle M12x1.75 wedge height 10mm wedge position horizontal number of wedges 2 lever inclined chrome-plated brass		

filters

for 1 cup



1

Part No.	527631	Ref. No.	N/A
description	coffee filter \varnothing 70mm mounting \varnothing 60.7mm H 17mm cups 1 amount of coffee 8g		



1

Part No.	529011	Ref. No.	4630051
description	coffee filter \varnothing 70mm mounting \varnothing 60mm H 24.5mm cups 1 amount of coffee 7g perforation \varnothing 0.4mm		

for 2 cups



1

Part No.	529076	Ref. No.	4630052
description	coffee filter \varnothing 70mm mounting \varnothing 60.8mm H 24.5mm cups 2 amount of coffee 14g ECONOMY		

blind filters



1

Part No.	529023	Ref. No.	4630100
description	blind filter \varnothing 70mm mounting \varnothing 60mm H 18mm		



brewing units

shower screens

flat

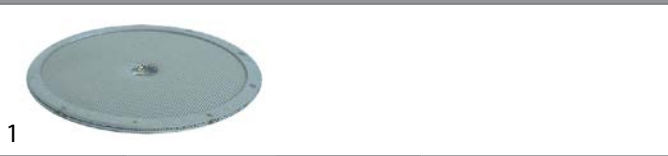

1

Part No.	529084	Ref. No.	4630033
-----------------	--------	-----------------	---------

description	shower screen \varnothing 52mm hole \varnothing 6.4mm		
--------------------	---	--	--

with upstand



1

Part No.	528417	Ref. No.	0520080
-----------------	--------	-----------------	---------

description	shower screen \varnothing 58mm H 19mm		
--------------------	---	--	--

filter holder gaskets

flat

with internal notch



1

Part No.	527986	Ref. No.	0520090
-----------------	--------	-----------------	---------

description	filter holder gasket D1 \varnothing 73.5mm D2 \varnothing 57.5mm H 8.5mm with inside notch Qty 1 pcs		
--------------------	--	--	--



1

Part No.	527987	Ref. No.	2002310
-----------------	--------	-----------------	---------

description	filter holder gasket D1 \varnothing 73.5mm D2 \varnothing 57.5mm H 8mm with inside notch Qty 1 pcs		
--------------------	--	--	--

brewing units with solenoid valve

components

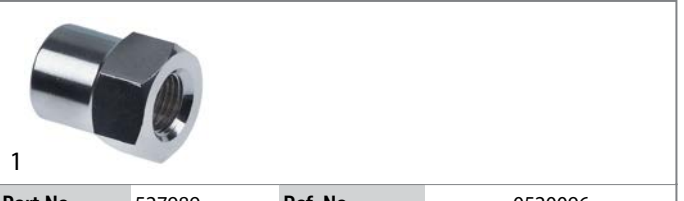

1

Part No.	527989	Ref. No.	0520096
-----------------	--------	-----------------	---------

description	drain pipe \varnothing 20mm ID \varnothing 16.5mm L 28mm T1: 1/4" chrome-plated brass		
--------------------	---	--	--

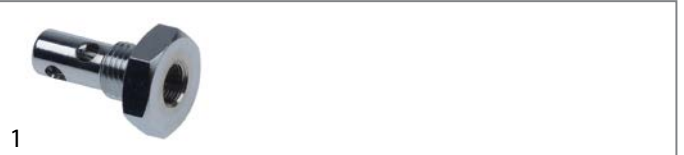

1

Part No.	527988	Ref. No.	0520095
-----------------	--------	-----------------	---------

description	tap aerator M10x1 L 35mm WS 22		
--------------------	--------------------------------	--	--

brewing units manual

components

drain units

drain pipes

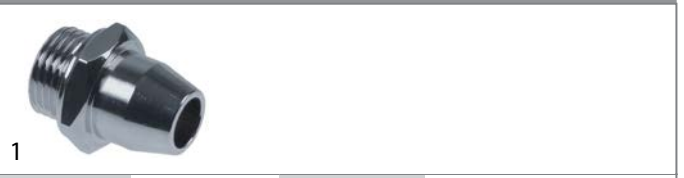

1

Part No.	527931	Ref. No.	0530060
-----------------	--------	-----------------	---------

description	drain pipe thread 1/2" int. \varnothing 1 11.5mm int. \varnothing 2 15mm L 35.5mm WS 26		
--------------------	---	--	--

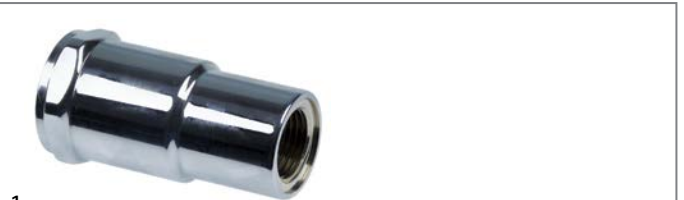

1

Part No.	527937	Ref. No.	0530040
-----------------	--------	-----------------	---------

description	drain pipe thread 1/2" T1: M30x1.5 L 72mm WS 36		
--------------------	---	--	--



1

Part No.	528538	Ref. No.	0530060
-----------------	--------	-----------------	---------

description	end piece thread 1/2" int. \varnothing 1 12mm int. \varnothing 2 15mm L 36mm chrome-plated brass WS 26		
--------------------	--	--	--



drain valves



1			
Part No.	527936	Ref. No.	0530043
description	valve ED ø 16mm H 27mm		



1			
Part No.	526002	Ref. No.	0530043
description	valve support ø 16mm L 27mm brass shaft triangular D1 ø 10mm D2 ø 7mm		

tap aerators



1			
Part No.	527932	Ref. No.	0530047
description	tap aerator D1 ø 8mm D2 ø 15mm ID ø 6mm H 6mm brass		

gaskets



1			
Part No.	529795	Ref. No.	0510140 0541070
description	gasket D1 ø 13mm D2 ø 4mm thickness 4mm coffee machine		



1			
Part No.	527945	Ref. No.	0530080
description	gasket ED ø 16mm ID ø 8mm H 4mm for lever		

nozzle holders



1			
Part No.	527949	Ref. No.	0520030
description	nozzle holder thread M30x1.5 IT M16x1.5 IT 1 M6 ø 25.5mm int. ø 15mm int. ø 2 17mm L 66mm total length 80mm WS 36 chrome-plated brass		

springs



1			
Part No.	527933	Ref. No.	0530045
description	compression spring ø 14.2mm L 21mm wire gauge ø 1.8mm SS		



1			
Part No.	527934	Ref. No.	0530030
description	compression spring ø 14.2mm L 45mm wire gauge ø 1.5mm SS		



1			
Part No.	527935	Ref. No.	0530095
description	compression spring ø 14.6mm L 33mm wire gauge ø 2mm		

levers

levers



1			
Part No.	527943	Ref. No.	0530110
description	lever L 70mm thread M8 shaft diameter 6x6mm		

camshafts



1			
Part No.	527940	Ref. No.	0530070
description	camshaft shaft ø 8mm shaft intake ø 6.2mm L 86.5mm W 20mm H 17mm thread M6 brass		

valves





1			
Part No.	526008	Ref. No.	0530001
description	valve group outflow L 54.3mm ED ø 16mm shaft ø 4.5mm brass		
accessories for	526008		

	Part No.	526003	Ref. No.	—
	compression spring ø 13.8mm L 54.5mm wire gauge ø 1.5mm windings 10 drain valve			

Table continues overleaf



accessories for	526008			
	Part No.	532550	Ref. No.	—
	O-ring NBR 787/70 thickness 2.62mm ID ø 9.13mm Qty 10 pcs			

1 				
Part No.	526007	Ref. No.	0530020	
description	valve group supply L 52.8mm ED ø 16mm shaft triangular			

1 				
Part No.	527938	Ref. No.	0530020	
description	valve H 52.6mm ED ø 16mm			

1 				
Part No.	527939	Ref. No.	0530001	
description	valve H 54.2mm ED ø 16mm			

screw connections

1 				
Part No.	527944	Ref. No.	0530120	
description	cap nuts IT M6 ø 15mm L 22mm			

1 				
Part No.	527942	Ref. No.	0530100	
description	screw connection thread 1/2" int. ø 1 10.8mm int. ø 2 15mm L 17mm WS 22			

1 				
Part No.	527941	Ref. No.	0530090	
description	screw connection thread M30x1.5 IT 1/2" L 39mm WS 26			

components

nozzles

with thread

1 				
Part No.	528486	Ref. No.	0520020	
description	nozzle bore ø 0.7mm thread M6x0.75 L 9mm WS 7			

miscellaneous

1 				
Part No.	527948	Ref. No.	4001011	
description	protection cap for brewing unit			

screw connections

1 				
Part No.	527270	Ref. No.	0520000	
description	end cap thread M16x1.5 ID ø 8.9mm L 21mm chrome-plated WS 22			

water dispersions

water dispersions

group 2

1 				
Part No.	529230	Ref. No.	0520070	
description	water distributor ø 30mm hole ø 2mm H 14mm ET M10x1 grooves 6 2mm brass 2 holes perforation ø 1.7mm			



safety valves

safety valves

3/8"



1

Part No.	527977	Ref. No.	3630030
description	safety valve connection 3/8" triggering pressure 1.8bar approval CE 0036		



1

Part No.	527976	Ref. No.	3630025
description	safety valve connection 3/8"-1/2" triggering pressure 1.8bar approval CE 0035 sealed		

expansion valves

with hose connection



1

Part No.	529329	Ref. No.	3630140
description	expansion valve adjustable T1: 3/8" ET hose ø 9.5mm BL 40mm total length 78.6mm		



1

Part No.	527979	Ref. No.	3630140
description	expansion valve T1: 3/8" ET hose ø 9.5mm L 58mm		

drain pans

drain pans



1

Part No.	527946	Ref. No.	4008005
description	drain pan L 69mm W 79mm H 54mm hose ø 14mm		

aerators and air bleeders



1

Part No.	527981	Ref. No.	3630001
description	aerator and air bleeder connection 1/4"		

boilers

heat exchangers

injector tubes



1

Part No.	527951	Ref. No.	2510002
description	injector pipe tube ø 8mm pipe length 100mm T1: 1/4" T2: 1/4"		



1

Part No.	527952	Ref. No.	2510005
description	injector pipe tube ø 8mm pipe length 140mm T1: 1/4" T2: 1/4"		

steam/water taps

steam/water taps

steam/water taps



1

Part No.	527953	Ref. No.	3501030
description	steam/water tap inlet 1/4" outlet 3/8" brass		

steam taps

steam taps (complete)



1

Part No.	527954	Ref. No.	3501150
description	steam tap mounting pos. external inlet 3/8" outlet 3/8" chrome-plated brass		



components

shafts



1

Part No.	527959	Ref. No.	0540080
description	shaft for steam-/water-tap ϕ 14mm D1 ϕ 11.5mm D2 ϕ 7.5mm D3 ϕ 5.8mm L 88mm brass		

bushes



1

Part No.	526010	Ref. No.	0540060
description	bush steam/water tap D1 ϕ 10.5mm D2 ϕ 9mm ID ϕ 6.3mm H 4.6mm brass		
accessories for	526010		
	Part No.	526005	Ref. No. —
description	shaft steam tap ϕ 14.8mm L 92.5mm thread M6 brass		

gaskets



1

Part No.	527961	Ref. No.	0510162 0540090
description	flat gasket copper ED ϕ 21mm ID ϕ 17.2mm thickness 1.5mm		



1

Part No.	527970	Ref. No.	0541060
description	flat gasket PTFE ED ϕ 24mm ID ϕ 18mm thickness 2mm Qty 1 pcs		



1

Part No.	527960	Ref. No.	0540085
description	gasket D1 ϕ 12mm thickness 6mm for steam-/water-tap		



1

Part No.	529795	Ref. No.	0510140 0541070
description	gasket D1 ϕ 13mm D2 ϕ 4mm thickness 4mm coffee machine		



1

Part No.	527972	Ref. No.	0541100
description	gasket set D1 ϕ 16mm ID ϕ 7.8mm thickness 4mm rubber for steam-/water-tap		

springs



1

Part No.	527958	Ref. No.	0540070
description	compression spring ϕ 10.5mm L 32mm wire gauge ϕ 1.3mm for steam-/water-tap		



1

Part No.	527968	Ref. No.	0541050
description	compression spring ϕ 12.5mm L 31mm wire gauge ϕ 1.8mm		



1

Part No.	527969	Ref. No.	0541055
description	compression spring ϕ 8mm L 21mm wire gauge ϕ 0.4mm		

tap bodies



1

Part No.	527962	Ref. No.	0540095
description	body T1: M16x1 T2: 3/8" T3: 1/4" L 49mm		

washers



1

Part No.	527955	Ref. No.	0540030
description	plain washer ID ϕ 6.1mm ED ϕ 20mm thickness 1.6mm brass Qty 1 pcs for coffee machine tap		



screw connections



1

Part No.	527956	Ref. No.	0540040
description	screw connection T1: M16x1 L 61mm ID ø 11mm WS 26 brass		

steam/water pipes

steam pipes



1

Part No.	527926	Ref. No.	2520530
description	steam pipe thread 3/8" H 120mm L 50mm W 100mm tube ø 10mm SS		



1

Part No.	527924	Ref. No.	2520512
description	steam pipe thread 3/8" H 170mm W 100mm tube ø 10mm SS		



1

Part No.	527925	Ref. No.	2520518
description	steam pipe thread 3/8" H 170mm W 120mm tube ø 10mm SS		



1

Part No.	527927	Ref. No.	2520550
description	steam pipe thread 3/8" H 190mm W 100mm tube ø 10mm SS		



1

Part No.	527928	Ref. No.	2520555
description	steam pipe thread 3/8" H 250mm W 70mm tube ø 10mm SS		



1

Part No.	527929	Ref. No.	2520580
description	steam pipe thread 3/8" H 270mm L 70mm W 80mm tube ø 8mm brass		



1

Part No.	527930	Ref. No.	2520590
description	steam pipe thread 3/8" H 270mm L 70mm W 80mm tube ø 8mm brass		

nozzles for steam pipes



1

Part No.	527964	Ref. No.	0540150
description	nozzle thread M9x0.75 ø 13mm L 21mm 4 holes bore ø 1.5mm SS		

nozzles for water pipes

gaskets



1

Part No.	527965	Ref. No.	0540210
description	flat gasket rubber ED ø 21mm ID ø 15mm thickness 3mm Qty 1 pcs		



components



1

Part No.	527967	Ref. No.	0540220
description	screw connection for flow regulator thread M22x1 L 16mm ø 23.5mm ID ø 20mm		

tap aerators



1

Part No.	527966	Ref. No.	0540215
description	tap aerator D1 ø 18.8mm D2 ø 20.8mm H 12mm		

water pipes



1

Part No.	527920	Ref. No.	2520007
description	water pipe thread 1/4" ø 23.5mm L 105mm WS 17 brass		



1

Part No.	526614	Ref. No.	2520035
description	water pipe thread 3/8" L 75mm WS 22		



1

Part No.	527921	Ref. No.	2520015
description	water pipe thread 3/8" ø 23.5mm L 112mm WS 22 brass		



1

Part No.	527923	Ref. No.	2520130
description	water pipe thread 3/8" ø 23.5mm L 75mm WS 22 SS		



1

Part No.	527922	Ref. No.	2520020
description	water pipe thread 3/8" ø 23.5mm L 86mm WS 22 brass		

accessories

bushes



1

Part No.	527971	Ref. No.	0541125
description	bush D1 ø 7.8mm D2 ø 15mm H 21.5mm brass ID ø 6mm		



1

Part No.	529705	Ref. No.	0540110
description	bush D1 ø 8.3mm D2 ø 12mm H 6mm brass ID ø 7mm		

springs



1

Part No.	527963	Ref. No.	0540100
description	compression spring ø 12mm L 16.5mm wire gauge ø 1.5mm steel for steam/water pipes		

tube handles





1

Part No.	528625	Ref. No.	4005040
description	tube handle L 35mm rubber ID ø 8mm		





union nuts			
1			
Part No.	529706	Ref. No.	0540135
description	union nut thread 3/8" L 21mm hole ø 12.5mm brass		

various taps			
1			
Part No.	527975	Ref. No.	3501160
description	water tap inlet 3/8" outlet 3/8" shaft 6.5x6.5 shaft L 19mm brass for cup warmer		

fine filters			
1			
Part No.	528946	Ref. No.	0520010
description	fine filter pipe ø 8.5mm H 22mm		

intake valves			
1			
Part No.	527957	Ref. No.	4650140
description	intake valve brass with expansion valve inlet 3/8" outlet 1/4"		

accessories			
1			
Part No.	526504	Ref. No.	0510142
description	bolt ø 7mm L 47.5mm brass		

bushes			
1			
Part No.	526501	Ref. No.	0510148
description	bush for lever D1 ø 12mm D2 ø 14.6mm int. ø 1.7mm H 6.7mm brass		

gaskets			
1			
Part No.	527995	Ref. No.	0510186
description	gasket ED ø 15mm seat ø 6mm H 5mm overall height 10mm		

gasket supports			
1			
Part No.	527997	Ref. No.	0510166
description	gasket support D1 ø 7.3mm D2 ø 13mm H 20mm brass		

1			
Part No.	527996	Ref. No.	0510184
description	gasket support D1 ø 8.6mm D2 ø 17mm int. ø 1.6mm int. ø 2.15mm H 9mm brass		

levers			
1			
Part No.	526500	Ref. No.	0510152
description	lever ø 12mm L 48mm brass		

miscellaneous			
1			
Part No.	526503	Ref. No.	0510120
description	piston D1 ø 9mm D2 ø 16mm int. ø 1.13mm H 13mm brass		

screw connections			
1			
Part No.	526502	Ref. No.	0510114
description	screw connection thread 1/4" L 28mm WS 24 ID ø 7mm brass		



			
1			
Part No.	527998	Ref. No.	0510105
description	screw connection thread 1/4" T1: 3/8" L 32mm WS 21 ID ø 7mm brass		

			
1			
Part No.	527999	Ref. No.	0510150
description	screw connection thread 3/8" L 19mm ø 20mm WS 21 ID ø 12.2mm		

level glasses			
level glasses			
gaskets			
			
1			
Part No.	529408	Ref. No.	2003010
description	gasket D1 ø 16mm D2 ø 10mm H 8mm water level glass		

balls			
			
1			
Part No.	527947	Ref. No.	4012010
description	ball ø 6mm plastic		

level glass pipes			
			
1			
Part No.	527990	Ref. No.	4580010
description	water level tube ø 11mm H 140mm ID ø 8mm marking Min/Max red		

pipes			
			
1			
Part No.	527950	Ref. No.	2502006
description	aspiration tube ø 8mm L 98mm		

non-return valves			
complete			
			
1			
Part No.	527978	Ref. No.	3630120
description	non-return valve inlet 3/8" outlet 3/8" L 38mm		

screw connections			
reducers			
			
1			
Part No.	527980	Ref. No.	3510730
description	reducer T1: 1/8" T2: 1/2" int. ø 1 5mm int. ø 2 14mm L 64mm brass		

T-pieces			
			
1			
Part No.	527985	Ref. No.	3510010
description	T-piece thread 1/4" T1: 1/2" T2: 1/2" int. ø 1 11.5mm int. ø 2 10/14mm L 46mm brass for boiler		

angle pieces			
			
1			
Part No.	527984	Ref. No.	3510005
description	angle piece T1: 1/2" T2: 1/2" int. ø 1 11.5mm int. ø 2 10/14mm L 48mm brass for boiler		

			
1			
Part No.	527983	Ref. No.	3510004
description	angle piece T1: 1/4" T2: 3/8" int. ø 1 6mm int. ø 2 8mm L 25mm brass		

			
1			
Part No.	527982	Ref. No.	3510003
description	angle piece T1: 3/8" T2: 3/8" int. ø 1 8.2mm int. ø 2 10mm L 25mm brass		



for dishwashers

washing and rinsing systems



1

Part No.	520706	Ref. No.	3530005
description	screw cap thread 1/4" WS 17		

knobs

steam/water taps

steam/water taps



1

Part No.	111274	Ref. No.	4001010
description	turning handle ø 41mm thread M18 black		

knob dial plates



1

Part No.	111275	Ref. No.	4001020
description	symbol steam ø 32mm L 28mm		



1

Part No.	111276	Ref. No.	4001025
description	symbol water ø 32mm L 28mm		

accessories



1

Part No.	528762	Ref. No.	0540020
description	cotter pin ø 1.8mm L 17mm		



1

Part No.	541691	Ref. No.	4001015
description	star handle shaft 7x7mm ø 64mm L 24mm black thermoplastic		

handles and hand wheels

cone handles



1

Part No.	111092	Ref. No.	4001005
description	cone handle thread M8 ø 25mm L 41mm black		

star handles

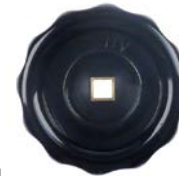

1

Part No.	541691	Ref. No.	4001015
description	star handle shaft 7x7mm ø 64mm L 24mm black thermoplastic		

fittings for catering equipment

drain taps

accessories



1

Part No.	540222	Ref. No.	2002120
description	O-ring EPDM thickness 2.62mm ID ø 47.3mm Qty 1 pcs		

gaskets

O-rings

EPDM



1

Part No.	510177	Ref. No.	0541120
description	O-ring EPDM thickness 1.78mm ID ø 7.66mm Qty 1 pcs		



1

Part No.	530293	Ref. No.	0510164
description	O-ring EPDM thickness 1.78mm ID ø 8.73mm Qty 1 pcs		

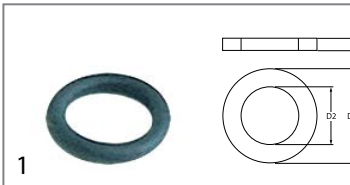
Part No.	529412	Ref. No.	0541130
description	O-ring EPDM thickness 2.62mm ID ø 10.78mm Qty 1 pcs		

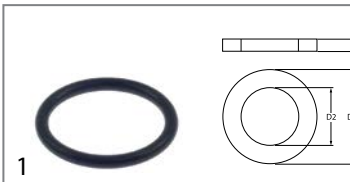

Part No.	532453	Ref. No.	0520040
description	O-ring EPDM thickness 2.62mm ID ø 21.89mm Qty 1 pcs		

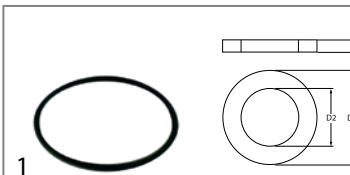

Part No.	540222	Ref. No.	2002120
description	O-ring EPDM thickness 2.62mm ID ø 47.3mm Qty 1 pcs		

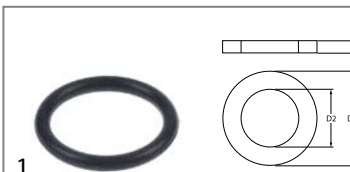

Part No.	527991	Ref. No.	0510182
description	O-ring EPDM thickness 2mm ID ø 14.5mm Qty 1 pcs		



Part No.	361311	Ref. No.	0540050
description	O-ring EPDM thickness 2mm ID ø 6mm Qty 1 pcs for type N6		

silicone

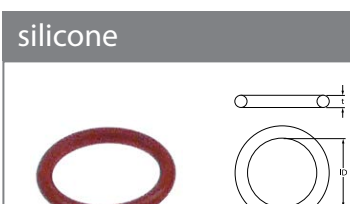

Part No.	528516	Ref. No.	0540140
description	O-ring silicone thickness 1mm ID ø 6mm Qty 1 pcs		

Viton



Part No.	528687	Ref. No.	0510144
description	O-ring Viton thickness 1.78mm ID ø 3.69mm Qty 1 pcs		

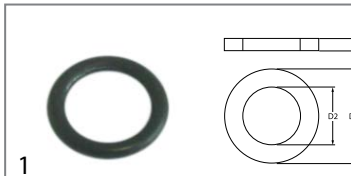

Part No.	528291	Ref. No.	0540130
description	O-ring Viton thickness 2.62mm ID ø 11.91mm Qty 1 pcs		

sealing washers

rubber gaskets



Part No.	527965	Ref. No.	0540210
description	flat gasket rubber ED ø 21mm ID ø 15mm thickness 3mm Qty 1 pcs		

copper gaskets

DIN-7603-A



Part No.	527961	Ref. No.	0510162 0540090
description	flat gasket copper ED ø 21mm ID ø 17.2mm thickness 1.5mm		



Part No.	527994	Ref. No.	0510112
description	flat gasket copper ED ø 25mm ID ø 19.3mm thickness 1.5mm		

DIN-7603-C



Part No.	529360	Ref. No.	2004005
description	gasket copper ED ø 26.1mm ID ø 21mm thickness 2.1mm for thread 1/2"		



PTFE gaskets

1 

Part No.	526679	Ref. No.	0510190
description	flat gasket PTFE ED ø 18mm ID ø 13mm thickness 2mm Qty 1 pcs		

1 

Part No.	527993	Ref. No.	0510190
description	flat gasket PTFE ED ø 18mm ID ø 13mm thickness 2mm Qty 1 pcs		

1 

Part No.	528314	Ref. No.	0540120
description	flat gasket PTFE ED ø 20mm ID ø 17mm thickness 2mm Qty 1 pcs suitable for Astoria/Azkoyen/Espressa/Wega		

1 

Part No.	526013	Ref. No.	0520001
description	flat gasket PTFE ED ø 22mm ID ø 17mm thickness 2mm Qty 1 pcs		

1 

Part No.	527970	Ref. No.	0541060
description	flat gasket PTFE ED ø 24mm ID ø 18mm thickness 2mm Qty 1 pcs		

1 

Part No.	528683	Ref. No.	0530050
description	flat gasket PTFE ED ø 26mm ID ø 21mm thickness 2mm Qty 1 pcs suitable for GAGGIA, SPAZIALE		

1 

Part No.	526014	Ref. No.	0520050
description	flat gasket PTFE ED ø 35mm ID ø 30mm thickness 2mm Qty 1 pcs		

1 

Part No.	528022	Ref. No.	2001001
description	flat gasket PTFE ED ø 52mm ID ø 41mm thickness 2mm size 1¼" Qty 1 pcs suitable for CARIMALI, FAEMA, MARZOCCO, PAVONI		

1 

Part No.	528002	Ref. No.	2001010
description	flat gasket PTFE ED ø 57mm ID ø 42mm thickness 3mm Qty 1 pcs equiv. no. 12001/W10470 suitable for		

Viton gaskets

1 

Part No.	528476	Ref. No.	0530010
description	flat gasket Viton ED ø 13mm ID ø 4mm thickness 4mm Qty 1 pcs		

special gaskets

group gaskets

1 

Part No.	528165	Ref. No.	2001310
description	group gasket L 76mm W 72mm thickness 2.5mm aperture 26x64mm hole distance 55mm		

springs

compression springs

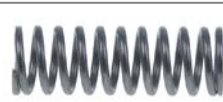
1 

Part No.	527958	Ref. No.	0540070
description	compression spring ø 10.5mm L 32mm wire gauge ø 1.3mm for steam-/water-tap		

1 

Part No.	527968	Ref. No.	0541050
description	compression spring ø 12.5mm L 31mm wire gauge ø 1.8mm		



			
1			
Part No.	528493	Ref. No.	0510110
description	compression spring \varnothing 12.6mm L 30mm wire gauge \varnothing 1.9mm		

			
1			
Part No.	527963	Ref. No.	0540100
description	compression spring \varnothing 12mm L 16.5mm wire gauge \varnothing 1.5mm steel for steam/water pipes		

			
1			
Part No.	527933	Ref. No.	0530045
description	compression spring \varnothing 14.2mm L 21mm wire gauge \varnothing 1.8mm SS		

			
1			
Part No.	527934	Ref. No.	0530030
description	compression spring \varnothing 14.2mm L 45mm wire gauge \varnothing 1.5mm SS		

			
1			
Part No.	527935	Ref. No.	0530095
description	compression spring \varnothing 14.6mm L 33mm wire gauge \varnothing 2mm		

			
1			
Part No.	527969	Ref. No.	0541055
description	compression spring \varnothing 8mm L 21mm wire gauge \varnothing 0.4mm		

			
1			
Part No.	527992	Ref. No.	0510160
description	compression spring \varnothing 8mm L 32mm wire gauge \varnothing 0.5mm		

manometers

			
1			
Part No.	541685	Ref. No.	4551014
description	manometer double scale \varnothing 63mm pressure range 0-2.5 / 0-15bar connection on the backside thread 1/8"		

			
1			
Part No.	541686	Ref. No.	4551017
description	manometer double scale \varnothing 63mm pressure range 0-3 / 0-15bar connection on the backside thread 1/8"		

			
1			
Part No.	541687	Ref. No.	4551035 4551045
description	manometer \varnothing 41mm pressure range 0-15bar thread 1/8" marking 7-8 connection on the backside with capillary pipe		

			
1			
Part No.	541688	Ref. No.	4551037 4551047
description	manometer \varnothing 41mm pressure range 0-3bar thread 1/8" marking 2 connection on the backside with capillary pipe		

			
1			
Part No.	541200	Ref. No.	4551022
description	manometer \varnothing 52mm pressure range 0 up to 3bar connection on the backside marking 0.7-1 thread 1/8"		

1

Part No.	541201	Ref. No.	4551025
description	manometer ø 53.5mm pressure range 0 up to 16bar connection on the backside thread 1/8"		



1

Part No.	541693	Ref. No.	4551040
description	manometer ø 63mm pressure range 0 up to 2.5bar marking 1 up to 1.2 connection 1/8"		

dosing pumps

membrane dosing pumps

self-priming

LANG

spare parts



1

Part No.	361311	Ref. No.	0540050
description	O-ring EPDM thickness 2mm ID ø 6mm Qty 1 pcs for type N6		

hoses

industrial hoses

PTFE hoses

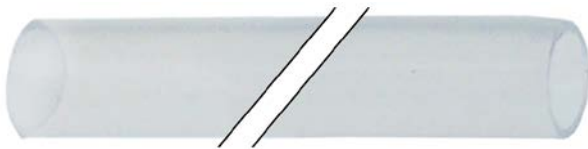

1

Part No.	527919	Ref. No.	4010200
description	hose ED ø 12mm ID ø 10mm L 1m PFA		

fittings, hose and pipe connectors

fittings

double nipples



1

Part No.	520164	Ref. No.	3510710
description	double nipple nickel-plated brass thread 1/4" - 3/8" Qty 1 pcs		

angle pieces



1

Part No.	520824	Ref. No.	3510009
description	angle piece thread 1/8" ET - 1/8" IT nickel-plated brass		

T-pieces

stainless steel



1

Part No.	520710	Ref. No.	3510014
description	T-piece thread 1/4" ET - 1/4" ET - 1/4" ET stainless steel L 49mm		

hose connectors

brass



1

Part No.	520673	Ref. No.	3520030
description	hose connector brass straight thread 1/2" hose ø 14mm Qty 1 pcs		



valves and tank inlets

ball valves

universal

mini ball valves



1

Part No.	520722	Ref. No.	3501001
description	ball valve connection 1/4" IT - 1/4" ET DN8 total length 39mm chrome-plated brass		

fastening material

screws

cylinder head bolts

DIN 912/ISO 4762



1

Part No.	560316	Ref. No.	1103210
description	cylinder head bolt thread M8 thread L 25mm WS 6 SS Qty 20 pcs DIN 912/ISO 4762		

nuts

hexagonal nuts

hexagonal nuts inch thread



1

Part No.	503042	Ref. No.	0510146
description	nut thread 3/8" H 6mm brass WS 22 Qty 1 pcs		

washers

washers

miscellaneous



1

Part No.	527955	Ref. No.	0540030
description	plain washer ID ø 6.1mm ED ø 20mm thickness 1.6mm brass Qty 1 pcs for coffee machine tap		

fasteners

cotter pins



1

Part No.	528762	Ref. No.	0540020
description	cotter pin ø 1.8mm L 17mm		

screw caps



1

Part No.	520706	Ref. No.	3530005
description	screw cap thread 1/4" WS 17		



1

Part No.	520705	Ref. No.	3530022
description	screw cap thread 1/8" WS 16		

GASTROPARTS.COM

