



GASTROPARTS

Roller-Grill

[EN] Equipment

[DE] Geräte

[ES] Aparatos

[FR] Équipement

[IT] Attrezzature

[PL] Urządzenia

[RU] Оборудование

✉ gastroparts@gastroparts.com

☎ tel. +48 56 657 00 66

📘 fb.com/gastroparts.global

GASTROPARTS.COM





heating elements

heating elements for ovens

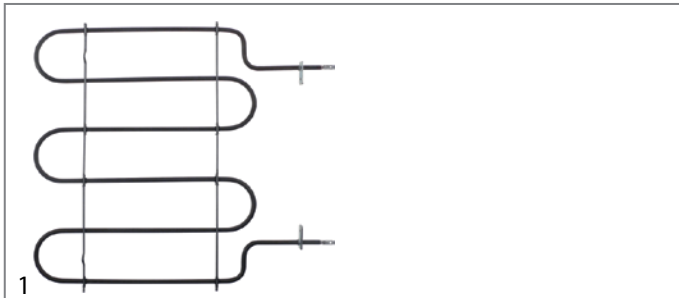

Part No.	420092	Ref. No.	D02157
description	heating element 1200W 230V L 363mm W 360mm lug length 33mm lug width 16mm hole ø 3.4mm tube ø 6.5mm connection male faston 6.3mm heating circuits 1 dry heating element windings 3 for oven		

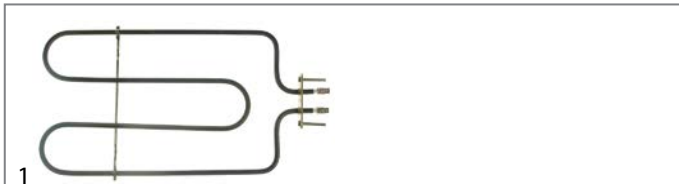

Part No.	416735	Ref. No.	D02147
description	heating element 700W 110V heating circuits 1 L 330mm W 186mm L1 25mm L2 305mm W1 77mm W2 32mm flange length 70mm flange width 22mm hole distance 56mm bridge length 200mm hole ø 4mm tube ø 6.3mm connection male faston 6.3mm rectangular flange with bolt grill setting oven		

heating elements for bain maries

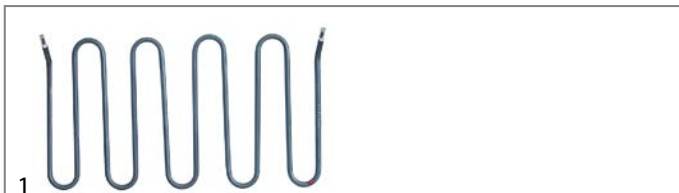

Part No.	416778	Ref. No.	D02073
description	heating element 1500W 230V heating circuits 1 L 246mm L1 30mm W 430mm connection distance 422mm tube ø 8mm dry heating element bain marie H 33mm		

heating elements for crepes makers

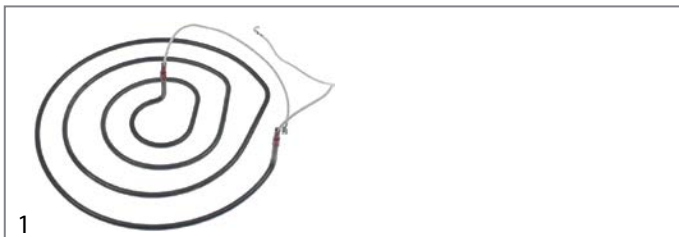

Part No.	419231	Ref. No.	D02172
description	heating element 3000W 230V ED ø 374mm H 70mm tube ø 8.5mm connection cable connection length 400mm heating circuits 1 crepes maker		



Part No.	416726	Ref. No.	D02013
description	heating element 3000W 230V L 304mm W 300mm H 65mm tube ø 8.5mm connection cable cable length 580mm dry heating element heating circuits 1 ED ø 310mm crepes maker		
For models:	350E, 350ED, 400E, 400ED		



Part No.	416771	Ref. No.	D02022
description	heating element 3600W 230V H 40mm tube ø 8.5mm connection distance 133mm cable length 570mm dry heating element heating circuits 1 ED ø 375mm crepes maker		
For models:	400FE		

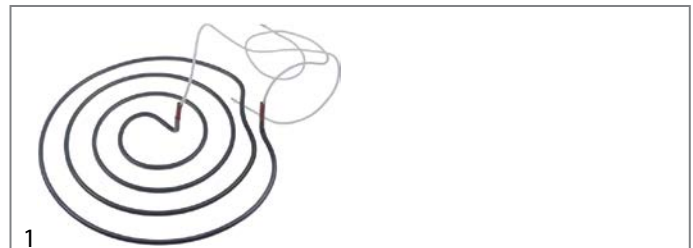

Part No.	420085	Ref. No.	D02156
description	heating element 3600W 230V H 45mm tube ø 8mm L1 140mm L2 215mm connection distance 132mm cable length 750mm for crepes maker heating circuits 1 ED ø 380mm		



Part No.	420234	Ref. No.	D02163
description	heating element 3600W 230V H 70mm tube ø 8mm L1 190mm L2 170mm connection male faston 6.3mm connection distance 190mm cable length 400mm heating circuits 1 ED ø 360mm crepes maker suitable for crepes maker		



heating elements for fryers

Part No.	416746	Ref. No.	D02023
description	heating element 3000W 230V heating circuits 1 L 300mm W 185mm H 180mm L1 23mm L2 270mm W1 78mm W2 29mm flange length 50mm flange width 22mm hole distance 40mm windings 2 tube \varnothing 8mm connection male faston 6.3mm hole \varnothing 4.5mm rectangular flange immersion heater		

Part No.	416744	Ref. No.	D02010 D02019
description	heating element 2000W 230V heating circuits 1 L 282mm W 120mm H 175mm rectangular flange connection male faston 6.3mm L1 22mm L2 50mm L3 210mm W1 46mm W2 28mm hole distance 40mm windings 2 hole \varnothing 5mm flange length 50mm flange width 22mm		

Part No.	416743	Ref. No.	D02018
description	heating element 2000W 230V heating circuits 1 L 285mm W 118mm H 142mm rectangular flange connection male faston 6.3mm immersion heater L1 25mm L2 50mm L3 210mm W1 45mm W2 28mm hole distance 40mm windings 2 hole \varnothing 5mm flange length 50mm flange width 22mm tube \varnothing 18mm		

Part No.	416745	Ref. No.	D02069
description	heating element 2500W 230V heating circuits 1 L 285mm W 125mm H 177mm rectangular flange connection male faston 6.3mm immersion heater L1 25mm L2 50mm L3 210mm W1 48mm W2 28mm hole distance 40mm windings 3 hole \varnothing 5mm flange length 50mm flange width 22mm tube \varnothing 8mm		

Part No.	420496	Ref. No.	D02122
description	heating element 3200W 230V heating circuits 1 L 284mm W 115mm H 180mm connection F6.3 L1 22mm L2 45mm L3 215mm W1 25mm hole distance 40mm		

Part No.	418833	Ref. No.	D02070
description	heating element 3400W 230V heating circuits 1 L 295mm W 180mm H 175mm rectangular flange connection male faston 6.3mm L1 25mm L2 30mm L3 235mm W1 79mm W2 22mm hole distance 40mm windings 4 hole \varnothing 4.5mm flange length 50mm flange width 22mm tube \varnothing 8mm		

Part No.	416739	Ref. No.	D02025
description	heating element 3800W 230/400V heating circuits 3 L 280mm W 185mm H 170mm L1 20mm L2 260mm W1 50mm W2 85mm flange length 115mm flange width 22mm tube \varnothing 8mm hole distance 103mm hole \varnothing 5mm connection male faston 6.3mm rectangular flange immersion heater fryer		

Part No.	416740	Ref. No.	D02027
description	heating element 5000W 230/400V heating circuits 3 L 292mm W 186mm H 170mm L1 28mm L2 266mm W1 50mm W2 85mm flange length 115mm flange width 23mm tube \varnothing 8mm hole distance 103mm hole \varnothing 4mm connection male faston 6.3mm connection length 35mm rectangular flange immersion heater fryer		



2 hole fixing

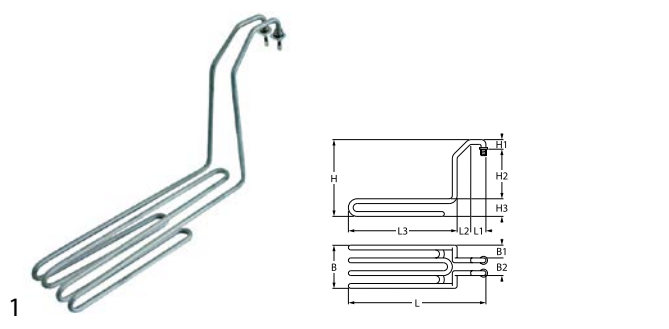

Part No.	416741	Ref. No.	D02028
description	heating element 4000W 230V heating circuits 1 L 465mm W 82mm H 280mm 2 hole fixing connection M4 immersion heater L1 55mm L2 50mm L3 360mm W1 30mm W2 26mm H1 38mm H2 203mm H3 35mm tube ø 8mm thread M11x1 mounting distance 22mm		
accessories for	416741		
	Part No.	521103	Ref. No. —
	nut thread M4 H 3mm WS 7 brass Qty 20 pcs		
	Part No.	521104	Ref. No. —
	washer ID ø 4.3mm ED ø 8mm thickness 0.5mm brass Qty 20 pcs for thread M4		
	Part No.	560111	Ref. No. —
	plain washer ID ø 4.3mm ED ø 9mm thickness 0.8mm SS Qty 20 pcs DIN 125A for thread M4		
	Part No.	560131	Ref. No. —
	hexagonal nut thread M4 H 3.2mm WS 7 SS DIN/ISO DIN 934 / ISO 4032/8673 Qty 20 pcs		

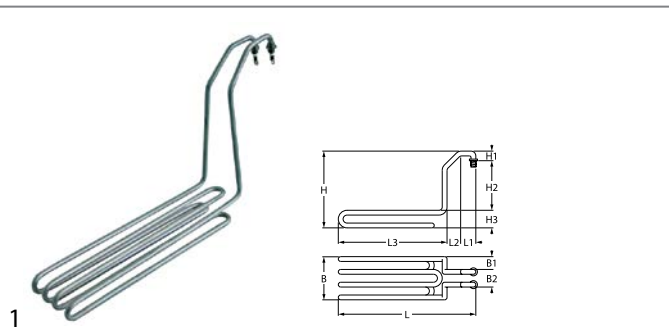

Part No.	416742	Ref. No.	D02099
description	heating element 6000W 230V heating circuits 1 L 460mm W 86mm H 290mm 2 hole fixing connection M4 immersion heater L1 60mm L2 30mm L3 370mm W1 20mm W2 46mm H1 20mm H2 220mm H3 50mm tube ø 8mm thread M11x1 mounting distance 38mm		
accessories for	416742		
	Part No.	521103	Ref. No. —
	nut thread M4 H 3mm WS 7 brass Qty 20 pcs		
	Part No.	521104	Ref. No. —
	washer ID ø 4.3mm ED ø 8mm thickness 0.5mm brass Qty 20 pcs for thread M4		
	Part No.	560111	Ref. No. —
	plain washer ID ø 4.3mm ED ø 9mm thickness 0.8mm SS Qty 20 pcs DIN 125A for thread M4		
	Part No.	560131	Ref. No. —
	hexagonal nut thread M4 H 3.2mm WS 7 SS DIN/ISO DIN 934 / ISO 4032/8673 Qty 20 pcs		

heating elements for griddles



Part No.	419177	Ref. No.	D02169
description	heating element 1750W 230V heating circuits 1 L 255mm W 240mm H 60mm tube ø 6.3mm cable length 600mm bain marie connection distance 234mm dry heating element		

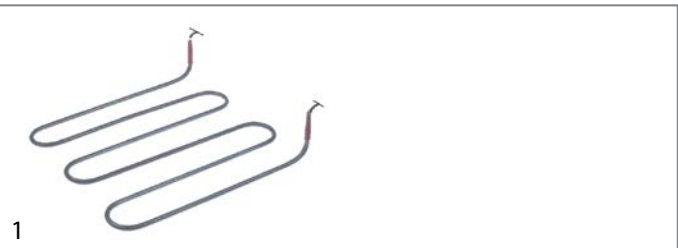

Part No.	416700	Ref. No.	D02141
description	heating element 1750W 240V heating circuits 1 L 275mm W 270mm tube ø 6.3mm W1 50mm W2 170mm windings 4 bain marie dry heating element		
For models:	PSE600		



Part No.	416772	Ref. No.	D02011
description	heating element 2500W 230V heating circuits 1 L 350mm W 182mm tube ø 8.5mm L1 60mm L2 290mm W1 75mm W2 32mm rectangular flange connection male faston 6.3mm hole distance 56mm flange length 70mm flange width 22mm hole ø 4mm dry heating element		

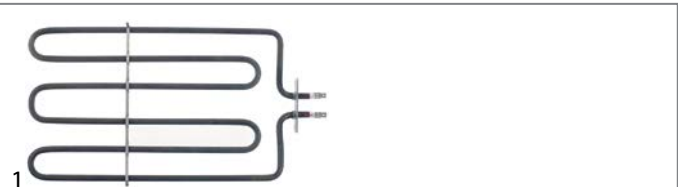

Part No.	420456	Ref. No.	D02017 D02160
description	heating element 2800W 230V heating circuits 1 L 338mm W 190mm H 25mm tube ø 8mm		
For models:	140, 140D		

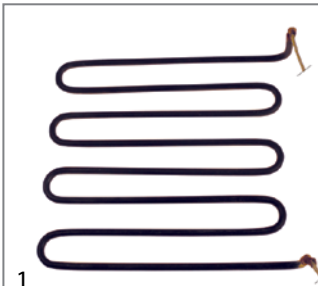



Part No.	418622	Ref. No.	D02105
description	heating element 3000W 230V heating circuits 1 L 277mm W 245mm H 55mm tube ø 8mm connection cable cable length 600mm connection length 15mm griddle connection distance 237mm dry heating element		

heating elements for gyros grills



Part No.	420086	Ref. No.	D02154
description	heating element 1450W 230V L 300mm W 100mm H 57mm connection M4 thread M14x1.5 tube ø 8.3mm 2 hole fixing dry heating element		



Part No.	416704	Ref. No.	D02075	
description	heating element 2500W 240V L 280mm W 190mm H 130mm connection M4 L1 143mm L2 130mm tube ø 6.3mm 2 hole fixing dry heating element thread M12x1.25			
For models:	GRE40, GRE60, GRE80			
accessories for	416704			
	Part No.	550681	Ref. No.	—
	nut thread M12x1.25 H 5mm WS 17 brass Qty 1 pcs			

heating elements for chicken rotisseries



Part No.	416702	Ref. No.	D02068
description	heating element 1400W 230V 1 hole fixing thread M16x1.5 L 595mm heating circuits 1 connection M5 dry heating element tube ø 12mm chicken rotisserie		
For models:	RBE12, RBE4, RBE8		



Part No.	420457	Ref. No.	D02152
description	heating element 1400W 230V screw mounting L 685mm W 10.5mm H 10.5mm heating circuits 1 connection M4 tube ø 10.5mm		



Part No.	420477	Ref. No.	D02035
description	heating element 1500W 110V screw mounting L 160mm W 140mm H 45mm heating circuits 1 connection F6.3 tube ø 6.5mm		



Part No.	420458	Ref. No.	D02009
description	heating element 1500W 230V screw mounting L 160mm W 140mm H 45mm heating circuits 1 connection F6.3 tube ø 6.5mm		



Part No.	416705	Ref. No.	D02074
description	heating element 2500W 230V 2 hole fixing thread M16x1.5 L 557mm W 53mm heating circuits 1 connection M5 dry heating element tube ø 12.5mm mounting distance 41mm connection length 50mm mounting pos. lower grill		

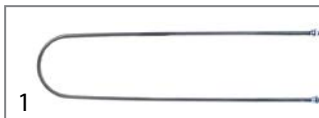

Part No.	418843	Ref. No.	D02016
description	heating element 3000W 230V 2 hole fixing thread M14 L 705mm W 175mm heating circuits 1 connection M4 tube ø 10mm mounting distance 165mm connection length 40mm		

heating elements for hot counters

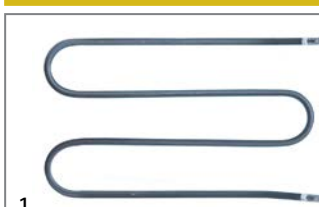

Part No.	416777	Ref. No.	D02029
description	heating element 500W 230V heating circuits 1 L 245mm W 147mm H 28mm connection distance 140mm tube ø 6.3mm connection 6.3 dry heating element hot bar L1 38mm L2 195mm		



1

Part No.	420455	Ref. No.	D02097
description	heating element 650W 230V heating circuits 1 L 183mm W 330mm H 15mm connection distance 327.5mm tube ø 6.3mm windings 2 connection F6.3		

heating elements for contact grills

1

Part No.	416724	Ref. No.	D02095 D02112
description	heating element 1200W 230V L 180mm W 200mm H 38mm W1 100mm W2 50mm connection length 25mm tube ø 6.5mm windings 3 cable length 6.5mm mounting pos. lower dry heating element		
For models:	MAJESTIC, SAVOYE		

heating elements for hot dog machines

1

Part No.	416718	Ref. No.	D02002
description	heating element 300W 230V L 170mm W 198mm tube ø 6.3mm L1 50mm L2 120mm W1 68mm W2 62mm connection male faston 6.3mm connection distance 56mm dry heating element heating circuits 1 hot dog machine		

1

Part No.	417229	Ref. No.	D02159
description	heating element 1200W 230V L 250mm W 120mm tube ø 6.3mm windings 5 egg cooker		

1

Part No.	416703	Ref. No.	D02001
description	heating element 650W 230V L 140mm W 267mm tube ø 6.5mm L1 50mm L2 89mm W1 120mm W2 56mm connection male faston 6.3mm dry heating element heating circuits 1 hot dog machine		

1

Part No.	416725	Ref. No.	D02094 D02114
description	heating element 1200W 240V heating circuits 1 L 178mm W 200mm H 35mm W1 60mm W2 80mm connection distance 50mm tube ø 6.3mm windings 4 connection cable cable length 800mm mounting pos. upper dry heating element		
For models:	DOUBLE PANINI, PANINI		

1

Part No.	420454	Ref. No.	D02171
description	heating element 1200W 240V L 180mm W 320mm H 15mm tube ø 6.5mm connection F6.3 connection length 770mm windings 5		

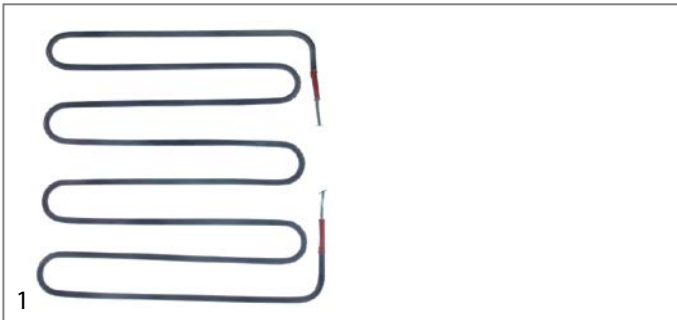

Part No.	417219	Ref. No.	D02101
description	heating element 1400W 230V heating circuits 1 L 290mm W 320mm H 8mm W1 70mm W2 190mm tube ø 6.5mm windings 4 cable length 800mm bain marie		

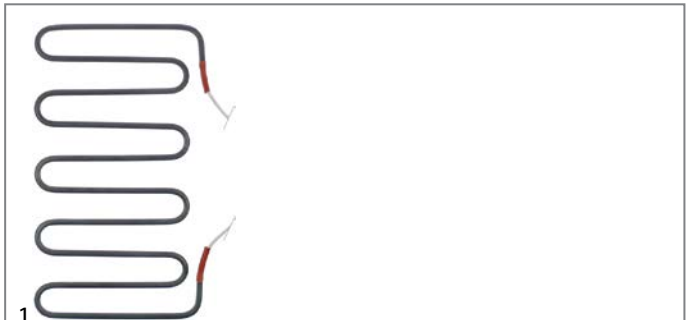

Part No.	417537	Ref. No.	D02170
description	heating element 1800W 240V L 315mm W 180mm H mm		

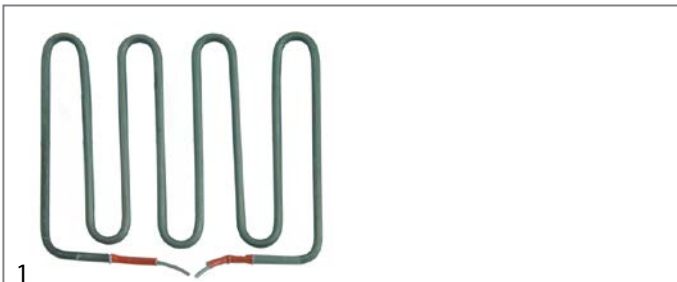

Part No.	416749	Ref. No.	D02081
description	heating element 1750W 230V windings 4 griddle		
For models:	PSE600		

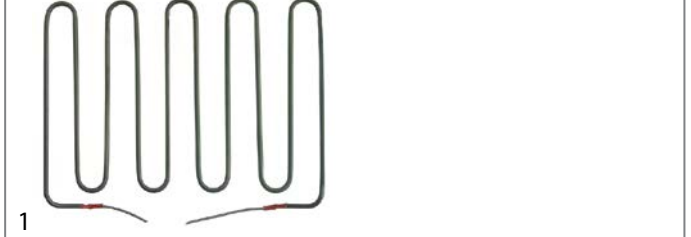

Part No.	416748	Ref. No.	D02102 D02142
description	heating element 2000W 240V heating circuits 1 L 285mm W 370mm H 40mm W1 60mm W2 165mm connection distance 165mm tube ø 6.3mm windings 5 cable length 550mm dry heating element griddle		
For models:	PSE400		

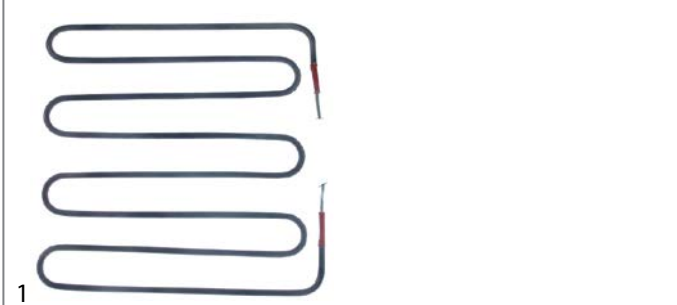

Part No.	416779	Ref. No.	D02101
description	heating element 1750W 240V heating circuits 1 L 274mm W 273mm connection distance 143mm tube ø 6.3mm windings 4 cable length 550mm dry heating element bain marie		

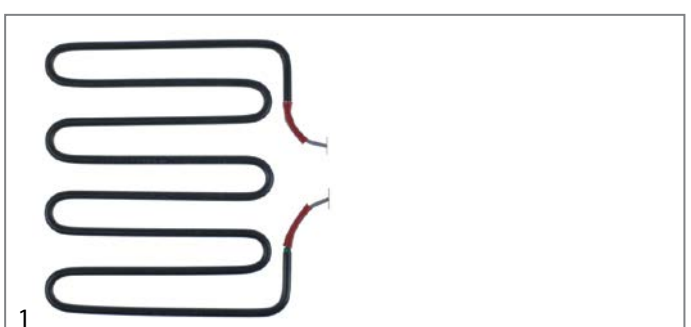

Part No.	416754	Ref. No.	D02043
description	heating element 500W 110V L 180mm W 200mm W1 48mm W2 105mm tube ø 6.3mm cable length 800mm windings 4 Panini		

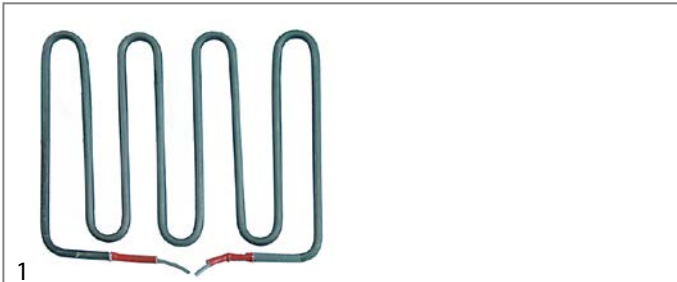

Part No.	416701	Ref. No.	D02093 D02115
description	heating element 1800W 230V heating circuits 1 L 175mm W 208mm H 30mm W1 52mm W2 71mm connection length 36mm tube ø 6.3mm windings 4 connection cable cable length 300mm dry heating element		
For models:	DOUBLE PANINI, PANINI		

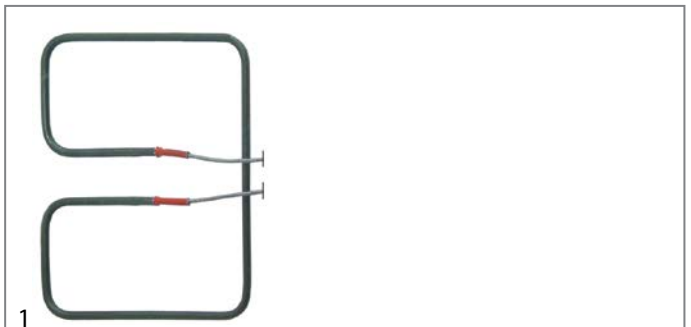

Part No.	416722	Ref. No.	D02140
description	heating element 750W 230V L 175mm W 212mm H 22mm tube ø 6.5mm W1 90mm W2 33mm connection cable cable length 75mm mounting pos. upper dry heating element heating circuits 1		
For models:	GED10, GED20, GED30, GED40, GES10, GES20, GES30, GES40		

1

Part No.	420539	Ref. No.	D02139
description	heating element 800W 230V L 175mm W 212mm H 22mm tube ø 6.5mm W1 90mm W2 33mm connection cable cable length 350mm mounting pos. upper dry heating element heating circuits 1		







1



Part No.	416723	Ref. No.	D02096 D02113
description	heating element 800W 230V L 178mm W 196mm H 33mm W1 50mm W2 108mm tube ø 6.3mm windings 3 cable length 740mm mounting pos. upper dry heating element		
For models:	MAJESTIC, SAVOYE		

heating elements for pasta cookers



1

Part No.	416728	Ref. No.	D02084
description	heating element 2200W 230V heating circuits 1 L 265mm W 195mm Hmm 2 hole fixing connection M4 thread 1/4" tube ø 8.5mm mounting distance 187mm pasta cooker immersion heater		
spare parts for	416728		
	Part No.	510417	Ref. No. —
	flat gasket fibre ED ø 20mm ID ø 14mm thickness 2mm Qty 1 pcs		
accessories for	416728		
	Part No.	361182	Ref. No. —
	nut thread 1/4" H 5mm nickel-plated brass WS 17 Qty 1 pcs		
	Part No.	520228	Ref. No. —
	tooth lock washer ID ø 15.3mm ED ø 24mm steel Qty 1 pcs for thread M14		
	Part No.	527169	Ref. No. —
	hexagonal nut thread M3 H 2.8mm WS 5.5 brass Qty 1 pcs		
	Part No.	550262	Ref. No. —
	flat gasket copper ED ø 20mm ID ø 14mm thickness 2mm		

accessories for	416728		
	Part No.	560110	Ref. No. —
	plain washer ID ø 3.2mm ED ø 7mm thickness 0.5mm SS Qty 20 pcs DIN 125A for thread M3		
	Part No.	560130	Ref. No. —
	hexagonal nut thread M3 H 2.4mm WS 5.5 SS DIN/ISO DIN 934 / ISO 4032/8673 Qty 20 pcs		

heating elements for pizza ovens

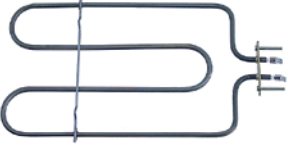

1

Part No.	416727	Ref. No.	D02148
description	heating element 700W 230V L 330mm W 185mm flange length 70mm flange width 22mm hole distance 56mm connection length 35mm connection male faston 6.3mm L1 25mm L2 305mm W1 77mm W2 31mm tube ø 6.3mm heating circuits 1 rectangular flange with bolt hole ø 4mm dry heating element		
For models:	PZ400		

heating elements for rechauds



1

Part No.	416712	Ref. No.	D02003
description	heating element 1300W 230V L 290mm W 258mm H 82mm L1 20mm L2 270mm mounting distance 241mm thread M12x1.25 tube ø 8.5mm connection male faston 6.3mm 2 hole fixing dry heating element		



1

Part No.	416717	Ref. No.	D02004
description	heating element 650W 230V L 155mm W 258mm H 82mm L1 20mm L2 135mm mounting distance 252mm thread M12x1.25 tube ø 8.5mm connection male faston 6.3mm 2 hole fixing dry heating element		

heating elements for rolling grills



1

Part No.	416755	Ref. No.	D02037
description	heating element 125W 230V heating circuits 1 L 470mm connection M4 tube ø 8mm dry heating element roller grill		
For models:	RG11, RG5, RG7, RG9		



heating elements for salamanders/toast-



Part No.	417655	Ref. No.	D02162
description	heating element 1500W 230V L 260mm W 218mm thread M14x1.5 mounting distance 210mm connection length 30mm connection M4 tube ø 8mm heating circuits 1 dry heating element 2 hole fixing		



Part No.	420497	Ref. No.	D02149
description	heating element 2000W 230V L 230mm W 215mm L1 22mm L2 208mm W1 74mm W2 70mm thread M16 mounting distance 55mm tube ø 8mm connection M4		



Part No.	416759	Ref. No.	D02092
description	heating element 650W 115V L 614mm thread M14x1.5 connection length 25mm tube ø 8.5mm connection M4 heating circuits 1 dry heating element		
For models:	SEF80		



Part No.	418215	Ref. No.	D02108
description	heating element 700W 245V L 410mm thread M14x1.25 connection length 19mm tube ø 10mm connection M4 heating circuits 1 dry heating element salamander grill W 10mm H 10mm		
For models:	SEM60		



Part No.	416756	Ref. No.	D02091
description	heating element 950W 230V		
For models:	SEM60		

heating elements for heated cabinets

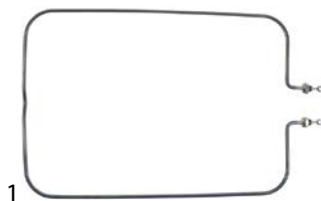

Part No.	420453	Ref. No.	SD02107
description	heating element 1800W 230V L 580mm W 383mm H 8.5mm tube ø 8.5mm connection screw connection connection distance 75mm windings 1 heating circuits 1		

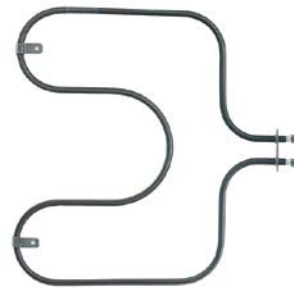

Part No.	416719	Ref. No.	D02014
description	heating element 600W 230V heating circuits 1 L 259mm W 275mm flange length 44mm flange width 22mm connection male faston 6.3mm tube ø 6.5mm rectangular flange hole ø 4mm dry heating element L1 45mm L2 214mm W1 125mm W2 29mm		
For models:	RELAIS		

heating elements for saladettes

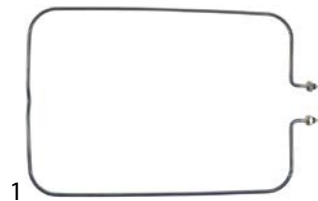

Part No.	420531	Ref. No.	SD02108
description	heating element 1200W 230V L 580mm W 383mm H 8.5mm tube ø 8.5mm connection screw connection connection distance 75mm windings 1 heating circuits 1		

heaters



Part No.	418822	Ref. No.	48006BOI
description	heater 250W 230V heating circuits 1 L 360mm W 68mm H 70mm cable length 1500mm with timer		

quartz heating elements



Part No.	416764	Ref. No.	D01035
description	heating coil 100W 75V for quartz tube 11.50hm L1 300mm L2 255mm ø 5mm		
For models:	RST127, RST227		













Part No.	416750	Ref. No.	D01033
description	heating coil 1100W 230V for quartz tube 410hm L1 545mm L2 435mm ø 7mm		
For models:	RBE12, RBE4, RBE8		





Part No.	416737	Ref. No.	D01026
description	heating coil 250W 220-240V for quartz tube L1 320mm L2 220mm ø 4.5mm		
For models:	PZ660		





			
Part No.	417654	Ref. No.	D01054
description	heating coil 330Ohm L1 160mm L2 112mm ø 5.1mm connection eye		
			
Part No.	416761	Ref. No.	D01003
description	heating coil 450W 115V for quartz tube L1 340mm L2 240mm ø 4mm		
For models:	BAR100, BAR200		
			
Part No.	416738	Ref. No.	D01027
description	heating coil 500W 220-240V for quartz tube L1 355mm L2 260mm ø 7mm		
For models:	PZ660		
			
Part No.	416729	Ref. No.	D01021
description	heating coil 600W 230V for quartz tube L1 330mm L2 230mm ø 6mm		
			
Part No.	416766	Ref. No.	D01036
description	heating coil 735W 77V for quartz tube L1 425mm L2 320mm ø 6mm		
For models:	RST128, RST228		
			
Part No.	416708	Ref. No.	D01032
description	heating coil 750W 115V for quartz tube 180Ohm L1 380mm L2 285mm ø 6.5mm connection male faston 6.3mm		
For models:	SEM60		
			
Part No.	416752	Ref. No.	D01030
description	heating coil for quartz tube 100Ohm L1 620mm L2 500mm ø 9mm		
			
Part No.	416762	Ref. No.	D01043
description	heating coil for quartz tube L1 250mm L2 160mm ø 5mm		
For models:	BAR106, BAR206		
			
Part No.	416706	Ref. No.	D01025
description	heating coil for quartz tube L1 260mm L2 165mm ø 6.5mm		
For models:	PZ330		
			
Part No.	416711	Ref. No.	D01024
description	heating coil L1 245mm L2 160mm ø 5mm		
For models:	PZ330		

			
Part No.	416758	Ref. No.	D01031
description	heating coil WV for quartz tube 210Ohm L1 290mm L2 200mm ø 6.2mm		
For models:	SEF80		

			
Part No.	416710	Ref. No.	D01041 D01045
description	heating coil WV for quartz tube L1 160mm L2 125mm ø 5.5mm connection eye		
For models:	CT540		
accessories for	416710		
	Part No.	416709	Ref. No. D04015
	 quartz tube WV L 320mm tube ø 11mm		

			
Part No.	416714	Ref. No.	D01040 D01044
description	heating coil WV L1 230mm L2 195mm ø 5.5mm connection eye		
For models:	CT540		

			
Part No.	693022	Ref. No.	A09001
description	insulator female for male faston L 20mm ø 15mm bore ø 11.5mm		

			
Part No.	416775	Ref. No.	D04016 D04024
description	quartz heating element 1200W 115V L 668mm ø 10mm connection male faston 6.3mm		

			
Part No.	416776	Ref. No.	D04025
description	quartz heating element 1200W 115V L 680mm ø 11mm connection male faston 6.3mm		
For models:	FC110G		

			
Part No.	417217	Ref. No.	D04029
description	quartz heating element 200W 115V L 340mm ø 11mm connection male faston 6.3mm for model PZ330 mounting pos. lower		



1			
Part No.	417216	Ref. No.	D04030
description	quartz heating element 295W 115V L 340mm ø 11mm connection male faston 6.3mm for model PZ330 mounting pos. upper		

1			
Part No.	418820	Ref. No.	D04033
description	quartz heating element 460W 76V L 545mm ø 11mm connection male faston 6.3mm		

1			
Part No.	418625	Ref. No.	D04022
description	quartz heating element 500W 115V L 365mm ø 10mm connection male faston 6.3mm		

1			
Part No.	420460	Ref. No.	D04043
description	quartz heating element 500W 115V L 455mm ø 11mm connection F6.3 pizza oven		

1			
Part No.	416713	Ref. No.	D04023
description	quartz heating element 525W 76V L 525mm ø 11mm connection male faston 6.3mm 10.8Ohm		

1			
Part No.	416914	Ref. No.	D04028
description	quartz heating element 530W 77V L 478mm ø 11mm connection male faston 6.3mm		
For models:	FC60G		

1			
Part No.	420459	Ref. No.	D04040
description	quartz heating element 580W 115V L 455mm ø 11mm connection F6.3 pizza oven		

1			
Part No.	420089	Ref. No.	D04034
description	quartz heating element 600W 115V L 365mm ø 11mm connection male faston 6.3mm		
accessories for	420089		
	Part No.	551108	Ref. No. B07025
	spring clip stainless steel for quartz heating element L 39mm W 25mm H 13.5mm bore ø 10mm		

1			
Part No.	416733	Ref. No.	D04001
description	quartz heating element 750W 115V L 415mm		
For models:	FC33		

1			
Part No.	416732	Ref. No.	D04001 D04020
description	quartz heating element 750W 115V L 415mm ø 11mm connection male faston 6.3mm		

1			
Part No.	420461	Ref. No.	D04038
description	quartz heating element 750W 115V L 684mm ø 11mm connection F6.3 pizza oven		

1			
Part No.	416765	Ref. No.	D04010
description	quartz tube L 620mm ID ø 8.5mm ED ø 10.5mm		
For models:	RST128, RST228		

1			
Part No.	416751	Ref. No.	D04003
description	quartz tube L 625mm ID ø 9.5mm ED ø 15.5mm		
For models:	RBE12, RBE4, RBE8		

1			
Part No.	420498	Ref. No.	D04037
description	quartz tube WV heating circuits L 725mm W 15mm H 15mm tube ø 15mm		
accessories for	420498		
	Part No.	416750	Ref. No. D01033
	heating coil 1100W 230V for quartz tube 41Ohm L1 545mm L2 435mm ø 7mm		



1			
Part No.	416757	Ref. No.	D04006
description	quartz tube WV L 315mm tube ø 11mm ID ø 9mm		
For models:	SEF80		

1			
Part No.	416709	Ref. No.	D04015
description	quartz tube WV L 320mm tube ø 11mm		
For models:	CT540		
accessories for	416709		
	Part No.	416766	Ref. No. D01036
	heating coil 735W 77V for quartz tube L1 425mm L2 320mm ø 6mm		

1			
Part No.	416760	Ref. No.	D04005
description	quartz tube WV L 365mm tube ø 11mm		
For models:	BAR100, BAR106, BAR200, BAR206		

1			
Part No.	416715	Ref. No.	D04007
description	quartz tube WV L 460mm tube ø 11mm		
For models:	SEM60		



1 			
Part No.	416763	Ref. No.	D04009
description	quartz tube WV L 510mm tube ø 11mm		
For models:	RST127, RST227		
accessories for	416763		
	Part No.	416764	Ref. No. D01035
	heating coil 100W 75V for quartz tube 11.5Ohm L1 300mm L2 255mm ø 5mm		
	Part No.	693022	Ref. No. A09001
	insulator female for male faston L 20mm ø 15mm bore ø 11.5mm		

1 			
Part No.	416731	Ref. No.	D02052
description	heating element 1500W 230V rectangular flange		
For models:	FC26, TH1		

1 			
Part No.	416736	Ref. No.	D04013
description	quartz tube WV L 695mm tube ø 11mm		
For models:	PZ660		

1 			
Part No.	420088	Ref. No.	D02158
description	heating element 2400W 230V heating circuits 1 ID ø 135mm ED ø 145mm L 162mm H 61mm L1 7mm W1 27mm H1 33mm H2 28mm connection male faston 6.3mm tube ø 6.3mm		

1 			
Part No.	416753	Ref. No.	D04011
description	quartz tube WV L 780mm ID ø 10.5mm ED ø 14.5mm		

1 			
Part No.	551108	Ref. No.	B07025
description	spring clip stainless steel for quartz heating element L 39mm W 25mm H 13.5mm bore ø 10mm		

1 			
Part No.	416730	Ref. No.	D02143
description	heating element 2500W 230V heating circuits 1 ID ø 177mm ED ø 189mm L 253mm H 53mm L1 58mm W1 32mm H1 28mm H2 25mm flange length 47mm flange width 17mm hole distance 36mm connection male faston 6.3mm tube ø 6.3mm convection heating element mounting thread M4 rectangular flange		
For models:	CN, FC33		

heating elements for convection

1 			
Part No.	416770	Ref. No.	D02144
description	heating element 1500W 230V heating circuits 1 ID ø 175mm ED ø 188mm L 256mm H 29mm L1 60mm W1 26mm H1 5mm H2 20mm flange length 45mm flange width 16mm hole distance 36mm connection male faston 6.3mm tube ø 6.3mm convection heating element mounting thread M4 rectangular flange with thread bolt		

1 			
Part No.	416734	Ref. No.	D02086
description	heating element 2500W 240V heating circuits 1 ID ø 176mm ED ø 188mm L 252mm H 30mm L1 56mm W1 24mm H1 20mm H2 10mm flange length 47mm flange width 17mm hole distance 35mm connection male faston 6.3mm tube ø 6.3mm convection heating element mounting thread M4 rectangular flange with thread bolt		
For models:	FC34		

1

Part No.	416773	Ref. No.	D02034
description	heating element 3000W 230V heating circuits 1 ID ø 185mm ED ø 198mm L 210mm H 35mm L1 10mm W1 30mm H1 7mm H2 25mm flange length 70mm flange width 22mm hole distance 56mm connection male faston 6.3mm connection length 36mm tube ø 6.3mm convection heating element hole ø 5mm rectangular flange		
For models:	FC60, FC60G		
accessories for	416773		
	Part No.	510368	Ref. No. —
	gasket L 70mm W 23.5mm hole ø 5mm hole distance 56mm FIBER thickness 2mm for heating element		



1

Part No.	416774	Ref. No.	D02045
description	heating element 5000W 230V heating circuits 1 ID ø 224mm ED ø 242mm L 273mm H 41mm L1 25mm W1 35mm H1 3mm H2 38mm flange length 101mm flange width 22mm hole distance 86mm connection male faston 6.3mm connection length 43mm tube ø 8.4mm convection heating element hole ø 4mm rectangular flange		
For models:	FC110, FC110G		



1

Part No.	420087	Ref. No.	D02151
description	heating element 6000W 240V heating circuits 2 ID ø 240mm ED ø 250mm L 267mm H 46mm L1 19mm W1 60mm H1 12mm H2 34mm flange length 100mm flange width 22mm hole distance 86mm connection male faston 6.3mm tube ø 6.2mm convection heating element hole ø 4mm		

radiation heaters



1

Part No.	420540	Ref. No.	D06003 D06006 D06009
description	radiation heater 1500W 230V L 295mm W 250mm H 35mm heating circuits eye connection type threaded cable length 1230mm		

hot plates

round

with radiused edge

for domestic and commercial kitchens



1

Part No.	490130	Ref. No.	D03016
description	hot plate ø 220mm 2000W 230V connection 4 screw clamps with 8mm spill ring		

energy regulators

EGO

1-circuit



1

Part No.		Ref. No.	A04006
description	energy regulator		
For models:	140, 140D, RG11, RG5, RG7, RG9		



1

Part No.	380015	Ref. No.	A04006
description	energy regulator 230V 13A single-circuit turn direction right shaft ø 6x4.6mm shaft L 23mm mounting thread M4 power release 6-100% no. 50.57021.010		



thermostats

bi-metal thermostats

bi-metal thermostats



Part No.	390503	Ref. No.	A06034 A06034/1
description	bi-metal thermostat hole distance 23.5mm switch-off temp. 135°C 1NC 1-pole 10A connection F6.3 2 hole fixing		
For models:	FC110, FC110G, FC60		



Part No.	390652	Ref. No.	A06035 A06035/1
description	bi-metal thermostat hole distance 23.5mm switch-off temp. 170°C 1NCA connection F6.3 vertical		



Part No.	390504	Ref. No.	A06048
description	bi-metal thermostat hole distance 23.8mm switch-off temp. 90°C 1NO 1-pole 16A 250V connection F6.3 2 hole fixing probe ø 16mm		
For models:	FC110, FC110G		

control and safety thermostats

EGO

control thermostats

55.13_ series



Part No.	375007	Ref. No.	A06044
description	thermostat t.max. 110°C temperature range 30-110°C 1-pole 1NO 16A probe ø 6mm probe L 113mm capillary pipe 870mm capillary pipe isolatedmm gland nut M9x1 shaft L 25mm shaft position upper rotation 270°		
accessories for	375007		
	Part No.	110119	Ref. No. —
	knob thermostat t.max. 110°C ø 50mm shaft ø 6x4.6mm shaft flat upper black temperature range 30-110°C rotation 270°		
	Part No.	110241	Ref. No. —
	knob thermostat t.max. 110°C ø 50mm shaft ø 6x4.6mm shaft flat upper black temperature range 30-110°C		



Part No.	375505	Ref. No.	A06042
description	thermostat t.max. 320°C temperature range 50-320°C 1-pole 1NO 16A probe ø 3mm probe L 160mm capillary pipe 870mm capillary pipe isolatedmm gland nut shaft ø 6x4.6mm shaft L 23mm shaft position upper rotation 270°		
For models:	350E, 350ED, 400E, 400ED, 400FE, CN, FC110, FC110G, FC26, FC33, FC34, FC60, FC60G, PSE400, PSE600, PZ330, PZ400, PZ660		



Part No.	375005	Ref. No.	A06002 A06041
description	thermostat t.max. 85°C temperature range 30-85°C 1-pole 1NO 16A probe ø 6mm probe L 92mm capillary pipe 830mm capillary pipe isolatedmm gland nut shaft L 23mm shaft position upper rotation 270° probe material SS		
For models:	RELAIS		
accessories for	375005		
	Part No.	110109	Ref. No. —
	knob thermostat t.max. 85°C ø 60mm shaft ø 6x4.6mm shaft flat upper silver temperature range 30-85°C rotation 270°		
	Part No.	110133	Ref. No. —
	knob thermostat t.max. 85°C ø 50mm shaft ø 6x4.6mm shaft flat upper black temperature range 30-85°C rotation 270°		
	Part No.	110240	Ref. No. —
	knob thermostat t.max. 85°C ø 50mm shaft ø 6x4.6mm shaft flat upper black temperature range 30-85°C		



Part No.	375400	Ref. No.	A06021
description	thermostat t.max. 90°C temperature range 30-90°C 1-pole 1CO 16A probe ø 6mm probe L 98mm capillary pipe 2380mm capillary pipe isolated 1700mm gland nut M9x1 shaft ø 6x4.6mm shaft L 18mm shaft position upper rotation 270°		



55.17_ series

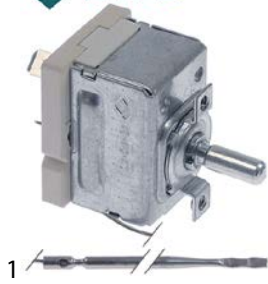

Part No.	371320	Ref. No.	A06032
description	thermostat t.max. 280°C temperature range 30-280°C 1-pole 1NO 16A probe ø 3mm probe L 170mm capillary pipe 860mm capillary pipe isolatedmm gland nut shaft L 14mm shaft position upper rotation 270°		
For models:	DOUBLE PANINI, GED10, GED20, GED30, GED40, GES10, GES20, GES30, GES40, MAJESTIC, PANINI, SAVOYE		

55.34_ series



Part No.	375417	Ref. No.	A06005
description	thermostat t.max. 200°C temperature range 65-200°C 3-pole 3NO 16A probe ø 6mm probe L 79mm capillary pipe 840mm capillary pipe isolatedmm gland nut M9x1 shaft ø 6x4.6mm shaft L 23mm rotation 270°		

safety thermostats

55.11_ series

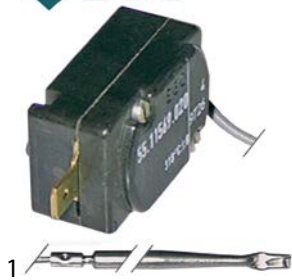

Part No.	375109	Ref. No.	A06004
description	safety thermostat switch-off temp. 240°C 1-pole 16A probe ø 4mm probe L 91mm capillary pipe 530mm capillary pipe isolated 350mm gland nut probe SS		

55.32_ series





Part No.	375600	Ref. No.	A06012
description	safety thermostat switch-off temp. 230°C 3-pole 20A probe ø 6mm probe L 87mm capillary pipe 890mm capillary pipe isolatedmm gland nut		



Part No.	375418	Ref. No.	A06012 A06059
description	safety thermostat switch-off temp. 340°C 3-pole 20A probe ø 4mm probe L 128mm capillary pipe 1190mm capillary pipe isolatedmm gland nut probe SS		

IMIT / TEMPOMATIC / ARTERMO
control thermostats

Part No.	390006	Ref. No.	A06003 A06011	
description	thermostat t.max. 86°C temperature range 0-86°C 1-pole 1CO 16A probe ø 6.5mm probe L 95mm capillary pipe 1500mm capillary pipe isolatedmm gland nut shaft ø 6x4.6mm shaft L 19mm rotation 270°			
accessories for	390006			
	Part No.	110100	Ref. No.	—
	knob thermostat t.max. 90°C 0-90°C ø 42mm shaft ø 6x4.6mm shaft flat -135° black			
	Part No.	110105	Ref. No.	—
	rosette knob ø 42mm ø 56mm zero mark			



TECASA

control thermostats



Part No.	390502	Ref. No.	A06006
description	thermostat capillary pipe isolatedmm gland nut		

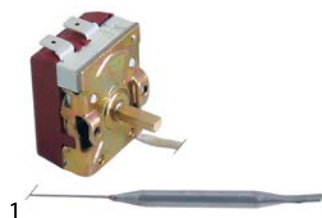

Part No.	375177	Ref. No.	A06018
description	thermostat t.max. 170°C temperature range 50-170°C 1-pole 1NO 16A probe ø 6mm probe L 75mm capillary pipe 420mm capillary pipe isolated 210mm gland nut shaft L 15mm shaft position upper rotation 270°		

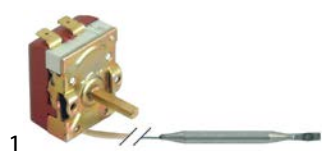

Part No.	375506	Ref. No.	A06007 A06026 A06056
description	thermostat t.max. 190°C temperature range 50-190°C 1-pole 1NO 16A probe ø 6mm probe L 75mm capillary pipe 630mm capillary pipe isolated 140mm gland nut shaft ø 6x4.6mm shaft L 23mm shaft position upper rotation 270°		

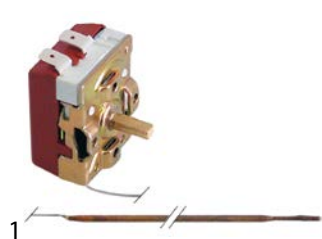

Part No.	375155	Ref. No.	A06019
description	thermostat t.max. 230°C temperature range 45-230°C 1-pole 1NO 16A probe ø 3.1mm probe L 150mm capillary pipe 530mm capillary pipe isolatedmm gland nut shaft L 14mm shaft position upper rotation 270°		
For models:	TH1		



Part No.	375134	Ref. No.	A06032 (old version) NT-253M W11/16 40-280°C
description	thermostat t.max. 280°C temperature range 30-280°C 1-pole 1NO 16A probe ø 3mm probe L 170mm capillary pipe 860mm capillary pipe isolatedmm gland nut shaft L 14mm shaft position upper rotation 270°		

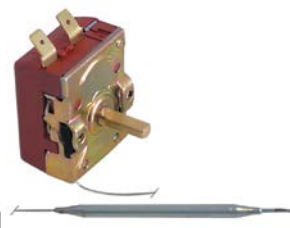

Part No.	375168	Ref. No.	A06049
description	thermostat t.max. 55°C temperature range 30-55°C 1-pole 1NO 16A probe ø 6mm probe L 105mm capillary pipe 880mm capillary pipe isolatedmm gland nut shaft ø 6x4.6mm shaft L 16mm shaft position upper rotation 270°		



Part No.	390500	Ref. No.	A06021
description	thermostat t.max. 95°C temperature range 0-95°C 1-pole 1NO 16A probe ø 6mm probe L 105mm capillary pipe 900mm capillary pipe isolatedmm gland nut shaft ø 6x4.6mm shaft L 16mm shaft position upper rotation 270°		

safety thermostats



Part No.	375452	Ref. No.	A06001
description	safety thermostat switch-off temp. 230°C 1-pole 16A probe ø 6mm probe L 52mm capillary pipe 520mm capillary pipe isolated 70mm gland nut starting temperature 216°C probe SS		
For models:	FD120R		



			
1			
Part No.	375176	Ref. No.	A06017
description	safety thermostat switch-off temp. 230°C 1-pole 16A probe ø 6mm probe L 68mm capillary pipe 430mm		

refrigeration thermostats

DANFOSS

control thermostats

			
1			
Part No.	391001	Ref. No.	SA06043
description	thermostat type 077B0804L capillary pipe 810mm temperature range +6 up to +15°C		



accessories



connecting bows

			
1			
Part No.	550059	Ref. No.	A01023
description	connecting bow short for switch Qty 1 pcs		

switches and momentary switches

rocker/momentary rocker switches

19x13mm				
				
1				
Part No.	301066	Ref. No.	A07005	
description	rocker switch mounting measurements 19x13mm black 2NO 250V 6A 0-I connection male faston 4.8mm ambient temperature max. 85°C protection IP40			
For models:	TH1			
accessories for	301066			
	Part No.	301064	Ref. No.	—
	protective cover for pressure switch external size 23.4x17.4mm internal size 19x13mm H 7.5mm clear mounting measurementsmm			

30x11mm				
				
1				
Part No.	301010	Ref. No.	A07012	
description	rocker switch mounting measurements 30x11mm red 1NO/indicator light 250V 16A 0-I connection male faston 6.3mm ambient temperature max. 85/125°C protection IP40			
For models:	GED10, GED20, GED30, GED40, GES10, GES20, GES30, GES40, PZ330, PZ400, PZ660, WDL100, WDL200			
accessories for	301010			
	Part No.	301035	Ref. No.	—
	protective cover mounting measurements 30x11mm			



30x22mm			
			
1			
Part No.	301202 ¹	Ref. No.	A07025 A07027 A07030
description	rocker switch mounting measurements 30x22mm black 2NO 230V 20A 0-1 connection male faston 6.3mm ambient temperature max. 125/55°C protection IP65 with rubber collar		

¹non-illuminated



			
1			
Part No.	346896 ¹	Ref. No.	A07020 A07025 A07027 A07030
description	rocker switch mounting measurements 30x22mm black 2NO 250V 16A 0-I connection male faston 6.3mm ambient temperature max. 125/55°C protection IP65		
For models:	DOUBLE PANINI, MAJESTIC, PANINI, PSE400, PSE600, RG11, RG5, RG7, RG9, SAVOYE		



¹non-illuminated



			
1			
Part No.	347791	Ref. No.	A07034
description	rocker switch mounting measurements 30x22mm green 2NO 230V 20A illuminated 0-I connection male faston 6.3mm ambient temperature max. 125/55°C protection IP65 with rubber collar		



				
1				
Part No.	301003	Ref. No.	A07032	
description	rocker switch mounting measurements 30x22mm green 2NO 250V 16A illuminated 0-I connection male faston 6.3mm ambient temperature max. 125/55°C protection IP65			
accessories for	301003			
	Part No.	301036	Ref. No.	—
	protective cover internal size 30x22mm for rocker switch mounting measurementsmm			



			
1			
Part No.	301001	Ref. No.	A07003
description	rocker switch mounting measurements 30x22mm red 2NO 250V 16A illuminated 0-I connection male faston 6.3mm ambient temperature max. 125/55°C protection IP65		
For models:	RBG12, RBG4, RBG8		
accessories for	301001		
	Part No.	301036	Ref. No. —
	protective cover internal size 30x22mm for rocker switch mounting measurementsmm		

			
1			
Part No.	301004	Ref. No.	A07022
description	rocker switch mounting measurements 30x22mm black 2CO 250V 16A connection male faston 6.3mm ambient temperature max. 125/55°C protection IP40		
For models:	FC33		
accessories for	301004		
	Part No.	301036	Ref. No. —
	protective cover internal size 30x22mm for rocker switch mounting measurementsmm		

labelled			
			
1			
Part No.	301200	Ref. No.	A070029
description	rocker switch mounting measurements 30x22mm black 2NO 230V 16A 0-1 connection male faston 6.3mm ambient temperature max. 85°C protection IP65 with cover cap		
For models:	GRE40, GRE60, GRE80, RBE12, RBE4, RBE8		
accessories for	301200		
	Part No.	301036	Ref. No. —
	protective cover internal size 30x22mm for rocker switch mounting measurementsmm		

			
1			
Part No.	300125	Ref. No.	A07002
description	rocker switch mounting measurements 30x22mm green 2NO 230V 16A 0-I connection male faston 6.3mm ambient temperature max. 125/55°C protection IP65 with cover cap		
accessories for	300125		
	Part No.	301036	Ref. No. —
	protective cover internal size 30x22mm for rocker switch mounting measurementsmm		

push/momentary push switches

19x13mm			
			
1			
Part No.	301054	Ref. No.	A07014 A07015
description	momentary push switch mounting measurements 19x13mm red 1NO 250V 16A connection male faston 6.3mm ambient temperature max. 105/55°C protection IP65 with cover cap		

			
1			
Part No.	347079 ¹	Ref. No.	A07033
description	push switch mounting measurements 19x13mm green 2NO 250V 16A illuminated connection male faston 6.3mm ambient temperature max. 125°C protection IP65 with cover cap		

¹illuminated

microswitches

lever actuated			
			
1			
Part No.	345699	Ref. No.	A07017
description	microswitch with lever 250V 10A 1NO connection male faston 6.3mm ambient temperature max. 85°C		
For models:	FC110, FC110G		

pin-plunger actuated			
			
1			
Part No.	345060	Ref. No.	A07011
description	microswitch with plunger 250V 16A 1NO connection male faston 6.3mm ambient temperature max. 85°C mounting distance 22mm type BS1010 actuating force: 350g red stroke 9mm		

			
1			
Part No.	345062	Ref. No.	A07023
description	microswitch with plunger 250V 16A 1NO/1NC connection male faston 6.3mm ambient temperature max. 85°C mounting distance 22mm type BS1012 actuating force: 350g red stroke 8mm		
For models:	FC33		



M10



1



Part No.	346864	Ref. No.	A07018 A07035
description	microswitch with plunger thread M10x0.75 thread L 6mm 250V 10A 1NO connection male faston 6.3mm stroke 3mm mounting distance 22mm ambient temperature max. 125°C actuating force: 200g		
For models:	FD120R		

cam switches

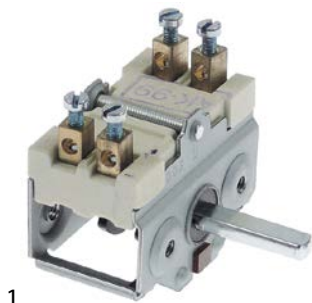
on/off



1

Part No.	300020	Ref. No.	A01015 A01016
description	cam switch 4 operating positions 2NO sequence 0-1-0-1 16A shaft ø 6x4.6mm shaft L 23mm connection screw ceramic		
accessories for	300020		
	Part No.	110135	Ref. No. —
	rosette knob up to ø 52mm		
	Part No.	110231	Ref. No. —
	knob switch 0-1-0-1 t.max.°C ø 50mm shaft ø 6x4.6mm shaft flat upper black		

4-position

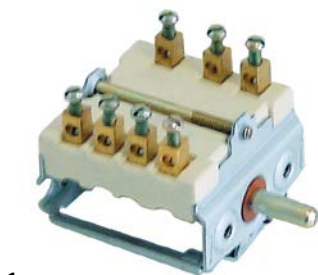

1

Part No.	300094	Ref. No.	A01001
description	cam switch 4 operating positions 1NO/2CO sequence 0-1-2-3 16A shaft ø 6x4.6mm shaft L 15mm connection screw 4-position ceramic		
For models:	BAR100, BAR106, BAR200, BAR206, CT540, GRE40, GRE60, GRE80, RBE12, RBE4, RBE8, RST127, RST128, RST227, RST228, SEF80, SEM60		



1

Part No.	300104	Ref. No.	A01002
description	cam switch 4 operating positions 3NO/1CO sequence 0-1-2-3 32A shaft ø 6x4.6mm shaft L 23mm connection screw ceramic		

4 operating positions



1

Part No.	347101	Ref. No.	A01017
description	cam switch 4 operating positions 1NO/1CO sequence 0-1-2-3 13A shaft ø 6x4.6mm shaft L 23mm connection male faston 6.3mm plastic		

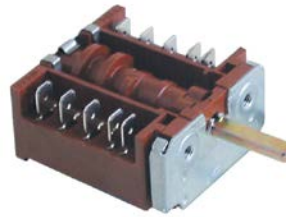

1

Part No.	345320	Ref. No.	A01009
description	cam switch 4 operating positions 4NO sequence 0-1-2-3 16A shaft ø 6x4.6mm shaft L 23mm connection male faston 6.3mm plastic		



1

Part No.	348143	Ref. No.	A01001/1
description	cam switch 4 operating positions 5NO sequence 0-1-2-3 16A shaft ø 6x4.6mm shaft L 23mm connection male faston 6.3mm 8410R plastic		

1

Part No.	300143	Ref. No.	A01014
description	cam switch 4 operating positions sequence 0-1-2-3 13A shaft \varnothing 6x4.6mm shaft L 13mm connection male faston 6.3mm 250V plastic open A+1, B+3 A+1, A+2 A+1, B+4 shaft round sets of contacts 2 ambient temperature max. 150°C		
For models:	FC110G		

5 operating positions

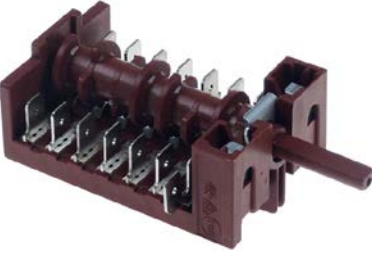

1

Part No.	300238	Ref. No.	A01006
description	cam switch 5 operating positions shaft \varnothing 6x4.6mm connection male faston 6.3mm 7-pole		
For models:	FC60G		

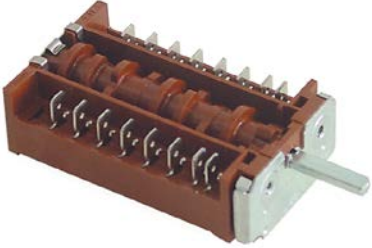

1

Part No.	300142	Ref. No.	A01006
description	cam switch 5 operating positions shaft \varnothing 6x4.6mm connection male faston 7-pole		

operation switches

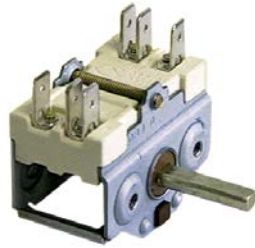

1

Part No.	300001	Ref. No.	A01022	
description	cam switch operation switch 16A sequence 0-1 shaft \varnothing 6x4.6mm connection male faston 6.3mm 2-pole			
accessories for	300001			
	Part No.	551456	Ref. No.	—
	gasket for switch ED \varnothing 14mm ID \varnothing 2.5mm thickness 3.5mm white			

miscellaneous



1

Part No.	347585	Ref. No.	A01020 A01021
description	rotary switch 2NO shaft \varnothing 6x4.6mm shaft L 23mm 2-pole		

encoders and potentiometers



1

Part No.	300144	Ref. No.	A04004 A04005
description	potentiometer 0.5KOhm		
For models:	CT540		



lamps

indicator lights

indicator lights (complete)

ø 9mm



Part No.	359286	Ref. No.	A08006
-----------------	--------	-----------------	--------

description	indicator light ø 9mm 230V green with cord
--------------------	--

For models:	RELAIS
--------------------	--------



Part No.	359287	Ref. No.	A08001
-----------------	--------	-----------------	--------

description	indicator light ø 9mm 230V red
--------------------	--------------------------------

For models:	RELAIS
--------------------	--------

ø12mm

with screw socket



Part No.	359026	Ref. No.	A08019
-----------------	--------	-----------------	--------

description	indicator light ø 12mm 230V red connection male faston 6.3mm model CM/5
--------------------	---



Part No.	359027	Ref. No.	A08020
-----------------	--------	-----------------	--------

description	indicator light ø 12mm 250V green connection male faston 6.3mm
--------------------	--

with plug-in socket



Part No.	359041	Ref. No.	A08009
-----------------	--------	-----------------	--------

description	indicator light ø 12mm green 230V connection male faston 6.3mm temp.-resist. 120°C Qty 1 pcs
--------------------	--

For models:	FC60, FD120R
--------------------	--------------



Part No.	359043	Ref. No.	A08008
-----------------	--------	-----------------	--------

description	indicator light ø 12mm red 230V connection male faston 6.3mm temp.-resist. 120°C Qty 1 pcs
--------------------	--



1

Part No.	359042	Ref. No.	A08003
-----------------	--------	-----------------	--------

description	indicator light ø 12mm yellow 230V connection male faston 6.3mm temp.-resist. 120°C Qty 1 pcs
--------------------	---

For models:	FD120R
--------------------	--------



1

Part No.	359288	Ref. No.	A08011
-----------------	--------	-----------------	--------

description	indicator light ø 12mm 230V green
--------------------	-----------------------------------

For models:	CT540, DOUBLE PANINI, FC26, FC34, GED10, GED20, GED30, GED40, GES10, GES30, GES40, MAJESTIC, PANINI, PSE400, PSE600, PZ330, PZ660, SAVOYE
--------------------	---



1

Part No.	359900	Ref. No.	A08005
-----------------	--------	-----------------	--------

description	indicator light ø 12mm 230V red with cable
--------------------	--

For models:	140, 140D, 350E, 350ED, 400E, 400ED, 400FE, BAR100, BAR106, BAR200, BAR206, CT540, DOUBLE PANINI, FC26, FC34, GED10, GED20, GED30, GED40, GES10, GES20, GES30, GES40, GRE40, GRE60, GRE80, MAJESTIC, PANINI, PSE400, PSE600, PZ330, PZ400, PZ660, RBE12, RBE4, RBE8, RG11, RG5, RG7, RG9, RST127, RST128, RST227, RST228, SAVOYE, SEF80, SEM60
--------------------	--

ø13mm

with plug-in socket



1

Part No.	359141	Ref. No.	A08008
-----------------	--------	-----------------	--------

description	indicator light ø 13mm red 230V connection male faston 6.3mm temp.-resist. 120°C Qty 1 pcs
--------------------	--

LED

accessories



1

Part No.	357248	Ref. No.	SA03093COM
-----------------	--------	-----------------	------------

description	power supply for LEDs 30W primary 170-250VACV secondary 2.5A Qty 1 pcs secondary 12VDCVK
--------------------	--

linear lamps

halogen lamps



1

Part No.	359647	Ref. No.	A18003
-----------------	--------	-----------------	--------

description	halogen lamp socket R7s L 117.6mm 230V 200W IMPORT
--------------------	--



1 			
Part No.	360556	Ref. No.	A18002
description	halogen lamp socket R7s L 74.9mm 230V 80W OSRAM		

infrared lamps

with base type R7s

1 			
Part No.	359628	Ref. No.	A18003
description	infrared lamp socket R7s L 117.6mm 240V 300W IMPORT unjacketed		

sockets for linear lamps

R7s

1 			
Part No.	359735	Ref. No.	A18011
description	lamp socket socket R7s 250V ømm L 16mm W 25mm H 40mm connection cable 230mm mounting distance mm		

fluorescent lamps

fluorescent lamps

G13

1 			
Part No.	359737	Ref. No.	A18013
description	fluorescent lamp socket G13 L 516mm 13W 230V Qty 1 pcs light colour Cool White		
For models:	WDL100, WDL200		

complete with holder

1 			
Part No.	359462	Ref. No.	A18024
description	fluorescent lamp L 545mm W 22mm 13W ø 19mm 230V		

1 			
Part No.	357096	Ref. No.	SA18011
description	fluorescent lamp socket T5 L 900mm W 42mm 21W 230V plug type male/female with switch with mounting clips		

accessories



sockets





1 			
Part No.	359736	Ref. No.	SA18014
description	lamp socket socket G5 L 516mm for fluorescent lamps		

oven lamps

universal oven lamps

mounting diameter 35.5mm

1 			
Part No.	359718	Ref. No.	A18004 A18022
description	oven lamp mounting ø 35.5mm 230V 15W socket E14 temp.-resist. 300°C connection male faston 6.3mm hard glas		
For models:	FC60, FC60G		
spare parts for	359718		
	Part No.	359701	Ref. No. A18022
	description	lamp socket socket E14 220-230V mounting ø 35.5mm connection male faston 6.3mm 15W	
	Part No.	359740	Ref. No. —
	description	light bulb t.max. 300°C socket E14 15W 230V ø 22mm L 48mm lens L 20mm for oven lamp IMPORT	





1 			
Part No.	359701	Ref. No.	A18022
description	lamp socket socket E14 220-230V mounting ø 35.5mm connection male faston 6.3mm 15W		
accessories for	359701		
	Part No.	359705	Ref. No. —
	description	oven lamp glass thr.ø 33.5mm ø 52mm hard glas temp.-resist. 350°C	
	Part No.	359709	Ref. No. —
	description	oven lamp glass thr.ø 33.5mm ø 42mm hard glas temp.-resist. 350°C	
	Part No.	359721	Ref. No. —
	description	gasket silicone ED ø 48mm ID ø 39.5mm thickness 5mm Qty 1 pcs	
	Part No.	359942	Ref. No. —
	description	oven lamp glass thr.ø 33.5mm ø 41mm hard glas temp.-resist. 350°C	



mounting diameter 65.5mm



1

Part No.	359712	Ref. No.	A18005
description	oven lamp mounting ϕ 65.5mm 230V 40W socket E14 temp.-resist. 300°C connection male faston 6.3mm hard glas		
For models:	RBE12, RBE4, RBE8, RBG12, RBG4, RBG8		
spare parts for	359712		
	Part No.	359022	Ref. No. —
	lamp socket socket E14 mounting ϕ 65.5mm connection male faston 6.3mm		
	Part No.	359611	Ref. No. —
	light bulb t.max. 300°C socket E14 40W 230V ϕ 45mm L 75mm lens L 50mm for oven lamp IMPORT		
	Part No.	359722	Ref. No. —
	gasket silicone ID ϕ 57.5mm ED ϕ 68mm thickness 2mm		
	Part No.	359724	Ref. No. —
	oven lamp glass thread ϕ 62mm H 46mm ϕ 74mm hard glas temp.-resist. 350°C		

timers

mechanical timers



1

Part No.	350186	Ref. No.	A02030
description	timer M2 2-pole operation time 120min impulse mechanical 2CO at 250V 16A permanent position yes shaft ϕ 6x4.6mm shaft 6x4.6mm shaft L 23mm mounting distance 28mm		
accessories for	350186		
	Part No.	112627	Ref. No. —
	knob time 120min ϕ 58mm shaft ϕ 6x4.6mm shaft flat lower		



1

Part No.	360173	Ref. No.	A02001 A02002
description	timer M2 3-pole operation time 15min impulse mechanical 3NO at 250V 16A permanent position yes shaft ϕ 6x4.6mm shaft 6x4.6mm shaft L 16mm mounting distance 28mm connection lateral		



1

Part No.	360446	Ref. No.	020014 A02028
description	timer M2 with bell 2-pole operation time 120min impulse mechanical 2NO at 250V 16A permanent position yes shaft ϕ 6x4.6mm shaft 6x4.6mm shaft L 23mm mounting distance 28mm connection rear		



1

Part No.	350008	Ref. No.	A02014 A02028
description	timer M2 with bell 2-pole operation time 120min impulse mechanical 2NO at 250V 16A permanent position yes shaft ϕ 6x4.6mm shaft 6x4.6mm shaft L 24mm mounting distance 28mm connection lateral		



1

Part No.	360460	Ref. No.	A02016 A02029
description	timer M2 with bell 2-pole operation time 15min impulse mechanical 2NO at 250V 16A permanent position yes shaft ϕ 6x4.6mm shaft 6x4.6mm shaft L 23mm with bell mounting distance 28mm connection rear ambient temperature max. 125°C		
For models:	PZ400		





1

Part No.	350043	Ref. No.	A02010
description	timer M17 2-pole operation time 120min impulse mechanical 2NO at 250V 16A permanent position no shaft ϕ 6x4.6mm shaft 6x4.6mm shaft L 17mm mounting distance 28mm mounting thread M8 connection rear		
For models:	TH1		



 <p>1</p>			
Part No.	360164	Ref. No.	A02008
description	timer MT49 2-pole operation time 15min impulse mechanical 2NO at 250V 16A permanent position yes shaft \varnothing 6x4.6mm shaft L 16mm mounting distance 28mm connection lateral		
For models:	BAR100, BAR106, BAR200, BAR206, RST127, RST128, RST227, RST228		

 <p>1</p>			
Part No.	350000	Ref. No.	A02004
description	audible timer operation time 30min \varnothing 57mm shaft \varnothing 6x4.6mm shaft L 24mm mounting distance 28mm		

 <p>1</p>			
Part No.	360097	Ref. No.	A02015
description	timer MT59 1-pole operation time 120min impulse mechanical 1NO at 250V 16A permanent position no shaft \varnothing 6x4.6mm shaft 6x4.6mm shaft L 20mm mounting distance 28mm connection lateral shaft flat upper		
For models:	CN, FC26, FC33, FC34		

 <p>1</p>			
Part No.	360630	Ref. No.	A02004
description	timer operation time 15min \varnothing 57.6mm shaft \varnothing 6.4x4.8mm shaft L 22.4mm mounting distance 28.5mm		

 <p>1</p>			
Part No.	360690	Ref. No.	A02019
description	timer MT59 2-pole operation time 120min impulse mechanical 2NO at 250V 16A permanent position no shaft \varnothing 6x4.6mm shaft 6x4.6mm shaft L 20mm mounting distance 28mm connection lateral shaft flat upper		

contactors

BENEDIKT & JÄGER

power contactors

 <p>1</p>			
Part No.	380774	Ref. No.	A05007
description	power contactor resistive load 32A 230VAC (AC3/400V) 18A/7.5kW main contacts 3NO auxiliary contacts 1NO connection screw connection type K3-18ND10		

audible timers

 <p>1</p>			
Part No.	360151	Ref. No.	A02012
description	audible timer operation time 120min \varnothing 52mm shaft \varnothing 6x4.6mm shaft L 23mm mounting distance 28mm		

GENERAL ELECTRIC (AEG)

power contactors

 <p>1</p>			
Part No.	380238	Ref. No.	A05002 A05006
description	power contactor resistive load 20A 230VAC (AC3/400V) 8.4A/4kW main contacts 3NO auxiliary contacts 1NO connection screw connection type LS0510A type AEG LS0510A type GE MC1A 310A		



ISKRA (FANAL)

power contactors



1

Part No.	380213	Ref. No.	A05008
description	power contactor resistive load 20A 230VAC (AC3/400V) 8.5A/5.5kW main contacts 3NO auxiliary contacts 1NO connection screw connection type Fanal DSL7 10 type ISKRA K07M 10		
For models:	FD120R		

LOVATO

power contactors



1

Part No.	380083	Ref. No.	A05008
description	power contactor resistive load 25A 230VAC (AC3/400V) 9A/4.2kW main contacts 3NO auxiliary contacts 1NC connection screw connection type BF0901A230		

OMRON

power contactors



1

Part No.	380882	Ref. No.	A05002 A05006
description	power contactor resistive load 25A 230VAC AC3 10A main contacts 3NO auxiliary contacts 1NO connection screw connection type J7KN-10D-10 OMRON		

solid state relays

accessories

diodes

diodes



Part No.	693039	Ref. No.	A18006
description	diode		



Part No.	694844	Ref. No.	A18027
description	diode type P2000M		

electronic controllers

AKO

refrigeration controllers

built-in version



1

Part No.	379460 ¹	Ref. No.	SA06030
description	electronic controller AKO type AKO-D14123 mounting measurements 71x29mm 230V voltage AC NTC/PTC relay outputs 1 NO-12A(9) NTC/PTC built-in depth 43mm mode of operation protection IP65 built-in version 1x NTC probe inclusive -50 up to +99/+150°C display 3½ digits		
accessories for	379460		
	Part No.	378261	Ref. No. —
	temperature probe NTC 10kOhm cable thermoplastic probe -40 up to +110°C cable -40 up to +110°C probe ø6x35mm cable length 3m without screw connection 2-wire		
	Part No.	379052	Ref. No. —
	temperature probe PTC 1kOhm cable silicone probe -50 up to +150°C cable -50 up to +180°C probe ø6x40mm cable length 1.5m without screw connection 2-wire		
	Part No.	379053	Ref. No. —
	temperature probe PTC 1kOhm cable PVC probe -50 up to +150°C cable -10 up to 100°C probe ø6x30mm cable length 3m without screw connection 2-wire		
	Part No.	379064	Ref. No. —
	temperature probe PTC 1kOhm cable silicone probe -50 up to +150°C cable -50 up to +180°C probe ø6x40mm cable length 3m without screw connection 2-wire		
	Part No.	379142	Ref. No. —
	temperature probe PTC 1kOhm cable PVC probe -50 up to +150°C cable -10 up to 100°C probe ø6x30mm cable length 1.5m without screw connection 2-wire		
	Part No.	379160	Ref. No. —
	temperature probe NTC 10kOhm cable thermoplastic probe -40 up to +110°C cable -40 up to +110°C probe ø6x14mm cable length 1.5m without screw connection 2-wire		

¹incl. 1x NTC probe
Table continues overleaf



accessories for		379460	
Part No.	379161	Ref. No.	—
	temperature probe NTC 10kOhm cable thermoplastic probe -40 up to +110°C cable -40 up to +110°C probe ø6x14mm cable length 3m without screw connection 2-wire		
Part No.	379342	Ref. No.	—
	temperature probe NTC 10kOhm cable PVC probe -20 up to +80°C cable -10 up to 100°C probe ø6x25mm cable length 1.5m 2-wire protection IP67		
Part No.	379343	Ref. No.	—
	temperature probe NTC 10kOhm cable silicone probe -40 up to +110°C cable -50 up to +180°C probe ø6x40mm cable length 3m 2-wire		
Part No.	379458	Ref. No.	—
	temperature probe NTC 10kOhm cable silicone probe -40 up to +110°C cable -50 up to +180°C probe ø6x40mm cable length 1.5m without screw connection 2-wire		
Part No.	379637	Ref. No.	—
	temperature probe PTC 1kOhm cable PVC probe -50 up to +150°C cable -10 up to 100°C probe ø6x35mm cable length 2m without screw connection 2-wire		
Part No.	379781	Ref. No.	—
	temperature probe PTC 1kOhm cable thermoplastic probe -50 up to +150°C cable -40 up to +110°C probe ø6x14mm cable length 1.5m without screw connection 2-wire		
Part No.	379782	Ref. No.	—
	temperature probe PTC 1kOhm cable thermoplastic probe -50 up to +150°C cable -40 up to +110°C probe ø6x14mm cable length 3m 2-wire resistor 1kOhm		
Part No.	379860	Ref. No.	—
	temperature probe NTC 10kOhm cable PVC probe -20 up to +80°C cable -10 up to 100°C probe ø6x40mm cable length 1.5m without screw connection 2-wire		

electronics

PCBs

	1		
Part No.	402941	Ref. No.	A03024
description	PCB for oven FC 110 EG L 97mm W 72mm suitable for ROLLER GRILL		

	1		
Part No.	403563	Ref. No.	A02017
description	PCB grill Panini L 32mm W 72mm timer		

keypads

front foils

	1		
Part No.	403675	Ref. No.	G0G162
description	front foil fryer RM160 L 400mm W 100mm		

solenoid valves

solenoid valves (water)

various			
	1		
Part No.	370216	Ref. No.	B10006
description	solenoid valve single angled 230VAC inlet 3/4" outlet 11.5mm t.max. 90°C plastic flow regulating valve outlet red suitable for ROLLER GRILL		
For models:	FC110, FC110G		

metal

solenoid valves (various)

	1		
Part No.	370665	Ref. No.	SB10018
description	solenoid valve 2-ways 24VAC inlet 1/8" outlet 1/8" connection male faston 6.3mm L 31mm Olab type series 6000-9000 coil type 6000BH/B1-FN 50/60Hz brass		



compressors

SECOP DANFOSS

R134A

LBP monophase

Lower evaporation temperature below -20°C



1

Part No.	605052	Ref. No.	SA03024/F
description	compressor coolant R134a type TL5G 220-240V 50Hz LBP/HBP fully hermetic 7.5kg 1/6HP cylinder capacity 5.08cm ³ RSIR/CSIR H 173mm 69W 97W 132W 172W 220W 277W 345W 423W 461W test method ASHRAE		
spare parts for	605052		
	Part No.	380076	Ref. No. —
	start relay DANFOSS 117U6000 HST		

HBP monophase

High evaporation temperature above -15°C



1

Part No.	605052	Ref. No.	SA03024/F
description	compressor coolant R134a type TL5G 220-240V 50Hz LBP/HBP fully hermetic 7.5kg 1/6HP cylinder capacity 5.08cm ³ RSIR/CSIR H 173mm 69W 97W 132W 172W 220W 277W 345W 423W 461W test method ASHRAE		
spare parts for	605052		
	Part No.	380076	Ref. No. —
	start relay DANFOSS 117U6000 HST		

fans

axial fans

import



1

Part No.	601604 ¹	Ref. No.	SA03018
description	axial fan L 119mm W 119mm H 38mm 230VAC 50/60Hz 17/15W bearing slide bearing manuf. no. AA1282HS-AT connection cable 300mm fan wheel ø 110mm temp.-resist. 70°C input current 0.1A airflow 130m ³ /h 2600rpm		

¹with slide bearings

refrigeration fans

refrigeration motors universal

ELCO

N series - standard



1

Part No.	601843	Ref. No.	SA03012
description	fan motor ELCO 10W 230V 50/60Hz bearing slide bearing L1 49mm L2 65mm L3 87mm W 82mm connection cable 1000mm cable length 1000mm 1300/1550rpm 3 mounting options N10-20/158		
spare parts for	601843		
	Part No.	601413	Ref. No. —
	fixing plate suitable for fanwheel ED ø 32mm shaft ø 7 mounting distance 26mm		



hot air motors



1

Part No.	601122	Ref. No.	A03010
description	hot air fan 230V 1 phase 50Hz 0.12kW 2650rpm speeds 1 L1 100mm L2 34mm L3 33mm L4 178mm fan wheel ø 180mm type R2E180-AH05-10		
For models:	FC110, FC110G		



1

Part No.	601548	Ref. No.	A03006	
description	hot air fan 220-240V 40W 50/60Hz L1 65mm L2 11mm L3 25mm L4 87mm fan wheel ø 150mm FIME type C25R8023CLH			
For models:	CN, FC26, FC33, FC34, TH1			
accessories for	601548			
	Part No.	601441	Ref. No.	—
	fan wheel ø 150mm W 25mm shaft intake ø 6x5mm stainless steel blades 7			

hot air fans

miscellaneous



1

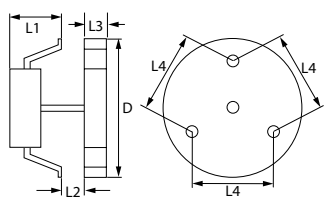



Part No.	500902	Ref. No.	A03057	
description	fan motor 220V 55W 50/60Hz L1 68mm FIME type L25R without fan wheel			
accessories for	500902			
	Part No.	550879	Ref. No.	—
	insulation ø 130mm thickness 3mm hole ø 20mm for hot air fan			

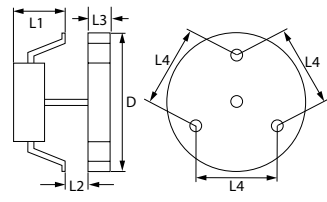

1



Part No.	601011	Ref. No.	A03001 A03006	
description	hot air fan 220-240V 40W 50/60Hz L1 65mm L2 15mm L3 25mm L4 87mm fan wheel ø 150mm FIME type C25R8023CLH			
accessories for	601011			
	Part No.	550879	Ref. No.	—
	insulation ø 130mm thickness 3mm hole ø 20mm for hot air fan			
	Part No.	601260	Ref. No.	—
	nut thread M6L IT for hot air fan			

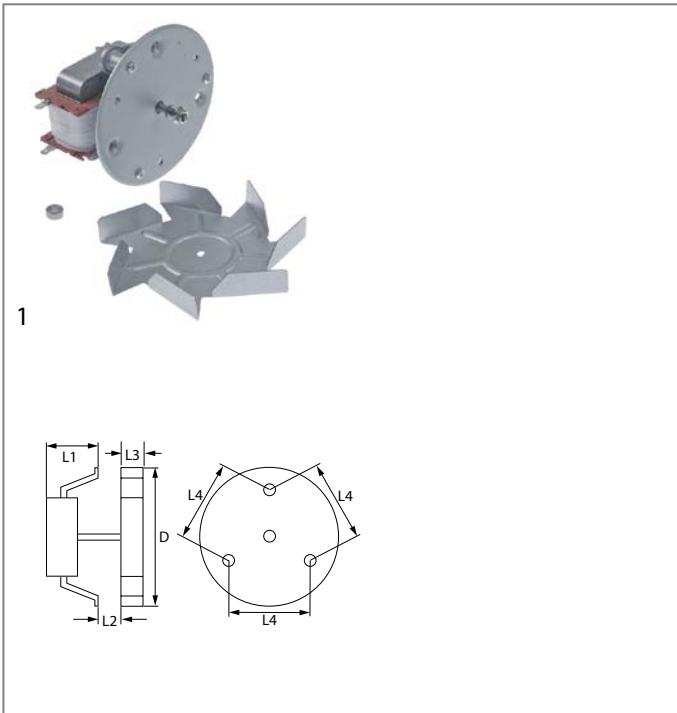

Part No.	601860	Ref. No.	A03057 + A03058 + B08050
description	hot air fan 230V 55W 50/60Hz L1 83mm L2 19mm L3 20mm L4 87mm fan wheel ø 150mm FIME		

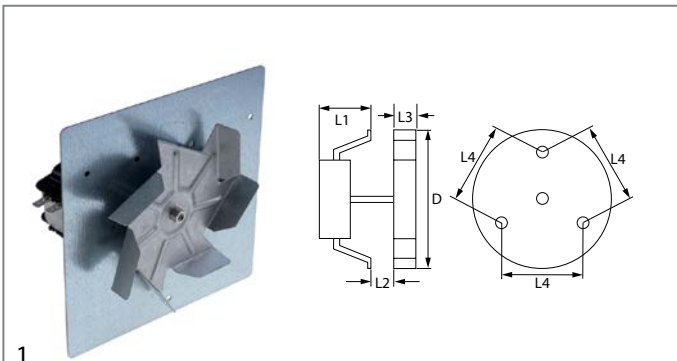

Part No.	601177	Ref. No.	A03001
description	hot air fan 230V 55W L1 83mm L2 19mm L3 20mm L4 87mm fan wheel ø 150mm L25R7570		
For models:	FC60, FC60G		

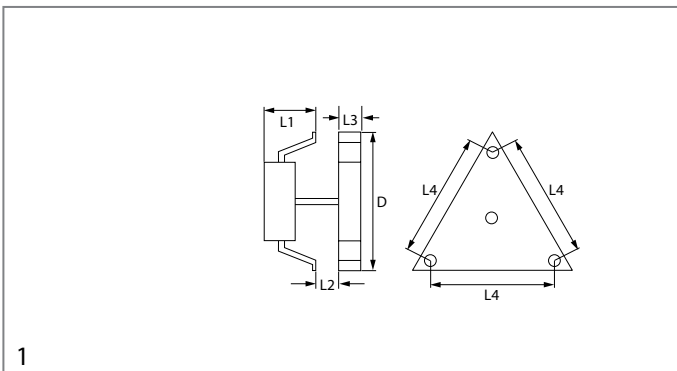

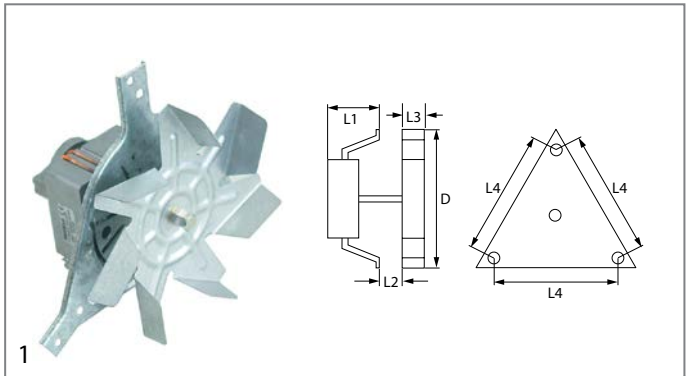

Part No.		Ref. No.	A03006
description	hot air fan		

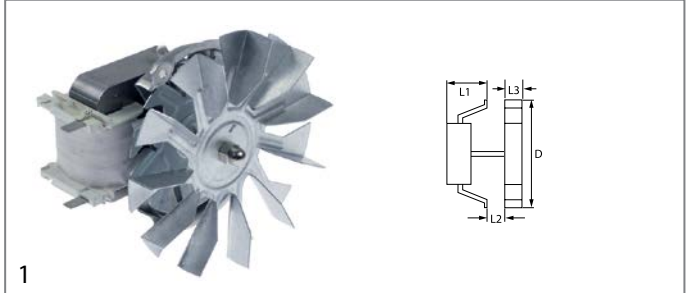

Part No.	601118	Ref. No.	A03001
description	hot air fan 230V 40W L2 19mm fan wheel ø 150mm		



Part No.	601796	Ref. No.	A03044 A03063
description	hot air fan 220/240V 30W L1 62mm L2 15mm L3 16.5mm fan wheel ø 120mm PLASET shaft M6L		

spare parts for	601796			
	Part No.	601259	Ref. No.	—
	fan wheel ø 120mm W 16mm shaft intake ø 6x5mm blades 11			
	Part No.	601260	Ref. No.	—
	nut thread M6L IT for hot air fan			

accessories

fan wheels for hot air fans



Part No.	601200	Ref. No.	A03058
description	fan wheel ø 150mm W 20mm shaft intake ø 6x5mm zinc-plated blades 7		



miscellaneous



1

Part No.	551320	Ref. No.	B08050
description	distance washers SS ø 12mm thickness 5mm hole ø 6mm		

motors

gear motors

for grills



1

Part No.	500603	Ref. No.	A03038 A03064
description	gear motor 230V 50/60Hz shaft ø 8mm L 91mm W 64mm H 118mm for hot dog grill type 2512-B01661-1392 RMS		
For models:	RG11, RG5, RG7, RG9		
accessories for	500603		
	Part No.	693160	Ref. No. B01004
	gear wheel teeth 20 shaft intake ø 8mm ø 38mm hub ø 20mm stainless steel		



1

Part No.	500602	Ref. No.	A03007
description	gear motor CROUZET 220V 50/60Hz 4rpm shaft ø 8x7mm		

for gyros grills



1

Part No.	500600	Ref. No.	A03025 A03050+A03051
description	gear motor CROUZET type 80644034 220V 50/60Hz shaft ø 15mm shaft diameter for shaft 8x8mm L 92mm W 63mm H 70mm for gyro grill		
For models:	GRE40, GRE60, GRE80, GRG40, GRG60, GRG80		



1

Part No.	500748	Ref. No.	A03008 A03054
description	gear motor KENTA type K9115106 28W 230V 50Hz 2.5rpm shaft ø 15mm shaft diameter 9x9mm		
For models:	RBE12, RBE4, RBE8, RBG12, RBG4, RBG8		

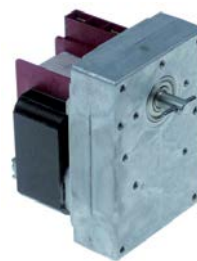

1

Part No.	500993	Ref. No.	A03050 A03055
description	gear motor KENTA type K9175001 30W 230V voltage AC 50Hz 1rpm shaft ø 8mm L 105mm W 72mm H 86mm for gyro grill		



1

Part No.	601765	Ref. No.	A03053
description	gear motor KENTA type K9177150 50W 230V 50Hz 2rpm shaft ø 21mm L 105mm W 70mm H 130mm skewer 12x12mm		



miscellaneous



1			
Part No.	500604	Ref. No.	A03036
description	gear motor for toaster		
For models:	CT540		



1			
Part No.	601728	Ref. No.	A03026
description	gear motor TEMPOMATIC type TY49-II 4W 230V voltage AC 50Hz 2.5rpm shaft ø 5.4x7mm for vitrine		

fuses

fine fuses

fine fuse holders



1			
Part No.	358125	Ref. No.	A18019 SA18022
description	fuse holder suitable fuse ø6.3x32mm ø 15mm thread M13 1-pole 10A rated 250V connection F4.8		

electric accessories

cables

power supply cables



1			
Part No.	551085	Ref. No.	C03013 SC03024
description	cable CEE7/7 type E+F 3-pole contacts P+N+E 1.5mm ² max. 16A max 230V 2m with plug H05VV-F 3G1.5		



1			
Part No.	551203	Ref. No.	C03007
description	connecting cable CEE7/7 type E+F 3-pole contacts P+N+E 2.5mm ² max. 16A max 230V 2m H07 RN-F with plug		



1			
Part No.	551321	Ref. No.	C03011
description	power lead BS1363 3-pole contacts P+N+E 1.5mm ² max. 13A max 250V 1.6m with fuse countries UK Qty 1 pcs connection female faston 6.3mm black		



1			
Part No.	551193	Ref. No.	C03002
description	power lead CEE7/7 type E+F 3-pole contacts P+N+E 1.5mm ² max. 16A max 230V 1.37m H07RN-F 3G1.50mm ² countries A/B/D/F/I		

accessories

insulated hoses

up to 250°C



1			
Part No.	550019	Ref. No.	C04007
description	insulating hose ID ø 8mm Qty 10m silicone coated glass fibre braiding permanent temperature 250°C t.max. 290°C flashover voltage 3000V red/brown		

protection hoses

miscellaneous

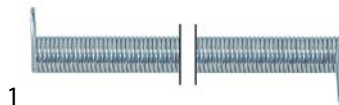

1			
Part No.	693042	Ref. No.	C04005 C04008
description	protective metal tube		
For models:	DOUBLE PANINI, MAJESTIC, PANINI, SAVOYE		



cable glands

cable glands



1

Part No.	550313	Ref. No.	A12008
description	cable gland ID \varnothing 9mm mounting \varnothing 11mm ED \varnothing 16mm Neoprene -30 up to +90°C Qty 10 pcs		

threaded cable glands

screw connections



1

Part No.	551288 ¹	Ref. No.	A10032
description	cable gland thread PG16 cable \varnothing 14mm mounting \varnothing 22.5mm WS 27 plastic Qty 1 pcs		
For models:	FD120R		

¹incl. fastening nut

terminals

porcelain clamps



1

Part No.	550115	Ref. No.	A16021
description	porcelain terminal block 2-pole 10mm ² max. 30A max 450V L 37mm W 37mm H 23mm mounting distance mm Qty 1 pcs		



1

Part No.	550112	Ref. No.	A16003
description	porcelain terminal block 2-pole 2.5mm ² max. 10A max 250V t.max. 200°C L 22mm W 17mm H 15mm mounting distance mm Qty 1 pcs		

connection terminals with screw/faston connections



1

Part No.	505212	Ref. No.	A16012
description	power terminal block 2-pole max. 20A max 600V connection \varnothing 2.5mm ² / F6.3 temp.-resist. 150°C cross section 4mm ²		
For models:	DOUBLE PANINI, GED10, GED20, GED30, GED40, GES10, GES20, GES30, GES40, MAJESTIC, PANINI, SAVOYE		



1

Part No.	550458	Ref. No.	A16013
description	power terminal block 3-pole max. 25A max 450V connection \varnothing 2.5mm ² / F6.3 temp.-resist. 150°C		



1

Part No.	550411	Ref. No.	A16014
description	power terminal block 6-pole max. 40A max 450V connection \varnothing 6mm ² / F6.3 temp.-resist. 150°C cross section 6mm ²		

connection terminals with strain relief



1

Part No.	550356	Ref. No.	A10002
description	power terminal block 2-pole max 450V max. 16A cable \varnothing 15mm cross section 1.5mm ²		
For models:	RELAIS		

connection boxes



1

Part No.	550300	Ref. No.	A10007
description	power terminal block 3-pole contacts P+N+E		

terminal boards



1

Part No.	550413	Ref. No.	A16010
description	terminal board 3-pole thread M5 L 55mm W 36mm		
For models:	FD120R, GRE40, GRE60, GRE80		

























			
1			
Part No.	550459	Ref. No.	A16004
description	terminal board 3-pole thread M6 L 70mm W 45mm		
For models:	RBE12, RBE4, RBE8		

gas taps

PEL

20S series

			
1			
Part No.	101094	Ref. No.	E02030 E02036
description	gas tap PEL type 20S gas inlet M16x1.5 (tube ø 10mm) bypass nozzle ø 0.35mm gas outlet M16x1.5 (tube ø 10/8mm) thermocouple connection M8x1 pilot connection shaft ø 8x6.5mm shaft L 22/15mm shaft flat lower		
For models:	350G, 350GD, 400G, 400GD		
spare parts for	101094		
	Part No.	100408	Ref. No. —
	bypass nozzle type PEL20/21 bore ø 0.35mm thread M5x0.5		
	Part No.	101060	Ref. No. —
	magnet unit standard L 39mm D1 ø 15.4mm D2 ø 11mm suitable for PEL20-21/JUNKERS/EGA		
	Part No.	101205	Ref. No. —
	gas tap front part shaft ø 8x6.5mm shaft L 22/15mm shaft flat upper/lower suitable for PEL20		
	Part No.	101230	Ref. No. —
	thermocouple nut T1: M8x1 T2: M18x1 aluminium		
accessories for	101094		
	Part No.	101278	Ref. No. —
	olive for pipe ø 10mm Qty 1 pcs		
	Part No.	101300	Ref. No. —
	union nut thread M16x1.5 tube ø 10mm		
	Part No.	101450	Ref. No. —
	olive for pipe ø 8mm L 12.7mm Qty 1 pcs ED ø 10mm		
	Part No.	101451	Ref. No. —
	union nut thread M16x1.5 tube ø 8mm		
	Part No.	110081	Ref. No. —
	knob ø 70mm shaft ø 8x6.5mm shaft flat universal		
	Part No.	110083	Ref. No. —
	knob dial plate gas tap without ignition flame silver		

			
1			
Part No.	101491	Ref. No.	E02030
description	gas tap PEL type 20S gas inlet M16x1.5 (tube ø 10mm) bypass nozzle ø 0.35mm gas outlet M16x1.5 (tube ø 10/8mm) thermocouple connection M9x1 pilot connection shaft ø 8x6.5mm shaft L 22/15mm shaft flat lower		
For models:	GRG40, GRG60, GRG80, PSG400, PSG600, RBG12, RBG4, RBG8		
spare parts for	101491		
	Part No.	100408	Ref. No. —
	bypass nozzle type PEL20/21 bore ø 0.35mm thread M5x0.5		
	Part No.	101060	Ref. No. —
	magnet unit standard L 39mm D1 ø 15.4mm D2 ø 11mm suitable for PEL20-21/JUNKERS/EGA		
	Part No.	101205	Ref. No. —
	gas tap front part shaft ø 8x6.5mm shaft L 22/15mm shaft flat upper/lower suitable for PEL20		
	Part No.	101231	Ref. No. —
	thermocouple nut T1: M9x1 T2: M18x1		
accessories for	101491		
	Part No.	101287	Ref. No. —
	olive for pipe ø 6mm Qty 1 pcs		
	Part No.	101300	Ref. No. —
	union nut thread M16x1.5 tube ø 10mm		
	Part No.	101450	Ref. No. —
	olive for pipe ø 8mm L 12.7mm Qty 1 pcs ED ø 10mm		
	Part No.	101451	Ref. No. —
	union nut thread M16x1.5 tube ø 8mm		
	Part No.	110081	Ref. No. —
	knob ø 70mm shaft ø 8x6.5mm shaft flat universal		
	Part No.	110083	Ref. No. —
	knob dial plate gas tap without ignition flame silver		



21S series

			
1			
Part No.	101095	Ref. No.	E02031
description	gas tap PEL type 21S gas inlet M16x1.5 (tube ø 10mm) bypass nozzle ø 0.35mm gas outlet M16x1.5 (tube ø 10/8mm) thermocouple connection M8x1 pilot connection M10x1 shaft ø 8x6.5mm shaft L 22/15mm shaft flat lower		
spare parts for	101095		
	Part No.	100408	Ref. No. —
	bypass nozzle type PEL20/21 bore ø 0.35mm thread M5x0.5		

Table continues overleaf



spare parts for		101095	
	Part No.	101060	Ref. No. —
	magnet unit standard L 39mm D1 ø 15.4mm D2 ø 11mm suitable for PEL20-21/JUNKERS/EGA		
	Part No.	101206	Ref. No. —
	gas tap front part shaft ø 8x6.5mm shaft L 22/15mm shaft flat upper/lower suitable for PEL21		
	Part No.	101230	Ref. No. —
	thermocouple nut T1: M8x1 T2: M18x1 aluminium		
accessories for		101095	
	Part No.	100908	Ref. No. —
	union screw thread M10x1 for pipe ø 4mm Qty 1 pcs		
	Part No.	100909	Ref. No. —
	union screw thread M10x1 for pipe ø 6mm Qty 1 pcs		
	Part No.	101246	Ref. No. —
	olive for pipe ø 4mm Qty 1 pcs		
	Part No.	101278	Ref. No. —
	olive for pipe ø 10mm Qty 1 pcs		
	Part No.	101286	Ref. No. —
	olive ID ø 6mm Qty 1 pcs		
	Part No.	101300	Ref. No. —
	union nut thread M16x1.5 tube ø 10mm		
	Part No.	101450	Ref. No. —
	olive for pipe ø 8mm L 12.7mm Qty 1 pcs ED ø 10mm		
	Part No.	101451	Ref. No. —
	union nut thread M16x1.5 tube ø 8mm		
	Part No.	110081	Ref. No. —
	knob ø 70mm shaft ø 8x6.5mm shaft flat universal		
	Part No.	112206	Ref. No. —
	knob dial plate silver gas tap PEL21/22/23 t.max.°C ED ø 63mm ID ø 45.5mm		

			
1			
Part No.	101397	Ref. No.	E02031
description	gas tap PEL type 21S gas inlet M16x1.5 (tube ø 10mm) bypass nozzle ø 0.35mm gas outlet M16x1.5 (tube ø 10/8mm) thermocouple connection M9x1 pilot connection M10x1 shaft ø 8x6.5mm shaft L 22/15mm shaft flat lower		
For models:	GSM60, SGF80		
spare parts for		101397	
	Part No.	100408	Ref. No. —
	bypass nozzle type PEL20/21 bore ø 0.35mm thread M5x0.5		
	Part No.	101060	Ref. No. —
	magnet unit standard L 39mm D1 ø 15.4mm D2 ø 11mm suitable for PEL20-21/JUNKERS/EGA		

spare parts for		101397	
	Part No.	101206	Ref. No. —
	gas tap front part shaft ø 8x6.5mm shaft L 22/15mm shaft flat upper/lower suitable for PEL21		
	Part No.	101231	Ref. No. —
	thermocouple nut T1: M9x1 T2: M18x1		
accessories for		101397	
	Part No.	100908	Ref. No. —
	union screw thread M10x1 for pipe ø 4mm Qty 1 pcs		
	Part No.	100909	Ref. No. —
	union screw thread M10x1 for pipe ø 6mm Qty 1 pcs		
	Part No.	101246	Ref. No. —
	olive for pipe ø 4mm Qty 1 pcs		
	Part No.	101278	Ref. No. —
	olive for pipe ø 10mm Qty 1 pcs		
	Part No.	101286	Ref. No. —
	olive ID ø 6mm Qty 1 pcs		
	Part No.	101300	Ref. No. —
	union nut thread M16x1.5 tube ø 10mm		
	Part No.	101450	Ref. No. —
	olive for pipe ø 8mm L 12.7mm Qty 1 pcs ED ø 10mm		
	Part No.	101451	Ref. No. —
	union nut thread M16x1.5 tube ø 8mm		
	Part No.	110081	Ref. No. —
	knob ø 70mm shaft ø 8x6.5mm shaft flat universal		
	Part No.	112206	Ref. No. —
	knob dial plate silver gas tap PEL21/22/23 t.max.°C ED ø 63mm ID ø 45.5mm		

SABAF

			
1			
Part No.	103277	Ref. No.	E02218
description	gas tap SABAF type 10 gas inlet pipe flange ø14mm bypass nozzle ø 0mm gas outlet 1/4" (tube ø 8mm) front fixing M13x1 thermocouple connection M8x1 shaft ø 8x6.5mm shaft L 23/17mm shaft flat left		



miscellaneous

			
1			
Part No.	109105	Ref. No.	E02145
description	gas tap gas inlet 1/2" (tube ø 15mm) bypass nozzle ø 0.4mm gas outlet M14x1.5 (tube ø 8mm) pilot connection thermocouple connection M9x1 shaft ø 8x6.5mm shaft L 18.5/10mm shaft flat left kit front fixing M10x1		

			
1			
Part No.	109206	Ref. No.	E02217
description	gas tap thermocouple connection M8x1 shaft ø 8x6.5mm shaft L 24/17mm		

gas thermostats



PEL

25ST series





			
1			





Part No.	107780	Ref. No.	E02191 E02279
description	gas thermostat PEL type 25ST up to 190°C gas inlet M16x1.5 (tube ø 10mm) bypass nozzle ø 0mm gas outlet M16x1.5 (tube ø 10/8mm) thermocouple connection M9x1 pilot connection M10x1 capillary pipe 1200mm probe ø 6mm probe L 195mm shaft ø 8x6.5mm shaft L 21/15mm shaft flat upper		

spare parts for 107780

	Part No.	101060	Ref. No.	—
	description	magnet unit standard L 39mm D1 ø 15.4mm D2 ø 11mm suitable for PEL20-21/JUNKERS/EGA		
	Part No.	106191	Ref. No.	—
	description	bypass nozzle type PEL22 bore ø 0mm thread M6x0.5		
	Part No.	106200	Ref. No.	—
	description	nut thread M9x1 suitable for PEL 24/25S		

accessories for 107780

	Part No.	100908	Ref. No.	—
	description	union screw thread M10x1 for pipe ø 4mm Qty 1 pcs		
	Part No.	100909	Ref. No.	—
	description	union screw thread M10x1 for pipe ø 6mm Qty 1 pcs		
	Part No.	101246	Ref. No.	—
	description	olive for pipe ø 4mm Qty 1 pcs		
	Part No.	101278	Ref. No.	—
	description	olive for pipe ø 10mm Qty 1 pcs		

accessories for	107780			
	Part No.	101286	Ref. No.	—
	description	olive ID ø 6mm Qty 1 pcs		
	Part No.	101300	Ref. No.	—
	description	union nut thread M16x1.5 tube ø 10mm		
	Part No.	101450	Ref. No.	—
	description	olive for pipe ø 8mm L 12.7mm Qty 1 pcs ED ø 10mm		
	Part No.	101451	Ref. No.	—
	description	union nut thread M16x1.5 tube ø 8mm		

			
1			
Part No.	107838	Ref. No.	E02298
description	gas thermostat PEL type 25ST up to 210°C gas inlet M16x1.5 (tube ø 10mm) bypass nozzle ø 0mm gas outlet M16x1.5 (tube ø 10/8mm) thermocouple connection M9x1 pilot connection M10x1 capillary pipe 1200mm probe ø 6mm probe L 195mm shaft ø 8x6.5mm shaft L 21/15mm shaft flat upper		

ignition parts

pilot burners





SIT

100 series

			
1			

Part No.	106901	Ref. No.	E02188
description	pilot burner SIT type 100 series 1 flame nozzle ø 0.2mm gas connection 6mm		

spare parts for 106901

	Part No.	100854	Ref. No.	—
	description	pilot burner bracket double		
	Part No.	100916	Ref. No.	—
	description	compression spring for pilot burner Qty 1 pcs		
	Part No.	100917	Ref. No.	—
	description	gasket for pilot burner Qty 1 pcs aluminium		
	Part No.	100918	Ref. No.	—
	description	screw for pilot burner		

accessories for 106901























	Part No.	100904	Ref. No.	—
	description	locking screw M10x1 for pipe ø 4mm Qty 1 pcs		

Table continues overleaf



accessories for		106901		
Part No.		100905	Ref. No.	—
	locking screw M10x1 for pipe ø 6mm Qty 1 pcs			
	pilot tube copper pipe ø 4mm thickness 1mm L 3000mm			
	pilot tube copper pipe ø 6mm thickness 1mm L 3000mm			
	pilot burner nozzle LPG code 25 bore ø 0.25mm Qty 1 pcs			

 <p>1</p>				
Part No.	106903	Ref. No.	E02032	
description	pilot burner SIT type 100 series 3 flames nozzle ø 0.2mm gas connection 6mm			
For models:	GSM60, SGF80			
spare parts for	106903			
	Part No.	100245	Ref. No.	E02086
	pilot burner nozzle LPG code 20 bore ø 0.2mm Qty 1 pcs thread M8x0.75			
	Part No.	100854	Ref. No.	—
	pilot burner bracket double			
	Part No.	100885	Ref. No.	—
	air mixing sleeve for pilot burner Qty 1 pcs			
	Part No.	100916	Ref. No.	—
	compression spring for pilot burner Qty 1 pcs			
	Part No.	100917	Ref. No.	—
	gasket for pilot burner Qty 1 pcs aluminium			
	Part No.	100918	Ref. No.	—
	screw for pilot burner			
	Part No.	107162	Ref. No.	—
	pilot burner cap SIT 3 flames Hmm Lmm Qty 1 pcs			
	Part No.	107701	Ref. No.	—
	pilot burner bottom part SIT 100 series nozzle ø 0.2mm			
accessories for		106903		
	Part No.	100245	Ref. No.	E02086
	pilot burner nozzle LPG code 20 bore ø 0.2mm Qty 1 pcs thread M8x0.75			
	Part No.	100246	Ref. No.	E02086
	pilot burner nozzle natural gas bore ø 0.35mm Qty 1 pcs thread M8x0.75			
	Part No.	100904	Ref. No.	—
	locking screw M10x1 for pipe ø 4mm Qty 1 pcs			

accessories for		106903		
Part No.		100905	Ref. No.	—
	locking screw M10x1 for pipe ø 6mm Qty 1 pcs			
	pilot tube copper pipe ø 4mm thickness 1mm L 3000mm			
	pilot tube copper pipe ø 6mm thickness 1mm L 3000mm			
	pilot burner nozzle SIT natural/liquid gas bore ø 0.25mm Qty 1 pcs			
	pilot burner bottom part SIT 100 series nozzle ø 0.25mm			
	pilot burner bottom part SIT 100 series nozzle ø 0.35mm			

accessories				
pilot burner nozzles				
 <p>1</p>				
Part No.	100245	Ref. No.	E02086	
description	pilot burner nozzle LPG code 20 bore ø 0.2mm Qty 1 pcs thread M8x0.75			

 <p>1</p>				
Part No.	100246	Ref. No.	E02086	
description	pilot burner nozzle natural gas bore ø 0.35mm Qty 1 pcs thread M8x0.75			

piezoelectric igniters

miscellaneous				
 <p>1</p>				
Part No.	107692	Ref. No.	E02212 E02215	
description	service kit piezoelectric igniter ignition electrode included			



thermocouples

plug-in thermocouples

plug-in thermocouples standard

with barrel socket ø6(6.5)mm

thermocouples SIT

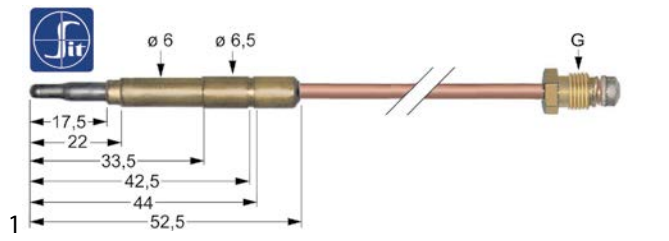

Part No.	107609	Ref. No.	E02033
description	thermocouple SIT M9x1 L 600mm plug connection ø6.0(6.5)mm		
For models:	RBG12, RBG4, RBG8		

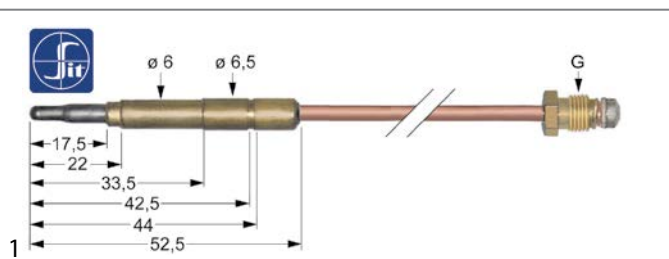

Part No.	107611	Ref. No.	E02011
description	thermocouple SIT M9x1 L 850mm plug connection ø6.0(6.5)mm		

thermocouples with aluminised tip

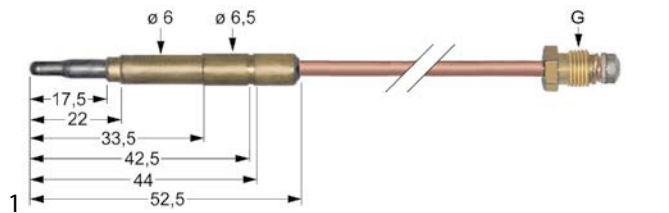

Part No.	102041	Ref. No.	E02033
description	thermocouple M9x1 L 600mm plug connection ø6.0(6.5)mm		



Part No.		Ref. No.	E02033
description	thermocouple set		

plug-in thermocouples with cable link

1

Part No.	107522	Ref. No.	E02201 E02253
description	thermocouple L 1300mm connection M9x1 plug connection ø6.0mm		

threaded thermocouples

threaded thermocouples standard

with socket with thread M8x1

SIT

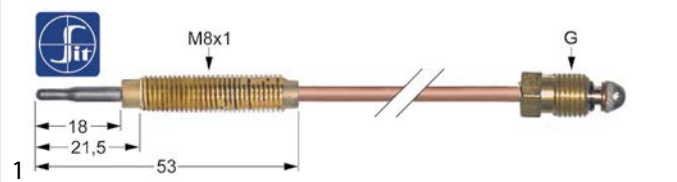

Part No.	107628	Ref. No.	E02237
description	thermocouple SIT M8x1 L 320mm M8x1		
accessories for	107628		
	Part No.	102067	Ref. No. —
	nut thread M8x1 H 3mm brass Qty 1 pcs type SEF 1		

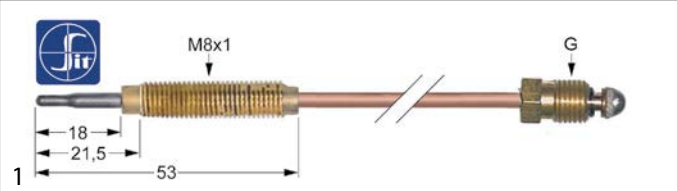

Part No.	107638	Ref. No.	E02011 E02029
description	thermocouple SIT M9x1 L 1000mm M8x1		
For models:	GRG40, GRG60, GRG80, GSM60, SGF80		

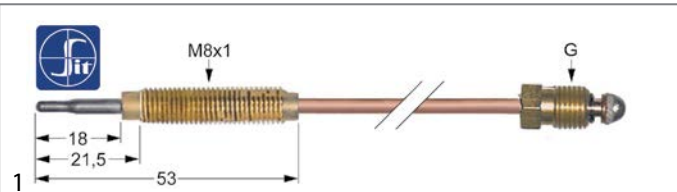

Part No.	107639	Ref. No.	E02147
description	thermocouple SIT M9x1 L 1200mm M8x1		



extensions

1 

Part No.	102241	Ref. No.	E02033 E02081
description	thermocouple extension flexible thread M9x1 - M9x1 L 500mm		

1 

Part No.	102811	Ref. No.	E02251
description	thermocouple extension thread M9x1 - M9x1 L 600mm		

gas burners

hob burners

producer-specific hob burners

ROLLER GRILL

1 

Part No.	103059	Ref. No.	E01015
description	burner ø 125mm for burner cap ø 124mm nozzle mounting 1/4" H 102mm with burner cover and nozzle		

bar burners

bar burners

1 

Part No.	105505	Ref. No.	E01006
description	bar burner ø 40mm Wmm Hmm L 288mm griddle flange ø 61mm		
For models:	PSG400, PSG600		

ceramic burners

1 

Part No.	105509	Ref. No.	E01005
description	ceramic burner L 220mm W 168mm firing range 178x125mm for gyro grill		
For models:	GRG40, GRG60, GRG80		

1 

Part No.	104757	Ref. No.	E01012 E01012 + 71061
description	ceramic burner L 415mm W 80mm firing range 395x65mm 2.6kW		
accessories for	104757		
	Part No.	104758	Ref. No.
nozzle set for ceramic burner EG+FG			

1 



Part No.	107516	Ref. No.	E01001
description	ceramic burner L 430mm W 80mm firing range 390x38mm H 46mm		
For models:	SGM60		

1 

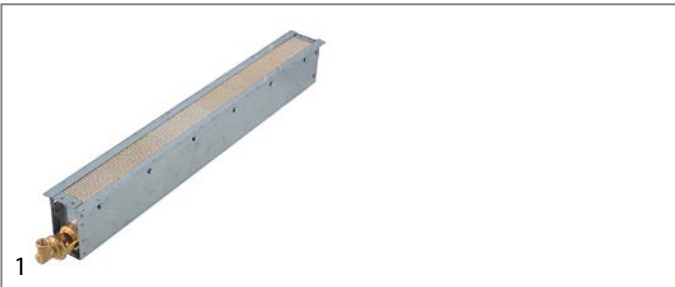
Part No.	104681	Ref. No.	E01011
description	ceramic burner L 580mm W 85mm firing range 494x63mm 4kW		

1

Part No.	105506	Ref. No.	E01002
description	ceramic burner L 585mm W 67mm firing range 549x38mm for salamander/chicken rotisserie		
accessories for	105506		
	Part No.	100982	Ref. No. E02077
	gas injector thread M8x1 WS 12 bore ø 0.85mm		
	Part No.	102953	Ref. No. —
	gas injector thread M8x1 WS 12 bore ø 1.1mm		



1

Part No.	107572	Ref. No.	E01002
description	ceramic burner L 585mm W 67mm firing range 549x38mm for salamander/chicken rotisserie		
For models:	RBG12, RBG4, RBG8, SGF80		
accessories for	107572		
	Part No.	107573	Ref. No. E02158
	screw connection		
	Part No.	107574	Ref. No. E02157
	cap		
	Part No.	107575	Ref. No. E02160
	nozzle holder		

accessories

burner grids



1

Part No.	850017	Ref. No.	F01059
description	burner grid L 228mm W 163mm for gyro grill		



1

Part No.	105508	Ref. No.	36063GRI
description	burner grid L 360mm W 200mm		
For models:	GRG40, GRG80		



1

Part No.	105511	Ref. No.	36064GRI 36065GRI
description	burner grid L 545mm W 200mm		
For models:	GRG60		

star burners



1

Part No.	105500	Ref. No.	E01003
description	star burner 3kW L 330mm W 298mm H 82mm number of burners: 6 for crepes maker		
For models:	350G, 350GD, 400G, 400GD		



1

Part No.	107000	Ref. No.	E01007
description	star burner L 317mm W 308mm H 90mm number of burners: 6 for crepes maker		

accessories

miscellaneous





1

Part No.	107574	Ref. No.	E02157
description	cap		



			
1			
Part No.	105501	Ref. No.	68009
description	flame spreader		
For models:	350G, 350GD, 400G, 400GD		

			
1			
Part No.	107575	Ref. No.	E02160
description	nozzle holder		

			
1			
Part No.	107573	Ref. No.	E02158
description	screw connection		

gas nozzles

main nozzles

<h4>gas nozzles 3/8"</h4>			
			
1			
Part No.	100984	Ref. No.	E02074
description	gas injector thread 3/8" WS 17 bore ø 0.75mm		
For models:	350G, 350GD, 400G, 400GD, PSG400, PSG600		

			
1			
Part No.	100985	Ref. No.	E02075
description	gas injector thread 3/8" WS 17 bore ø 0.85mm		
For models:	350G, 350GD, 400GD, PSG400, PSG600		

<h4>gas nozzles M7x0.75</h4>			
			
1			
Part No.	106649	Ref. No.	E02170
description	gas injector thread M7x0.75mm WS 8 bore ø 1mm		

<h4>gas nozzles M8x1</h4>			
			
1			
Part No.	106999	Ref. No.	E02018
description	gas injector thread M8x1 WS 10 bore ø 0.9mm		

			
1			
Part No.	100988	Ref. No.	E02076
description	gas injector thread M8x1 WS 10 bore ø 1.35mm		
For models:	350GD, 400G, 400GD		

			
1			
Part No.	106910	Ref. No.	E02016
description	gas injector thread M8x1 WS 10 bore ø 1.45mm		

			
1			
Part No.	106911	Ref. No.	E02019
description	gas injector thread M8x1 WS 10 bore ø 1mm		

			
1			
Part No.	100982	Ref. No.	E02077
description	gas injector thread M8x1 WS 12 bore ø 0.85mm		
For models:	GSM60, SGF80		

			
1			
Part No.	100987	Ref. No.	E02040 E02079
description	gas injector thread M8x1 WS 12 bore ø 1.3mm		
For models:	GSM60, SGF80		

			
1			
Part No.	100983	Ref. No.	E02090
description	gas injector thread M8x1 WS 12 bore ø 1.5mm		
For models:	GSM60, SGF80		



pilot burner nozzles

pilot burner nozzles SIT

100 series



Part No.	100245	Ref. No.	E02086
description	pilot burner nozzle LPG code 20 bore \varnothing 0.2mm Qty 1 pcs thread M8x0.75		



Part No.	100246	Ref. No.	E02086
description	pilot burner nozzle natural gas bore \varnothing 0.35mm Qty 1 pcs thread M8x0.75		



Part No.	107170	Ref. No.	E02086
description	pilot burner nozzle SIT natural gas bore \varnothing 0.35mm Qty 1 pcs		
For models:	GSM60, SGF80, SGM60		

burner nozzles



Part No.	698960	Ref. No.	E02179
description	nozzle for ceramic burner EG+FG L 28.7mm W 21mm H 21mm M14x1.25		

gas nozzles sets



Part No.	104758	Ref. No.	E02160+E02179+E02180
description	nozzle set for ceramic burner EG+FG		

auxiliary gas parts

gas hoses

miscellaneous



Part No.	250008	Ref. No.	E02087
description	gas hose L 500mm nominal- \varnothing 6mm		
For models:	GSM60, SGF80		

Part No.	105512	Ref. No.	E02088
description	gas hose L 560mm hose SS for pipe \varnothing 10mm		
For models:	GSM60, SGF80		

consumables

lava rocks / ceramic briquetts



Part No.	693326	Ref. No.	F07001
description	lava rocks size ca.20mm Qty 1.5kg		

equipment-specific units

for display coolers

glass panels

glass panels



Part No.	692050	Ref. No.	SH01017
description	glass panel H 5mm \varnothing 575mm for fridge glas		

for bain marie

drain systems

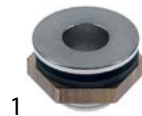

Part No.	691913	Ref. No.	E02059 E02059 + E02056 + E02057
description	drain fitting thread 3/8" SS \varnothing 24mm H 16mm		

spare parts for

Part No.	511182	Ref. No.	E02057
description	nut thread 3/8" H 8mm brass WS 24 Qty 1 pcs		



housing and bezels



1

Part No.	550826	Ref. No.	65004
description	fixing plate for heating element L 275mm W 240mm H 8mm mounting pos. lower hole ø 6mm		

1

Part No.	418893	Ref. No.	H02028
description	insulating mat L 260mm W 235mm thickness 15mm		

for crepes makers

cast plates



1

Part No.	693021	Ref. No.	B02016
description	cast plate ø 350mm		



1

Part No.	693020	Ref. No.	B02015
description	cast plate ø 400mm		
For models:	400E, 400ED, 400FE, 400G, 400GD		

accessories

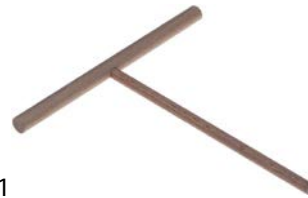

1

Part No.	694451	Ref. No.	F05017
description	batter spreader for crepes maker ø 12.3mm L 184mm W 180mm wood		

for deep fryers

lids



1

Part No.	696404	Ref. No.	07107
description	lid L 325mm W 265mm for fryer FD80		

basket holders



1

Part No.	970739	Ref. No.	F04011
description	basket support for fryer basket W 265mm H 225mm		



sumps



1

Part No.	695118	Ref. No.	F05068
description	sump for fryer with hole L 320mm W 260mm H 200mm 8l		



1

Part No.	691952	Ref. No.	F05002
description	sump for fryer without hole L 320mm W 170mm H 200mm		



1

Part No.	691923	Ref. No.	F05027
description	sump for fryer without hole L 530mm W 325mm H 170mm		



1

Part No.	691924	Ref. No.	F05028
description	sump for fryer/pasta cooker with hole L 530mm W 325mm H 170mm		

for drink dispensers

valve bodies



1

Part No.	698959	Ref. No.	SB04059
description	valve body H 52mm ø 40.8mm M16x2		

for grills

sumps



1

Part No.	693016	Ref. No.	4900P7110 49015
description	grease collecting tray L 650mm W 50mm H 45mm		
For models:	PSE 600		

for griddles

griddles



1

Part No.	693361	Ref. No.	B02027
description	cast plate L 400mm W 380mm H 60mm griddle		
For models:	PSE400, PSG400		



1

Part No.	693015	Ref. No.	B02026
description	griddle		
For models:	PSE600, PSG600		

sumps



1

Part No.	698310	Ref. No.	53022
description	drain tray L 414mm W 35mm H 80mm		

for gyros grills

skewers

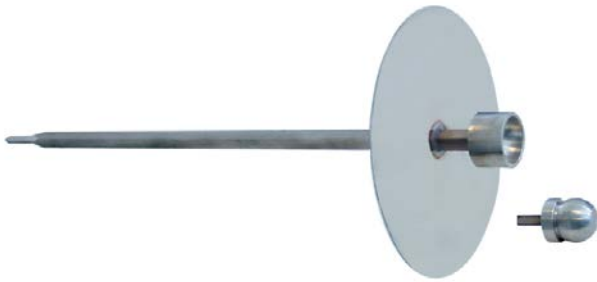

1

Part No.	693008	Ref. No.	F03028
description	skewer for gyro grill size 12x12mm L 535mm with skewer plates ø 210mm		
For models:	GRE40, GRG40		



1

Part No.	693034	Ref. No.	F03030
description	skewer for gyro grill size 12x12mm L 715mm with skewer plates ø 210mm		
For models:	GRE80, GRG80		

miscellaneous



1

Part No.	301201	Ref. No.	B04048
description	ball for skewer		
For models:	GRE40, GRE60, GRE80, GRG40, GRG60, GRG80		



1

Part No.	694845	Ref. No.	B06012
description	bracket for ball bearing mounting pos. lower		



1

Part No.	693013	Ref. No.	B06036
description	rubber pad		



1

Part No.	694846	Ref. No.	B04071
description	skewer intake mounting pos. lower		

for chicken rotisserie

baskets



1

Part No.	970919	Ref. No.	B04054
description	basket for chicken rotisserie L 664mm W 140mm H 100mm chrome-plated steel		

skewers



1

Part No.	693010	Ref. No.	F03019
description	skewer for chicken rotisserie L 588mm thickness 8x8mm shaft intake ø 5x15mm stainless steel		
For models:	RBE12, RBE4, RBE8, RBG12, RBG4, RBG8		





1			
Part No.	693433	Ref. No.	F03003
description	skewer for oven		

spit clamp



1			
Part No.	693011	Ref. No.	F03020
description	skewer clamp for chicken rotisserie ID ø 13mm L 130mm W 73mm		
For models:	RBE12, RBE4, RBE8, RBG12, RBG4, RBG8		



1			
Part No.	691648	Ref. No.	F03021 + F03020 F03034
description	skewer clamp set composed of 3xZ, 2xU		

for hot counters

housing and bezels

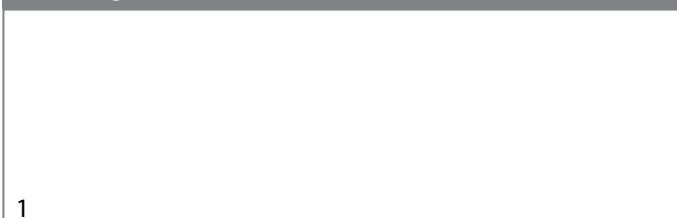

1			
Part No.	693341	Ref. No.	H01045
description	cover for hot counter plexiglas mounting pos. in the front/at the back		
For models:	WDL 100, WDL 200		

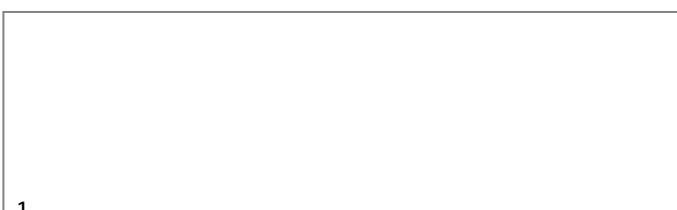

1			
Part No.		Ref. No.	H01040
description	cover for hot counter plexiglas mounting pos. in the front/at the back		
For models:	WDL 100, WDL 200		



1			
Part No.	550826	Ref. No.	65004
description	fixing plate for heating element L 275mm W 240mm H 8mm mounting pos. lower hole ø 6mm		



1			
Part No.	418893	Ref. No.	H02028
description	insulating mat L 260mm W 235mm thickness 15mm		



1			
Part No.	693342	Ref. No.	H01041
description	protector for glass mounting for hot counter		



1			
Part No.	693340	Ref. No.	H01043
description	side panel for hot counter plexiglas mounting pos. left/right		
For models:	WD 100, WDL 100		

doors



1			
Part No.		Ref. No.	H01044
description	door complete plexiglas for hot counter		
For models:	WD 100, WDL 100		



for convection ovens/combi-steamers

spare parts and accessories



Part No.	693043	Ref. No.	F02005
description	guard		
For models:	FC26, FC34, TH1		

for hot dog machines

lids



Part No.	693051	Ref. No.	F05038
description	lid		



Part No.	694450	Ref. No.	F05051
description	lid for hot dog machine ø 205mm		

glass cylinders



Part No.	693003	Ref. No.	F05012
description	glass cylinder ø 200mm H 240mm		



Part No.	693002	Ref. No.	F05009
description	glass cylinder ø 200mm Pyrex glass H 240mm		

skewers



Part No.	693018	Ref. No.	F05010
description	bun spikes for hot dog machine		

water containers



Part No.	693006	Ref. No.	F05025
description	water container for hot dog machine		



Part No.	693005	Ref. No.	F05022
description	water container for hot dog machine PTFE/aluminium		

for panini grill

guiding pieces



Part No.	699279	Ref. No.	B03003 B03007+B06063
description	bearing block with bush L 50mm W 20mm H 10mm		

cast plates



Part No.	693362	Ref. No.	B02022
description	cast plate mounting pos. lower grooved		
For models:	MAJESTIC		



1

Part No.	693367	Ref. No.	B02018
description	cast plate mounting pos. lower grooved		
For models:	SAVOYE		



1

Part No.	693360	Ref. No.	B02021
description	cast plate mounting pos. lower smooth		
For models:	MAJESTIC		



1

Part No.	693359	Ref. No.	B02023
description	cast plate mounting pos. lower L 373mm W 294mm H 78mm grooved		
For models:	DOUBLE PANINI, PANINI		



1

Part No.	693366	Ref. No.	B02020
description	cast plate mounting pos. lower smooth		
For models:	SAVOYE		



1

Part No.	693363	Ref. No.	B02017 B02017+PTR
description	cast plate mounting pos. lower L 550mm W 300mm grooved		
For models:	MAJESTIC		



1

Part No.	693365	Ref. No.	B02019
description	cast plate mounting pos. upper L 250mm W 240mm grooved		
For models:	MAJESTIC, SAVOYE		



1

Part No.	693357	Ref. No.	B02025
description	cast plate mounting pos. lower smooth		
For models:	DOUBLE PANINI, PANINI		



1

Part No.	693356	Ref. No.	B02033
description	cast plate mounting pos. upper L 355mm W 235mm smooth		
For models:	DOUBLE PANINI, PANINI		



1

Part No.	693358	Ref. No.	B02024
description	cast plate mounting pos. upper L 355mm W 255mm grooved		
For models:	DOUBLE PANINI, PANINI		



1

Part No.	693364	Ref. No.	B02034
description	cast plate mounting pos. upper smooth		
For models:	MAJESTIC, SAVOYE		

for contact grills

griddles

ceran plates



1

Part No.	694268	Ref. No.	37250COL
description	ceran plate L 275mm W 252mm H 45mm grooved		

for ovens

glass panels



1

Part No.	698958	Ref. No.	H01076
description	glass panel L 215mm W 90mm H 5mm thickness 5mm Qty 1 pcs		

miscellaneous



1

Part No.	698614	Ref. No.	H01011
description	glass panel for door oven L 577mm W 435mm H 4.5mm		
For models:	FC60		

for pizza ovens

firebricks



1

Part No.	693001	Ref. No.	F07005
description	firebrick delivery freight forwarding company only		



1

Part No.	693009	Ref. No.	F07005 F07008
description	firebrick L 350mm W 322mm H 15mm delivery freight forwarding company only		
For models:	PZ330, PZ660		



miscellaneous



1			
Part No.	693041	Ref. No.	H02002
description	insulating mat L 215mm W 195mm		
For models:	PZ330, PZ660, SEM60		

for rechauds

warming plates

components



1			
Part No.	693014	Ref. No.	F07009
description	handle protection for warming plate		

warming plates



1			
Part No.	416720	Ref. No.	H04051
description	warming plate		

for rolling grills

drive shafts



1			
Part No.	693032	Ref. No.	B04012 B04072
description	drive shaft L 450mm		
For models:	RG11, RG5, RG7, RG9		

EQUIPMENT-SPECIFIC UNITS ROLLER-GRILL

pipes

bushes



1			
Part No.	693038	Ref. No.	B06029
description	bushing ED \varnothing 37mm ID \varnothing 30mm H 4.5mm PTFE suitable for ROLLER GRILL		
For models:	RG11, RG5, RG7, RG9		

gear wheels



1			
Part No.	693160	Ref. No.	B01004
description	gear wheel teeth 20 shaft intake \varnothing 8mm \varnothing 38mm hub \varnothing 20mm stainless steel		

for salamander grills



1			
Part No.	692240	Ref. No.	30045
description	drain tray for salamander grill L 350mm W 245mm		

for toasters

spare parts and accessories



1			
Part No.	693043	Ref. No.	F02005
description	guard		
For models:	FC26, FC34, TH1		



miscellaneous



1

Part No.	694023	Ref. No.	B03004 B03008 B03008+B06063
description	bearing for conveyor toaster mounting pos. front		

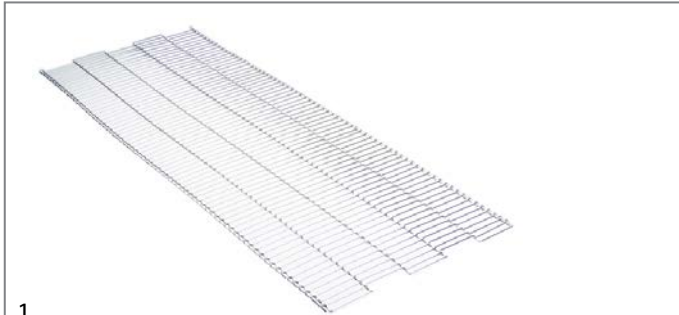

1

Part No.	694024	Ref. No.	F01045
description	conveyor belt for conveyor toaster		

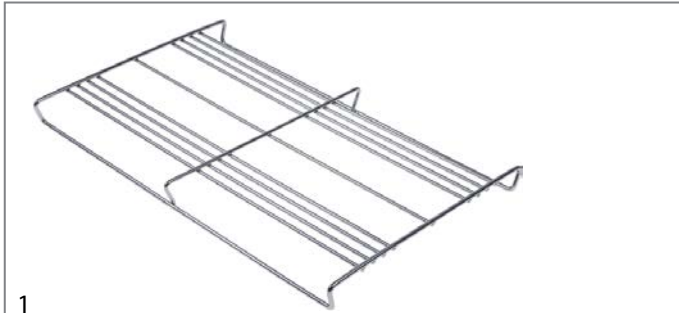

1

Part No.	694449	Ref. No.	F01069
description	guard L 315mm W 200mm for toaster H 24mm		

pliers

pliers



1

Part No.	690010	Ref. No.	F01013
description	plier for toaster H 180mm total length 100mm		

for waffle irons

cast plates



1

Part No.	693349	Ref. No.	B02029INF
description	cast plate for waffle iron for model GES10 mounting pos. lower		



1

Part No.	693348	Ref. No.	B02029SUO
description	cast plate for waffle iron for model GES10 mounting pos. upper		
For models:	GED10, GES10		



1

Part No.	693303	Ref. No.	B02029PTR
description	cast plate for waffle iron for model GES10 set mounting pos. upper/lower L 250mm W 250mm H 60mm		



1

Part No.	693351	Ref. No.	B02028INF
description	cast plate for waffle iron for model GES20 mounting pos. lower		
For models:	GED20, GES20		



1

Part No.	693350	Ref. No.	B02028SUP
description	cast plate for waffle iron for model GES20 mounting pos. upper		
For models:	GED20, GES20		



1

Part No.	691251	Ref. No.	B02032PRT
description	cast plate for waffle iron for model GES20 set mounting pos. upper/lower L 250mm W 250mm H 60mm		

1

Part No.	693353	Ref. No.	B02030INF
description	cast plate for waffle iron for model GES30 mounting pos. lower		
For models:	GED30, GES30		



1

Part No.	693426	Ref. No.	B02041INF
description	cast plate for waffle iron for model GES30 mounting pos. lower		

1

Part No.	693352	Ref. No.	B02030SUP
description	cast plate for waffle iron for model GES30 mounting pos. upper		
For models:	GED30, GES30		



1

Part No.	693425	Ref. No.	B02041SUP
description	cast plate for waffle iron for model GES30 mounting pos. upper		



1

Part No.	693355	Ref. No.	B02031INF
description	cast plate for waffle iron for model GES40 mounting pos. lower		
For models:	GED40, GES40		



1

Part No.	693354	Ref. No.	B02031SUP
description	cast plate for waffle iron for model GES40 mounting pos. upper		
For models:	GED40, GES40		



1

Part No.	692111	Ref. No.	B02031PTR
description	cast plate for waffle iron for model GES40 set mounting pos. upper/lower L 250mm W 250mm H 60mm		

knobs

producer-specific knobs

ROLLER GRILL



1

Part No.	112784	Ref. No.	A14094
description	knob switch zero mark ø 40mm shaft ø 6x4.6mm shaft flat left black		



1

Part No.	110654	Ref. No.	A14090
description	knob switch zero mark ø 40mm shaft ø 6x4.6mm shaft flat lower black		
For models:	CN		



1

Part No.	110651	Ref. No.	A14078 A14097
description	knob switch zero mark ø 50mm shaft ø 6x4.6mm shaft flat upper black		
For models:	350E, 350ED, 350G, 350GD, 400E, 400ED, 400FE, 400G, 400GD, CT540, DOUBLE PANINI, FC110, FC110G, FC33, FC34, FC60, FC60G, FD120R, GED10, GED20, GED30, GED40, GES10, GES20, GES30, GES40, GRE40, GRE60, GRE80, MAJESTIC, PANINI, PSE400, PSE600, PZ330, PZ400, PZ660, RBE12, RBE4, RBE8, RG11, RG5, RG7, RG9, SAVOYE, SEF80, SEM60		



1

Part No.	110653	Ref. No.	A14029
description	knob switch zero mark ø 50mm shaft ø 6x4.6mm shaft flat upper black		
For models:	TH1		



1

Part No.	110652	Ref. No.	A14076
description	knob switch zero mark ø 50mm shaft ø 8x6.5mm shaft flat right black		
For models:	GSM60, RBG12, RBG4, RBG8, SGF80		



1

Part No.	110656	Ref. No.	A14075
description	knob switch zero mark ø 50mm shaft ø 8x6.5mm shaft flat upper black		
For models:	GRG40, GRG60, GRG80		



1

Part No.	110655	Ref. No.	A14077 A14113
description	knob switch zero mark ø 50mm shaft ø 8x7mm shaft flat left black		
For models:	PSG400, PSG600		



1

Part No.	110657	Ref. No.	A14042 A14084 A14121
description	knob switch zero mark t.max.°C temperature range°C ø 40mm shaft ø 6x4.6mm shaft flat lower black		
For models:	140, 140D, BAR100, BAR106, BAR200, BAR206, FC26, RST127, RST128, RST227, RST228		



1

Part No.	112778	Ref. No.	A14111
description	knob zero mark ø 40mm shaft ø 6x4.6mm shaft flat lower black		



1

Part No.	112657	Ref. No.	A14109
description	knob zero mark ø 55mm shaft ø 6x4.6mm shaft flat left black		



1

Part No.	112656	Ref. No.	A14108
description	knob zero mark ø 55mm shaft ø 6x4.6mm shaft flat right black		



1

Part No.	112658	Ref. No.	A14110
description	knob zero mark ø 55mm shaft ø 6x4.6mm shaft flat upper black		

handles and hand wheels

cone handles



1

Part No.	694952	Ref. No.	A17012
description	cone handle thread M10x1.5 ø 32mm plastic L 105mm		



1

Part No.	693036	Ref. No.	A15033
description	cone handle thread M8 ø 28mm plastic L 105mm black thread L 11mm		
For models:	BAR106, BAR206, PZ400		



1

Part No.	693162	Ref. No.	A15008 A15035
description	handle		



1

Part No.	110920	Ref. No.	A17001 A17003
description	cone handle thread M5 ø 25mm L 26mm plastic black		



ball handles



1

Part No.	540321	Ref. No.	A17008
description	ball handle thread M6 ø 25mm with metal bush		

bracket handles



1

Part No.	700551	Ref. No.	A15018
description	pull handle L 200mm H 62mm mounting distance 179mm handle M8		

lever handles



1

Part No.	693035	Ref. No.	F01025
description	lever handle plastic		

folding grill handles



1

Part No.	693161	Ref. No.	A15036
description	handle rod		
For models:	DOUBLE PANINI, GED10, GED20, GED30, GED40, GES10, GES20, GES30, GES40, MAJESTIC, PANINI, SAVOYE		

door handles

door handles



1

Part No.	693079	Ref. No.	A15020/2
description	door handle for chicken rotisserie black		

miscellaneous



1

Part No.	691960	Ref. No.	A15015
description	handle L 100mm W 32mm hole distance 70mm for lid		
For models:	FD120R		



1

Part No.	110921	Ref. No.	A15001 A15016
description	handle L 130mm W 39mm hole distance 91mm Qty 1 pcs		

hinges

oven hinges



1

Part No.	693044	Ref. No.	B09005
description	oven hinge		

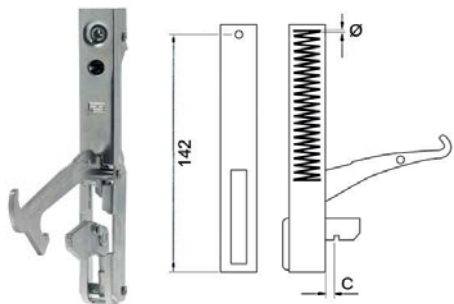

1

Part No.	700459	Ref. No.	B09005	
description	oven hinge mounting distance 142mm mounting distance 2mm lug mountingmm lever length 117mm groove distance 7mm spring thickness 3.5mm mounting ear position spring length 58mm L 156mm W 22mm			
For models:	FC110, FC110G, FC60, FC60G			
accessories for	700459			
	Part No.	693045	Ref. No.	—
	opposite support L 110mm W 12mm mounting distance 94mm			



door bearing

			
1			
Part No.	693023	Ref. No.	H04096
description	hinge bearing without bolt		

fittings for catering equipment

outlet taps

universal

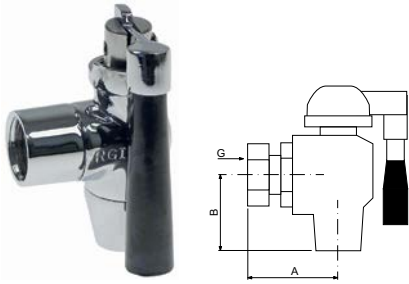
			
1			
Part No.	514170	Ref. No.	B10012 B10014
description	outlet tap W 35mm H 40mm thread 1/2" IT		
For models:	FD120R		

equipment feet and end caps

equipment feet

with fixing plate

			
1			
Part No.	701003	Ref. No.	A13008
description	equipment foot tube ømm plate size 95x95mm hole distance 70x70mm H 155-210mm plastic size Qty 1 pcs		

screw-in feet

			
1			
Part No.	701008	Ref. No.	A13005
description	equipment foot thread M10 thread L 14mm H 102-140mm WS 44 Qty 1 pcs D1 ø 24mm D2 ø 36mm for chicken rotisserie		

			
1			
Part No.	692235	Ref. No.	A13012
description	equipment foot thread M10 thread L 20mm ø 26mm H 6mm Qty 1 pcs		
For models:	FC60		

			
1			
Part No.	701036	Ref. No.	A13006
description	equipment foot thread M10 thread L 40mm ø 40mm H 52mm Qty 1 pcs		

			
1			
Part No.	691828	Ref. No.	A13009 A13009+105005
description	equipment foot thread M8 thread L 20mm ø 25mm H 29mm with nut plastic WS 26 Qty 1 pcs		
For models:	FC26, FC33, FC34, PZ330, PZ660, RELAIS		

bolting feet

			
1			
Part No.	691814	Ref. No.	A13003
description	equipment foot ø 22mm H 20mm bore ø 4mm Qty 1 pcs		



baskets

fryer baskets

ROLLER GRILL



Part No.	693017	Ref. No.	F04006 F04038
description	fryer basket L1 250mm W1 225mm H1 105mm		



Part No.	693025	Ref. No.	F04008 F04039
description	fryer basket L1 250mm W1 285mm H1 115mm		



Part No.	693029	Ref. No.	F04002 F04030
description	fryer basket L1 260mm W1 125mm H1 100mm hinged handle		

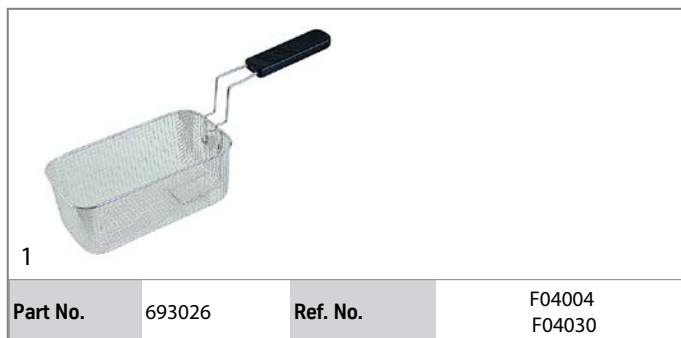

Part No.	693026	Ref. No.	F04004 F04030
description	fryer basket L1 260mm W1 140mm H1 100mm		



Part No.	693028	Ref. No.	F04010 F04017
description	fryer basket L1 310mm W1 145mm H1 140mm		

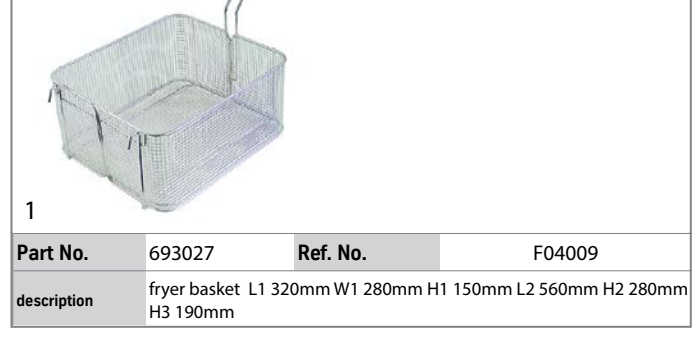

Part No.	693027	Ref. No.	F04009
description	fryer basket L1 320mm W1 280mm H1 150mm L2 560mm H2 280mm H3 190mm		



Part No.	694711	Ref. No.	F04046
description	fryer basket W1 130mm L1 321mm H1 145mm		

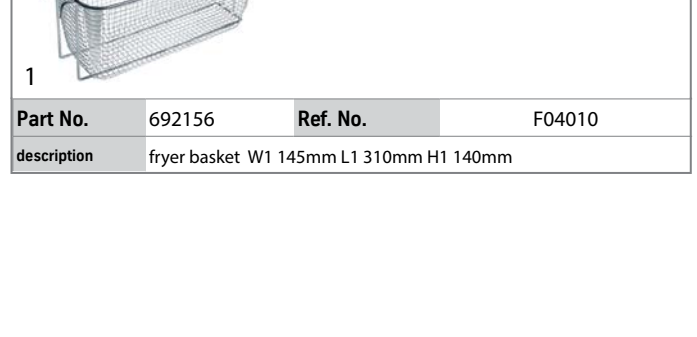

Part No.	692156	Ref. No.	F04010
description	fryer basket W1 145mm L1 310mm H1 140mm		



wire baskets for hot dog machines



1	Part No.	693004	Ref. No.	F04012
	description	grid basket for hot dog grill ø 180mm H 210mm		

miscellaneous



1	Part No.	691216	Ref. No.	F04013
	description	egg basket ø 54mm L 160mm W 54mm H 35mm set 4-piece for egg cooker stainless steel		

shelves and shelf rails

grates

universal

without upstand



1	Part No.	970740	Ref. No.	F01002
	description	grate W 315mm D 315mm H 9mm chrome-plated steel for heated cabinet wire gauge frame 6mm lengthwise wires gauge 3.5mm suitable for relays ROLLER GRILL		
	For models:	RELAIS		



1	Part No.	970747	Ref. No.	F01070
	description	grate W 350mm D 240mm H 7mm SS for toaster wire gauge frame 4mm lengthwise wires gauge 3mm crossing wires ROLLER GRILL		



1	Part No.	970895	Ref. No.	F01021
	description	grate W 400mm D 600mm H 5mm chrome-plated steel wire gauge frame 5mm lengthwise wires gauge 2mm crossing wires 3		

producer-specific

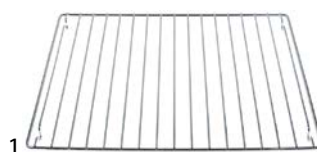

1	Part No.	970894	Ref. No.	F01035
	description	grate W 340mm D 455mm H 20mm chrome-plated steel wire gauge frame 5mm lengthwise wires gauge 3mm		
	For models:	FC60		



1	Part No.	970893	Ref. No.	F01031
	description	grate W 400mm D 290mm H 20mm chrome-plated steel wire gauge frame 4.5mm lengthwise wires gauge 3mm		



accessories



1			
Part No.	691917	Ref. No.	F03006
description	grid handle L 204mm W 80mm		

gaskets

refrigeration gaskets

screw-in gaskets

profile 9954

We offer custom-made gaskets for this profile

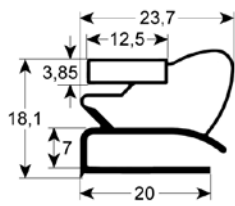

1			
Part No.	902109	Ref. No.	SH03026
description	refrigeration gasket profile 9954 W 450mm L 1210mm external size		

gaskets for heated units

door seals with fixing hook

1			
Part No.	900242	Ref. No.	H03001
description	door seal		
For models:	FC34, TH1		



1			
Part No.	900240	Ref. No.	H03002
description	door seal W 310mm H 170mm		
For models:	FC26		



1			
Part No.	900241	Ref. No.	H03010
description	oven gasket L 235mm W 370mm external size		
For models:	CN, FC33		



1			
Part No.	900244	Ref. No.	H03006
description	oven gasket L 340mm W 640mm external size		
For models:	FC110, FC110G		



1			
Part No.	900243	Ref. No.	H03005
description	oven gasket L 350mm W 450mm external size		
For models:	FC60, FC60G		

evaporators

for fridges

producer-specific



1			
Part No.	750623	Ref. No.	SA03083
description	evaporator total length 508mm overall width 106mm overall height 178mm for display refrigerator suitable for ROLLER GRILL		



transmission technology and ball bearings

ball bearings

deep-groove ball bearings 2Z



1

Part No.	698613	Ref. No.	B06010
description	deep-groove ball bearing shaft \varnothing 17mm ED \varnothing 40mm W 12mm type 6203-2Z DIN 625-1		

deep-groove ball bearings Z



1

Part No.	697842	Ref. No.	B06010
description	deep-groove ball bearing type 6203-Z shaft \varnothing 17mm ED \varnothing 40mm W 12mm DIN 625-1		

chains

roller chains 06B-1 single



1

Part No.	693030	Ref. No.	B07013
description	roller chain DIN/ISO 06 B-1 splitting 3/8" / 9.525mm links 53 internal width 5.72mm rollo \varnothing 6.35mm single with connector		

springs

torsion springs



1

Part No.	693019	Ref. No.	B07015
description	torsion spring \varnothing 20.8mm L1 48mm L2 124mm L3 48mm wire gauge \varnothing 3.7mm		
For models:	DOUBLE PANINI, MAJESTIC, PANINI, SAVOYE		



1

Part No.	700822	Ref. No.	B07019 B07029
description	torsion spring \varnothing 20mm L1 69mm L2 119mm L3 69mm wire gauge \varnothing 3.6mm		

tension springs



1

Part No.	693024	Ref. No.	B07002
description	tension spring \varnothing 8mm total length 130mm wire gauge \varnothing 1mm		
For models:	CN, FC26, FC33, FC34, TH1		

hoses

drain hoses

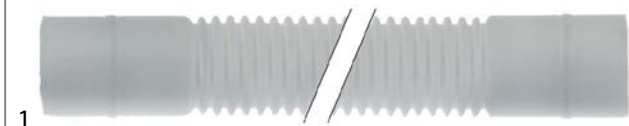

1

Part No.	698962	Ref. No.	SH03018
description	drain hose L 1550mm ED \varnothing 25mm ID \varnothing 23mm		

industrial hoses

PE hoses

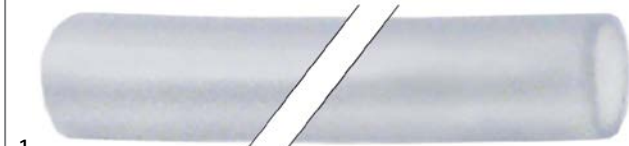

1

Part No.	520549 ¹	Ref. No.	SH03012
description	hose Lm operating p. 6bar burst p. 10bar t.max. 65°C LLDPE transparent ID \varnothing 6mm ED \varnothing 8mm John Guest supplied by meter		

¹by the meter



fittings, hose and pipe connectors

push-in fittings

JOHN GUEST



1

Part No.	440561	Ref. No.	SB10015
description	push-in fitting John Guest straight thread 1/8" BSP pipe connection ø8mm		
accessories for	440561		
	Part No.	520972	Ref. No.
			—
	hose John Guest thickness 1mm LLDPE blue ID ø 6mm ED ø 8mm		



1

Part No.	520550	Ref. No.	SB10017
description	push-in fitting John Guest T-piece thread 1/8" BSP pipe connection ø8mm - ø8mm SK approved		

valves and tank inlets

ball valves

universal

ball valves with lever handle



1

Part No.	693046	Ref. No.	B10001
description	ball valve connection 3/8" IT - 3/8" IT DN10 total length 41mm with lever handle		

water filters

miscellaneous

filters



1

Part No.	530269	Ref. No.	SB10019
description	water filter AQUA CURE type H60FB capacity/ flow rate 4l/min operation p max 8.5bar water temperature max. 38°C ø 50mm H 155mm for water dispenser		

drain systems and wash basins

accessories



1

Part No.	691916	Ref. No.	B04009
description	drain pipe L 60x30mm ø 12mm brass		

measuring equipment

thermometers

built-in thermometers



1

Part No.	541085	Ref. No.	A18007
description	thermometer mounting measurements 58x25.5mm +50 up to +350°C capillary pipe 1000mm probe ø 6.5mm probe L 13mm		



1

Part No.	541063	Ref. No.	A18010
description	thermometer mounting measurements 58x25.5mm 0 up to +120°C capillary pipe 1500mm probe ø 6.5mm probe L 23mm		



fastening material

nuts

hexagonal nuts

hexagonal nuts inch thread



1

Part No.	520500	Ref. No.	E02144
description	hexagonal nut thread 3/8" H 4mm WS 23 nickel-plated brass Qty 1 pcs		



1

Part No.	511182	Ref. No.	E02057
description	nut thread 3/8" H 8mm brass WS 24 Qty 1 pcs		



1

Part No.	960035	Ref. No.	F07026
description	bottle 1l ø 85mm H 250mm plastic		

lava rocks / ceramic briquetts



1

Part No.	693326	Ref. No.	F07001
description	lava rocks size ca.20mm Qty 1.5kg		

consumables

containers

bottles



1

Part No.	960034	Ref. No.	F07034
description	bottle 0.5l ø 75mm H 200mm plastic		

GASTROPARTS.COM

