



GASTROPARTS

Retigo

- [EN]** Equipment
- [DE]** Geräte
- [ES]** Aparatos
- [FR]** Équipement
- [IT]** Attrezzature
- [PL]** Urządzenia
- [RU]** Оборудование

✉ gastroparts@gastroparts.com

☎ tel. +48 56 657 00 66

📘 fb.com/gastroparts.global

GASTROPARTS.COM





heating elements

immersion heating elements

miscellaneous



Part No.	420360	Ref. No.	AX24-0008 AX24-0008+AX24-0002 EX24-0008
description	heating element 12000W 230V heating circuits 3 L 330mm W 42mm H 65mm number of thermostat sleeves 1 thermostat sleeves ø 3.5mm length thermostat sleeves 80mm thermostat sleeve eccentric, clinging tube ø 8.4mm hole distance 65/77mm hole ø 8mm connection M4 flange immersion heater flange width 83mm flange length 95mm		
For models:	B1011b, B1221b, B2011b, B2021b, O1011b, O1221b, O2011b, O2021b		
accessories for	420360		
	Part No.	520580	Ref. No. AX24-0002
	gasket rubber L 96mm W 84mm thickness 5mm hole ø 7mm hole distance 65x78mm		



Part No.	417542	Ref. No.	AX24-0006 AX24-0006+AX24-0002
description	heating element 3x3000W 230V heating circuits 3 L 305mm W 68mm H 40mm number of thermostat sleeves 1 thermostat sleeves ø 3.3mm length thermostat sleeves 970mm thermostat sleeve upper right tube ø 8.5mm hole distance 77x67mm hole ø 7.9mm connection screw immersion heater flange width 95mm flange length 83mm with gasket		
For models:	B611b, O611b		
accessories for	417542		
	Part No.	520580	Ref. No. AX24-0002
	gasket rubber L 96mm W 84mm thickness 5mm hole ø 7mm hole distance 65x78mm		



Part No.	419143	Ref. No.	EX24-0006
description	heating element 9000W 230V heating circuits 3 L 305mm W 45mm H 65mm number of thermostat sleeves 1 thermostat sleeves ø 2.5mm length thermostat sleeves 90mm hole distance 65x78mm hole ø 8mm connection length 33mm connection M4 rectangular flange immersion heater		
accessories for	419143		
	Part No.	520580	Ref. No. AX24-0002
	gasket rubber L 96mm W 84mm thickness 5mm hole ø 7mm hole distance 65x78mm		

heating elements for convection



Part No.	417545	Ref. No.	AX00-0007 AX00-0007+AX00-0008
description	heating element 16000W 230V heating circuits 3 ID ø 380mm ED ø 430mm L 460mm H 98mm L1 45mm W1 187mm H1 18mm H2 80mm flange length 210mm flange width 24mm connection screw connection length 90mm tube ø 8.5mm convection heating element hole ø 7.6mm rectangular flange combi-steamer		
For models:	B1011b, B1011i, B1221b, B1221i, B2011b, B2011i, O1011b, O1011i, O1221b, O1221i, O2011b, O2011i		
accessories for	417545		
	Part No.	521127	Ref. No. AX00-0008
	gasket L 210mm W 24mm thickness 2mm for heating element		



Part No.	417546	Ref. No.	AX00-0018
description	heating element 29000W 230V heating circuits 6 ID ø 430mm ED ø 530mm L 530mm H 130mm L1 20mm W1 100mm H1 21mm H2 150mm flange length 130mm flange width 90mm hole distance 55mm connection screw connection length 85mm tube ø 8.5mm convection heating element hole ø 7.6mm rectangular flange combi-steamer		
For models:	B2021b, B2021i, O2021b, O2021i		



1

Part No.	417544	Ref. No.	AX00-0005 AX00-0005+AX00-0008
description	heating element 3x3000W 230V heating circuits 3 ID ø 375mm ED ø 400mm L 455mm H 200mm L1 45mm W1 160mm H1 20mm H2 110mm flange length 210mm flange width 25mm hole distance 30mm connection screw connection length 90mm tube ø 8.5mm convection heating element hole ø 7.6mm rectangular flange combi-steamer		
For models:	B611b, B611i, O611b, O611i		
accessories for	417544		
	Part No.	Ref. No.	AX00-0008
	gasket L 210mm W 24mm thickness 2mm for heating element		



1

Part No.	417541	Ref. No.	AX00-0016 AX00-0016+AX00-0017
description	heating element 4800W 230V heating circuits 3 ID ø 205mm ED ø 250mm L 290mm H 45mm L1 45mm W1 95mm H1 5mm H2 30mm flange length 110mm flange width 20mm hole distance 35mm connection screw connection length 100mm tube ø 6.4mm convection heating element rectangular flange combi-steamer		
For models:	B623i, O623i		

accessories

flange gaskets



1

Part No.	551258	Ref. No.	AX00-0020
description	gasket L 130mm W 88mm D1 ø 7mm D2 ø 11mm 12 holes thickness 2mm for combi-steamer suitable for 417546		
For models:	B2021b, B2021i, O2021b, O2021i		



1

Part No.	521072	Ref. No.	AX00-0017
description	gasket L 112mm W 22mm D1 ø 10mm D2 ø 5.5mm graphite thickness 2mm for heating element suitable for RETIGO		
For models:	B623i, O623i		



1

Part No.	521127	Ref. No.	AX00-0008
description	gasket L 210mm W 24mm thickness 2mm for heating element		
For models:	B1011b, B1011i, B1221b, B1221i, B2011b, B2011i, B611b, B611i, O1011b, O1011i, O1221b, O1221i, O2011b, O2011i, O611b, O611i		



1

Part No.	520580	Ref. No.	AX24-0002
description	gasket rubber L 96mm W 84mm thickness 5mm hole ø 7mm hole distance 65x78mm		
For models:	B1011b, B1221b, B2011b, B2021b, B611b, O1011b, O1221b, O2011b, O2021b, O611b		

thermostats

control and safety thermostats

JUMO

safety thermostats



1

Part No.	390922	Ref. No.	EA04-0011
description	safety thermostat switch-off temp. 140°C 1-pole 1CO 16A probe ø 5mm probe L 96mm capillary pipe 990mm capillary pipe isolated 880mm gland nut probe copper		
For models:	B1011b, B1221b, B2011b, B2021b, B611b, O1011b, O1221b, O2011b, O2021b, O611b		

1

Part No.	390923	Ref. No.	EA04-0012
description	safety thermostat switch-off temp. 365°C temperature range°C 1-pole 1CO 16A probe ø 4mm probe L 107mm capillary pipe 1190mm capillary pipe isolated 1015mm gland nut shaft ømm screw connection M14x1		
For models:	B1011b, B1011i, B1221b, B1221i, B2011b, B2011i, B2021b, B2021i, B611b, B611i, B623i, O1011b, O1011i, O1221b, O1221i, O2011b, O2011i, O2021b, O2021i, O611b, O611i, O623i		

23x19mm



1

Part No.	347948	Ref. No.	EA01-0001
description	magnetic switch L 23mm W 19mm 1NC connection cable cable length 700mm 700W		

switches and momentary switches

magnetic switches

23x14mm

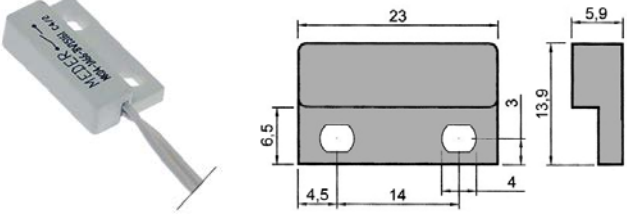

1

Part No.	347995	Ref. No.	EA01-0015
description	magnetic switch L 23mm W 14mm 1NO 180V 0.5A P max. 10W connection cable cable length 500mm		
For models:	B1011b, B1011i, B611b, B611i, B623i, O1011b, O1011i, O611b, O611i, O623i		

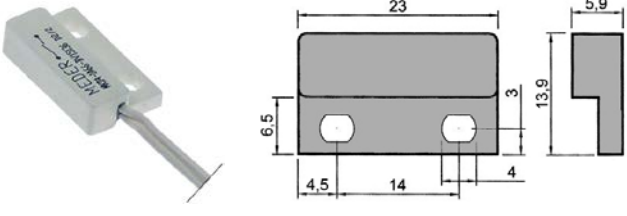

1

Part No.	347994	Ref. No.	EA01-0015
description	magnetic switch L 23mm W 14mm 1NO 180V 0.5A P max. 10W connection cable cable length 700mm		

lamps

screw-on/push-on fit

halogen lamp

for socket G4 / G6.35 / G9



1

Part No.	357193	Ref. No.	EA13-0100
description	halogen lamp socket G4 12V 20W temp.-resist. 300°C OSRAM HALOSTAR OVEN		



1

Part No.	359599	Ref. No.	EA13-0100
description	halogen lamp socket G4 12V 20W temp.-resist. 500°C		
For models:	B1011b, B1011i, B1221b, B1221i, B2011b, B2011i, B2021b, B2021i, B611b, B611i, B623i, O1011b, O1011i, O1221b, O1221i, O2011b, O2011i, O2021b, O2021i, O611b, O611i, O623i		

oven lamps

producer-specific oven lamps



RETIGO



1

Part No.	357183	Ref. No.	AX07-0002
description	gasket graphite ø 37mm ID ø 31mm thickness 1.5mm for bulb socket		
accessories for	357183		
Part No.	357182	Ref. No.	AX07-0001
description	lamp glass ø 37mm thickness 3mm		





			
1			
Part No.	357182	Ref. No.	AX07-0001
description	lamp glass ø 37mm thickness 3mm		
accessories for	357182		
	Part No.	357183	Ref. No. AX07-0002
	gasket graphite ø 37mm ID ø 31mm thickness 1.5mm for bulb socket		

			
1			
Part No.	359922	Ref. No.	EA13-0101
description	lamp socket with 2 hole fixing 25V socket G4 connection cable 140mm ø 17mm H 10mm mounting distance 11.5mm cable material silicone		
For models:	B1011b, B1011i, B1221b, B1221i, B2011b, B2011i, B2021b, B2021i, B611b, B611i, B623i, O1011b, O1011i, O1221b, O1221i, O2011b, O2011i, O2021b, O2021i, O611b, O611i, O623i		

			
1			
Part No.	680000	Ref. No.	AX07-0005 AX07-0006
description	gasket rubber ø 92mm ID ø 58mm thickness 7.6mm cavity lighting suitable for RETIGO		
For models:	B1011b, B1011i, B1221b, B1221i, B2011b, B2011i, B2021b, B2021i, B611b, B611i, B623i, O1011b, O1011i, O1221b, O1221i, O2011b, O2011i, O2021b, O2021i, O611b, O611i, O623i		

			
1			
Part No.	680001	Ref. No.	AX07-0004
description	lamp glass ø 69mm thickness 2.9mm		
For models:	B1011b, B1011i, B1221b, B1221i, B2011b, B2011i, B2021b, B2021i, B611b, B611i, B623i, O1011b, O1011i, O1221b, O1221i, O2011b, O2011i, O2021b, O2021i, O611b, O611i, O623i		

			
1			
Part No.	359922	Ref. No.	EA13-0101
description	lamp socket with 2 hole fixing 25V socket G4 connection cable 140mm ø 17mm H 10mm mounting distance 11.5mm cable material silicone		
For models:	B1011b, B1011i, B1221b, B1221i, B2011b, B2011i, B2021b, B2021i, B611b, B611i, B623i, O1011b, O1011i, O1221b, O1221i, O2011b, O2011i, O2021b, O2021i, O611b, O611i, O623i		

lamps			
halogen lamps			
for socket G4 / G6.35 / G9			
			
1			
Part No.	357193	Ref. No.	EA13-0100
description	halogen lamp socket G4 12V 20W temp.-resist. 300°C OSRAM HALOSTAR OVEN		

			
1			
Part No.	359599	Ref. No.	EA13-0100
description	halogen lamp socket G4 12V 20W temp.-resist. 500°C		
For models:	B1011b, B1011i, B1221b, B1221i, B2011b, B2011i, B2021b, B2021i, B611b, B611i, B623i, O1011b, O1011i, O1221b, O1221i, O2011b, O2011i, O2021b, O2021i, O611b, O611i, O623i		

alarm devices

loudspeakers			
			
1			
Part No.	350208	Ref. No.	AA11-9903
description	loudspeaker ø 50mm built-in depth 15mm 80hm 0.5W connection plug cable length 1360mm		

			
1			
Part No.	350209	Ref. No.	AA11-9904
description	loudspeaker ø 50mm built-in depth 15mm 80hm 0.5W connection plug cable length 1740mm		

			
1			
Part No.	350207	Ref. No.	AA11-9902
description	loudspeaker ø 50mm built-in depth 16mm 80hm 0.5W connection plug cable length 340mm		



			
1			
Part No.	350211	Ref. No.	EA13-0151
description	loudspeaker ø 50mm built-in depth 16mm 8Ohm 0.5W connection soldering connection cable lengthmm		
For models:	B1011b, B1011i, B1221b, B1221i, B2011b, B2011i, B2021b, B2021i, B611b, B611i, B623i, O1011b, O1011i, O1221b, O1221i, O2011b, O2011i, O2021b, O2021i, O611b, O611i, O623i		

			
1			
Part No.	380976	Ref. No.	EA02-0003
description	power contactor resistive load 32A 230VAC (AC3/400V) 18A/7.5kW main contacts 3NO auxiliary contacts 1NO/1NC connection screw connection		

contactors

TELEMECANIQUE (Schneider Electric)

power contactors

			
1			
Part No.	381010	Ref. No.	EA02-0002
description	power contactor resistive load 20A 230VAC (AC3/400V) 6A/2.2kW main contacts 2x3NO auxiliary contacts 2x1NO connection screw connection type LC2K0610P7		
For models:	O1011b, O1011i, O1221b, O1221i, O2011b, O2011i, O2021b, O2021i, O611b, O611i		

			
1			
Part No.	380979	Ref. No.	EA02-0004
description	power contactor resistive load 40A 230VAC (AC3/400V) 25A/11kW main contacts 3NO auxiliary contacts 1NO/1NC connection screw connection type LC1D25P7		
For models:	B1011b, B1011i, B611b, B611i, O1011b, O1011i, O611b, O611i		

			
1			
Part No.	380965	Ref. No.	EA02-0001
description	power contactor resistive load 20A 230VAC (AC3/400V) 6A/2.2kW main contacts 3NO auxiliary contacts 1NO connection screw connection type LC1K0610P7+		
For models:	B623i, O623i		

			
1			
Part No.	380982	Ref. No.	EA02-0006
description	power contactor resistive load 80A 230VAC (AC3/400V) 50A/22kW main contacts 3NO auxiliary contacts 1NO/1NC connection screw connection type LC1D50P7		
For models:	B1221b, B1221i, B2011b, B2011i, B2021b, B2021i, O1221b, O1221i, O2011b, O2011i, O2021b, O2021i		



solid state relays

CELDUC



1

Part No.	402974	Ref. No.	EA02-0203 EA02-203
description	solid state relay CELDUC 2 phase 50A 24-600V 10-30VDC L 58mm W 45mm plug screw type SOB965660		
For models:	B1011b, B1011i, B1221b, B1221i, B2011b, B2011i, B2021b, B2021i, B611b, B611i, B623i, O1011b, O1011i, O1221b, O1221i, O2011b, O2011i, O2021b, O2021i, O611b, O611i, O623i		

heat-conducting foils



1

Part No.	403355	Ref. No.	EA02-0204
description	heat-conducting foil L 37mm W 37mm		

relays

plug-in/print relays

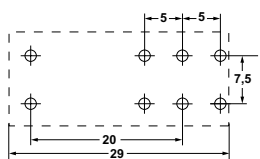

1

Part No.	380333	Ref. No.	EA01-0104
description	print relay 230VAC 2CO at 250V 8A connection pins raster size 5mm FINDER manif. no. 40.52.8.230.0000 95.65/95.75		
accessories for	380333		
	Part No.	380340	Ref. No. —
	relay socket dimensions 62x36x15mm 250V voltage AC 10A Italiana Relè manif. no. ZMEM/5		
	Part No.	380505	Ref. No. —
	relay socket 2CO 40.52 dimensions 81.9x15.5x75mm 250V voltage AC 10A FINDER manif. no. 95.95.3		
	Part No.	381181	Ref. No. —
	relay socket 2-pole 40.51/40.52/40.61 connection screw clamp dimensions 15.8x78.6mm 250V voltage AC 10A FINDER manif. no. 95.75		

relay sockets

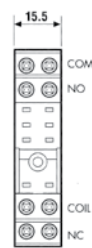

1

Part No.	381241	Ref. No.	EA13-0103
description	relay socket DIN rail connection screw dimensions 80x46x15mm 300V voltage AC 10A FINDER manif. no. 95.85.3 95.85.3		

transformers

toroidal core transformers



1

Part No.	403333	Ref. No.	EA13-0010
description	transformer primary 230VAC secondary 11.5VAC 20VA connection cable 200mm 50Hz type toroid temperature restriction 120°C ambient temperature max. 40°C		
For models:	B623i, O623i		



1

Part No.	403336	Ref. No.	EA13-0011
description	transformer primary 230VAC secondary 11.5VAC 40VA connection cable 200mm 50Hz		
For models:	B1011b, B1011i, B611b, B611i, O1011b, O1011i, O611b, O611i		

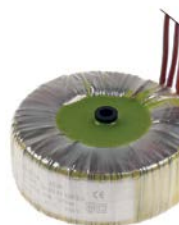

1

Part No.	403340	Ref. No.	EA13-0009
description	transformer primary 230VAC secondary 11.5VAC 63VA connection cable 200mm 50Hz type toroid		
For models:	B1221b, B1221i, B2011b, B2011i, B2021b, B2021i, O1221b, O1221i, O2011b, O2011i, O2021b, O2021i		



encapsulated transformers

with screw connection



1

Part No.	403352	Ref. No.	EA13-0008
description	transformer primary 230VAC secondary 17VAC 20VA secondary 1.17A connection screw 50-60Hz type 704077 DIN rail temperature restriction 125°C ambient temperature max. 40°C		
For models:	B1011b, B1011i, B1221b, B1221i, B2011b, B2011i, B2021b, B2021i, B611b, B611i, B623i, O1011b, O1011i, O1221b, O1221i, O2011b, O2011i, O2021b, O2021i, O611b, O611i, O623i		

probes

producer-specific probes

probes



1

Part No.	378348	Ref. No.	EA10-0007
description	temperature probe Pt100 cable silicone probe -100 up to 450°C cable -50 up to +180°C connection plug thread M10x1.5 probe ø6x30mm cable length 1.5m		



1

Part No.	378350	Ref. No.	EA10-0006
description	temperature probe Pt100 cable silicone probe -100 up to 450°C cable -50 up to +180°C connection plug thread probe ø4.5x25mm cable length 1.5m		



1

Part No.	381239	Ref. No.	EA10-0104
description	temperature probe thermocouple K (NiCr-Ni) cable PTFE probe -50 up to 1150°C cable -40 up to +250°C connection coded plug thread probe ø2x4mm cable length 1.5m		
For models:	B1011b, B1011i, B1221b, B1221i, B2011b, B2021b, B611b, B611i, B623i, O1011b, O1011i, O1221b, O1221i, O2011b, O2021b, O611b, O611i, O623i		



1

Part No.	381240	Ref. No.	EA10-0105
description	temperature probe thermocouple K (NiCr-Ni) cable PTFE probe -50 up to 1150°C cable -40 up to +250°C connection coded plug thread probe ø2x7mm cable length 2m		
For models:	B2011b, B2011i, B2021b, B2021i, O2011b, O2011i, O2021b, O2021i		

Part No.	381238	Ref. No.	EA10-0103
description	temperature probe thermocouple K (NiCr-Ni) cable silicone probe -50 up to 1150°C cable -50 up to +180°C connection coded plug thread probe ø1.9x140mm cable length 1.4m		
For models:	B1011b, B1011i, B1221b, B1221i, B2011b, B2011i, B2021b, B2021i, B611b, B611i, B623i, O1011b, O1011i, O1221b, O1221i, O2011b, O2011i, O2021b, O2021i, O611b, O611i, O623i		

core probes



1

Part No.	378349 ¹	Ref. No.	EA10-0069
description	core temperature probe Pt100 cable PTFE probe -40 up to +250°C cable -40 up to +250°C connection coded plug probe ø4.5x125mm thread M12x1.75 cable length 1m handle ø 14mm handle length 58mm		

¹multipoint probe



1

Part No.	378359	Ref. No.	EA10-0055
description	core temperature probe Pt100 cable PTFE probe -40 up to +250°C cable -40 up to +250°C connection coded plug probe ø4x115mm thread M12x1.75 cable length 1.5m handle ø 14mm handle length 58mm		



1



Part No.	378677	Ref. No.	EA10-0058
description	core temperature probe Pt100 cable PTFE probe -40 up to +250°C cable -40 up to +250°C connection coded plug probe ø4x125mm thread M12x1.75 cable length 0.8m handle ø 14mm handle length 58mm		

1



Part No.	381237	Ref. No.	EA10-0111 EA10-0116
description	core temperature probe thermocouple K (NiCr-Ni) cable PTFE probe -40 up to +250°C cable -40 up to +250°C connection coded plug probe ø3.9x170mm thread M16x2 cable length 1.4m handle ømm handle length 50mm		
For models:	O1011b, O1011i, O611b, O611i, O623i		

1



Part No.	381234 ¹	Ref. No.	EA10-0113 EA10-0118
description	core temperature probe thermocouple K (NiCr-Ni) cable PTFE probe -40 up to +250°C cable -40 up to +250°C connection coded plug probe ø3.9x170mm thread M16x2 cable length 1.4m handle ømm handle length 50mm		
For models:	B1011b, B1011i, B611b, B611i, B623i		

1



Part No.	381235 ¹	Ref. No.	EA10-0119
description	core temperature probe thermocouple K (NiCr-Ni) cable PTFE probe -40 up to +250°C cable -40 up to +250°C connection coded plug probe ø3.9x170mm thread M16x2 cable length 1.8m handle ømm handle length 50mm		

¹ multipoint probe

¹ multipoint probe





1

Part No.	381236	Ref. No.	EA10-0117
description	core temperature probe thermocouple K (NiCr-Ni) cable PTFE probe -40 up to +250°C cable -40 up to +250°C connection coded plug probe ø3.9x170mm thread M16x2 cable length 2.1m handle ømm handle length 50mm		



1

Part No.	403937	Ref. No.	EA14-0041
description	display combi-steamer L 95mm W 72mm		



1

Part No.	404012	Ref. No.	XC10-2100
description	display combi-steamer Orange FreeScale 2011 L 17mm W 13mm model XC10-2100 with control H 50mm type orange		
For models:	O1011b, O1011i, O1221b, O1221i, O2011b, O2011i, O2021b, O2021i, O611b, O611i, O623i		

electronics

frequency converters

accessories



1

Part No.	403356	Ref. No.	EA16-0041
description	braking resistor for frequency converter L 78mm W 29mm H 16mm 20-60W cable length 170mm VW3TR342150RJ 150Ohm		
For models:	B1011b, B1011i, B1221b, B1221i, B2011b, B2011i, B2021b, B2021i, B611b, B611i		

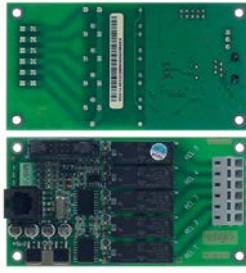

1

Part No.	403936	Ref. No.	EA14-0032
description	electronic controller for cleaning system L 112mm W 60mm		

PCBs



1

Part No.	404013	Ref. No.	XC10-2000
description	display combi-steamer Blue FreeScale2011 L 170mm W 130mm suitable for RETIGO model XC10-2000-10 with control H 50mm type blue		
For models:	B1011b, B1011i, B1221b, B1221i, B2011b, B2011i, B2021b, B2021i, B611b, B611i, B623i		

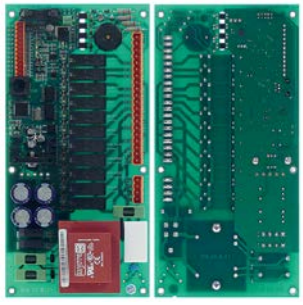

1

Part No.	403938	Ref. No.	EA14-0043
description	power PCB combi-steamer L 230mm W 115mm		

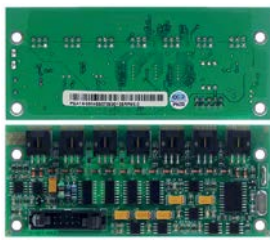

			
1			
Part No.	404014	Ref. No.	EA14-0080
description	relay PCB combi-steamer B1011/B2011 L 200mm W 115mm model RP20B.15 with ribbon cable H 30mm		
For models:	B1011b, B1011i, B1221b, B1221i, B2011b, B2011i, B2021b, B2021i, B611b, B611i, B623i, O1011b, O1011i, O1221b, O1221i, O2011b, O2011i, O2021b, O2021i, O611b, O611i, O623i		

			
1			
Part No.	404029	Ref. No.	EA14-0014
description	relay PCB combi-steamer L 112mm W 47mm		

solenoid valves



solenoid valves (water)

ROBERTSHAW/INVENSYS

medium temperature: 90°C 90°C 60°C
 ambient temperature: 60°C 25°C 60°C
 duty cycle: 40% 100% 100%

			
1			
Part No.	372021	Ref. No.	EA12-0050
description	solenoid valve double straight 230VAC inlet 3/4" outlet 11.5mm DN10 EATON (INVENSYS)		
For models:	B1011b, B1011i, B611b, B611i, B623i, O1011b, O1011i, O1221b, O1221i, O2011b, O2011i, O2021b, O2021i, O611b, O611i, O623i		

			
1			
Part No.	372003	Ref. No.	EA12-0051
description	solenoid valve single straight 230VAC inlet 3/4" outlet 10mm DN10 EATON (INVENSYS)		
For models:	O623i		

			
1			
Part No.	372018	Ref. No.	EA12-0050
description	solenoid valve single straight 230VAC inlet 3/4" outlet 14mm DN10 EATON (INVENSYS) flow regulating valve outlet flow regulating valve inlet white		
spare parts for	372018		
	Part No.	371122	Ref. No. —
	solenoid valve filter ø 19mm H 10mm suitable for MÜLLER		
	Part No.	371131	Ref. No. —
	solenoid coil 230VAC		

			
1			
Part No.	372025	Ref. No.	EA12-0056
description	solenoid valve triple straight 230VAC inlet 3/4" outlet 11.5mm DN10 EATON (INVENSYS)		
For models:	B1011b, B1011i, B1221b, B1221i, B2011b, B2011i, B2021b, B2021i, B611b, B611i, O1221b, O1221i, O2011b, O2011i, O2021b, O2021i		

RPE

reducers

outlet side

			
1			
Part No.	371247	Ref. No.	EA12-0303
description	reducer RPE flow rate 1-1.25l/min white		
For models:	B1011b, B1011i, B1221b, B1221i, B2011b, B2021b, B2021i, B611b, B611i, O1011b, O1011i, O1221b, O1221i, O2011b, O2021b, O2021i, O611b, O611i		

electrodes

			
1			
Part No.	403295	Ref. No.	AC24-0101
description	level electrode M16x1 total length 205mm probe L 148mm insulated probe length 8mm connection 3-wire cable length 40mm		

			
1			
Part No.	403353	Ref. No.	AC24-0602
description	level electrode push-in total length 225mm probe L 185mm insulated probe length 170mm triple connection bullet connector ø 15mm level suitable for RETIGO for 611/1011/1221/2011 edition boiler		
For models:	B1011b, B1221b, B2011b, B2021b, B611b, O1011b, O1221b, O2011b, O2021b, O611b		



fans

axial fans

import



1

Part No.	601909 ¹	Ref. No.	ZA21-0007
description	axial fan L 119mm W 119mm H 38mm 220-240 50/60Hz 31/29W bearing ball bearing connection male faston 2.8mm		
For models:	B1011b, B1011i, B1221b, B1221i, B2011b, B2011i, B2021b, B2021i, B611b, B611i, B623i, O1011b, O1011i, O1221b, O1221i, O2011b, O2011i, O2021b, O2021i, O611b, O611i, O623i		

¹with ball bearings

hot air motors



1

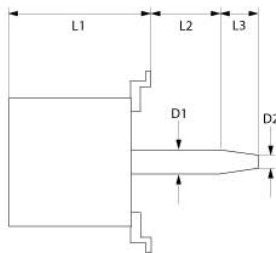

Part No.	499311	Ref. No.	AA11-0016 EA11-0014 EA11-14
description	fan motor 440V 3 phase 50Hz 0.3kW 1410rpm speeds 1 L1 130mm L2 22mm L3 38mm M10 1.2/0.7A at 50Hz 1410rpm D1 ø 17mm D2 ø 13.5mm		
For models:	B1011b, B1011i, B1221b, B1221i, B2011b, B2011i, B2021b, B2021i, B611b, B611i, O1011b, O1011i, O1221b, O1221i, O2011b, O2011i, O2021b, O2021i, O611b, O611i		



1

Part No.	602002	Ref. No.	AX09-0004
description	fan wheel D1 ø 175mm H1 38.5mm blades 9 D2 ø 8mm D3 ø 8mm H2 10mm H3 12mm		
For models:	B623i, O623i		



1

Part No.	602000	Ref. No.	AX09-0006
description	fan wheel D1 ø 320mm H1 110mm blades 12 D2 ø 13mm D3 ø 16.4mm H2 12mm H3 18mm		
For models:	B1221b, B1221i, B2021b, B2021i, O1221b, O1221i, O2021b, O2021i		



1

Part No.	602001	Ref. No.	AX09-0001
description	fan wheel D1 ø 320mm H1 83mm blades 12 D2 ø 13mm D3 ø 16.4mm H2 12mm H3 18mm		
For models:	B1011b, B1011i, B2011b, B2011i, B611b, B611i, O1011b, O1011i, O2011b, O2011i, O611b, O611i		



1

Part No.	551259	Ref. No.	AX00-0006
description	gasket motor shaft gasket ID ø 16.5mm ED ø 29mm thickness 4.2mm		
For models:	B1011b, B1011i, B1221b, B1221i, B2011b, B2011i, B2021b, B2021i, B611b, B611i, O1011b, O1011i, O1221b, O1221i, O2011b, O2011i, O2021b, O2021i, O611b, O611i		



1

Part No.	551261	Ref. No.	AX00-0011
description	gasket motor shaft gasket ID ø 8.5mm ED ø 20mm		
For models:	B623i, O623i		



1

Part No.	694684	Ref. No.	EA05-0201
description	motor supply line for hot air motors shielded conductor 3PH/PE L 1040mm for model 6011, 1011 ED ø 8.5mm		

1

Part No.	694685	Ref. No.	EA05-0202
description	motor supply line for hot air motors shielded conductor 3PH/PE L 600mm for model 1221 ED ø 8.5mm Qty 2 pcs		



1

Part No.	694686	Ref. No.	EA05-0203
description	motor supply line for hot air motors shielded conductor 3PH/PE L 900mm L 1.3m for model 2011 ED ø 8.5mm Qty 2 pcs		

hot air fans

HANNING



1

Part No.	601910	Ref. No.	EA11-0004
description	hot air fan 220-240V 125W 0.46/0.56A 3600rpm L1 115mm L2 3mm L3 12mm L4 95mm fan wheel ø 100mm HANNING		
For models:	B623i, O623i		

radial fans

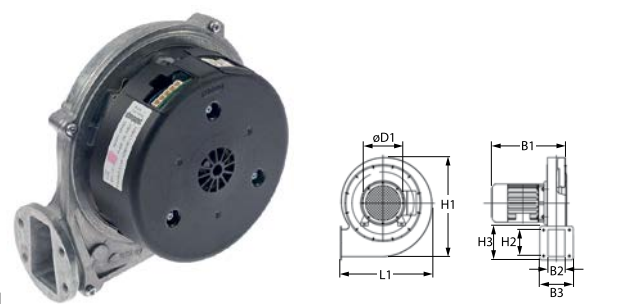

1

Part No.	692477	Ref. No.	ZA21-0008
description	radial fan 230V voltage AC 50Hz H1 150mm L1 170mm D1 ø 80mm W1 90mm W2 28mm H2 49mm W3 65mm H3 65mm		

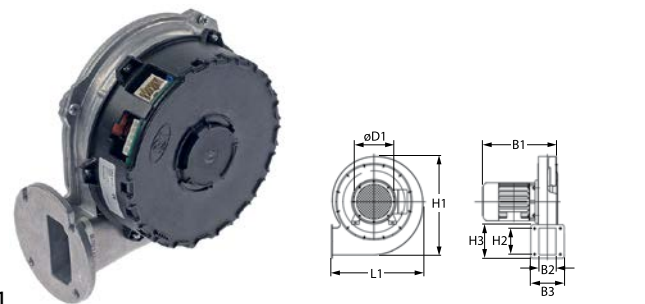

1

Part No.	692478	Ref. No.	ZA21-0009
description	radial fan 230V voltage AC 50Hz H1 165mm L1 170mm D1 ø 80mm W1 80mm W2 23mm H2 46mm W3 83mm H3 83mm		

motors
gear motors
for ovens
for flues



1

Part No.	602072	Ref. No.	AC25-0112/S AC25-0311/S
description	gear motor 5W 220-240V voltage AC 50/60Hz 3/3.6rpm shaft ømm L 84mm W 70mm H 54.4mm		



1

Part No.	601912	Ref. No.	EA11-0012
description	gear motor FIBER type P245J01C128 230V voltage AC 50Hz shaft ø 6.3mm L 71.5mm W 56.5mm H 46.5mm motor type M51BJ0L0000/ M51BJ0R0000		
For models:	B1011b, B1011i, B1221b, B1221i, B2011i, B2021b, B2021i, B611b, B611i, B623i		



pumps

drain pumps

HANNING



1

Part No.	499328	Ref. No.	EA10-0005 EA12-0005
description	pump 25W 220-240V inlet ø 30mm outlet ø 24mm 50Hz type DP020-028 HANNING		

PLASET



1

Part No.	499312	Ref. No.	EA12-0001
description	pump inlet ø 30mm outlet ø 22mm 220/240V 34W 50Hz PLASET type 50763		
For models:	B1011b, B1011i, B1221b, B1221i, B2011b, B2011i, B2021b, B2021i, B611b, B611i, B623i, O1011b, O1221b, O2011b, O2021b, O611b		

accessories

pump covers



1

Part No.	500303	Ref. No.	ZA14-0105
description	body inlet ø 24mm outlet ø 22mm suitable for drain pump		
For models:	B1221b, B1221i, B2011b, B2011i, B2021b, B2021i		

condensators & interference suppression filters

operating capacitors

metal



1

Part No.	365191	Ref. No.	EA13-0301
description	operating capacitor capacity 3µF 400V tolerance 5% 60Hz ambient temperature max. -40 up to +85°C ø 30mm L 85mm M8 aluminium connection cable 400mm MLR25L40303063		
For models:	B623i, O623i		

filters

line filters

with housing



1

Part No.	403358	Ref. No.	EA13-0057
description	line filter type FC61113 400V 50-60Hz three-phase connection cable length 500mm mounting DIN rail		
For models:	B1011b, B1011i, B611b, B611i, B623i, O1221b, O1221i, O2011b, O2011i, O2021b, O2021i, O623i		



1

Part No.	403357	Ref. No.	EA13-0058
description	line filter type FC61113b 400V 50-60Hz conductor 3 connection cable 500mm L 70mm ømm H 34mm W 50mm DIN rail plastic Qty 1 pcs		
For models:	B1221b, B1221i, B2011b, B2011i, B2021b, B2021i, O1011b, O1011i, O611b, O611i		



1

Part No.	365189	Ref. No.	EA13-0109
description	line filter type SKY2FN3 230V 50-60Hz conductor 2 with E connection spring terminal L 90mm ømm H 40mm W 52mm DIN rail plastic Qty 1 pcs		
For models:	B1011b, B1011i, B1221b, B1221i, B2011b, B2011i, B2021b, B2021i, B611b, B611i		

			
1			
Part No.	365190	Ref. No.	EA13-0056
description	line filter type TS8111022B 250V 50-60Hz conductor 2 with E connection cable 300mm L 41mm ømm H 38mm W 18mm DIN rail plastic Qty 1 pcs		
For models:	B1221b, B1221i, B2011b, B2011i, B2021b, B2021i, B623i, O1221b, O1221i, O2011b, O2011i, O2021b, O2021i, O623i		

			
1			
Part No.	551255	Ref. No.	EA07-1309
description	PCB terminal block 9-pole max. 16A max 400V raster size 5mm		



electronic components

varistors

			
1			
Part No.	403354	Ref. No.	EA05-0200
description	varistor		

gas valves and ignition boxes

gas control valves

SIT			
SIGMA			
			
1			
Part No.	106009	Ref. No.	ZA12-0003
description	gas valve 230V 50Hz gas inlet 3/4" gas outlet 3/4" pressure range 0.5-12mbar Sigma equiv. no. 0.848.037		
spare parts for	106009		
	Part No.	106214	Ref. No.
			—
	solenoid coil 230V 50Hz Sigma		
accessories for	106009		
	Part No.	107222	Ref. No.
			EA05-0055
	plug for solenoid valve 3-pole cable length 1070mm		

fuses

line circuit breakers

miscellaneous

			
1			
Part No.	381233	Ref. No.	EA03-0016
description	line circuit breaker 1-pole 6A tripping type D rated 230/400V connection screw mounting DIN rail 1 phase		
For models:	B1011b, B1011i, B1221b, B1221i, B2011b, B2011i, B2021b, B2021i, B611b, B611i, B623i, O623i		

			
1			
Part No.	381232	Ref. No.	EA03-0018
description	line circuit breaker 3-pole 6A tripping type D rated 400V connection screw mounting DIN rail 3 phase		
For models:	O1011b, O1011i, O1221b, O1221i, O2011b, O2011i, O2021b, O2021i, O611b, O611i		

electric accessories

terminals

PCB terminal blocks

			
1			
Part No.	551256	Ref. No.	EA07-1310
description	PCB terminal block 10-pole max. 16A max 400V raster size 5mm		

			
1			
Part No.	551257	Ref. No.	EA07-1014
description	PCB terminal block 14-pole max. 1A max 240V raster size 3mm		



ignition boxes

BRAHMA

BRAHMA



1



Part No.	103193	Ref. No.	EA01-0203
description	ignition box BRAHMA type SM592N.2 electrodes 1 waiting time 1.5s safety time 10s 230V 7VA 50-60Hz with reset button		

ignition parts

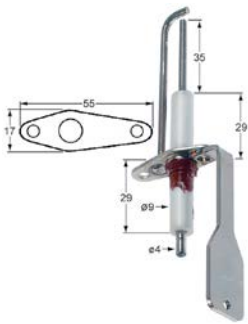
electrodes



1

Part No.	103191	Ref. No.	AC31-0903
description	ignition electrode flange length 55mm flange width 17mm D1 9mm L1 35mm BL1 29mm BL2 29mm connection 4mm		
spare parts for	103191		
	Part No.	692511	Ref. No. AX31-0044
	gasket for ignition electrode Qty 1 RETIGO AC31-0903		
accessories for	103191		
	Part No.	692511	Ref. No. AX31-0044
	gasket for ignition electrode Qty 1 RETIGO AC31-0903		

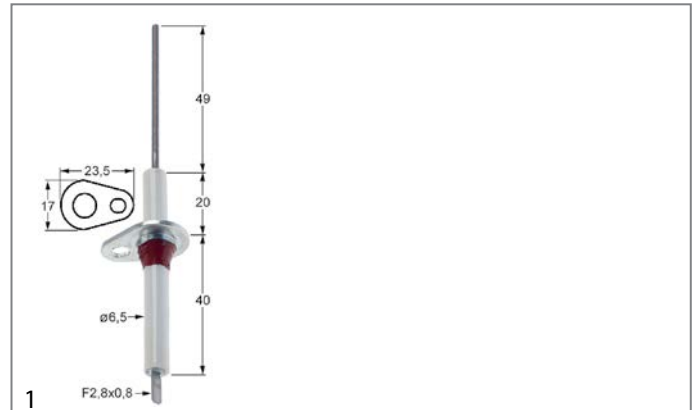

1

Part No.	103188	Ref. No.	AT31-0029
description	monitoring electrode flange length 23.5mm D1 6.5mm flange width 17mm L1 49mm BL1 20mm BL2 40mm connection male faston 2.8mm		
accessories for	103188		
	Part No.	692512	Ref. No. AX31-0045
	gasket for flame monitoring Qty 1 RETIGO		



1

Part No.	103189	Ref. No.	ZA22-0153
description	monitoring electrode flange length 23.5mm D1 6.8mm flange width 17mm L1 55mm L2 19mm BL1 46mm BL2 10mm connection screw		



1

Part No.	103268	Ref. No.	AA31-0014
description	monitoring electrode flange length 23.5mm D1 6.8mm flange width 17mm L1 64mm L2 26mm BL1 54.5mm BL2 18mm connection screw		



ignition cables

various



Part No.	103192	Ref. No.	EA05-0077
description	ignition cable cable length 880mm connection bullet connector 3.6 1mm ² ED ø 4.8mm insulation PTFE conductor silver plated white 0.150hm		

ignition units

BRAHMA









Part No.	103194	Ref. No.	EA13-0013
description	ignition unit outputs 1 220-240VAC dimensions 85x70x35mm mounting distance 60mm inlet cable outlet ø4mm type TC1SVCS 25VA 50/60Hz BRAHMA equiv. no. 15911250		

gas burners

burners for convection ovens



Part No.	104656	Ref. No.	ZA22-0003
description	burner 38kW W 140mm L 315mm H 120mm		
spare parts for	104656		
	Part No.	103191	Ref. No. AC31-0903
	ignition electrode flange length 55mm flange width 17mm D1 ø 9mm L1 35mm BL1 29mm BL2 29mm connection ø 4mm		
	Part No.	692509	Ref. No. AP31-0100 KP31-0100
	frame for burner RETIGO ZA22-0003 size 320x136mm Qty 1		
	Part No.	692510	Ref. No. AT31-0047 ZA13-3040
	gasket for burner RETIGO ZA22-0003 Qty 1m		
	Part No.	692511	Ref. No. AX31-0044
	gasket for ignition electrode Qty 1 RETIGO AC31-0903		
accessories for	104656		
	Part No.	692509	Ref. No. AP31-0100 KP31-0100
	frame for burner RETIGO ZA22-0003 size 320x136mm Qty 1		
	Part No.	692510	Ref. No. AT31-0047 ZA13-3040
	gasket for burner RETIGO ZA22-0003 Qty 1m		

equipment-specific units

for ice-cube maker

hoses

formed hoses

straight

silicone hoses



Part No.	530062	Ref. No.	ZA11-0805
description	silicone hose ID ø 16mm ED ø 23mm L 1m t.max. 200°C transparent		

for convection ovens/combi-steamers

drain units

accessories



Part No.	694681	Ref. No.	AC02-2202
description	strainer insert ED ø 118mm H 13.5mm spring holder SS		
For models:	B1011b, B1011i, B1221b, B1221i, B2011b, B2011i, B2021b, B2021i, B611b, B611i, B623i, O1011b, O1011i, O1221b, O1221i, O2011b, O2011i, O2021b, O2021i, O611b, O611i, O623i		

steam pipes



Part No.	530920	Ref. No.	ZA10-0500
description	steam hose silicone L 68mm ID ø 38mm ED ø 46mm for combi-steamer steam generator		

injection nozzles



Part No.	542109	Ref. No.	AT00-0056
description	nozzle bore ø 0.7mm D1 ø 12mm brass mounting pos. inside hose 07 TYC D12-8		
For models:	B1011i, B1221i, B2011i, B2021i, B611i, B623i, O1011i, O1221i, O2011i, O2021i, O611i, O623i		



injection pipes



1

Part No.	696859	Ref. No.	AC12-0100
description	injection pipe for combi-steamer ED ø 10mm ID ø 6mm L 250mm		



1

Part No.	692485	Ref. No.	AC12-1000
description	injection pipe L 350mm H 130mm ID ø 8mm ED ø 12mm		
For models:	B2021b, B2021i, O2021b, O2021i		



1

Part No.	692480	Ref. No.	AC12-0800
description	injection pipe L 185mm H 45mm ID ø 12mm ED ø 8mm		
For models:	B623i, O623i		



1

Part No.	692483	Ref. No.	AC12-1100
description	injection pipe L 190mm H 125mm ID ø 8mm ED ø 12mm		



1

Part No.	692484	Ref. No.	AC12-0900 AC12-1300
description	injection pipe L 235mm H 130mm ID ø 8mm ED ø 12mm		
For models:	B1221b, B1221i, O1221b, O1221i		



1

Part No.	692482	Ref. No.	AC12-0700
description	injection pipe L 243mm H 115mm ID ø 8mm ED ø 12mm		
For models:	B1011b, B1011i, B2011b, B2011i, B611b, B611i, O1011b, O1011i, O2011b, O2011i, O611b, O611i		



front panels



1

Part No.	694705	Ref. No.	AC21-1406/S/CH1
description	front panel for combi-steamer L 1580mm W 190mm H 60mm SS with accessories RETIGO		
For models:	O2011b, O2011i		





Part No.	694704	Ref. No.	AC21-1506/S/CH1
description	front panel for combi-steamer L 530mm W 190mm H 60mm SS with accessories RETIGO		
For models:	O623i		
accessories for	694704		
	Part No.	360594	Ref. No. EA05-0052
	USB cable A mounting screw mounting bush 1.5m		
	Part No.	360607	Ref. No. AX21-0001+AX21-
	USB cover plastic A mounting screw mounting bush grey		



Part No.	694703	Ref. No.	AC21-1206/S/CH1
description	front panel for combi-steamer L 700mm W 190mm H 60mm SS with accessories RETIGO		
For models:	O611b, O611i		
accessories for	694703		
	Part No.	360594	Ref. No. EA05-0052
	USB cable A mounting screw mounting bush 1.5m		

accessories for	694703		
	Part No.	360607	Ref. No. AX21-0001+AX21-
	USB cover plastic A mounting screw mounting bush grey		



Part No.	694702	Ref. No.	AC21-1205/S/CH1
description	front panel for combi-steamer L 700mm W 190mm H 60mm SS with accessories RETIGO for touch screen		
For models:	B611b, B611i		
accessories for	694702		
	Part No.	360594	Ref. No. EA05-0052
	USB cable A mounting screw mounting bush 1.5m		
	Part No.	360607	Ref. No. AX21-0001+AX21-
	USB cover plastic A mounting screw mounting bush grey		
	Part No.	404013	Ref. No. XC10-2000
	display combi-steamer Blue FreeScale2011 L 170mm W 130mm suitable for RETIGO model XC10-2000-10 with control H 50mm type blue		



Part No.	694770	Ref. No.	AC21-1305/S/CH1
description	front panel for combi-steamer L 960mm W 190mm H 60mm SS with accessories RETIGO for touch screen		
For models:	B1011b, B1011i		



Part No.	694771	Ref. No.	AC21-1306/CH1
description	front panel for combi-steamer L 960mm W 190mm H 60mm SS with accessories RETIGO without touch screen		
For models:	O1011b, O1011i		

cleaning system

nozzles

			
1			
Part No.	694682	Ref. No.	AA32-0050 AT32-0052
description	nozzle hole ø 6.45mm H 17.8mm metal ED ø 52mm ID ø 44.6mm		
For models:	B1011b, B1011i, B1221b, B1221i, B2011b, B2011i, B2021b, B2021i, B611b, B611i, B623i		

hoses

			
1			
Part No.	698469	Ref. No.	ATOO-0006
description	hose ID ø 48mm ED ø 54mm L 83mm		

			
1			
Part No.	530920	Ref. No.	ZA10-0500
description	steam hose silicone L 68mm ID ø 38mm ED ø 46mm for combi-steamer steam generator		

door mechanics

accessories





			
1			
Part No.	694683	Ref. No.	AX03-0076
description	stop ø 14mm rubber ID ø 7.5mm H 14mm		
For models:	B1011b, B1011i, B1221b, B1221i, B2011b, B2011i, B2021b, B2021i, B611b, B611i, B623i, O1011b, O1011i, O1221b, O1221i, O2011b, O2011i, O2021b, O2021i, O611b, O611i, O623i		

			
1			
Part No.	694680	Ref. No.	ZA13-0516
description	stop ø 22.25mm rubber ID ø 14.75mm H 7.3mm		
For models:	B1011b, B1011i, B611b, B611i, B623i, O1011b, O1011i, O611b, O611i, O623i		







heat exchangers







Part No.	692505	Ref. No.	AC31-1700 AC31-4600
description	heat exchanger for combi-steamer RETIGO model 1011		
accessories for	692505		
	Part No.	103191	Ref. No. AC31-0903
	ignition electrode flange length 55mm flange width 17mm D1 ø 9mm L1 35mm BL1 29mm BL2 29mm connection ø 4mm		
	Part No.	103268	Ref. No. AA31-0014
	monitoring electrode flange length 23.5mm D1 ø 6.8mm flange width 17mm L1 64mm L2 26mm BL1 54.5mm BL2 18mm connection screw		
	Part No.	692515	Ref. No. AX31-0043
	gasket for heat exchanger Qty 1 MICA		
	Part No.	692516	Ref. No. KP31-0049
	gasket for heat exchanger brass for model Qty 1		
	Part No.	692518	Ref. No. AX31-0011
	gasket for gas supply Qty 1 silicone		



Part No.	692550	Ref. No.	AC31-3850
description	heat exchanger for combi-steamer RETIGO model 2011 L 2040mm short		
accessories for	692550		
	Part No.	103191	Ref. No. AC31-0903
	ignition electrode flange length 55mm flange width 17mm D1 ø 9mm L1 35mm BL1 29mm BL2 29mm connection ø 4mm		
	Part No.	103268	Ref. No. AA31-0014
	monitoring electrode flange length 23.5mm D1 ø 6.8mm flange width 17mm L1 64mm L2 26mm BL1 54.5mm BL2 18mm connection screw		
	Part No.	692515	Ref. No. AX31-0043
	gasket for heat exchanger Qty 1 MICA		
	Part No.	692516	Ref. No. KP31-0049
	gasket for heat exchanger brass for model Qty 1		
	Part No.	692518	Ref. No. AX31-0011
	gasket for gas supply Qty 1 silicone		



Part No.	692551	Ref. No.	AC31-3750
description	heat exchanger for combi-steamer RETIGO model 2011 L 2500mm LANG		
accessories for	692551		
	Part No.	103191	Ref. No. AC31-0903
	ignition electrode flange length 55mm flange width 17mm D1 ø 9mm L1 35mm BL1 29mm BL2 29mm connection ø 4mm		
	Part No.	103268	Ref. No. AA31-0014
	monitoring electrode flange length 23.5mm D1 ø 6.8mm flange width 17mm L1 64mm L2 26mm BL1 54.5mm BL2 18mm connection screw		
	Part No.	692515	Ref. No. AX31-0043
	gasket for heat exchanger Qty 1 MICA		
	Part No.	692516	Ref. No. KP31-0049
	gasket for heat exchanger brass for model Qty 1		
	Part No.	692518	Ref. No. AX31-0011
	gasket for gas supply Qty 1 silicone		



Part No.	692506	Ref. No.	AC31-1800 AC31-4700
description	heat exchanger for combi-steamer RETIGO model 611		

miscellaneous





Part No.	692513	Ref. No.	KP31-0153
description	bracket PAD 1 SS mounting pos. underneath burn chamber		



1



Part No.	692514	Ref. No.	AP31-0152 KP31-0152
description	bracket PAD 2 SS mounting pos. uinderneath burne chamber W 335mm H 160mm		
accessories for	692514		
	Part No.	692509	Ref. No. AP31-0100 KP31-0100
	frame for burner RETIGO ZA22-0003 size 320x136mm Qty 1		
	Part No.	692510	Ref. No. AT31-0047 ZA13-3040
	gasket for burner RETIGO ZA22-0003 Qty 1m		

1



Part No.	698467	Ref. No.	AT00-0002
description	bracket plastic for spray gun ø 21.5mm		
For models:	B1011b, B1011i, B1221b, B1221i, B2011b, B2011i, B2021b, B2021i, B611b, B611i, B623i, O1011b, O1011i, O1221b, O1221i, O2011b, O2011i, O2021b, O2021i, O611b, O611i, O623i		







1



Part No.	692508	Ref. No.	AC31-5000 AC31-5100
description	burner chamber RETIGO for 611 and 1011 L 400mm W 200mm H 230mm complete, but without gaskets not compatible with AC31-5000		

1



Part No.	692548	Ref. No.	20 AISI 316L AC31-4000
description	burner chamber RETIGO L 480mm W 160mm H 230mm complete, but without gaskets 20 AISI 316L		
accessories for	692548		
	Part No.	103191	Ref. No. AC31-0903
	ignition electrode flange length 55mm flange width 17mm D1 ø 9mm L1 35mm BL1 29mm BL2 29mm connection ø 4mm		
	Part No.	103268	Ref. No. AA31-0014
	monitoring electrode flange length 23.5mm D1 ø 6.8mm flange width 17mm L1 64mm L2 26mm BL1 54.5mm BL2 18mm connection screw		
	Part No.	692515	Ref. No. AX31-0043
	gasket for heat exchanger Qty 1 MICA		
	Part No.	692516	Ref. No. KP31-0049
	gasket for heat exchanger brass for model Qty 1		
	Part No.	692518	Ref. No. AX31-0011
	gasket for gas supply Qty 1 silicone		
	Part No.	692550	Ref. No. AC31-3850
	heat exchanger for combi-steamer RETIGO model 2011 L 2040mm short		
	Part No.	692551	Ref. No. AC31-3750
	heat exchanger for combi-steamer RETIGO model 2011 L 2500mm LANG		

1





Part No.	601914	Ref. No.	AA25-1002
description	flap kit for combi-steamer with cable with cover cap		
spare parts for	601914		
	Part No.	602072	Ref. No. AC25-0112/S AC25-0311/S
	gear motor 5W 220-240V voltage AC 50/60Hz 3/3.6rpm shaft ømm L 84mm W 70mm H 54.4mm		

Table continues overleaf



spare parts for 601914			
	Part No. 750400	Ref. No.	AC25-0105
pressure compensation valve for combi-steamer D1 ø 50mm D2 ø 84.5mm hole ø 50mm H 55mm			



Part No.	601913	Ref. No.	AC25-0100 V15-001-030
description	flap kit for combi-steamer with cover cap		
For models:	B1011b, B1011i, B1221b, B1221i, B2011i, B2021b, B2021i, B611b, B611i, B623i, O2011i		
spare parts for 601913			
	Part No. 602072	Ref. No.	AC25-0112/S AC25-0311/S
gear motor 5W 220-240V voltage AC 50/60Hz 3/3.6rpm shaft ømm L 84mm W 70mm H 54.4mm			
	Part No. 750400	Ref. No.	AC25-0105
pressure compensation valve for combi-steamer D1 ø 50mm D2 ø 84.5mm hole ø 50mm H 55mm			



Part No.	696592	Ref. No.	AC00-2500
description	hose connector bore ø 10mm D1 ø 10mm D2 ø 25mm SS thread M16		
For models:	B1011b, B1011i, B1221b, B1221i, B2011b, B2011i, B2021b, B2021i, B611b, B611i, B623i, O1011b, O1011i, O1221b, O1221i, O2011b, O2011i, O2021b, O2021i, O611b, O611i, O623i		



Part No.	750400	Ref. No.	AC25-0105
description	pressure compensation valve for combi-steamer D1 ø 50mm D2 ø 84.5mm hole ø 50mm H 55mm		
For models:	B1011b, B1011i, B1221b, B1221i, B2011i, B2021b, B2021i, B611b, B611i, B623i, O1011b, O1011i, O1221b, O1221i, O2011i, O2021b, O2021i, O611b, O611i, O623i		



Part No.	692479	Ref. No.	AX04-0001
description	rubber gasket rubber W 9.7mm ø 55mm for hose 379mm hole ø 38mm H 15mm		
For models:	B623i, O623i		



Part No.	692481	Ref. No.	AX04-0002
description	rubber gasket rubber W 9.7mm ø 65mm hole ø 48mm H 15mm		
For models:	B1011b, B1011i, B1221b, B1221i, B2011b, B2011i, B2021b, B2021i, B611b, B611i, O1011b, O1011i, O1221b, O1221i, O2011b, O2011i, O2021b, O2021i, O611b, O611i		

locks

handle latches

producer-specific

RETIGO



Part No.	696590	Ref. No.	AX08-0020
description	bezel for door handle suitable for combi-steamer ø 47mm black H 24mm hole ø 36mm		
For models:	B1011b, B1011i, B611b, B611i, B623i, O1011b, O1011i, O611b, O611i, O623i		





Part No.	692486	Ref. No.	ZA20-0901
description	catch clamp length 54mm BL 31mm for off-set 66-76mm		
For models:	B1011b, B1011i, B611b, B611i, B623i, O1011b, O1011i, O611b, O611i, O623i		

spare parts for 692486			
	Part No. 514450	Ref. No.	AX08-0024
spring for door handle ø 6mm L 61mm W 27.5mm			

	Part No. 692907	Ref. No.	ZA20-0910
spring holder L 20mm W 18mm H 8mm mounting pos. catch ø 4mm			



 <p>1</p>			
Part No.	694067	Ref. No.	ZA20-0902
description	door catch with spigot 1-stage L 26mm total length 51mm thread M8		
For models:	B1011b, B1011i, B611b, B611i, B623i, O1011b, O1011i, O611b, O611i, O623i		

 <p>1</p>			
Part No.	694066	Ref. No.	ZA20-0903
description	door catch with spigot 2-stage L 28mm W 14mm H 15mm H1 16mm total length 51mm thread M8 thread L 23mm stainless steel		
For models:	B1011b, B1011i, B611b, B611i, B623i, O1011b, O1011i, O611b, O611i, O623i		

 <p>1</p>			
Part No.	696588	Ref. No.	AC08-0700
description	door handle L 190mm W 35mm H 60mm handle ø 60.5mm spring length 50mm screw mounting black/silver plastic flange 50mm		
For models:	B1011b, B1011i, B611b, B611i, B623i, O1011b, O1011i, O611b, O611i, O623i		
spare parts for	696588		
	Part No.	514450	Ref. No. AX08-0024
	 <p>spring for door handle ø 6mm L 61mm W 27.5mm</p>		
	Part No.	692486	Ref. No. ZA20-0901
	 <p>catch clamp length 54mm BL 31mm for off-set 66-76mm</p>		
	Part No.	696587	Ref. No. AX08-0021
	 <p>door handle L 195mm W 38mm handle ø 60mm hole ø 8mm</p>		
accessories for	696588		
	Part No.	694066	Ref. No. ZA20-0903
	 <p>door catch with spigot 2-stage L 28mm W 14mm H 15mm H1 16mm total length 51mm thread M8 thread L 23mm stainless steel</p>		
	Part No.	694067	Ref. No. ZA20-0902
	 <p>door catch with spigot 1-stage L 26mm total length 51mm thread M8</p>		
	Part No.	696590	Ref. No. AX08-0020
	 <p>bezel for door handle suitable for combi-steamer ø 47mm black H 24mm hole ø 36mm</p>		

 <p>1</p>			
Part No.	696587	Ref. No.	AX08-0021
description	door handle L 195mm W 38mm handle ø 60mm hole ø 8mm		
For models:	B1011b, B1011i, B611b, B611i, B623i, O1011b, O1011i, O611b, O611i, O623i		

 <p>1</p>			
Part No.	692907	Ref. No.	ZA20-0910
description	spring holder L 20mm W 18mm H 8mm mounting pos. catch ø 4mm		

hinges

door bearing

 <p>1</p>			
Part No.	514534	Ref. No.	AAX03-0074 AP03-0135
description	bracket L 37mm W 25mm H 20mm mounting distance 15mm for glass plate		

 <p>1</p>			
Part No.	514533	Ref. No.	AT03-0024
description	hinge bearing L 20mm W 20mm H 13mm ø 5mm without bolt for glass plate		

filters

grease filters

grease filter

 <p>1</p>			
Part No.	970831	Ref. No.	ZA17-0010
description	grease filter W 135mm H 155mm thickness 9mm SS layers 7 outer grids 2 inner grids 5		
For models:	B1011b, B1011i, B1221b, B1221i, B2011b, B2011i, B2021b, B2021i, B611b, B611i, B623i, O1011b, O1011i, O1221b, O1221i, O2011b, O2011i, O2021b, O2021i, O611b, O611i, O623i		



equipment feet and end caps

equipment feet

with screw mounting



1

Part No.	701310	Ref. No.	AA00-0027 ZA15-0005
description	equipment foot tube ø 40mm thread M10 thread L 15mm H 80-110mm SS size 1 1/2" Qty 1 pcs		
For models:	B623i, O623i		



1

Part No.	701309	Ref. No.	AA00-0026 ZA15-0002
description	equipment foot tube ø 52mm thread M10 thread Lmm H 86-110mm SS size 2" Qty 1 pcs		
For models:	B1011b, B1011i, B611b, B611i, O1011b, O1011i, O611b, O611i		

with fixing plate



1

Part No.	701308	Ref. No.	ZA15-0008
description	equipment foot tube ø 58mm plate size 85x85mm hole distance 85mm H 208-315mm SS size 2 1/4" Qty 1 pcs		
For models:	B1221b, B1221i, B2011b, B2011i, B2021b, B2021i, O1221b, O1221i, O2011b, O2011i, O2021b, O2021i		

bolting feet



1

Part No.	701311	Ref. No.	AC09-0400
description	equipment foot ø 60.5mm H 40mm SS bore ø M10mm Qty 1 pcs		

STEINCO

with bolt hole

plastic



1

Part No.	701306	Ref. No.	ZA16-0003
description	swivel castor ø 100mm bolt hole bolt hole ø 10.3mm housing plastic capacity 90kg bearing ball bearing wheel body polypropylene tread thermoplastic H 135mm wheel width 30mm Qty 1 pcs		
For models:	B1221b, B1221i, B2011b, B2011i, B2021b, B2021i, O1221b, O1221i, O2011b, O2011i, O2021b, O2021i		



1

Part No.	701307 ¹	Ref. No.	ZA16-0004
description	swivel castor with swivel brake ø 100mm bolt hole bolt hole ø 10.3mm housing plastic capacity 90kg bearing ball bearing wheel body polypropylene tread thermoplastic H 135mm wheel width 30mm Qty 1 pcs		
For models:	B1221b, B1221i, B2011b, B2011i, B2021b, B2021i, O1221b, O1221i, O2011b, O2011i, O2021b, O2021i		

¹with swivel brake



gaskets

gaskets for heated units

door seals

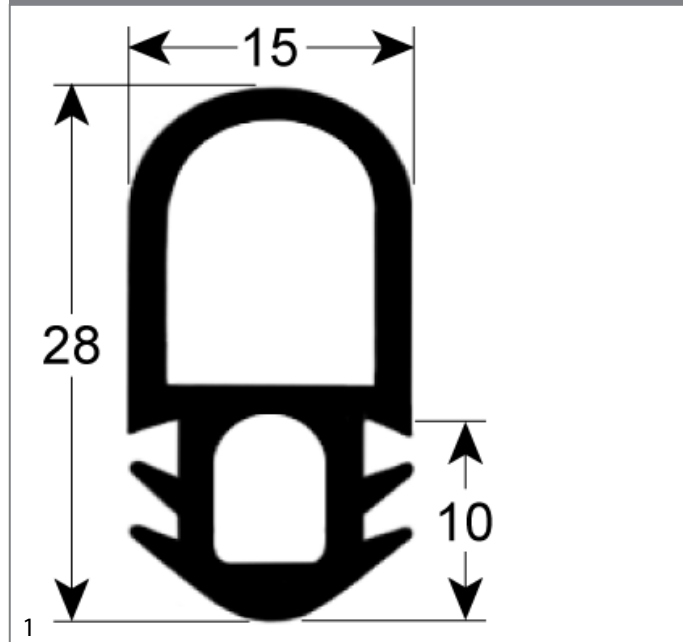

Part No.	901461	Ref. No.	AX00-0002
description	door seal profile 2052 W 505mm L 620mm external size		

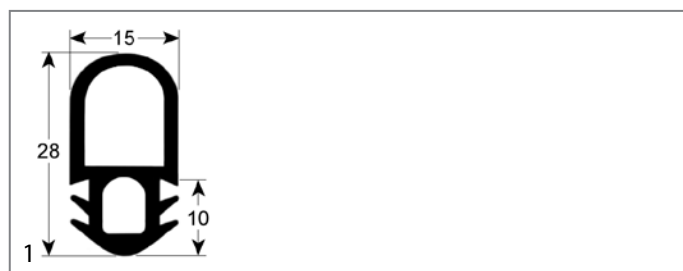

Part No.	901701	Ref. No.	AX00-0003
description	door seal profile 2052 W 615mm L 755mm external size		

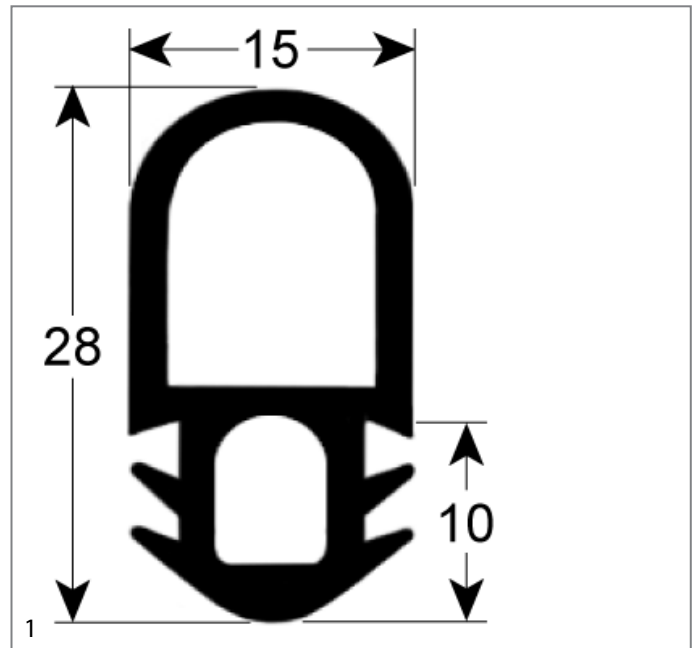

Part No.	902552	Ref. No.	AX00-0004
description	door seal profile 2052 W 660mm L 1420mm external size Qty 1		

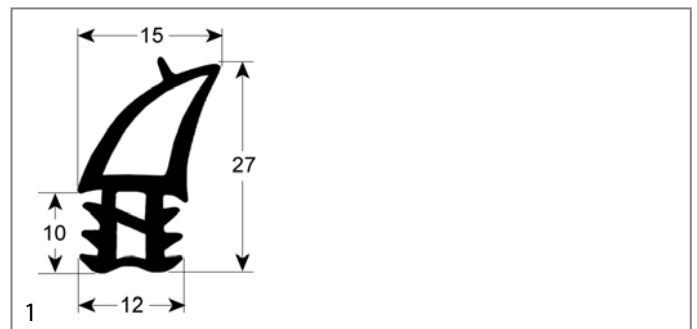

Part No.	901720	Ref. No.	AX00-0034
description	door seal profile 2729 W 405mm L 405mm external size Qty 1 suitable for RETIGO		
For models:	B623i, O623i		

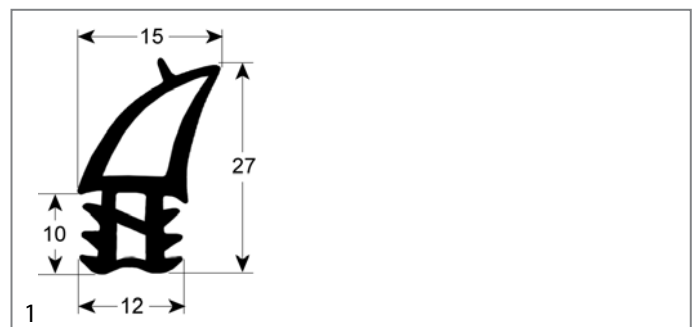

Part No.	901717	Ref. No.	AX00-0031 AX00-0038
description	door seal profile 2729 W 620mm L 1380mm external size Qty 1 suitable for RETIGO		
For models:	B2011b, B2011i, B2021b, B2021i, O2011b, O2011i, O2021b, O2021i		

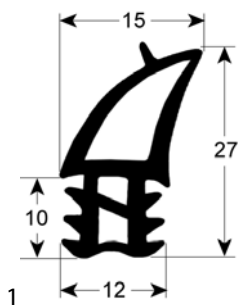

Part No.	901721	Ref. No.	AX00-0035
description	door seal profile 2729 W 620mm L 490mm external size Qty 1 suitable for RETIGO		
For models:	B611b, B611i, O611b, O611i		

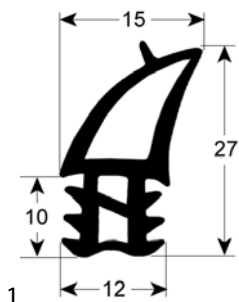

Part No.	901719	Ref. No.	AX00-0036
description	door seal profile 2729 W 620mm L 755mm external size Qty 1 suitable for RETIGO		
For models:	B1011b, B1011i, O1011b, O1011i		

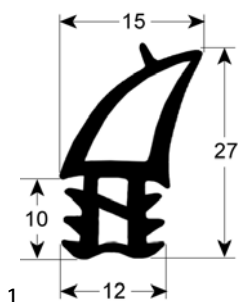

Part No.	901718	Ref. No.	AX00-0037
description	door seal profile 2729 W 620mm L 930mm external size Qty 1 suitable for RETIGO		
For models:	B1221b, B1221i, O1221b, O1221i		

gaskets for tray rack trolleys



Part No.	901722	Ref. No.	AX03-0078
description	tray rack trolley gasket L 645mm W 44mm suitable for RETIGO		
For models:	B1221b, B1221i, B2011b, B2011i, B2021b, B2021i, O1221b, O1221i, O2011b, O2011i, O2021b, O2021i		

O-rings

PTFE

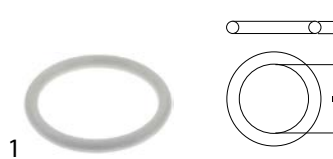

Part No.	696591	Ref. No.	ZA13-1549
description	O-ring silicone thickness 5.5mm ID ø 48.75mm		
For models:	B1011b, B1011i, B1221b, B1221i, B2011b, B2011i, B2021b, B2021i, B611b, B611i, B623i, O1011b, O1011i, O1221b, O1221i, O2011b, O2011i, O2021b, O2021i, O611b, O611i, O623i		

miscellaneous



Part No.	692509	Ref. No.	AP31-0100 KP31-0100	
description	frame for burner RETIGO ZA22-0003 size 320x136mm Qty 1			
accessories for	692509			
	Part No.	692510	Ref. No.	AT31-0047 ZA13-3040
	gasket for burner RETIGO ZA22-0003 Qty 1m			

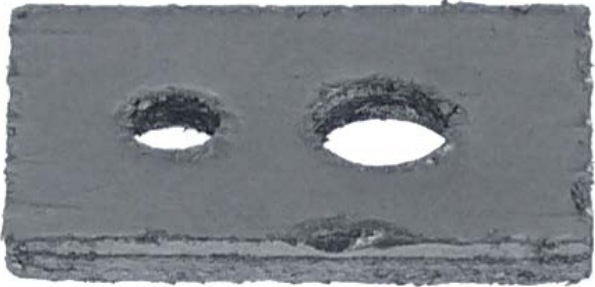

Part No.	692510	Ref. No.	AT31-0047 ZA13-3040	
description	gasket for burner RETIGO ZA22-0003 Qty 1m			
accessories for	692510			
	Part No.	692509	Ref. No.	AP31-0100 KP31-0100
	frame for burner RETIGO ZA22-0003 size 320x136mm Qty 1			

1

Part No.	692512	Ref. No.	AX31-0045
description	gasket for flame monitoring Qty 1 RETIGO		



1

Part No.	692516	Ref. No.	KP31-0049
description	gasket for heat exchanger brass for model Qty 1		

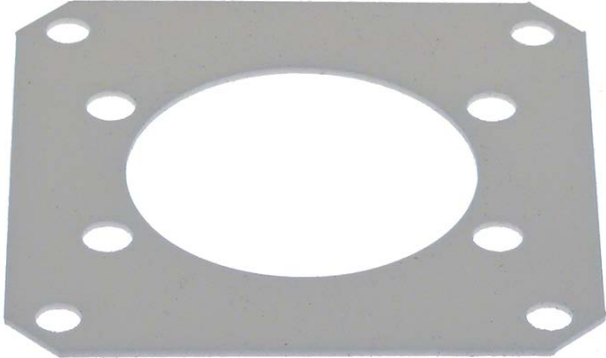

1

Part No.	692517	Ref. No.	AX31-0010
description	gasket for gas mixing compartment Qty 1 for type 611 and 1011		



1

Part No.	692515	Ref. No.	AX31-0043
description	gasket for heat exchanger Qty 1 MICA		

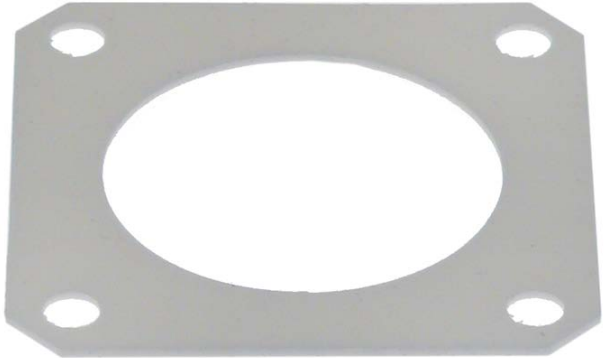

1

Part No.	692518	Ref. No.	AX31-0011
description	gasket for gas supply Qty 1 silicone		



1

Part No.	692511	Ref. No.	AX31-0044
description	gasket for ignition electrode Qty 1 RETIGO AC31-0903		

springs

miscellaneous



1

Part No.	514450	Ref. No.	AX08-0024
description	spring for door handle ø 6mm L 61mm W 27.5mm		



			
1			
Part No.	701316	Ref. No.	AC08-0208
description	spring clip U-shape door lock shaft diametermm ømm L 40mm W 50mm Hmm wire gauge ø 0.8mm		
For models:	B1221b, B1221i, B2011b, B2011i, B2021b, B2021i, O1221b, O1221i, O2011b, O2011i, O2021b, O2021i		

tension springs

			
1			
Part No.	701659	Ref. No.	AX08-0012
description	tension spring for door mechanism ø 7mm total length 44mm wire gauge ø 0.9mm for combi-steamer		



manometers

			
1			
Part No.	541998	Ref. No.	ZA12-0401 ZA12-0409
description	manometer ø 40mm pressure range 0-1bar connection 1/8"		
For models:	B1011i, B1221i, B2011i, B2021i, B611i, B623i, O1011i, O1221i, O2011i, O2021i, O611i, O623i		

hose reels and spray guns

spray guns

			
1			
Part No.	542038	Ref. No.	ZA15-0100
description	spray gun for appliances 3/8" IT L 135mm		
For models:	B1011b, B1011i, B1221b, B1221i, B2011b, B2011i, B2021b, B2021i, B611b, B611i, B623i, O1011b, O1011i, O1221b, O1221i, O2011b, O2011i, O2021b, O2021i, O611b, O611i, O623i		

			
1			
Part No.	698468	Ref. No.	AA26-1002
description	spray gun for appliances incl. accessories		
spare parts for	698468		
	Part No.	542038	Ref. No. ZA15-0100
	spray gun for appliances 3/8" IT L 135mm		
	Part No.	698467	Ref. No. AT00-0002
	bracket plastic for spray gun ø 21.5mm		

			
1			
Part No.	520892	Ref. No.	ZA11-0902
description	shower hose connections 3/8" L 1600mm EPDM t.max. 110°C burst p. 10bar for combi-steamer		
For models:	B1011b, B1011i, B611b, B611i, B623i, O1011b, O1011i, O611b, O611i, O623i		

			
1			
Part No.	520891	Ref. No.	ZA11-0904
description	shower hose connections 3/8" L 2100mm EPDM t.max. 110°C burst p. 10bar for combi-steamer		
For models:	B1221b, B1221i, B2011b, B2011i, B2021b, B2021i, O1221b, O1221i, O2011b, O2011i, O2021b, O2021i		



hoses

industrial hoses

PVC hoses

PVC braided hoses



1

Part No.	570163	Ref. No.	AA26-0101
description	PVC braided hose ID ø 10mm ED ø 17.2mm L 350m thickness 3.6mm PVC combi-steamer transparent Qty 1		



1

Part No.	570162	Ref. No.	AA26-0100
description	PVC braided hose ID ø 10mm ED ø 17.2mm L 440m thickness 3.6mm PVC combi-steamer transparent Qty 1		



1

Part No.	570164	Ref. No.	AA26-0104
description	PVC braided hose ID ø 10mm ED ø 17.2mm L 90m thickness 3.6mm PVC combi-steamer transparent Qty 1		

silicone hoses

without fabric



1

Part No.	530062	Ref. No.	ZA11-0805
description	silicone hose ID ø 16mm ED ø 23mm L 1m t.max. 200°C transparent		

with fabric

with monofilament braid



1

Part No.	530435	Ref. No.	ZA11-0803
description	silicone hose L 1m ID ø 10mm ED ø 17mm with monofilament braid thickness 3.5mm operating p. 4bar t.max. 200°C clear		
For models:	B2011i, O2011i		

formed hoses

straight



1

Part No.	530920	Ref. No.	ZA10-0500
description	steam hose silicone L 68mm ID ø 38mm ED ø 46mm for combi-steamer steam generator		

water cycle components

pressure reduction valves

pressure reduction valves

producer-specific



1

Part No.	541184	Ref. No.	ZA12-0201 ZA12-02012
description	pressure controller Metal Work series Bit MRA connection 1/4" default settingbar setting range 0-2bar p max 13bar t.max. 50°C plastic		
For models:	B1011i, B1221i, B2011i, B2021i, B611i, B623i, O1011i, O1221i, O2011i, O2021i, O611i, O623i		



1

Part No.	520958	Ref. No.	ZA12-0207
description	pressure reduction valve Norgren connection 1/4 / 1/8 default settingbar setting range 0.1-2bar		

GASTROPARTS.COM

