



GASTROPARTS

Repagas

- [EN]** Equipment
- [DE]** Geräte
- [ES]** Aparatos
- [FR]** Équipement
- [IT]** Attrezzature
- [PL]** Urządzenia
- [RU]** Оборудование

✉ gastroparts@gastroparts.com

☎ tel. +48 56 657 00 66

📘 fb.com/gastroparts.global

GASTROPARTS.COM





heating elements





heating elements for bain maries

			
Part No.	420216	Ref. No.	007410 22300016
description	heating element 1500W 230V heating circuits 1 L 490mm W 92mm connection screw tube ø 8mm 2 hole fixing thread M12x1.25 immersion heater for bain marie mounting distance 84mm		

heating elements for fryers

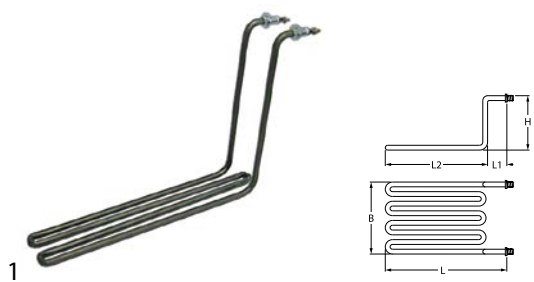
2 hole fixing

			
Part No.	415920	Ref. No.	8500013
description	heating element 2800W 230V heating circuits 1 L 280mm W 160mm H 185mm thread 1/4" tube ø 8.5mm windings 4 connection M4 2 hole fixing fryer heaters		
accessories for	415920		
	Part No.	510417	Ref. No. —
	flat gasket fibre ED ø 20mm ID ø 14mm thickness 2mm Qty 1 pcs		
	Part No.	520228	Ref. No. —
	tooth lock washer ID ø 15.3mm ED ø 24mm steel Qty 1 pcs for thread M14		
	Part No.	520230	Ref. No. 00112127 010106
	nut thread M14x1.5 H 5mm WS 19 zinc-coated steel Qty 1 pcs		
	Part No.	521101	Ref. No. —
	nut thread M14x1.5 H 5mm WS 19 SS Qty 1 pcs		
	Part No.	521103	Ref. No. —
	nut thread M4 H 3mm WS 7 brass Qty 20 pcs		
	Part No.	521104	Ref. No. —
	washer ID ø 4.3mm ED ø 8mm thickness 0.5mm brass Qty 20 pcs for thread M4		
	Part No.	550262	Ref. No. —
	flat gasket copper ED ø 20mm ID ø 14mm thickness 2mm		
	Part No.	560111	Ref. No. —
	plain washer ID ø 4.3mm ED ø 9mm thickness 0.8mm SS Qty 20 pcs DIN 125A for thread M4		
	Part No.	560131	Ref. No. —
	hexagonal nut thread M4 H 3.2mm WS 7 SS DIN/ISO DIN 934 / ISO 4032/8673 Qty 20 pcs		

			
Part No.	415921	Ref. No.	8700024
description	heating element 1260W 230V heating circuits 1 L 320mm W 48mm H 220mm L1 22mm L2 298mm thread 1/4" tube ø 8.5mm windings 2 2 hole fixing connection M4 fryer heaters		
accessories for	415921		
	Part No.	521103	Ref. No. —
	nut thread M4 H 3mm WS 7 brass Qty 20 pcs		
	Part No.	521104	Ref. No. —
	washer ID ø 4.3mm ED ø 8mm thickness 0.5mm brass Qty 20 pcs for thread M4		
	Part No.	560111	Ref. No. —
	plain washer ID ø 4.3mm ED ø 9mm thickness 0.8mm SS Qty 20 pcs DIN 125A for thread M4		
	Part No.	560131	Ref. No. —
	hexagonal nut thread M4 H 3.2mm WS 7 SS DIN/ISO DIN 934 / ISO 4032/8673 Qty 20 pcs		

group 7

			
Part No.	420210	Ref. No.	16300008
description	heating element 1600W 230V heating circuits 1 L 283mm W 75mm H 200mm 2 hole fixing connection male faston 6.3mm immersion heater L1 10mm L2 273mm W1 12.5mm W2 50mm H1 20mm H2 180mm tube ø 8.5mm thread 1/4" mounting distance 41.5mm windings 2		





			
Part No.	416783	Ref. No.	1140011
description	heating element 5500W 230V heating circuits 1 L 250mm W 60mm H 250mm L1 22mm L2 375mm H1 206mm H2 44mm thread M14x1.5 tube ø 8.5mm 2 hole fixing connection M4 fryer heaters windings 6		
accessories for	416783		
	Part No.	521103	Ref. No. —
	nut thread M4 H 3mm WS 7 brass Qty 20 pcs		

Table continues overleaf



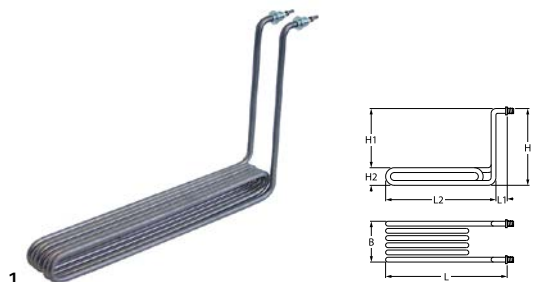

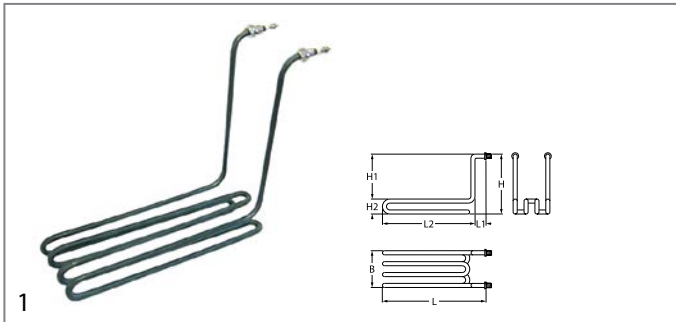

accessories for 416783			
	Part No.	521104	Ref. No. —
washer ID \varnothing 4.3mm ED \varnothing 8mm thickness 0.5mm brass Qty 20 pcs for thread M4			
	Part No.	560111	Ref. No. —
plain washer ID \varnothing 4.3mm ED \varnothing 9mm thickness 0.8mm SS Qty 20 pcs DIN 125A for thread M4			
	Part No.	560131	Ref. No. —
hexagonal nut thread M4 H 3.2mm WS 7 SS DIN/ISO DIN 934 / ISO 4032/8673 Qty 20 pcs			

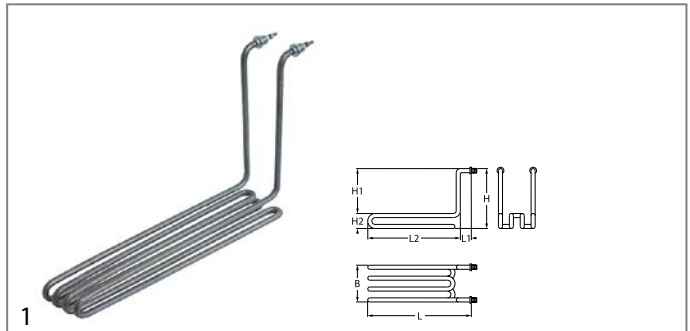

Part No.	415924	Ref. No.	1130002
description	heating element 3000W 230V heating circuits 1 L 297mm W 86mm H 243mm L1 22mm L2 275mm H1 207mm H2 36mm thread 1/4" mounting distance 34mm tube \varnothing 8.5mm 2 hole fixing connection M4 fryer heaters windings 4		
accessories for 415924			
	Part No.	361182	Ref. No. —
nut thread 1/4" H 5mm nickel-plated brass WS 17 Qty 1 pcs			
	Part No.	510417	Ref. No. —
flat gasket fibre ED \varnothing 20mm ID \varnothing 14mm thickness 2mm Qty 1 pcs			
	Part No.	520228	Ref. No. —
tooth lock washer ID \varnothing 15.3mm ED \varnothing 24mm steel Qty 1 pcs for thread M14			
	Part No.	521103	Ref. No. —
nut thread M4 H 3mm WS 7 brass Qty 20 pcs			
	Part No.	521104	Ref. No. —
washer ID \varnothing 4.3mm ED \varnothing 8mm thickness 0.5mm brass Qty 20 pcs for thread M4			
	Part No.	550262	Ref. No. —
flat gasket copper ED \varnothing 20mm ID \varnothing 14mm thickness 2mm			
	Part No.	560111	Ref. No. —
plain washer ID \varnothing 4.3mm ED \varnothing 9mm thickness 0.8mm SS Qty 20 pcs DIN 125A for thread M4			
	Part No.	560131	Ref. No. —
hexagonal nut thread M4 H 3.2mm WS 7 SS DIN/ISO DIN 934 / ISO 4032/8673 Qty 20 pcs			



Part No.	416782	Ref. No.	9000007
description	heating element 3333W 230V heating circuits 1 L 395mm W 85mm H 245mm L1 23mm L2 375mm H1 210mm H2 35mm thread 1/4" mounting distance 76mm tube \varnothing 8.5mm 2 hole fixing connection M4 connection length 37mm fryer heaters windings 4		
accessories for 416782			
	Part No.	521103	Ref. No. —
nut thread M4 H 3mm WS 7 brass Qty 20 pcs			
	Part No.	521104	Ref. No. —
washer ID \varnothing 4.3mm ED \varnothing 8mm thickness 0.5mm brass Qty 20 pcs for thread M4			
	Part No.	560111	Ref. No. —
plain washer ID \varnothing 4.3mm ED \varnothing 9mm thickness 0.8mm SS Qty 20 pcs DIN 125A for thread M4			
	Part No.	560131	Ref. No. —
hexagonal nut thread M4 H 3.2mm WS 7 SS DIN/ISO DIN 934 / ISO 4032/8673 Qty 20 pcs			

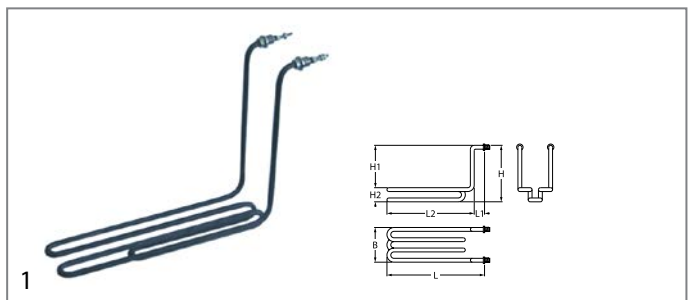









Part No.	415923	Ref. No.	8800027
description	heating element 2000W 230V heating circuits 1 L 315mm W 74mm H 250mm L1 20mm L2 295mm H1 214mm H2 36mm thread 1/4" mounting distance 66mm tube \varnothing 8.5mm 2 hole fixing connection M4 fryer heaters windings 2 fryer		
spare parts for 415923			
	Part No.	510417	Ref. No. —
flat gasket fibre ED \varnothing 20mm ID \varnothing 14mm thickness 2mm Qty 1 pcs			
accessories for 415923			
	Part No.	361182	Ref. No. —
nut thread 1/4" H 5mm nickel-plated brass WS 17 Qty 1 pcs			
	Part No.	520228	Ref. No. —
tooth lock washer ID \varnothing 15.3mm ED \varnothing 24mm steel Qty 1 pcs for thread M14			
	Part No.	521103	Ref. No. —
nut thread M4 H 3mm WS 7 brass Qty 20 pcs			
	Part No.	521104	Ref. No. —
washer ID \varnothing 4.3mm ED \varnothing 8mm thickness 0.5mm brass Qty 20 pcs for thread M4			

Table continues overleaf



accessories for		415923	
	Part No.	550262	Ref. No. —
	flat gasket copper ED ø 20mm ID ø 14mm thickness 2mm		
	Part No.	560111	Ref. No. —
	plain washer ID ø 4.3mm ED ø 9mm thickness 0.8mm SS Qty 20 pcs DIN 125A for thread M4		
	Part No.	560131	Ref. No. —
	hexagonal nut thread M4 H 3.2mm WS 7 SS DIN/ISO DIN 934 / ISO 4032/8673 Qty 20 pcs		

heating elements for heated cabinets

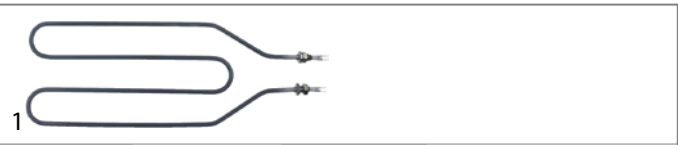

Part No.	419065	Ref. No.	1510002
description	heating element 1400W 230V heating circuits 1 L 375mm W 140mm connection length 30mm connection male faston 6.3mm tube ø 6.3mm 2 hole fixing thread M10x1 dry heating element L1 45mm L2 75mm L3 255mm W1 45mm W2 50mm mounting distance 44mm		

6 hole fixing



Part No.	420209	Ref. No.	16500005
description	heating element 9000W 230V heating circuits 3 L 310mm W 180mm H 235mm L1 10mm L2 300mm thread 1/4" mounting distance 34.5mm tube ø 8.5mm 6 hole fixing connection male faston 6.3mm immersion heater fryer		

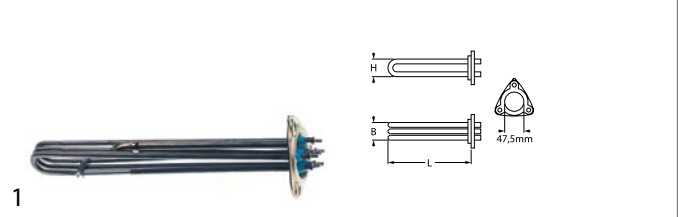

immersion heating elements

3 hole flange ø47.5mm



Part No.	418136	Ref. No.	1250007
description	heating element 4360W 240V mounting ø 47.5mm heating circuits 3 L 310mm W 31mm H 35mm number of thermostat sleeves 1 thermostat sleeves ø 7mm length thermostat sleeves 200mm thermostat sleeve clinging tube ø 6.3mm hole distance 62mm hole ø 8mm connection M4 3 hole flange immersion heater		

spare parts for		418136	
	Part No.	510408	Ref. No. —
	O-ring EPDM thickness 5.34mm ID ø 47mm Qty 1 pcs		

accessories for		418136	
	Part No.	510408	Ref. No. —
	O-ring EPDM thickness 5.34mm ID ø 47mm Qty 1 pcs		
	Part No.	510562	Ref. No. —
	O-ring silicone thickness 5.34mm ID ø 47mm Qty 1 pcs		

heating elements for griddles



Part No.	420218	Ref. No.	016053 32100002
description	heating element 1000W 230V heating circuits 1 L 345mm W 56mm H 55mm tube ø 10x10mm screw connection M4 connection distance 46mm dry heating element		

heating elements for contact grills



Part No.	420217	Ref. No.	32400014
description	heating element 1300W 230V heating circuits 1 L 300mm W 130mm H 55mm connection distance 120mm tube ø 10mm dry heating element connection screw		



with expansion flange 70 x 18mm





Part No.	418137	Ref. No.	42000003
description	heating element 3000W 230V heating circuits 1 flange 70x18mm L 220mm W 65mm Hmm connection male faston 6.3mm tube ø 8.5mm immersion heater expansion flange connection length 34mm		









heating elements for convection

			
1			
Part No.	418102	Ref. No.	91600001
description	heating element 16400W 230V heating circuits 3 ID \varnothing 441mm ED \varnothing 458mm L 492mm H 143mm L1 34mm W1 104mm H1 128mm H2 115mm flange length 142mm flange width 25mm hole distance 63mm connection M6x1 tube \varnothing 8.5mm convection heating element hole \varnothing 6mm rectangular flange		
accessories for	418102		
	Part No.	699165	Ref. No. —
	gasket L 142mm W 25mm D1 \varnothing 6.5mm D2 \varnothing 12mm hole distance 17mm 9 holes graphite thickness 2mm		

			
1			
Part No.	418134	Ref. No.	1230005
description	heating element 3300W 240V heating circuits 1 ID \varnothing 185mm ED \varnothing 200mm L 215mm H 30mm W1 60mm H1 5mm H2 25mm flange length 100mm flange width 22mm hole distance 85mm connection male faston 6.3mm connection length 22mm tube \varnothing 6.5mm convection heating element hole \varnothing 5mm rectangular flange		

			
1			
Part No.	418132	Ref. No.	1250016
description	heating element 7350W 230V heating circuits 3 ID \varnothing 250mm ED \varnothing 265mm L 277mm H 75mm L1 17mm W1 102mm H1 12mm H2 67mm flange length 143mm flange width 25mm hole distance 7mm connection M4 tube \varnothing 6.5mm convection heating element hole \varnothing 63mm rectangular flange		

			
1			
Part No.	418753	Ref. No.	45200001
description	heating element 8000W 230V heating circuits 3 ID \varnothing 287mm ED \varnothing 300mm L 345mm H 90mm L1 39mm H1 20mm H2 67mm flange length 142mm flange width 25mm hole distance 12.7mm connection M4 connection length 67mm tube \varnothing 6.5mm convection heating element hole \varnothing 7mm rectangular flange		

			
1			
Part No.	418135	Ref. No.	1230006
description	heating element 920W 230V heating circuits 1 ID \varnothing 200mm ED \varnothing 215mm L 255mm H 40mm thread 1/4" connection male faston 6.3mm 2 hole fixing mounting distance 24mm tube \varnothing 8.5mm convection heating element		
accessories for	418135		
	Part No.	361182	Ref. No. —
	nut thread 1/4" H 5mm nickel-plated brass WS 17 Qty 1 pcs		
	Part No.	510417	Ref. No. —
	flat gasket fibre ED \varnothing 20mm ID \varnothing 14mm thickness 2mm Qty 1 pcs		
	Part No.	520228	Ref. No. —
	tooth lock washer ID \varnothing 15.3mm ED \varnothing 24mm steel Qty 1 pcs for thread M14		
	Part No.	550262	Ref. No. —
	flat gasket copper ED \varnothing 20mm ID \varnothing 14mm thickness 2mm		

			
1			
Part No.	419261	Ref. No.	92000041
description	heating element 9500/10400W 230/240V heating circuits 3 ID \varnothing 320mm ED \varnothing 337mm L 380mm H 148mm L1 40mm W1 105mm H1 20mm H2 120mm flange length 142mm flange width 25mm hole distance 18mm connection M6x1 connection length 85mm tube \varnothing 8.5mm convection heating element flange combi-steamer		



			
1			
Part No.	419222	Ref. No.	92800004
description	heating element 27000/29000W 400/415V L 590mm W 545mm H 140mm heating circuits 3 cable lengthmm		

			
1			
Part No.	418139	Ref. No.	1240014
description	heating element 3500W 240V heating circuits 1 L 620mm W 120mm L1 33mm L2 587mm W2 90mm flange length 70mm flange width 22mm hole distance 56mm connection length 100mm connection M4 tube ø 8.5mm hole ø 6mm W1 30mm rectangular flange convection heating element windings 2		

accessories

hexagonal nuts			
			
1			
Part No.	520230	Ref. No.	00112127 010106
description	nut thread M14x1.5 H 5mm WS 19 zinc-coated steel Qty 1 pcs		

energy regulators

EGO

1-circuit			
			
1			
Part No.	380019	Ref. No.	1230018
description	energy regulator 240V 13A single-circuit turn direction right shaft ø 6x4.6mm shaft L 23mm mounting thread M4 power release 6-100% no. 50.57071.010		

thermostats

control and safety thermostats

EGO

control thermostats

55.10/19_ series

			
1			
Part No.	390779	Ref. No.	64100014
description	thermostat t.max. 190°C temperature range 105-190°C 1-pole 1NO 0.5A probe ø 4mm probe L 235mm capillary pipe 1470mm capillary pipe isolated 1250mm gland nut M10x1 shaft ø 6x4.6mm shaft L 23mm shaft position lower rotation 270°		

			
1			
Part No.	390731	Ref. No.	8500014
description	thermostat t.max. 195°C temperature range 65-195°C 1-pole 1NO 16A probe ø 4mm probe L 106mm capillary pipe 1470mm capillary pipe isolatedmm gland nut shaft ø 6x4.6mm shaft L 23mm shaft position° shaft position upper rotation 270°		

			
1			
Part No.	390068	Ref. No.	1230017
description	thermostat t.max. 269°C temperature range 55-269°C 1-pole 1CO 16A probe ø 3.1mm probe L 219mm capillary pipe 1280mm capillary pipe isolated 1270mm gland nut shaft ø 6x4.6mm shaft L 23mm shaft position upper° rotation 318°		



E·G·O



Part No.	375002	Ref. No.	1270013
description	thermostat t.max. 320°C temperature range 55-320°C 1-pole 1NO 16A probe ø 3.1mm probe L 226mm capillary pipe 870mm capillary pipe isolated 850mm gland nut shaft L 23mm shaft position upper rotation 270°		

55.13_series

E·G·O



Part No.	375505	Ref. No.	32403007
description	thermostat t.max. 320°C temperature range 50-320°C 1-pole 1NO 16A probe ø 3mm probe L 160mm capillary pipe 870mm capillary pipe isolatedmm gland nut shaft ø 6x4.6mm shaft L 23mm shaft position upper rotation 270°		

55.34_series

E·G·O

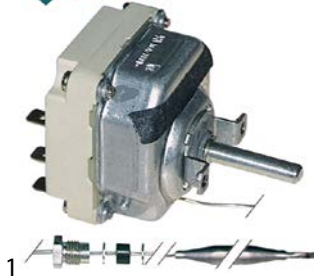

Part No.	375021	Ref. No.	22405003
description	thermostat t.max. 110°C temperature range 32-110°C 3-pole 3CO 16A probe ø 6mm probe L 138mm capillary pipe 2980mm capillary pipe isolated 2200mm gland nut M9x1 shaft ø 6x4.6mm shaft L 23mm shaft position upper rotation 270°		

E·G·O

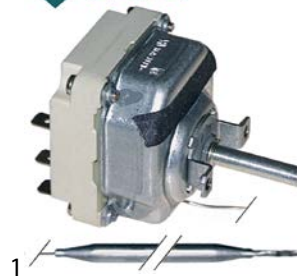

Part No.	375038	Ref. No.	32104009
description	thermostat t.max. 300°C temperature range 50-300°C 3-pole 3NO 16A probe ø 6mm probe L 79mm capillary pipe 1740mm capillary pipe isolated 800mm gland nut shaft ø 6x4.6mm shaft L 23mm shaft position upper rotation 270°		

accessories for 375038



Part No.	110123	Ref. No.	—
description	knob thermostat t.max. 300°C ø 50mm shaft ø 6x4.6mm shaft flat upper black temperature range 50-300°C rotation 270°		

56._series

E·G·O



Part No.	376076	Ref. No.	57103017
description	thermostat t.max. 200°C temperature range 60-200°C 16A probe ø 6mm probe L 78mm capillary pipe 870mm		

safety thermostats

55.10/19_series

E·G·O

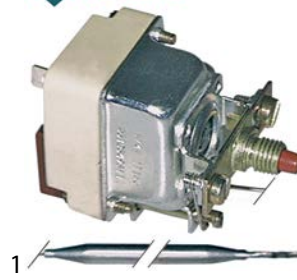

Part No.	375250	Ref. No.	1440003
description	safety thermostat capillary pipe 870mm probe ø 6mm 1-pole probe L 129mm 16A capillary pipe isolatedmm gland nut switch-off temp. 130°C probe SS		

spare parts for 375250



Part No.	551083	Ref. No.	—
description	cap for safety thermostat thread M8x1		



E·G·O



1

Part No.	390730	Ref. No.	09500064
description	safety thermostat switch-off temp. 230°C 1-pole 0.5A probe ø 4mm probe L 125mm capillary pipe 1550mm capillary pipe isolated 1410mm gland nut probe		

55.13_ series

E·G·O



1

Part No.	390804	Ref. No.	010677 20400023 73313025
description	safety thermostat switch-off temp. 340°C 1-pole 1NC 16A probe ø 3mm probe L 160mm capillary pipe 870mm capillary pipe isolated 600mm gland nut probe connection male faston 6.3mm		

55.31_ series

E·G·O



1

Part No.	390091	Ref. No.	8700021
description	safety thermostat switch-off temp. 230°C 3-pole 20A probe ø 6mm probe L 239mm capillary pipe 830mm capillary pipe isolated 960mm gland nut probe SS 380V		

55.32_ series

E·G·O



1

Part No.	375649	Ref. No.	1250025
description	safety thermostat switch-off temp. 160°C 3-pole 20A probe ø 6mm probe L 87mm capillary pipe 890mm capillary pipe isolated 880mm gland nut probe SS		

56_ series

E·G·O



1

Part No.	390714	Ref. No.	8500016
description	safety thermostat switch-off temp. 230°C 1-pole 1NC 16A probe ø 6mm probe L 75mm capillary pipe 740mm capillary pipe isolated 200mm gland nut probe SS		

IMIT / TEMPOMATIC / ARTHERMO

control thermostats

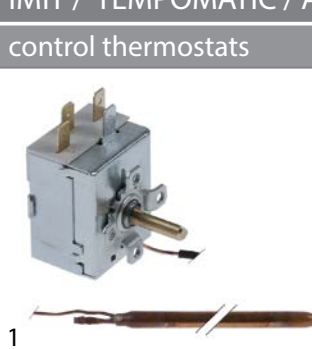

1

Part No.	390683	Ref. No.	25304008
description	thermostat t.max. 86°C temperature range 0-86°C 1-pole 1CO 16A probe ø 6.5mm probe L 98mm capillary pipe 1000mm capillary pipe isolated 960mm gland nut shaft ø 6x4.6mm shaft L 20mm shaft position +135° rotation 270° probe material copper		
accessories for	390683		
	Part No.	110100	Ref. No. —
	knob thermostat t.max. 90°C 0-90°C ø 42mm shaft ø 6x4.6mm shaft flat -135° black		

1

Part No.	375847	Ref. No.	25304008
description	thermostat t.max. 90°C temperature range 0-90°C 1-pole 1CO 15A probe ø 6.5mm probe L 100mm capillary pipe 1500mm capillary pipe isolatedmm gland nut shaft ø 6x4.6mm shaft L 18mm shaft position +135° rotation 270° 250V		

safety thermostats



1

Part No.	375941	Ref. No.	57103016
description	safety thermostat switch-off temp. 238°C 1-pole 1NC 16A probe ø 5mm probe L 100mm capillary pipe 1050mm capillary pipe isolatedmm gland nut 250V		

CAEM

control thermostats

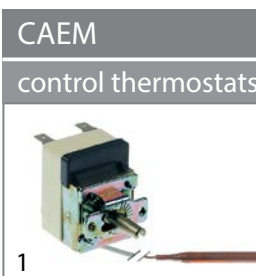

1

Part No.	375645	Ref. No.	43000006
description	thermostat t.max. 120°C temperature range 30-120°C 1-pole 1CO 16A probe ø 6mm probe L 110mm capillary pipe 1600mm capillary pipe isolated 1550mm gland nut shaft ø 6x4.6mm shaft L 22mm shaft position upper rotation 270° probe material copper 250V		

accessories

miscellaneous



1

Part No.	550268	Ref. No.	8700008
description	cover cap for push-button		

switches and momentary switches

microswitches

pin-plunger actuated

M10



1

Part No.	347216	Ref. No.	1230024
description	microswitch with plunger thread M10x0.75 thread L 14mm 250V 10A 1CO connection male faston 6.3mm stroke 7.5mm mounting distance 22mm L 28mm ambient temperature max. 125°C type NR6K5 actuating force: 260g		

system switches (ROLD)



1

Part No.	345537	Ref. No.	44700004
description	element holder mounting measurements 20.6x16.4mm grey arched for push buttons 13x17mm		



1

Part No.	345131	Ref. No.	1510009
description	element holder mounting measurements 28.5x28.5mm grey single element holder		



1

Part No.	345606	Ref. No.	43000005
description	momentary switch unit 2CO 250V 16A connection male faston 6.3mm		



1

Part No.	346211	Ref. No.	1510008
description	push button ø 23mm grey with lens		

1

Part No.	345539	Ref. No.	44700003
description	push button size 17x13mm grey		



1

Part No.	345605	Ref. No.	1250039
description	switch 2CO 250V 16A connection male faston 6.3mm		

cam switches

4 operating positions

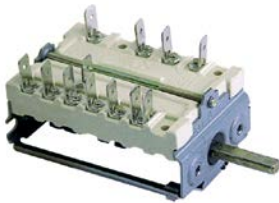

1

Part No.	300010	Ref. No.	1230016
description	cam switch 4 operating positions 2NO/2CO sequence 0-1-2-3 16A shaft ϕ 6x4.6mm shaft L 23mm connection male faston 6.3mm ceramic		

operation switches



1

Part No.	300153	Ref. No.	1270012
description	cam switch 3 operating positions operation switch 16A sequence 0-1-2 shaft ϕ 6x4.6mm shaft L 23mm connection male faston 6.3mm plastic ambient temperature max. 240°C		

rotary switches

TECNOMATIC



1

Part No.	345016	Ref. No.	8700027
description	rotary switch 2 0-1 sets of contacts 1 type HD1201R000 600V 12A shaft ϕ 5x5mm shaft L 23mm shaft square connection screw		

TELERGON



1

Part No.	347693	Ref. No.	015963 27800010
description	rotary switch 2 0-1 sets of contacts 1 type T-0002000011E1N1 300V 20A shaft ϕ 5x5mm shaft L 15mm shaft square with knob connection screw clamp		

magnetic switches

37x16mm

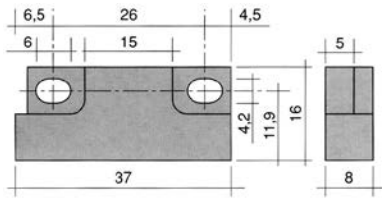



1

Part No.	345600	Ref. No.	92000018
description	magnetic switch L 37mm W 16mm 1NO 250V 0.2A P max. 50W connection cable length 960mm		
accessories for	345600		
	Part No.	Ref. No.	—
	519049		
description	magnet ϕ mm L 63mm H 10.7mm W 18.8mm hole distance 52mm M2 hole ϕ 2mm		

accessories

magnets



1

Part No.	691178	Ref. No.	92000021
description	magnet ϕ 22mm Lmm H 7mm Wmm ED ϕ 22mm M5		

encoders and potentiometers



1

Part No.	402322	Ref. No.	90200019
description	encoder		



			
1			
Part No.	300272	Ref. No.	90100015
description	encoder shaft ø 6x4.6mm for combi-steamer		

			
1			
Part No.	401592	Ref. No.	020042 44100002
description	potentiometer 10KOhm		

lamps

indicator lights

indicator lights (complete)

ø10mm

with screw socket

			
1			
Part No.	359528	Ref. No.	57103020
description	indicator light ø 10mm 400V red connection male faston 6.3mm socket male faston 6.3mm		

with plug-in socket

			
1			
Part No.	359139	Ref. No.	1250050
description	indicator light ø 10mm green 230V connection male faston 6.3mm Qty 1 pcs		

			
1			
Part No.	359138	Ref. No.	1260025
description	indicator light ø 10mm red 230V connection male faston 6.3mm Qty 1 pcs		

			
1			
Part No.	359140	Ref. No.	1230023
description	indicator light ø 10mm yellow 230V connection male faston 6.3mm Qty 1 pcs		

ø13mm

with screw socket

			
1			
Part No.	357125	Ref. No.	32100012
description	indicator light ø 13mm red 400V connection screw clamp		

33x10mm

			
1			
Part No.	359452	Ref. No.	8500007
description	indicator light mounting measurements 33.1x10.3mm 400V green connection male faston 6.3mm		

			
1			
Part No.	359451	Ref. No.	8500005
description	indicator light mounting measurements 33.1x10.3mm 400V yellow connection male faston 6.3mm		

miscellaneous

			
1			
Part No.	357124	Ref. No.	012865 25303013
description	indicator light green/red 230V connection screw		

			
1			
Part No.	357123	Ref. No.	16300009
description	indicator light red 230V connection cable ø 8mm		

screw-on/push-on fit

light bulbs

for ovens

			
1			
Part No.	359610	Ref. No.	1230009
description	light bulb t.max. 300°C socket E14 15W 230V ø 22mm L 47mm lens L 20mm for oven lamp type Philips		







			
1			
Part No.	357153	Ref. No.	1250021
description	light bulb t.max. 300°C socket E14 25W 230V ø 25mm L 55mm lens L 30mm for oven type		



halogen lamp
for socket G4 / G6.35 / G9

			
1	500°C		
Part No.	359599	Ref. No.	42200007
description	halogen lamp socket G4 12V 20W temp.-resist. 500°C		



oven lamps

universal oven lamps
mounting diameter 35.5mm

			
1			
Part No.	359701	Ref. No.	1230010
description	lamp socket socket E14 220-230V mounting ø 35.5mm connection male faston 6.3mm 15W		
accessories for	359701		
	Part No.	359705	Ref. No. —
	oven lamp glass thr.ø 33.5mm ø 52mm hard glas temp.-resist. 350°C		
	Part No.	359709	Ref. No. —
	oven lamp glass thr.ø 33.5mm ø 42mm hard glas temp.-resist. 350°C		
	Part No.	359721	Ref. No. 1230008
	gasket silicone ED ø 48mm ID ø 39.5mm thickness 5mm Qty 1 pcs		
	Part No.	359942	Ref. No. —
	oven lamp glass thr.ø 33.5mm ø 41mm hard glas temp.-resist. 350°C		

			
1			
Part No.	359661	Ref. No.	1230007
description	oven lamp glass thread 32.1 ø 58mm hard glas temp.-resist. 350°C		
accessories for	359661		
	Part No.	359700	Ref. No. —
	gasket for pizza oven fibre glass ID ø 32.5mm ED ø 55mm thickness 5mm		

			
1			
Part No.	359721	Ref. No.	1230008
description	gasket silicone ED ø 48mm ID ø 39.5mm thickness 5mm Qty 1 pcs		

<p>55x70mm</p> 			
1			
Part No.	359297	Ref. No.	44100006
description	frame L 95mm W 81mm mounting distance 68/83mm thickness 6mm		
accessories for	359297		
	Part No.	359299	Ref. No. 44100005
	gasket L 91mm W 77mm hole ø 3mm for oven lamp		

			
1			
Part No.	359299	Ref. No.	44100005
description	gasket L 91mm W 77mm hole ø 3mm for oven lamp		

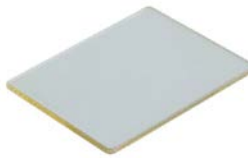
			
1			
Part No.	359296	Ref. No.	44100004
description	lamp glass L 74mm W 58mm thickness 3mm		











<p>55x100mm</p> 			
1			
Part No.	359698	Ref. No.	1250065
description	lamp socket L 100mm W 55mm socket E14 connection male faston 6.3mm		
spare parts for	359698		
	Part No.	358119	Ref. No. —
	frame L 118mm W 72mm mounting distance 143mm for bulb socket		
	Part No.	358122	Ref. No. —
	gasket L 112mm W 68mm silicone thickness 3mm for bulb socket		
	Part No.	358123	Ref. No. —
	lamp glass L 112mm W 68mm		

Table continues overleaf













spare parts for		359698	
	Part No.	359612	Ref. No. —
light bulb t.max. 300°C socket E14 25W 230V ø 25mm L 56mm lens L 30mm for oven lamp type Philips			
	Part No.	359714	Ref. No. 1250020
gasket for bulb socket			
	Part No.	359715	Ref. No. 1250019
lamp glass L 110mm W 65mm thickness 5mm			
	Part No.	359716	Ref. No. 1250018
frame for bulb socket			
accessories for		359698	
	Part No.	359612	Ref. No. —
light bulb t.max. 300°C socket E14 25W 230V ø 25mm L 56mm lens L 30mm for oven lamp type Philips			
	Part No.	359938	Ref. No. —
borosilicate glass L 115mm W 69mm			

1			
Part No.	359716	Ref. No.	1250018
description		frame for bulb socket	

1			
Part No.	359714	Ref. No.	1250020
description		gasket for bulb socket	

1			
Part No.	359715	Ref. No.	1250019
description		lamp glass L 110mm W 65mm thickness 5mm	

1			
Part No.	359698	Ref. No.	1250065
description		lamp socket L 100mm W 55mm socket E14 connection male faston 6.3mm	
spare parts for		359698	
	Part No.	358119	Ref. No. —
frame L 118mm W 72mm mounting distance 143mm for bulb socket			

spare parts for		359698	
	Part No.	358122	Ref. No. —
gasket L 112mm W 68mm silicone thickness 3mm for bulb socket			
	Part No.	358123	Ref. No. —
lamp glass L 112mm W 68mm			
	Part No.	359612	Ref. No. —
light bulb t.max. 300°C socket E14 25W 230V ø 25mm L 56mm lens L 30mm for oven lamp type Philips			
	Part No.	359714	Ref. No. 1250020
gasket for bulb socket			
	Part No.	359715	Ref. No. 1250019
lamp glass L 110mm W 65mm thickness 5mm			
	Part No.	359716	Ref. No. 1250018
frame for bulb socket			
accessories for		359698	
	Part No.	359612	Ref. No. —
light bulb t.max. 300°C socket E14 25W 230V ø 25mm L 56mm lens L 30mm for oven lamp type Philips			
	Part No.	359938	Ref. No. —
borosilicate glass L 115mm W 69mm			

lamps

light bulbs

1			
Part No.	359610	Ref. No.	1230009
description		light bulb t.max. 300°C socket E14 15W 230V ø 22mm L 47mm lens L 20mm for oven lamp type Philips	

1			
Part No.	357153	Ref. No.	1250021
description		light bulb t.max. 300°C socket E14 25W 230V ø 25mm L 55mm lens L 30mm for oven type	

halogen lamps

for socket G4 / G6.35 / G9

1			
Part No.	359599	Ref. No.	42200007
description		halogen lamp socket G4 12V 20W temp.-resist. 500°C	



sockets

G4 / G5,3 / G6,35



1

Part No.	359646	Ref. No.	42200008
description	lamp socket socket G4/G5.3/G6.35 24V ø 17mm H 15mm connection cable 130mm mounting distance 26mm for halogen lamp holder length 31mm cable length 130mm		

timers

programme timers

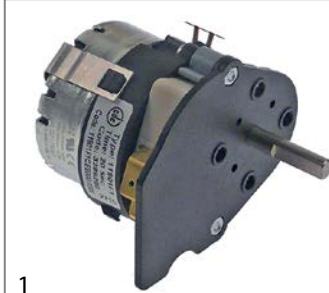

1

Part No.	360645	Ref. No.	92000036
description	timer CDC 11901F engines 1 chambers 1 operation time 20S 230V 50/60Hz shaft ø 6x4mm shaft L 25mm manuf. no. 11901F1CEE000.0000		

mechanical timers



1

Part No.	350008	Ref. No.	1250037
description	timer M2 with bell 2-pole operation time 120min impulse mechanical 2NO at 250V 16A permanent position yes shaft ø 6x4.6mm shaft 6x4.6mm shaft L 24mm mounting distance 28mm connection lateral		

alarm devices

buzzers



1

Part No.	350050	Ref. No.	1230015
description	buzzer 230VAC connection male faston 6.3mm screw mounting thread M4 60dB		

contactors

LOVATO

power contactors



1

Part No.	380704	Ref. No.	92000046
description	power contactor resistive load 20A 230VAC (AC3/400V) 9A/4kW main contacts 3NO auxiliary contacts 1NC connection screw connection type 11BG0901A230		



1

Part No.	380083	Ref. No.	16300011 92000044
description	power contactor resistive load 25A 230VAC (AC3/400V) 9A/4.2kW main contacts 3NO auxiliary contacts 1NC connection screw connection type BF0901A230		



1

Part No.	380717	Ref. No.	16500007
description	power contactor resistive load 32A 230VAC (AC3/400V) 18A/7.5kW main contacts 3NO auxiliary contacts 1NC connection screw connection type BF1801A230		

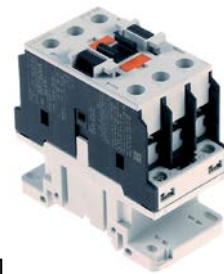

1

Part No.	380722	Ref. No.	92200003
description	power contactor resistive load 56A 230VAC (AC3/400V) 32A/16kW main contacts 3NO auxiliary contacts connection screw connection type BF3200A230		



SIEMENS

power contactors



1

Part No.	380645	Ref. No.	1260010
-----------------	--------	-----------------	---------

description	power contactor 230VAC with auxiliary contacts
--------------------	--



1

Part No.	380389	Ref. No.	1430006
-----------------	--------	-----------------	---------

description	power contactor resistive load 22A 230VAC (AC3/400V) 9A/4kW main contacts 3NO auxiliary contacts 1NO connection screw connection type 3RT10-16-1AP01
--------------------	--

overload switches



1

Part No.	381002	Ref. No.	1420005
-----------------	--------	-----------------	---------

description	overload switch setting range 1.8-2.5A
--------------------	--

TELEMECANIQUE (Schneider Electric)

power contactors



1

Part No.	380820	Ref. No.	1130014
-----------------	--------	-----------------	---------

description	power contactor resistive load 25A 230VAC (AC3/400V) 9A/4kW main contacts 3NO auxiliary contacts 1NO/1NC connection screw connection type LC1D0900M7
--------------------	--

relays

power relays

with male contacts

female contact 2.0mm



1

Part No.	380129	Ref. No.	41200002
-----------------	--------	-----------------	----------

description	power relays 24VAC 12A 2CO connection F2 plug-in connection 94.92.3 250V connection 2mm
--------------------	---

accessories for	380129
------------------------	--------

	Part No.	380341	Ref. No.	—
	description	relay socket 4-pole contacts 12 300V voltage AC 6A Italiana Relè manuf. no. ZMD4		

	Part No.	380378	Ref. No.	—
	description	relay socket 2-pole 55/85 dimensions 70.5x30x27mm 250V voltage AC 10A FINDER manuf. no. 94.72		

	Part No.	380384	Ref. No.	—
	description	relay socket 2-pole contacts male faston 2.8mm 250V voltage AC 10A W 23mm for		

	Part No.	380399	Ref. No.	—
	description	relay socket 4-pole dimensions 76.2x27x86.1mm 250V voltage AC 1A FINDER manuf. no. 94.94.3		



level relays

GICAR



1

Part No.	401224	Ref. No.	43700002
description	level relay 230V connection F6.3 type RL30/3ES/F/G		



1



Part No.	380640	Ref. No.	41100006	
description	time relay TECNOLOGIC RTR12DS60S time range 60s 230VAC 5A 1CO connection plug-in connection round 8-pole			
accessories for	380640			
	Part No.	380638	Ref. No.	—
	relay socket 8-pole dimensions 51x41x23mm 250V 10A FINDER manuf. no. 90.26			

time relays

time relays



1

Part No.	380329	Ref. No.	43000002	
description	time relay FIBER 85.02.8.240 time range 0.05s - 100h 230-240VAC 10A mounting measurements 20.6x27.7mm 2CO connection 2.0			
accessories for	380329			
	Part No.	380378	Ref. No.	—
	relay socket 2-pole 55/85 dimensions 70.5x30x27mm 250V voltage AC 10A FINDER manuf. no. 94.72			
	Part No.	380803	Ref. No.	—
	relay socket 2-pole dimensions 76.2x27x86.1mm 250V voltage AC 10A FINDER manuf. no. 94.92.3			



1

Part No.	380639	Ref. No.	41100005	
description	time relay TECNOLOGIC RTR12DS06S time range 6s 230VAC 5A mounting measurements 34x34mm 1CO connection plug-in connection round 8-pole			
accessories for	380639			
	Part No.	380638	Ref. No.	—
	relay socket 8-pole dimensions 51x41x23mm 250V 10A FINDER manuf. no. 90.26			

transformers

open transformers

with clamp terminal



1

Part No.	403905	Ref. No.	92000016
description	transformer primary 230V/50-60Hz secondary 12V 50VA connection screw connection type T1ULF		

with plug connection



1

Part No.	400956	Ref. No.	92000045
description	transformer primary 230VAC secondary 12VAC 20VA connection male faston 6.3mm 50/60Hz type T602012/E temperature restriction 150°C ambient temperature max. 80°C		



electronic controllers

EVCO - EVERY CONTROL

universal controllers

built-in version



1	Part No.	378131	Ref. No.	1230020
	description	electronic controller EVERY CONTROL EVK411M mounting measurements 71x29mm 12V voltage AC/DC NTC/PTC/Pt100/Pt1000 relay outputs 1 CO-16A(8) NTC/PTC/Pt100/Pt1000/TC(J,K)/mV/mA yes protection IP65 dependent on probe°C display 3½ digits		
	accessories for	378131		
	Part No.	379050	Ref. No.	—
	description	temperature probe Pt100 cable Vetrotex probe -200 up to +600°C cable -50 up to +350°C probe ø6x100mm cable length 2.7m without screw connection 3-wire		
	Part No.	379160	Ref. No.	—
	description	temperature probe NTC 10kOhm cable thermoplastic probe -40 up to +110°C cable -40 up to +110°C probe ø6x14mm cable length 1.5m without screw connection 2-wire		
	Part No.	379781	Ref. No.	—
	description	temperature probe PTC 1kOhm cable thermoplastic probe -50 up to +150°C cable -40 up to +110°C probe ø6x14mm cable length 1.5m without screw connection 2-wire		
	Part No.	379944	Ref. No.	—
	description	temperature probe Pt1000 cable Vetrotex probe -70 up to +500°C cable -50 up to +350°C connection 2-wire thread probe ø6x180mm cable length 1.7m		

probes

universal probes

temperature probes



1	Part No.	379052	Ref. No.	44300002
	description	temperature probe PTC 1kOhm cable silicone probe -50 up to +150°C cable -50 up to +180°C probe ø6x40mm cable length 1.5m without screw connection 2-wire		

producer-specific probes

probes



1	Part No.	402154	Ref. No.	1460011
	description	temperature probe Pt100 cable silicone probe -100 up to 450°C cable -50 up to +180°C connection 3-wire thread 1/8" probe ø6x35mm cable length 1.5m		



1	Part No.	379331	Ref. No.	92000004
	description	temperature probe Pt1000 cable PTFE probe -70 up to +500°C cable -40 up to +250°C connection 2-wire thread M10x1 probe ø3x60mm cable length 0.7m		

core probes



1	Part No.	379945	Ref. No.	4270004
	description	core temperature probe Pt100 cable PTFE probe -40 up to +250°C cable -40 up to +250°C connection plug probe ø3.5x100mm thread cable length 0.5m handle ø 10mm handle length 80mm		

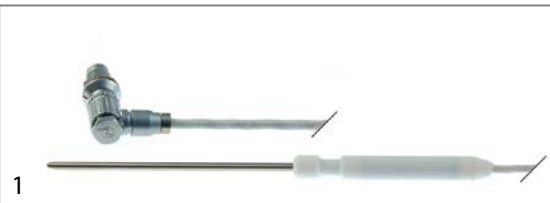

1	Part No.	379946	Ref. No.	011915 4270001
	description	core temperature probe Pt100 cable PTFE probe -40 up to +250°C cable -40 up to +250°C connection plug probe ø3.5x100mm thread cable length 0.7m handle ø 10mm handle length 80mm		

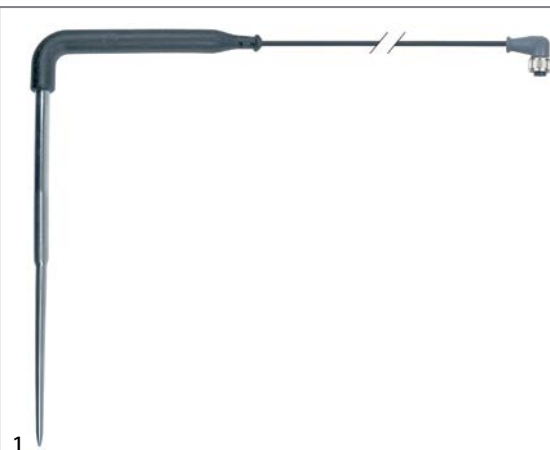

1	Part No.	379350 ¹	Ref. No.	44300003
	description	core temperature probe PTC 1kOhm cable silicone probe -40 up to +120°C cable -50 up to +180°C connection plug probe ø4x100mm thread cable length 1.7m handle ø 8mm handle length 120/35mm L1 120mm L2 130mm		

¹multipoint probe



1

Part No.	379662 ¹	Ref. No.	44200002
description	core temperature probe PTC 1kOhm cable silicone probe -40 up to +120°C cable -50 up to +180°C connection plug probe ø4x70mm thread cable length 1.3m handle ø 16mm handle length 120mm L1 120mm L2 130mm		

¹multipoint probe



1

Part No.	401566	Ref. No.	42200006
description	power PCB without EPROM type CQB 324(02)		
accessories for	401566		
	Part No.	403062	Ref. No. —
description	EPROM type FOCABO P5		
	Part No.	403201	Ref. No. —
description	EPROM type FOCABO 59		

electronics

PCBs



1

Part No.	401245	Ref. No.	1270005
description	keypad PCB		



1

Part No.	403473	Ref. No.	005883 49200017
description	PCB combi-steamer LCM06/M100 L 95mm W 79mm H 43mm Fan Reversal Card		



1

Part No.	404028	Ref. No.	92100004
description	PCB for combi-steamer ANGELO PO L 140mm W 100mm		

solenoïd valves

solenoïd valves (water)

ELBI

straight



1

Part No.	373017	Ref. No.	1230013
description	solenoid valve single straight 230VAC inlet 3/4" outlet 11.5mm DN10 ELBI		
spare parts for	373017		
	Part No.	370467	Ref. No. —
description	solenoid valve filter suitable for ELBI		

RPE

reducers

outlet side



1

Part No.	371269	Ref. No.	009006 1250022
description	reducer flow rate 0.07-0.14l/min brown		



1

Part No.	371266	Ref. No.	008887 1250009
description	reducer flow rate 0.2l/min red		



solenoid valves with reducers

4-fold



1			
Part No.	374026	Ref. No.	1450003
description	solenoid valve 4-fold straight 230VAC inlet 3/4" outlet 11.5mm duty cycle 100% RPE plastic pressure range 0.2-10bar		
spare parts for	374026		
	Part No.	371015	Ref. No. —
	solenoid coil RPE 230VAC 8.4VA 50/60Hz seat ø 9mm connection male faston 6.3mm		

TP

solenoid valves with reducers



1			
Part No.	370648	Ref. No.	92000030 92000031
description	solenoid valve double straight 220-240VAC inlet 3/4" input 10l/min DN10 TP outlet 11.5mm output A 3.4l/min flow regulating valve outlet A green		



1			
Part No.	370628	Ref. No.	1240007
description	solenoid valve double straight 230VAC inlet 3/4" input 16l/min DN10 TP plastic outlet 11.5mm		

ball valves electric



1			
Part No.	401233	Ref. No.	43000004
description	ball valve inlet 1/2" IT outlet 1/2" IT 230V 50/60Hz mode of operation electric W 60mm H 99mm cable 4-pole 2.5W 4-pole duty cycle 50%		

pressure switches

for combi-steamers



1			
Part No.	541806	Ref. No.	92000033
description	pressure control ø 38mm pressure range 0.2-3.0bar connection 1/8" 250V 10A GP600 pressure connection 1/8"		
accessories for	541806		
	Part No.	541814	Ref. No. —
	protection cap for pressure switch EPDM XP600		

electrodes



1			
Part No.	401161	Ref. No.	43000007
description	level electrode 1/4" total length 210mm probe L 184mm insulated probe length 26mm connection male faston 6.3mm stainless steel ø 2.5mm		



1			
Part No.	401225	Ref. No.	1250012
description	level electrode M12 ET - 1/8" ET total length 124/127/139mm probe L 91/95/104mm insulated probe length 42mm set 3-piece connection male faston 6.3mm ø 2.5mm		



1			
Part No.	401226	Ref. No.	1260005
description	level electrode M12x1 total length 150/160/171mm probe L 117/127/138mm insulated probe length 20mm set 3-piece connection male faston 6.3mm ø 2.5mm		



fans

axial fans

import



1			
Part No.	601080 ¹	Ref. No.	42300006
description	axial fan L 119mm W 119mm H 38mm 230VAC 50/60Hz 23/20W bearing ball bearing connection male faston 2.8mm metal ADDA fan wheel ø 110mm temp.-resist. 70°C		
accessories for	601080		
	Part No.	550898	Ref. No. —
	connecting cable cable length 2000mm connection F 2.8 connection distance 7.9mm for axial flow fan		
	Part No.	692519	Ref. No. —
	guard L 120mm W 120mm plastic		

¹with ball bearings



1			
Part No.	601130 ¹	Ref. No.	41100009
description	axial fan L 80mm W 80mm H 25mm 230VAC 50/60Hz 13/14W bearing ball bearing connection male faston 2.8mm metal ADDA fan wheel ø 75mm temp.-resist. 70°C airflow 30.6m ³ /h		
accessories for	601130		
	Part No.	550898	Ref. No. —
	connecting cable cable length 2000mm connection F 2.8 connection distance 7.9mm for axial flow fan		

¹with ball bearings

hot air motors



1			
Part No.	550757	Ref. No.	002080 43000044
description	counterflange for fan motor ED ø 48mm int. ø 1 24mm int. ø 2 15mm thickness 5mm brass		



1			
Part No.	550859	Ref. No.	002115 43000047
description	counterflange for fan motor ED ø 60mm int. ø 1 34mm int. ø 2 25mm thickness 6mm brass		





1			
Part No.	601046	Ref. No.	1240004
description	fan motor 220/380V 3 phase 50/60Hz 0.75kW 1350/1650rpm speeds 1 L1 185mm L2 42mm L3 47mm D1 ø 24mm D2 ø 20mm M12L IT 1.9/3.3A Cos(φ) 0.83 at 50Hz 200-240/346-415V at 60Hz 200-277/346-480V at 50Hz 1350rpm at 60Hz 1650rpm type ST80/4 no. 661512		

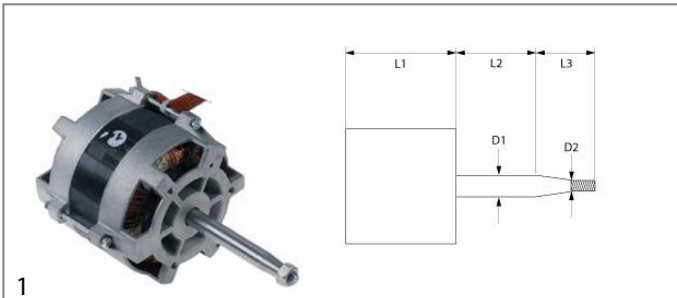

1			
Part No.	601043	Ref. No.	008939 1250015
description	fan motor 220-240V 1 phase 50Hz 0.37/0.07kW 0.1/0.5HP 1400/2700rpm speeds 2 L1 123mm L2 107mm L3 15mm D1 ø 15mm D2 ø 12mm M10L ET 2/0.7A suitable capacitor 20µF/250V at 50Hz 1400/2700rpm type 1057		
accessories for	601043		
	Part No.	365019	Ref. No. —
	operating capacitor capacity 20µF 400V tolerance 5% 50/60Hz ambient temperature max. -25 to +85°C ø 39.5mm L 70mm M8 plastic connection male faston 6.3mm 16.10.25. protection		

1

Part No.	601166	Ref. No.	44700005
description	fan motor 220-240V 1 phase 50Hz 0.37kW 2700rpm speeds 1 L1 123mm L2 77mm L3 30mm D1 ø 15mm D2 ø 12mm M10L ET 2A suitable capacitor 12.5µF/450V at 50Hz 2700rpm type 1057.2157		
spare parts for	601166		
	Part No.	Ref. No.	—
	365014		
description	operating capacitor capacity 12.5µF 450V tolerance 5%Hz ambient temperature max. -25 to +85°C ø 35mm L 70mm M8 plastic connection male faston 6.3mm 45S.C3DS.12.5 protection		
accessories for	601166		
	Part No.	Ref. No.	—
	601165		
description	fan wheel D1 ø 160mm H1 60mm blades 15 D2 ø 16mm D3 ø 16mm H2 29mm		



1

Part No.	602175	Ref. No.	92000040
description	fan motor 230/400V 3 phase 50/60Hz 0.7kW 1400/1700rpm L1 150mm L2 80mm L3 32mm D1 ø 18mm D2 ø 15mm M8 suitable capacitor 3µF400V type 3042P4050		

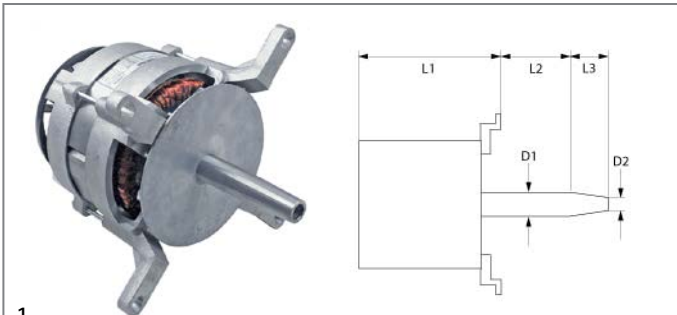

1

Part No.	499185	Ref. No.	009961 1260008
description	fan motor 380-415V 3 phase 50/60Hz 0.13/0.55kW 700/1350rpm speeds 2 L1 170mm L2 49mm L3 45mm D1 ø 24mm D2 ø 20mm M12x1.75 4P/8P type FB100L		

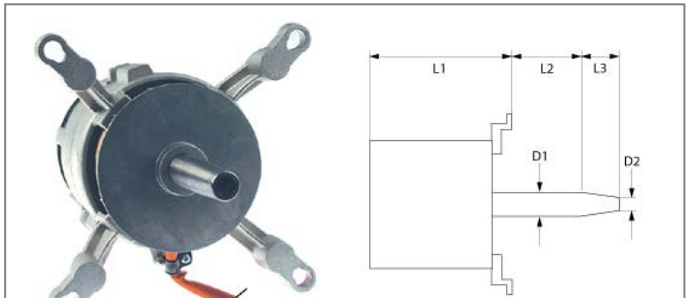

1

Part No.	500652	Ref. No.	009961 1260008
description	fan motor 380-415V 3 phase 50Hz 0.13/0.55kW 700/1350rpm speeds 2 L1 188mm L2 44mm L3 48mm D1 ø 24mm D2 ø 20mm M12L ITA Cos(φ) 0.13/0.55 at 50Hz 700/1350rpm 4P/8P type FB80 4/8 no. 390133		



1

Part No.	601067	Ref. No.	41100010
description	fan wheel D1 ø 150mm H1 38mm blades 36 D2 ø 6mm D3 ø 6mm H2 14mm		

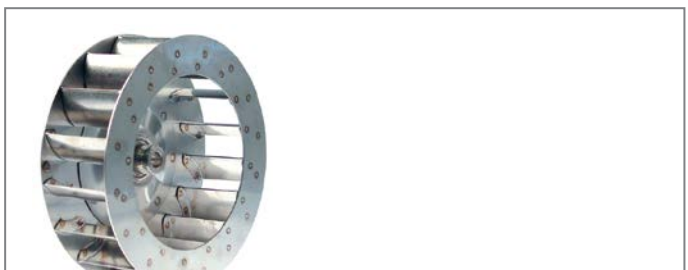

1

Part No.	601060	Ref. No.	1250014
description	fan wheel D1 ø 180mm H1 60mm blades 16 D2 ø 11mm D3 ø 16mm H2 30mm		



1

Part No.	601064	Ref. No.	44700002
description	fan wheel D1 ø 220mm H1 78mm blades 20 D2 ø 11.5mm D3 ø 16.5mm H2 30mm		





1

Part No.	601224	Ref. No.	1260007
description	fan wheel D1 ø 300mm H1 100mm blades 24 D2 ø 19.5mm D3 ø 23mm H2 46mm		



1

Part No.	601063	Ref. No.	1410004
description	fan wheel D1 ø 350mm H1 100mm blades 24 D2 ø 19.5mm D3 ø 23mm H2 46mm		



1

Part No.	691810	Ref. No.	002067 43000043
description	flange for fan motor ED ø 48mm int. ø 1 19.5mm int. ø 2 15mm thickness 3.5mm brass		



1

Part No.	550858	Ref. No.	002101 43000046
description	flange for fan motor ED ø 60mm int. ø 1 28.5mm int. ø 2 25mm thickness 4mm brass		



1

Part No.	550686	Ref. No.	90200030
description	gasket for fan motor ID ø 12mm ED ø 58mm thickness 1mm with 3 screw holes		



1

Part No.	511171	Ref. No.	43000042
description	shaft seal ID ø 14.5mm ED ø 20mm thickness 3mm		



1

Part No.	511172	Ref. No.	43000045
description	shaft sealing ID ø 24mm ED ø 29mm thickness 3mm		

hot air fans

miscellaneous



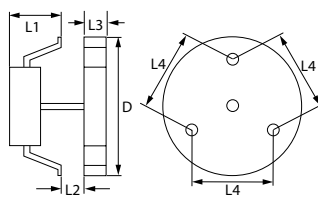

1

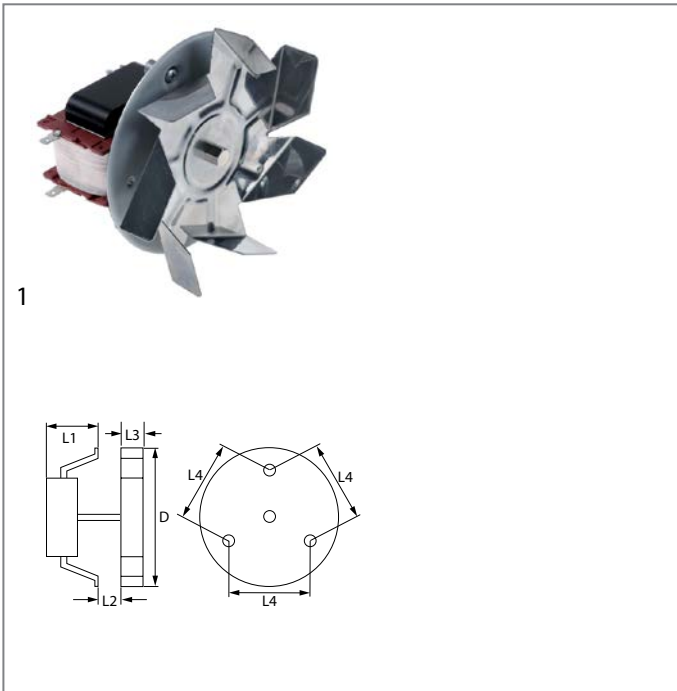

Part No.	601011	Ref. No.	1510006
description	hot air fan 220-240V 40W 50/60Hz L1 65mm L2 15mm L3 25mm L4 87mm fan wheel ø 150mm FIME type C25R8023CLH		
accessories for	601011		

Part No.	550879	Ref. No.	—
description	insulation ø 130mm thickness 3mm hole ø 20mm for hot air fan		
Part No.	601260	Ref. No.	—
description	nut thread M6L IT for hot air fan		



Part No.	601125	Ref. No.	1270016
description	hot air fan 220-240V 45W 50/60Hz L1 70mm L2 11mm L3 25mm L4 87mm fan wheel ø 150mm FIME type C30R0479CLF		
accessories for	601125		
	Part No.	550879	Ref. No. —
	insulation ø 130mm thickness 3mm hole ø 20mm for hot air fan		

pumps

drain pumps

ASKOLL



Part No.	500565	Ref. No.	1250030
description	drain pump 30W		

condensators & interference suppression filters

operating capacitors

plastic

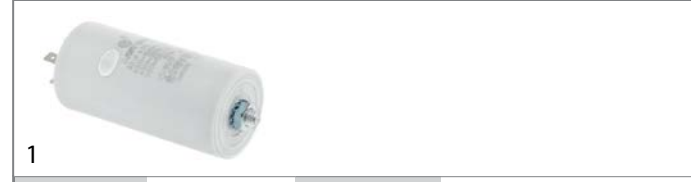

Part No.	365022	Ref. No.	90400011
description	operating capacitor capacity 40µF 400V tolerance 5%Hz ambient temperature max. -25 to +85°C ø 45mm L 95mm M8 plastic connection male faston 6.3mm protection		

electric accessories

cables

earthing cables



Part No.	104684	Ref. No.	90200015
description	earthing cable connection F2.8mm / lug M5 cable length 350mm 1.5mm ²		



Part No.	104527	Ref. No.	00128157 019715
description	earthing cable connection F2.8mm/lug M6 cable length 270mm Qty 1 ED ø 3mm		

miscellaneous

Part No.	403098	Ref. No.	003368 00400011
description	cable for piezoelectric igniter L 1250m connection female bullet ø2mm/lug M5		

Part No.	403097	Ref. No.	008022 08100027
description	cable L 500m connection female bullet ø2/4mm		

terminals

porcelain clamps

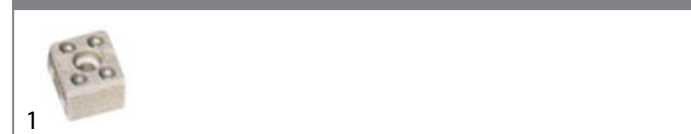

Part No.	550112	Ref. No.	32100015
description	porcelain terminal block 2-pole 2.5mm ² max. 10A max 250V t.max. 200°C L 22mm W 17mm H 15mm mounting distancemm Qty 1 pcs		



gas taps

COPRECI

CAL-3200



1

Part No.	109109	Ref. No.	00119075 006120
description	gas tap COPRECI type CAL-3200 gas inlet M18x1.5 (tube ø 12mm) bypass nozzle ø 0.75mm gas outlet M18x1.5 (tube ø 12mm) thermocouple connection M8x1 pilot connection 1/8" shaft ø 10x8mm shaft flat right shaft L 28/12mm		

CAL-5200



1

Part No.	107766	Ref. No.	006385 24609015
description	gas tap COPRECI type CAL-5200 gas inlet pipe flange ø21mm bypass nozzle ø 0.6mm gas outlet M16x1.25 (tube ø 6mm) thermocouple connection M8x1 pilot connection shaft ø 10x8mm shaft L 32/12mm		



1

Part No.	106294	Ref. No.	24609015 (old version)
description	gas tap COPRECI type CAL-5200 gas inlet pipe flange ø21mm bypass nozzle ø 0.6mm gas outlet M16x1.25 (tube ø 6mm) thermocouple connection M8x1 pilot connection shaft ø 8x6.5mm shaft L 32/12mm shaft flat right with pipe outlet		
spare parts for	106294		
	Part No.	101060	Ref. No. 24600044
	magnet unit standard L 39mm D1 ø 15.4mm D2 ø 11mm suitable for PEL20-21/JUNKERS/EGA		

GAI



1

Part No.	106566	Ref. No.	N/A
description	gas tap GAI gas inlet 1/2" (tube ø 13mm) bypass nozzle ø 0mm gas outlet 1/2" (tube ø 10mm) thermocouple connection M9x1 pilot connection M10x1 shaft ø 10x8mm shaft L 38/15mm shaft flat right		





gas thermostats

SIT

630 Eurosit series



1

Part No.	101188	Ref. No.	40900005
description	gas thermostat type 630 Eurosit series t.max. 190°C 110-190°C gas inlet 3/8" gas outlet 3/8" thermocouple connection M9x1 pilot connection M10x1 probe ø 4mm probe L 202mm capillary pipe 1050mm SIT		
accessories for	101188		
	Part No.	100904	Ref. No. —
	locking screw M10x1 for pipe ø 4mm Qty 1 pcs		
	Part No.	100905	Ref. No. 00131131 43000018
	locking screw M10x1 for pipe ø 6mm Qty 1 pcs		
	Part No.	101273	Ref. No. —
	olive for pipe ø 12mm L 9.5mm brass Qty 1 pcs suitable for universal		
	Part No.	101276	Ref. No. —
	union screw thread 3/8" tube ø 12mm Qty 1 pcs		
	Part No.	101333	Ref. No. —
	plug thread 3/8" with O-ring		



710 Minisit series

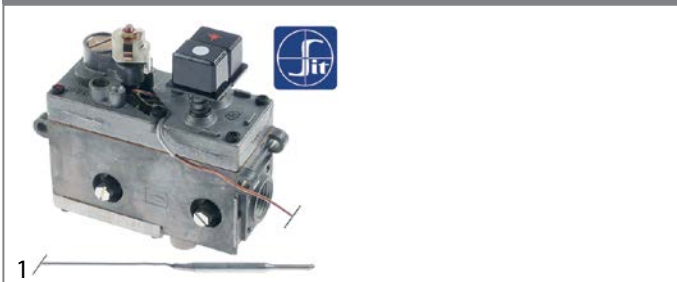

Part No.	101132	Ref. No.	00131000
-----------------	--------	-----------------	----------

description gas thermostat SIT type MINISIT 710 t.max. 340°C 100-340°C gas inlet 1/2" gas outlet 3/8" thermocouple connection M9x1 pilot connection M10x1 probe ø 5mm probe L 68mm capillary pipe 1050mm probe type type B1 pressure controller no pressure regulator mbar gland nut ignition gas no

spare parts for 101132

	Part No.	101053	Ref. No.	—
	magnet unit T1: M9x1 T2: M24x1 L 45mm ø 17mm suitable for Minisit			
	Part No.	102102	Ref. No.	—
	probe 100-340°C probe ø 5mm probe L 68mm capillary pipe 1750mm t.max. 340°C oven/grill probe type type B1 suitable for MINISIT 710			

accessories for 101132

	Part No.	100809	Ref. No.	—
	O-ring EPDM thickness 2mm ID ø 21mm Qty 1 pcs			
	Part No.	100904	Ref. No.	—
	locking screw M10x1 for pipe ø 4mm Qty 1 pcs			
	Part No.	100905	Ref. No.	00131131 43000018
	locking screw M10x1 for pipe ø 6mm Qty 1 pcs			
	Part No.	101054	Ref. No.	—
	magnet unit T1: M10x1 T2: M24x1 L 45mm ø 17mm suitable for Minisit			
	Part No.	101136	Ref. No.	—
	piezoelectric igniter suitable for Minisit with cover cap ømm connection F6.3x0.8			
	Part No.	101137	Ref. No.	—
	cover cap without piezoelectric igniter			
	Part No.	101267	Ref. No.	—
	reducer IT 3/8" ET 1/2" L 21mm			
	Part No.	101268	Ref. No.	—
	gas connection thread 3/8" angled with O-ring MINISIT 710			
	Part No.	101269	Ref. No.	—
	gas connection thread 1/2" angled with O-ring MINISIT 710			
	Part No.	101270	Ref. No.	—
	screw connection IT 3/8" ET 3/8" L 28mm			
	Part No.	101272	Ref. No.	—
	screw connection IT 1/2" ET 3/8" L 57mm			
	Part No.	101273	Ref. No.	—
	olive for pipe ø 12mm L 9.5mm brass Qty 1 pcs suitable for universal			

accessories for 101132

	Part No.	101274	Ref. No.	—
	olive for pipe ø 16mm Qty 1 pcs			
	Part No.	101275	Ref. No.	—
	union screw thread 1/2" for pipe ø 16mm Qty 1 pcs			
	Part No.	101276	Ref. No.	—
	union screw thread 3/8" tube ø 12mm Qty 1 pcs			
	Part No.	110068	Ref. No.	—
	knob suitable for Minisit ø 37mm			

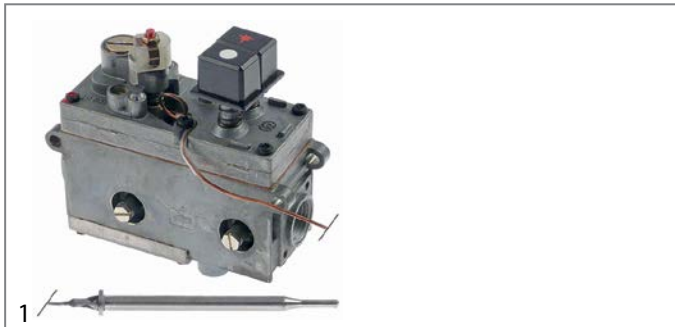

Part No.	101434	Ref. No.	9400008
-----------------	--------	-----------------	---------

description gas thermostat without accessories SIT type MINISIT 710 t.max. 190°C 110-190°C gas inlet 1/2" gas outlet 3/8" thermocouple connection M9x1 pilot connection M10x1 probe ø 5mm probe L 102mm capillary pipe 1200mm probe type type G1 pressure controller no pressure regulator mbar gland nut

spare parts for 101434

	Part No.	101053	Ref. No.	—
	magnet unit T1: M9x1 T2: M24x1 L 45mm ø 17mm suitable for Minisit			
	Part No.	102105	Ref. No.	—
	probe 110-200°C probe ø 6mm probe L 102mm capillary pipe 1050mm t.max. 200°C fryer probe type type G1 suitable for MINISIT 710			

accessories for 101434

	Part No.	100809	Ref. No.	—
	O-ring EPDM thickness 2mm ID ø 21mm Qty 1 pcs			
	Part No.	100904	Ref. No.	—
	locking screw M10x1 for pipe ø 4mm Qty 1 pcs			
	Part No.	100905	Ref. No.	00131131 43000018
	locking screw M10x1 for pipe ø 6mm Qty 1 pcs			
	Part No.	101054	Ref. No.	—
	magnet unit T1: M10x1 T2: M24x1 L 45mm ø 17mm suitable for Minisit			
	Part No.	101136	Ref. No.	—
	piezoelectric igniter suitable for Minisit with cover cap ømm connection F6.3x0.8			
	Part No.	101137	Ref. No.	—
	cover cap without piezoelectric igniter			
	Part No.	101267	Ref. No.	—
	reducer IT 3/8" ET 1/2" L 21mm			

Table continues overleaf



accessories for		101434	
Part No.	101268	Ref. No.	—
	gas connection	thread 3/8" angled with O-ring	MINISIT 710
Part No.	101269	Ref. No.	—
	gas connection	thread 1/2" angled with O-ring	MINISIT 710
Part No.	101270	Ref. No.	—
	screw connection	IT 3/8" ET 3/8" L 28mm	
Part No.	101272	Ref. No.	—
	screw connection	IT 1/2" ET 3/8" L 57mm	
Part No.	101273	Ref. No.	—
	olive	for pipe ø 12mm L 9.5mm brass Qty 1 pcs	suitable for universal
Part No.	101274	Ref. No.	—
	olive	for pipe ø 16mm Qty 1 pcs	
Part No.	101275	Ref. No.	—
	union screw	thread 1/2" for pipe ø 16mm Qty 1 pcs	
Part No.	101276	Ref. No.	—
	union screw	thread 3/8" tube ø 12mm Qty 1 pcs	
Part No.	110068	Ref. No.	—
	knob	suitable for Minisit ø 37mm	

accessories

probes

	1		
Part No.	102101	Ref. No.	00100144
description	probe 100-340°C probe ø 5mm probe L 70mm capillary pipe 1000mm t.max. 340°C suitable for MINISIT 710		

gas valves and ignition boxes







gas control valves

SIT

NOVASIT



1

Part No.	101187	Ref. No.	64100011	
description	gas valve SIT series Novasit 820 0.17VHz gas inlet 1/2" gas outlet 1/2" thermocouple connection M9x1 pilot connection M10x1 ignition pressurebar pressure range 5-50mbar pressure regulator connection blind equiv. no. 0.820.301 supply Operator millivolt			
spare parts for	101187			
	Part No.	101065	Ref. No.	—
	magnet unit with cable L 44mm D1 ø 30mm D2 ø 20mm suitable for NOVASIT			
accessories for	101187			
	Part No.	100110	Ref. No.	—
	pilot burner SIT type 190 series 3 flames nozzle ømm gas connectionmm			
	Part No.	101305	Ref. No.	—
	gas connection straight 1/2" flange 45x45mm ELETTROSIT/V4400/4600/4605 suitable for SIT/HONEYWELL hole distance 36x36mm			
	Part No.	101306	Ref. No.	—
	gas connection angled flange 45x45mm hole distance 36x36mm 1/2" ELETTROSIT/V4400/4600/4605 screw with O-ring suitable for SIT/HONEYWELL			
	Part No.	101307	Ref. No.	—
	gas connection straight flange 45x45mm hole distance 36x36mm 3/4" ELETTROSIT/V4400/4600/4605 screw with O-ring suitable for SIT/HONEYWELL			
	Part No.	101308	Ref. No.	—
	gas connection angled flange 45x45mm hole distance 36x36mm 3/4" ELETTROSIT/V4400/4600/4605 screw with O-ring suitable for SIT/HONEYWELL			
	Part No.	102116	Ref. No.	64100008
	thermopile ROBERTSHAW L 900mm probe ø 9mm probe L 57mm 250-750mV screw connection 7/16"			

accessories



1

Part No.	100905	Ref. No.	00131131 43000018
description	locking screw M10x1 for pipe ø 6mm Qty 1 pcs		



SIGMA



1

Part No.	107894	Ref. No.	92100003
description	gas valve type 0848083 230V 50Hz gas inlet 3/4" gas outlet 3/4" pressure range 0.5-12mbar incl reducer 1/2" - 3/4"		



1

Part No.	107498	Ref. No.	43000009
description	gas valve type Sigma 230V 50Hz gas inlet 1/2" gas outlet 1/2" pressure range 2-50mbar		
spare parts for	107498		
	Part No.	106214	Ref. No. 90200020
	solenoid coil 230V 50Hz Sigma		
accessories for	107498		
	Part No.	107222	Ref. No. —
	plug for solenoid valve 3-pole cable length 1070mm		

ignition boxes

HONEYWELL



1

Part No.	101165	Ref. No.	1440006
description	ignition box HONEYWELL type S4560A 1008 equiv. no. S4560A 1008 electrodes 1 waiting time 0s safety time 10s 220-240V 10VA 50Hz		
spare parts for	101165		
	Part No.	358696	Ref. No. —
	fine fuse size ø5x20mm 4A medium lag rated 250V Qty 10 pcs		

Honeywell



1

Part No.	102367	Ref. No.	43000031
description	ignition box HONEYWELL type S4565A 2092 1 electrodes 3 waiting times safety time 10s 220-240V 4VA 50/60Hz		

SIT



1

Part No.	102309	Ref. No.	43000008
description	ignition box SIT type 537ABC electrodes 3 waiting time 1.5s safety time 10s 230V 10VA 50-60Hz protection IP44		

ignition parts
pilot burners

SIT

100 series



1

















Part No.	106906	Ref. No.	00106039
description	pilot burner SIT type 100 series 3 flames nozzle ø 0.2mm gas connection 6mm		
spare parts for	106906		
	Part No.	100245	Ref. No. —
	pilot burner nozzle LPG code 20 bore ø 0.2mm Qty 1 pcs thread M8x0.75		
	Part No.	100855	Ref. No. —
	pilot burner bracket triple		
	Part No.	100885	Ref. No. —
	air mixing sleeve for pilot burner Qty 1 pcs		
	Part No.	100916	Ref. No. —
	compression spring for pilot burner Qty 1 pcs		
	Part No.	100917	Ref. No. —
	gasket for pilot burner Qty 1 pcs aluminium		

Table continues overleaf



spare parts for		106906	
	Part No.	100918	Ref. No. —
	screw for pilot burner		
	Part No.	107162	Ref. No. —
	pilot burner cap SIT 3 flames Hmm Lmm Qty 1 pcs		
	Part No.	107701	Ref. No. —
	pilot burner bottom part SIT 100 series nozzle \varnothing 0.2mm		
accessories for		106906	
	Part No.	100245	Ref. No. —
	pilot burner nozzle LPG code 20 bore \varnothing 0.2mm Qty 1 pcs thread M8x0.75		
	Part No.	100246	Ref. No. —
	pilot burner nozzle natural gas bore \varnothing 0.35mm Qty 1 pcs thread M8x0.75		
	Part No.	100904	Ref. No. —
	locking screw M10x1 for pipe \varnothing 4mm Qty 1 pcs		
	Part No.	100905	Ref. No. 00131131 43000018
	locking screw M10x1 for pipe \varnothing 6mm Qty 1 pcs		
	Part No.	102110	Ref. No. —
	pilot tube copper pipe \varnothing 4mm thickness 1mm L 3000mm		
	Part No.	102111	Ref. No. —
	pilot tube copper pipe \varnothing 6mm thickness 1mm L 3000mm		
	Part No.	107171	Ref. No. —
	pilot burner nozzle SIT natural/liquid gas bore \varnothing 0.25mm Qty 1 pcs		
	Part No.	107700	Ref. No. —
	pilot burner bottom part SIT 100 series nozzle \varnothing 0.25mm		
	Part No.	107702	Ref. No. —
	pilot burner bottom part SIT 100 series nozzle \varnothing 0.35mm		

accessories

ignition electrodes

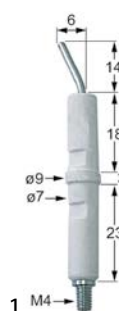

Part No.	100706	Ref. No.	40100008
description	ignition electrode connection M4 Qty 1 pcs		

160 series





Part No.	100055	Ref. No.	00150219
description	pilot burner SIT type 160 series 2 flames nozzle \varnothing 0.41mm gas connection 6mm		
spare parts for		100055	
	Part No.	100907	Ref. No. —
	screw connection thread M10x1 Qty 1 pcs type SEF 1 \varnothing mm for thermocouple		
accessories for		100055	
	Part No.	100202	Ref. No. —
	pilot burner nozzle natural gas code 41 Qty 1 pcs nozzle \varnothing 0.41mm		
	Part No.	100203	Ref. No. 00150220
	pilot burner nozzle LPG code 25 Qty 1 pcs nozzle \varnothing 0.25mm		
	Part No.	100701	Ref. No. 00142187
	ignition electrode connection M4 Qty 1 pcs		
	Part No.	100869	Ref. No. 00142186
	pilot burner nozzle natural gas code 51 Qty 1 pcs suitable for 160 series nozzle \varnothing 0.51mm		
	Part No.	100906	Ref. No. —
	screw connection thread M10x1 for ignition electrode brass Qty 1 pcs WS 10		
	Part No.	100908	Ref. No. —
	union screw thread M10x1 for pipe \varnothing 4mm Qty 1 pcs		
	Part No.	100909	Ref. No. —
	union screw thread M10x1 for pipe \varnothing 6mm Qty 1 pcs		
	Part No.	101282	Ref. No. —
	olive for pipe \varnothing 4mm L 7.4mm Qty 1 pcs		
	Part No.	101287	Ref. No. 00142188
	olive for pipe \varnothing 6mm Qty 1 pcs		
	Part No.	102110	Ref. No. —
	pilot tube copper pipe \varnothing 4mm thickness 1mm L 3000mm		
	Part No.	102111	Ref. No. —
	pilot tube copper pipe \varnothing 6mm thickness 1mm L 3000mm		
	Part No.	107650	Ref. No. —
	pilot burner nozzle SIT LPG code 30 Qty 1 pcs		



			
1			
Part No.	100056	Ref. No.	00142184
description	pilot burner SIT type 160 series 3 flames nozzle ømm gas connectionmm		
spare parts for	100056		
	Part No.	100907	Ref. No. —
	screw connection thread M10x1 Qty 1 pcs type SEF 1 ømm for thermocouple		
accessories for	100056		
	Part No.	100202	Ref. No. —
	pilot burner nozzle natural gas code 41 Qty 1 pcs nozzle ø 0.41mm		
	Part No.	100203	Ref. No. 00150220
	pilot burner nozzle LPG code 25 Qty 1 pcs nozzle ø 0.25mm		
	Part No.	100701	Ref. No. 00142187
	ignition electrode connection M4 Qty 1 pcs		
	Part No.	100801	Ref. No. —
	gasket for pilot burner Qty 1 pcs		
	Part No.	100869	Ref. No. 00142186
	pilot burner nozzle natural gas code 51 Qty 1 pcs suitable for 160 series nozzle ø 0.51mm		
	Part No.	100870	Ref. No. —
	olive for pipe ø 4mm Qty 1 pcs suitable for 160 series for pilot burner		
	Part No.	100906	Ref. No. —
	screw connection thread M10x1 for ignition electrode brass Qty 1 pcs WS 10		
	Part No.	100908	Ref. No. —
	union screw thread M10x1 for pipe ø 4mm Qty 1 pcs		
	Part No.	100909	Ref. No. —
	union screw thread M10x1 for pipe ø 6mm Qty 1 pcs		
	Part No.	101287	Ref. No. 00142188
	olive for pipe ø 6mm Qty 1 pcs		
	Part No.	102110	Ref. No. —
	pilot tube copper pipe ø 4mm thickness 1mm L 3000mm		
	Part No.	102111	Ref. No. —
	pilot tube copper pipe ø 6mm thickness 1mm L 3000mm		
	Part No.	107650	Ref. No. —
	pilot burner nozzle SIT LPG code 30 Qty 1 pcs		

190 series			
			
1			
Part No.	106722	Ref. No.	64100007
description	pilot burner SIT type 190 series 3 flames natural/liquid gas nozzle 35/51 nozzle ø 0.35/0.51mm gas connection 6mm complete with nozzle		

POLIDORO			
pilot burners			
			
1			
Part No.	104485	Ref. No.	40900004
description	pilot burner POLIDORO 2 flames natural gas code 29.2 gas connection 6mm		

producer-specific pilot burners			
REPAGAS			
			
1			
Part No.	104524	Ref. No.	002676 24204028
description	pilot burner KROMSCHRÖDER 1 natural/liquid gas nozzle ø 0.18/0.22mm		







			
1			
Part No.	107189	Ref. No.	50116000
description	pilot burner SIT 1 flame nozzle ø 0.2mm gas connectionmm		
spare parts for	107189		
	Part No.	100245	Ref. No. —
	pilot burner nozzle LPG code 20 bore ø 0.2mm Qty 1 pcs thread M8x0.75		

Table continues overleaf





spare parts for		107189	
Part No.	100832	Ref. No.	—
	pilot burner cap 1 flame suitable for 100 series Hmm Lmm Qty 1 pcs		
Part No.	100854	Ref. No.	—
	pilot burner bracket double		
Part No.	100885	Ref. No.	—
	air mixing sleeve for pilot burner Qty 1 pcs		
Part No.	100916	Ref. No.	—
	compression spring for pilot burner Qty 1 pcs		
Part No.	100917	Ref. No.	—
	gasket for pilot burner Qty 1 pcs aluminium		
Part No.	100918	Ref. No.	—
	screw for pilot burner		
Part No.	107701	Ref. No.	—
	pilot burner bottom part SIT 100 series nozzle ϕ 0.2mm		

miscellaneous

	1		
Part No.	106966	Ref. No.	40200022
description pilot burner 2 flames natural/liquid gas nozzle ϕ 0.45mm gas connection 6mm			
spare parts for		106966	
Part No.	100855	Ref. No.	—
	pilot burner bracket triple		
Part No.	100885	Ref. No.	—
	air mixing sleeve for pilot burner Qty 1 pcs		
Part No.	102742	Ref. No.	—
	pilot burner nozzle LPG code 25 bore ϕ 0.25mm Qty 1 pcs		
Part No.	102973	Ref. No.	—
	pilot burner nozzle natural gas bore ϕ 0.45mm Qty 1 pcs		

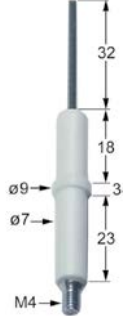
electrodes

	1		
Part No.	100701	Ref. No.	00142187
description ignition electrode connection M4 Qty 1 pcs			
accessories for		100701	
Part No.	100906	Ref. No.	—
	screw connection thread M10x1 for ignition electrode brass Qty 1 pcs WS 10		

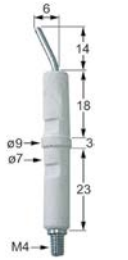
	1		
Part No.	100706	Ref. No.	40100008
description ignition electrode connection M4 Qty 1 pcs			

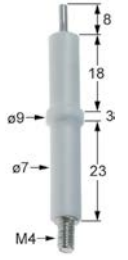
	1		
Part No.	102871	Ref. No.	64100005
description ignition electrode D1 ϕ 7mm D2 ϕ 9mm connection M4 L1 8mm BL1 18mm BL2 3mm BL3 23mm to clip			

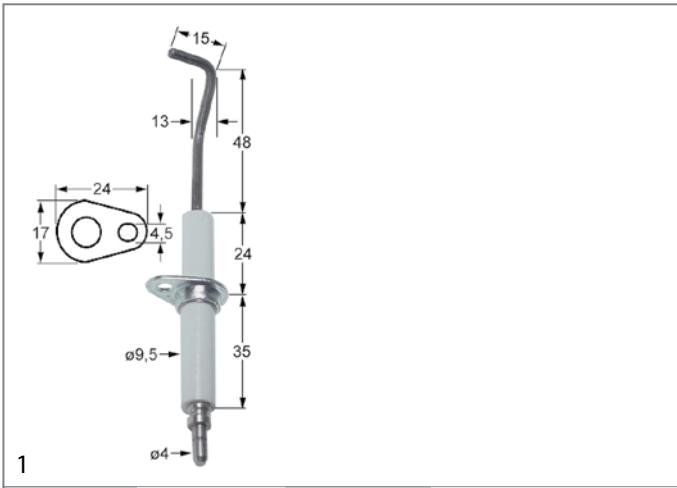

Part No.	102342	Ref. No.	43000026
description	ignition electrode flange length 24mm flange width 17mm D1 ø 9.5mm L1 48mm L2 13mm L3 15mm BL1 24mm BL2 35mm fixing dimensions ø4.5mm with flange connection ø 4mm		



Part No.	104799	Ref. No.	92900003
description	ignition electrode flange length 56mm flange width 22mm D1 ø 9x62mm D2 ø 9x62mm L1 130mm L2 140mm		



Part No.	103287	Ref. No.	92100002
description	ignition electrode kit flange length 56mm flange width 22mm D1 ø 3mm D2 ø 9.5mm mounting distance 47mm		

ignition cables

pre-assembled cables



Part No.	102180	Ref. No.	00106042
description	ignition cable cable length 1200mm connection ø2.4mm / ø2.4mm		



Part No.	102187	Ref. No.	90200014
description	ignition cable cable length 300mm connection ø4mm / F2.8mm		



Part No.	102162	Ref. No.	91100002
description	ignition cable cable length 400mm connection F2.8mm / F6.3mm		



Part No.	100025	Ref. No.	40100009
description	ignition cable cable length 600mm connection ø4mm / F6.3mm		

piezoelectric igniters

mounting diameter 22mm



Part No.	100013	Ref. No.	00128101
description	piezoelectric igniter body plastic blowing mounting ø 22mm connection ø2.4mm cable lengthmm		

accessories for	100013			
	Part No.	100023	Ref. No.	—
	female bullet size 2.3mm 0.5-1.5mm ² CuZn t.max. 125°C Qty 20 pcs			

ignition units



Part No.	103334	Ref. No.	90200013
description	ignition unit outputs 2 220-240VAC dimensions 83x42x32mm mounting distance 34mm inlet F2.8 outlet F2.8 type TSM 17VA 50/60Hz		



1			
Part No.	101002	Ref. No.	1430008
description	ignition unit outputs 2 230VAC dimensions 88x23x34mm mounting distance 73mm inlet F6.3x0.8 outlet F2.8x0.8 0.6VA 50/60Hz		

thermocouples

plug-in thermocouples

plug-in thermocouples standard

with barrel socket $\varnothing 6(6.5)$ mm

thermocouples SIT

1			
Part No.	107615	Ref. No.	24204026
description	thermocouple SIT M10x1 L 320mm plug connection $\varnothing 6.0(6.5)$ mm		

1			
Part No.	107600	Ref. No.	00100095
description	thermocouple SIT M8x1 L 320mm plug connection $\varnothing 6.0(6.5)$ mm		

1			
Part No.	107178	Ref. No.	00100079
description	thermocouple SIT M8x1 L 750mm plug connection $\varnothing 6.0(6.5)$ mm		

1			
Part No.	107612	Ref. No.	00106040
description	thermocouple SIT M9x1 L 1000mm plug connection $\varnothing 6.0(6.5)$ mm		

1			
Part No.	107613	Ref. No.	25100058
description	thermocouple SIT M9x1 L 1200mm plug connection $\varnothing 6.0(6.5)$ mm		

thermocouples with aluminised tip

1			
Part No.	102037	Ref. No.	50100032
description	thermocouple M8x1 L 1200mm plug connection $\varnothing 6.0(6.5)$ mm		

1			
Part No.	102038	Ref. No.	51600020
description	thermocouple M8x1 L 1500mm plug connection $\varnothing 6.0(6.5)$ mm		

plug-in thermocouples with interruption

1			
Part No.	107177	Ref. No.	9400051
description	thermocouple SIT with interrupter M9x1 L 600mm plug connection $\varnothing 6.0$ mm F 6.3mm		

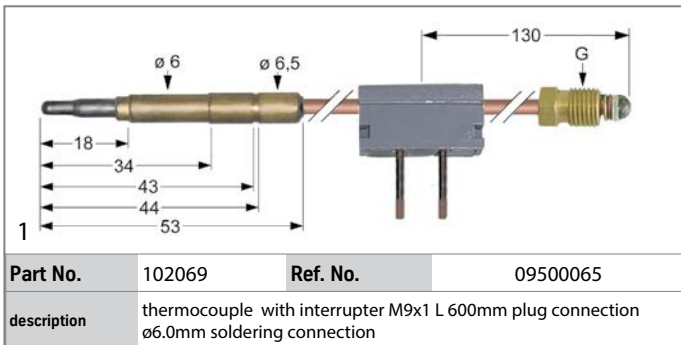

Part No.	102069	Ref. No.	09500065
description	thermocouple with interrupter M9x1 L 600mm plug connection ø6.0mm soldering connection		

threaded thermocouples

threaded thermocouples standard

with socket with thread M8x1

type Junkers with aluminised tip

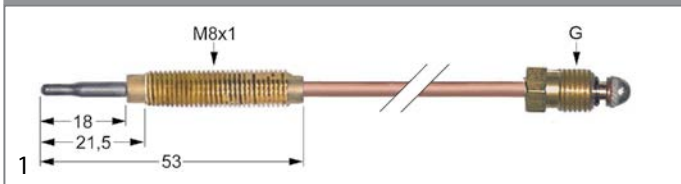

Part No.	102058	Ref. No.	04700019
description	thermocouple M8x1 L 1000mm M8x1		
accessories for	102058		
	Part No.	102067	Ref. No.
			—
	nut thread M8x1 H 3mm brass Qty 1 pcs type SEF 1		

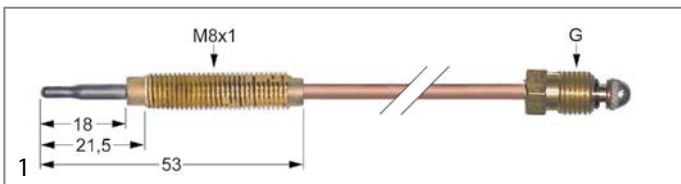

Part No.	102057	Ref. No.	04700018
description	thermocouple M8x1 L 850mm M8x1		
accessories for	102057		
	Part No.	102067	Ref. No.
			—
	nut thread M8x1 H 3mm brass Qty 1 pcs type SEF 1		

thermopiles

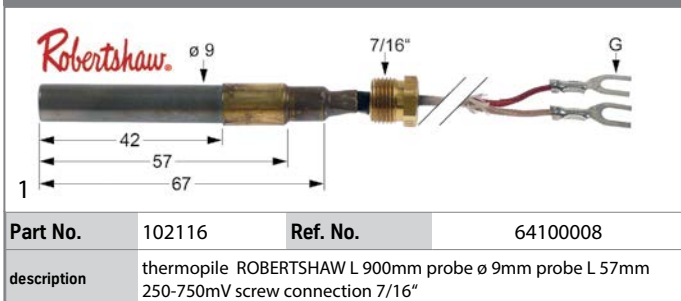

Part No.	102116	Ref. No.	64100008
description	thermopile ROBERTSHAW L 900mm probe ø 9mm probe L 57mm 250-750mV screw connection 7/16"		

gas burners

hob burners

producer-specific hob burners

REPAGAS

until 2005



Part No.	104497	Ref. No.	00100107
description	burner cap ø 110mm		



Part No.	104495	Ref. No.	00100172
description	burner cap ø 115mm		



Part No.	104498	Ref. No.	001382 50132064
description	burner cap ø 115mm		



Part No.	104496	Ref. No.	005648 02100030
description	burner cap ø 95mm		





Part No.	104488	Ref. No.	00100171 00100171+0670018+1083-P 013119+016550
description	burner head ø 115mm for burner cap ø 105mm		
accessories for	104488		

	Part No.	104655	Ref. No.
			017956 06700018
	air mixing tube L 74mm ED ø 22mm ID ø 20mm		

	Part No.	560555	Ref. No.
			1083-P
	hexagonal screw thread M6 thread L 15mm SS WS 10 Qty 1 pcs DIN 933 / ISO 4017		



 <p>1</p>			
Part No.	104514	Ref. No.	010720 31300021
description	burner holder ø 37mm seat ø 22mm		

 <p>1</p>			
Part No.	104509	Ref. No.	00121077 001694
description	burner holder ø 44mm seat ø 34mm thread M18x1.5		

since 2005

 <p>1</p>			
Part No.	104493	Ref. No.	015430 50141088
description	burner cap ø 120mm		

 <p>1</p>			
Part No.	104494	Ref. No.	002910 50142090
description	burner cap ø 140mm		

 <p>1</p>			
Part No.	104492	Ref. No.	007139 50140086
description	burner cap ø 95mm		

pan supports



 <p>1</p>			
Part No.	210040	Ref. No.	00100110 012605
description	pan support W 365mm L 395mm H 65mm		

<p>reducers for pan supports</p>  <p>1</p>			
Part No.	104499	Ref. No.	00100132 012790
description	reducer for pan support L 175mm W 114mm		

accessories

<p>reducers for pan supports</p>  <p>1</p>			
Part No.	104499	Ref. No.	00100132 012790
description	reducer for pan support L 175mm W 114mm		

air mixers

 <p>1</p>			
Part No.	104655	Ref. No.	017956 06700018
description	air mixing tube L 74mm ED ø 22mm ID ø 20mm		
accessories for	104655		
	Part No.	104488	Ref. No. 00100171
	burner head ø 115mm for burner cap ø 105mm		

bar burners

<p>bar burners</p>  <p>1</p>			
Part No.	105788	Ref. No.	1440002
description	bar burner 1-row ø 50mm Wmm Hmm L 483mm flange width 71mm convection oven flange ø 75mm		

 <p>1</p>			
Part No.	104483	Ref. No.	40900007
description	bar burner ø 40mm Wmm Hmm L 340mm flange width 50mm flange length 62mm fryer		

1 gas components



			
1			
Part No.	105787	Ref. No.	1430003
description	bar burner ø 40mm Wmm Hmm L 415mm flange width 43mm flange length 43mm convection oven		

			
1			
Part No.	105790	Ref. No.	008017 1430002
description	bar burner ø 50mm Wmm Hmm L 325mm flange width 57mm flange length 57mm convection oven		

			
1			
Part No.	105789	Ref. No.	1450001
description	bar burner ø 50mm Wmm Hmm L 618mm flange width 71mm convection oven flange ø 75mm		

gas nozzles

main nozzles

gas nozzles M8x1

			
1			
Part No.	104737	Ref. No.	90200025
description	gas injector thread M8x1 WS 10 bore ø 0.5mm		

gas nozzles M9x1

			
1			
Part No.	100501	Ref. No.	04704017
description	gas injector thread M9x1 WS 10 bore ø 0.95mm		

			
1			
Part No.	107345	Ref. No.	30100013
description	gas injector thread M9x1 WS 10 bore ø 0.9mm		

			
1			
Part No.	100504	Ref. No.	00120151
description	gas injector thread M9x1 WS 10 bore ø 1.15mm		

			
1			
Part No.	100503	Ref. No.	20111020
description	gas injector thread M9x1 WS 10 bore ø 1.1mm		

			
1			
Part No.	100505	Ref. No.	02107015
description	gas injector thread M9x1 WS 10 bore ø 1.2mm		

			
1			
Part No.	100507	Ref. No.	30100039
description	gas injector thread M9x1 WS 10 bore ø 1.35mm		

			
1			
Part No.	100956	Ref. No.	00112037
description	gas injector thread M9x1 WS 10 bore ø 1.3mm		

			
1			
Part No.	107346	Ref. No.	07600009
description	gas injector thread M9x1 WS 10 bore ø 1.4mm		





			
1			
Part No.	100509	Ref. No.	09511127
description	gas injector thread M9x1 WS 10 bore ø 1.55mm		

			
1			
Part No.	100510	Ref. No.	00100139
description	gas injector thread M9x1 WS 10 bore ø 1.8mm		

			
1			
Part No.	100511	Ref. No.	50100013
description	gas injector thread M9x1 WS 10 bore ø 1.9mm		

			
1			
Part No.	100502	Ref. No.	21107011
description	gas injector thread M9x1 WS 10 bore ø 1mm		

			
1			
Part No.	106881	Ref. No.	07600010
description	gas injector thread M9x1 WS 10 bore ø 2.1mm		

			
1			
Part No.	107347	Ref. No.	50100069
description	gas injector thread M9x1 WS 10 bore ø 2.4mm		

gas nozzles M10x1			
			
1			
Part No.	107343	Ref. No.	40200025
description	gas injector thread M10x1 WS 12 bore ø 1.2mm LPG gas pressure 30mbar		

			
1			
Part No.	106290	Ref. No.	40200015 40200018
description	gas injector thread M10x1 WS 12 bore ø 1.85mm inner peaked		

gas nozzles M13x1			
			
1			
Part No.	103270	Ref. No.	012419 40100029
description	gas injector thread M13x1 bore ø 2.4mm WS 13		

pilot burner nozzles

pilot burner nozzle AB			
			
1			
Part No.	100203	Ref. No.	00150220
description	pilot burner nozzle LPG code 25 Qty 1 pcs nozzle ø 0.25mm		

			
1			
Part No.	100869	Ref. No.	00142186
description	pilot burner nozzle natural gas code 51 Qty 1 pcs suitable for 160 series nozzle ø 0.51mm		

			
1			
Part No.	100201	Ref. No.	00142185
description	pilot burner nozzle PRO-GAS LPG code 30 Qty 1 pcs nozzle ø 0.3mm		

pilot burner nozzles POLIDORO			
			
1			
Part No.	100000	Ref. No.	40900003
description	pilot burner nozzle POLIDORO LPG code 22 bore ø 0.22mm Qty 1 pcs		



			
1			
Part No.	104486	Ref. No.	40900006
description	pilot burner nozzle POLIDORO natural gas code 29.2 bore ø 2x0.29mm Qty 1 pcs		

auxiliary gas parts

screw connections

olives

			
1			
Part No.	104526	Ref. No.	00100152 012941
description	olive L 6mm Qty 1 pcs ID ø 4.4/6mm ED ø 8mm		

union screws

			
1			
Part No.	100905	Ref. No.	00131131 43000018
description	locking screw M10x1 for pipe ø 6mm Qty 1 pcs		

			
1			
Part No.	104487	Ref. No.	00100153 012949
description	union screw thread 1/8" for pipe ø 6mm L 13mm brass Qty 1 pcs WS 11		

			
1			
Part No.	104491	Ref. No.	00131225 004497
description	union screw thread M10x1 for pipe ø 6mm L 16mm Qty 1 pcs WS 11		

angle pieces

			
1			
Part No.	104484	Ref. No.	40600008
description	angle piece T1: 1/2" ET T2: 1/2" ET		

			
1			
Part No.	104490	Ref. No.	008322 27306000
description	angle piece T1: 1/2" IT T2: 1/2" ET grommet ø 13.5mm grommet length 22mm WS 24 brass		

			
1			
Part No.	104489	Ref. No.	00135000 011894
description	angle piece T1: 3/4" IT T2: 1/2" ET grommet ø 13.5mm grommet length 22mm WS 24 brass		

equipment-specific units

for deep fryers

miscellaneous

			
1			
Part No.	550268	Ref. No.	8700008
description	cover cap for push-button		

for convection ovens/combi-steamers





drain valves

			
1			
Part No.	696788	Ref. No.	91200011
description	drain pipe thread 1 1/2" IT T-piece plastic ID ø 37mm ED ø 40mm for combi-steamer		



door mechanics

locking mechanism

			
1			
Part No.	698503	Ref. No.	92800011
description	espagnolette lock complete		
accessories for	698503		
	Part No.	690041	Ref. No. —
	cam L 148mm mounting distance 32mm		
	Part No.	694409	Ref. No. —
	mounting set for espagnolette lock 694382		
	Part No.	700604	Ref. No. 1260017
	latch gear opening to the right shaft intake ø 8x8mm L 170mm W 40mm H 40mm		



for ovens

miscellaneous

			
1			
Part No.	698478	Ref. No.	92800013
description	coupling for oven for door L 80mm W 26mm intake 7.8 x 7.8		

knobs

universal knobs

			
1			
Part No.	110119	Ref. No.	22405005
description	knob thermostat t.max. 110°C ø 50mm shaft ø 6x4.6mm shaft flat upper black temperature range 30-110°C rotation 270°		
accessories for	110119		
	Part No.	110135	Ref. No. —
	rosette knob up to ø 52mm		

producer-specific knobs

REPAGAS

			
1			
Part No.	111474	Ref. No.	001624 30100053
description	knob gas tap ø 63mm shaft ø 8x6mm shaft flat right		

			
1			
Part No.	111472	Ref. No.	00300078 013839
description	knob gas tap with ignition flame ø 63mm shaft ø 10x8mm shaft flat right		

			
1			
Part No.	111473	Ref. No.	012948 60100059
description	knob gas tap with ignition flame ø 63mm shaft ø 8x6mm shaft flat right		

			
1			
Part No.	111471	Ref. No.	002217 50100083
description	knob gas tap with ignition flame ø 76mm shaft ø 10x8mm shaft flat right		

			
1			
Part No.	112769	Ref. No.	017181 30800043
description	knob gas tap without ignition flame ø 76mm shaft ø 10x8mm shaft flat right		



locks



edgmount latches

handle latches

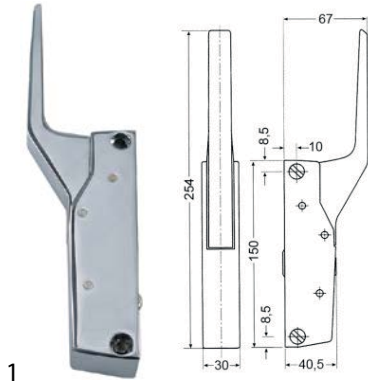
CAFF/FERMOD



1

Part No.	700060	Ref. No.	1250056
description	handle latch L 150mm mounting distance 133mm non lockable heated units G 791		
accessories for	700060		
	Part No.	700061	Ref. No. 1250046
	door catch L 58mm W 20mm H 35mm mounting distance 42mm chrome-plated brass for headed units		
	Part No.	700062	Ref. No. —
	handle protection heated units		

door catches



1

Part No.	700061	Ref. No.	1250046
description	door catch L 58mm W 20mm H 35mm mounting distance 42mm chrome-plated brass for headed units		
accessories for	700061		
	Part No.	690414	Ref. No. —
	handle latch L 150mm mounting distance 133mm non lockable refrigeration units G 791		

snap locks

universal



1

Part No.	690903	Ref. No.	1270034
description	snap lock L 69mm W 13mm H 20mm mounting distance 57mm complete with door catch nickel-plated brass		



1

Part No.	692609	Ref. No.	1270034
description	snap lock L 70mm W 13mm H 21mm mounting distance 60/30mm complete with door catch zamak		

espagnolette locks

universal



1

Part No.	700604	Ref. No.	1260017
description	latch gear opening to the right shaft intake \varnothing 8x8mm L 170mm W 40mm H 40mm		

hinges

oven hinges



1

Part No.	701137	Ref. No.	00107027 003626
description	cover mounting distance 95mm L 112mm W 26mm thickness 1mm cut-out 9x66mm for oven hinge		



1

Part No.	701135	Ref. No.	00111000
description	opposite support mounting distance 94mm L 110mm W 19mm for oven hinge		

1

Part No.	701136	Ref. No.	00148000 005488
description	opposite support mounting distance 94mm L 110mm W 21mm cut-out 8x59mm for oven hinge		



1

Part No.	701134	Ref. No.	000620 00144000
description	oven hinge mounting distance 173mm mounting distance 2mm lug mounting 14mm lever length 123mm groove distance 10mm spring thickness 3.5mm mounting ear position left/right spring length 112mm L 207mm W 25mm		

door bearing



1

Part No.	514310	Ref. No.	009400 1250066
description	hinge bearing mounting pos. bottom left without bolt		



1

Part No.	514309	Ref. No.	009413 1250067
description	hinge bearing mounting pos. upper left without bolt		



1

Part No.	514312	Ref. No.	001988 43000034
description	hinge bearing mounting pos. upper left without bolt		

fittings for catering equipment

outlet taps

universal

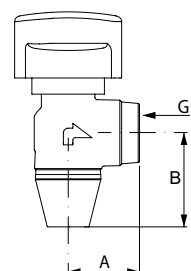
1

Part No.	541609	Ref. No.	8500001	
description	outlet tap chrome-plated brass W 46mm H 40mm thread 1" IT			
spare parts for	541609			
	Part No.	540747	Ref. No.	—
	outlet tap chrome-plated brass angled W 30mm H 40mm thread 1/2" IT			

equipment feet and end caps

equipment feet

with fixing plate



1

Part No.	701132	Ref. No.	00102005 007971
description	equipment foot tube ø 64mm plate size 70x90mm hole distance 35x76mm H 115-155mm SS size 2 1/2" Qty 1 pcs		



screw-in feet



Part No.	701133	Ref. No.	018148+008243 24600030 34101010 34101010+078-p
description	equipment foot thread M10 thread L 34mm ø 40mm H 25mm WS 17 Qty 1 pcs		

with upstand



Part No.	970527	Ref. No.	00100115
description	grate W 530mm D 650mm GN 2/1 chrome-plated steel with hinge camp crossing wires 2 suitable for refrigerator		
accessories for	970527		
	Part No.	690330	Ref. No. —
	rack L 1000mm W 22mm H 4mm aperture 3x8mm hole distance 12.5mm stainless steel		
	Part No.	694700	Ref. No. —
	shelf support L 31/28mm W 22mm H 18mm SS Qty 12 pcs		
	Part No.	694701	Ref. No. —
	shelf support L 31/28mm W 22mm H 17mm SS with hook Qty 12 pcs		

baskets

fryer baskets

REPAGAS



Part No.	970778	Ref. No.	001414 57200022
description	fryer basket W1 210mm L1 240mm H1 115mm chrome-plated steel		

gaskets

gaskets for heated units

window seals

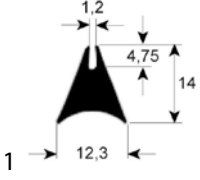

Part No.	900058	Ref. No.	009293 1240011 1250054
description	window gasket profile 1620 Qty supplied by meter		



shelves and shelf rails

grates

universal

without upstand



Part No.	970120	Ref. No.	4100029
description	grate W 325mm D 530mm GN 1/1 chrome-plated steel wire gauge frame 7mm lengthwise wires gauge 4mm crossing wires 1		
accessories for	970120		
	Part No.	690330	Ref. No. —
	rack L 1000mm W 22mm H 4mm aperture 3x8mm hole distance 12.5mm stainless steel		
	Part No.	694700	Ref. No. —
	shelf support L 31/28mm W 22mm H 18mm SS Qty 12 pcs		
	Part No.	694701	Ref. No. —
	shelf support L 31/28mm W 22mm H 17mm SS with hook Qty 12 pcs		

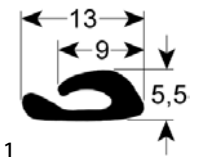

Part No.	900470	Ref. No.	007609 42300002
description	window gasket profile 1880 L 520mm Qty 1		
accessories for	900470		
	Part No.	900471	Ref. No. —
	window gasket profile 1880 L 680mm Qty 1		

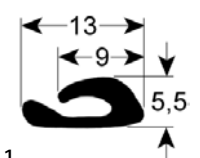

Part No.	900882	Ref. No.	007620 42300003
description	window gasket profile 1880 Qty supplied by meter		



door seals

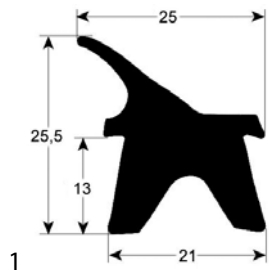

Part No.	900348	Ref. No.	1240012
description	door seal profile 2402 Qty supplied by meter		

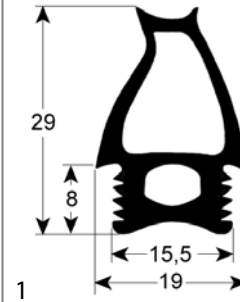

Part No.	901627	Ref. No.	92800001
description	door seal profile 2781 W 688mm L 1410mm external size suitable for ANGELO PO		

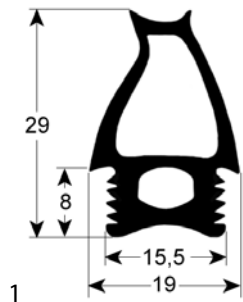

Part No.	901624	Ref. No.	92600002
description	door seal profile 2781 W 475mm L 1410mm external size suitable for ANGELO PO		

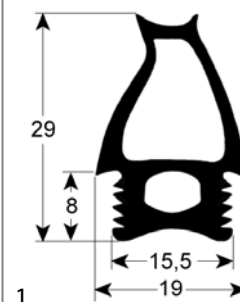

Part No.	901626	Ref. No.	92800010
description	door seal profile 2781 W 688mm L 886mm external size suitable for ANGELO PO		

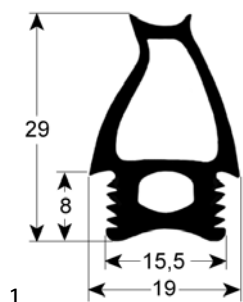

Part No.	901622	Ref. No.	92000022
description	door seal profile 2781 W 475mm L 475mm external size suitable for ANGELO PO		

gaskets for tray rack trolleys

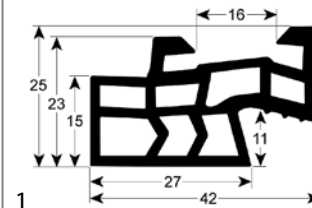

Part No.	902520	Ref. No.	92600004
description	tray rack trolley gasket profile 4140 L 515mm Qty 1		

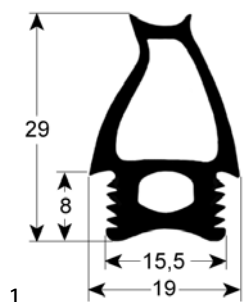

Part No.	901623	Ref. No.	92200002
description	door seal profile 2781 W 475mm L 725mm external size suitable for ANGELO PO		

sealing washers

graphite gaskets



Part No.	501423	Ref. No.	006621 04708015
description	flat gasket graphite ED ø 20mm ID ø 8mm thickness 1mm eccentric Qty 1 pcs		



Part No.	501422	Ref. No.	005438 07108015
description	flat gasket graphite ED ø 46mm ID ø 35mm thickness 1mm Qty 1 pcs		



rubber gaskets



1

Part No.	511926	Ref. No.	009037 04708016
description	flat gasket rubber ED ø 11.3mm ID ø 7.5mm thickness 2.7mm Qty 1 pcs		

silicone gaskets



1

Part No.	359721	Ref. No.	1230008
description	gasket silicone ED ø 48mm ID ø 39.5mm thickness 5mm Qty 1 pcs		

shaft gaskets

shaft gaskets



1

Part No.	511171	Ref. No.	43000042
description	shaft seal ID ø 14.5mm ED ø 20mm thickness 3mm		



1

Part No.	511172	Ref. No.	43000045
description	shaft sealing ID ø 24mm ED ø 29mm thickness 3mm		

manometers



1

Part No.	541508	Ref. No.	90200028
description	manometer ø 40mm pressure range 0-4bar connection thread 1/8"		

hose reels and spray guns

spray guns



1

Part No.	691048	Ref. No.	1270003R	
description	spray gun for appliances 1/2" ET L 225mm type STAR			
spare parts for	691048			
	Part No.	507309	Ref. No.	—
	O-ring EPDM thickness 2.62mm ID ø 17.13mm Qty 1 pcs			
	Part No.	510322	Ref. No.	—
	O-ring EPDM thickness 1.78mm ID ø 17.17mm Qty 1 pcs			
	Part No.	524055	Ref. No.	—
	flat gasket rubber ED ø 18mm ID ø 12mm thickness 2mm Qty 1 pcs			
	Part No.	528485	Ref. No.	—
	O-ring EPDM thickness 1.78mm ID ø 6.07mm Qty 1 pcs			
	Part No.	528494	Ref. No.	—
	gasket rubber ED ø 13mm ID ø 4mm thickness 4mm Qty 1 pcs			

valves and tank inlets

ball valves

ball valves electric



1

Part No.	401233	Ref. No.	43000004
description	ball valve inlet 1/2" IT outlet 1/2" IT 230V 50/60Hz mode of operation electric W 60mm H 99mm cable 4-pole 2.5W 4-pole duty cycle 50%		



water cycle components

pressure reduction valves

pressure reduction valves

universal



1			
Part No.	520967	Ref. No.	90200026
description	pressure reduction valve series HP WR01 connection 1/2" default setting 3bar setting range 1-6bar p max 16bar t.max. 40°C chrome-plated brass IMPORT		

measuring equipment

thermometers

built-in thermometers

ø52mm



1			
Part No.	541252	Ref. No.	9400021
description	thermometer mounting ø 52mm t.max. 250°C 0 up to +250°C probe ø 4mm probe L 74mm capillary pipe 1330mm		



1			
Part No.	541077	Ref. No.	1230022
description	thermometer mounting ø 52mm t.max. 350°C +50 up to +350°C probe ø 6mm probe L 30mm capillary pipe 1000mm built-in depth 28mm		

fastening material

screws

hexagonal screws

1			
Part No.	506445	Ref. No.	91900007
description	hexagonal screw thread M10 thread L 35mm SS WS 17 Qty 1 pcs DIN 933 / ISO 4017		

1			
Part No.	560555	Ref. No.	1083-P
description	hexagonal screw thread M6 thread L 15mm SS WS 10 Qty 1 pcs DIN 933 / ISO 4017		
accessories for	560555		
	Part No.	104488	Ref. No. 00100171
	burner head ø 115mm for burner cap ø 105mm		

nuts

hexagonal nuts

hexagonal nuts metric (without norm)

1			
Part No.	520230	Ref. No.	00112127 010106
description	nut thread M14x1.5 H 5mm WS 19 zinc-coated steel Qty 1 pcs		

1			
Part No.	520594	Ref. No.	003510 04700009
description	nut thread M8x1 H 3mm WS 13 brass Qty 1 pcs		

washers

washers

miscellaneous

1			
Part No.	560494	Ref. No.	011523 24205030
description	plain washer ID ø 12mm ED ø 18mm thickness 1.6mm aluminium Qty 1 pcs		



fasteners

roll pins



1

Part No.	691637	Ref. No.	1260021
description	roll pin ø 3mm L 20mm		

GASTROPARTS.COM

