



GASTROPARTS

Reneka

- [EN]** Equipment
- [DE]** Geräte
- [ES]** Aparatos
- [FR]** Équipement
- [IT]** Attrezzature
- [PL]** Urządzenia
- [RU]** Оборудование

✉ gastroparts@gastroparts.com

☎ tel. +48 56 657 00 66

📘 fb.com/gastroparts.global

GASTROPARTS.COM







heating elements

heating elements for coffee machine

			
1			
Part No.	417460	Ref. No.	9005365
description	heating element 2100W 230V heating circuits 2 mounting ø 46mm hole distance 57mm L 180mm W 37mm H 48mm L1 30mm L2 45mm L3 105mm H1 30mm H2 18mm hole ø 8.3mm tube ø 8.3mm thermostat sleeves ø 7mm length thermostat sleeves 160mm thermostat sleeve eccentric, non clinging number of thermostat sleeves 1 connection male faston 6.3mm immersion heater 3 hole flange suitable for RENEKA		
For models:	LC, Pilot, Tempo, Viva, Viva-S, XL-Basic, XL-PALLAS		

			
1			
Part No.	417449	Ref. No.	9005365
description	heating element 2100W 230V heating circuits 2 mounting ø 46mm hole distance 57mm L 185mm W 28mm H 36mm connection male faston 6.3mm immersion heater		

			
1			
Part No.	417136	Ref. No.	N/A
description	heating element 2100W 230V heating circuits 3 mounting ø 46mm hole distance 56mm L 172mm W 35mm H 34mm hole ø 8.5mm tube ø 8mm connection male faston 6.3mm immersion heater 3 hole flange suitable for RENEKA		



			
1			
Part No.	417298	Ref. No.	9215366
description	heating element 3100W 230V heating circuits 2 thread 1/4" L 325mm W 24mm H 36mm tube ø 8.3mm thermostat sleeves ø 6mm length thermostat sleeves 156mm number of thermostat sleeves 1 thermostat sleeve centre not clinging connection male faston 6.3mm immersion heater connection length 25mm flange with thread coffee machine WS 37		
For models:	Mosaic		

			
1			
Part No.	417137	Ref. No.	9005366
description	heating element 3100W 230V heating circuits 3 mounting ø 46mm hole distance 56mm L 230mm W 37mm H 42mm hole ø 8mm tube ø 8.2mm connection male faston 6.3mm immersion heater 3 hole flange suitable for RENEKA		
For models:	Concept, LC, Tempo, Viva, Viva-e, Viva-S, XL-PALLAS		

			
1			
Part No.	417299	Ref. No.	9215367
description	heating element 3130/4700W 230/400V heating circuits 3 thread 1/4" L 400mm W 36mm H 27mm tube ø 8.3mm connection male faston 6.3mm immersion heater connection length 25mm flange with thread coffee machine WS 37		
For models:	Mosaic		

			
1			
Part No.	417450	Ref. No.	9005367
description	heating element 3800W 230V heating circuits 3 mounting ø 46mm hole distance 57mm L 325mm W 35mm H 34mm L1 35mm L2 50mm L3 240mm thermostat sleeves ø 7mm length thermostat sleeves 156mm thermostat sleeve eccentric, clinging number of thermostat sleeves 1 connection male faston 6.3mm immersion heater 3 hole flange		
For models:	Concept, Plus, Prestige, Viva, Viva-e, Viva-S, XL-Basic, XL-PALLAS		

			
1			
Part No.	417438	Ref. No.	9005378
description	heating element 4000W 230V heating circuits 3 mounting ø 46mm hole distance 57mm L 550mm W 37mm H 50mm L1 30mm L2 60mm L3 460mm H1 40mm H2 10mm hole ø 8.3mm tube ø 8.3mm thermostat sleeves ø 7mm length thermostat sleeves 160mm thermostat sleeve eccentric, non clinging number of thermostat sleeves 1 connection male faston 6.3mm immersion heater 3 hole flange		
For models:	LC, Viva-S, XL-PALLAS		

			
1			
Part No.	417317	Ref. No.	9101012
description	heating element 4600/5450W 220/240V heating circuits 2 mounting ø 42mm hole distance 39mm L 540mm W 28mm H 55mm L1 45mm L2 35mm L3 460mm H1 35mm H2 20mm hole ø 9mm tube ø 8.5mm thermostat sleeves ø 7.5mm length thermostat sleeves 268mm thermostat sleeve eccentric, non clinging number of thermostat sleeves 1 connection male faston 6.3mm immersion heater 4 hole flange stainless steel		
For models:	Streamline-710, Streamline-940		
accessories for	417317		
		Part No.	526448
		Ref. No.	9220013
	gasket D1 ø 76mm D2 ø 39mm thickness 2mm hole distance 39mm FIBER		

			
1			
Part No.	417316	Ref. No.	9220017 9220017 3 Phase
description	heating element 4650W 230/400V heating circuits 3 mounting ø 41mm hole distance 39mm L 338mm W 33mm H 58mm L1 50mm L2 58mm L3 230mm H1 33mm H2 25mm hole ø 9mm tube ø 8mm thermostat sleeves ø 6.5mm length thermostat sleeves 168mm thermostat sleeve eccentric, non clinging number of thermostat sleeves 1 connection male faston 6.3mm immersion heater 4 hole flange		
For models:	Streamline-710, Streamline-940		



			
1			
Part No.	417138	Ref. No.	N/A
description	heating element 5500W 230V heating circuits 3 mounting \varnothing 46mm hole distance 56mm L 463mm W 36mm H 34mm hole \varnothing 8mm tube \varnothing 8mm connection male faston 6.3mm immersion heater 3 hole flange suitable for RENEKA		

			
1			
Part No.	417451	Ref. No.	9005354
description	heating element 5500W 230V heating circuits 3 mounting \varnothing 48mm hole distance 57mm L 550mm W 35mm H 34mm L1 45mm L2 50mm L3 465mm tube \varnothing 8.3mm thermostat sleeves \varnothing 7mm length thermostat sleeves 160mm thermostat sleeve eccentric, non clinging number of thermostat sleeves 1 connection male faston 6.3mm immersion heater		
For models:	Concept, LC, Plus, Prestige, Viva, Viva-e, Viva-S, XL-Basic, XL-PALLAS		

heating cartridges

			
1			
Part No.	417318	Ref. No.	9213475
description	heating cartridge 35W 230V \varnothing 6mm L 70mm connection male faston 6.3mm cable length 260mm dry heating element		
For models:	Mosaic		

accessories

sealing washers

PTFE gaskets

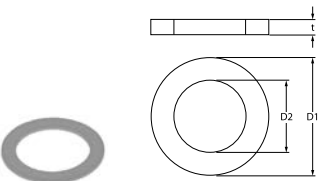
			
1			
Part No.	526460	Ref. No.	9001720
description	flat gasket PTFE ED \varnothing 50mm ID \varnothing 36mm thickness 2mm Qty 1 pcs		
For models:	LC, Streamline-710, Streamline-940, Tempo, Viva, Viva-e, Viva-S, XL-Basic, XL-PALLAS		

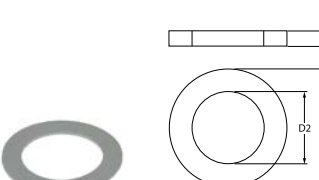
			
1			
Part No.	526459	Ref. No.	9001824
description	flat gasket PTFE ED \varnothing 62mm ID \varnothing 42mm thickness 2mm Qty 1 pcs		
For models:	Mosaic		

thermostats

control and safety thermostats

EGO

safety thermostats

55.32_ series



			
1			
Part No.	375454	Ref. No.	9101000
description	safety thermostat switch-off temp. 154°C 3-pole 20A probe \varnothing 6mm probe L 87mm capillary pipe 890mm capillary pipe isolated 800mm gland nut probe		
For models:	Streamline-710, Streamline-940		

switches and momentary switches

push/momentary push switches

\varnothing 30mm

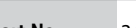

			
1			
Part No.	346923	Ref. No.	9209001 9209031
description	push switch mounting measurements \varnothing 30mm clear 2NO 230V connection screw 10A protection IP40 ambient temperature max. 85/125°C		
For models:	Streamline-710, Streamline-940		

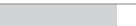

			
1			
Part No.	346922	Ref. No.	9209008 9209038
description	push switch mounting measurements \varnothing 30mm green 2NO/indicator light 230V connection screw 10A protection IP40 ambient temperature max. 85°C		
For models:	Viva-e		



control equipment

SCHLEGEL

ø22mm

switches (complete)



1

Part No.	347081	Ref. No.	9003763
description	switch mounting measurements ø22mm silver latching 1NO rotation 90° sequence 0-1		
For models:	LC, Mosaic		

LEGRAND

lamp elements



1

Part No.	347087	Ref. No.	9209003 9209017
description	lamp element 230V voltage AC blue		
For models:	Streamline-710, Streamline-940, Viva-S		

switches (complete)



1

Part No.	346923	Ref. No.	9209001 9209031
description	push switch mounting measurements ø30mm clear 2NO 230V connection screw 10A protection IP40 ambient temperature max. 85/125°C		
For models:	Streamline-710, Streamline-940		



1

Part No.	346922	Ref. No.	9209008 9209038
description	push switch mounting measurements ø30mm green 2NO/indicator light 230V connection screw 10A protection IP40 ambient temperature max. 85°C		
For models:	Viva-e		



1

Part No.	347290	Ref. No.	9003756
description	switch mounting measurements ø22mm 1NO sequence 0-1		
For models:	Concept, Tempo, Viva, XL-Basic, XL-PALLAS		



1

Part No.	347289	Ref. No.	9209031 9209042
description	switch mounting measurements ø22mm black 2NO sequence 0-1 complete		
For models:	Streamline-710, Streamline-940, Viva-S		

lamps



1

Part No.	359896	Ref. No.	9003754
description	neon light bulb socket Ba9s 230V green ø 10mm L 28mm		
For models:	Concept, Plus, Prestige, Tempo, Viva, Viva-e, XL-Basic, XL-PALLAS		

lamps

indicator lights

indicator lights 3-piece (housing, lens and bulb)

lamps

neon light bulbs



1

Part No.	359896	Ref. No.	9003754
description	neon light bulb socket Ba9s 230V green ø 10mm L 28mm		
For models:	Concept, Plus, Prestige, Tempo, Viva, Viva-e, XL-Basic, XL-PALLAS		



screw-on/push-on fit

neon light bulbs



1

Part No.	359896	Ref. No.	9003754
description	neon light bulb socket Ba9s 230V green ø 10mm L 28mm		
For models:	Concept, Plus, Prestige, Tempo, Viva, Viva-e, XL-Basic, XL-PALLAS		

solid state relays

CELDUC



1

Part No.	401643	Ref. No.	9209000
description	solid state relay CELDUC 1 phase 50A 12-280V 3-32VDC L 58mm W 45mm screw type SO945460		
For models:	Mosaic, Streamline-710, Streamline-940, Viva-S		

relays

power relays

with bracket mounting



1

Part No.	380687	Ref. No.	9006578
description	power relays FINDER 230VAC 30A 2NO connection F6.3 bracket mounting manuf. no. 66.82.8.230.0300		
For models:	Concept, LC, Mosaic, Pilot, Plus, Prestige, Streamline-710, Streamline-940, Tempo, Viva, Viva-e, Viva-S, XL-Basic, XL-PALLAS		

probes

producer-specific probes

probes



1

Part No.	401656	Ref. No.	9209004
description	temperature probe NTC 47kOhm cable PTFE probe -40 up to +125°C cable -40 up to +250°C connection plug thread 1/8" probe ø7x28mm cable length 0.2m		
For models:	Mosaic, Streamline-710, Streamline-940, Viva-S		

electronics

PCBs



1

Part No.	401650	Ref. No.	9005447
description	display L 117mm W 45mm blue		
For models:	Streamline-710, Streamline-940, Tempo, Viva-S		



1

Part No.	401647	Ref. No.	9209037
description	keypad PCB L 135mm W 43mm with housing buttons 6		
For models:	Streamline-710, Streamline-940, Viva-e, Viva-S		



1

Part No.	401646	Ref. No.	9209036 9509036
description	keypad PCB L 135mm W 44mm with housing buttons 5		
For models:	Streamline-710, Streamline-940, Viva-S		



central units



1

Part No.	402434	Ref. No.	9213963
description	central unit 240V 50/60Hz type 3d5 3GRCT XLC (SC) voltage AC		
For models:	Mosaic		



1

Part No.	402433	Ref. No.	9213964
description	central unit 240V 50/60Hz type 3d5 3GRCTZ XLC (SC) „H16A“ NT-C+SSR voltage AC		
For models:	Mosaic		



1

Part No.	401653	Ref. No.	9209010
description	central unit 4-group 230V 50/60Hz type Viva S		
For models:	Streamline-710, Streamline-940, Viva-S		



1

Part No.	402435	Ref. No.	4209010
description	central unit 4-group 230V 50/60Hz type Viva S „Triac“		



1

Part No.	402436	Ref. No.	9003155 9003675 9003678
description	central unit complete incl. fastening plate type 3d5 3GRCTZ XLC (SC)		
For models:	Viva, Viva-S, XL-Basic, XL-PALLAS		
spare parts for	402436		
	Part No.	402434	Ref. No. 9213963
	central unit 240V 50/60Hz type 3d5 3GRCT XLC (SC) voltage AC		



1

Part No.	401651	Ref. No.	9003678
description	control box 2-group for coffee machine 230V type 3d5 2GRCTZ LC		



1

Part No.	401652	Ref. No.	9003679
description	control box 3-group for coffee machine 230V type 3d5 3GRCTZ XLC (SC)		
For models:	LC, Streamline-710, Streamline-940, Viva-e, Viva-S		

keypads

front foils



1

Part No.	401644	Ref. No.	9006858
description	front foil		



1			
Part No.	401645	Ref. No.	9209040 9209041
description	keypad foil black L 110mm W 16.5mm buttons 6		
For models:	Streamline-710, Streamline-940, Viva-S		

1			
Part No.	402439	Ref. No.	9006860
description	keypad foil ON-OFF grey/white L 104mm W 27mm buttons 2		
For models:	LC		

1			
Part No.	402440	Ref. No.	9006806
description	keypad foil RENEKA black/silver L 130mm W 40mm buttons 5		
For models:	LC, Viva		

1			
Part No.	531118	Ref. No.	9006807
description	keypad foil suitable for RENEKA L 130mm W 40mm buttons 6		
For models:	Viva		

membrane keypads

1				
Part No.	400487	Ref. No.	9006824	
description	membrane keypad			
For models:	Viva			
accessories for	400487			
	Part No.	401673	Ref. No.	9005012
	connecting cable for membrane keypad 2x4-pole suitable for RENEKA			

1			
Part No.	402847	Ref. No.	9213706
description	membrane keypad coffee machine RENEKA		
For models:	Mosaic		

keypad units

1			
Part No.	402437	Ref. No.	9003549
description	keypad unit buttons 2 grey/white ON-OFF L 116mm W 44mm		
For models:	LC		

1			
Part No.	402438	Ref. No.	9006778
description	keypad unit buttons 5 black RENEKA		
For models:	LC, Viva		

1			
Part No.	402444	Ref. No.	9213707
description	keypad unit buttons 5 chrome-plated set		

1			
Part No.	401648	Ref. No.	9209028
description	keypad unit buttons 6		
For models:	Streamline-710, Streamline-940, Viva-S		

1			
Part No.	402887	Ref. No.	9006779
description	keypad unit buttons 6 suitable for RENEKA lighting LED L 137mm W 46mm		
For models:	Viva		



accessories

			
Part No.	401673	Ref. No.	9005012
description	connecting cable for membrane keypad 2x4-pole suitable for RENEKA		

solenoid valves

solenoid valves (water)

metal

ODE

solenoid valves steam (water)

21A1 series

			
Part No.	370474	Ref. No.	9003435
description	solenoid valve brass 2-ways 230VAC with flange plate body 25-I28 DN 2.5mm slide-on receptacle DIN -10 up to 140°C ODE type series 5005 coil type BDA membranes FKM p max 14bar 50/60Hz silicone flange 32x32mm		
For models:	LC, Mosaic, Streamline-710, Streamline-940, Techno, Viva-e, Viva-S		

5005A series

			
Part No.	370541	Ref. No.	9008257
description	solenoid valve brass 3-ways 230VAC DN 1.5mm slide-on receptacle DIN -10 up to 140°C ODE coil type BDA membranes FKM (water/steam) p max 15bar p min 0bar outer cone		
For models:	Concept, LC, Mosaic, Pilot, Plus, Prestige, Streamline-710, Streamline-940, Techno, Viva, Viva-e, Viva-S, XL-Basic, XL-PALLAS		

PARKER

2-way

VE-140 series

			
Part No.	370473 ¹	Ref. No.	9003344 AT7702308
description	solenoid valve 2-ways 230VAC connection 1/8" L 30mm -10 up to 140°C coil type ZB09 membranes ruby nickel-plated brass		
For models:	Atalante, Plus, Prestige, Streamline-710, Streamline-940, Tempo, Viva, Viva-e, Viva-S, XL-Basic, XL-PALLAS		

¹nickel-plated

electrodes

			
Part No.	401655	Ref. No.	9010491
description	level electrode 1/4" IT total length 155mm probe L 131mm insulated probe length 31mm connection angled, male faston 6.3mm ø 3mm		
For models:	LC, Mosaic, Plus, Prestige, Streamline-710, Streamline-940, Tempo, Viva, Viva-e, Viva-S, XL-Basic, XL-PALLAS		

			
Part No.	401654	Ref. No.	9010490
description	level electrode 1/4" IT total length 95mm probe L 65mm insulated probe length 31mm connection angled, male faston 6.3mm ø 3mm		
For models:	LC, Mosaic, Streamline-710, Streamline-940, Tempo, Viva, Viva-e, Viva-S, XL-Basic, XL-PALLAS		

flow meters and flow sensors

flow meters

GICAR

			
Part No.	400778	Ref. No.	9008954
description	flow meter thread 1/4" stainless steel with LED plug-in connection approval NSF		
For models:	Concept, LC, Pilot, Plus, Prestige, Streamline-710, Streamline-940, Techno, Tempo, Viva, Viva-e, Viva-S, XL-Basic, XL-PALLAS		



pumps

booster pumps II

pump motors

clip connection



Part No.	500072	Ref. No.	9007902
description	pump motor RPM type C013726 120W 230V 50/60Hz connection clip L 145mm W 125mm H 110mm capacitor 6.3µF at 50Hz 1320rpm at 60Hz 1570rpm flange ø1 47.5mm flange ø2 38.3mm shaft diameter 5x11.5mm		
For models:	LC, Tempo, Viva, Viva-S		
accessories for	500072		
	Part No.	365012	Ref. No. —
	operating capacitor capacity 6.3µF 450V tolerance 5% 50Hz ambient temperature max. -25 to +85°C ø 30mm L 61mm M8 plastic connection male faston 6.3mm protection		

pump heads

FLUID-O-TECH



Part No.	501517	Ref. No.	9007907
description	pump head FLUID-O-TECH 200l/h connection 3/8" NPT with filter an bypass brass clip connection for coffee machine		
For models:	Plus, Prestige, Streamline-710, Streamline-940, Viva-S, XL-PALLAS		



Part No.	500177	Ref. No.	N/A
description	pump head PA204X FLUID-O-TECH L 82mm 200l/h connection 3/8" GAS with filter an bypass brass clip connection for coffee machine shaft ø 4.8x11mm		



Part No.	500064	Ref. No.	N/A
description	pump head PO204 FLUID-O-TECH L 82mm 200l/h connection 3/8" GAS with bypass brass clip connection for coffee machine shaft ø 4.8x11mm		
accessories for	500064		
	Part No.	520126	Ref. No. —
	clamp for pump/motor		

equipment-specific units

for espresso machines

filter holders

filter holders standard

filter holders (complete)



Part No.	529214	Ref. No.	9204510
description	filter holder		



Part No.	529215	Ref. No.	9204511
description	filter holder		



Part No.	529217	Ref. No.	9204501
description	filter holder		
For models:	Viva-e, Viva-S		



filter holder without spout			
1			
Part No.		Ref. No.	N/A
description	filter holder suitable for RENEKA without outlet mounting ø 77mm outlet 3/8" ID ø 60.5mm wedge height 11.5mm wedge position horizontal number of wedges 2 lever straight		

1			
Part No.	526466	Ref. No.	9215312 9216151
description	filter holder suitable for RENEKA without outlet mounting ø 83mm ID ø 62mm		
For models:	Mosaic		

filter holders short			
1			
Part No.	529033	Ref. No.	9004934
description	filter holder mounting ø 77mm outlet 3/8" ID ø 60.5mm handle M10x1.5 wedge height 11.5mm wedge position horizontal number of wedges 2 lever straight chrome-plated brass		
For models:	LC, Plus, Streamline-710, Streamline-940, Viva-e, Viva-S, XL-PALLAS		
accessories for	529033		
	Part No.	Ref. No.	N/A
	529053		
description	handle ø 35mm thread M10x1.5 thread L 15mm L 125mm black		

handles			
with external thread			
1			
Part No.	529053	Ref. No.	N/A
description	handle ø 35mm thread M10x1.5 thread L 15mm L 125mm black		

with bore			
1			
Part No.	529207	Ref. No.	N/A
description	handle dimensions 28/33mm ID ø 11mm L 130mm black		

filters			
for 1 cup			
1			
Part No.	526496	Ref. No.	9003947 9003957
description	coffee filter ø 67.5mm mounting ø 60mm H 20.1mm cups 1 amount of coffee 7g perforation ø 0.4mm		
For models:	Concept, LC, Mosaic, Pilot, Plus, Prestige, Streamline-710, Streamline-940, Techno, Viva, Viva-e, Viva-S, XL-Basic, XL-PALLAS		

1			
Part No.	526495	Ref. No.	9003961
description	coffee filter ø 67.7mm mounting ø 60mm H 20mm cups 1 amount of coffee 6g perforation ø 0.4mm		
For models:	Concept, LC, Plus, Prestige, Streamline-710, Streamline-940, Techno, Viva-e, Viva-S, XL-Basic, XL-PALLAS		

for 2 cups			
1			
Part No.	526497	Ref. No.	9003944 9003958
description	coffee filter ø 67.5mm mounting ø 60mm H 22.1mm cups 2 amount of coffee 14g perforation ø 0.4mm		
For models:	Concept, LC, Mosaic, Pilot, Plus, Prestige, Streamline-710, Streamline-940, Techno, Viva, Viva-e, Viva-S, XL-Basic, XL-PALLAS		

for 3 and more cups			
1			
Part No.	526477	Ref. No.	9003939
description	coffee filter ø 67.6mm mounting ø 60mm H 30mm cups 3 amount of coffee 21g		
For models:	LC, Plus, Prestige, Streamline-710, Streamline-940, Techno, Viva, Viva-e, Viva-S, XL-Basic, XL-PALLAS		



brewing units

shower screens

flat



Part No.	529084	Ref. No.	9003470
description	shower screen ϕ 52mm hole ϕ 6.4mm		
For models:	Concept, LC, Mosaic, Pilot, Plus, Prestige, Streamline-710, Streamline-940, Techno, Viva, Viva-e, Viva-S, XL-Basic, XL-PALLAS		

filter holder gaskets

flat

with internal notch



Part No.	526270	Ref. No.	9101145
description	filter holder gasket D1 ϕ 72mm D2 ϕ 56mm H 8mm with inside notch Qty 1 pcs		
For models:	Mosaic		



Part No.	528037	Ref. No.	9003203
description	filter holder gasket D1 ϕ 73.8mm D2 ϕ 57.2mm H 9mm with inside notch Qty 1 pcs		
For models:	Concept, LC, Plus, Prestige, Streamline-710, Streamline-940, Viva, Viva-e, Viva-S, XL-Basic, XL-PALLAS		

brewing units manual

components

gaskets



Part No.	529795	Ref. No.	9005074
description	gasket D1 ϕ 13mm D2 ϕ 4mm thickness 4mm coffee machine		
For models:	LC, Mosaic, Streamline-710, Streamline-940, Viva-e, Viva-S		

components

nozzles

with thread



Part No.	531162	Ref. No.	9004176
description	nozzle bore ϕ 0.8mm thread M10x1 L 8mm		
For models:	Concept, Plus, Prestige, Viva, XL-Basic, XL-PALLAS		

gaskets



Part No.	526448	Ref. No.	9220013
description	gasket D1 ϕ 76mm D2 ϕ 39mm thickness 2mm hole distance 39mm FIBER		
For models:	Streamline-710, Streamline-940		

water dispersions

water dispersions

group 3



Part No.	528855	Ref. No.	9003471
description	water distributor ϕ 39.5mm H 4.3mm 6 holes hole ϕ 2mm mounting ϕ 6.6mm brass		
For models:	Concept, LC, Plus, Prestige, Streamline-710, Streamline-940, Viva, Viva-e, Viva-S, XL-Basic, XL-PALLAS		

safety valves

safety valves

1/2"



Part No.	529827	Ref. No.	9005001
description	safety valve connection 1/2" triggering pressure 1.5bar		
For models:	Atalante, LC, Plus, Prestige, Streamline-710, Streamline-940, Viva, Viva-e, Viva-S, XL-Basic, XL-PALLAS		



drain pans

covers



1

Part No.	529899	Ref. No.	9003996
description	cover for drain pan L 100mm W 75mm H 92mm hose ø 19mm ABS plastic		
For models:	Mosaic, Plus, Prestige, Viva, Viva-e, XL-Basic, XL-PALLAS		



1

Part No.	526454	Ref. No.	9003913
description	cover for drain pan with hole L 100mm W 75mm H 92mm hole ø 10mm hose ø 19mm ABS plastic		
For models:	LC		



1

Part No.	526455	Ref. No.	9202501 9202502
description	cover for drain pan with hole L 100mm W 75mm H 92mm hole ø 10mm hose ø 19mm ABS plastic		
For models:	Streamline-710, Streamline-940, Viva-S		

drain pans



1

Part No.	526456	Ref. No.	9003994
description	drain pan L 205mm W 68mm H 50mm connection 3/8" thread L 10mm		
For models:	LC, Tempo, Viva		

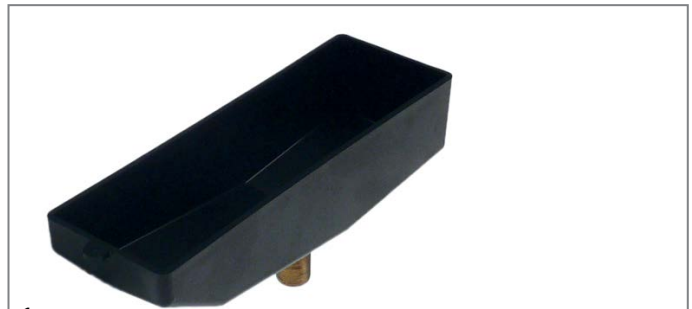

1

Part No.	526457	Ref. No.	9004004
description	drain pan L 205mm W 68mm H 50mm connection 3/8" thread L 22mm		
For models:	Plus, Prestige, XL-Basic, XL-PALLAS		



1

Part No.	526458	Ref. No.	9202499 9202500
description	drain pan with hole L 205mm W 68mm H 50mm connection 3/8" thread L 10mm		
For models:	Mosaic, Streamline-710, Streamline-940, Viva-e, Viva-S		

hose couplings





1

Part No.	526476	Ref. No.	9003995
description	hose connector connection 15mm thread 3/8" brass with mounting thread		
For models:	LC, Plus, Prestige, Tempo, Viva, XL-Basic, XL-PALLAS		



			
1			
Part No.	526463	Ref. No.	9201503
description	hose connector connection 15mm thread M16x1.5 chrome-plated brass		
For models:	Mosaic, Streamline-710, Streamline-940, Viva-e, Viva-S		



steam/water taps			
steam/water taps			
steam/water taps			
			
1			
Part No.	529830	Ref. No.	9007699 9007702
description	steam/water tap		
For models:	Concept, LC, Plus, Prestige, Tempo, Viva, XL-Basic, XL-PALLAS		

			
1			
Part No.	528974	Ref. No.	9208020
description	steam/water tap complete		
For models:	Viva-e, Viva-S		
accessories for	528974		
	Part No.	532557	Ref. No. 9001834
	O-ring NBR thickness 2.62mm ID ø 12.37mm Qty 1 pcs		

			
1			
Part No.	531072	Ref. No.	9217703
description	steam/water tap mounting pos. left inlet 3/8" outlet 3/8" shaft M8 shaft L 25mm chrome-plated brass		
For models:	Streamline-710, Streamline-940		

			
1			
Part No.	526446	Ref. No.	9217702
description	steam/water tap mounting pos. left/right swing lever inlet 3/8" outlet 3/8" shaft M8 shaft L 25mm chrome-plated brass		
For models:	Mosaic		

steam taps			
steam taps (complete)			
1			
Part No.		Ref. No.	9217713
description	steam tap with pipe swing lever		
For models:	Mosaic		

components			
bushes			
			
1			
Part No.	526010	Ref. No.	9007706
description	bush steam/water tap D1 ø 10.5mm D2 ø 9mm ID ø 6.3mm H 4.6mm brass		
For models:	LC, Plus, Prestige, Tempo, Viva-e, Viva-S, XL-PALLAS		
accessories for	526010		
	Part No.	526005	Ref. No. —
	shaft steam tap ø 14.8mm L 92.5mm thread M6 brass		

gaskets			
			
1			
Part No.	526258	Ref. No.	9007703
description	gasket D1 ø 12.5mm thickness 5.5mm silicone		
For models:	LC, Plus, Prestige, Streamline-710, Streamline-940, Tempo, Viva-e, Viva-S, XL-PALLAS		

			
1			
Part No.	529795	Ref. No.	9005074
description	gasket D1 ø 13mm D2 ø 4mm thickness 4mm coffee machine		
For models:	LC, Mosaic, Streamline-710, Streamline-940, Viva-e, Viva-S		



union nuts



			
1			
Part No.	526464	Ref. No.	9220019
description	union nut thread TR20 for swing lever ID ø 13.5mm L 33mm		
For models:	Streamline-710, Streamline-940		

miscellaneous

			
1			
Part No.	525358	Ref. No.	9007708
description	stop for steam-/water-tap ø 14.5mm ID ø 6.3mm L 7.7mm		
For models:	LC, Plus, Prestige, Tempo, Viva-e, Viva-S, XL-PALLAS		

steam/water pipes

steam pipes

			
1			
Part No.	526450	Ref. No.	9213696
description	steam pipe with handle thread 3/8" H 170mm ø 14.5mm tube ø 8mm		
For models:	Mosaic		
accessories for	526450		
			
Part No.	528291	Ref. No.	9208015 9211741
description	O-ring Viton thickness 2.62mm ID ø 11.91mm Qty 1 pcs		
			
Part No.	528396	Ref. No.	9211739
description	O-ring EPDM thickness 2mm ID ø 7.2mm Qty 1 pcs		

			
1			
Part No.	526475	Ref. No.	9003696 9003700
description	steam pipe with tube handle thread M18x1 H 160mm ø 14.2mm tube ø 10mm stainless steel		
For models:	LC, Plus, Prestige, Tempo, Viva, Viva-e, Viva-S, XL-Basic		

nozzles for water pipes

tap aerators

			
1			
Part No.	548385	Ref. No.	9001890
description	tap aerator thread M22x1 with plastic insert at 3bar ca.44l/min		
For models:	LC, Mosaic, Plus, Prestige, Streamline-710, Streamline-940, Techno, Tempo, Viva, Viva-e, Viva-S, XL-Basic, XL-PALLAS		

water pipes

			
1			
Part No.	528976	Ref. No.	9003687
description	water pipe thread M18x1 L 84mm		
For models:	LC, Streamline-710, Streamline-940, Viva-e, Viva-S, XL-PALLAS		

			
1			
Part No.	526449	Ref. No.	9003697
description	water pipe thread M18x1 ø 22.3mm L 65mm		
For models:	LC, Streamline-710, Streamline-940, Techno, Viva, Viva-e, Viva-S, XL-Basic		

			
1			
Part No.	528975	Ref. No.	9003699
description	water pipe thread M18x1 ø 23.5mm L 35mm		
For models:	Plus, Prestige, Tempo, Viva-e, Viva-S, XL-PALLAS		



accessories

bushes



1

Part No.	526467	Ref. No.	9001887
description	bush D1 ø 14.2mm H 6mm with O-ring ID ø 7.1mm		
For models:	LC, Plus, Prestige, Streamline-710, Streamline-940, Techno, Tempo, Viva, Viva-e, Viva-S, XL-Basic, XL-PALLAS		

tube handles



1

Part No.	527844	Ref. No.	9001810
description	tube handle for pipe ø 10mm		
For models:	Concept, LC, Plus, Prestige, Streamline-710, Streamline-940, Techno, Tempo, Viva, Viva-e, Viva-S, XL-Basic, XL-PALLAS		



1

Part No.	528625	Ref. No.	9211810
description	tube handle L 35mm rubber ID ø 8mm		
For models:	Mosaic		

fine filters

fine filters



1

Part No.	528853	Ref. No.	9004176
description	fine filter with housing with thread H 8mm thread M10x1		

non-return valves

complete



1

Part No.	526465	Ref. No.	9008340
description	non-return valve EPDM inlet 1/8" outlet 1/8" L 20mm suitable for RENEKA		
For models:	Viva-S		



1

Part No.	526447	Ref. No.	9008336 9008339
description	non-return valve inlet 1/8" outlet 1/8" L 40.5mm		
For models:	Concept, LC, Mosaic, Pilot, Plus, Prestige, Tempo, XL-Basic, XL-PALLAS		

screw connections

miscellaneous



1

Part No.	531119	Ref. No.	9201505
description	grub screw for boiler T1: 1/8" L 8mm SS Qty 1 pcs		
For models:	Mosaic, Viva-e, Viva-S		

for coffee grinders

grinding burrs

grinding burrs straight

standard



1

Part No.	527202	Ref. No.	9009822
description	grinding burrs pair turn direction left D1 ø 63.3mm ID ø 38mm H 9mm tooth spacing 3mm hole ø 5.5mm bore ø 8.5mm mounting ø 50 straight suitable for BRASILIA, ROSSI equiv. no. 00058/BRASILIA, 4433/ROSSI		

knobs

steam/water taps

steam/water taps



1

Part No.	111323	Ref. No.	9208030
description	knob ø 45mm thread Tr18x2 black		
For models:	Viva-e, Viva-S		



1

Part No.	111324	Ref. No.	9004475
description	knob ø 48mm shaft ø 7.5mm chrome-plated		
For models:	Plus, Prestige, Tempo, XL-PALLAS		



1

Part No.	111170	Ref. No.	9004469
description	knob ø 55mm black		
For models:	Concept, LC, Tempo, Viva, XL-Basic		



knob dial plates

1 

Part No.	111321	Ref. No.	9208031
description	knob dial plate tail +/- ø 32.5mm chrome-plated		
For models:	Viva-S		

1 

Part No.	111322	Ref. No.	9208032
description	knob dial plate tail +/- ø 32.5mm chrome-plated		
For models:	Viva-e		

handles and hand wheels

lever handles

1 

Part No.	111326	Ref. No.	9217707 9218030
description	lever handle ø 16-19mm L 40mm thread M18x1.25 black		
For models:	Mosaic		

1 

Part No.	111325	Ref. No.	9220016
description	lever handle ø 22mm L 50mm thread M8x1.25 black/chrome		
For models:	Streamline-710, Streamline-940		

gaskets

O-rings

EPDM

1 

Part No.	526471	Ref. No.	9005073
description	O-ring EPDM thickness 1.78mm ID ø 8.9mm Qty 1 pcs		
For models:	LC, Mosaic, Streamline-710, Streamline-940, Viva-e, Viva-S		

1 

Part No.	504574	Ref. No.	9001838
description	O-ring EPDM thickness 1.78mm ID ø 9.25mm Qty 1 pcs		
For models:	Concept, Plus, Prestige, Viva, XL-Basic, XL-PALLAS		

1 

Part No.	526470	Ref. No.	9001825 9001900
description	O-ring EPDM thickness 2.62mm ID ø 3.68mm Qty 1 pcs		
For models:	Concept, Pilot, Plus, Prestige, Streamline-710, Streamline-940, Tempo, Viva, Viva-S, XL-PALLAS		

1 

Part No.	532572	Ref. No.	9001827
description	O-ring EPDM thickness 2.62mm ID ø 48.89mm Qty 1 pcs		
For models:	Mosaic		

1 

Part No.	532074	Ref. No.	9001827
description	O-ring EPDM thickness 2.62mm ID ø 48.89mm Qty 10 pcs		

1 

Part No.	528813	Ref. No.	9005075
description	O-ring EPDM thickness 2mm ID ø 17mm Qty 1 pcs		
For models:	LC, Mosaic, Streamline-710, Streamline-940, Viva-e, Viva-S		

1 

Part No.	526469	Ref. No.	9007707
description	O-ring EPDM thickness 2mm ID ø 5.5mm Qty 1 pcs		
For models:	LC, Plus, Prestige, Streamline-710, Streamline-940, Tempo, Viva-e, Viva-S, XL-PALLAS		



1				
	Part No.	528396	Ref. No.	9211739
	description	O-ring EPDM thickness 2mm ID ø 7.2mm Qty 1 pcs		
For models:	Mosaic			

1				
	Part No.	528852	Ref. No.	9001842
	description	O-ring EPDM thickness 3mm ID ø 39.8mm Qty 1 pcs		
For models:	Concept, LC, Pilot, Streamline-710, Streamline-940, Tempo, Viva, Viva-e, Viva-S, XL-Basic, XL-PALLAS			

Viton				
1				
	Part No.	528291	Ref. No.	9208015 9211741
	description	O-ring Viton thickness 2.62mm ID ø 11.91mm Qty 1 pcs		
For models:	Mosaic, Streamline-710, Streamline-940, Viva-S			

1				
	Part No.	526468	Ref. No.	9001859
	description	O-ring Viton thickness 3.6mm ID ø 35.6mm Qty 1 pcs		
For models:	Plus, Prestige, Tempo, XL-PALLAS			

NBR				
1				
	Part No.	532557	Ref. No.	9001834
	description	O-ring NBR thickness 2.62mm ID ø 12.37mm Qty 1 pcs		
For models:	Concept, Plus, Prestige, Streamline-710, Streamline-940, Tempo, Viva, Viva-e, Viva-S, XL-PALLAS			

miscellaneous				
1				
	Part No.	526473	Ref. No.	9001883
	description	O-ring thickness 2.5mm ID ø 12.5mm Qty 1 pcs		
For models:	LC, Plus, Prestige, Streamline-710, Streamline-940, Tempo, Viva, Viva-e, Viva-S, XL-Basic, XL-PALLAS			

sealing washers**copper gaskets**

DIN-7603-A				
1				
	Part No.	526461	Ref. No.	9007701
	description	flat gasket copper ED ø 22mm ID ø 17mm thickness 2mm Qty 1 pcs		
For models:	LC			

PTFE gaskets

1				
	Part No.	527638	Ref. No.	9211740
	description	flat gasket PTFE ED ø 12mm ID ø 10mm thickness 1mm Qty 1 pcs		
For models:	Mosaic			

1				
	Part No.	526013	Ref. No.	9005072
	description	flat gasket PTFE ED ø 22mm ID ø 17mm thickness 2mm Qty 1 pcs		
For models:	LC, Mosaic, Streamline-710, Streamline-940, Viva-e, Viva-S			

1				
	Part No.	526460	Ref. No.	9001720
	description	flat gasket PTFE ED ø 50mm ID ø 36mm thickness 2mm Qty 1 pcs		
For models:	LC, Streamline-710, Streamline-940, Tempo, Viva, Viva-e, Viva-S, XL-Basic, XL-PALLAS			



 <p>1</p>			
Part No.	526459	Ref. No.	9001824
description	flat gasket PTFE ED ø 62mm ID ø 42mm thickness 2mm Qty 1 pcs		
For models:	Mosaic		

special gaskets

group gaskets

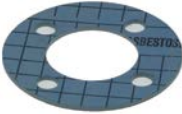
 <p>1</p>			
Part No.	526448	Ref. No.	9220013
description	gasket D1 ø 76mm D2 ø 39mm thickness 2mm hole distance 39mm FIBER		
For models:	Streamline-710, Streamline-940		

springs

compression springs

 <p>1</p>			
Part No.	526462	Ref. No.	9007705
description	compression spring ø 10.5mm L 31.5mm wire gauge ø 1.25mm		
For models:	LC, Plus, Prestige, Tempo, Viva-e, Viva-S, XL-PALLAS		

manometers

 <p>1</p>			
Part No.	541722	Ref. No.	9004720
description	manometer double scale ø 63mm pressure range 0-2.5 / 0-15bar connection on the backside thread 1/8" silver		
For models:	Mosaic, Streamline-710, Streamline-940, Viva-e, Viva-S, XL-PALLAS		

 <p>1</p>			
Part No.	541290	Ref. No.	541.290
description	manometer ø 51mm pressure range 0 up to 16bar thread 1/8" marking 9 connection on the backside		

 <p>1</p>			
Part No.	541289	Ref. No.	N/A
description	manometer ø 51mm pressure range 0 up to 3bar thread 1/8" marking 2.5 connection on the backside		

fastening material

screws

countersunk screws

 <p>1</p>			
Part No.	560215	Ref. No.	9001091 9211091
description	countersunk screw thread M5 L 14mm SS DIN 963/ISO 2009 Qty 20 pcs intake slotted head ø 9.2mm		
For models:	LC, Mosaic, Plus, Prestige, Streamline-710, Streamline-940, Viva, Viva-e, Viva-S, XL-Basic, XL-PALLAS		

cylinder head bolts

DIN 912/ISO 4762

 <p>1</p>			
Part No.	560025	Ref. No.	9001173
description	cylinder head bolt thread M4 thread L 10mm WS 3 SS Qty 20 pcs DIN 912/ISO 4762		
For models:	LC, Mosaic, Pilot, Plus, Prestige, Streamline-710, Streamline-940, Techno, Tempo, Viva, Viva-e, Viva-S, XL-Basic, XL-PALLAS		

grub screws

miscellaneous

 <p>1</p>			
Part No.	531119	Ref. No.	9201505
description	grub screw for boiler T1: 1/8" L 8mm SS Qty 1 pcs		
For models:	Mosaic, Viva-e, Viva-S		

GASTROPARTS.COM

