



GASTROPARTS

QualityEspresso-Futurmat

- [EN]** Equipment
- [DE]** Geräte
- [ES]** Aparatos
- [FR]** Équipement
- [IT]** Attrezzature
- [PL]** Urządzenia
- [RU]** Оборудование

✉ gastroparts@gastroparts.com

☎ +48 56 657 00 66

📘 fb.com/gastroparts.global



GASTROPARTS.COM







heating elements

heating elements for coffee machine

			
Part No.	417001	Ref. No.	02212439
description	heating element 2600W 230V heating circuits 2 mounting ø 42mm hole distance 74mm L 330mm W 30mm H 60mm L1 23mm L2 65mm L3 202mm H1 30mm H2 30mm hole ø 12mm tube ø 8.5mm thermostat sleeves ø 7mm length thermostat sleeves 195mm thermostat sleeve eccentric, non clinging number of thermostat sleeves 1 connection M6 immersion heater 2 hole flange		
accessories for	417001		
	Part No.	528002	Ref. No. —
	flat gasket PTFE ED ø 57mm ID ø 42mm thickness 3mm Qty 1 pcs equiv. no. 12001/W10470 suitable for		
	Part No.	528488	Ref. No. —
	flat gasket fibre ED ø 57mm ID ø 42mm thickness 3mm Qty 1 pcs		

			
Part No.	417290	Ref. No.	08024804
description	heating element 3000W 230V heating circuits 2 mounting ø 42mm hole distance 74mm L 250mm W 28mm H 65mm L1 20mm L2 40mm L3 190mm H1 30mm H2 35mm hole ø 10mm tube ø 8.5mm thermostat sleeves ø 7mm length thermostat sleeves 210mm number of thermostat sleeves 1 connection M4 immersion heater 2 hole flange		

			
Part No.	417108	Ref. No.	08148002
description	heating element 3500W 230V heating circuits 2 mounting ø 42mm hole distance 74mm L 380mm W 30mm H 50mm L1 25mm L2 70mm L3 275mm H1 25mm H2 25mm hole ø 10mm tube ø 8.5mm thermostat sleeves ø 7mm length thermostat sleeves 190mm thermostat sleeve not clinging number of thermostat sleeves 1 connection M4 immersion heater 2 hole flange		

			
Part No.	417105	Ref. No.	02212538
description	heating element 3700W 230V heating circuits 2 mounting ø 42mm hole distance 74mm L 530mm W 28mm H 50mm L1 30mm L2 75mm L3 400mm H1 25mm H2 25mm hole ø 9mm tube ø 8.4mm thermostat sleeves ø 7.5mm length thermostat sleeves 185mm thermostat sleeve eccentric, non clinging number of thermostat sleeves 1 connection M6 immersion heater 2 hole flange suitable for FAEMA		

			
Part No.	417289	Ref. No.	08335100
description	heating element 4600W 230V heating circuits 2 mounting ø 42mm hole distance 74mm L 565mm W 34mm H 70mm L1 20mm L2 40mm L3 505mm H1 30mm H2 40mm hole ø 10mm tube ø 8.3mm thermostat sleeves ø 7mm length thermostat sleeves 210mm thermostat sleeve centre number of thermostat sleeves 1 connection M4 immersion heater 2 hole flange		

accessories

hexagonal nuts

			
Part No.	361184	Ref. No.	05060680
description	nut thread 1/2" H 6mm nickel-plated brass WS 24 Qty 1 pcs		

sealing washers

O-rings

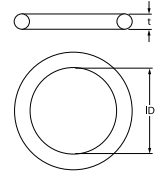
 			
Part No.	510893	Ref. No.	07763204
description	O-ring EPDM thickness 2.62mm ID ø 9.92mm Qty 1 pcs		

thermostats

bi-metal thermostats

bi-metal thermostats

			
Part No.	390319	Ref. No.	08368400
description	bi-metal thermostat hole distance 23.8mm switch-off temp. 80°C 1NC 1-pole 16A connection F6.3 2 hole fixing		

control and safety thermostats

EGO

safety thermostats

55.32_ series

			
Part No.	390324	Ref. No.	07476906
description	safety thermostat switch-off temp. 169°C 3-pole 3NC 20A probe ø 4mm probe L 128mm capillary pipe 890mm capillary pipe isolated 210/210mm gland nut probe SS		



various

safety thermostats



Part No.	375501	Ref. No.	08324600
description	safety thermostat switch-off temp. 172°C 1-pole 16A probe ø 3mm probe L 135mm capillary pipe 88mm capillary pipe isolated 80mm gland nut probe SS		

switches and momentary switches

rocker/momentary rocker switches

30x22mm



Part No.	301002	Ref. No.	07967010 07967020
description	rocker switch mounting measurements 30x22mm orange 2NO 250V 16A illuminated 0-I connection male faston 6.3mm ambient temperature max. 85/125°C protection IP65		
accessories for	301002		
	Part No.	301036	Ref. No. —
	protective cover internal size 30x22mm for rocker switch mounting measurementsmm		



Part No.	301001	Ref. No.	07967000
description	rocker switch mounting measurements 30x22mm red 2NO 250V 16A illuminated 0-I connection male faston 6.3mm ambient temperature max. 125/55°C protection IP65		
accessories for	301001		
	Part No.	301036	Ref. No. —
	protective cover internal size 30x22mm for rocker switch mounting measurementsmm		

labelled



Part No.	300125	Ref. No.	04001140 09000209
description	rocker switch mounting measurements 30x22mm green 2NO 230V 16A 0-I connection male faston 6.3mm ambient temperature max. 125/55°C protection IP65 with cover cap		
accessories for	300125		
	Part No.	301036	Ref. No. —
	protective cover internal size 30x22mm for rocker switch mounting measurementsmm		

microswitches

roller-lever actuated

microswitches



Part No.	345250	Ref. No.	04001130 09000208
description	microswitch with handle with a switch 250V 16A 1CO connection male faston 6.3mm L 27mm L1 36mm ambient temperature max. 125°C mounting distance 22mm type RL6-1-FGE-P12-5-L actuating force: 90g		

pin-plunger actuated



Part No.	527736	Ref. No.	10975704
description	microswitch 250V 16A 1CO connection male faston 4.8mm ambient temperature max. 125°C mounting distance 22mm with plunger blue/black		



Part No.	345105	Ref. No.	010957504
description	microswitch with plunger 250V 16A 1CO connection male faston 6.3mm L 28mm ambient temperature max. 125°C mounting distance 22mm type SM-51 actuating force: 280g black		

roller actuated

roller 90°



Part No.	345104	Ref. No.	07421605
description	microswitch with roller plunger 250V 16A 1CO connection male faston 6.3mm L 24mm ambient temperature max. 125°C thread L 12mm thread M10x0.75 mounting distance 22mm actuating force: 280g type EF83161.1		



rotary switches

GOTTAK



1

Part No.	345148	Ref. No.	07847908
description	rotary switch 3 0-1-2 sets of contacts 6 type 4RH 400V 10A shaft ø 4.8x6mm shaft L 21mm shaft oval connection male faston 6.3mm		

accessories

symbol labels



1

Part No.	347266	Ref. No.	08283301
description	symbol label 0-1 ø 60mm bore ø 7mm mounting distance 28mm		



1

Part No.	347265	Ref. No.	08283202 08336200
description	symbol label 0-1-heating off ø 53mm bore ø 7mm mounting distance 28mm		

lamps

indicator lights

indicator lights (complete)

ø 9mm



1

Part No.	359491	Ref. No.	08456900
description	indicator light ø 9mm clear connection plug cable length 33mm		

ø 10mm

with screw socket



1

Part No.	346881	Ref. No.	08329800
description	indicator light ø 10mm 230V red connection male faston 6.3mm		

with plug-in socket



1

Part No.	359486	Ref. No.	08478100
description	indicator light ø 10mm 250V red connection male faston 6.3mm cable length 400mm		

ø 12mm

with plug-in socket



1

Part No.	359043	Ref. No.	07847800
description	indicator light ø 12mm red 230V connection male faston 6.3mm temp.-resist. 120°C Qty 1 pcs		

ø 13mm

with plug-in socket



1

Part No.	359143	Ref. No.	07847820
description	indicator light ø 13mm yellow 230V connection male faston 6.3mm temp.-resist. 120°C Qty 1 pcs		

miscellaneous



1

Part No.	359490	Ref. No.	08428600
description	indicator lamp clear 230V connection male faston 6.3mm cable length 80mm ø 7mm		



1

Part No.	359489	Ref. No.	08428500
description	indicator light lens red ø 10.5mm		

LED

indicator lamps

miscellaneous



1

Part No.	359487	Ref. No.	08477800
description	indicator light LED mounting ø 10mm 250 red connection with plug 1W		



contactors

LOVATO

power contactors



1

Part No.	380964	Ref. No.	0651/060119
description	power contactor resistive load 20A 230VAC (AC3/400V) 9A/4kW main contacts 4NO auxiliary contacts connection screw connection type 11BG09T4A230		

solid state relays

miscellaneous



1

Part No.	403941	Ref. No.	08371300
description	solid state relay CARLO GAVAZZI 2 phase 40A 24-280V 5-15VDC L 58mm W 44mm male faston 6.3mm type RA2A23D40C		

relays

level relays

miscellaneous



1

Part No.	403445	Ref. No.	08386800
description	level controller 230V type		

transformers

open transformers

with plug connection



1

Part No.	402441	Ref. No.	04300660 09000222
description	transformer primary 230V secondary 8/18V 48VA secondary 0.6/2.4A connection male faston 6.3mm 50/60Hz		

toroidal core transformers



1

Part No.	402381	Ref. No.	08414800
description	transformer primary 220V secondary 30V 80VA connection male faston 6.3mm 50/60Hz		

probes

producer-specific probes

probes



1

Part No.	379464	Ref. No.	08370500
description	temperature probe NTC cable silicone probe -40 up to +110°C cable -50 up to +180°C connection coded plug thread 3/8" probe ø12x8mm cable length 0.5m		



1

Part No.	379461	Ref. No.	08370510
description	temperature probe NTC cable silicone probe -40 up to +110°C cable -50 up to +180°C connection plug thread 3/8" probe ø10x8mm cable length 0.5m		



sensors



1

Part No.	379467	Ref. No.	08417900
description	temperature probe set PTC probe L 26mm probe ø 5mm 2-group		



1

Part No.	379465	Ref. No.	08418000
description	temperature probe set PTC probe L 26mm probe ø 5mm 3-group		

electronics

EPROMS

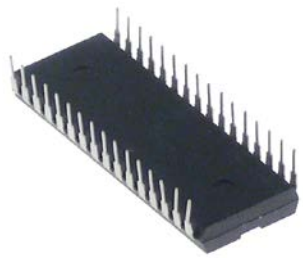

1

Part No.	402432	Ref. No.	09001278 43524660
description	EPROM type CP-A for coffee grinder CODE 09001278		

PCBs



1

Part No.	402783	Ref. No.	08331610 08372000
description	display espresso machine QUALITY ESPRESSO model new		



1

Part No.	402369	Ref. No.	08372010
description	display L 106mm W 48mm with keypad		



1

Part No.	402385	Ref. No.	08264301
description	display L 131mm W 47mm with keypad		



1

Part No.	402443	Ref. No.	08506200 09001263 43310420
description	PCB for coffee grinder suitable for QUALITY ESPRESSO		



1

Part No.	402363	Ref. No.	08406400
description	probe L 128mm W 106mm with keypad		

central units



1

Part No.	402357	Ref. No.	08363800 08363800/6
description	central unit 230V		



			
1			
Part No.	402361	Ref. No.	08363900 08363900/09
description	central unit 230V		

			
1			
Part No.	402356	Ref. No.	08220303 08220303/06
description	central unit 2-group 230V		

			
1			
Part No.	402358	Ref. No.	08351500 08351500/6
description	central unit 3-4-group 230V		

			
1			
Part No.	402359	Ref. No.	08371740
description	central unit 3-group 230V		

			
1			
Part No.	402362	Ref. No.	08371720
description	central unit 3-group 230V		

			
1			
Part No.	402360	Ref. No.	08455700
description	central unit 4-group 230V		

			
1			
Part No.	402368	Ref. No.	08414500
description	central unit temperature 24V		

			
1			
Part No.	400445	Ref. No.	08280307 08280307/09 08280307/6
description	control box 4-group for coffee machine		

keypads

front foils

			
1			
Part No.	526689	Ref. No.	08456700
description	front foil for indicator light L 50mm W 16mm		

			
1			
Part No.	402389	Ref. No.	08264509
description	front foil with keypad L 112mm W 36mm		

			
1			
Part No.	401434	Ref. No.	08109600
description	keypad foil coffee machine Arianne/Arieta 1-2-3-4 gr. L 92mm W 26mm buttons 5		

			
1			
Part No.	401433	Ref. No.	08274607
description	keypad foil coffee machine Ottima/Genova/Compac L 80mm W 44mm buttons 5		

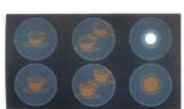
			
1			
Part No.	402386	Ref. No.	08272106
description	keypad foil grey L 80mm W 44mm buttons 5		



			
1			
Part No.	400442	Ref. No.	08274201
description	keypad foil L 80mm W 44mm buttons 5		

			
1			
Part No.	401432	Ref. No.	08274409
description	keypad foil L 80mm W 44mm buttons 5		

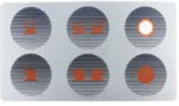
			
1			
Part No.	402387	Ref. No.	08221608
description	keypad foil silver L 80mm W 44mm buttons 5		

			
1			
Part No.	402388	Ref. No.	08323900
description	keypad foil suitable for GENOVA L 80mm W 44mm buttons 5		

membrane keypads

			
1			
Part No.	525549	Ref. No.	09001137 42923151
description	keypad foil for coffee grinder suitable for QUALITY ESPRESSO L 85mm W 62mm		

			
1			
Part No.	400447	Ref. No.	N/A
description	membrane keypad		

keypad units

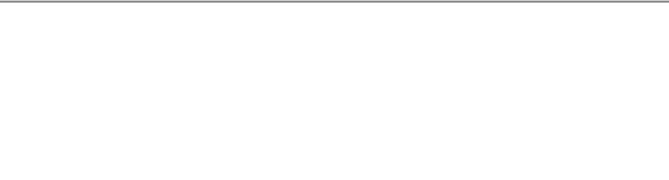
			
1			
Part No.	400440	Ref. No.	08272205 + 08274409
description	keypad unit		

			
1			
Part No.	402375	Ref. No.	08337000
description	keypad unit buttons 1 L 106mm W 50mm		

			
1			
Part No.	402382	Ref. No.	08332600
description	keypad unit buttons 1 L 50mm W 46mm		

			
1			
Part No.	402383	Ref. No.	08331900 08331910
description	keypad unit buttons 1 L 50mm W 46mm		

			
1			
Part No.	402384	Ref. No.	08373100
description	keypad unit buttons 1 L 50mm W 46mm Spezial		

1

Part No.	402366	Ref. No.	08405700
description	keypad unit buttons 1 red L 106mm W 76mm		



1

Part No.	402374	Ref. No.	08474500
description	keypad unit buttons 5 L 106mm W 50mm		



1

Part No.	402372	Ref. No.	08336900 08336910
description	keypad unit buttons 2 L 106mm W 50mm		



1

Part No.	402376	Ref. No.	08332200
description	keypad unit buttons 5 L 106mm W 50mm		



1

Part No.	402371	Ref. No.	08405800
description	keypad unit buttons 2 red L 106mm W 76mm		



1

Part No.	402377	Ref. No.	08330700
description	keypad unit buttons 5 L 106mm W 50mm		



1

Part No.	402378	Ref. No.	08234213
description	keypad unit buttons 5 black with LED suitable for ARIANNA, COMPAC L 142mm W 62mm with bush		



1

Part No.	402373	Ref. No.	08378400
description	keypad unit buttons 5 L 125mm W 50mm		



1

Part No.	402379	Ref. No.	08234205
description	keypad unit buttons 5 grey with LED suitable for ARIANNA, COMPAC L 142mm W 62mm with bush		



1

Part No.	402364	Ref. No.	08427600
description	keypad unit buttons 5 L 185mm W 70mm		



1

Part No.	402365	Ref. No.	08427610
description	keypad unit buttons 5 L 185mm W 70mm ECONOMY		



1

Part No.	400441	Ref. No.	08272205
description	keypad unit buttons 5 L 91mm W 51mm		



1

Part No.	402367	Ref. No.	08405620
description	keypad unit buttons 5 white L 106mm W 76mm		



1

Part No.	402380	Ref. No.	08109400 08211906
description	keypad unit coffee machine Arienne/Arieta 1-2-3-4 gr. buttons 5 L 110mm W 39mm		

solenoid valves

solenoid valves (water)

metal

PARKER

2-way

E-146 series



1

Part No.	370067	Ref. No.	N/A	
description	solenoid valve 2-ways 230VAC connection 1/4" L 40mm DN 3mm slide-on receptacle DIN -20° up to 130°C PARKER type series VE-146 coil type ZB09 membranes FKM (water) p max 7bar			
spare parts for	370067			
	Part No.	371029	Ref. No.	—
	solenoid coil PARKER 230VAC 9VA coil type ZB09 seat ø 14mm H 33mm W 34mm D 43mm			

accessories for 370067

	Part No.	371090	Ref. No.	—
	power socket plug type DIN 43650A screw			

compressors

CUBIGEL

accessories



1

Part No.	380913	Ref. No.	07985500
description	start relay MTRP3920 743 250V 8A		

motors

motors

for coffee grinders

complete



1



Part No.	525529	Ref. No.	09001132 09112400 42922200	
description	motor with belt pulley 24V 1 phase shaft ø 2mm type WRS-365SH-14134 ø 28mm L 32mm			
accessories for	525529			
	Part No.	525531	Ref. No.	09000302 09710320
	round belt for coffee grinder thickness 2.68mm ø 50.47mm			



1

Part No.	525530	Ref. No.	09001133 09112500 42922210	
description	motor with belt pulley ø 28mm L 32mm cable length 150mm cable colours red/orange			
accessories for	525530			
	Part No.	525531	Ref. No.	09000302 09710320
	round belt for coffee grinder thickness 2.68mm ø 50.47mm			



			
1			
Part No.	525528	Ref. No.	09001131 42922180
description	motor with belt pulley ø 28mm L 32mm cable length 250mm cable colours blue/yellow		
accessories for	525528		
	Part No.	525531	Ref. No. 09000302 09710320
	round belt for coffee grinder thickness 2.68mm ø 50.47mm		

condensators & interference suppression filters

starting capacitors

starting capacitors

			
1			
Part No.	365129	Ref. No.	07273006
description	starting capacitor 88-106µF 220V 50-60Hz duty cycle 3s with discharge resistor 12.80.2360 ø 46mm L 85mm plastic connection male faston 6.3mm		

operating capacitors

plastic

			
1			
Part No.	365127	Ref. No.	03203950 09000125
description	operating capacitor capacity 70µF 250V tolerance 5% 50Hz ambient temperature max. -25 to +85°C ø 45mm L 120mm M8 plastic connection male faston 6.3mm 16.18.39 protection		

metal

			
1			
Part No.	365128	Ref. No.	03203120 09000117
description	operating capacitor capacity 16µF 450V tolerance 5% 50-60Hz ambient temperature max. -25 to +85°C ø 40mm L 100mm M8 aluminium connection male faston 6.3mm 16.26.16 protection		

equipmentspecific units

filter holders

filter holders standard

filter holders (complete)

			
1			
Part No.	531173	Ref. No.	08485800
description	filter holder 1-way suitable for FUTURMAT complete number of wedges 2		

			
1			
Part No.	531174	Ref. No.	08485900
description	filter holder 2-way suitable for FUTURMAT complete number of wedges 2		

			
1			
Part No.	526729	Ref. No.	08480080 08486700
description	filter holder without filter suitable for QUALITY ESPRESSO mounting ø 83mm ID ø 61.5mm wedge height 10.4mm wedge position horizontal number of wedges 2		
accessories for	526729		
	Part No.	526699	Ref. No. 08366650
	filter holder spout thread 3/8" 1-way curved outlet distance 6mm		
	Part No.	526719	Ref. No. 08366750
	filter holder spout thread 3/8" 2-way curved outlet distance 55mm		



filter holders short



1

Part No.	529041	Ref. No.	08486680
description	filter holder mounting ø 82.5mm outlet 3/8" ID ø 62mm handle M12x1.75 wedge hight 10.5mm wedge position horizontal number of wedges 2 lever straight chrome-plated brass		



1

Part No.	531185	Ref. No.	08480050
description	filter holder mounting ø 83mm hole ø 17mm ID ø 62mm handle M12x1.75 wedge hight 10.5mm wedge position horizontal number of wedges 2 lever inclined chrome-plated brass		
accessories for	531185		
	Part No.	526699	Ref. No. 08366650
	filter holder spout thread 3/8" 1-way curved outlet distancemm		
	Part No.	526719	Ref. No. 08366750
	filter holder spout thread 3/8" 2-way curved outlet distance 55mm		
	Part No.	526733	Ref. No. 08480100
	screw connection thread 3/8" for outlet ø 25mm H 14mm chrome-plated brass		



1

Part No.	526785	Ref. No.	08486650 08486680
description	filter holder mounting ø 83mm hole ø 17mm ID ø 62mm handle M12x1.75 wedge hight 10.5mm wedge position horizontal number of wedges 2 lever straight chrome-plated brass		
accessories for	526785		
	Part No.	526699	Ref. No. 08366650
	filter holder spout thread 3/8" 1-way curved outlet distancemm		
	Part No.	526719	Ref. No. 08366750
	filter holder spout thread 3/8" 2-way curved outlet distance 55mm		
	Part No.	526733	Ref. No. 08480100
	screw connection thread 3/8" for outlet ø 25mm H 14mm chrome-plated brass		

handles

with bore



1

Part No.	526745	Ref. No.	08412010
description	handle ø 32mm L 123mm black L1 50mm		



1

Part No.	526746	Ref. No.	08412000
description	handle ø 33mm L 125mm grey L1 56mm		



1

Part No.	526751	Ref. No.	08335700
description	handle ø 35mm L 123mm black L1 44mm		



1

Part No.	529049	Ref. No.	08103600
description	handle ø 36mm aperture 13x13mm ID ø 9mm IT L 127mm black		

end caps



1

Part No.	526688	Ref. No.	08412300
description	end cap ø 25mm silver		



1

Part No.	526748	Ref. No.	08336000
description	end cap ø 32mm black		



1

Part No.	526744	Ref. No.	08412210
description	ring for handle ø 33mm black		



			
1			
Part No.	526747	Ref. No.	08412200
description	ring ø 33mm grey		

sleeves			
			
1			
Part No.	526675	Ref. No.	08412110
description	sleeve ø 34mm L 50mm black		

			
1			
Part No.	526749	Ref. No.	08412100
description	sleeve ø 35mm L 51mm grey		

			
1			
Part No.	526750	Ref. No.	08335900
description	sleeve ø 36mm L 40mm black		

screws			
			
1			
Part No.	529123	Ref. No.	05193800
description	cylinder head bolt thread M8 L 80mm thread L 30mm WS 6 SS Qty 1 pcs DIN 912/ISO 4762		

			
1			
Part No.	526793	Ref. No.	08335800
description	handle holder thread M12 L 76mm thread L 100mm zinc-coated steel		

spouts			
with thread 3/8"			
			
1			
Part No.	526699	Ref. No.	08366650
description	filter holder spout thread 3/8" 1-way curved outlet distance 10mm		

			
1			
Part No.	526719	Ref. No.	08366750
description	filter holder spout thread 3/8" 2-way curved outlet distance 55mm		

accessories			
			
1			
Part No.	526733	Ref. No.	08480100
description	screw connection thread 3/8" for outlet ø 25mm H 14mm chrome-plated brass		

brewing units			
shower screens			
with upstand			
			
1			
Part No.	526788	Ref. No.	02610004
description	shower screen ø 58mm H 17.5mm		

filter holder gaskets			
flat			
standard			
			
1			
Part No.	528030	Ref. No.	01652809
description	filter holder gasket D1 ø 72.7mm D2 ø 57.2mm H 8mm Qty 1 pcs		



brewing units with solenoid valve

filters

filters



1

Part No.	526738	Ref. No.	NT0029
description	filter set for brewing unit		

brewing units manual

components

drain units

drain pipes



1

Part No.	526786	Ref. No.	02010809
description	drain pipe thread M30x1.5 T1: 1/2" L 72mm chrome-plated brass WS 36		



1

Part No.	528534	Ref. No.	02010809
description	drain pipe thread M30x1.5 T1: 1/2" L 73mm WS 36 L1 21.5mm L2 36.5mm		



1

Part No.	528538	Ref. No.	02121002
description	end piece thread 1/2" int. ø 1 12mm int. ø 2 15mm L 36mm chrome-plated brass WS 26		

tap aerators



1

Part No.	526791	Ref. No.	02121101
description	tap aerator D1 ø 8mm D2 ø 14.5mm ID ø 6mm H 14.2mm 4 holes brass		

shafts



1

Part No.	528532	Ref. No.	02326106
description	shaft thread M4 square L 34mm W 6mm brass		

bushes



1

Part No.	528920	Ref. No.	01860402
description	bush D1 ø 15mm D2 ø 10.8mm ID ø 8mm H 30mm brass		



1

Part No.	526790	Ref. No.	02446300
description	filter support D1 ø 13mm ID ø 5mm int. ø 1 11mm H 9mm brass		

gaskets



1

Part No.	528494	Ref. No.	01954502
description	gasket rubber ED ø 13mm ID ø 4mm thickness 4mm Qty 1 pcs		

gasket supports



1

Part No.	528528	Ref. No.	01955103 02021608
description	gasket support ED ø 16mm ID ø 13mm H 13mm for gasket thread M3 brass L 13mm int. ø 1 13mm		



miscellaneous



1

Part No.	528530	Ref. No.	02211100
description	bolt square brass thread M3 L 11mm W 6mm H 6mm thread L 10mm		



1

Part No.	528531	Ref. No.	02211001
description	bolt square brass thread M3 L 12mm W 6mm H 6mm thread L 10mm		

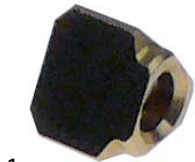

1

Part No.	526792	Ref. No.	02326007
description	nut triangle brass thread M3 L 6.2mm W 6.2mm H 6.2mm		



1

Part No.	528529	Ref. No.	04732202
description	plain washer ID ϕ 3.5mm ED ϕ 6.6mm thickness 0.5mm brass Qty 1 pcs		

nozzle holders



1

Part No.	528523	Ref. No.	02102309
description	nozzle holder thread M30x1.5 IT M16x1.5 IT 1 M6 ϕ 25.5mm int. ϕ 1 15.3mm int. ϕ 2 17.8mm L 66.5mm total length 82mm WS 36 chrome-plated brass		

accessories for



Part No.	525318	Ref. No.	—
description	shaft bearing suitable for FAEMA E61		



1

Part No.	526783	Ref. No.	02102300 02102309
description	nozzle holder thread M30x1.5 IT M16x1.5 IT 1 M8 ϕ 26mm int. ϕ 1 15mm int. ϕ 2 17.5mm L 66.5mm total length 82mm WS 36 chrome-plated brass		



1

Part No.	526782	Ref. No.	08299100
description	nozzle holder thread M8 int. ϕ 1 4mm int. ϕ 2 7mm L 12mm total length 18.5mm WS 8 brass		



1

Part No.	526781	Ref. No.	08299000
description	nozzle holder thread M8 int. ϕ 1 4mm int. ϕ 2 7mm L 42mm total length 48mm WS 8 brass		

springs



1

Part No.	528526	Ref. No.	02318400
description	compression spring ϕ 12.9mm L 41mm wire gauge ϕ 1.2mm		

filters



1

Part No.	526737	Ref. No.	NT0028
description	filter set for brewing unit E61		

camshafts



1

Part No.	528539	Ref. No.	01769702
description	camshaft shaft ϕ 8mm shaft intake ϕ 10mm L 79mm W 20.5mm H 17mm thread M6 brass		





1

Part No.	528527	Ref. No.	02102200
description	spindle shaft ϕ 4mm L 40mm thread M4 brass for cam shaft		



valves			
			
1			
Part No.	526736	Ref. No.	02022804
description	valve for outlet L 19.3mm ED ø 16mm brass		

			
1			
Part No.	526734	Ref. No.	02023000
description	valve L 58.2mm ED ø 16mm brass		

			
1			
Part No.	526735	Ref. No.	02022903
description	valve L 59.4mm triangle ED ø 16mm brass		

screw connections			
			
1			
Part No.	527802	Ref. No.	01878909
description	screw connection thread 1/2" int. ø 1 11mm int. ø 2 15mm L 9mm WS 24 chrome-plated brass		

			
1			
Part No.	526730	Ref. No.	02026300
description	screw connection thread M30x1.5 IT 1/2" ø 36mm int. ø 1 8mm int. ø 2 15mm L 26mm total length 38mm WS 26 chrome-plated brass		

			
1			
Part No.	526726	Ref. No.	01770601
description	stop bolt thread M6 ø 6.5mm total length 13mm SS		

components			
nozzles			
with thread			
			
1			
Part No.	528486	Ref. No.	02446706
description	nozzle bore ø 0.7mm thread M6x0.75 L 9mm WS 7		

without thread			
			
1			
Part No.	526732	Ref. No.	08298800
description	nozzle bore ø 0.65mm ø 7mm L 21mm		

screws			
			
1			
Part No.	560373	Ref. No.	05194402
description	cylinder head bolt thread M4 thread L 12mm WS 3 SS Qty 1 pcs intake internal hexagon DIN 912/ISO 4762		

screw connections			
			
1			
Part No.	528661	Ref. No.	02736403
description	end cap thread M12x1.5 L 18mm chrome-plated brass WS 16		

			
1			
Part No.	526724	Ref. No.	07557200
description	end cap thread M16x1.5 ID ø 10mm L 22mm chrome-plated brass WS 22		

			
1			
Part No.	527270	Ref. No.	02446201
description	end cap thread M16x1.5 ID ø 8.9mm L 21mm chrome-plated WS 22		



water dispersions

water dispersions

group 2



1

Part No.	526787	Ref. No.	02012904
description	water distributor ϕ 30mm hole ϕ 1.5mm H 15mm ET M10x1 grooves 6 1.5mm brass 2 holes perforation ϕ 1mm		

expansion valves



1

Part No.	529317	Ref. No.	N/A
description	expansion valve T1: 1/4" ET T2: 1/4" IT L 58mm		

gaskets



1

Part No.	526694	Ref. No.	07412109
description	gasket copper ED ϕ 30mm ID ϕ 21mm thickness 1.5mm		



1

Part No.	526692	Ref. No.	01853704
description	gasket ED ϕ 15mm seat ϕ 6mm H 4mm overall height 9mm		

gasket supports



1

Part No.	528769	Ref. No.	01853803
description	gasket support D1 ϕ 10.5mm D2 ϕ 17mm ID ϕ 6mm int. ϕ 1 15mm L 9mm brass		

compression springs



1

Part No.	526690	Ref. No.	00109108
description	compression spring ϕ 15mm L 27mm wire gauge ϕ 2.2mm		

with non-return valve



1

Part No.	529323	Ref. No.	07843808
description	expansion valve connection 3/8" with non-return valve		

drain pans

drain pans



1

Part No.	526697	Ref. No.	0271/050106 08478700
description	drain pan L 106mm W 76mm H 32mm hose ϕ 18mm		

aerators and air bleeders



1

Part No.	526780	Ref. No.	08178808
description	aerator and air bleeder screw connection 1/4"		

boilers

pipes



1

Part No.	526722	Ref. No.	07695604
description	aspiration tube tube ϕ 10mm pipe length 145mm T1: 1/4" T2: 1/4"		





			
1			
Part No.	526721	Ref. No.	08489000
description	aspiration tube tube ø 8mm pipe length 130mm T1: 1/4"		

heat exchangers

injector tubes

			
1			
Part No.	526739	Ref. No.	08489500
description	injector T1: 1/4"		





			
1			
Part No.	526740	Ref. No.	08355000
description	injector T1: 1/4" T2: 1/4"		





			
1			
Part No.	526720	Ref. No.	08362100
description	injector pipe tube ø 6mm pipe length 125mm T1: 1/4" T2: 1/4"		

steam/water taps

steam/water taps

steam/water taps

			
1			
Part No.	528427	Ref. No.	08204802
description	steam/water tap inlet 1/4" outlet 3/8" brass		
accessories for	528427		
	Part No.	510893	Ref. No. 07763204
	O-ring EPDM thickness 2.62mm ID ø 9.92mm Qty 1 pcs		
	Part No.	528184	Ref. No. 08165300
	compression spring ø 10.8mm L 25mm wire gauge ø 1.8mm		
	Part No.	528401	Ref. No. —
	flat gasket fibre ED ø 22mm ID ø 16mm thickness 2mm Qty 1 pcs		
	Part No.	528653	Ref. No. 08165508
	plain washer D1 ø 7mm D2 ø 14.5mm thickness 2mm brass		

accessories for	528427		
	Part No.	528654	Ref. No. 08165201
	bush D1 ø 15mm D2 ø 11mm H 7.7mm nylon ID ø 7mm		
	Part No.	529587	Ref. No.
	steam pipe		
	Part No.	529588	Ref. No. —
	steam pipe SS		
	Part No.	529589	Ref. No. —
	water pipe		

steam taps

steam taps (complete)

			
1			
Part No.	526775	Ref. No.	08493200
description	steam tap inlet 1/4" pipe length 150mm tube ø 8mm shaft 6mm		

			
1			
Part No.	526774	Ref. No.	08448400 08448440
description	steam tap inlet 1/4" pipe length 160mm tube ø 10mm shaft M6		

			
1			
Part No.	526725	Ref. No.	08165904
description	steam tap inlet 3/8" pipe length 150mm tube ø 8mm shaft 6mm		



			
1			
Part No.	526777	Ref. No.	08388700
description	steam tap mounting pos. left inlet 3/8" pipe length 150mm tube ø 10mm shaft M6		

			
1			
Part No.	526776	Ref. No.	08388600
description	steam tap mounting pos. right inlet 3/8" pipe length 150mm tube ø 10mm shaft M6		



components

shafts

			
1			
Part No.	526773	Ref. No.	11156530
description	shaft ø 14mm D2 ø 6mm L 85.5mm SS		

			
1			
Part No.	526772	Ref. No.	08389200
description	shaft ø 14mm D2 ø 7.6mm L 86mm thread M6 SS		

bushes

			
1			
Part No.	526010	Ref. No.	03001500
description	bush steam/water tap D1 ø 10.5mm D2 ø 9mm ID ø 6.3mm H 4.6mm brass		
accessories for	526010		
	Part No.	526005	Ref. No.
			—
			
	shaft steam tap ø 14.8mm L 92.5mm thread M6 brass		

gaskets

			
1			
Part No.	528648	Ref. No.	11181302
description	gasket D1 ø 12.2mm thickness 6mm		

springs

			
1			
Part No.	526789	Ref. No.	08389900
description	compression spring ø 11.3mm L 31mm wire gauge ø 1.5mm		

tap bodies

			
1			
Part No.	526762	Ref. No.	08165003
description	tap body T1: M16x1 T2: 3/8" T3: 1/4" L 49mm		

			
1			
Part No.	526763	Ref. No.	08493100
description	tap body T1: M16x1 T2: 3/8" T3: M12x1 L 49mm		

union nuts

			
1			
Part No.	526727	Ref. No.	08389800
description	nut thread M6 L 7.5mm WS 10		

washers

			
1			
Part No.	526695	Ref. No.	07413107
description	plain washer D1 ø 29mm D2 ø 22.6mm thickness 1.5mm brass		



			
1			
Part No.	528653	Ref. No.	08165508
description	plain washer D1 ø 7mm D2 ø 14.5mm thickness 2mm brass		

screw connections			
			
1			
Part No.	526761	Ref. No.	07358609
description	screw connection T1: M16x1 L 66mm ID ø 12mm WS 26 brass		

water taps			
			
1			
Part No.	526691	Ref. No.	08493300
description	water tap inlet 1/4" pipe length 60mm tube ø 10mm shaft 6mm		

			
1			
Part No.	526693	Ref. No.	08205908
description	water tap inlet 3/8" pipe length 60mm tube ø 10mm shaft 6mm		

			
1			
Part No.	526760	Ref. No.	08340400
description	water tap with water pipe inlet 1/4" pipe length 84mm tube ø 10mm		

steam/water pipes			
steam pipes			
			
1			
Part No.	529587	Ref. No.	08165722+08165110+08207400
description	steam pipe		

			
1			
Part No.	526769	Ref. No.	08341400
description	steam pipe H 100mm W 80mm tube ø 8mm SS		

			
1			
Part No.	526779	Ref. No.	08448540
description	steam pipe thread 1/2" H 180mm 1-2 group tube ø 10mm cable length 1000mm		

			
1			
Part No.	526778	Ref. No.	08448550
description	steam pipe thread 1/2" H 180mm 3-4 group tube ø 10mm with probe cable length 1400mm		

			
1			
Part No.	526768	Ref. No.	08340300
description	steam pipe thread M10x1 L 170mm W 105mm tube ø 10mm SS		



			
1			
Part No.	526767	Ref. No.	08165722
description	steam pipe thread M8x1 L 140mm W 80mm tube ø 8mm SS		

nozzles for steam pipes

			
1			
Part No.	526765	Ref. No.	08391900
description	nozzle thread M10x1 ø 15mm L 22mm 4 holes bore ø 1.25mm SS		

			
1			
Part No.	526764	Ref. No.	08207400
description	nozzle thread M8x1 ø 13mm L 22mm 4 holes bore ø 1.25mm SS		

nozzles for water pipes

tap aerators

			
1			
Part No.	529608	Ref. No.	09000325
description	tap aerator D1 ø 23mm H 15mm thread M22x1		

accessories

bushes

			
1			
Part No.	526797	Ref. No.	08397800
description	bush D1 ø 14.5mm D2 ø 10.8mm H 7.7mm PTFE ID ø 7mm		

			
1			
Part No.	528654	Ref. No.	08165201
description	bush D1 ø 15mm D2 ø 11mm H 7.7mm nylon ID ø 7mm		

gaskets

			
1			
Part No.	510893	Ref. No.	07763204
description	O-ring EPDM thickness 2.62mm ID ø 9.92mm Qty 1 pcs		

springs

			
1			
Part No.	528184	Ref. No.	08165300
description	compression spring ø 10.8mm L 25mm wire gauge ø 1.8mm		

tube handles

			
1			
Part No.	526743	Ref. No.	09000586
description	tube handle for pipe ø 10mm ø 15mm L 28mm silicone		

			
1			
Part No.	526742	Ref. No.	08339100 08339100P
description	tube handle for pipe ø 10mm ø 15mm L 50mm rubber		

			
1			
Part No.	526741	Ref. No.	08339000
description	tube handle for pipe ø 8mm ø 12.5mm L 50mm rubber		

union nuts

			
1			
Part No.	526766	Ref. No.	08165110 08165130+0847990
description	union nut thread 3/8" L 34mm hole ø 12mm		

fine filters

			
1			
Part No.	528326	Ref. No.	N/A
description	fine filter flat ø 11.2mm		

			
1			
Part No.	529911	Ref. No.	02435808
description	fine filter flat ø 11mm H 0.25mm		



			
1			
Part No.	526731	Ref. No.	08298700
description	fine filter ø 8.5mm H 15mm for brewing unit stainless steel		

intake valves

intake valves

			
1			
Part No.	529524	Ref. No.	07466006
description	intake valve water inlet 1/4" outlet 1/4" 3/8"		

accessories

gaskets

			
1			
Part No.	528596	Ref. No.	02932200
description	gasket ED ø 12mm ID ø 4mm overall height 4mm conical		

gasket supports

			
1			
Part No.	526771	Ref. No.	03059003
description	gasket support D1 ø 6mm D2 ø 16mm int. ø 1 3mm H 6.8mm plastic		

valves

			
1			
Part No.	526770	Ref. No.	07665409
description	valve L 66mm ED ø 17mm		

level glasses

level glasses

gaskets

			
1			
Part No.	526696	Ref. No.	08367000
description	gasket D1 ø 11mm D2 ø 8mm H 10mm		

level glasses (complete)

			
1			
Part No.	526698	Ref. No.	08181505 08181604
description	water level tube L 180mm W 72mm ø 11mm thread 1/2"		

level glass pipes

			
1			
Part No.	529367	Ref. No.	08181703
description	water level tube ø 11mm H 108mm		

non-return valves

compression springs

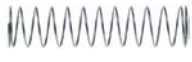
			
1			
Part No.	526723	Ref. No.	01720606
description	compression spring ø 7.8mm L 34mm wire gauge ø 0.4mm		

grinding burrs

grinding burrs straight

standard

			
1			
Part No.	527224	Ref. No.	00896209
description	grinding burrs pair turn direction left D1 ø 54mm ID ø 31mm H 8mm tooth spacing 3.5mm hole ø 4.5mm bore ø 6.5mm mounting ø 45 straight suitable for FAEMA (FP)		





			
1			
Part No.	525533	Ref. No.	09000298 (Standard)
description	grinding burrs pair turn direction left D1 ø 64mm ID ø 37mm H 9mm tooth spacing 3mm hole ø 5.6mm bore ø 8.5mm mounting ø 50		

TITAN			
			
1			
Part No.	523039	Ref. No.	09000298 09710020
description	grinding burrs pair titanium turn direction left D1 ø 64mm ID ø 37mm H 8.5mm tooth spacing 3mm hole ø 5.6mm bore ø 8.5mm mounting ø 50		

screws			
			
1			
Part No.	525562	Ref. No.	04148219
description	screw thread M4 thread L 8mm head ø 5.5mm head thickness 3mm		

			
1			
Part No.	525561	Ref. No.	04148110
description	screw thread M5 thread L 8mm head ø 7mm head thickness 3.5mm		

spillage trays			
			
1			
Part No.	525548	Ref. No.	09000546 11025311
description	drain tray L 240mm W 170mm for coffee grinder		

miscellaneous			
			
1			
Part No.	525543	Ref. No.	09000548 11025331
description	bezel L 142mm plastic		

			
1			
Part No.	525558	Ref. No.	2600/010133
description	equipment foot ø 29mm L 12mm rubber for coffee grinder		

			
1			
Part No.	525546	Ref. No.	09103400
description	flap left plastic		

			
1			
Part No.	525545	Ref. No.	09103300
description	flap right plastic		

			
1			
Part No.	111286	Ref. No.	09000299 09710030
description	knob spring L 20.3mm W 9.5mm H 12.5mm		

			
1			
Part No.	525539	Ref. No.	09000421 10012690
description	pin for stop ø 4mm L 15mm		

			
1			
Part No.	525541	Ref. No.	09000547 11025321
description	protector L 58mm plastic		

			
1			
Part No.	800014	Ref. No.	08290900
description	puller for knob ø 59mm H 21.5mm ID ø 35mm plastic		

			
1			
Part No.	525542	Ref. No.	09000739 19019650
description	retainer clip L 42mm		

			
1			
Part No.	525531	Ref. No.	09000302 09710320
description	round belt for coffee grinder thickness 2.68mm ø 50.47mm		



1			
Part No.	525552	Ref. No.	09000682 12001840
description	spring for stop ø 4mm L 15mm		

dosing containers

dosing container lids

			
1			
Part No.	525557	Ref. No.	00882506
description	lid for dosing container mounting ø 114mm ø 124mm plastic		

springs

group 1

			
1			
Part No.	525560	Ref. No.	00883603
description	tension spring for lever L1 12mm L2 17mm L3 12mm ø 14mm wire gauge ø 1.3mm		

levers



levers

			
1			
Part No.	525559	Ref. No.	07147804
description	lever for dosing container hole ø 20mm L 130mm metal		

coffee presses

components

holders

				
1				
Part No.	525534	Ref. No.	09000562 09000564 11025461 11025464	
description	bracket for coffee press aluminium L 80mm			
accessories for	525534			
	Part No.	525535	Ref. No.	09000948 41105851
coffee press ø 57mm H 16mm thread M4 plastic				
	Part No.	525536	Ref. No.	09000053
screw for coffee press thread M4 L 20mm				

accessories for	525534			
	Part No.	525537	Ref. No.	09001136 42923051
coffee press ø 52mm H 19mm thread M4 plastic				

pressers

				
1				
Part No.	525537	Ref. No.	09001136 42923051	
description	coffee press ø 52mm H 19mm thread M4 plastic			

				
1				
Part No.	525535	Ref. No.	09000948 41105851	
description	coffee press ø 57mm H 16mm thread M4 plastic			

screws

				
1				
Part No.	525536	Ref. No.	09000053	
description	screw for coffee press thread M4 L 20mm			

adjustment mechanism

setting rings

				
1				
Part No.	525540	Ref. No.	09000543 11025280	
description	setting ring for coffee grinder ø 85mm ID ø 54mm H 17mm plastic			

				
1				
Part No.	525554	Ref. No.	01314608	
description	setting ring mounting ø 88mm ø 125mm ID ø 52mm H 54mm			



coffee beans containers

container lids



1

Part No.	525547	Ref. No.	09000549
-----------------	--------	-----------------	----------

description	lid for coffee beans container L 280mm W 190mm		
--------------------	--	--	--

coffee beans containers



1

Part No.	525527	Ref. No.	09001108 09102700
-----------------	--------	-----------------	----------------------

description	coffee beans container with lid L 280mm W 190mm H 180mm seat ø 51mm		
--------------------	---	--	--

spare parts for	525527		
------------------------	--------	--	--



Part No.	525547	Ref. No.	09000549
-----------------	--------	-----------------	----------

lid for coffee beans container L 280mm W 190mm

support for filter holder



1

Part No.	525550	Ref. No.	09000789 31095450
-----------------	--------	-----------------	----------------------

description	filter holder support large SS		
--------------------	--------------------------------	--	--



1

Part No.	525551	Ref. No.	09001130 42922151
-----------------	--------	-----------------	----------------------

description	filter holder support standard plastic		
--------------------	--	--	--



1

Part No.	530888	Ref. No.	09111200
-----------------	--------	-----------------	----------

description	filter holder support standard steel		
--------------------	--------------------------------------	--	--

manifolds



1

Part No.	525544	Ref. No.	09001201
-----------------	--------	-----------------	----------

description	manifold 2-way L 230mm plastic for coffee grinder		
--------------------	---	--	--

spare parts for	525544		
------------------------	--------	--	--



Part No.	525542	Ref. No.	09000739 19019650
-----------------	--------	-----------------	----------------------

retainer clip L 42mm

knobs

steam/water taps

steam/water taps



1

Part No.	111305	Ref. No.	08183311
-----------------	--------	-----------------	----------

description	knob ø 42mm shaft ø 6x5mm shaft flat on both sides black		
--------------------	--	--	--



1

Part No.	111307	Ref. No.	08099700
-----------------	--------	-----------------	----------

description	knob ø 42mm shaft ø 6x5mm shaft flat on both sides black		
--------------------	--	--	--





1

Part No.	111098	Ref. No.	08183303
-----------------	--------	-----------------	----------

description	knob ø 42mm shaft ø 6x5mm shaft flat on both sides grey		
--------------------	---	--	--





			
1			
Part No.	111063	Ref. No.	08185911
description	knob ø 50mm black		

			
1			
Part No.	111020	Ref. No.	07678709 08225401
description	knob zero mark white ø 38mm shaft ø 6x5mm shaft flat on both sides black		

			
1			
Part No.	530623	Ref. No.	PZ901788
description	turning handle ø 48mm L 43mm shaft ø 23mm black		

			
1			
Part No.	526757	Ref. No.	08411410
description	turning handle ø 50mm shaft ø 23.5mm black		

			
1			
Part No.	526756	Ref. No.	08411400
description	turning handle ø 50mm shaft ø 23.5mm grey		

			
1			
Part No.	526755	Ref. No.	08335400
description	turning handle ø 51mm shaft ø 24mm black		

knob dial plates

			
1			
Part No.	526752	Ref. No.	08389500
description	cam disc ø 17.5mm L 10mm fixed		

			
1			
Part No.	526753	Ref. No.	08389600
description	cam disc ø 24mm L 15mm mobile		

			
1			
Part No.	526754	Ref. No.	08389710
description	coupling ø 45mm L 35mm		

			
1			
Part No.	526758	Ref. No.	08389700
description	coupling ø 45mm L 35mm		

			
1			
Part No.	528760	Ref. No.	08185804
description	knob adapter ø 45mm L 43mm		

			
1			
Part No.	111113	Ref. No.	08147804
description	knob dial plate steam ø 15mm		

			
1			
Part No.	111114	Ref. No.	08147903
description	knob dial plate water ø 15mm		

			
1			
Part No.	111103	Ref. No.	08100000
description	knob dial plate water t.max. 12°C		

			
1			
Part No.	526759	Ref. No.	08411500
description	sign for handle ø 47mm L 4mm		

accessories

			
1			
Part No.	111273	Ref. No.	09000277
description	cotter pin ø 1.3mm L 25mm		



miscellaneous



1

Part No.	111303	Ref. No.	08411610
-----------------	--------	-----------------	----------

description	knob ø 42mm W 25mm black
--------------------	--------------------------



1

Part No.	111302	Ref. No.	08411600
-----------------	--------	-----------------	----------

description	knob ø 42mm W 25mm grey
--------------------	-------------------------

accessories for	111302
------------------------	--------



Part No.	111301	Ref. No.	08411700
-----------------	--------	-----------------	----------

description	sign ø 38mm
--------------------	-------------



1

Part No.	525538	Ref. No.	09000537 11025211
-----------------	--------	-----------------	----------------------

description	knob shaft ø 8x7 black plastic
--------------------	--------------------------------



1

Part No.	111304	Ref. No.	08336100
-----------------	--------	-----------------	----------

description	knob zero mark ø 42mm L 24mm black
--------------------	------------------------------------

accessories

button springs



1

Part No.	111286	Ref. No.	09000299 09710030
-----------------	--------	-----------------	----------------------

description	knob spring L 20.3mm W 9.5mm H 12.5mm
--------------------	---------------------------------------

covers



1

Part No.	111301	Ref. No.	08411700
-----------------	--------	-----------------	----------

description	sign ø 38mm
--------------------	-------------

rosettes



1

Part No.	111306	Ref. No.	08099500
-----------------	--------	-----------------	----------

description	rosette for filling valve knob ø 42mm ø 55mm black
--------------------	--



1

Part No.	111069	Ref. No.	08099518
-----------------	--------	-----------------	----------

description	rosette for filling valve knob ø 42mm ø 55mm grey
--------------------	---

handles and hand wheels

lever handles



1

Part No.	528658	Ref. No.	08111200
-----------------	--------	-----------------	----------

description	lever handle plastic black shaft 6.5x6.5mm
--------------------	--

equipment feet and end caps

equipment feet with stem



1

Part No.	525558	Ref. No.	2600/010133
-----------------	--------	-----------------	-------------

description	equipment foot ø 29mm L 12mm rubber for coffee grinder
--------------------	--



gaskets

O-rings

EPDM

ø2.62mm



Part No.	529412	Ref. No.	08291007
description	O-ring EPDM thickness 2.62mm ID ø 10.78mm Qty 1 pcs		



Part No.	528487	Ref. No.	07763204
description	O-ring EPDM thickness 2.62mm ID ø 9.19mm Qty 1 pcs		



Part No.	510893	Ref. No.	07763204
description	O-ring EPDM thickness 2.62mm ID ø 9.92mm Qty 1 pcs		

silicone

ø2.00mm

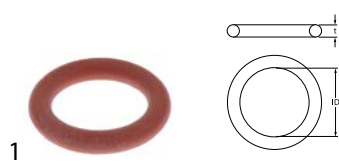

Part No.	532716	Ref. No.	NM01.057
description	O-ring silicone thickness 2mm ID ø 5mm Qty 10 pcs		



Part No.	532715	Ref. No.	140320459
description	O-ring silicone thickness 2mm ID ø 8mm Qty 10 pcs		

Viton

ø1.50mm

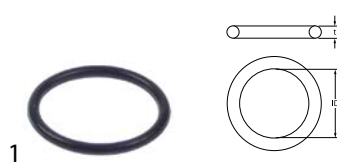

Part No.	525532	Ref. No.	08494700
description	O-ring Viton thickness 1.5mm ID ø 14mm Qty 1 pcs		

ø1.78mm



Part No.	528687	Ref. No.	0371/040103
description	O-ring Viton thickness 1.78mm ID ø 3.69mm Qty 1 pcs		



Part No.	101526	Ref. No.	03070802
description	O-ring Viton thickness 1.78mm ID ø 4.48mm Qty 1 pcs		

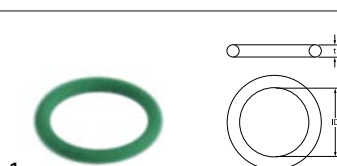

Part No.	529476	Ref. No.	07851900
description	O-ring Viton thickness 1.78mm ID ø 9.25mm Qty 1 pcs		

ø2.00mm

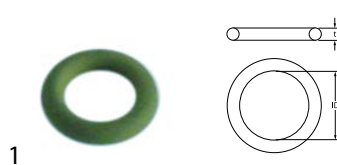

Part No.	528649	Ref. No.	02476703
description	O-ring Viton thickness 2mm ID ø 6mm Qty 1 pcs		

ø3.53mm

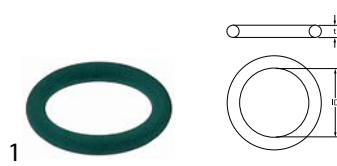

Part No.	528525	Ref. No.	02019701
description	O-ring Viton thickness 3.53mm ID ø 18.64mm Qty 1 pcs		

mechanical components, equipment accessories



sealing washers

rubber gaskets



1

Part No.	528494	Ref. No.	01954502
description	gasket rubber ED ø 13mm ID ø 4mm thickness 4mm Qty 1 pcs		



1

Part No.	528495	Ref. No.	10257608
description	gasket rubber ED ø 16mm ID ø 8mm thickness 4mm Qty 1 pcs		

copper gaskets

DIN-7603-A



1

Part No.	528197	Ref. No.	07411705
description	flat gasket copper ED ø 10mm ID ø 6mm thickness 1mm Qty 1 pcs		



1

Part No.	528662	Ref. No.	07411507
description	flat gasket copper ED ø 16mm ID ø 12mm thickness 1.5mm		



1

Part No.	529361	Ref. No.	01626804
description	flat gasket copper ED ø 18mm ID ø 13.5mm thickness 1.5mm for thread 1/4"		



1

Part No.	528660	Ref. No.	07412208
description	flat gasket copper ED ø 21mm ID ø 17mm thickness 1.5mm suitable for 3/8"		



1

Part No.	526694	Ref. No.	07412109
description	gasket copper ED ø 30mm ID ø 21mm thickness 1.5mm		

DIN-7603-C



1

Part No.	528520	Ref. No.	02455103
description	gasket copper ED ø 22mm ID ø 16mm thickness 2mm		



1

Part No.	529360	Ref. No.	02455202
description	gasket copper ED ø 26.1mm ID ø 21mm thickness 2.1mm for thread 1/2"		

PTFE gaskets



1

Part No.	528945	Ref. No.	05132808
description	flat gasket PTFE ED ø 22mm ID ø 16mm thickness 1.5mm Qty 1 pcs equiv. no. W10309 suitable for ESPRESSA, WEGA		



1

Part No.	526795	Ref. No.	05132900
description	flat gasket PTFE ED ø 36mm ID ø 30.2mm thickness 1.5mm Qty 1 pcs		

special gaskets

group gaskets



1

Part No.	526794	Ref. No.	08150203
description	group gasket L 78mm W 72mm thickness 1mm aperture 65x24mm hole distance 58mm		



springs

compression springs

1 

Part No.	528184	Ref. No.	08165300
description	compression spring ø 10.8mm L 25mm wire gauge ø 1.8mm		

1 

Part No.	526789	Ref. No.	08389900
description	compression spring ø 11.3mm L 31mm wire gauge ø 1.5mm		

1 

Part No.	528526	Ref. No.	02318400
description	compression spring ø 12.9mm L 41mm wire gauge ø 1.2mm		

1 

Part No.	528533	Ref. No.	02054609
description	compression spring ø 14.6mm L 43mm wire gauge ø 1.4mm		

1 

Part No.	528475	Ref. No.	01784909
description	compression spring ø 14.7mm L 33mm wire gauge ø 2mm		

1 

Part No.	528542	Ref. No.	01854306
description	compression spring ø 15mm L 27mm wire gauge ø 1.8mm windings 5		

1 

Part No.	526690	Ref. No.	00109108
description	compression spring ø 15mm L 27mm wire gauge ø 2.2mm		

1 

Part No.	528758	Ref. No.	08018707
description	compression spring ø 29.6mm L 28mm wire gauge ø 1.5mm		

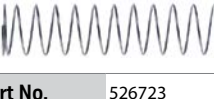
1 

Part No.	526723	Ref. No.	01720606
description	compression spring ø 7.8mm L 34mm wire gauge ø 0.4mm		

1 

Part No.	528521	Ref. No.	02446409
description	compression spring ø 8.3mm L 19mm wire gauge ø 0.9mm windings 5		

tension springs

1 

Part No.	525560	Ref. No.	00883603
description	tension spring for lever L1 12mm L2 17mm L3 12mm ø 14mm wire gauge ø 1.3mm		

manometers

1 

Part No.	541709	Ref. No.	08385000
description	manometer double scale ø 60mm pressure range 0-2.5 / 0-16bar connection on the backside thread 1/8"		

1 

Part No.	541710	Ref. No.	08339500
description	manometer double scale ø 60mm pressure range 0-2.5 / 0-16bar connection on the backside thread 1/8"		



Part No.	541711	Ref. No.	08405500
description	manometer double scale ø 60mm pressure range 0-2.5 / 0-16bar connection on the backside thread 1/8"		



Part No.	541713	Ref. No.	08130600
description	manometer double scale ø 60mm pressure range 0-2.5 / 0-16bar connection on the backside thread 1/8"		



Part No.	541712	Ref. No.	08323500
description	manometer pressure range 0-2.5bar ø 60mm connection 1/8" marking 0.7-1		

dosing pumps

accessories

hose couplings

metal



Part No.	361184	Ref. No.	05060680
description	nut thread 1/2" H 6mm nickel-plated brass WS 24 Qty 1 pcs		

hoses

industrial hoses

PTFE hoses

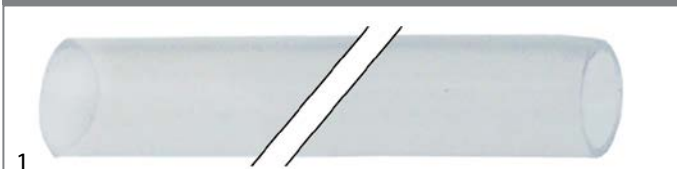

Part No.	520479	Ref. No.	67615610080
description	PTFE hose ED ø 10mm ID ø 8mm thickness 1mm L 1000mm		

tools

cleaning tools

brushes

pipe brushes

nylon



Part No.	802400	Ref. No.	09000410 09716130
description	brush nylon ø 30mm total length 480mm brush length 110mm		

fastening material

screws

cylinder head bolts

DIN 912/ISO 4762



Part No.	560373	Ref. No.	05194402
description	cylinder head bolt thread M4 thread L 12mm WS 3 SS Qty 1 pcs intake internal hexagon DIN 912/ISO 4762		



Part No.	560031	Ref. No.	05194006
description	cylinder head bolt thread M6 thread L 10mm WS 5 SS Qty 20 pcs DIN 912/ISO 4762		



Part No.	529123	Ref. No.	05193800
description	cylinder head bolt thread M8 L 80mm thread L 30mm WS 6 SS Qty 1 pcs DIN 912/ISO 4762		

nuts

cap nuts



Part No.	560137	Ref. No.	08115600
description	cap nuts thread M6 WS 10 SS Qty 20 pcs DIN/ISO DIN 1587		



hexagonal nuts

hexagonal nuts inch thread

1 

Part No.	361184	Ref. No.	05060680
description	nut thread 1/2" H 6mm nickel-plated brass WS 24 Qty 1 pcs		

1 

Part No.	511472	Ref. No.	04531505
description	nut thread 3/8" H 4mm brass WS 21 Qty 1 pcs		

washers

washers

DIN 9021

1 

Part No.	560398	Ref. No.	07414501
description	plain washer ID ø 6.5mm ED ø 22mm thickness 1.5mm SS Qty 1 pcs		

miscellaneous

1 

Part No.	560399	Ref. No.	07412509
description	plain washer ID ø 21.5mm ED ø 32mm thickness 0.5mm SS Qty 1 pcs		

1 

Part No.	528529	Ref. No.	04732202
description	plain washer ID ø 3.5mm ED ø 6.6mm thickness 0.5mm brass Qty 1 pcs		

1 

Part No.	526728	Ref. No.	04711701
description	plain washer ID ø 6.5mm ED ø 14.5mm thickness 1mm brass Qty 1 pcs		

1 

Part No.	528522	Ref. No.	04715801
description	plain washer ID ø 6.7mm ED ø 10.8mm thickness 1mm brass Qty 1 pcs		

1 

Part No.	525884	Ref. No.	07414300
description	plain washer ID ø 8mm ED ø 16mm thickness 1.5mm brass Qty 1 pcs		

tooth lock washers

DIN 6798A

1 

Part No.	560127	Ref. No.	09000067 7568603
description	tooth lock washer ID ø 6.2mm ED ø 11mm SS DIN/ISO DIN 6798A Qty 20 pcs for thread M6		

1 

Part No.	560128	Ref. No.	07568702
description	tooth lock washer ID ø 8.3mm ED ø 15mm SS DIN/ISO DIN 6798A Qty 20 pcs for thread M8		

fasteners

cotter pins

1 

Part No.	111273	Ref. No.	09000277
description	cotter pin ø 1.3mm L 25mm		

1 

Part No.	695209	Ref. No.	05160007
description	cotter pin ø 2mm L 20mm SS		

GASTROPARTS.COM

