



GASTROPARTS

Pizza-Group

- [EN]** Equipment
- [DE]** Geräte
- [ES]** Aparatos
- [FR]** Équipement
- [IT]** Attrezzature
- [PL]** Urządzenia
- [RU]** Оборудование

✉ gastroparts@gastroparts.com

☎ tel. +48 56 657 00 66

📘 fb.com/gastroparts.global

GASTROPARTS.COM





heating elements

heating elements for pizza ovens

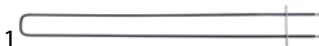

Part No.	417632	Ref. No.	5592000 A87RZ65054
description	heating element 400W 230V L 695mm W 60mm flange length 100mm flange width 22mm hole distance 87mm tube ø 6.5mm heating circuits 1		





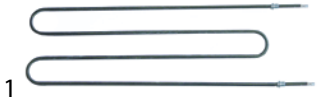

Part No.	420060	Ref. No.	5592031 A87RZ65057
description	heating element 820W 230V L 1047mm W 60mm flange length 100mm flange width 23mm hole distance 86mm connection male faston 6.3mm vertical tube ø 6.3mm heating circuits 1 hole ø 5mm for pizza oven		

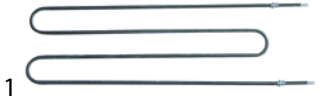





Part No.	418819	Ref. No.	5591410 5591411 5591450 5591460 A87RZ65046
description	heating element 1200W 230V L 645mm W 220mm thread 1/4" mounting distance 211mm connection length 92mm tube ø 8.5mm heating circuits 1 dry heating element		
For models:	FG 1/6090 A, FG 1/6090 R, FG 2/6090 A, FG 2/6090 R, FGM 1/6090 A, FGM 1/6090 R, FGM 2/6090 A, FGM 2/6090 R, FGMS 1/6090 A, FGMS 1/6090 R, FGMS 2/6090 A, FGMS 2/6090 R, FGS 1/6090 A, FGS 1/6090 R, FGS 2/6090 A, FGS 2/6090 R		



Part No.	416565	Ref. No.	5591400
description	heating element 1270W 400V L 650mm W 215mm thread 1/4" mounting distance 206mm connection length 81mm connection male faston 6.3mm tube ø 8.5mm heating circuits 1 dry heating element mounting pos. upper 2 hole fixing		
For models:	FG 1/6090 A, FG 1/6090 R, FG 2/6090 A, FG 2/6090 R, FGM 1/6090 A, FGM 1/6090 R, FGM 2/6090 A, FGM 2/6090 R, FGMS 1/6090 A, FGMS 1/6090 R, FGMS 2/6090 A, FGMS 2/6090 R, FGS 1/6090 A, FGS 1/6090 R, FGS 2/6090 A, FGS 2/6090 R		
accessories for	416565		
	Part No.	361182	Ref. No. —
	nut thread 1/4" H 5mm nickel-plated brass WS 17 Qty 1 pcs		
	Part No.	510417	Ref. No. —
	flat gasket fibre ED ø 20mm ID ø 14mm thickness 2mm Qty 1 pcs		
	Part No.	520228	Ref. No. —
	tooth lock washer ID ø 15.3mm ED ø 24mm steel Qty 1 pcs for thread M14		
	Part No.	550262	Ref. No. —
	flat gasket copper ED ø 20mm ID ø 14mm thickness 2mm		



Part No.	416567	Ref. No.	5591870 A87RZ65052 A87RZ65053
description	heating element 1340W 230V L 972mm W 220mm thread 1/4" mounting distance 112mm connection length 80mm connection male faston 6.3mm tube ø 8.5mm heating circuits 1 dry heating element 2 hole fixing		
For models:	FG 1/9060 A, FG 1/9060 R, FG 2/9060 A, FG 2/9060 R, FGM 1/9060 A, FGM 1/9060 R, FGM 2/9060 A, FGM 2/9060 R, FGMS 1/9060 A, FGMS 1/9060 R, FGMS 2/9060 A, FGMS 2/9060 R, FGS 1/9060 A, FGS 1/9060 R, FGS 2/9060 A, FGS 2/9060 R		
spare parts for	416567		
	Part No.	510417	Ref. No. —
	flat gasket fibre ED ø 20mm ID ø 14mm thickness 2mm Qty 1 pcs		
accessories for	416567		
	Part No.	361182	Ref. No. —
	nut thread 1/4" H 5mm nickel-plated brass WS 17 Qty 1 pcs		
	Part No.	520228	Ref. No. —
	tooth lock washer ID ø 15.3mm ED ø 24mm steel Qty 1 pcs for thread M14		
	Part No.	550262	Ref. No. —
	flat gasket copper ED ø 20mm ID ø 14mm thickness 2mm		



Part No.	416675	Ref. No.	5590980 A87RZ65039
description	heating element 1500W 230V L 480mm W 480mm L1 100mm L2 380mm W1 430mm W2 50mm connection length 20mm thread 1/4" mounting distance 55mm tube ø 6.5mm connection 5 2 hole fixing heating circuits 1 dry heating element		
For models:	FVD 2/50, FVD 3/50, FVD 5/50		









Part No.	416455	Ref. No.	5591700 A87RZ65050
description	heating element 1500W 400V L 645mm W 351mm thread 1/4" mounting distance 342mm connection length 80mm connection male faston 6.3mm tube ø 8.4mm heating circuits 1 dry heating element mounting pos. lower 2 hole fixing		
For models:	FG 1 60 90A, FG 1 60 90TA, FG 2 60 90A, FG 2 60 90R, FG 2 60 90TA, FGM 1 60 90A, FGM 2 60 90R, FGMS 1 60 90R, FGMS 1 60 90TA, FGMS 2 60 90A, FGMS 2 60 90R, FGMS 2 60 90TA, FGS 1 60 90A, FGS 1 60 90R, FGS 1 60 90TA, FGS 2 60 90A, FGS 2 60 90R, FGS 2 60 90TA		
accessories for	416455		
	Part No.	361182	Ref. No. —
	nut thread 1/4" H 5mm nickel-plated brass WS 17 Qty 1 pcs		





Table continues overleaf





1 electric components

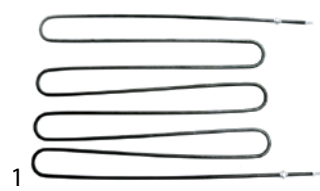

accessories for 416455			
	Part No. 510417	Ref. No.	—
flat gasket fibre ED ø 20mm ID ø 14mm thickness 2mm Qty 1 pcs			
	Part No. 520228	Ref. No.	—
tooth lock washer ID ø 15.3mm ED ø 24mm steel Qty 1 pcs for thread M14			
	Part No. 550262	Ref. No.	—
flat gasket copper ED ø 20mm ID ø 14mm thickness 2mm			

			
Part No.	416569	Ref. No.	5591900 A87RZ65051
description	heating element 1670W 400V L 975mm W 210mm thread 1/4" mounting distance 201mm connection length 95mm connection male faston 6.3mm tube ø 8.5mm heating circuits 1 dry heating element mounting pos. lower 2 hole fixing		
For models:	FG 1/90 A, FG 1/90 R, FG 2/90 A, FG 2/90 R, FGM 1/90 A, FGM 1/90 R, FGM 2/90 A, FGM 2/90 R, FGMS 1/90 A, FGMS 1/90 R, FGMS 2/90 A, FGMS 2/90 R, FGS 1/90 A, FGS 1/90 R, FGS 2/90 A, FGS 2/90 R		
accessories for 416569			
	Part No. 361182	Ref. No.	—
nut thread 1/4" H 5mm nickel-plated brass WS 17 Qty 1 pcs			
	Part No. 510417	Ref. No.	—
flat gasket fibre ED ø 20mm ID ø 14mm thickness 2mm Qty 1 pcs			
	Part No. 520228	Ref. No.	—
tooth lock washer ID ø 15.3mm ED ø 24mm steel Qty 1 pcs for thread M14			
	Part No. 550262	Ref. No.	—
flat gasket copper ED ø 20mm ID ø 14mm thickness 2mm			



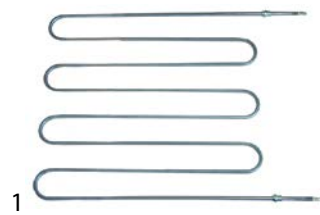

			
Part No.	416413	Ref. No.	5591861 A87RZ65051
description	heating element 1900W 230V L 970mm W 210mm thread 1/4" mounting distance 201mm connection length 93mm connection male faston 6.3mm tube ø 8.5mm heating circuits 1 2 hole fixing		
accessories for 416413			
	Part No. 361182	Ref. No.	—
nut thread 1/4" H 5mm nickel-plated brass WS 17 Qty 1 pcs			
	Part No. 510417	Ref. No.	—
flat gasket fibre ED ø 20mm ID ø 14mm thickness 2mm Qty 1 pcs			
	Part No. 520228	Ref. No.	—
tooth lock washer ID ø 15.3mm ED ø 24mm steel Qty 1 pcs for thread M14			
	Part No. 550262	Ref. No.	—
flat gasket copper ED ø 20mm ID ø 14mm thickness 2mm			

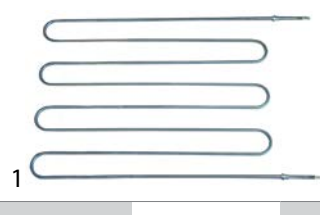
			
Part No.	418611	Ref. No.	5591570 A87RZ65058
description	heating element 2000W 230V L 645mm W 550mm thread 1/4" mounting distance 537mm connection length 100mm connection male faston 6.3mm tube ø 8.5mm heating circuits 1 dry heating element 2 hole fixing		
accessories for 418611			
	Part No. 361182	Ref. No.	—
nut thread 1/4" H 5mm nickel-plated brass WS 17 Qty 1 pcs			
	Part No. 510417	Ref. No.	—
flat gasket fibre ED ø 20mm ID ø 14mm thickness 2mm Qty 1 pcs			
	Part No. 520228	Ref. No.	—
tooth lock washer ID ø 15.3mm ED ø 24mm steel Qty 1 pcs for thread M14			
	Part No. 550262	Ref. No.	—
flat gasket copper ED ø 20mm ID ø 14mm thickness 2mm			





			
Part No.	416450	Ref. No.	5591300 A87RZ65042
description	heating element 2000W 380V L 467mm W 433mm thread 1/4" mounting distance 424.5mm connection length 100mm connection M4 tube ø 8.5mm heating circuits 1 dry heating element 2 hole fixing		
For models:	BABY 50A, BABY 50R, BABY 50TA		

			
Part No.	416453	Ref. No.	5591600 A87RZ65048
description	heating element 2000W 400V L 640mm W 510mm thread 1/4" mounting distance 501.5mm connection length 102mm connection male faston 6.3mm tube ø 8.5mm heating circuits 1 dry heating element mounting pos. lower 2 hole fixing pizza oven		
For models:	FG 1 60A, FG 1 60R, FG 1 60TA, FG 1/60 A, FG 1/60 R, FG 2 60A, FG 2 60R, FG 2 60TA, FG 2/60 A, FG 2/60 R, FGM 1 60A, FGM 1 60R, FGM 1 60TA, FGM 1/60 A, FGM 1/60884901R, FGM 2 60A, FGM 2 60R, FGM 2 60TA, FGM 2/60 A, FGM 2/60 R, FGMS 1 60A, FGMS 1 60R, FGMS 1 60TA, FGMS 1/60 A, FGMS 1/60 R, FGMS 2 60 90A, FGMS 2 60 90TA, FGMS 2 60A, FGMS 2/60 A, FGMS 2/60 R, FGS 1 60A, FGS 1 60R, FGS 1 60TA, FGS 1/60 A, FGS 1/60 R, FGS 2 60A, FGS 2 60R, FGS 2 60TA, FGS 2/60 A, FGS 2/60 R		

Part No.	416457	Ref. No.	5591800
description	heating element 2000W 400V L 965mm W 390mm thread 1/4" mounting distance 382mm connection M4 tube ø 8.5mm heating circuits 1 dry heating element mounting pos. lower 2 hole fixing		
For models:	FG 1 90A, FG 1 90R, FG 1 90TA, FG 2 90A, FG 2 90R, FG 2 90TA, FGM 1 90A, FGM 1 90R, FGM 1 90TA, FGM 2 90A, FGM 2 90R, FGM 2 90TA, FGMS 1 90A, FGMS 1 90R, FGMS 1 90TA, FGMS 2 90A, FGMS 2 90R, FGMS 2 90TA, FGS 1 90A, FGS 1 90R, FGS 1 90TA, FGS 2 90A, FGS 2 90R, FGS 2 90TA		
accessories for	416457		
	Part No.	361182	Ref. No. —
	nut thread 1/4" H 5mm nickel-plated brass WS 17 Qty 1 pcs		
	Part No.	510417	Ref. No. —
	flat gasket fibre ED ø 20mm ID ø 14mm thickness 2mm Qty 1 pcs		
	Part No.	520228	Ref. No. —
	tooth lock washer ID ø 15.3mm ED ø 24mm steel Qty 1 pcs for thread M14		
	Part No.	550262	Ref. No. —
	flat gasket copper ED ø 20mm ID ø 14mm thickness 2mm		







Part No.	416451	Ref. No.	55912800
description	heating element 2500W 380V L 567mm W 490mm thread 1/4" mounting distance 482mm connection length 87mm connection male faston 6.3mm tube ø 8.5mm heating circuits 1 dry heating element mounting pos. dry heating element 2 hole fixing		
For models:	FG 2 50R, FG 2 50TA, FG 2/50 A, FG 2/50 R, FG 250 A, FGM 2 50A, FGM 2 50R, FGM 2 50TA, FGM 2/50 A, FGM 2/50 R		
accessories for	416451		
	Part No.	361182	Ref. No. —
	nut thread 1/4" H 5mm nickel-plated brass WS 17 Qty 1 pcs		
	Part No.	510417	Ref. No. —
	flat gasket fibre ED ø 20mm ID ø 14mm thickness 2mm Qty 1 pcs		
	Part No.	520228	Ref. No. —
	tooth lock washer ID ø 15.3mm ED ø 24mm steel Qty 1 pcs for thread M14		
	Part No.	550262	Ref. No. —
	flat gasket copper ED ø 20mm ID ø 14mm thickness 2mm		

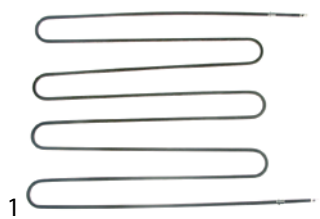

Part No.	416674	Ref. No.	5590880 A87RZ65037
description	heating element 2500W 230V L 495mm W 480mm L1 100mm L2 395mm W1 55mm W2 425mm connection length 61mm thread 1/4" mounting distance 42mm tube ø 6.3mm connection male faston 6.3mm 2 hole fixing heating circuits 1 dry heating element		
For models:	FVD 2/50, FVD 3/50, FVD 5/50		



Part No.	416452	Ref. No.	5591550 A87RZ65058
description	heating element 2500W 400V L 638mm W 470mm thread 1/4" mounting distance 462mm connection length 87mm connection male faston 6.3mm tube ø 8.5mm heating circuits 1 dry heating element mounting pos. upper 2 hole fixing		
For models:	FG 1 60A, FG 1 60R, FG 1 60TA, FG 1/60 A, FG 1/60 R, FG 2 60A, FG 2 60R, FG 2 60TA, FG 2/60 A, FG 2/60 R, FGM 1 60A, FGM 1 60R, FGM 1 60TA, FGM 1/60 A, FGM 1/60 R, FGM 1/60884901R, FGM 2 60A, FGM 2 60R, FGM 2 60TA, FGM 2/60 A, FGM 2/60 R, FGMS 1 60A, FGMS 1 60R, FGMS 1 60TA, FGMS 1/60 A, FGMS 1/60 R, FGMS 2 60A, FGMS 2 60R, FGMS 2 60TA, FGMS 2/60 A, FGMS 2/60 R, FGS 1 60A, FGS 1 60R, FGS 1 60TA, FGS 1/60 A, FGS 1/60 R, FGS 2 60A, FGS 2 60R, FGS 2 60TA, FGS 2/60 A, FGS 2/60 R		
accessories for	416452		
	Part No.	361182	Ref. No. —
	nut thread 1/4" H 5mm nickel-plated brass WS 17 Qty 1 pcs		
	Part No.	510417	Ref. No. —
	flat gasket fibre ED ø 20mm ID ø 14mm thickness 2mm Qty 1 pcs		
	Part No.	520228	Ref. No. —
	tooth lock washer ID ø 15.3mm ED ø 24mm steel Qty 1 pcs for thread M14		
	Part No.	550262	Ref. No. —
	flat gasket copper ED ø 20mm ID ø 14mm thickness 2mm		

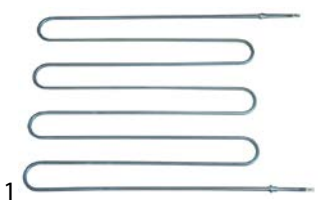

Part No.	418829	Ref. No.	55913140 5591340 A87RZ65043
description	heating element 2500W 230V L 570mm W 490mm thread 1/4" mounting distance 482mm connection male faston 6.3mm tube ø 8.5mm heating circuits 1 dry heating element 2 hole fixing		



Part No.	419072	Ref. No.	5591530 5591570 5800050 A87RZ65058
description	heating element 2800W 230V L 645mm W 550mm thread 1/4" mounting distance 537mm connection length 100mm connection male faston 6.3mm tube ø 8.5mm heating circuits 1 dry heating element 2 hole fixing		

Part No.	419229	Ref. No.	A87RZ65005
description	heating element 2800W 230V L 660mm W 360mm thread 1/4" mounting distance 355mm tube ø 9mm cable lengthmm heating circuits 1 screw connection		

Part No.	418988	Ref. No.	5592140 A87RZ80013
description	heating element 300W 230V L 498mm W 45mm thread M12x1 mounting distance 39mm connection length 62mm connection male faston 6.3mm tube ø 6.3mm heating circuits 1 dry heating element mounting pos. upper pizza oven		

Part No.	416570	Ref. No.	5591320
description	heating element 450W 400V L 620mm W 45mm thread 1/4" mounting distance 37mm connection length 90mm connection male faston 6.3mm tube ø 8.5mm heating circuits 1 dry heating element 2 hole fixing		
For models:	FGM 1 60 90A, FGMS 1 60 90R, FGMS 1 60 90TA, FGMS 1 60A, FGMS 1 60R, FGMS 1 60TA, FGMS 1/60 A, FGMS 1/60 R, FGMS 1/6090 A, FGMS 1/6090 R, FGMS 2 60 90A, FGMS 2 60 90R, FGMS 2 60 90TA, FGMS 2 60A, FGMS 2 60R, FGMS 2 60TA, FGMS 2/60 A, FGMS 2/60 R, FGMS 2/6090 A, FGMS 2/6090 R, FGS 1 60 90A, FGS 1 60 90R, FGS 1 60 90TA, FGS 1 60A, FGS 1 60R, FGS 1 60TA, FGS 1/60 A, FGS 1/60 R, FGS 1/6090 A, FGS 1/6090 R, FGS 2 60 90A, FGS 2 60 90R, FGS 2 60 90TA, FGS 2 60A, FGS 2/60 A, FGS 2/60 R, FGS 2/6090 A, FGS 2/6090 R		

accessories for	416570			
	Part No.	361182	Ref. No.	—
	nut thread 1/4" H 5mm nickel-plated brass WS 17 Qty 1 pcs			
	Part No.	510417	Ref. No.	—
	flat gasket fibre ED ø 20mm ID ø 14mm thickness 2mm Qty 1 pcs			
	Part No.	520228	Ref. No.	—
	tooth lock washer ID ø 15.3mm ED ø 24mm steel Qty 1 pcs for thread M14			
	Part No.	550262	Ref. No.	—
	flat gasket copper ED ø 20mm ID ø 14mm thickness 2mm			

Part No.	416673	Ref. No.	5590930 A87RZ80003
description	heating element 500W 230V L 315mm W 315mm L1 0mm L2 315mm W1 265mm W2 50mm connection length 62mm thread 1/4" mounting distance 44mm tube ø 6.3mm mounting pos. lower connection male faston 6.3mm 2 hole fixing heating circuits 1 dry heating element		
For models:	FVD 2/33, FVD 3/33, FVD 5/33		

heating elements for pizza presses

Part No.	416458	Ref. No.	5590700 A87RZ66001
description	heating element 1500W 230V L 375mm W 268mm connection male faston 6.3mm L1 137mm L2 238mm W1 120mm W2 28mm dry heating element tube ø 8.5mm windings 4		
For models:	PFD33		

Part No.	416309	Ref. No.	5590710 57110120 A87RZ66010
description	heating element 2000W 230V L 260mm W 260mm heating circuits 1 cable length 290mm connection length 10mm tube ø 6.2mm windings 8 connection distance 59mm		
For models:	PFD 30 N, PFD 33 N, PFD 40 N, PFD36		



<p>1</p>			
Part No.	416316	Ref. No.	5590760 A87RZ66003
description	heating element 2500W 230V L 360mm W 360mm heating circuits 1 cable length 250mm connection length 10mm tube ø 6.3mm windings 12 connection distance 49mm		
For models:	PFD 45 N, PFD 50 N, PFD 55 N		

<p>1</p>			
Part No.	416459	Ref. No.	5590750 A87RZ66002
description	heating element 2500W 230V L 494mm W 335mm connection male faston 6.3mm connection length 22mm L1 160mm L2 334mm W1 155mm W2 34mm dry heating element tube ø 8.5mm windings 5		
For models:	PFD45		

<p>1</p>			
Part No.	416460	Ref. No.	5590800 A87RZ66004
description	heating element 2500W 230V L 540mm W 407mm connection M5 dry heating element tube ø 8.5mm		
For models:	PFD 50		

thermostats

control and safety thermostats

EGO

control thermostats

55.10/19_ series



1

Part No.	375273	Ref. No.	5320400 A88TX77002
description	thermostat t.max. 200°C temperature range 60-200°C 1-pole 1NO 16A probe ø 6mm probe L 74mm capillary pipe 1500mm capillary pipe isolatedmm gland nut shaft L 23mm shaft position upper rotation 270°		
For models:	PFD 50, PFD33, PFD45		



1

Part No.	375253	Ref. No.	5320420 5320480 A88TX77005
description	thermostat t.max. 455°C temperature range 85-455°C 1-pole 1NO 16A probe ø 3.9mm probe L 228mm capillary pipe 870mm capillary pipe isolated 660mm gland nut shaft ø 6x4.6mm shaft L 23mm shaft position upper rotation 270°		
For models:	FGM 1/60 A, FGM 1/60884901R, FGM 2/60 A, FGM 2/60 R, FGMS 1/60 A, FGMS 1/60 R, FGMS 1/6090 A, FGMS 1/6090 R, FGMS 1/90 A, FGMS 1/90 R, FGMS 1/9060 A, FGMS 1/9060 R, FGMS 2/60 A, FGMS 2/60 R, FGMS 2/6090 A, FGMS 2/6090 R, FGMS 2/90 A, FGMS 2/90 R, FGMS 2/9060 A, FGMS 2/9060 R		



safety thermostats

55.10/19_ series



Part No.	390735	Ref. No.	5320440 A88TX77004
description	safety thermostat switch-off temp. 569°C 1-pole probe ø 4mm probe L 163mm capillary pipe 1470mm capillary pipe isolated 600mm		

55.32_ series



Part No.	375190	Ref. No.	A88TX85001
description	safety thermostat switch-off temp. 560°C 3-pole 20A probe ø 3.9mm probe L 228mm capillary pipe 870mm capillary pipe isolated 700mm gland nut probe		



Part No.	375257	Ref. No.	5320450 A88TX85003
description	safety thermostat switch-off temp. 580°C 3-pole 20A probe ø 4mm probe L 163mm capillary pipe 1200mm capillary pipe isolatedmm gland nut probe		
For models:	BABY 50A, BABY 50R, BABY 50TA, FG 1 60 90R, FG 1 60 90TA, FG 1 60A, FG 1 60R, FG 1 60TA, FG 1 90A, FG 1 90R, FG 1 90TA, FG 1/60 A, FG 1/60 R, FG 1/6090 A, FG 1/6090 R, FG 1/90 A, FG 1/90 R, FG 1/9060 A, FG 1/9060 R, FG 2 50R, FG 2 50TA, FG 2 50TA, FG 2 60 90A, FG 2 60 90R, FG 2 60 90TA, FG 2 60A, FG 2 60R, FG 2 60TA, FG 2 90A, FG 2 90R, FG 2 90TA, FG 2/50 A, FG 2/50 R, FG 2/60 A, FG 2/60 R, FG 2/6090 A, FG 2/6090 R, FG 2/90 A, FG 2/90 R, FG 2/9060 A, FG 2/9060 R, FG 250 A, FG 1 60 90A, FGM 1 60 90R, FGM 1 60 90TA, FGM 1 60A, FGM 1 60R, FGM 1 60TA, FGM 1 90A, FGM 1 90R, FGM 1 90TA...(Other models you can see in the webshop)		

JUMO

control thermostats

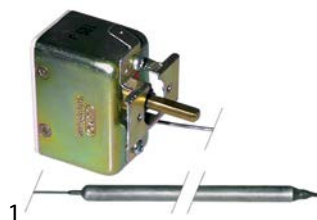

Part No.	375100	Ref. No.	5320470
description	thermostat t.max. 500°C temperature range 20-500°C 1-pole 1CO 16A probe ø 8mm probe L 155mm capillary pipe 1000mm capillary pipe isolatedmm gland nut shaft L 17mm rotation 318°		
For models:	FGM 1 60 90A, FGM 1 60 90R, FGM 1 60 90TA, FGM 1 60A, FGM 1 60R, FGM 1 60TA, FGM 1 90A, FGM 1 90R, FGM 1 90TA, FGM 2 60 90A, FGM 2 60 90R, FGM 2 60 90TA, FGM 2 60A, FGM 2 60R, FGM 2 60TA, FGM 2 90A, FGM 2 90R, FGM 2 90TA, FGMS 1 60 90R, FGMS 1 60 90TA, FGMS 1 60A, FGMS 1 60R, FGMS 1 60TA, FGMS 1 90A, FGMS 1 90R, FGMS 1 90TA, FGMS 2 60 90A, FGMS 2 60 90R, FGMS 2 60 90TA, FGMS 2 60A, FGMS 2 60R, FGMS 2 60TA, FGMS 2 90A, FGMS 2 90R, FGMS 2 90TA		

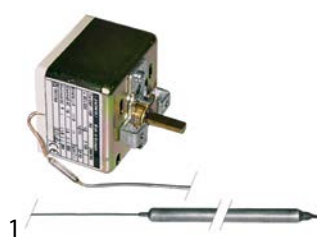

Part No.	375103	Ref. No.	5320390 A88TX85003
description	thermostat t.max. 500°C temperature range 20-500°C 3-pole 3CO 16A probe ø 8mm probe L 155mm capillary pipe 1000mm capillary pipe isolatedmm gland nut shaft ø 6x4.6mm shaft L 17mm rotation 270°		
For models:	BABY 50A, BABY 50R, BABY 50TA, FGM 1/6090 A, FGM 1/6090 R, FGM 1/90 A, FGM 1/90 R, FGM 1/9060 A, FGM 1/9060 R, FGM 2 50A, FGM 2 50R, FGM 2 50TA, FGM 2/50 A, FGM 2/50 R, FGM 2/6090 A, FGM 2/6090 R, FGM 2/90 A, FGM 2/90 R, FGM 2/9060 A, FGM 2/9060 R		

switches and momentary switches



rocker/momentary rocker switches

30x11 mm



Part No.	301053	Ref. No.	5320100 A87AZ69006
description	rocker switch mounting measurements 30x11mm white 1NO/indicator light 250V 16A 0-I connection male faston 6.3mm		
For models:	FGM 1 60 90A, FGM 1 60 90R, FGM 1 60 90TA, FGM 1 60A, FGM 1 60R, FGM 1 60TA, FGM 1 90A, FGM 1 90R, FGM 1 90TA, FGM 1/60 A, FGM 1/60884901R, FGM 1/6090 A, FGM 1/6090 R, FGM 1/90 A, FGM 1/90 R, FGM 1/9060 A, FGM 1/9060 R, FGM 2 60 90A, FGM 2 60 90R, FGM 2 60 90TA, FGM 2 60A, FGM 2 60R, FGM 2 60TA, FGM 2 90A, FGM 2 90R, FGM 2 90TA, FGM 2/60 A, FGM 2/60 R, FGM 2/6090 A, FGM 2/6090 R, FGM 2/90 A, FGM 2/90 R, FGM 2/9060 A, FGM 2/9060 R, FGMS 1 60 90R, FGMS 1 60 90TA, FGMS 1 60A, FGMS 1 60R, FGMS 1 60TA, FGMS 1 90A, FGMS 1 90R, FGMS 1 90TA, FGMS 1/60 A, FGMS 1/60 R, FGMS 1/6090 A, FGMS 1/6090 R, FGMS 1/90 A, FGMS 1/90 R, FGMS 1/9060 A, FGMS 1/9060 R...(Other models you can see in the webshop)		



30x22mm			
labelled			
			
1			
Part No.	300125	Ref. No.	5320020
description	rocker switch mounting measurements 30x22mm green 2NO 230V 16A 0-1 connection male faston 6.3mm ambient temperature max. 125/55°C protection IP65 with cover cap		
accessories for	300125		
	Part No.	301036	Ref. No.
			—
	 protective cover internal size 30x22mm for rocker switch mounting measurementsmm		

roller-lever actuated			
heavy duty version			
			
1			
Part No.	345485	Ref. No.	8300990 A96ZN00030
description	microswitch with handle with a switch 250V 20A 1CO connection screw L 50mm L1 49mm ambient temperature max. 85°C mounting distance 22mm type Z15G1703 actuating force: 75g lever length 47mm		
For models:	TF17, TF22, TF33, TF42, TF53		

push/momentary push switches

overload switches			
			
1			
Part No.	348137	Ref. No.	8308560 A96ZN00083 KLD-28A
description	momentary push switch KLD-28A mounting measurements 45x22mm green/red 2NO/A1 250V 16A I O connection male faston 2.8mm/6.3mm ambient temperature max. 85°C protection IP55 with cover cap		

roller actuated			
roller 0°			
			
1			
Part No.	345639	Ref. No.	5400100 5401000 A87AZ68003 A87AZ69016
description	microswitch with roller plunger 230V 16A 1CO connection solder/ screw connection L1 49mm ambient temperature max. 125°C thread L 14mm thread M10 mounting distance 25mm actuating force: 300g type MS15-1		
For models:	PFD 30 N, PFD 33 N, PFD 40 N, PFD 45 N, PFD 50, PFD 50 N, PFD 55 N, PFD33, PFD36, PFD45		

toggle switches

M12x0.75			
			
1			
Part No.	346842	Ref. No.	5320050 A87AZ69003
description	toggle switch thread M12x0.75 2NO 250V 15A male faston ON-OFF		
For models:	P30AE		

roller 90°			
			
1			
Part No.	347434	Ref. No.	8301380 A96ZN00042
description	microswitch with roller 250V 16A 1NO ambient temperature max. 85°C thread M12x1		
For models:	TR17, TR22, TR33, TR42, TR53		

microswitches

lever actuated			
			
1			
Part No.	345125	Ref. No.	5400100 5400250 A87AZ68003 A87AZ69015
description	microswitch with lever 250V 16A 1CO connection male faston 6.3mm ambient temperature max. 85°C mounting distance 25mm type C99ZP3 actuating force: 25g lever length 63.5mm		
For models:	PFD 30 N, PFD 33 N, PFD 40 N, PFD 45 N, PFD 50, PFD 50 N, PFD 55 N, PFD33, PFD36, PFD45		

cam switches			
on/off			
			
1			
Part No.	300021	Ref. No.	5320310
description	cam switch 4 operating positions 4NO sequence 0-1-0-1 16A shaft ø 6x4.6mm shaft L 23mm connection screw ceramic		
For models:	FG 2/50 A, FG 2/50 R, FGM 2/50 A, FGM 2/50 R		



E-G-O



1

Part No.	300102	Ref. No.	5320320
description	cam switch 4 operating positions 4NO sequence 0-1-0-1 32A shaft \varnothing 6x4.6mm shaft L 23mm connection screw ceramic		
For models:	FG 1/60 A, FG 1/60 R, FG 1/6090 A, FG 1/6090 R, FG 1/90 A, FG 1/90 R, FG 1/9060 A, FG 1/9060 R, FG 2/60 A, FG 2/60 R, FG 2/6090 A, FG 2/6090 R, FG 2/90 A, FG 2/90 R, FG 2/9060 A, FG 2/9060 R, FGM 1/60 A, FGM 1/60884901R, FGM 1/6090 A, FGM 1/6090 R, FGM 1/90 A, FGM 1/90 R, FGM 1/9060 A, FGM 1/9060 R, FGM 2/60 A, FGM 2/60 R, FGM 2/6090 A, FGM 2/6090 R, FGM 2/90 A, FGM 2/90 R, FGM 2/9060 A, FGM 2/9060 R, FGMS 1/60 A, FGMS 1/60 R, FGMS 1/6090 A, FGMS 1/6090 R, FGMS 1/90 A, FGMS 1/90 R, FGMS 1/9060 A, FGMS 1/9060 R, FGMS 2/60 A, FGMS 2/60 R, FGMS 2/6090 A, FGMS 2/6090 R, FGMS 2/90 A, FGMS 2/90 R, FGMS 2/9060 A, FGMS 2/9060 R, FGS 1/60 A, FGS 1/60 R...(Other models you can see in the webshop)		

rotary switches

BREMAS

A1200 series



1

Part No.	345675	Ref. No.	5320060 A87AZ69004
description	rotary switch sets of contacts 3 2 0-1 type CA0120003 380V 12A shaft \varnothing 5x5mm shaft L 23mm shaft square with knob connection screw		
For models:	BABY 50A, BABY 50R, BABY 50TA, FG 2 50R, FG 2 50TA, FG 2 60A, FGM 1 60 90A, FGM 1 60 90R, FGM 1 60 90TA, FGM 1 60A, FGM 1 60R, FGM 1 60TA, FGM 1 90A, FGM 1 90R, FGM 1 90TA, FGM 2 50A, FGM 2 50R, FGM 2 50TA, FGM 2 60 90A, FGM 2 60 90R, FGM 2 60 90TA, FGM 2 60A, FGM 2 60R, FGM 2 60TA, FGM 2 90A, FGM 2 90R, FGM 2 90TA, FGMS 1 60 90R, FGMS 1 60 90TA, FGMS 1 60A, FGMS 1 60R, FGMS 1 60TA, FGMS 1 90A, FGMS 1 90R, FGMS 1 90TA, FGMS 2 60 90A, FGMS 2 60 90R, FGMS 2 60 90TA, FGMS 2 60A, FGMS 2 60R, FGMS 2 60TA, FGMS 2 90A, FGMS 2 90R, FGMS 2 90TA		



1

Part No.	345274	Ref. No.	5320010 A87AZ69004
description	rotary switch sets of contacts 4 2 0-1 type CA0120004 380V 12A shaft \varnothing 5x5mm shaft L 23mm shaft square connection screw		
For models:	PFD33		

A1600 series



1

Part No.	345676	Ref. No.	5320090 A87AZ69005
description	rotary switch 2 0-1 sets of contacts 3 type CA0160003 400V 20A shaft \varnothing 5x5mm shaft L 23mm shaft square connection screw		
For models:	FG 2 50R, FG 2 50TA, FG 250 A		
spare parts for	345676		
	Part No.	347254	Ref. No. —
	rotary switch 2 0-1 sets of contacts 3 type CA0200003V 400V 16A shaft \varnothing 5x5mm shaft L 18mm shaft square connection screw contacts 3NO		

GIOVENZANA

rotary switches



1

Part No.	347634	Ref. No.	5320080 A87AZ69004
description	rotary switch 2 0-1 sets of contacts 4 type A87AZ69004 690V 20A shaft \varnothing 8x8mm shaft L 15mm shaft star-shaped connection screw		
For models:	FVD 2/33, FVD 3/33, FVD 5/33, PFD 30 N, PFD 33 N, PFD 40 N, PFD 45 N, PFD 50 N, PFD 55 N, PFD36, PFD45		



1

Part No.	345239	Ref. No.	5320250 A87AZ69009 A87AZ69009+A87AZ69011
description	rotary switch 2 0-1 sets of contacts 4 type SE323004R 690V 40A shaft \varnothing 6x4.6mm shaft L 15mm shaft star-shaped connection screw		
For models:	FG 1 60 90R, FG 1 60 90TA, FG 1 60A, FG 1 60R, FG 1 60TA, FG 1 90A, FG 1 90R, FG 1 90TA, FG 2 60 90A, FG 2 60 90R, FG 2 60 90TA, FG 2 60A, FG 2 60R, FG 2 60TA, FG 2 90A, FG 2 90R, FG 2 90TA, FGS 1 60 90A, FGS 1 60 90R, FGS 1 60 90TA, FGS 1 60A, FGS 1 60R, FGS 1 60TA, FGS 1 90A, FGS 1 90R, FGS 1 90TA, FGS 2 60 90A, FGS 2 60 90R, FGS 2 60 90TA, FGS 2 60A, FGS 2 60R, FGS 2 60TA, FGS 2 90A, FGS 2 90R, FGS 2 90TA, FVD 2/50, FVD 3/50, FVD 5/50		
accessories for	345239		
	Part No.	347651	Ref. No. 5320280 A87AZ69011
	knob with bezel dimensions 48x48mm display 0-1 \varnothing mm shaftmm shaft diametermm for rotary switch		



accessories



1			
Part No.	347651	Ref. No.	5320280 A87AZ69011
description	knob with bezel dimensions 48x48mm display 0-1 ømm shaftmm shaft diametermm for rotary switch		

KRAUS & NAIMER

rotary switches



1			
Part No.	345431	Ref. No.	8301310 A96ZN00037
description	rotary switch 2 0-1 sets of contacts 4 type 9A003PL-2V 400V 2A shaft ø 6mm shaft L 17mm shaft star-shaped connection screw		
For models:	TF17, TF22, TF33, TF42, TF53, TR17, TR22, TR33, TR42, TR53		

foot switches



1			
Part No.	346841	Ref. No.	2300020 3660330 PEDALE S66CI54002
description	foot switch 1CO		

control equipment

TELEMECANIQUE (EFA)

XA2 series

switches (complete)



1			
Part No.	345435	Ref. No.	8301060 A96ZN00032
description	momentary push switch mounting measurements ø22mm 1NO		
For models:	TF17, TF22, TF33, TF42, TF53, TR17, TR22, TR33, TR42, TR53		



1			
Part No.	345461	Ref. No.	8301050 A96ZN00031
description	mushroom switch mounting measurements ø22mm 1NC EMERGENCY SHUT-DOWN		
For models:	PFD 30 N, PFD 33 N, PFD 40 N, PFD 45 N, PFD 50 N, PFD 55 N, PFD36, TF17, TF22, TF33, TF42, TF53, TR17, TR22, TR33, TR42, TR53		
spare parts for	345461		
	Part No.	345221	Ref. No. —
	contact block EFA ZB2BE102 1NC max 230V 10(6)A black		
	Part No.	346660	Ref. No. —
	contact block holder		
accessories for	345461		
	Part No.	345220	Ref. No. —
	contact block EFA ZB2BE101 1NO max 230V 10(6)A black		

encoders and potentiometers



1			
Part No.	300225	Ref. No.	FT08060
description	potentiometer 10KOhm		
For models:	PFD 30 N, PFD 33 N, PFD 40 N, PFD 45 N, PFD 50 N, PFD 55 N, PFD36		



1			
Part No.	402900	Ref. No.	8308600
description	potentiometer 10KOhm rotation 280° shaft ø 6mm shaft L 51mm thread M10x0.75		



1			
Part No.	403205	Ref. No.	A96ZN00084
description	potentiometer 10KOhm shaft ø 6mm shaft L 10mm thread M10 2W type WTH118-1A ø 27.5mm		
accessories for	403205		
	Part No.	110970	Ref. No. 5873320 A90MA00002
	knob switch zero mark t.max.°C°C ø 19mm shaft ø 6mm black/red		



lamps

indicator lights

indicator lights (complete)

ø10mm

with plug-in socket



Part No.	359263	Ref. No.	5371120 A87IL72005
description	indicator light ø 10mm		
For models:	BABY 50A, BABY 50R, BABY 50TA, FGM 1 60 90A, FGM 1 60 90R, FGM 1 60 90TA, FGM 1 60A, FGM 1 60R, FGM 1 60TA, FGM 1 90A, FGM 1 90R, FGM 1 90TA, FGM 1/60 A, FGM 1/60884901R, FGM 1/6090 A, FGM 1/6090 R, FGM 1/90 A, FGM 1/90 R, FGM 1/9060 A, FGM 1/9060 R, FGM 2 50A, FGM 2 50R, FGM 2 50TA, FGM 2 60 90A, FGM 2 60 90R, FGM 2 60 90TA, FGM 2 60A, FGM 2 60R, FGM 2 60TA, FGM 2 90A, FGM 2 90R, FGM 2 90TA, FGM 2/50 A, FGM 2/50 R, FGM 2/60 A, FGM 2/60 R, FGM 2/6090 A, FGM 2/6090 R, FGM 2/90 A, FGM 2/90 R, FGM 2/9060 A, FGM 2/9060 R, FGMS 1 60 90R, FGMS 1 60 90TA, FGMS 1 60A, FGMS 1 60R, FGMS 1 60TA, FGMS 1 90A, FGMS 1 90R, FGMS 1 90TA...(Other models you can see in the webshop)		

screw-on/push-on fit

light bulbs

for ovens



Part No.	359610	Ref. No.	5371260 A87IL72008
description	light bulb t.max. 300°C socket E14 15W 230V ø 22mm L 47mm lens L 20mm for oven lamp type Philips		
For models:	FG 1 60A, FG 1 60R, FG 1 60TA, FG 2 60A, FG 2 60R, FG 2 60TA, FGM 1 60A, FGM 1 60R, FGM 1 60TA, FGM 2 60A, FGM 2 60R, FGM 2 60TA, FGMS 2 60 90R, FGMS 2 60R, FGMS 2 60TA, FGS 1 60A, FGS 1 60R, FGS 1 60TA, FGS 2 60A, FGS 2 60R, FGS 2 60TA		



Part No.	359612	Ref. No.	5371240 A87IL72006
description	light bulb t.max. 300°C socket E14 25W 230V ø 25mm L 56mm lens L 30mm for oven lamp type Philips		
For models:	FG 1 60 90R, FG 1 60 90TA, FG 1 90A, FG 1 90R, FG 1 90TA, FG 2 60 90A, FG 2 60 90R, FG 2 60 90TA, FG 2 90A, FG 2 90R, FG 2 90TA, FGM 1 60 90A, FGM 1 60 90R, FGM 1 60 90TA, FGM 1 90A, FGM 1 90R, FGM 1 90TA, FGM 2 60 90A, FGM 2 60 90R, FGM 2 60 90TA, FGM 2 90A, FGM 2 90R, FGM 2 90TA, FGMS 1 60 90R, FGMS 1 60 90TA, FGMS 1 90A, FGMS 1 90R, FGMS 1 90TA, FGMS 2 60 90A, FGMS 2 60 90R, FGMS 2 60 90TA, FGMS 2 90A, FGMS 2 90R, FGMS 2 90TA, FGS 1 60 90A, FGS 1 60 90R, FGS 1 60 90TA, FGS 1 90A, FGS 1 90R, FGS 1 90TA, FGS 2 60 90A, FGS 2 60 90R, FGS 2 60 90TA, FGS 2 90A, FGS 2 90R, FGS 2 90TA		



Part No.	357118	Ref. No.	A87IL72010
description	light bulb t.max. 500°C socket E14 40W 230/240V ø 25mm L 70mm lens L 44mm type Qty 1 pcs		

halogen lamp

for socket E14 / E27



Part No.	359728	Ref. No.	5371290
description	halogen lamp socket E14 230V 40W ø 25mm lens L 54mm L 80mm temp.-resist. 300°C Qty 1		
For models:	FG 1/90 A, FG 1/90 R, FG 2/90 A, FG 2/90 R, FG 2/9060 A, FG 2/9060 R, FGM 1/90 A, FGM 1/90 R, FGM 2/90 A, FGM 2/90 R, FGM 2/9060 A, FGM 2/9060 R, FGMS 1/90 A, FGMS 1/90 R, FGMS 2/90 A, FGMS 2/90 R, FGMS 2/9060 A, FGMS 2/9060 R, FGS 1/90 A, FGS 1/90 R, FGS 2/90 A, FGS 2/90 R, FGS 2/9060 A, FGS 2/9060 R		



Part No.	347481	Ref. No.	5371290 5371330 5371450
description	halogen lamp socket E14 230V 40W ø 25mm L 70mm temp.-resist. 500°C Qty 1		

for socket G4 / G6.35 / G9



Part No.	359946	Ref. No.	5800000 5800040 A87IL72011
description	halogen lamp socket G9 230V 40W temp.-resist. 300°C		



oven lamps

universal oven lamps

mounting diameter 35.5mm



1	Part No.	359701	Ref. No.	5371210 A87IL73006
description	lamp socket socket E14 220-230V mounting ø 35.5mm connection male faston 6.3mm 15W			
For models:	FG 1 60 90R, FG 1 60 90TA, FG 1 60A, FG 1 60R, FG 1 60TA, FG 1 90A, FG 1 90R, FG 1 90TA, FG 2 60 90A, FG 2 60 90R, FG 2 60 90TA, FG 2 60A, FG 2 60R, FG 2 60TA, FG 2 90A, FG 2 90R, FG 2 90TA, FGM 1 60 90A, FGM 1 60 90R, FGM 1 60 90TA, FGM 1 60A, FGM 1 60R, FGM 1 60TA, FGM 1 90A, FGM 1 90R, FGM 1 90TA, FGM 2 60 90A, FGM 2 60 90R, FGM 2 60 90TA, FGM 2 60A, FGM 2 60R, FGM 2 60TA, FGM 2 90A, FGM 2 90R, FGM 2 90TA, FGMS 1 60 90R, FGMS 1 60 90TA, FGMS 1 60A, FGMS 1 60R, FGMS 1 60TA, FGMS 1 90A, FGMS 1 90R, FGMS 1 90TA, FGMS 2 60 90A, FGMS 2 60 90R, FGMS 2 60 90TA, FGMS 2 60A, FGMS 2 60R, FGMS 2 60TA, FGMS 2 90A...(Other models you can see in the webshop)			
accessories for	359701			
	Part No.	359705	Ref. No.	—
description	oven lamp glass thr.ø 33.5mm ø 52mm hard glas temp.-resist. 350°C			
	Part No.	359709	Ref. No.	5371230 A87IL74005
description	oven lamp glass thr.ø 33.5mm ø 42mm hard glas temp.-resist. 350°C			
	Part No.	359721	Ref. No.	—
description	gasket silicone ED ø 48mm ID ø 39.5mm thickness 5mm Qty 1 pcs			
	Part No.	359942	Ref. No.	—
description	oven lamp glass thr.ø 33.5mm ø 41mm hard glas temp.-resist. 350°C			



1	Part No.	359661	Ref. No.	5371220 A87IL74004
description	oven lamp glass thread 32.1 ø 58mm hard glas temp.-resist. 350°C			
For models:	FG 1 60 90R, FG 1 60 90TA, FG 1 90A, FG 1 90R, FG 1 90TA, FG 2 60 90A, FG 2 60 90R, FG 2 60 90TA, FG 2 90A, FG 2 90R, FG 2 90TA, FGM 1 60 90A, FGM 1 60 90R, FGM 1 60 90TA, FGM 1 90A, FGM 1 90R, FGM 1 90TA, FGM 2 60 90A, FGM 2 60 90R, FGM 2 60 90TA, FGM 2 90A, FGM 2 90R, FGM 2 90TA, FGMS 1 60 90R, FGMS 1 60 90TA, FGMS 1 90A, FGMS 1 90R, FGMS 1 90TA, FGMS 2 60 90A, FGMS 2 60 90R, FGMS 2 60 90TA, FGMS 2 90A, FGMS 2 90R, FGMS 2 90TA, FGS 1 60 90A, FGS 1 60 90R, FGS 1 60 90TA, FGS 1 90A, FGS 1 90R, FGS 1 90TA, FGS 2 60 90A, FGS 2 60 90R, FGS 2 60 90TA, FGS 2 90A, FGS 2 90R, FGS 2 90TA			
accessories for	359661			
	Part No.	359700	Ref. No.	—
description	gasket for pizza oven fibre glass ID ø 32.5mm ED ø 55mm thickness 5mm			

mounting diameter 65.5mm



1	Part No.	359022	Ref. No.	5371190 A87IL73002
description	lamp socket socket E14 mounting ø 65.5mm connection male faston 6.3mm			



1	Part No.	359724	Ref. No.	5371180 A87IL74003
description	oven lamp glass thread ø 62mm H 46mm ø 74mm hard glas temp.-resist. 350°C			
For models:	FG 1/90 A, FG 1/90 R, FG 2/90 A, FG 2/90 R, FG 2/9060 A, FG 2/9060 R, FGM 1/90 A, FGM 1/90 R, FGM 2/90 A, FGM 2/90 R, FGM 2/9060 A, FGM 2/9060 R, FGMS 1/90 A, FGMS 1/90 R, FGMS 2/90 A, FGMS 2/90 R, FGMS 2/9060 A, FGMS 2/9060 R, FGS 1/90 A, FGS 1/90 R, FGS 2/90 A, FGS 2/90 R, FGS 2/9060 A, FGS 2/9060 R			





1	Part No.	359729	Ref. No.	5371160 A94GU00003
description	gasket glass fibre ID ø 57mm ED ø 67mm thickness 5mm ø 67mm			

1	Part No.	359033	Ref. No.	5371300 A87IL74006
description	oven lamp glass thr.ø 33.5mm H 36mm ø 41mm hard glas temp.-resist. 350°C			

1	Part No.	359709	Ref. No.	5371230 A87IL74005
description	oven lamp glass thr.ø 33.5mm ø 42mm hard glas temp.-resist. 350°C			
For models:	FG 1 60A, FG 1 60R, FG 1 60TA, FG 2 60A, FG 2 60R, FG 2 60TA, FGM 1 60A, FGM 1 60R, FGM 1 60TA, FGM 2 60A, FGMS 1 60A, FGMS 1 60R, FGMS 1 60TA, FGMS 2 60A, FGMS 2 60R, FGMS 2 60TA, FGS 1 60A, FGS 1 60R, FGS 1 60TA, FGS 2 60A, FGS 2 60R, FGS 2 60TA			





			
1			
Part No.	359722	Ref. No.	5371190 A87IL73002
description	gasket silicone ID ø 57.5mm ED ø 68mm thickness 2mm		

50x75.5mm			
			
1			
Part No.	360484	Ref. No.	5371310 A87IL73003
description	lamp socket L 75mm W 50mm 230V 40W socket E14 temp.-resist. 300°C connection male faston 6.3mm for pizza oven		

			
1			
Part No.	359303	Ref. No.	5371320 A87IL74007 NML
description	oven lamp glass L 88mm W 54mmVW socket connection for oven lamp		



lamps			
light bulbs			
			
1			
Part No.	359610	Ref. No.	5371260 A87IL72008
description	light bulb t.max. 300°C socket E14 15W 230V ø 22mm L 47mm lens L 20mm for oven lamp type Philips		
For models:	FG 1 60A, FG 1 60R, FG 1 60TA, FG 2 60A, FG 2 60R, FG 2 60TA, FGM 1 60A, FGM 1 60R, FGM 1 60TA, FGM 2 60A, FGM 2 60R, FGM 2 60TA, FGMS 2 60 90R, FGMS 2 60R, FGMS 2 60TA, FGS 1 60A, FGS 1 60R, FGS 1 60TA, FGS 2 60A, FGS 2 60R, FGS 2 60TA		

			
1			
Part No.	359612	Ref. No.	5371240 A87IL72006
description	light bulb t.max. 300°C socket E14 25W 230V ø 25mm L 56mm lens L 30mm for oven lamp type Philips		
For models:	FG 1 60 90R, FG 1 60 90TA, FG 1 90A, FG 1 90R, FG 1 90TA, FG 2 60 90A, FG 2 60 90R, FG 2 60 90TA, FG 2 90A, FG 2 90R, FG 2 90TA, FGM 1 60 90A, FGM 1 60 90R, FGM 1 60 90TA, FGM 1 90A, FGM 1 90R, FGM 1 90TA, FGM 2 60 90A, FGM 2 60 90R, FGM 2 60 90TA, FGM 2 90A, FGM 2 90R, FGM 2 90TA, FGMS 1 60 90R, FGMS 1 60 90TA, FGMS 1 90A, FGMS 1 90R, FGMS 1 90TA, FGMS 2 60 90A, FGMS 2 60 90R, FGMS 2 60 90TA, FGMS 2 90A, FGMS 2 90R, FGMS 2 90TA, FGS 1 60 90A, FGS 1 60 90R, FGS 1 60 90TA, FGS 1 90A, FGS 1 90R, FGS 1 90TA, FGS 2 60 90A, FGS 2 60 90R, FGS 2 60 90TA, FGS 2 90A, FGS 2 90R, FGS 2 90TA		

			
1 500°C			
Part No.	357118	Ref. No.	A87IL72010
description	light bulb t.max. 500°C socket E14 40W 230/240V ø 25mm L 70mm lens L 44mm type Qty 1 pcs		

halogen lamps			
for socket E14 / E27			
			
1			
Part No.	359728	Ref. No.	5371290
description	halogen lamp socket E14 230V 40W ø 25mm lens L 54mm L 80mm temp.-resist. 300°C Qty 1		
For models:	FG 1/90 A, FG 1/90 R, FG 2/90 A, FG 2/90 R, FG 2/9060 A, FG 2/9060 R, FGM 1/90 A, FGM 1/90 R, FGM 2/90 A, FGM 2/90 R, FGM 2/9060 A, FGM 2/9060 R, FGMS 1/90 A, FGMS 1/90 R, FGMS 2/90 A, FGMS 2/90 R, FGMS 2/9060 A, FGMS 2/9060 R, FGS 1/90 A, FGS 1/90 R, FGS 2/90 A, FGS 2/90 R, FGS 2/9060 A, FGS 2/9060 R		

for socket G4 / G6.35 / G9			
			
1			
Part No.	359946	Ref. No.	5800000 5800040 A87IL72011
description	halogen lamp socket G9 230V 40W temp.-resist. 300°C		

timers				
mechanical timers				
				
1				
Part No.	350124	Ref. No.	8301080 A96ZM00002	
description	timer M12 1-pole operation time 30min impulse mechanical 1NO at 250V 10A permanent position no shaft ø 6mm shaft 6mm shaft L 15mm mounting distance 28mm			
For models:	TF17, TF22, TF33, TF42, TF53, TR17, TR22, TR33, TR42, TR53			
accessories for	350124			
	Part No.	110372	Ref. No.	—
	dial plate graduation 30min permanent position no rotation 30-330° ø 60mm timers knob ø 45mm			



contactors

GENERAL ELECTRIC (AEG)

power contactors

 <p>1</p>			
Part No.	380837	Ref. No.	8301090 A96ZN00034
description	power contactor resistive load 20A 400VAC (AC3/400V) 9A/4kW main contacts 3NO auxiliary contacts 1NO connection screw connection type AEG LS0510A type GE MC1A 310A		
For models:	TF17, TF22, TF33, TF42, TR17, TR22, TR33, TR42, TR53		

ISKRA (FANAL)

power contactors

 <p>1</p>			
Part No.	380213	Ref. No.	5403500
description	power contactor resistive load 20A 230VAC (AC3/400V) 8.5A/5.5kW main contacts 3NO auxiliary contacts 1NO connection screw connection type Fanal DSL7 10 type ISKRA K07M 10		
For models:	FG 1 60 90R, FG 1 60 90TA, FG 1 60A, FG 1 60R, FG 1 60TA, FG 1 90A, FG 1 90R, FG 1 90TA, FG 2 50R, FG 2 50TA, FG 2 60 90A, FG 2 60 90R, FG 2 60 90TA, FG 2 60A, FG 2 60R, FG 2 60TA, FG 2 90A, FG 2 90R, FG 2 90TA, FG 250 A, FGS 1 60 90A, FGS 1 60 90R, FGS 1 60 90TA, FGS 1 60A, FGS 1 60R, FGS 1 60TA, FGS 1 90A, FGS 1 90R, FGS 1 90TA, FGS 2 60 90A, FGS 2 60 90R, FGS 2 60 90TA, FGS 2 60A, FGS 2 60R, FGS 2 60TA, FGS 2 90A, FGS 2 90R, FGS 2 90TA, FVD 2/50, FVD 3/33, FVD 3/50, FVD 5/33, FVD 5/50		

relays



power relays

with male contacts

female contact 2.0mm

 <p>1</p>			
Part No.	380048	Ref. No.	8301370 A96ZN00041
description	power relays 24VDC 5A 2CO plug-in connection with socket 250V 2-pole		
For models:	TF17, TF22, TF33, TF42, TF53, TR33, TR42, TR53		



relay sockets

 <p>1</p>				
Part No.	380137	Ref. No.	5584050	
description	relay socket 8-pole connection plug-in connection round 8-pole dimensions 65x28x40mm 380V voltage AC 10A Italiana Relè manuf. no. ZVE8			
accessories for	380137			
	Part No.	380805	Ref. No.	—
	 <p>support bracket</p>			

time relays

time relays

 <p>1</p>			
Part No.	380485	Ref. No.	5405100 A88TZ80002
description	time relay		

 <p>1</p>				
Part No.	360104	Ref. No.	5405100 A88TZ80002	
description	time relay FINDER 88.12.0.230.0002 time range 0.05s-100h 24-230V AC/DC 2x5A mounting measurements 45x45mm 2CO connection plug-in connection round 8-pole			
accessories for	360104			
	Part No.	380638	Ref. No.	—
	 <p>relay socket 8-pole dimensions 51x41x23mm 250V 10A FINDER manuf. no. 90.26</p>			



transformers

open transformers

with cable connection



Part No.	403320	Ref. No.	A96ZN00039
description	transformer primary 230/400V secondary 24VAC 18VA connection cable 50/60Hz		



Part No.	403094	Ref. No.	8301350 8301350 con schedina 8301350 old
description	transformer primary 230/400VAC secondary 24VDC 18VA secondary 0.75A L 57mm W 26mm connection cable 50/60Hz with rectifier		
For models:	TF17, TF22, TF33, TF42, TF53, TR17, TR22, TR33, TR42, TR53		



Part No.	400783	Ref. No.	A96ZN00040
description	transformer primary 230VAC secondary 24VDC 12VA secondary 0.5A connection cable 50/60Hz		



Part No.	403323	Ref. No.	8301360 8301360 con schedina 8301360 old
description	transformer primary 230VAC secondary 24VDC 12VA secondary 0.5A connection cable 50/60Hz with rectifier		

encapsulated transformers

PMA



Part No.	379054	Ref. No.	5410200 A87AZ70001
description	transformer primary 230VAC secondary 12VAC 3VA secondary 0.25A H 40mm L 45mm W 50mm connection screw 50/60Hz type 153/M		
For models:	FG 2 50R, FG 2 50TA, FG 250 A		

electronic controllers

EVCO - EVERY CONTROL

universal controllers

built-in version

Part No.	379984	Ref. No.	5310150 A88TD66002
description	electronic controller EVERY CONTROL 0-700°C type EC8		



Part No.	379027	Ref. No.	5310150 A88TD66002
description	electronic controller EVERY CONTROL mounting measurements 66.5x138mm 230V voltage AC TC J/K protection IP54 0-700°C for pizza oven type EC8		



			
1			
Part No.	379590	Ref. No.	5310060 A88TD66001
description	electronic controller EVERY CONTROL mounting measurements 71x29mm 12V voltage AC TC/J protection IP65 0-500°C type FK400A front measurements 33x75mm		
For models:	FG 2 50R, FG 2 50TA, FG 2/50 A, FG 2/50 R, FG 250 A, PFD 30 N, PFD 33 N, PFD 40 N, PFD 45 N, PFD 50 N, PFD 55 N, PFD36		
accessories for	379590		
	Part No.	Ref. No.	5310200 A88SO79001
	temperature probe thermocouple J (Fe-CuNi) cable Vetrotex probe -50 up to +750°C cable -50 up to +350°C probe ø6x100mm cable length 3m without screw connection cable colours red/blue 2-wire		

accessories for	379520		
	Part No.	Ref. No.	—
	temperature probe thermocouple J (Fe-CuNi) cable Vetrotex probe -50 up to +750°C cable -50 up to +350°C probe ø4x50mm cable length 2m without screw connection 2-wire		
	Part No.	Ref. No.	—
	temperature probe thermocouple J (Fe-CuNi) cable Vetrotex probe 0 up to +350°C cable -50 up to +350°C probe ø6x100mm cable length 1.35m without screw connection cable colours red/blue 2-wire		
	Part No.	Ref. No.	—
	temperature probe thermocouple J (Fe-CuNi) cable Vetrotex probe -50 up to +750°C cable -50 up to +350°C probe ø4x100mm cable length 1m cable colours black/white 2-wire		

LAE

electronic thermometers

built-in version

			
71 x 29mm			
1			

Part No.	379520	Ref. No.	5310360 A88TC84002
description	thermometer LAE LT12CJE mounting measurements 71x29mm built-in depth 70mm 230V voltage AC TC(J) -50 to 700°C display 3 digits 1 RoomTempIN TC(J) defr. funct.		
accessories for	379520		
	Part No.	Ref. No.	—
	temperature probe thermocouple J (Fe-CuNi) cable Vetrotex probe -50 up to +750°C cable -50 up to +350°C probe ø4x150mm cable length 1.5m 2-wire		
	Part No.	Ref. No.	—
	temperature probe thermocouple J (Fe-CuNi) cable Vetrotex probe -50 up to +750°C cable -50 up to +350°C probe ø3x100mm cable length 3m without screw connection 2-wire		
	Part No.	Ref. No.	—
	temperature probe thermocouple J (Fe-CuNi) probe -50 up to +750°C cable -50 up to +350°C probe ø3 cable length 3m		
	Part No.	Ref. No.	5310200 A88SO79001
	temperature probe thermocouple J (Fe-CuNi) cable Vetrotex probe -50 up to +750°C cable -50 up to +350°C probe ø6x100mm cable length 3m without screw connection cable colours red/blue 2-wire		
	Part No.	Ref. No.	—
	temperature probe thermocouple J (Fe-CuNi) cable Vetrotex probe -50 up to +750°C cable -50 up to +350°C probe ø6x50mm cable length 3m without screw connection 2-wire		
	Part No.	Ref. No.	—
	temperature probe thermocouple J (Fe-CuNi) cable Vetrotex probe -50 up to +750°C cable -50 up to +350°C probe ø6x50mm cable length 1.9m without screw connection 2-wire		

SHANGFANG

accessories

			
1			

Part No.	379054	Ref. No.	5410200 A87AZ70001
description	transformer primary 230VAC secondary 12VAC 3VA secondary 0.25A H 40mm L 45mm W 50mm connection screw 50/60Hz type 153/M		
For models:	FG 2 50R, FG 2 50TA, FG 250 A		

miscellaneous

speed controllers

			
1			
Part No.	401679	Ref. No.	5423300
description	speed controller voltage input 230V/50Hz 1PhV voltage output 0-208/230V 0-240Hz 3PhV 1500W max. 18.4A load current 8.1A length external size 145mm width external size 115mm D 125mm wall-mounted version		
For models:	PFD 30 N, PFD 33 N, PFD 40 N, PFD 45 N, PFD 50 N, PFD 55 N, PFD36		

probes

universal probes

temperature probes

			
1			
Part No.	379051	Ref. No.	5310200 A88SO79001
description	temperature probe thermocouple J (Fe-CuNi) cable Vetrotex probe -50 up to +750°C cable -50 up to +350°C probe ø6x100mm cable length 3m without screw connection cable colours red/blue 2-wire		
accessories for	379051		
	Part No.	Ref. No.	—
	electronic controller HONEYWELL type DC10N-400 mounting measurements 92x92mm 24/230V voltage AC TC (J) relay outputs 1 CO-10A(6) TC (J) universal built-in depth 55mm protection IP54 accuracy 1% built-in version defr. funct. no 0 up to +400°C display 3 digits		

electric components



electronics

electronics accessories



1

Part No.	697352	Ref. No.	5320750 A86PQ42001
description	spacer piece for PCB H 6mm thread M4		
For models:	P30, P30T, P30TA, P35A, P35TA, P40, P40A, P40T, P40TA, P45A, P45HTA, P45TA		

PCBs

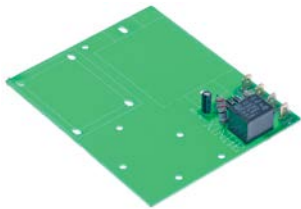

1

Part No.	403208	Ref. No.	8301960 A96ZN00055
description	control PCB dough mixers TF17/22/30 TR17/22/30 L 124mm W 102mm 230/400V		
For models:	TR17, TR22		

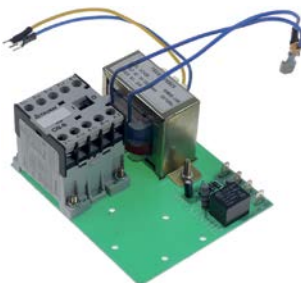

1

Part No.	402836	Ref. No.	A96ZN00091
description	control PCB for dough mixer L 124mm W 102mm cable length 200mm		

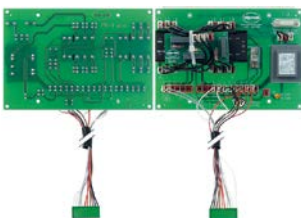

1

Part No.	400731	Ref. No.	5310090 A88SE66001
description	main PCB pizza press Pressy 33/45		
For models:	PFD 50, PFD33, PFD45		



1

Part No.	400734	Ref. No.	5310190 A88CY79001
description	PCB		
For models:	FG 1/60 A, FG 1/60 R, FG 1/6090 A, FG 1/6090 R, FG 1/90 A, FG 1/90 R, FG 1/9060 A, FG 1/9060 R, FG 2/60 A, FG 2/60 R, FG 2/6090 A, FG 2/6090 R, FG 2/90 A, FG 2/90 R, FG 2/9060 A, FG 2/9060 R, FGS 1/6090 A, FGS 1/6090 R, FGS 1/90 A, FGS 1/90 R, FGS 1/9060 A, FGS 1/9060 R, FGS 2/6090 A, FGS 2/6090 R, FGS 2/90 A, FGS 2/90 R, FGS 2/9060 A, FGS 2/9060 R, FVD 2/33, FVD 2/50, FVD 3/33, FVD 3/50, FVD 5/33, FVD 5/50		



1

Part No.	692027	Ref. No.	5310000 A88CY78001
description	PCB dough rolling machine STP30/40 new edition 230V		
For models:	P30, P30T, P30TA, P35A, P35TA, P40, P40A, P40T, P40TA, P45A, P45HTA, P45TA		



1

Part No.	401290	Ref. No.	5310040 A88TZ66001
description	PCB time control		
For models:	PFD 50, PFD33, PFD45		



1

Part No.	380430	Ref. No.	5310070 A88SE81001
description	relay PCB pizza oven FGM 1/90		
For models:	FG 1/90 A, FG 1/90 R, FG 2/90 A, FG 2/90 R, FG 2/9060 A, FG 2/9060 R, FGM 1/90 A, FGM 1/90 R, FGM 2/90 A, FGM 2/90 R, FGM 2/9060 A, FGM 2/9060 R, FGMS 1/90 A, FGMS 1/90 R, FGMS 2/90 A, FGMS 2/90 R, FGMS 2/9060 A, FGMS 2/9060 R, FGS 1/60 A, FGS 1/60 R, FGS 1/90 A, FGS 1/90 R, FGS 2/60 A, FGS 2/60 R, FGS 2/90 A, FGS 2/90 R, FGS 2/9060 A, FGS 2/9060 R, FVD 2/33, FVD 2/50, FVD 3/33, FVD 3/50, FVD 5/33, FVD 5/50		

1

Part No.	381384	Ref. No.	A88SE81002
description	relay PCB pizza oven FGM 1/90		

central units



1

Part No.	401684	Ref. No.	8301030 A96ZO00003
description	control box 400V		

keypads

front foils



1

Part No.	400733	Ref. No.	5800390 A93OL65023
description	keypad foil		
For models:	FG 1/60 A, FG 1/60 R, FG 1/6090 A, FG 1/6090 R, FG 1/90 A, FG 1/90 R, FG 1/9060 A, FG 1/9060 R, FG 2/60 A, FG 2/60 R, FG 2/6090 A, FG 2/6090 R, FG 2/90 A, FG 2/90 R, FG 2/9060 A, FG 2/9060 R, FGS 1/60 A, FGS 1/60 R, FGS 1/6090 A, FGS 1/6090 R, FGS 1/90 A, FGS 1/90 R, FGS 1/9060 A, FGS 1/9060 R, FGS 2/60 A, FGS 2/60 R, FGS 2/6090 A, FGS 2/6090 R, FGS 2/90 A, FGS 2/90 R, FGS 2/9060 A, FGS 2/9060 R		



1

Part No.	401587	Ref. No.	5800370 A93OL78007
description	keypad foil dough rolling machine STP 30/40 P30/40/45/35 Start/Stop L 100mm W 80mm		
For models:	P30, P30T, P30TA, P35A, P35TA, P40, P40A, P40T, P40TA, P45A, P45HTA, P45TA		

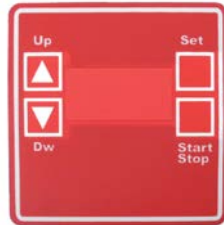

1

Part No.	400735	Ref. No.	5800380 A93OL65022
description	keypad foil pizza oven FVD 2/33 2/50 3/33 3/50 5/33 5/50 L 88mm W 85mm		
For models:	FVD 2/33, FVD 2/50, FVD 3/33, FVD 3/50, FVD 5/33, FVD 5/50		

control panel

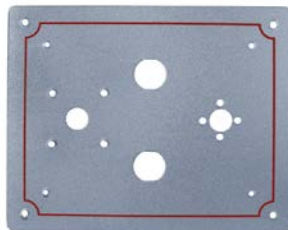

1

Part No.	697351	Ref. No.	8301040 A96ZC00009
description	switch panel dough mixers TF17/22/30 TR17/22/30 L 200mm W 160mm		
For models:	TF17, TF22, TF33, TF42, TF53, TR17, TR22, TR33, TR42, TR53		

fans

axial fans

import



1

Part No.	601080 ¹	Ref. No.	5371400 A87VN00002
description	axial fan L 119mm W 119mm H 38mm 230VAC 50/60Hz 23/20W bearing ball bearing connection male faston 2.8mm metal ADDA fan wheel ø 110mm temp.-resist. 70°C		
For models:	FG 1/60 A, FG 1/60 R, FG 1/6090 A, FG 1/6090 R, FG 1/90 A, FG 1/90 R, FG 1/9060 A, FG 1/9060 R, FG 2/60 A, FG 2/60 R, FG 2/6090 A, FG 2/6090 R, FG 2/90 A, FG 2/90 R, FG 2/9060 A, FG 2/9060 R, FGS 1/60 A, FGS 1/60 R, FGS 1/6090 A, FGS 1/6090 R, FGS 1/90 A, FGS 1/90 R, FGS 1/9060 A, FGS 1/9060 R, FGS 2/60 A, FGS 2/60 R, FGS 2/6090 A, FGS 2/6090 R, FGS 2/90 A, FGS 2/90 R, FGS 2/9060 A, FGS 2/9060 R, FVD 2/33, FVD 2/50, FVD 3/33, FVD 3/50, FVD 5/33, FVD 5/50		
accessories for	601080		
	Part No.	550898	Ref. No. —
	connecting cable cable length 2000mm connection F 2.8 connection distance 7.9mm for axial flow fan		

¹with ball bearings
Table continues overleaf



accessories for	601080		
	Part No.	692519	Ref. No. —
	guard L 120mm W 120mm plastic		

accessories

fan guards



Part No.	691104	Ref. No.	5371410 A87VN00003
description	guard ø 115mm mounting distance 105mm for axial fan 119mm		

speed controllers



Part No.	401679	Ref. No.	5423300
description	speed controller voltage input 230V/50Hz 1PhV vottage output 0-208/230V 0-240Hz 3PhV 1500W max. 18.4A load current 8.1A length external size 145mm width external size 115mm D 125mm wall-mounted version		
For models:	PFD 30 N, PFD 33 N, PFD 40 N, PFD 45 N, PFD 50 N, PFD 55 N, PFD36		

motors

motors

universal



Part No.	500471	Ref. No.	8300530 A87MR55012 A87MR56009
description	motor 1100W 400V 50/60Hz 3 phase shaft ø 19mm flange ø 120mm 1370/1700rpm type AT80C4 ø 160mm H 200mm L 250mm Lafert		
For models:	TF17, TF22, TR17, TR22		





Part No.	501558	Ref. No.	A87MR56009 old version
description	motor 1100W 400V 50Hz 3 phase shaft ø 19mm flange ø 120mm 1400rpm type VL2 803-4 ø 160mm H 200mm L 250mm VELA		



Part No.	500472	Ref. No.	8300540 A96ZJ00014
description	motor 2000W 400V 50Hz 3 phase shaft ø 24mm flange ø 140mm 1400rpm type YS9034 ø 170mm H 210mm L 290mm TIANYANG 2kW		
For models:	TF33, TF42, TF53, TR33, TR42, TR53		



Part No.	501436	Ref. No.	A87MR55020
description	motor 220-230V 50Hz shaft ø 11mm ø 133mm H 195mm		
accessories for	501436		
	Part No.	365014	Ref. No. —
	operating capacitor capacity 12.5µF 450V tolerance 5%Hz ambient temperature max. -25 to +85°C ø 35mm L 70mm M8 plastic connection male faston 6.3mm 45S.C3DS.12.5 protection		

1

Part No.	500903	Ref. No.	5420200
description	motor 250W 230V 50Hz 1 phase shaft ø 14mm flange ø 160mm 1400rpm type M71B4 ø 140mm H 180mm L 220mm ICME 0.25kW		
For models:	P30, P30A, P30AE, P30T, P30TA, P40		



1

Part No.	601179	Ref. No.	5420800 A87MR56004
description	motor 550W 230/400V 50Hz 3 phase shaft ø 14mm flange ø 105mm 1400rpm type T71BX4 ø 140mm H 170mm L 220mm ICME 0.55kW		
For models:	PFD33		



1

Part No.	501373	Ref. No.	5420200alt
description	motor 250W 230V 50Hz 1 phase shaft ø 14mm flange ø 160mm 1420rpm type 62 ø 140mm L 260mm 0.25kW shaft length 32mm		



1

Part No.	601180	Ref. No.	5420900 A87MR56005
description	motor 550W 230/400V 50Hz 3 phase shaft ø 19mm flange ø 120mm 1400rpm type AIS80A4 ø 160mm H 175mm L 230mm VELA 0.55kW		
For models:	PFD 50, PFD45		



1

Part No.	501404	Ref. No.	2420200 A87MR55002 A87MR55003 A87MR55003+4xS56MT54001+2xS42F5 Bonani S4CAB030 Bonani S4CBB030
description	motor 370W 230V 50Hz 1 phase shaft ø 14mm flange ø 160mm 1370rpm type S71B4 L 260mm 0.37kW shaft length 32mm		



1

Part No.	500904	Ref. No.	5420310 A87MR55004
description	motor 550W 230V 50Hz 1 phase shaft ø 14mm flange ø 160mm 1400rpm type M80B4 ø 150mm H 200mm L 230mm ICME 0.55kW		
For models:	P45HTA		



1

Part No.	500821	Ref. No.	5420300 A87MR55003
description	motor 370W 230V 50Hz 1 phase shaft ø 14mm flange ø 160mm 1400rpm ø 140mm H 180mm L 220mm ICME 0.37kW		
For models:	P35A, P35TA, P40, P40A, P40T, P40TA, P45A, P45TA		



1

Part No.	500473	Ref. No.	PF08300
description	motor 750W 230/400V 50Hz 3 phase shaft ø 19mm flange ø 120mm 1400rpm type F580B4 ø 150mm H 200mm L 240mm ICME 0.75kW		
For models:	PFD 30 N, PFD 33 N, PFD 40 N, PFD 45 N, PFD 50 N, PFD 55 N, PFD36		



fuses

fine fuses

fine fuse holders



1

Part No.	358388	Ref. No.	8301070 A96ZN00033
description	fuse holder suitable fuse $\phi 6.3 \times 32\text{mm}$ $\phi 15.2\text{mm}$ 15A rated 250V connection male faston 4.8mm		
For models:	TF17, TF22, TF33, TF42, TF53, TR33, TR42, TR53		

equipment-specific units

for meat mincers

gear wheels



1

Part No.	697241	Ref. No.	8300720 A96ZH00009
description	sprocket-wheel DIN/ISO 06 B-1 splitting 3/8" teeth 16 shaft intake $\phi 25\text{mm}$ H 28mm 25-38 S-C-F		
For models:	TF33, TF42, TF53, TR33, TR42, TR53		



1

Part No.	697256	Ref. No.	8300240 A96ZR00005
description	sprocket-wheel DIN/ISO 06 B-1 splitting 3/8" teeth 85 shaft intake $\phi 60\text{mm}$ H 5mm 25-38 S-C-F		
For models:	TF33, TF42, TF53, TR33, TR42, TR53		



1

Part No.	697130	Ref. No.	8300860 A96ZH00011
description	sprocket-wheel DIN/ISO 08 B-1 splitting 1/2" teeth 29 shaft intake $\phi 25\text{mm}$ H 30mm 33-42-53 TF-TR		
For models:	TF33, TF42, TF53, TR33, TR42, TR53		

for dough mixers

drive shafts



1

Part No.	697335	Ref. No.	8301900 8301900+5227370+5227570 A86ME36003+A86ME36006 A96ZI00030 siehe Bemerkung
description	drive shaft D1 $\phi 20\text{mm}$ for gearbox $\phi 25\text{mm}$ L 487mm D2 $\phi 20\text{mm}$		



1

Part No.	697336	Ref. No.	8301910 S63TR67002
description	drive shaft D1 $\phi 25\text{mm}$ for gearbox $\phi 25\text{mm}$ L 545mm D2 $\phi 25\text{mm}$		



1

Part No.	697337	Ref. No.	8301920 A96ZI00031
description	drive shaft D1 $\phi 25\text{mm}$ for gearbox $\phi 28\text{mm}$ L 545mm D2 $\phi 25\text{mm}$		



1

Part No.	697394	Ref. No.	8300810 A96ZI00022
description	drive shaft D1 $\phi 25\text{mm}$ $\phi 22\text{mm}$ L 295mm D2 $\phi 20\text{mm}$		
For models:	TF17, TF22		



1

Part No.	697314	Ref. No.	8101200 8300460 A96ZI00015
description	drive shaft D1 $\phi 30\text{mm}$ for dough hook $\phi 25\text{mm}$ L 84mm IT M18x1.5		
For models:	TF17, TF22, TR17, TR22		



1

Part No.	697315	Ref. No.	8300470 A96ZI00016
description	drive shaft for dough hook $\phi 30\text{mm}$ L 96mm 33-42-53 TF-TR IT M22x1.5		
For models:	TF33, TF42, TF53, TR33, TR42, TR53		

lids

protective grid



1

Part No.	697320	Ref. No.	8300000 A96ZE00007
description	guard $\phi 340\text{mm}$ 17		
For models:	TF17, TF22, TR17		

1

Part No.	697321	Ref. No.	8300010 A96ZE00008
description	guard ø 380mm 22		
For models:	TR22		



1

Part No.	697322	Ref. No.	8300020 A96ZE00009
description	guard ø 420mm 33		
For models:	TF33, TR33		

flange bearings



1

Part No.	693112	Ref. No.	8300830 A96ZI00024
description	flange bearing type UCF204 shaft ø 20mm 4 hole flange hole distance 64mm H 33mm flange length 86mm flange width 86mm hole ø 12mm flange F204 ball bearing UC204G2 FH 25.5mm		
For models:	TF17, TF22, TR17, TR22		



1

Part No.	697278	Ref. No.	8300840 A96ZI00025
description	flange bearing type UCF205 shaft ø 25mm 4 hole flange hole distance 70mm H 36mm flange length 95mm flange width 95mm hole ø 12mm flange F205 ball bearing UC205G2 FH 27mm		
For models:	TF33, TF42, TF53, TR33, TR42, TR53		

gearboxes



1

Part No.	697840	Ref. No.	8300590 A96ZL00008 A96ZL00008+4xA86ME32016 siehe Bemerkung
description	gearbox motor shaft ø 25mm flange ø 120mm transmission 1/30 drive shaft ø 19mm type 50		
For models:	TF17, TF22, TR17, TR22		

chains

roller chains 06B-1 single



1

Part No.	697127	Ref. No.	8300870 S14MT67001
description	roller chain DIN/ISO 06 B-1 splitting 3/8" / 9.525mm links 42 internal width 5.72mm rollerø 6.35mm single		
For models:	TF17, TF22, TR17		



1

Part No.	697126	Ref. No.	8300210 A96ZN00022 S14MT67007
description	roller chain DIN/ISO 06 B-1 splitting 3/8" / 9.525mm links 63 internal width 5.72mm rollerø 6.35mm		
For models:	TF17, TF22, TF33, TR17, TR22		



1

Part No.	697112	Ref. No.	8300220 A96ZN00023 S14MT67008
description	roller chain DIN/ISO 06 B-1 splitting 3/8" / 9.525mm links 74 internal width 5.72mm rollerø 6.35mm single		
For models:	TF33, TF42, TF53, TR33, TR42, TR53		

roller chains 08B-1 single



1

Part No.	697128	Ref. No.	8300880 S14MT67002
description	roller chain DIN/ISO 08 B-1 splitting 1/2" / 12.7mm links 37 internal width 7.75mm rollerø 8.51mm single		
For models:	TF33, TR33		



dough hooks

with mounting thread



1			
Part No.	698566	Ref. No.	8308500 A96ZS00012 A96ZS00012+A96ZH00016
description	dough hook		



1			
Part No.	697316	Ref. No.	8300480 A96ZS00004
description	dough hook thread M18x1.5 usable height 220mm 17-22 TF-TR		
For models:	TF17, TF22, TR17, TR22		



1			
Part No.	697317	Ref. No.	8300490 A96ZS00005
description	dough hook thread M22x1.5 usable height 285mm 33-42-53 TF-TR		
For models:	TF33, TF42, TF53, TR33, TR42, TR53		

bearing blocks



1			
Part No.	697324	Ref. No.	8301490 A96ZS00007
description	bearing block for dough hook mounting pos. upper ø 140mm ID ø 52mm int. ø 1 55mm H 90mm 33-42-53 TF-TR		
For models:	TF33, TF42, TF53, TR33, TR42, TR53		



1			
Part No.	697323	Ref. No.	8301480 A96ZS00006
description	bearing block for dough hook mounting pos. upper ø 107mm ID ø 52mm H 57mm 17-22 TF-TR		
For models:	TF17, TF22, TR17, TR22		



1			
Part No.	697325	Ref. No.	8300200 A96ZV00025
description	bearing block for mixer bowl mounting pos. lower ø 148mm ID ø 52mm H 83mm		
For models:	TF17, TF22, TF33, TF42, TF53, TR17, TR22, TR33, TR42, TR53		

pulleys



1			
Part No.	693925	Ref. No.	3150200 S74RU54005
description	round belt pulley disc ø 110mm single shaft intake ø 14mm groove depth 3mm disc width 12mm groove width 8mm overall width 20mm metal P45 shaft ø 48mm		



1			
Part No.	693924	Ref. No.	3150010 S74RU54001
description	round belt pulley disc ø 90mm single shaft intake ø 14mm groove depth 3mm disc width 12mm groove width 8mm overall width 20mm metal P45 shaft ø 4.8mm		

dough separator



1			
Part No.	697339	Ref. No.	8301210 A96ZA00001
description	pastry rod L 330mm W 30mm thickness 10mm hole distance 60mm hole ø 11mm 17-22 TF-TR		
For models:	TF17, TF22, TR17		



1



Part No.	697340	Ref. No.	8301220 A96ZA00002
description	pastry rod L 405mm W 30mm thickness 10mm hole distance 60mm hole ø 12mm TF-TR 33		
For models:	TF33, TR33		

spindles
for lids

1



Part No.	697137	Ref. No.	8300270 S63FS67001
description	spindle for lid ø 15mm D1 ø 13mm L 250mm		
For models:	TF33, TF42, TF53, TR33, TR42, TR53		

1



Part No.	697136	Ref. No.	8300260 A96ZI00014
description	spindle for lid ø 15mm L 210mm		
For models:	TF17, TF22, TR17, TR22		

for mixer bowls

1



Part No.	697135	Ref. No.	8300250 A96ZI00013
description	spindle for mixer bowl ø 25mm D1 ø 30mm L 176mm		
For models:	TF17, TF22, TF33, TF42, TF53, TR17, TR22, TR33, TR42		

gear wheels

1



Part No.	697134	Ref. No.	8101800 8300710 A96ZH00004 A96ZH00008	
description	sprocket-wheel DIN/ISO 06 B-1 splitting 3/8" teeth 14 shaft intake ø 22mm H 25mm 17-22 TF-TR			
For models:	TF17, TF22, TR17, TR22			
accessories for	697134			
	Part No.	560207	Ref. No.	8300280 A86ME32013
	grub screw thread M8 L 10mm steel DIN 916/ISO 4029 intake internal hexagon WS 4 Qty 1 pcs			

1



Part No.	697132	Ref. No.	8300410 A96ZH00006
description	sprocket-wheel DIN/ISO 06 B-1 splitting 3/8" teeth 15 shaft intake ø 25mm 17-22 TF-TR		
For models:	TF17, TF22, TR17, TR22		

1



Part No.	697241	Ref. No.	8300720 A96ZH00009
description	sprocket-wheel DIN/ISO 06 B-1 splitting 3/8" teeth 16 shaft intake ø 25mm H 28mm 25-38 S-C-F		
For models:	TF33, TF42, TF53, TR33, TR42, TR53		

1



Part No.	697129	Ref. No.	8300850 A96ZH00010 S14MT67009
description	sprocket-wheel DIN/ISO 06 B-1 splitting 3/8" teeth 29 shaft intake ø 20mm 17-22 TF-TR		
For models:	TF17, TF22, TR17, TR22		

1





Part No.	697131	Ref. No.	8300230 A96ZR00004
description	sprocket-wheel DIN/ISO 06 B-1 splitting 3/8" teeth 72 shaft intake ø 60mm H 5mm 17-22 TF-TR		
For models:	TF17, TF22, TR17, TR22		



			
1			
Part No.	697256	Ref. No.	8300240 A96ZR00005
description	sprocket-wheel DIN/ISO 06 B-1 splitting 3/8" teeth 85 shaft intake ø 60mm H 5mm 25-38 S-C-F		
For models:	TF33, TF42, TF53, TR33, TR42, TR53		

			
1			
Part No.	697133	Ref. No.	8300420 A96ZH00007
description	sprocket-wheel DIN/ISO 08 B-1 splitting 1/2" teeth 15 shaft intake ø 30mm H 28mm 33-42-53 TF-TR		
For models:	TF33, TF42, TF53, TR33, TR42, TR53		

			
1			
Part No.	697130	Ref. No.	8300860 A96ZH00011
description	sprocket-wheel DIN/ISO 08 B-1 splitting 1/2" teeth 29 shaft intake ø 25mm H 30mm 33-42-53 TF-TR		
For models:	TF33, TF42, TF53, TR33, TR42, TR53		

miscellaneous			
			
1			
Part No.	697350	Ref. No.	8300370 A96ZE00012
description	bush for lid		
For models:	TF17, TF22, TF33, TF42, TF53, TR33, TR42, TR53		

			
1			
Part No.	697318	Ref. No.	8301590 A96ZL00010
description	flange for gearbox ø 100mm ID ø 70mm		
For models:	TF17, TF22, TR17, TR22		

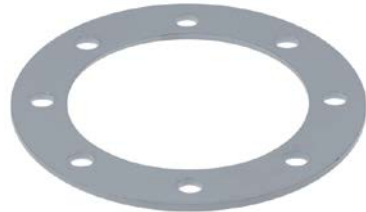
			
1			
Part No.	697319	Ref. No.	8301600 A96ZL00011
description	flange for gearbox ø 140mm ID ø 95mm		
For models:	TF33, TF42, TF53, TR33, TR42, TR53		

			
1			
Part No.	697353	Ref. No.	8301270 A96ZD00002
description	stop bolt for lid ø 20mm L 15mm		
For models:	TF17, TF22, TF33, TF42, TF53, TR17, TR22, TR33, TR42, TR53		

for dough roller

wipers			
			
1			
Part No.	693895	Ref. No.	4001020 S43RA54004
description	wiper for dough roller L 330mm mounting pos. front P30		
For models:	P30, P30A, P30AE, P30T, P30TA		

			
1			
Part No.	693898	Ref. No.	4001010 S43RA54003
description	wiper for dough roller L 330mm mounting pos. rear P30		
For models:	P30, P30A, P30AE, P30T, P30TA		





1

Part No.	693896	Ref. No.	4001030 S43RA54005
description	wiper for dough roller L 456mm mounting pos. front P40		
For models:	P40, P40A, P40T, P40TA		



1

Part No.	693899	Ref. No.	4001040 S43RA54006
description	wiper for dough roller L 456mm mounting pos. rear P40		
For models:	P40, P40A, P40T, P40TA		



1

Part No.	693897	Ref. No.	4001060 S43RA54008
description	wiper for dough roller L 498mm mounting pos. front P45		



1

Part No.	693900	Ref. No.	4001050 S43RA54007
description	wiper for dough roller L 498mm mounting pos. rear P45		

roll units (complete)



1

Part No.	696604	Ref. No.	S51RL54009
description	roller assembly L 360mm mounting pos. upper		

rollers



1

Part No.	693901	Ref. No.	3003100 S75CD54001
description	roller L 167mm ø 48mm mounting pos. upper at the back		
For models:	P30, P30A, P30AE, P30T, P30TA		



1

Part No.	693905	Ref. No.	3003000 S75EC54001
description	roller L 167mm ø 48mm mounting pos. upper in the front		
For models:	P30, P30A, P30AE, P30T, P30TA		



1

Part No.	693903	Ref. No.	3003150 S75CD54003
description	roller L 218mm ø 48mm mounting pos. upper at the back		
For models:	P35A, P35TA, P40, P40A, P45A		



1

Part No.	693906	Ref. No.	3003050 S75EC54003
description	roller L 218mm ø 48mm mounting pos. upper in the front		
For models:	P35A, P35TA, P40, P40A, P45A		



1

Part No.	693908	Ref. No.	3003800 S75EC54005
description	roller L 298mm ø 48mm mounting pos. bottom in the front		
For models:	P30, P30A, P30AE, P30T, P30TA		

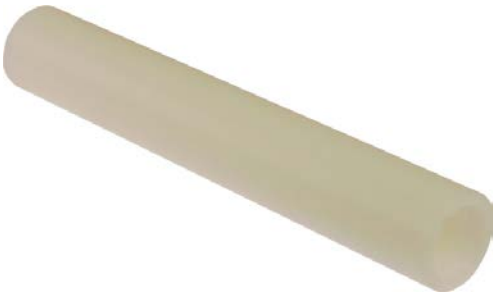

1

Part No.	693911	Ref. No.	3003900 S75CD54005
description	roller L 298mm ø 48mm mounting pos. bottom at the back		



1

Part No.	693907	Ref. No.	3003160 S75EC54004
description	roller L 298mm ø 52mm mounting pos. upper in the front		
For models:	P40T, P40TA, P45HTA, P45TA		



1

Part No.	693932	Ref. No.	3003900 S75CD54005
description	roller L 298mm ø 48mm mounting pos. bottom at the back		
For models:	P30, P30A, P30AE, P30T, P30TA		



1

Part No.	693904	Ref. No.	3003180 S75CD54004
description	roller L 298mm ø 56mm mounting pos. upper at the back		
For models:	P40T, P40TA, P45HTA, P45TA		



1

Part No.	693912	Ref. No.	3003950 S75CD54008
description	roller L 422mm ø 48mm mounting pos. bottom at the back		
For models:	P40, P40A, P40T, P40TA		



1

Part No.	693910	Ref. No.	3003920 S75EC54008
description	roller L 464mm ø 52mm mounting pos. bottom in the front		
For models:	P45A, P45HTA, P45TA		



1

Part No.	693909	Ref. No.	3003850 S75EC54007
description	roller L 422mm ø 48mm mounting pos. bottom in the front		
For models:	P40, P40A, P40T, P40TA		

1

Part No.	693838	Ref. No.	3003800 S75EC54005
description	roller mounting pos. lower		

housing and bezels

1

Part No.	697286	Ref. No.	4100050 A90FF78002
description	housing plastic P40		
For models:	P40, P40T, P45A, P45HTA, P45TA		



1

Part No.	693913	Ref. No.	3003930 S75CD54007
description	roller L 464mm ø 52mm mounting pos. bottom at the back		
For models:	P45A, P45HTA, P45TA		

holders



1

Part No.	694566	Ref. No.	3503800 S51GN54001
description	bracket for dough roller complete with handle hole ø 10mm H 20mm hole distance 32mm red		
For models:	P30, P30A, P30AE, P30T, P30TA, P40, P40A, P40T, P40TA, P40TAE, P45TA		

1

Part No.	693658	Ref. No.	3503800
description	lever hole ø 10mm H 20mm hole distance 32mm		

levers



1

Part No.	700666	Ref. No.	3004500 A98DL54001
description	lever for dough roller P30		
For models:	P30, P30A, P30AE		



1

Part No.	697338	Ref. No.	3004550 A98DL54002
description	lever shaft intake ø 8.3mm L 230mm P40		
For models:	P35A, P40, P40A, P45A		

accessories



1

Part No.	700667	Ref. No.	3004600 S54PX54001 S54PX54005
description	balance weight for dough roller ø 25mm L 15mm thread M5		
For models:	P30, P30A, P30AE		



1

Part No.	697348	Ref. No.	3004650 S54PX54002 S79BL54001
description	balance weight for dough roller ø 25mm L 20mm thread M5		
For models:	P35A, P40, P40A, P45A		

couplings



1

Part No.	692011	Ref. No.	4203200	
description	coupling ø 41.5mm ID ø 25mm H 12mm			
For models:	P30, P30AE, P30T, P30TA, P40, P40T, P40TA, P40TAE, P45TA			
accessories for	692011			
	Part No.	692012	Ref. No.	—
	coupling ø 35mm ID ø 25mm H 14mm			



1

Part No.	693646	Ref. No.	4203250 S51GN54005
description	coupling set ø 42.8mm ID ø 25mm H 21mm		
For models:	P30, P30A, P30AE, P30T, P30TA, P35A, P35TA, P40, P40A, P40T, P40TA, P40TAE, P45A, P45HTA, P45TA		



1

Part No.	693919	Ref. No.	4203300 S51GN54005
description	mixer coupling		
For models:	P30AE		

pulleys



1

Part No.	693927 ¹	Ref. No.	3150050 S74RU54003
description	round belt pulley disc ø 70mm double shaft intake ø 14mm groove depth 3mm disc width 28mm groove width 9mm overall width 30mm metal P45		
For models:	P30AE		

¹double



 <p>1</p>			
Part No.	693926 ¹	Ref. No.	3150080 A90UL78002
description	round belt pulley disc ø 76mm double shaft intake ø 14mm groove depth 6mm disc width 29mm groove width 10mm overall width 32mm plastic P30-P40		
For models:	P30, P30A, P30T, P30TA, P35A, P35TA, P40, P40A, P40T, P40TA, P45A, P45HTA, P45TA		

¹double

 <p>1</p>			
Part No.	697285 ¹	Ref. No.	3150030 A90UL78001
description	round belt pulley disc ø 96mm double shaft intake ø 14mm type 14x11 groove depth 6mm disc width 29mm groove width 10mm overall width 31mm plastic P30-P40 shaft ø 24mm		
For models:	P30, P30A, P30AE, P30T, P30TA, P35A, P35TA, P40, P40A, P40T, P40TA, P45A, P45HTA, P45TA		

¹double

pinions

rear mounting

 <p>1</p>			
Part No.	697109	Ref. No.	3203510 3203511 A90IG78002
description	pinion ø 47.5mm H 35mm mounting pos. rear ID ø 25mm for dough roller		
For models:	P30, P30A, P30AE, P30T, P30TA, P35A, P35TA, P40, P40A, P40T, P40TA, P40TAE, P45A, P45HTA, P45TA		

front mounting

 <p>1</p>			
Part No.	697108	Ref. No.	3203410 3203411 A90IG78001
description	pinion ø 47.5mm H 35mm mounting pos. front ID ø 14mm for dough roller		
For models:	P30, P30A, P30AE, P30T, P30TA, P35A, P35TA, P40, P40A, P40T, P40TA, P40TAE, P45A, P45HTA, P45TA		

springs

 <p>1</p>			
Part No.	693920	Ref. No.	5003010 A86ME29001
description	spring for pinion ø 49mm thickness 1.5mm Qty 2 pcs		
For models:	P30, P30A, P30AE, P30T, P30TA, P35A, P35TA, P40, P40A, P40T, P40TA, P40TAE, P45A, P45HTA, P45TA		

roller covers

upper

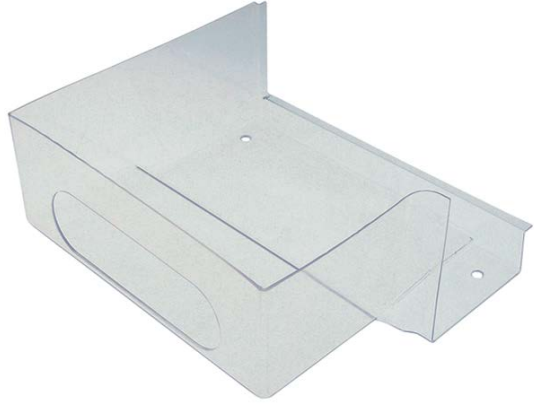
 <p>1</p>			
Part No.	697307	Ref. No.	4100400 A90SU78010
description	hand protection mounting pos. upper L 290mm W 250mm H 125mm		
For models:	P30, P35A, P35TA, P40, P40A, P45A		

 <p>1</p>			
Part No.	697343	Ref. No.	4100380 A90SU78009
description	hand protection mounting pos. upper L 360mm W 130mm H 250mm P40		
For models:	P40T, P40TA, P45HTA, P45TA		



1

Part No.	697342	Ref. No.	4100060 A90SU78001
description	hand protection mounting pos. upper P30		
For models:	P30, P30A, P30AE, P30T, P30TA, P45A, P45HTA, P45TA		

bottom



1

Part No.	692645	Ref. No.	S61IE54020
description	hand protection mounting pos. lower L 440mm W 62mm H 82mm RM 42 edition since 2012		



1

Part No.	692299	Ref. No.	S61IE54003 3700410
description	hand protection mounting pos. lower L 440mm W 90mm H 70mm RM 42 edition until 2011		



1

Part No.	697341	Ref. No.	4100070 A90SU78002
description	hand protection mounting pos. lower P30		
For models:	P30, P30A, P30AE, P30T, P30TA		

side parts



1

Part No.	697332	Ref. No.	3003400 S52RD54001
description	side panel for dough roller mounting pos. upper right W 40mm L 125mm H 100mm P30-P40 bore ø 14.3mm depth of bore 19mm		
For models:	P30, P30A, P30AE, P30T, P30TA, P35A, P35TA, P40, P40A, P45A		



1

Part No.	697333	Ref. No.	3003450 S31RD54001
description	side panel for dough roller mounting pos. upper right W 40mm L 135mm H 100mm P40T		
For models:	P40T, P40TA, P45HTA, P45TA		



1

Part No.	693922	Ref. No.	3004200 3004201 S52RD54004 S52RD54005
description	side panel for dough roller mounting pos. upper/lower right W 40mm L 125mm H 100mm P30-P40		
For models:	P30, P30A, P30T, P30TA, P35A, P35TA, P40, P40A, P40T, P40TA, P45A		





1

Part No.	691911	Ref. No.	3004300 S52IE54003
description	side panel for dough roller mounting pos. bottom left W 20mm L 115mm H 80mm P30-P40		
For models:	P30, P30A, P30AE, P30T, P30TA, P35A, P35TA, P40, P40A, P40T, P40TA, P45A		





 <p>1</p>			
Part No.	694448	Ref. No.	3004301 S52IE54004
description	side panel for dough roller mounting pos. bottom left W 20mm L 117mm H 80mm P30-P40		

 <p>1</p>			
Part No.	692040	Ref. No.	3003410 S52SR54001 S52SR54005
description	side panel for dough roller mounting pos. upper left W 20mm L 115mm H 80mm P30-P40		
For models:	P30, P30A, P30AE, P30T, P30TA, P35A, P35TA, P40, P40A, P45A		

 <p>1</p>			
Part No.	697334	Ref. No.	3003550 S52SR54002 S52SR54007
description	side panel for dough roller mounting pos. upper left W 20mm L 125mm H 80mm P40T		
For models:	P40T, P40TA, P45HTA, P45TA		

<p>spindles</p>  <p>1</p>			
Part No.	693923	Ref. No.	3003650 S63TR54003 S63TR54009
description	spindle ø 22mm L 156mm		
For models:	P30, P30AE, P30T, P30TA, P35A, P35TA, P40, P40A, P40T, P40TA, P45A		

<p>bars</p>  <p>1</p>			
Part No.	693915	Ref. No.	3100400 S61RL54001
description	bar ø 5mm L 315mm P30		
For models:	P30, P30A, P30AE, P30T, P30TA		

 <p>1</p>			
Part No.	693916	Ref. No.	3100500 S61RL54003
description	bar ø 5mm L 440mm P40		
For models:	P40, P40A, P40T, P40TA		

 <p>1</p>			
Part No.	693917	Ref. No.	3100600 S61RL54004
description	bar ø 5mm L 480mm P45		
For models:	P45A, P45HTA, P45TA		

<p>spindles</p> <p>eccentric</p>  <p>1</p>			
Part No.	693890	Ref. No.	3003200 S63EC54001
description	spindle ø 25mm L 244mm mounting pos. upper in the front eccentric		
For models:	P30, P30A, P30AE, P30T, P30TA		

 <p>1</p>			
Part No.	693891	Ref. No.	3003250 S63EC54002
description	spindle ø 25mm L 293mm mounting pos. upper in the front eccentric		
For models:	P35A, P35TA, P40, P40A, P45A		

 <p>1</p>			
Part No.	693892	Ref. No.	3004000 S63EC54003
description	spindle ø 25mm L 373mm mounting pos. upper in the front eccentric		
For models:	P30, P30A, P30AE, P30T, P30TA, P40T, P40TA, P45HTA, P45TA		

 <p>1</p>			
Part No.	693893	Ref. No.	3004050 S63EC54004
description	spindle ø 25mm L 499mm mounting pos. bottom in the front eccentric		
For models:	P40, P40A, P40T, P40TA		



			
1			
Part No.	693894	Ref. No.	3004110 S63EC54005
description	spindle ø 25mm L 538mm mounting pos. bottom in the front eccentric		
For models:	P45A, P45HTA, P45TA		

cylindric			
			
1			
Part No.	693885	Ref. No.	3003300 S63CD54001
description	spindle ø 25mm L 212mm mounting pos. upper at the back cylindrical		
For models:	P30, P30A, P30AE, P30T, P30TA		

			
1			
Part No.	693886	Ref. No.	3004100 3004150 S63CD54003 S63CD54005
description	spindle ø 25mm L 262mm mounting pos. upper at the back cylindrical		
For models:	P35A, P35TA, P40, P40A, P45A		

			
1			
Part No.	693887	Ref. No.	3004100 S63CD54003
description	spindle ø 25mm L 342mm mounting pos. bottom at the back cylindrical		
For models:	P30, P30A, P30AE, P30T, P30TA, P40T, P40TA, P45HTA, P45TA		

			
1			
Part No.	693888	Ref. No.	3003350 S63CD54002
description	spindle ø 25mm L 467mm mounting pos. bottom at the back cylindrical		
For models:	P40, P40A, P40T, P40TA		

			
1			
Part No.	693889	Ref. No.	3004120 S63CD54004
description	spindle ø 25mm L 508mm mounting pos. bottom at the back cylindrical		
For models:	P45A, P45HTA, P45TA		

miscellaneous			
			
1			
Part No.	697346	Ref. No.	5873100 A90MP78001
description	ball handle thread M4 ø 20mm black		
For models:	P30, P30A, P30T, P30TA, P35A, P35TA, P40, P40A, P40T, P40TA, P45A, P45HTA, P45TA		

			
1			
Part No.	697328	Ref. No.	5163010 A86ME30006
description	compression spring ø 7mm L 19.5mm wire gauge ø 0.6mm		
For models:	P30, P30A, P30T, P30TA, P35A, P35TA, P40, P40A, P40T, P40TA, P45A, P45HTA, P45TA		

			
1			
Part No.	697347	Ref. No.	3002170 S69FE54001
description	distance washer for dough roller ø 11mm H 30mm		
For models:	P30, P35A, P40, P40A, P45A		

			
1			
Part No.	697344	Ref. No.	4203000 4660000
description	lever for dough roller		
For models:	P30, P30A, P30T, P30TA, P35A, P35TA, P40, P40A, P40T, P40TA, P45A, P45HTA, P45TA		





			
1			
Part No.	699474	Ref. No.	A90MI78001
description	lever for dough roller H 50mm L 50mm W 20mm		

			
1			
Part No.	692007	Ref. No.	4203100 A90TP78003
description	lid		

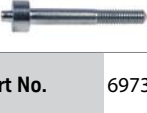
			
1			
Part No.	696467	Ref. No.	A90TP78003
description	lid for side part ø 30.2mm H 3mm		

			
1			
Part No.	693921	Ref. No.	4203100 4660010 A90TP78001
description	lid for side part ø 30.5mm H 11mm		
For models:	P30, P30A, P30AE, P30T, P30TA, P35A, P35TA, P40, P40A, P40T, P40TA, P40TAE, P45A, P45HTA, P45TA		

			
1			
Part No.	697345	Ref. No.	3003700 S74MG54001
description	screw for lever L 37mm		
For models:	P30, P30A, P30T, P30TA, P35A, P35TA, P40, P40A, P40T, P40TA, P45A, P45HTA, P45TA		

			
1			
Part No.	697859	Ref. No.	3002460 S56SR54001
description	spacer piece for dough roller ø 10.5mm L 37mm		
For models:	P30, P30A, P30AE, P30T, P30TA, P35A, P35TA, P40, P40A, P40T, P40TA, P45A, P45HTA, P45TA		

			
1			
Part No.	697774	Ref. No.	3002470 S56IE54001
description	spacer piece for dough roller ø 10mm L 43mm		
For models:	P30, P30A, P30AE, P30T, P30TA, P35A, P35TA, P40, P40A, P40T, P40TA, P45A, P45HTA, P45TA		

for pizza press

gearboxes

			
1			
Part No.	601182	Ref. No.	5424300 A89RE00003
description	gearbox motor shaft ø 14mm flange ø 105mm transmission 1/80 drive shaft ø 25mm fixing dimensions 86-110mm type MV 63A		
For models:	PFD33		

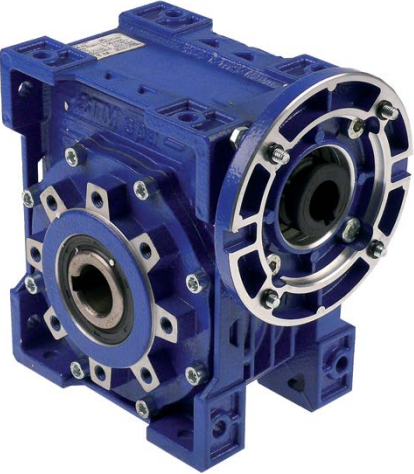
			
1			
Part No.	697326	Ref. No.	A89RE66002 PF08410
description	gearbox motor shaft ø 19mm flange ø 120mm transmission 1/70 drive shaft ø 25mm type UMI 63		
For models:	PFD 30 N, PFD 33 N, PFD 40 N, PFD36		

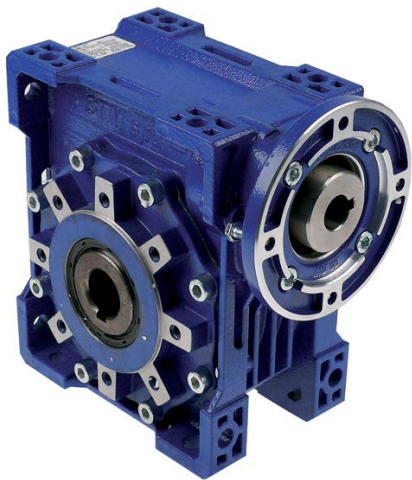

1

Part No.	697327	Ref. No.	A89RE66001 PF08400
description	gearbox motor shaft \varnothing 19mm flange \varnothing 120mm transmission 1/70 drive shaft \varnothing 28mm type UMI 75		
For models:	PFD 45 N, PFD 50 N, PFD 55 N		

1

Part No.	601183	Ref. No.	5424260 A89RE00001
description	gearbox type 1/64		
For models:	PFD 50, PFD45		

for tilting bratt pans

miscellaneous



1

Part No.	523510	Ref. No.	8303070 A89CK00013
description	deep-groove ball bearing type 6202-2RS shaft \varnothing 15mm ED \varnothing 35mm W 11mm with sealing discs deep-groove ball bearing DIN 625-1		

EQUIPMENT-SPECIFIC UNITS PIZZA-GROUP

for pizza ovens

glass panels



1

Part No.	700138	Ref. No.	5592150 A00PT55003
description	glass panel L 415mm W 107mm thickness 4mm rectangular		
For models:	FG 1 60 90R, FG 1 60 90TA, FG 1 60A, FG 1 60R, FG 1 60TA, FG 1/60 A, FG 1/60 R, FG 1/6090 A, FG 1/6090 R, FG 1/90 A, FG 1/90 R, FG 1/9060 A, FG 1/9060 R, FG 2 60 90A, FG 2 60 90R, FG 2 60 90TA, FG 2 60A, FG 2 60R, FG 2 60TA, FG 2/60 A, FG 2/60 R, FG 2/6090 A, FG 2/6090 R, FG 2/90 A, FG 2/90 R, FG 2/9060 A, FG 2/9060 R, FGM 1 60 90A, FGM 1 60 90R, FGM 1 60 90TA, FGM 1 60A, FGM 1 60R, FGM 1 60TA, FGM 1/60 A, FGM 1/60884901R, FGM 1/6090 A, FGM 1/6090 R, FGM 1/90 A, FGM 1/90 R, FGM 1/9060 A, FGM 1/9060 R, FGM 2 60 90A, FGM 2 60 90R, FGM 2 60 90TA, FGM 2 60A, FGM 2 60R, FGM 2 60TA, FGM 2/60 A, FGM 2/60 R, FGM 2/6090 A...(Other models you can see in the webshop)		
accessories for	700138		
	Part No.	900324	Ref. No.
			5300880 A94GU65002
	door seal W 114mm L 415mm thickness 3mm		

firebricks



1

Part No.	850119	Ref. No.	4103020 4800160 A95FA65004
description	firebrick L 1050mm W 350mm H 22mm		



1

Part No.	850058	Ref. No.	4102900 A95OO65006
description	firebrick L 500mm W 500mm H 14mm delivery freight forwarding company only		
For models:	BABY 50A, BABY 50R, BABY 50TA, FVD 2/50, FVD 3/50, FVD 5/50		



			
1			
Part No.	850059	Ref. No.	4102840 A950065003
description	firebrick L 600mm W 500mm H 14mm delivery freight forwarding company only		
For models:	FG 2 50R, FG 2 50TA, FG 2/50 A, FG 2/50 R, FG 250 A, FGM 2 50A, FGM 2 50R, FGM 2 50TA		

			
1			
Part No.	850060	Ref. No.	4102860 A950065004
description	firebrick L 660mm W 330mm H 14mm delivery freight forwarding company only		
For models:	FG 1 60 90TA, FG 1 60A, FG 1 60R, FG 1 60TA, FG 1/60 A, FG 1/60 R, FG 1/9060 A, FG 1/9060 R, FG 2 60A, FG 2 60R, FG 2 60TA, FG 2/60 A, FG 2/60 R, FG 2/9060 A, FG 2/9060 R, FGM 1 60A, FGM 1 60R, FGM 1 60TA, FGM 1/60 A, FGM 1/60884901R, FGM 1/9060 A, FGM 1/9060 R, FGM 2 60A, FGM 2 60R, FGM 2 60TA, FGM 2/60 A, FGM 2/60 R, FGM 2/9060 A, FGM 2/9060 R, FGMS 1 60A, FGMS 1 60R, FGMS 1 60TA, FGMS 1/60 A, FGMS 1/60 R, FGMS 1/9060 A, FGMS 1/9060 R, FGMS 2 60A, FGMS 2 60R, FGMS 2 60TA, FGMS 2/60 A, FGMS 2/60 R, FGMS 2/9060 A, FGMS 2/9060 R, FGS 1 60A, FGS 1 60R, FGS 1 60TA, FGS 1/60 A, FGS 1/60 R, FGS 1/9060 A, FGS 1/9060 R...(Other models you can see in the webshop)		

			
1			
Part No.	850061	Ref. No.	4102880 A950065005
description	firebrick L 990mm W 330mm H 14mm delivery freight forwarding company only		
For models:	FG 1 60 90A, FG 1 60 90TA, FG 1 90A, FG 1 90R, FG 1 90TA, FG 1/6090 A, FG 1/6090 R, FG 1/90 A, FG 1/90 R, FG 2 60 90A, FG 2 60 90R, FG 2 60 90TA, FG 2 90A, FG 2 90R, FG 2 90TA, FG 2/6090 A, FG 2/6090 R, FG 2/90 A, FG 2/90 R, FGM 1 60 90A, FGM 1 60 90R, FGM 1 60 90TA, FGM 1 90A, FGM 1 90R, FGM 1 90TA, FGM 1/6090 A, FGM 1/6090 R, FGM 1/90 A, FGM 1/90 R, FGM 2 60 90A, FGM 2 60 90R, FGM 2 60 90TA, FGM 2 90A, FGM 2 90R, FGM 2 90TA, FGM 2/6090 A, FGM 2/6090 R, FGM 2/90 A, FGM 2/90 R, FGMS 1 60 90R, FGMS 1 60 90TA, FGMS 1 90A, FGMS 1 90R, FGMS 1 90TA, FGMS 1/6090 A, FGMS 1/6090 R, FGMS 1/90 A, FGMS 1/90 R, FGMS 2 60 90A, FGMS 2 60 90R...(Other models you can see in the webshop)		

knobs

universal knobs

			
1			
Part No.	110253	Ref. No.	5873160 A90MA65008
description	knob switch zero mark t.max.°C°C ø 50mm shaft ø 6x4.6mm shaft flat upper black		
For models:	FG 1/60 A, FG 1/60 R, FG 1/6090 A, FG 1/6090 R, FG 1/90 A, FG 1/90 R, FG 1/9060 A, FG 1/9060 R, FG 2/50 A, FG 2/50 R, FG 2/60 A, FG 2/60 R, FG 2/6090 A, FG 2/6090 R, FG 2/90 A, FG 2/90 R, FG 2/9060 A, FG 2/9060 R, FGM 1/60 A, FGM 1/60884901R, FGM 1/6090 A, FGM 1/6090 R, FGM 1/90 A, FGM 1/90 R, FGM 1/9060 A, FGM 1/9060 R, FGM 2/50 A, FGM 2/50 R, FGM 2/60 A, FGM 2/60 R, FGM 2/6090 A, FGM 2/6090 R, FGM 2/90 A, FGM 2/90 R, FGM 2/9060 A, FGM 2/9060 R, FGMS 1/60 A, FGMS 1/60 R, FGMS 1/6090 A, FGMS 1/6090 R, FGMS 1/90 A, FGMS 1/90 R, FGMS 1/9060 A, FGMS 1/9060 R, FGMS 2/60 A, FGMS 2/60 R, FGMS 2/6090 A, FGMS 2/6090 R, FGMS 2/90 A, FGMS 2/90 R...(Other models you can see in the webshop)		

producer-specific knobs

PIZZA GROUP

			
1			
Part No.	110642	Ref. No.	4102950 A90MA65001
description	knob without symbol ø 46mm shaft ø 6x4.6mm		
For models:	BABY 50A, BABY 50R, BABY 50TA, FGM 1 60 90A, FGM 1 60 90R, FGM 1 60 90TA, FGM 1 60A, FGM 1 60R, FGM 1 60TA, FGM 1 90A, FGM 1 90R, FGM 1 90TA, FGM 1/60 A, FGM 1/60884901R, FGM 1/6090 A, FGM 1/6090 R, FGM 1/90 A, FGM 1/90 R, FGM 1/9060 A, FGM 1/9060 R, FGM 2 60 90A, FGM 2 60 90R, FGM 2 60 90TA, FGM 2 60A, FGM 2 60R, FGM 2 60TA, FGM 2 90A, FGM 2 90R, FGM 2 90TA, FGM 2/50 A, FGM 2/50 R, FGM 2/60 A, FGM 2/60 R, FGM 2/6090 A, FGM 2/6090 R, FGM 2/90 A, FGM 2/90 R, FGM 2/9060 A, FGM 2/9060 R, FGMS 1 60 90R, FGMS 1 60 90TA, FGMS 1 60A, FGMS 1 60R, FGMS 1 60TA, FGMS 1 90A, FGMS 1 90R, FGMS 1 90TA, FGMS 1/60 A, FGMS 1/60 R, FGMS 1/6090 A...(Other models you can see in the webshop)		

			
1			
Part No.	110892	Ref. No.	5820290 A93AD00024
description	knob dial plate thermostat t.max. 210°C		
For models:	PFD 50, PFD33, PFD45		



1

Part No.	112167	Ref. No.	5820220 A93AD00021
description	knob dial plate thermostat t.max. 500°C		



1

Part No.	110890	Ref. No.	5820270 A93AD00023
description	knob dial plate thermostat t.max. 500°C ED ø 42mm		
For models:	FGM 2/50 A, FGM 2/50 R		



1

Part No.	112164	Ref. No.	5820200 A93AD00020
description	knob dial plate thermostat t.max. 500°C ED ø 42mm red		



1

Part No.	110893	Ref. No.	5820280
description	knob dial plate thermostat t.max. 500°C ED ø 42mm silver		



1

Part No.	110970	Ref. No.	5873320 A90MA00002
description	knob switch zero mark t.max.°C°C ø 19mm shaft ø 6mm black/red		
For models:	PFD 30 N, PFD 33 N, PFD 40 N, PFD 45 N, PFD 50 N, PFD 55 N, PFD36		



1

Part No.	110253	Ref. No.	5873160 A90MA65008
description	knob switch zero mark t.max.°C°C ø 50mm shaft ø 6x4.6mm shaft flat upper black		
For models:	FG 1/60 A, FG 1/60 R, FG 1/6090 A, FG 1/6090 R, FG 1/90 A, FG 1/90 R, FG 1/9060 A, FG 1/9060 R, FG 2/50 A, FG 2/50 R, FG 2/60 A, FG 2/60 R, FG 2/6090 A, FG 2/6090 R, FG 2/90 A, FG 2/90 R, FG 2/9060 A, FG 2/9060 R, FGM 1/60 A, FGM 1/60884901R, FGM 1/6090 A, FGM 1/6090 R, FGM 1/90 A, FGM 1/90 R, FGM 1/9060 A, FGM 1/9060 R, FGM 2/50 A, FGM 2/50 R, FGM 2/60 A, FGM 2/60 R, FGM 2/6090 A, FGM 2/6090 R, FGM 2/90 A, FGM 2/90 R, FGM 2/9060 A, FGM 2/9060 R, FGMS 1/60 A, FGMS 1/60 R, FGMS 1/6090 A, FGMS 1/6090 R, FGMS 1/90 A, FGMS 1/90 R, FGMS 1/9060 A, FGMS 1/9060 R, FGMS 2/60 A, FGMS 2/60 R, FGMS 2/6090 A, FGMS 2/6090 R, FGMS 2/90 A, FGMS 2/90 R...(Other models you can see in the webshop)		

handles and hand wheels

cylindrical handles

fixed



1

Part No.	110804	Ref. No.	5873250 A90MI65003
description	cylindrical handle thread M12 ø 29mm L 111mm		
For models:	FG 1 60 90R, FG 1 60 90TA, FG 1 60A, FG 1 60R, FG 1 60TA, FG 1 90A, FG 1 90R, FG 1 90TA, FG 1/60 A, FG 1/60 R, FG 1/6090 A, FG 1/6090 R, FG 2 60 90A, FG 2 60 90R, FG 2 60 90TA, FG 2 60A, FG 2 60R, FG 2 60TA, FG 2 90A, FG 2 90R, FG 2 90TA, FG 2/60 A, FG 2/60 R, FG 2/6090 A, FG 2/6090 R, FGM 1 60 90A, FGM 1 60 90R, FGM 1 60 90TA, FGM 1 60A, FGM 1 60R, FGM 1 60TA, FGM 1 90A, FGM 1 90R, FGM 1 90TA, FGM 1/60 A, FGM 1/60884901R, FGM 1/6090 A, FGM 1/6090 R, FGM 2 60 90A, FGM 2 60 90R, FGM 2 60 90TA, FGM 2 60A, FGM 2 60R, FGM 2 60TA, FGM 2 90A, FGM 2 90R, FGM 2 90TA, FGM 2/60 A, FGM 2/60 R, FGM 2/6090 A...(Other models you can see in the webshop)		

ball handles



1

Part No.	697346	Ref. No.	5873100 A90MP78001
description	ball handle thread M4 ø 20mm black		
For models:	P30, P30A, P30T, P30TA, P35A, P35TA, P40, P40A, P40T, P40TA, P45A, P45HTA, P45TA		





equipment feet and end caps



screw-in feet

			
1			
Part No.	697331	Ref. No.	5874000 A90XP80001
description	equipment foot thread M10 thread L 32mm ø 34mm H 12mm Qty 1 pcs		
For models:	PFD 30 N, PFD 33 N, PFD 40 N, PFD 45 N, PFD 50 N, PFD 55 N, PFD33, PFD36, PFD45		

equipment feet with stem

			
1			
Part No.	697330	Ref. No.	8301340 A96ZF00019
description	equipment foot ø 35mm H 38mm bore ø 20mm rubber Qty 1 pcs		
For models:	TF17, TF22, TF33, TF42, TF53, TR17, TR22, TR33, TR42, TR53		
accessories for	697329		
			
Part No.	697329	Ref. No.	8301560 A96ZF00011
description	bolt for equipment foot thread M12 ø 20mm H 30mm thread L 38mm		

miscellaneous

			
1			
Part No.	697329	Ref. No.	8301560 A96ZF00011
description	bolt for equipment foot thread M12 ø 20mm H 30mm thread L 38mm		
For models:	TF33, TF42, TF53, TR17, TR22, TR33, TR42, TR53		
accessories for	697329		
			
Part No.	697330	Ref. No.	8301340 A96ZF00019
description	equipment foot ø 35mm H 38mm bore ø 20mm rubber Qty 1 pcs		

miscellaneous



with spigot

ø75mm

			
1			
Part No.	700206	Ref. No.	8301580 A96ZG00004
description	swivel castor ø 75mm with thread bolt housing chrome-plated steel thread L 30mm thread ø M12x1.5mm capacity 100kg bearing ball bearing wheel body polyamide tread PVC H 100mm wheel width 35mm -20 up to +60°C Qty 1 pcs		
For models:	TF33, TF42, TF53, TR17, TR22, TR33, TR42, TR53		

			
1			
Part No.	700195 ¹	Ref. No.	8301570 A96ZG00003
description	swivel castor with brake ø 75mm with thread bolt housing chrome-plated steel thread L 30mm thread ø M12x1.5mm capacity 100kg bearing ball bearing wheel body polyamide tread PVC H 100mm wheel width 35mm -20 up to +60°C Qty 1 pcs		
For models:	TF33, TF42, TF53, TR17, TR22, TR33, TR42, TR53		

¹with swivel brake

			
1			
Part No.	701130	Ref. No.	8100900 8100950 S66RU67001
description	swivel castor set 2x with swivel brake ø 75mm with thread bolt housing chrome-plated steel thread L 30mm thread ø M12x1.5mm capacity 100kg bearing ball bearing wheel body polyamide tread PVC H 100mm wheel width 35mm -20 up to +60°C Qty 4 pcs		
spare parts for	701130		
			
Part No.	700195	Ref. No.	8301570 A96ZG00003
description	swivel castor with brake ø 75mm with thread bolt housing chrome-plated steel thread L 30mm thread ø M12x1.5mm capacity 100kg bearing ball bearing wheel body polyamide tread PVC H 100mm wheel width 35mm -20 up to +60°C Qty 1 pcs		
			
Part No.	700206	Ref. No.	8301580 A96ZG00004
description	swivel castor ø 75mm with thread bolt housing chrome-plated steel thread L 30mm thread ø M12x1.5mm capacity 100kg bearing ball bearing wheel body polyamide tread PVC H 100mm wheel width 35mm -20 up to +60°C Qty 1 pcs		



mechanical components, equipment accessories

gaskets

gaskets for heated units

door seals

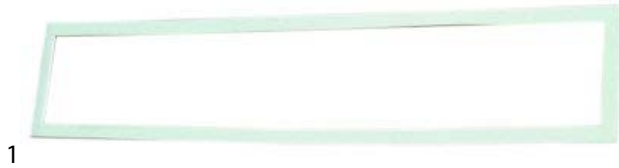

1

Part No.	900324	Ref. No.	5300880 A94GU65002
description	door seal W 114mm L 415mm thickness 3mm		
For models:	FG 1 60 90R, FG 1 60 90TA, FG 1 60A, FG 1 60R, FG 1 60TA, FG 2 60 90A, FG 2 60 90R, FG 2 60 90TA, FG 2 60A, FG 2 60R, FG 2 60TA, FGM 1 60 90A, FGM 1 60A, FGM 1 60R, FGM 1 60TA, FGM 2 60 90R, FGM 2 60A, FGMS 1 60 90R, FGMS 1 60 90TA, FGMS 1 60A, FGMS 1 60R, FGMS 1 60TA, FGMS 2 60 90A, FGMS 2 60 90R, FGMS 2 60 90TA, FGMS 2 60A, FGMS 2 60R, FGMS 2 60TA, FGS 1 60 90A, FGS 1 60 90R, FGS 1 60 90TA, FGS 1 60A, FGS 1 60R, FGS 1 60TA, FGS 2 60 90A, FGS 2 60 90R, FGS 2 60 90TA, FGS 2 60A, FGS 2 60R, FGS 2 60TA		

transmission technology and ball bearings

ball bearings

deep-groove ball bearings 2RS



1

Part No.	523541	Ref. No.	8301550 A89CK00011
description	deep-groove ball bearing type 6006-2RS shaft ø 30mm ED ø 55mm W 13mm with sealing discs deep-groove ball bearing DIN 625-1		
For models:	TF33, TF42, TF53, TR33, TR42, TR53		



1

Part No.	523510	Ref. No.	8303070 A89CK00013
description	deep-groove ball bearing type 6202-2RS shaft ø 15mm ED ø 35mm W 11mm with sealing discs deep-groove ball bearing DIN 625-1		



1

Part No.	523513	Ref. No.	8104900 8300190 A89CK00010
description	deep-groove ball bearing type 6205-2RS shaft ø 25mm ED ø 52mm W 15mm with sealing discs deep-groove ball bearing DIN 625-1		
For models:	TF17, TF22, TF33, TF42, TF53, TR17, TR22, TR33, TR42, TR53		

deep-groove ball bearings 2Z



1

Part No.	523508	Ref. No.	5093000 A89CK78001
description	deep-groove ball bearing shaft ø 10mm ED ø 30mm W 9mm type 6200-2Z DIN 625-1		
For models:	P30, P30A, P30AE, P30T, P30TA, P35A, P35TA, P40, P40A, P40T, P40TA, P45A, P45HTA, P45TA		



1

Part No.	692000	Ref. No.	5093100 A89CK78002
description	deep-groove ball bearing shaft ø 15mm ED ø 35mm W 11mm type 6202-2Z DIN 625-1		
For models:	P30, P30A, P30AE, P30T, P30TA, P35A, P35TA, P40, P40A, P40T, P40TA, P40TAE, P45A, P45HTA, P45TA		

flange bearings



1

Part No.	693112	Ref. No.	8300830 A96ZI00024
description	flange bearing type UCF204 shaft ø 20mm 4 hole flange hole distance 64mm H 33mm flange length 86mm flange width 86mm hole ø 12mm flange F204 ball bearing UC204G2 FH 25.5mm		
For models:	TF17, TF22, TR17, TR22		





			
1			
Part No.	697278	Ref. No.	8300840 A96ZI00025
description	flange bearing type UCF205 shaft ø 25mm 4 hole flange hole distance 70mm H 36mm flange length 95mm flange width 95mm hole ø 12mm flange F205 ball bearing UC205G2 FH 27mm		
For models:	TF33, TF42, TF53, TR33, TR42, TR53		

drive belts

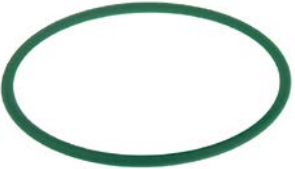
round belts

			
1			
Part No.	693701	Ref. No.	5070200 A90KI78009
description	round belt ø 8mm L 540mm		
For models:	P30A, P30AE, P35A		

			
1			
Part No.	693873	Ref. No.	5070080 A90KI78004
description	round belt ø 8mm L 560mm		
For models:	P30AE, P30TA, P35A, P35TA		

			
1			
Part No.	693874	Ref. No.	5070090 A90KI78005
description	round belt ø 8mm L 600mm		
For models:	P30TA, P35TA		

			
1			
Part No.	693843	Ref. No.	5070050 A90KI78002
description	round belt ø 8mm L 680mm		
For models:	P30, P30T, P40, P40T		

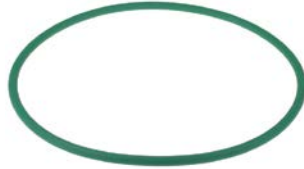
			
1			
Part No.	693875	Ref. No.	5070010 5070030 A90KI78001
description	round belt ø 8mm L 784mm		
For models:	P30, P30AE, P40A, P40TA, P45A, P45HTA, P45TA		

			
1			
Part No.	694578	Ref. No.	5070020
description	round belt ø 8mm L 805mm		

			
1			
Part No.	693876	Ref. No.	5070160 A90KI78007
description	round belt ø 8mm L 860mm		
For models:	P30T		

			
1			
Part No.	693877	Ref. No.	5070180 A90KI78008
description	round belt ø 8mm L 920mm		
For models:	P40		





			
1			
Part No.	693878	Ref. No.	5070220 A90KI78010
description	round belt ø 8mm L 950mm		
For models:	P40T		

chains

roller chains 06B-1 single

			
1			
Part No.	697127	Ref. No.	8300870 S14MT67001
description	roller chain DIN/ISO 06 B-1 splitting 3/8" / 9.525mm links 42 internal width 5.72mm rollero 6.35mm single		
For models:	TF17, TF22, TR17		

			
1			
Part No.	697126	Ref. No.	8300210 A96ZN00022 S14MT67007
description	roller chain DIN/ISO 06 B-1 splitting 3/8" / 9.525mm links 63 internal width 5.72mm rollero 6.35mm		
For models:	TF17, TF22, TF33, TR17, TR22		

			
1			
Part No.	697112	Ref. No.	8300220 A96ZN00023 S14MT67008
description	roller chain DIN/ISO 06 B-1 splitting 3/8" / 9.525mm links 74 internal width 5.72mm rollero 6.35mm single		
For models:	TF33, TF42, TF53, TR33, TR42, TR53		

roller chains 08B-1 single

			
1			
Part No.	697128	Ref. No.	8300880 S14MT67002
description	roller chain DIN/ISO 08 B-1 splitting 1/2" / 12.7mm links 37 internal width 7.75mm rollero 8.51mm single		
For models:	TF33, TR33		

springs

torsion springs

			
1			
Part No.	693789	Ref. No.	4000500 4000510 A86ME30003
description	spring ø 12mm L2 70mm mounting pos. in the front/at the back wire gauge ø 1.5mm P30-P40 L1 3mm L3mm Qty 1 pcs		
For models:	P30, P30A, P30AE, P30T, P30TA, P35A, P35TA, P40, P40A, P40T, P40TA, P45A, P45HTA, P45TA		

			
1			
Part No.	700159	Ref. No.	4000530 A86ME30004
description	torsion spring ø 20mm L2 80mm wire gauge ø 3.5mm L1 150mm L3mm Qty 1 pcs		

compression springs

			
1			
Part No.	697328	Ref. No.	5163010 A86ME30006
description	compression spring ø 7mm L 19.5mm wire gauge ø 0.6mm		
For models:	P30, P30A, P30T, P30TA, P35A, P35TA, P40, P40A, P40T, P40TA, P45A, P45HTA, P45TA		

tension springs

			
1			
Part No.	700492	Ref. No.	A86ME30011 A86ME30012 FP 08040
description	tension spring ø 20mm total length 230mm wire gauge ø 2.8mm L1 125mm L2 55mm L3 50mm pizza oven		

			
1			
Part No.	697349	Ref. No.	A86ME30011 FP08040 PF08650
description	tension spring ø 20mm wire gauge ø 3mm L1 125mm L2 55mm		
For models:	PFD 30 N, PFD 33 N, PFD 40 N, PFD 45 N, PFD 50 N, PFD 55 N, PFD36		



measuring equipment

thermometers

built-in thermometers

ø60mm



Part No.	541054	Ref. No.	5310350 A88TC83001
description	thermometer mounting ø 60mm t.max. 500°C 0 up to +500°C probe ø 10mm probe L 80mm capillary pipe 700mm		

fastening material

screws

hexagonal screws



Part No.	560202	Ref. No.	8300610 A86ME24117
description	hexagonal screw thread M10 thread L 25mm SS WS 17 Qty 1 pcs DIN 933 / ISO 4017		
For models:	TF17, TF22, TF33, TF42, TF53, TR17, TR22, TR33, TR42, TR53		



Part No.	560203	Ref. No.	8301710 A86ME24120
description	hexagonal screw thread M10 thread L 30mm SS WS 17 Qty 1 pcs DIN 933 / ISO 4017		
For models:	TF17, TF22, TF33, TF42, TF53, TR33, TR42, TR53		



Part No.	560204	Ref. No.	8300380 A86ME24116
description	hexagonal screw thread M8 thread L 25mm SS WS 13 Qty 1 pcs DIN 933 / ISO 4017		
For models:	TF17, TF22, TF33, TF42, TF53, TR17, TR22, TR33, TR42, TR53		

Part No.	560205	Ref. No.	8300290 A86ME24114
description	hexagonal screw thread M8 thread L 30mm SS WS 13 Qty 1 pcs DIN 933 / ISO 4017		
For models:	TF17, TF22, TF33, TF42, TF53, TR17, TR22, TR33, TR42, TR53		

Part No.	560206	Ref. No.	8300310 A86ME24115
description	hexagonal screw thread M8 thread L 35mm SS WS 14 Qty 1 pcs DIN 933 / ISO 4017		
For models:	TF17, TF22, TF33, TF42, TR33, TR42, TR53		

Part No.	560493	Ref. No.	A86ME24115
description	hexagonal screw thread M8 thread L 35mm zinc-coated steel WS 13 Qty 1 pcs head thickness 4.5mm DIN 933 / ISO 4017		

Part No.	506446	Ref. No.	8301740 A86ME24121
description	hexagonal screw thread M8 thread L 40mm SS WS 13 Qty 1 pcs DIN 933 / ISO 4017		
For models:	TF17, TF22, TF33, TF42, TF53, TR17, TR22		

cylinder head bolts

DIN 912/ISO 4762

Part No.	560225	Ref. No.	8301260 A86ME24119
description	cylinder head bolt thread M4 L 30mm thread L 20mm WS 3 intake hexagonal SS Qty 1 pcs head ø 7mm head thickness 4mm DIN 912/ ISO 4762		
For models:	TF17, TF22, TF33, TF42, TF53, TR17, TR22, TR33, TR42, TR53		



grub screws

DIN 916/ISO 4029



1

Part No.	560207	Ref. No.	8300280 A86ME32013
description	grub screw thread M8 L 10mm steel DIN 916/ISO 4029 intake internal hexagon WS 4 Qty 1 pcs		
For models:	TF17, TF22, TF33, TF42, TF53, TR17, TR22, TR33, TR42, TR53		

nuts

hexagonal nuts

DIN 934 / ISO 4032/8673



1

Part No.	560197	Ref. No.	A86ME25024
description	nut thread M10 H 8mm WS 17 SS DIN/ISO DIN 934 / ISO 4032/8673 Qty 1 pcs		

washers

spring rings



1

Part No.	560209	Ref. No.	8300620 A86ME26026
description	lock washer ID \varnothing 10.3mm ED \varnothing 17.2mm SS Qty 1 pcs for thread M10		
For models:	TF17, TF22, TF33, TF42, TF53, TR17, TR22, TR33, TR42, TR53		



1

Part No.	560208	Ref. No.	8300390 A86ME26024
description	lock washer ID \varnothing 8.3mm ED \varnothing 15mm SS Qty 1 pcs		
For models:	TF17, TF22, TF33, TF42, TF53, TR17, TR22, TR33, TR42, TR53		

washers

DIN 9021



1

Part No.	560210	Ref. No.	8300630 A86ME26027
description	plain washer ID \varnothing 11mm ED \varnothing 30mm thickness 2mm SS Qty 1 pcs DIN 9021 for thread M10		
For models:	TF17, TF22, TF33, TF42, TF53, TR17, TR22, TR33, TR42, TR53		

miscellaneous



1

Part No.	560214	Ref. No.	8300400 A86ME26025
description	washer ID \varnothing 8.5mm ED \varnothing 31.5mm thickness 1mm SS Qty 1 pcs		
For models:	TF17, TF22, TF33, TF42, TF53, TR17, TR22, TR33, TR42, TR53		

fasteners

slot nuts



1

Part No.	560287	Ref. No.	8301530 A86ME36008
description	slot nut W 6mm H 6mm L 20mm		
For models:	TF17, TF22, TR17, TR22		



1

Part No.	560269	Ref. No.	5227570 A86ME36006
description	slot nut W 6mm H 6mm L 30mm		



1

Part No.	560284	Ref. No.	8301540 A86ME36009
description	slot nut W 6mm H 6mm L 35mm		
For models:	TF33, TF42, TF53, TR33, TR42, TR53		



1

Part No.	560268	Ref. No.	8300650 A86ME36007
description	slot nut W 8mm H 7mm L 35mm		
For models:	TF17, TF22, TF33, TF42, TF53, TR17, TR22, TR33, TR42, TR53		

retaining rings

DIN 471



1

Part No.	519248	Ref. No.	5203100 A86ME28003
description	retaining ring shaft \varnothing 10mm thickness 1mm SS DIN 471		
For models:	P30, P30A, P30AE, P30T, P30TA, P35A, P35TA, P40, P40A, P40T, P40TA, P45A, P45HTA, P45TA, PFD 30 N, PFD 33 N, PFD 40 N, PFD 45 N, PFD 50 N, PFD 55 N, PFD36		



			
1			
Part No.	528689	Ref. No.	5203200 A86ME28008
description	retaining ring shaft ø 15mm thickness 1mm steel DIN 471		
For models:	P30, P30A, P30AE, P30T, P30TA, P35A, P35TA, P40, P40A, P40T, P40TA, P45A, P45HTA, P45TA		

GASTROPARTS.COM

