



**GASTROPARTS**

# Pitco

- [EN]** Equipment
- [DE]** Geräte
- [ES]** Aparatos
- [FR]** Équipement
- [IT]** Attrezzature
- [PL]** Urządzenia
- [RU]** Оборудование

✉ [gastroparts@gastroparts.com](mailto:gastroparts@gastroparts.com)

☎ tel. +48 56 657 00 66

📘 [fb.com/gastroparts.global](https://fb.com/gastroparts.global)

**GASTROPARTS.COM**





## heating elements

### heating elements for fryers



1

<b>Part No.</b>	420421	<b>Ref. No.</b>	B5307203-C
<b>description</b>	heating element 7000W 240V heating circuits 3 L 280mm W 158mm H 285mm flange with thread connection cable fryer hole distance 87mm hole ø 6.3mm flange length 101.5mm flange width 36mm cable length 1000mm		



1

<b>Part No.</b>	420428	<b>Ref. No.</b>	50006614
<b>description</b>	heating element 8500W 230V heating circuits 3 L 355mm W 115mm H 280mm flange connection plug flange length 163mm flange width 45mm tube ø 8mm		

### 2 hole fixing



1

<b>Part No.</b>	420423	<b>Ref. No.</b>	P5046916
<b>description</b>	heating element 7000W 240V heating circuits 1 L 280mm W 87mm H 295mm thread 5/8"-18UNF tube ø 11mm windings 5 fryer		



1

<b>Part No.</b>	420427	<b>Ref. No.</b>	PP10904
<b>description</b>	heating element 8500W 230V heating circuits 3 L 260mm W 90mm H 260mm thread 3/4"-16UNF windings 4 fryer		



1

<b>Part No.</b>	420425	<b>Ref. No.</b>	P5046921
<b>description</b>	heating element 5500W 240V heating circuits 1 L 265mm W 97mm H 290mm H1 220mm H2 70mm thread 5/8"-18UNF tube ø 11mm		



1

<b>Part No.</b>	420424	<b>Ref. No.</b>	P5046902
<b>description</b>	heating element 6000W 240V heating circuits 1 L 365mm W 105mm H 295mm thread 5/8"-18UNF tube ø 11mm windings 4		

### heating elements for pasta cookers



1

<b>Part No.</b>	420426	<b>Ref. No.</b>	B5309305
<b>description</b>	heating element 2500W 230V heating circuits 1 L 310mm W 75mm H 75mm		

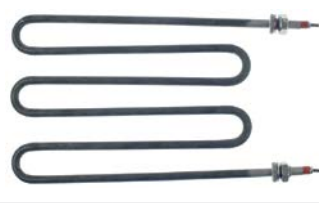

1

<b>Part No.</b>	420422	<b>Ref. No.</b>	P5046968
<b>description</b>	heating element 6000W 240V heating circuits 1 L 345mm W 218mm H 25.4mm 5/8"-18UNF		



1

<b>Part No.</b>	420429	<b>Ref. No.</b>	PP11210
<b>description</b>	heating element 8500W 230V heating circuits 1 L 420mm W 275mm H 31.8mm		



## thermostats

## bi-metal thermostats

## bi-metal thermostats



<b>Part No.</b>	390969	<b>Ref. No.</b>	PP10739
<b>description</b>	bi-metal thermostat hole distance 23.5mm switch-off temp. 57.2°C 1NC 1-poleAV connection F6.3 2 hole fixing		

## control and safety thermostats

## INVENSYS / ROBERTSHAW

## control thermostats



<b>Part No.</b>	390971	<b>Ref. No.</b>	60125402
<b>description</b>	thermostat t.max. 190.6°C temperature range 93-190°C 1-pole 1NO 0.67A probe ø 9.5mm probe L 120mm capillary pipe 870mm capillary pipe isolatedmm gland nut 3/8" NPT shaft L 23mm shaft position lower 200-375°F		



<b>Part No.</b>	390636	<b>Ref. No.</b>	60125401
<b>description</b>	thermostat t.max. 204°C temperature range 93-204°C 1-pole 1NO 0.67A probe ø 9.5mm probe L 123mm capillary pipe 915mm capillary pipe isolatedmm gland nut 1/4" NPT shaft ø 6x4.6mm shaft L 21mm shaft position lower rotation 315° probe material nickel-plated probe thread 1/4" US		



<b>Part No.</b>	580040	<b>Ref. No.</b>	P5047587
<b>description</b>	thermostat t.max. 205°C temperature range 94-205°C 1-pole 1NOA probe ø 9.5mm probe L 123mm capillary pipe 885mm capillary pipe isolatedmm gland nut 3/8" NPT shaft Lmm with knob		

## safety thermostats

RANCO



<b>Part No.</b>	390966	<b>Ref. No.</b>	60070701
<b>description</b>	safety thermostat switch-off temp. 121°C temperature range°C 1-poleA probe ø 6.4mm probe L 136mm capillary pipe 610mm capillary pipe isolatedmm gland nut 1/4" NPT shaft ømm probe SS		



<b>Part No.</b>	390967	<b>Ref. No.</b>	PP11010
<b>description</b>	safety thermostat switch-off temp. 224°C temperature range fixed 224°C 1-pole 1COA probe ø 6.4mm probe L 118mm capillary pipe 790mm capillary pipe isolatedmm gland nut shaft ømm probe SS		

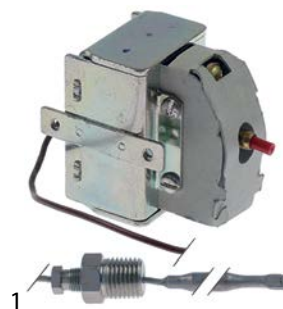

<b>Part No.</b>	580045	<b>Ref. No.</b>	PP10084
<b>description</b>	safety thermostat switch-off temp. 232°C 1-pole 1COA probe ø 6.4mm probe L 120mm capillary pipe 760mm capillary pipe isolatedmm gland nut 3/8" NPT shaft ømm probe SS screw connection 1/4" 450°F		

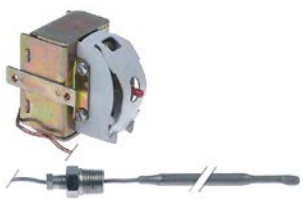
<b>Part No.</b>	580047	<b>Ref. No.</b>	P5047210 PP10271
<b>description</b>	safety thermostat switch-off temp. 232°C 1-pole probe ø 6.4mm probe L 120mm capillary pipe 600mm 450°F		



<b>Part No.</b>	390965	<b>Ref. No.</b>	P5047216
<b>description</b>	safety thermostat switch-off temp. 232°C 1-poleA probe ø 7.93mm probe L 77mm capillary pipe 760mm capillary pipe isolatedmm gland nut shaft ømm probe SS		

## switches and momentary switches

### rocker/momentary rocker switches

37x21mm



<b>Part No.</b>	348059	<b>Ref. No.</b>	6717337 PP10093
<b>description</b>	rocker switch mounting measurements 37x21mm white 1CO 250V 6A connection male faston 6.3mm ambient temperature max. 85/100°C protection IP44		



<b>Part No.</b>	348062	<b>Ref. No.</b>	PP11284
<b>description</b>	rocker switch mounting measurements 37x21mm white/black 2NO 250V 15A 0-1 connection male faston 6.3mm ambient temperature max. 125°C protection IP40		

miscellaneous



<b>Part No.</b>	348054	<b>Ref. No.</b>	PP10735
<b>description</b>	rocker switch mounting measurements 37x21mm white/black 2CO 250V 10A connection male faston 6.3mm ambient temperature max. 85/125°C protection IP44		

## toggle switches

M12x0.75



<b>Part No.</b>	348060	<b>Ref. No.</b>	PP11175
<b>description</b>	momentary toggle switch thread M12 2NO 250V 10A ON-OFF male faston 6.3mm momentary		



<b>Part No.</b>	348055	<b>Ref. No.</b>	P5047165
<b>description</b>	toggle switch thread M12x0.75 2CO 250V 15A ON-ON screw		



<b>Part No.</b>	348058	<b>Ref. No.</b>	PP10821
<b>description</b>	toggle switch thread M12x0.75 3CO 250V 12A ON-OFF-ON male faston 6.3mm with neutral position		

## microswitches

pin-plunger actuated

M12



<b>Part No.</b>	348061	<b>Ref. No.</b>	P5047170
<b>description</b>	microswitch with plunger mounting distance 20mm thread M12x1 thread L 14mm 250V 10A 1CO connection screw stroke 10mm L 50mm L1 50mm L2 20mm ambient temperature max. 125°C actuating force: 560g		

## float switches



<b>Part No.</b>	403494	<b>Ref. No.</b>	P5047217
<b>description</b>	float switch thread 1/4" NPT 1NO ø 52mm L 90mm mounting ø 14mm 240V 0.4A cable cable length 910mm		



## magnetic switches

29x19mm

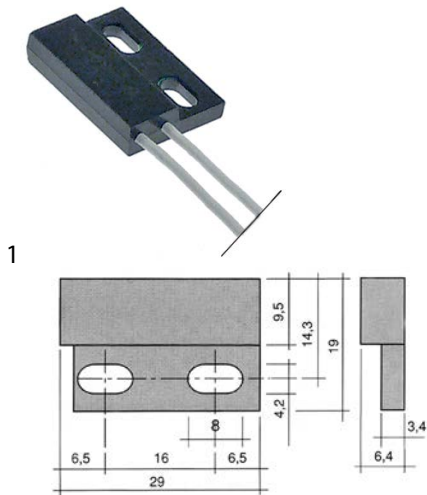

<b>Part No.</b>	348050 <sup>1</sup>	<b>Ref. No.</b>	B5305001
<b>description</b>	magnetic switch L 29mm W 19mm 1NO 250V 0.5A P max. 10W connection plug cable length 290mm		
<b>For models:</b>	ME2, MEII		

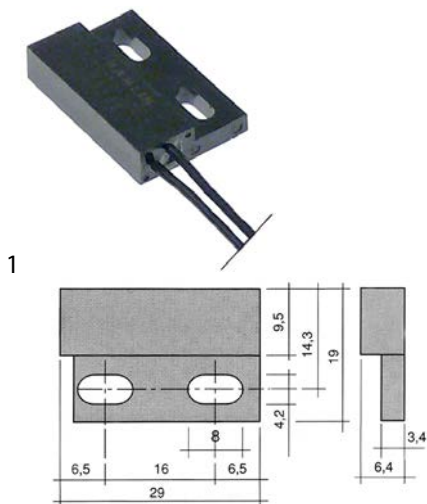
<sup>1</sup>with coded connector

<b>Part No.</b>	348049	<b>Ref. No.</b>	PP11164
<b>description</b>	magnetic switch L 29mm W 19mm 1NO 250V 1.5A P max. 50W cable length 600mm		

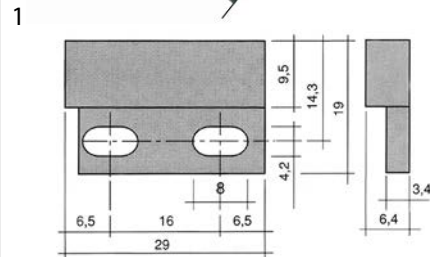
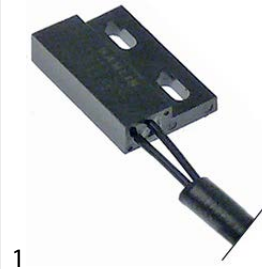

<b>Part No.</b>	348051	<b>Ref. No.</b>	B5305002
<b>description</b>	magnetic switch with insulation L 29mm W 19mm 1NO 250V 0.5A P max. 10W connection plug cable length 290mm		

## accessories

## magnets

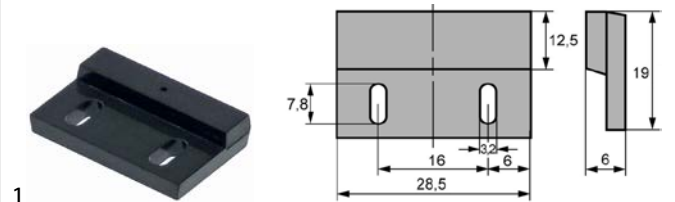

<b>Part No.</b>	345700	<b>Ref. No.</b>	PP10263
<b>description</b>	magnet $\varnothing$ mm L 29mm H 6.5mm W 19mm hole distance 16mm M3 hole $\varnothing$ 3.5mm		
<b>For models:</b>	ME2, MEII		

## lamps

## indicator lights

## indicator lights (complete)

27x12mm



<b>Part No.</b>	348056	<b>Ref. No.</b>	P5045040
<b>description</b>	indicator light mounting measurements 27x12mm red 28V connection male faston 6.3mm temp.-resist. 125°C		



<b>Part No.</b>	348057	<b>Ref. No.</b>	P5045043
<b>description</b>	indicator light mounting measurements 27x12mm white 28V connection male faston 6.3mm temp.-resist. 125°C		



miscellaneous



1			
<b>Part No.</b>	360619	<b>Ref. No.</b>	PP10736
<b>description</b>	indicator light green 125/250V connection male faston 6.3mm		

contactors

HARTLAND

power contactors



1			
<b>Part No.</b>	381278	<b>Ref. No.</b>	P5045352
<b>description</b>	power contactor resistive load 40A 120VAC 30A/10HP (AC3/240V) 30A/7.46kW main contacts 3NO auxiliary contacts connection screw clamp/male faston 6.3mm type HCCY3XT02CY		



1			
<b>Part No.</b>	381277	<b>Ref. No.</b>	P60157202 PP10560
<b>description</b>	power contactor resistive load 50A 24VAC 40A/10HP (AC3/240V) 40A/7.46kW main contacts 3NO auxiliary contacts connection screw clamp/male faston 6.3mm type HCCY3XQ04CG		
<b>For models:</b>	ME2, MEII		

SPRECHER+SCHUH

power contactors



1			
<b>Part No.</b>	381279	<b>Ref. No.</b>	60139201
<b>description</b>	power contactor resistive load 65A 24VAC (AC3/400V) 60A/18.5kW main contacts 3NO auxiliary contacts connection screw connection type CA7-37-00		
<b>For models:</b>	ME2, MEII		

solid state relays

CRYDOM



1			
<b>Part No.</b>	381280	<b>Ref. No.</b>	PP11011
<b>description</b>	solid state relay CRYDOM 1 phase 50A 480V 18-36 VAC L 57mm W 45mm screw type HA4850E		

relays

power relays

with bracket mounting





1			
<b>Part No.</b>	381290	<b>Ref. No.</b>	PP11058
<b>description</b>	power relays OMRON 24VAC 25A 1NO connection F6.3 bracket mounting at 250V 30A manuf. no. G7L-1A-TUBJ-CB 24VAC		
<b>For models:</b>	ME2, MEII		







			
1			
<b>Part No.</b>	381291	<b>Ref. No.</b>	60104701
<b>description</b>	power relays OMRON 24VAC 25A 2NO connection F6.3 bracket mounting at 250V 25A manuf. no. G7L-2A-TUBJ-CB 24VAC		
<b>For models:</b>	ME2, MEII		

			
1			
<b>Part No.</b>	381292	<b>Ref. No.</b>	PP11036
<b>description</b>	power relays OMRON 24VDC 25A 2NO connection F6.3 bracket mounting at 250V 25A manuf. no. G7L-2A-TUBJ-CB 24VDC		

			
1			
<b>Part No.</b>	381295	<b>Ref. No.</b>	P5046687
<b>description</b>	relay OMRON 24VAC 10A 2CO connection F4.8 bracket mounting manuf. no. LY2 24VAC		

			
1			
<b>Part No.</b>	381296	<b>Ref. No.</b>	60126001
<b>description</b>	relay OMRON 24VAC 10A 3CO connection F4.8 bracket mounting manuf. no. LY3F AC24		
<b>For models:</b>	ME2, MEII		

			
1			
<b>Part No.</b>	381294	<b>Ref. No.</b>	PP11068
<b>description</b>	relay OMRON 24VDC 10A 2CO connection F4.8 bracket mounting manuf. no. LY2F 24DC		

			
1			
<b>Part No.</b>	381293	<b>Ref. No.</b>	PP11124
<b>description</b>	relay OMRON 24VDC 15A 1CO connection F4.8 bracket mounting manuf. no. LY1F DC24		

## miscellaneous

			
1			
<b>Part No.</b>	403495	<b>Ref. No.</b>	60143301
<b>description</b>	relay reset		

## probes

### producer-specific probes

#### probes

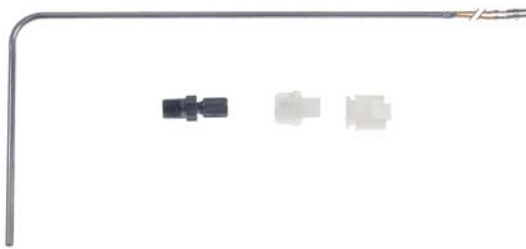
			
1			
<b>Part No.</b>	403491	<b>Ref. No.</b>	B6700601-C
<b>description</b>	temperature probe thermocouple K (NiCr-Ni) cable glass fibre probe -50 up to +750°C cable -50 up to +350°C connection 2-wire thread 1/4" NPT probe ø4.7x280mm cable length 0.315m handle ømm handle lengthmm		



core probes



<b>Part No.</b>	403489	<b>Ref. No.</b>	60055003-C
<b>description</b>	temperature probe NTC 100kOhm cable PTFE probe -40 up to +120°C cable -40 up to +250°C connection 2-wire probe ø4.7x70mm thread M9 cable length 1.12m handle ømm handle lengthmm L2 65mm		

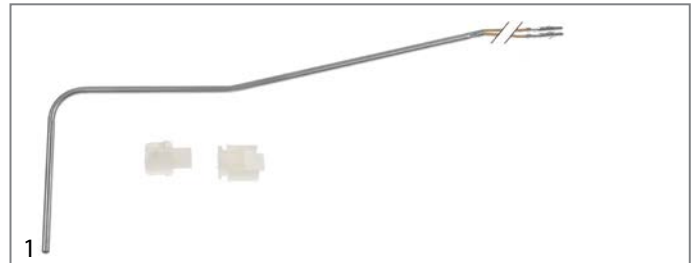

<b>Part No.</b>	403490	<b>Ref. No.</b>	B6700602-C
<b>description</b>	temperature probe thermocouple K (NiCr-Ni) cable glass fibre probe -50 up to +750°C cable -50 up to +350°C connection 2-wire probe ø4.7x270mm thread cable length 0.35m handle ømm handle lengthmm		



<b>Part No.</b>	403493	<b>Ref. No.</b>	60139801
<b>description</b>	temperature probe NTC 10kOhm cable PVC probe -40 up to +110°C cable -10 up to 100°C connection 2-wire probe ø4.7x270mm thread M12x1.25 cable length 0.4m handle ømm handle lengthmm		



<b>Part No.</b>	403488	<b>Ref. No.</b>	PP10915
<b>description</b>	temperature probe thermocouple K (NiCr-Ni) cable glass fibre probe -50 up to +750°C cable -50 up to +350°C connection 2-wire probe ø4.7x280mm thread cable length 0.32m handle ømm handle lengthmm		

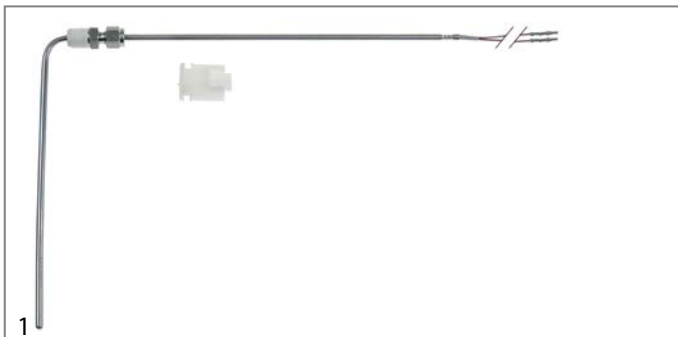

<b>Part No.</b>	403492	<b>Ref. No.</b>	P5044882
<b>description</b>	temperature probe NTC 10kOhm cable PVC probe -40 up to +110°C cable -10 up to 100°C connection 2-wire probe ø4.7x270mm thread M12x1.25 cable length 0.8m handle ømm handle lengthmm		

accessories

fasteners



<b>Part No.</b>	692860	<b>Ref. No.</b>	A3342802 PITA3342802
<b>description</b>	bracket for fryer mounting pos. probes L 30mm W 45mm H 22mm stainless steel hole ø 14mm mounting distance 31mm		
<b>For models:</b>	ME2, MEII		



<b>Part No.</b>	403487	<b>Ref. No.</b>	B3316801-C
<b>description</b>	temperature probe thermocouple K (NiCr-Ni) cable glass fibre probe -50 up to +750°C cable -50 up to +350°C connection 2-wire probe ø4.7x140mm thread M9 cable length 0.27m handle ømm handle lengthmm		

electronics

PCBs



<b>Part No.</b>	698535	<b>Ref. No.</b>	60134001
<b>description</b>	PCB fryer L 130mm W 90mm 24V H 55mm PITCO Qty 1 pcs		





<b>Part No.</b>	698539	<b>Ref. No.</b>	PP11012
<b>description</b>	PCB fryer L 380mm W 150mm 24V H 60mm mounting pos. front PITCO Qty 1 pcs		







			
1			
<b>Part No.</b>	698534	<b>Ref. No.</b>	60126601
<b>description</b>	PCB fryer L 380mm W 155mm 24V H 40mm 1.67A mounting pos. front PITCO Qty 1 pcs		

			
1			
<b>Part No.</b>	698540	<b>Ref. No.</b>	PP11306
<b>description</b>	PCB fryer L 380mm W 160mm 24V H 55mm 1.67A mounting pos. front PITCO Qty 1 pcs		

			
1			
<b>Part No.</b>	698541	<b>Ref. No.</b>	PP11372
<b>description</b>	PCB fryer L 385mm W 160mm 24V H 60mm 1.67A mounting pos. front PITCO Qty 1 pcs		

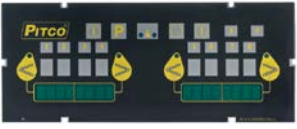
			
1			
<b>Part No.</b>	698542	<b>Ref. No.</b>	PP11370
<b>description</b>	PCB fryer L 390mm W 155mm 24V H 55mm 1.67A mounting pos. front PITCO Qty 1 pcs		

			
1			
<b>Part No.</b>	698536	<b>Ref. No.</b>	60137701-C
<b>description</b>	PCB fryer L 390mm W 160mm 24V H 60mm 1.67A mounting pos. front PITCO Qty 1 pcs		

			
1			
<b>Part No.</b>	698532	<b>Ref. No.</b>	60149501-CL
<b>description</b>	PCB fryer L 400mm W 220mm 24V H 80mm 1.2A mounting pos. front PITCO Qty 1 pcs		

			
1			
<b>Part No.</b>	698537	<b>Ref. No.</b>	60127301
<b>description</b>	PCB fryer L 99mm W 69mm 24V H 20mm PITCO Qty 1 pcs		
<b>For models:</b>	ME2, MEII		

			
1			
<b>Part No.</b>	698533	<b>Ref. No.</b>	60144002-C
<b>description</b>	PCB L 115mm W 70mm 24V H 20mm PITCO Qty 1 pcs		

			
1			
<b>Part No.</b>	698538	<b>Ref. No.</b>	PP10939
<b>description</b>	PCB L 240mm W 160mm 24V H 50mm 1.67A PITCO Qty 1 pcs		

## pressure switches

for deep fryers

			
1			
<b>Part No.</b>	698529	<b>Ref. No.</b>	PP11137
<b>description</b>	pressure control ø 90mm 1CO connection 7/16" UNF (1/4" SAE) pressure connection 7/16" UNF (1/4" SAE)		



## fans

### radial fans

1

<b>Part No.</b>	601971	<b>Ref. No.</b>	PP11129
<b>description</b>	radial fan 220-240V voltage AC 50Hz H1 260mm L1 220mm D1 ø 170mm W1 240mm W2 60mm H2 90mm W3 95mm H3 120mm		

## motors

### gear motors

#### miscellaneous

1

<b>Part No.</b>	601970	<b>Ref. No.</b>	PP10930
<b>description</b>	gear motor PITCO type ZEM-6006-25 230V 50/60Hz shaft ø 8/9mm L 120mm W 70mm H 155mm		

### motors

1

<b>Part No.</b>	504785	<b>Ref. No.</b>	60130804
<b>description</b>	pump motor 240V 50Hz 1425rpm capacitorµF for oil/grease H 160mm PITCO L 240mm W 160mm 248W		
<b>For models:</b>	ME2, ME11		

## pumps

### oil pumps

1

<b>Part No.</b>	501475	<b>Ref. No.</b>	PP10171
<b>description</b>	oil pump PITCO type M4C14DH4G 246W 240V 50Hz inlet ø 23mm outlet ø 21mm L 285mm		

1

<b>Part No.</b>	501474	<b>Ref. No.</b>	60130802
<b>description</b>	oil pump PITCO type M4S14DH3B 248W 240V 50Hz inlet ø 23mm outlet ø 23mm L 330mm 1817l/h capacitorµF		

1

<b>Part No.</b>	501473	<b>Ref. No.</b>	60143508
<b>description</b>	oil pump PITCO type SG-0510-G00WVHz inlet ø 15mm outlet ø 15mm 910l/h		

## fuses

### fine fuses

1

<b>Part No.</b>	358840	<b>Ref. No.</b>	PP10122
<b>description</b>	fuse size ø6.3x32mm 1A slow-acting rated 250V Qty 1 pcs		

1

<b>Part No.</b>	358839	<b>Ref. No.</b>	60132703
<b>description</b>	fuse size ø6.3x32mm 2.5A slow-acting rated 250V Qty 1 pcs		



			
1			
<b>Part No.</b>	358841	<b>Ref. No.</b>	P5045717
<b>description</b>	fuse size ø6.3x32mm 2A slow-acting rated 250V Qty 1 pcs		

**fine fuse holders**

			
1			
<b>Part No.</b>	551283	<b>Ref. No.</b>	P5045794
<b>description</b>	fuse holder suitable fuse ø6.3x32mm ø 12.5mm mounting ø 13mm 20A rated 300V connection F4.8		



			
1			
<b>Part No.</b>	551282	<b>Ref. No.</b>	PP10765
<b>description</b>	fuse holder suitable fuse ø5x20mm ø 12.5mm 30A rated 32V L 57mm connection 8x5 cross section 2.5mm <sup>2</sup>		

**overload switches**



			
1			
<b>Part No.</b>	358179	<b>Ref. No.</b>	PP10470
<b>description</b>	overload switch 2-pole drop-away current 4A rated 250V nominal 4A connection male faston		

**gas thermostats**

**ROBERTSHAW**



				
1				
<b>Part No.</b>	580041 <sup>1</sup>	<b>Ref. No.</b>	P5047588	
<b>description</b>	gas thermostat type GSA60301800 93-204°C 200-400°F gas inlet 1/4" CCT (tube ø 1/4") bypass nozzle ømm gas outlet 1/4" CCT (tube ø 1/4") thermocouple connection pilot connection capillary pipe 30" - 760mm probe ø 3/8" - 9.5mm probe L 5 3/8" - 135mm gland nut 1/4" NPT shaft ø 6.4x4.8mm shaft L 21/21mm shaft flat upper ROBERTSHAW			
<b>accessories for</b>	580041			
	<b>Part No.</b>	101481	<b>Ref. No.</b>	—
	olive for pipe ø 1/4" CCT Qty 1 pcs			
	<b>Part No.</b>	106109	<b>Ref. No.</b>	—
	locking screw thread 7/16"-24 UNS for pipe ø 1/4" L 16mm brass Qty 1 pcs WS 7/16" (11.113mm) hole ø 6.4mm			

<sup>1</sup>with gland nut 1/4" NPT

<b>accessories for</b>	580041			
	<b>Part No.</b>	106110	<b>Ref. No.</b>	—
	union screw tube ø 1/4"mm			
	<b>Part No.</b>	580039	<b>Ref. No.</b>	—
	knob 200-400°F ø 57mm shaft ø 6x4.6mm shaft flat lower t.max. 400°F rotation 270°			



<b>Part No.</b>	580052 <sup>1</sup>	<b>Ref. No.</b>	P5047590
<b>description</b>	gas thermostat type GSH30240000 t.max. 190°C 93-190°C 200-375°F gas inlet 1/4" CCT (tube ø 1/4") bypass nozzle ømm gas outlet 1/4" CCT (tube ø 1/4") thermocouple connection pilot connection capillary pipe 24" - 610mm probe ø 3/8" - 9.5mm probe L 5 3/8" - 135mm gland nut 3/8" NPT shaft ø 6.4x4.8mm shaft L 21/21mm shaft flat lower ROBERTSHAW		

<b>accessories for</b>	580052			
	<b>Part No.</b>	101481	<b>Ref. No.</b>	—
	olive for pipe ø 1/4" CCT Qty 1 pcs			
	<b>Part No.</b>	106109	<b>Ref. No.</b>	—
	locking screw thread 7/16"-24 UNS for pipe ø 1/4" L 16mm brass Qty 1 pcs WS 7/16" (11.113mm) hole ø 6.4mm			
	<b>Part No.</b>	106110	<b>Ref. No.</b>	—
	union screw tube ø 1/4"mm			

<sup>1</sup>with gland box 3/8" NPT

**gas valves and ignition boxes**

**gas control valves**

**HONEYWELL**







<b>Part No.</b>	107668	<b>Ref. No.</b>	60113503-C
<b>description</b>	gas valve type VR8204A natural gas 24V 50/60Hz gas inlet 1/2" NPT gas outlet 1/2" NPT thermocouple connection pilot connection 1/4" CCT pressure range 7.5-12.5mbar operator type pressure controller type automatic HONEYWELL		



ROBERTSHAW

electric controlled valves



1			
<b>Part No.</b>	101429	<b>Ref. No.</b>	P5045657
<b>description</b>	gas valve 120V 50/60Hz gas inlet 3/4" gas outlet 3/4" thermocouple connection 3/8" NEF pilot connection 1/4" pipe US type 7000BMSER-120 pressure controller natural gas 3.5" W.C. suitable for ROBERTSHAW		
<b>spare parts for</b>	101429		
	<b>Part No.</b>	101047	<b>Ref. No.</b> P6071301 P6071303
	magnet unit T1: ASA 11/32 T2: M24x1 L 59mm ø 4mm suitable for ROBERTSHAW		
	<b>Part No.</b>	101389	<b>Ref. No.</b> —
	pressure controller natural gas suitable for ROBERTSHAW		
	<b>Part No.</b>	580033	<b>Ref. No.</b> P6071170 P6071267
	knob suitable for ROBERTSHAW		
<b>accessories for</b>	101429		
	<b>Part No.</b>	580035	<b>Ref. No.</b> P5047541 P5047542
	thermopile L 36" - 915mm probe ø 9mm probe L 38mm 250-750mV screw connection 7/16" connection 3/8" NEF		



1			
<b>Part No.</b>	107670	<b>Ref. No.</b>	PP10720
<b>description</b>	gas valve supply 24VAC supply 12VDC gas inlet 1/2" NPT gas outlet 1/2" NPT thermocouple connection 11/32" pilot connection 1/4" CCT type 7000 BER-LP pressure controller LPG 10" W.C. suitable for PITCO		



1			
<b>Part No.</b>	107672	<b>Ref. No.</b>	PP10770
<b>description</b>	gas valve supply 24VAC supplyVDC gas inlet 1/2" NPT gas outlet 1/2" NPT thermocouple connection pilot connection type 7000B DER pressure controller natural gas 3.0" W.C. suitable for PITCO		



1			
<b>Part No.</b>	107671	<b>Ref. No.</b>	PP11142
<b>description</b>	gas valve supply 24VAC supplyVDC gas inlet 1/2" NPT gas outlet 1/2" NPT thermocouple connection pilot connection type U7010DER-S7B pressure controller natural gas 3.5" W.C. suitable for PITCO		

gas controlled valves

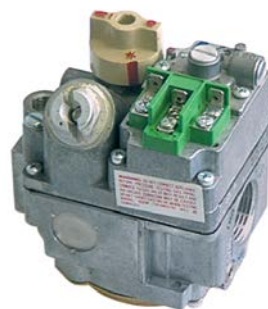







1			
<b>Part No.</b>	580032	<b>Ref. No.</b>	P5045638
<b>description</b>	gas valve 50/60Hz gas inlet 1/2" gas outlet 1/2" thermocouple connection 3/8" NEF pilot connection 1/4" pipe US type 7000BMSER pressure controller natural gas 3.5" W.C. suitable for ROBERTSHAW supply 24VAC supply 12VDC		
<b>spare parts for</b>	580032		
	<b>Part No.</b>	101047	<b>Ref. No.</b> P6071301 P6071303
	magnet unit T1: ASA 11/32 T2: M24x1 L 59mm ø 4mm suitable for ROBERTSHAW		
	<b>Part No.</b>	101389	<b>Ref. No.</b> —
	pressure controller natural gas suitable for ROBERTSHAW		
	<b>Part No.</b>	101403	<b>Ref. No.</b> —
	operator 24V voltage AC natural gas suitable for ROBERTSHAW		

Table continues overleaf









spare parts for		580032		
	Part No.	580033	Ref. No.	P6071170 P6071267
knob suitable for ROBERTSHAW				
accessories for		580032		
	Part No.	580035	Ref. No.	P5047541 P5047542
thermopile L 36" - 915mm probe ø 9mm probe L 38mm 250-750mV screw connection 7/16" connection 3/8" NEF				

				
1				
Part No.	106923	Ref. No.	PP10593	
description	gas valve 60Hz type 7000BDER-S7A supply 24VAC			

				
1				
Part No.	107675	Ref. No.	B8002702	
description	gas valve supply Operator gas inlet 1/4" CCT outlet 1/4" CCT gas inlet 1/2" NPT gas outlet 1/2" NPT thermocouple connection 11/32" pilot connection 1/4" CCT type 7000BGOR-LP pressure controller LPG 10"W.C.			

				
1				
Part No.	107673	Ref. No.	PP10956	
description	gas valve supply Operator gas inlet 1/4" CCT outlet 1/4" CCT gas inlet 1/2" NPT gas outlet 1/2" NPT thermocouple connection 11/32" pilot connection 1/4" CCT type U7000 LP pressure controller LPG			

				
1				

Part No.	580043	Ref. No.	P5045642 P5045659	
description	gas valve supply Operator gas inlet 1/4" CCT outlet 1/4" CCT gas inlet 3/4" NPT gas outlet 3/4" NPT thermocouple connection 3/8" NEF pilot connection 1/4" CCT type 7000BMSGOR pressure controller natural gas 3.5" W.C. suitable for ROBERTSHAW			
spare parts for		580043		
	Part No.	101042	Ref. No.	—
magnet unit T1: 3/8" NEF suitable for ROBERTSHAW for gas operator				
	Part No.	101481	Ref. No.	—
olive for pipe ø 1/4" CCT Qty 1 pcs				
	Part No.	106109	Ref. No.	—
locking screw thread 7/16"-24 UNS for pipe ø 1/4" L 16mm brass Qty 1 pcs WS 7/16" (11.113mm) hole ø 6.4mm				
	Part No.	580033	Ref. No.	P6071170 P6071267
knob suitable for ROBERTSHAW				
accessories for		580043		
	Part No.	580035	Ref. No.	P5047541 P5047542
thermopile L 36" - 915mm probe ø 9mm probe L 38mm 250-750mV screw connection 7/16" connection 3/8" NEF				

## millivolt controlled valves

				
1				
Part No.	107674	Ref. No.	60132902	
description	gas valve supply Operator millivolt gas inlet 1/2" NPT gas outlet 1/2" NPT thermocouple connection 11/32" pilot connection 1/4" CCT type U7000MVRL pressure controller LPG 10"W.C. suitable for PITCO			







1

<b>Part No.</b>	107669	<b>Ref. No.</b>	60132901
<b>description</b>	gas valve supply Operator millivolt gas inlet 1/2" NPT gas outlet 1/2" NPT thermocouple connection 1 1/32" pilot connection 1/4" CCT type U7000MVRL pressure controller natural gas 4.0" W.C. suitable for PITCO		
<b>For models:</b>	ME2, MEII		



1

<b>Part No.</b>	580031	<b>Ref. No.</b>	N/A	
<b>description</b>	gas valve supply Operator millivolt gas inlet 3/4" NPT gas outlet 3/4" NPT thermocouple connection pilot connection 1/4" CCT type 7000BMVR pressure controller natural gas 3.5" W.C. suitable for ROBERTSHAW			
<b>spare parts for</b>	580031			
	<b>Part No.</b>	101422	<b>Ref. No.</b>	—
	operator natural gas supply Operator millivolt			
	<b>Part No.</b>	106109	<b>Ref. No.</b>	—
	locking screw thread 7/16"-24 UNS for pipe ø 1/4" L 16mm brass Qty 1 pcs WS 7/16" (11.113mm) hole ø 6.4mm			
	<b>Part No.</b>	106121	<b>Ref. No.</b>	P6071551
	pressure controller natural gas 3.5" W.C.			
	<b>Part No.</b>	580033	<b>Ref. No.</b>	P6071170 P6071267
	knob suitable for ROBERTSHAW			

ignition boxes

miscellaneous



1

<b>Part No.</b>	107658	<b>Ref. No.</b>	PP11145
<b>description</b>	ignition box GASLITER type MARK10DX-24-716-2 suitable for PITCO electrodes 1 waiting time 1s safety time 10s 24V 50/60Hz		

safety valves

miscellaneous



1

<b>Part No.</b>	107667	<b>Ref. No.</b>	P6071776
<b>description</b>	safety valve BASO type G96HGA-1 pressure range 34.5mbar gas inlet 1/2" NPT gas outlet 1/2" NPT thermocouple connection natural gas 3.5"W.C.		

ignition parts

pilot burners

ROBERTSHAW

pilot burners

universal series - type 4



1

<b>Part No.</b>	580050	<b>Ref. No.</b>	P6071451 P6071458
<b>description</b>	pilot burner ROBERTSHAW type 4CH-6 3 flames LPG code 16 for pipe ø 1/4" CCT		





## universal series - type 6

Width of caps:

6CH10 = 1" (25,4mm)

6CH14 = 1½" (38,1mm)

6CH24 = 2½" (63,5mm)

6CH30 = 3" (76,2mm)



1

<b>Part No.</b>	107677	<b>Ref. No.</b>	6071449
<b>description</b>	pilot burner ROBERTSHAW type 6CH14-6 3 flames LPG code 16 for pipe ø 1/4" CCT		





1

<b>Part No.</b>	107676	<b>Ref. No.</b>	6071450
<b>description</b>	pilot burner ROBERTSHAW type 6CH14-6 3 flames natural gas code 22 for pipe ø 1/4" CCT		
<b>accessories for</b>	107676		
	<b>Part No.</b>	106108	<b>Ref. No.</b> P6071666
	pilot burner nozzle natural gas code 22 suitable for ROBERTSHAW		











1

<b>Part No.</b>	107396	<b>Ref. No.</b>	P6071452 P6071457
<b>description</b>	pilot burner ROBERTSHAW type 6CH24-6 3 flames natural/liquid gas code 16/26 for pipe ø 1/4" CCT		
<b>spare parts for</b>	107396		
	<b>Part No.</b>	100277	<b>Ref. No.</b> —
	pilot burner nozzle natural gas code 26 suitable for ROBERTSHAW		
	<b>Part No.</b>	106105	<b>Ref. No.</b> P6071665
	pilot burner nozzle LPG code 16 suitable for ROBERTSHAW		

## universal series with electrodes





1

<b>Part No.</b>	107661	<b>Ref. No.</b>	60130902
<b>description</b>	pilot burner ROBERTSHAW type 6SW14-21E 3 flames LPG code 16 for pipe ø 1/4" CCT		
<b>spare parts for</b>	107661		
	<b>Part No.</b>	100275	<b>Ref. No.</b> —
	pilot burner nozzle LPG code 10 bore ø 0.1mm suitable for ROBERTSHAW		
	<b>Part No.</b>	100276	<b>Ref. No.</b> —
	pilot burner nozzle natural gas code 18 suitable for ROBERTSHAW		
	<b>Part No.</b>	100277	<b>Ref. No.</b> —
	pilot burner nozzle natural gas code 26 suitable for ROBERTSHAW		
	<b>Part No.</b>	106105	<b>Ref. No.</b> P6071665
	pilot burner nozzle LPG code 16 suitable for ROBERTSHAW		
	<b>Part No.</b>	106106	<b>Ref. No.</b> —
	pilot burner nozzle LPG code 14 suitable for ROBERTSHAW		
	<b>Part No.</b>	106107	<b>Ref. No.</b> —
	pilot burner nozzle LPG code 11 suitable for ROBERTSHAW		
	<b>Part No.</b>	106108	<b>Ref. No.</b> P6071666
	pilot burner nozzle natural gas code 22 suitable for ROBERTSHAW		
	<b>Part No.</b>	106115	<b>Ref. No.</b> —
	pilot burner nozzle town gas suitable for ROBERTSHAW		



1

<b>Part No.</b>	107395	<b>Ref. No.</b>	60130901 60130902
<b>description</b>	pilot burner ROBERTSHAW type 6SW14-21E 3 flames natural/liquid gas code 22/16 for pipe ø 1/4" CCT		
<b>spare parts for</b>	107395		
	<b>Part No.</b>	106105	<b>Ref. No.</b> P6071665
	pilot burner nozzle LPG code 16 suitable for ROBERTSHAW		
	<b>Part No.</b>	106108	<b>Ref. No.</b> P6071666
	pilot burner nozzle natural gas code 22 suitable for ROBERTSHAW		

1

<b>Part No.</b>	107678	<b>Ref. No.</b>	PP11296
<b>description</b>	pilot burner ROBERTSHAW type W1350 3 flames code for pipe ø		









producer-specific pilot burners

PITCO

pilot burners











1

<b>Part No.</b>	107662	<b>Ref. No.</b>	B8032104-C
<b>description</b>	pilot burner ROBERTSHAW type 6CH14-21 3 flames LPG nozzle 16 1/4" complete		
<b>spare parts for</b>	107662		
	<b>Part No.</b>	100275	<b>Ref. No.</b> —
	pilot burner nozzle LPG code 10 bore ø 0.1mm suitable for ROBERTSHAW		
	<b>Part No.</b>	100276	<b>Ref. No.</b> —
	pilot burner nozzle natural gas code 18 suitable for ROBERTSHAW		
	<b>Part No.</b>	100277	<b>Ref. No.</b> —
	pilot burner nozzle natural gas code 26 suitable for ROBERTSHAW		
	<b>Part No.</b>	106105	<b>Ref. No.</b> P6071665
	pilot burner nozzle LPG code 16 suitable for ROBERTSHAW		
	<b>Part No.</b>	106106	<b>Ref. No.</b> —
	pilot burner nozzle LPG code 14 suitable for ROBERTSHAW		
	<b>Part No.</b>	106107	<b>Ref. No.</b> —
	pilot burner nozzle LPG code 11 suitable for ROBERTSHAW		
	<b>Part No.</b>	106108	<b>Ref. No.</b> P6071666
	pilot burner nozzle natural gas code 22 suitable for ROBERTSHAW		
	<b>Part No.</b>	106115	<b>Ref. No.</b> —
	pilot burner nozzle town gas suitable for ROBERTSHAW		



1

<b>Part No.</b>	107663	<b>Ref. No.</b>	B8032103-C
<b>description</b>	pilot burner ROBERTSHAW type 6CH14-21 3 flames natural gas nozzle 22 1/4" complete		
<b>spare parts for</b>	107663		
	<b>Part No.</b>	100275	<b>Ref. No.</b> —
	pilot burner nozzle LPG code 10 bore ø 0.1mm suitable for ROBERTSHAW		
	<b>Part No.</b>	100276	<b>Ref. No.</b> —
	pilot burner nozzle natural gas code 18 suitable for ROBERTSHAW		
	<b>Part No.</b>	100277	<b>Ref. No.</b> —
	pilot burner nozzle natural gas code 26 suitable for ROBERTSHAW		
	<b>Part No.</b>	106105	<b>Ref. No.</b> P6071665
	pilot burner nozzle LPG code 16 suitable for ROBERTSHAW		
	<b>Part No.</b>	106106	<b>Ref. No.</b> —
	pilot burner nozzle LPG code 14 suitable for ROBERTSHAW		
	<b>Part No.</b>	106107	<b>Ref. No.</b> —
	pilot burner nozzle LPG code 11 suitable for ROBERTSHAW		
	<b>Part No.</b>	106108	<b>Ref. No.</b> P6071666
	pilot burner nozzle natural gas code 22 suitable for ROBERTSHAW		
	<b>Part No.</b>	106115	<b>Ref. No.</b> —
	pilot burner nozzle town gas suitable for ROBERTSHAW		



1

<b>Part No.</b>	107660	<b>Ref. No.</b>	B8039520-C
<b>description</b>	pilot burner ROBERTSHAW type 6SW1421E 3 flames natural/liquid gas nozzle 22/16 1/4" complete		



1











<b>Part No.</b>	107666	<b>Ref. No.</b>	60130906 B8039518-C
<b>description</b>	pilot burner ROBERTSHAW type 6SW30-21E 3 flames LPG nozzle 16 for pipe ø 1/4" CCT 1/4" complete		
<b>spare parts for</b>	107666		
	<b>Part No.</b>	100275	<b>Ref. No.</b> —
	pilot burner nozzle LPG code 10 bore ø 0.1mm suitable for ROBERTSHAW		

Table continues overleaf



spare parts for		107666	
Part No.	Ref. No.	Ref. No.	—
	100276	Ref. No.	—
pilot burner nozzle natural gas code 18 suitable for ROBERTSHAW			
	100277	Ref. No.	—
pilot burner nozzle natural gas code 26 suitable for ROBERTSHAW			
	106105	Ref. No.	P6071665
pilot burner nozzle LPG code 16 suitable for ROBERTSHAW			
	106106	Ref. No.	—
pilot burner nozzle LPG code 14 suitable for ROBERTSHAW			
	106107	Ref. No.	—
pilot burner nozzle LPG code 11 suitable for ROBERTSHAW			
	106108	Ref. No.	P6071666
pilot burner nozzle natural gas code 22 suitable for ROBERTSHAW			
	106115	Ref. No.	—
pilot burner nozzle town gas suitable for ROBERTSHAW			

			
1			
Part No.	Ref. No.	Ref. No.	B8039517-C
description pilot burner ROBERTSHAW type 6SW30-21E 3 flames natural gas nozzle 22 for pipe ø 1/4" CCT 1/4" complete			
spare parts for		107664	
	100275	Ref. No.	—
pilot burner nozzle LPG code 10 bore ø 0.1mm suitable for ROBERTSHAW			
	100276	Ref. No.	—
pilot burner nozzle natural gas code 18 suitable for ROBERTSHAW			
	100277	Ref. No.	—
pilot burner nozzle natural gas code 26 suitable for ROBERTSHAW			
	106105	Ref. No.	P6071665
pilot burner nozzle LPG code 16 suitable for ROBERTSHAW			
	106106	Ref. No.	—
pilot burner nozzle LPG code 14 suitable for ROBERTSHAW			
	106107	Ref. No.	—
pilot burner nozzle LPG code 11 suitable for ROBERTSHAW			
	106108	Ref. No.	P6071666
pilot burner nozzle natural gas code 22 suitable for ROBERTSHAW			
	106115	Ref. No.	—
pilot burner nozzle town gas suitable for ROBERTSHAW			

miscellaneous

			
1			
Part No.	104660	Ref. No.	A8035302
description pilot burner bracket PITCO 1 burner bearing upper			

			
1			
Part No.	104661	Ref. No.	A8027301-C
description pilot burner bracket PITCO 1 burner bearing upper			

electrodes









			
1			
Part No.	107665	Ref. No.	PP11131
description ignition electrode flange length 32mm flange width 19mm D1 ø 9.3mm L1 31mm L2 16mm BL1 22mm BL2 26mm connection F6.3			
spare parts for		107665	
	100275	Ref. No.	—
pilot burner nozzle LPG code 10 bore ø 0.1mm suitable for ROBERTSHAW			
	100276	Ref. No.	—
pilot burner nozzle natural gas code 18 suitable for ROBERTSHAW			
	100277	Ref. No.	—
pilot burner nozzle natural gas code 26 suitable for ROBERTSHAW			
	106105	Ref. No.	P6071665
pilot burner nozzle LPG code 16 suitable for ROBERTSHAW			
	106106	Ref. No.	—
pilot burner nozzle LPG code 14 suitable for ROBERTSHAW			
	106107	Ref. No.	—
pilot burner nozzle LPG code 11 suitable for ROBERTSHAW			

Table continues overleaf



spare parts for		107665		
	Part No.	106108	Ref. No.	P6071666
	pilot burner nozzle natural gas code 22 suitable for ROBERTSHAW			
	Part No.	106115	Ref. No.	—
	pilot burner nozzle town gas suitable for ROBERTSHAW			

## ignition cables

### pre-assembled cables



1	Part No.	103223	Ref. No.	60126101
	description ignition cable cable length 455mm connection F6.3mm / ø6.5mm 7mm <sup>2</sup> silicone			

### various



1	Part No.	107654	Ref. No.	PP11128
	description ignition cable cable length 340mm ED ø 7mm insulation silicone black			

## thermocouples

### thermocouple sets universal

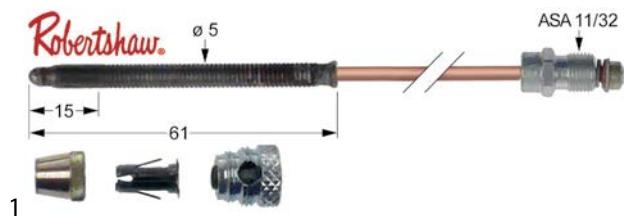

1	Part No.	107706	Ref. No.	P5047540
	description thermocouple ROBERTSHAW 5-piece L 24" - 610mm ASA 11/32			



1	Part No.	102281	Ref. No.	P5047540
	description thermocouple set ROBERTSHAW 5-piece L 24" - 610mm			

## plug-in thermocouples

### plug-in thermocouples standard

#### ROBERTSHAW

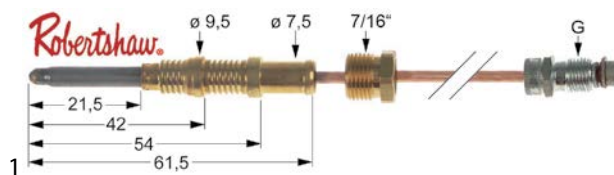

1	Part No.	102276	Ref. No.	P5047540
	description thermocouple ROBERTSHAW ASA 11/32 L 24" - 610mm 7/16"			

### thermopiles

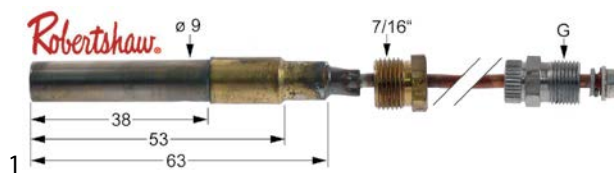

1	Part No.	580035	Ref. No.	P5047541 P5047542
	description thermopile L 36" - 915mm probe ø 9mm probe L 38mm 250-750mV screw connection 7/16" connection 3/8" NEF			

#### White Rodgers

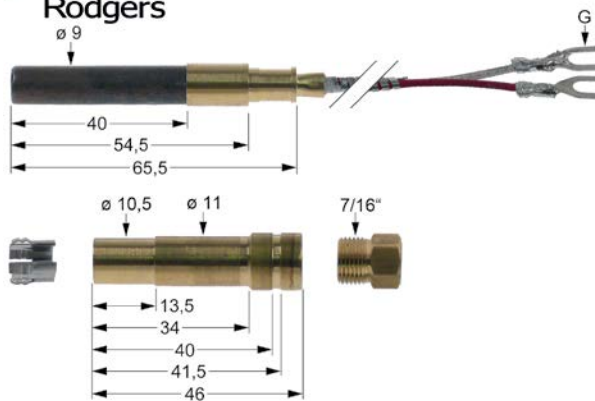

1	Part No.	103243	Ref. No.	60125501
	description thermopile with PG9 adapter WHITE RODGERS L 36" - 915mm probe ø 9mm probe L 40mm 250-750mV screw connection 7/16" connection on spate terminals			

## accessories

### interrupters



1	Part No.	580046	Ref. No.	B6779850 P6071805 P6779850 P9087601
	description extension for interrupter L 18" - 455mm			



## gas burners

## bar burners

## bar burners



1

<b>Part No.</b>	201100	<b>Ref. No.</b>	PP10927
<b>description</b>	bar burner L 310mm W 85mm ø 60mm Hmm fryer		

## tube burners



1

<b>Part No.</b>	109191	<b>Ref. No.</b>	B8037302-C B8046101
<b>description</b>	tubular burner L 277mm W 57mm H 100mm fryer oval		



1

<b>Part No.</b>	109190	<b>Ref. No.</b>	PP10853
<b>description</b>	tubular burner L 360mm W 67mm H 56mm fryer oval		

## gas nozzles

## main nozzles

## gas nozzles (other)



1

<b>Part No.</b>	109192	<b>Ref. No.</b>	PP10984
<b>description</b>	gas injector thread 1/4" NPT WS 17 bore ø 1.15mm Qty 1 pcs		



1

<b>Part No.</b>	109193	<b>Ref. No.</b>	PP10857
<b>description</b>	gas injector thread 5/16" UNEF WS 9.5 bore ø 2.44mm Qty 1 pcs		

## pilot burner nozzles

## pilot burner nozzles ROBERTSHAW



1

<b>Part No.</b>	106105	<b>Ref. No.</b>	P6071665
<b>description</b>	pilot burner nozzle LPG code 16 suitable for ROBERTSHAW		



1

<b>Part No.</b>	106108	<b>Ref. No.</b>	P6071666
<b>description</b>	pilot burner nozzle natural gas code 22 suitable for ROBERTSHAW		

## pilot burner nozzles (other)

## miscellaneous



1

<b>Part No.</b>	103222	<b>Ref. No.</b>	PP10861
<b>description</b>	gas injector LPG bore ø 1.4mm brass		

## auxiliary gas parts

## screw connections

## adapters



1

<b>Part No.</b>	107656	<b>Ref. No.</b>	60127501
<b>description</b>	adapter thread 1/2" for gas burner brass		



gas ball valves

miscellaneous



1			
<b>Part No.</b>	520909	<b>Ref. No.</b>	60128101
<b>description</b>	ball valve straight t-handle inlet 1/2" IT outlet 1/2" IT DN15 L 65mm brass operating p. 0.03bar		

gas lines

main gas lines

producer-specific



1			
<b>Part No.</b>	107659	<b>Ref. No.</b>	PP11257
<b>description</b>	gas line tube ø 19mm L 480mm W 50mm H 50mm connection 1/2"NPT-3/4"NPT		

gas hoses

miscellaneous



1			
<b>Part No.</b>	250081	<b>Ref. No.</b>	B6602403-C
<b>description</b>	gas hose T1: 3/8" NPSF L 260mm nominal-ø 10.5mm connection ø 14.5mm		

equipment-specific units

for deep fryers

spare parts and accessories



1			
<b>Part No.</b>	701428	<b>Ref. No.</b>	P0093300
<b>description</b>	nut fryer PITCO SS Qty 1 pcs		



1			
<b>Part No.</b>	701429	<b>Ref. No.</b>	P0091100
<b>description</b>	nut fryer PITCO SS Qty 1 pcs		



1			
<b>Part No.</b>	701426	<b>Ref. No.</b>	PP10686
<b>description</b>	screw fryer PITCO SS Qty 1 pcs		



1			
<b>Part No.</b>	701427	<b>Ref. No.</b>	PP10697
<b>description</b>	screw fryer PITCO SS Qty 1 pcs		



1			
<b>Part No.</b>	701424	<b>Ref. No.</b>	PP10687
<b>description</b>	screw fryer suitable for PITCO Qty 1 pcs thread 6-32x5/16		



1			
<b>Part No.</b>	701425	<b>Ref. No.</b>	P5045661
<b>description</b>	screw Unitrol fryer PITCO SS Qty 1 pcs		





## miscellaneous



1

<b>Part No.</b>	694727	<b>Ref. No.</b>	A8030407
<b>description</b>	adapter PITCO for oil drain steel L 50mm W 60mm H 60mm thread 1 1/2" mounting pos. lower		



1

<b>Part No.</b>	694722	<b>Ref. No.</b>	60131801 6717300
<b>description</b>	ball valve for oil tap steel L 100mm W 90mm H 55mm thread 1/2"		
<b>For models:</b>	ME2, MEII		



1

<b>Part No.</b>	694726	<b>Ref. No.</b>	PP11005
<b>description</b>	ball valve for oil drain steel L 250mm W 80mm H 150mm thread 1 1/2" mounting pos. lower		



1

<b>Part No.</b>	694725	<b>Ref. No.</b>	PITPP10962
<b>description</b>	ball valve PITCO for oil drain steel L 230mm W 65mm H 90mm thread 1 1/4" mounting pos. lower		



1

<b>Part No.</b>	694724	<b>Ref. No.</b>	60131007
<b>description</b>	ball valve for oil drain steel L 260mm W 130mm H 80mm thread 1 1/4" mounting pos. lower		



1

<b>Part No.</b>	694728	<b>Ref. No.</b>	60144401
<b>description</b>	ball valve PITCO for oil drain steel L 95mm W 80mm H 120mm thread 1 1/4" mounting pos. lower		



1

<b>Part No.</b>	694723	<b>Ref. No.</b>	B4004404-C
<b>description</b>	ball valve with sensor for oil drain steel L 270mm W 90mm H 85mm thread 1 1/2" mounting pos. lower		

1

<b>Part No.</b>	694720	<b>Ref. No.</b>	B4005104
<b>description</b>	bar for fryer for outlet tap steel L 780mm W 30mm H 80mm mounting pos. lower		



1

<b>Part No.</b>	694731	<b>Ref. No.</b>	B2801106-C
<b>description</b>	element holder E14/E14B SS L 370mm W 360mm H 120mm		



1

<b>Part No.</b>	694732	<b>Ref. No.</b>	B2801104-C
<b>description</b>	element holder E14X SS L 370mm W 360mm H 120mm		



1

<b>Part No.</b>	694733	<b>Ref. No.</b>	B4004101
<b>description</b>	handle rod for oil filter steel L 490mm W 190mm H 8mm		



1

<b>Part No.</b>	694730	<b>Ref. No.</b>	B1001702
<b>description</b>	insert PITCO for flues plate L 230mm W 150mm H 420mm		



1

<b>Part No.</b>	692534	<b>Ref. No.</b>	A1403202-C
<b>description</b>	mounting clip fryer SS L 43mm W 20mm H 14mm		



1

<b>Part No.</b>	696626	<b>Ref. No.</b>	B6602406-C
<b>description</b>	pump hose complete for draining L 1500mm W 22mm		



1

<b>Part No.</b>	694721	<b>Ref. No.</b>	B6658101-C
<b>description</b>	spout for oil drain steel L 240mm W 50mm H 80mm mounting pos. lower		



1

<b>Part No.</b>	694729	<b>Ref. No.</b>	60127702
<b>description</b>	terminal PITCO for drain unit SS L 85mm W 85mm mounting pos. lower		
<b>For models:</b>	ME2, MEII		



## for ovens

## housing and bezels



1

<b>Part No.</b>	698530	<b>Ref. No.</b>	P6071215
<b>description</b>	cover L 67mm W 93mm H 0.67mm rubber		

## knobs

## producer-specific knobs

## PITCO



1

<b>Part No.</b>	111803	<b>Ref. No.</b>	PP10537
<b>description</b>	knob 100-200 shaft flat lower black shaft 6x4.6 H 22mm L 58mm Qty 1 pcs		



1

<b>Part No.</b>	112142	<b>Ref. No.</b>	PP10782
<b>description</b>	knob D1 ø 31mm shaft ø specialmm		

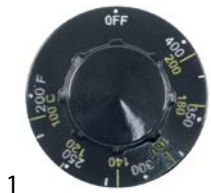

1

<b>Part No.</b>	112732	<b>Ref. No.</b>	PP10539
<b>description</b>	knob thermostat shaft ø 6.4x4.8mm temperature range 100-200°C shaft flat lower black external size 58mm H 22mm Qty 1 pcs		

## handles and hand wheels

## bracket handles



1

<b>Part No.</b>	694718	<b>Ref. No.</b>	PP11332
<b>description</b>	pull handle for fryer L 120mm SS		

## levers

## with handle



1

<b>Part No.</b>	111802	<b>Ref. No.</b>	B4000707
<b>description</b>	lever outlet tap steel for fryer		



1

<b>Part No.</b>	111801	<b>Ref. No.</b>	B4003001-C
<b>description</b>	lever outlet tap steel for fryer operation with latch		

## hinges

## door bearing



1

<b>Part No.</b>	694719	<b>Ref. No.</b>	B3801802
<b>description</b>	hinge L 24mm W 42mm H 64mm mounting pos. bottom left bolt 17mm bolt ø 6.3mm with bolt for fryer suitable for PITCO		



## equipment feet and end caps

### equipment feet

#### with fixing plate



1

<b>Part No.</b>	701419	<b>Ref. No.</b>	60132401
<b>description</b>	equipment foot tube $\phi$ 41mm plate size 83x83mm hole distance 65x65mm H 220-250mm SS Qty 1 pcs for fryer suitable for PITCO		

### miscellaneous

#### with fixing plate

$\phi$ 75mm



1

<b>Part No.</b>	701420	<b>Ref. No.</b>	PP10808
<b>description</b>	swivel castor $\phi$ 75mm plates fixing 82x82mm housing zinc-plated sheet steel plate size 82x82mm hole distance 66x66mm capacity 100kg bearing slide bearing wheel body polyamide tread 32 H 145-165mm wheel width 33mm Qty 1 pcs		

## baskets

### fryer baskets

#### US producers



1

<b>Part No.</b>	970134	<b>Ref. No.</b>	P6072125
<b>description</b>	fryer basket L1 280mm W1 140mm H1 105mm		



1

<b>Part No.</b>	970184	<b>Ref. No.</b>	P6072143
<b>description</b>	fryer basket L1 330mm W1 315mm H1 135mm		

1			
<b>Part No.</b>	970182	<b>Ref. No.</b>	P6072145
<b>description</b>	fryer basket L1 340mm W1 165mm H1 150mm L2 620mm H2 280mm		

## shelves and shelf rails

### grates

#### universal

#### without upstand



1

<b>Part No.</b>	970865	<b>Ref. No.</b>	PP10434
<b>description</b>	grate W 292mm D 343mm H 9mm chrome-plated steel for fryer PITCO		



1

<b>Part No.</b>	970864	<b>Ref. No.</b>	A4500601
<b>description</b>	grate W 345mm D 345mm H 10mm stainless steel crossing wires 1		
<b>For models:</b>	ME2, ME11		

## gaskets

### O-rings

#### Viton



1

<b>Part No.</b>	532693	<b>Ref. No.</b>	PP10111
<b>description</b>	O-ring Viton thickness 2.62mm ID $\phi$ 13mm Qty 1 pcs suitable for PITCO		



### special gaskets

#### sealing discs



1			
<b>Part No.</b>	109189	<b>Ref. No.</b>	PP11181
<b>description</b>	gasket ø 55mm rubber Qty 1 pcs		

1			
<b>Part No.</b>	358839	<b>Ref. No.</b>	60132703
<b>description</b>	fuse size ø6.3x32mm 2.5A slow-acting rated 250V Qty 1 pcs		

1			
<b>Part No.</b>	358841	<b>Ref. No.</b>	P5045717
<b>description</b>	fuse size ø6.3x32mm 2A slow-acting rated 250V Qty 1 pcs		

### consumables

#### fuses

##### fine fuses

ø6.3x32mm 250V



1			
<b>Part No.</b>	358840	<b>Ref. No.</b>	PP10122
<b>description</b>	fuse size ø6.3x32mm 1A slow-acting rated 250V Qty 1 pcs		

**GASTRO**PARTS.COM

