



GASTROPARTS

Piron

[EN] Equipment

[DE] Geräte

[ES] Aparatos

[FR] Équipement

[IT] Attrezzature

[PL] Urządzenia

[RU] Оборудование

✉ gastroparts@gastroparts.com

☎ tel. +48 56 657 00 66

📘 fb.com/gastroparts.global

GASTROPARTS.COM





heating elements

heating elements for convection





1

Part No.	418267	Ref. No.	KRS00019 RES30003 RES30019
description	heating element 2500W 230V heating circuits 1 ID ø 181mm ED ø 193mm L 208mm H 30mm L1 10mm W1 30mm H1 6mm H2 24mm flange length 70mm flange width 22mm hole distance 56mm connection male faston 6.3mm tube ø 6.3mm convection heating element hole ø 5mm rectangular flange		
spare parts for	418267		
	Part No.	510368	Ref. No. —
	gasket L 70mm W 23.5mm hole ø 5mm hole distance 56mm FIBER thickness 2mm for heating element		





1

Part No.	419244	Ref. No.	KRS00003
description	heating element 2500W 230V heating circuits 1 ID ø 185mm ED ø 195mm L 210mm H 28mm L1 8mm W1 30mm H1 6mm H2 22mm flange length 70mm flange width 22mm hole distance 56mm connection male faston 6.3mm tube ø 6.3mm hole ø 5mm mounting pos. on the backside flange 70 x 22mm with screws convection heating element		
spare parts for	419244		
	Part No.	560102	Ref. No. —
	sheet metal screws ø 3.9mm L 9.5mm SS Qty 20 pcs DIN 7981/ISO 7049 head ø 7.5mm oval head		





1

Part No.	419243	Ref. No.	KRS00033 RES30033
description	heating element 2700W 230V heating circuits 1 ID ø 180mm ED ø 193mm L 208mm H 30mm L1 8mm W1 30mm H1 7mm H2 23mm flange length 70 no to be sold in Francemmm flange width 22mm hole distance 56mm connection male faston 6.3mm tube ø 6.3mm convection heating element hole ø 5mm rectangular flange 70 x 22mm with screws		
spare parts for	419243		
	Part No.	560102	Ref. No. —
	sheet metal screws ø 3.9mm L 9.5mm SS Qty 20 pcs DIN 7981/ISO 7049 head ø 7.5mm oval head		



1

Part No.	417224	Ref. No.	KRS00005 RES30005
description	heating element 3000W 230V heating circuits 1 ID ø 180mm ED ø 194mm L 205mm H 32mm L1 11mm W1 30mm H1 10mm H2 24mm flange length 70mm flange width 22mm hole distance 56mm connection male faston 6.3mm tube ø 6.1mm convection heating element hole ø 5mm rectangular flange		
For models:	704UD		
accessories for	417224		
	Part No.	510368	Ref. No. —
	gasket L 70mm W 23.5mm hole ø 5mm hole distance 56mm FIBER thickness 2mm for heating element		



1

Part No.	417225	Ref. No.	RES30001
description	heating element 3500W 230V heating circuits 1 ID ø 215mm ED ø 232mm L 265mm H 48mm L1 25mm W1 33mm H1 10mm H2 38mm flange length 70mm flange width 22mm hole distance 56mm connection male faston 6.3mm tube ø 8.5mm convection heating element hole ø 5mm rectangular flange		



1

Part No.	419024	Ref. No.	KRS00006 RES30006
description	heating element 4000W 230V heating circuits 1 ID ø 217mm ED ø 233mm L 265mm H 50mm L1 25mm W1 33mm H1 5mm H2 45mm flange length 70mm flange width 22mm hole distance 56mm connection male faston 6.3mm connection length 29mm tube ø 8.5mm convection heating element hole ø 5mm rectangular flange oven		
accessories for	419024		
	Part No.	510368	Ref. No. —
	gasket L 70mm W 23.5mm hole ø 5mm hole distance 56mm FIBER thickness 2mm for heating element		



accessories

spring clips



1

Part No.	550795	Ref. No.	PIA30014
description	probe clip for pipe ø 6mm for probe ø 3.5mm Qty 1 pcs for oven		

energy regulators

ROBERTSHAW

MSA series

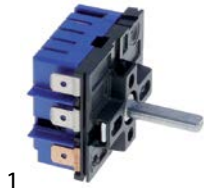

1

Part No.	380858	Ref. No.	KTR00004 TER30004
description	energy regulator ROBERTSHAW 240V 15A turn direction right shaft ø 6x4.6mm shaft L 23mm mounting thread 8"-32UNC		

thermostats

bi-metal thermostats

bi-metal thermostats



1

Part No.	390634	Ref. No.	TER30002
description	bi-metal thermostat hole distance 23.5mm switch-off temp. 145°C 1NC 1-pole 16A 250V connection F6.3 2 hole fixing		
For models:	704UD		

control and safety thermostats

EGO

control thermostats

55.10/19_ series



1

Part No.	375463	Ref. No.	TER30006
description	thermostat t.max. 277°C 1-pole 1NO 16A probe ø 3.03mm probe L 139mm capillary pipe 870mm capillary pipe isolated 6mm gland nut shaft ø 6x4.6mm shaft L 23mm		



1

Part No.	375464	Ref. No.	TER30003
description	thermostat t.max. 294°C 1-pole 1NO 16A probe ø 3.03mm probe L 160mm capillary pipe 980mm capillary pipe isolated 600mm gland nut shaft ø 6x4.6mm shaft L 23mm shaft position lower°		

55.17_ series

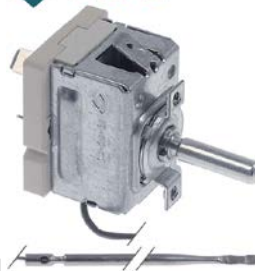

1

Part No.	376057	Ref. No.	KTR00020 TER30020
description	thermostat t.max. 272°C 1-pole probe ø 3mm probe L 165mm capillary pipe 1300mm capillary pipe isolated 320mm shaft ø 6x4.6mm shaft L 23mm shaft position upper rotation 270° probe material SS		



E-G-O



Part No.	391048	Ref. No.	KTR00016 TER30016
description	thermostat t.max. 292°C 1-pole 1NO probe ø 3mm probe L 182mm shaft ø 6x4.6mm shaft L 23mm shaft position upper* rotation 270° probe material SS with mounting accessories		

safety thermostats

55.32_ series

E-G-O



Part No.	390999	Ref. No.	KTR00011 TER30008 TER30011
description	safety thermostat switch-off temp. 350°C temperature range°C 2-pole NC 20A probe ø 3mm probe L 187mm capillary pipe 690mm capillary pipe isolated 680mm gland nut shaft ømm probe SS		

CAMPINI

safety thermostats



Part No.	375892	Ref. No.	Ter30013
description	safety thermostat switch-off temp. 318°C 1-pole 16A probe ø 3mm probe L 137mm capillary pipe 1260mm capillary pipe isolated 710mm gland nut probe SS type Ty 95-H		

various

control thermostats



Part No.	375914	Ref. No.	TER30003 TER30018
description	thermostat t.max. 290°C temperature range 50-290°C 1-pole 1NOA probe ø 3mm probe L 165mm capillary pipe 1040mm capillary pipe isolated 600mm gland nut shaft ø 6x4.6mm shaft L 23mm shaft position upper rotation 270° probe material SS		

accessories

probe clips

spring clips

for safety thermostat



Part No.	550795	Ref. No.	PIA30014
description	probe clip for pipe ø 6mm for probe ø 3.5mm Qty 1 pcs for oven		

switches and momentary switches

push/momentary push switches

ø25mm



Part No.	347355	Ref. No.	KPL00003 PUL30003
description	momentary push switch mounting ø 25mm red 2NO 250V 16A connection male faston 6.3mm ambient temperature max. 85°C protection IP40		



microswitches

pin-plunger actuated

M10



1

Part No.	345032	Ref. No.	PUL30001
description	microswitch with plunger thread M10x1 thread L 12mm 250V 16A 1CO connection male faston 6.3mm stroke 7mm mounting distance 22mm L 28mm ambient temperature max. 125°C type SP9603 actuating force: 180g		

cam switches

4 operating positions



1

Part No.	300229	Ref. No.	COM30001
description	cam switch 4 operating positions 4NO sequence 0-1-0-2 16A shaft ø 6x4.6mm shaft L 23mm connection male faston 6.3mm plastic		

encoders and potentiometers



1

Part No.	403843	Ref. No.	KSH00019 KSH00024 SCH30006
description	encoder complete auxiliary equipment		

lamps



indicator lights

indicator lights 2-piece (lens and indicator lamp)

indicator lamps for socket type RL



1

Part No.	359818	Ref. No.	IND30009 KID00009
description	indicator light 230V clear connection male faston 6.3mm		
accessories for	359818		
	Part No.	359820	Ref. No. —
	indicator light lens yellow Qty 1 pcs ø 8mm		
	Part No.	359833	Ref. No. —
	indicator light lens red Qty 1 pcs ø 8mm		
	Part No.	359948	Ref. No. —
	indicator light lens clear Qty 1 pcs ø 8mm		

indicator lights (complete)

ø 6mm



1

Part No.	359031	Ref. No.	IND30001
description	indicator light ø 6mm 230V green		



1

Part No.	359032	Ref. No.	IND30002
description	indicator light ø 6mm 230V yellow		





oven lamps

universal oven lamps

mounting diameter 35.5mm



1

Part No.	357158	Ref. No.	LAM00003 LAM30003-A
description	oven lamp mounting ø 35.5mm 230V 40W socket G9 cable length 100mm connection male faston 6.3mm with gasket		
spare parts for	357158		
	Part No.	357160	Ref. No. —
	lamp socket socket G9 220-230V mounting ø 35.5mm connection cable 100mm		
	Part No.	358135	Ref. No. —
	gasket for oven lamp PTFE ID ø 44mm ED ø 53mm thickness 3mm with silicone O-ring		
	Part No.	359705	Ref. No. —
	oven lamp glass thr.ø 33.5mm ø 52mm hard glas temp.-resist. 350°C		
	Part No.	359946	Ref. No. —
	halogen lamp socket G9 230V 40W temp.-resist. 300°C		



1

Part No.	357176	Ref. No.	LAM30006
description	oven lamp mounting ø 35.5mm 230V 40W socket G9 temp.-resist. 300°C connection cable 100mm hard glas		



			
1			
Part No.	357232	Ref. No.	KLM00003
description	oven lamp mounting ø 35.5mm 230V 40W socket G9 temp.-resist. 300°C connection cable 85mm hard glas Qty 2 pcs		

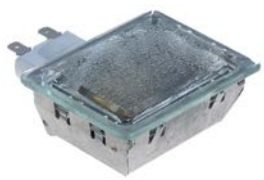

55x70mm			
			
1			
Part No.	358187	Ref. No.	LAM00004
description	oven lamp 230V 25W socket G9 L 80mm W 65mm mounting measurements 55x70mm rectangular connection male faston 6.3mm Qty 2 pcs		

			
1			
Part No.	359659	Ref. No.	611140005 LAM30002
description	oven lamp complete 230V 25W socket E14 L 70mm W 55mm mounting measurements 55x70mm temp.-resist. 300°C connection male faston 6.3mm		
For models:	704UD		

timers

programme timers

			
1			
Part No.	360743	Ref. No.	KPG00005 KPG00015 PRG30002 PRG30005
description	timer CDC 11902F1 engines 1 chambers 2 operation time 240s 230V 50/60Hz manuf. no. 11902F1AGE000.0070 motor type M48R 230V		

			
1			
Part No.	360758	Ref. No.	KSH00001
description	timer kit CDC 11902F1 engines 1 chambers 2 operation time 240s 230V 50/60Hz manuf. no. 11902F1AGE000.0070 motor type M48R 230V		
spare parts for	360758		
	Part No.	360743	Ref. No.
			KPG00005 KPG00015 PRG30002 PRG30005
description	timer CDC 11902F1 engines 1 chambers 2 operation time 240s 230V 50/60Hz manuf. no. 11902F1AGE000.0070 motor type M48R 230V		

mechanical timers

			
1			
Part No.	350130	Ref. No.	611130001 PRG30001
description	timer M11 with bell 1-pole operation time 120min impulse mechanical 1NO at 250V 16A permanent position yes shaft ø 6x4.6mm shaft L 23mm mounting distance 28mm mounting thread M4 connection male faston 6.3mm 4 hole fixing shaft flat upper		

electronics

PCBs

			
1			
Part No.	403225	Ref. No.	KSH00011 SCH30011
description	control PCB convection oven G544		



1 			
Part No.	403206	Ref. No.	SCH30008
description	keypad PCB convection oven 500/800 L 200mm 12V with display H 40mm mounting pos. horizontal buttons 7		

1 			
Part No.	403239	Ref. No.	KSH00005 SCH30010
description	PCB convection oven 824/524 L 180mm W 70mm 230V 12V voltage AC		

1 			
Part No.	401834	Ref. No.	7121000001 KSH00001 old version SCH30001
description	PCB for oven L 110mm W 80mm 230V		

1			
Part No.	403476	Ref. No.	SCH30028
description	PCB L 90mm W 48mm H 40mm		

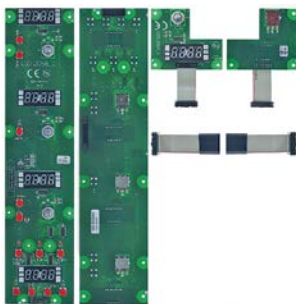
1 			
Part No.	403844	Ref. No.	KSH00004 SCH30003 SCH30004
description	PCB kit combi-steamer L 340mm W 80mm suitable for PIRON with ribbon cable display digital		

solenoid valves



solenoid valves (water)

RPE

1 			
Part No.	374021	Ref. No.	ELE30001
description	solenoid valve double straight 230VAC inlet 3/4" outlet 10mm DN10 RPE		

1 			
Part No.	374015	Ref. No.	ELE30002
description	solenoid valve single angled 230VAC inlet 3/4" outlet 10mm input 10-12l/min DN10 RPE flow regulating valve inlet white		

JOHN GUEST

1 				
Part No.	370772	Ref. No.	ELE30005 KEE00005	
description	solenoid valve double straight 230VAC inlet 3/4" outlet JG 8 DN10 t.max. 60°C duty cycle 100% RPE			
accessories for	370772			
	Part No.	371265	Ref. No.	—
	reducer flow rate 3l/min black			
	Part No.	371269	Ref. No.	—
	reducer flow rate 0.07-0.14l/min brown			





solenoid valves with reducers			
single			
			
1			
Part No.	374009	Ref. No.	ELE30004 KEE00004
description	solenoid valve single straight 220-240VAC inlet 3/4" outlet JG 8 input 10-12l/min output 0.07-0.14l/min t.max. 60°C duty cycle 100% RPE plastic flow regulating valve outlet brown flow regulating valve inlet white 1-ways medium temp max. 25°C		
For models:	704UD		

fans

hot air motors

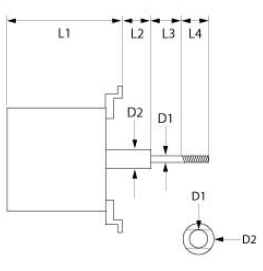
			
1			
Part No.	501568	Ref. No.	KMT00038
description	fan motor 200-230V 50/60Hz 0.2kW 2800/3400rpm speeds 2 L1 100mm D1 ø 110mm suitable capacitor 6.3µF/450V type CT80		

 			
1			
Part No.	500662	Ref. No.	MOT30002
description	fan motor 220-240V 1 phase 50/60Hz 0.12kW 2800/3200rpm speeds 1 L1 85mm L2 7mm L3 47mm L4 12mm D1 ø 8/6mm D2 ø 12mm MSR ET 1.6A power input 0.25W suitable capacitor 5µF/400V		

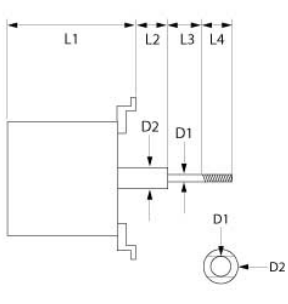
 			
1			
Part No.	500964	Ref. No.	KMT00006 MOT30004 MOT30006
description	fan motor 230V 3 phase 50Hz 0.08kW 2700rpm speeds 1 L1 78mm L2 7mm L3 47mm L4 12mm D1 ø 8/6mm D2 ø 12mm MSR ET at 50Hz 2700rpm suitable capacitor 6.3µF/450V with capacitor 6,3µF/450V		

			
1			
Part No.	601450	Ref. No.	VEN30002
description	fan wheel D1 ø 160mm H1 45mm blades 36 D2 ø 8mm D3 ø 8mm H2 24mm		

			
1			
Part No.	601778	Ref. No.	KVN00004 VEN30004
description	fan wheel D1 ø 197mm H1 43mm blades 45 D2 ø 8mm D3 ø 8x6.8mm H2 14mm H3 1.5mm		

			
1			
Part No.	601560	Ref. No.	VEN30003
description	fan wheel D1 ø 200mm H1 45mm blades 44 D2 ø 8mm D3 ø 8mm H2 24mm		





hot air fans

miscellaneous

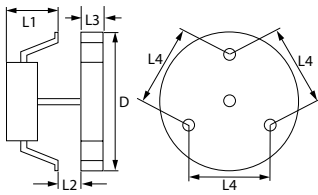

1



Part No.	500902	Ref. No.	KMT00029 MOT30029
description	fan motor 220V 55W 50/60Hz L1 68mm FIME type L25R without fan wheel		
accessories for	500902		
	Part No.	550879	Ref. No. —
	insulation ø 130mm thickness 3mm hole ø 20mm for hot air fan		



1

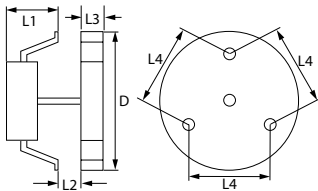

Part No.	601562	Ref. No.	MOT30003
description	hot air fan 220-240V 30W L1 60mm L2 13mm L3 25mm L4 87mm fan wheel ø 150mm IMS type VRD150H2629		



1

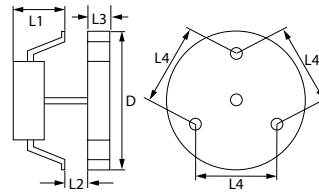

Part No.	601694	Ref. No.	MOT30005
description	hot air fan 220-240V 33W 50/60Hz L1 57mm L2 13mm L3 21mm L4 87mm fan wheel ø 150mm IMS type VRB150H2022		
For models:	704UD		

accessories

fan wheels for hot air fans



1

Part No.	601261	Ref. No.	KVN00013 VEN30013
description	fan wheel ø 154mm W 25mm shaft intake ø 6x5mm chrome-plated blades 7		

condensators & interference suppression filters

operating capacitors

plastic



1

Part No.	365009	Ref. No.	CON30001
description	operating capacitor capacity 2.5µF 400V tolerance 5% 50Hz ambient temperature max. -25 to +85°C ø 36.5mm L 55mm M8 plastic connection male faston 6.3mm 1.27.65C3 protection		



electric accessories

cables

power supply cables



1			
Part No.	551203	Ref. No.	CAV30013 CAV30014 KCV00014
description	connecting cable CEE7/7 type E+F 3-pole contacts P+N+E 2.5mm ² max. 16A max 230V 2m H07 RN-F with plug		

accessories

cable glands

threaded cable glands

screw connections



1			
Part No.	551379	Ref. No.	KPC00004 PPC30004
description	cable gland thread PG13.5 cable ø 12mm mounting ø 20mm WS 24 plastic Qty 1 pcs with nut		

terminals

connection terminals with screw/faston connections



1			
Part No.	550516	Ref. No.	KMR00005 MOR30005
description	power terminal block 3-pole max. 40A max 400V connection M6/ male faston 6.3mm temp.-resist. 150°C cross section 6mm ² mounting distance 66.5mm		

connection boxes



1			
Part No.	550671	Ref. No.	MOR30002
description	power terminal block 6-pole contacts 3P+N+E		

various



1			
Part No.	550794	Ref. No.	MOR30001
description	terminal 1-pole cross section 6-16mm ² Qty 1 pcs		
For models:	704UD		

equipment-specific units

for convection ovens/combi-steamers

glass panels



1			
Part No.	694950	Ref. No.	KVT00017 VET30017
description	door glass for combi-steamer L 485mm mounting pos. inner W 415mm thickness 4mm		



1			
Part No.	694951	Ref. No.	KVT05021 VET05021
description	door glass for combi-steamer L 555mm mounting pos. outer W 425mm thickness 4mm		



1			
Part No.	694406	Ref. No.	KVT00021 VET00021 VET30021
description	glass panel L 549mm W 420mm H 30mm thickness 4mm mounting pos. outer for hot air oven		



1 			
Part No.	694338	Ref. No.	803000031 KVT00070 VET00016 VET00070
description	glass panel L 750mm W 420mm thickness 4mm mounting pos. outer for oven		

for ovens

housing and bezels

1 			
Part No.	692763	Ref. No.	DEF30123 KDF00123
description	cover for hot air oven L 320mm W 325mm H 62mm		

knobs

universal knobs

1 			
Part No.	111492	Ref. No.	KMN00014 MAN30014
description	knob zero mark t.max.°C ø 47mm shaft ø 6x4.6mm shaft flat right nickel		

producer-specific knobs

PIRON

1 			
Part No.	111239	Ref. No.	MAN30008
description	knob switch zero mark ø 47mm shaft ø 6x4.6mm shaft flat right black		

1 			
Part No.	112803	Ref. No.	KMN00008
description	knob switch zero mark ø 47mm shaft ø 6x4.6mm shaft flat right black		

1 			
Part No.	699162	Ref. No.	KMN00024 MAN30024
description	knob zero mark ø 42.5mm shaft flat left black		

1 			
Part No.	111492	Ref. No.	KMN00014 MAN30014
description	knob zero mark t.max.°C ø 47mm shaft ø 6x4.6mm shaft flat right nickel		

handles and hand wheels

bracket handles

1 			
Part No.	691927	Ref. No.	MAG30008
description	pull handle L 550mm H 45mm mounting distance 512mm for oven handle M5		



locks



handle latches

universal

inside fixing

locks



Part No.	694225	Ref. No.	KMG00045 MAG30001-A MAG30019
description	door handle for headed units L 145mm W 40mm H 62mm spring length 55mm inner black		
spare parts for	694225		
	Part No.	514451	Ref. No. —
	spring for door handle ø 6mm L 76mm W 27.5mm		
	Part No.	694734	Ref. No. —
	door handle L 165mm W 40mm H 25mm black		
	Part No.	694735	Ref. No. —
	cap ø 32mm black		



producer-specific

PIRON

	Part No.	694226	Ref. No.	PIA30005
description	cover for door handle L 130mm W 43mm mounting distance 110mm stainless steel			

	Part No.	694066	Ref. No.	MAG30001-B
description	door catch with spigot 2-stage L 28mm W 14mm H 15mm H1 16mm total length 51mm thread M8 thread L 23mm stainless steel			



Part No.	694225	Ref. No.	KMG00045 MAG30001-A MAG30019
description	door handle for headed units L 145mm W 40mm H 62mm spring length 55mm inner black		
spare parts for	694225		
	Part No.	514451	Ref. No. —
	spring for door handle ø 6mm L 76mm W 27.5mm		
	Part No.	694734	Ref. No. —
	door handle L 165mm W 40mm H 25mm black		
	Part No.	694735	Ref. No. —
	cap ø 32mm black		



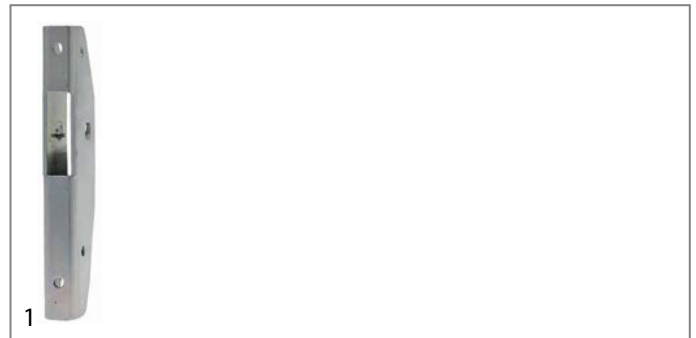

hinges





oven hinges



Part No.	700841	Ref. No.	742400002 CER30012 KCR00012
description	opposite support mounting distance 85mm L 107mm W 12.5mm for hinge		



			
Part No.	700623	Ref. No.	742400003 KCR00009
description	oven hinge mounting distance 154mm lever length 91mm groove distance 14mm spring thickness 3mm mounting pos. left/right zinc-coated steel		
accessories for	700623		
	Part No.	700628	Ref. No. —
	opposite support right oven hinge		
	Part No.	700629	Ref. No. —
	opposite support mounting distance 75mm L 95mm W 26mm left H 46mm M5 cut-out 10X30mm oven hinge		
	Part No.	700841	Ref. No. 742400002 CER30012 KCR00012
	opposite support mounting distance 85mm L 107mm W 12.5mm for hinge		

			
Part No.	700627	Ref. No.	742400001 CER30011
description	oven hinge mounting distance 154mm mounting distance 2mm lug mountingmm lever length 79mm groove distance 14mm spring thickness 3.5mm mounting ear position spring length 54mm L 165mm mounting pos. left/right zinc-coated steel		
accessories for	700627		
	Part No.	700628	Ref. No. —
	opposite support right oven hinge		
	Part No.	700629	Ref. No. —
	opposite support mounting distance 75mm L 95mm W 26mm left H 46mm M5 cut-out 10X30mm oven hinge		
	Part No.	700841	Ref. No. 742400002 CER30012 KCR00012
	opposite support mounting distance 85mm L 107mm W 12.5mm for hinge		

			
Part No.	701592	Ref. No.	2xCER30021+2xSTA00028 KCR00021
description	oven hinge set mounting distance 140mm lever length 42mm groove distance 15mm spring thickness 2.9mm L 170mm mounting pos. left/right with opposite support Qty 2 pcs		

equipment feet and end caps

screw-in feet

			
Part No.	701593	Ref. No.	KPE00010 PIE30010
description	equipment foot thread M10 thread L 18.5mm ø 49mm H 35mm plastic Qty 4 pcs		

			
Part No.	695545	Ref. No.	PIE30001
description	equipment foot thread M10 thread L 32mm ø 40mm H 12mm Qty 1 pcs		
For models:	704UD		

gaskets

gaskets for heated units

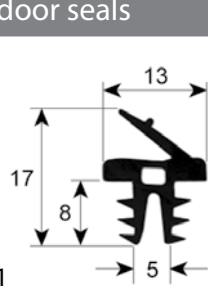
			
Part No.	900914	Ref. No.	7323000016
description	door seal profile 2300 Qty supplied by meter		



Part No.	902446	Ref. No.	GUA30015 KGA00015
description	door seal profile 2718 L 5500mm		

Part No.	901159	Ref. No.	7323000019
description	door seal profile 2755 L 2780mm		

Part No.	900913	Ref. No.	GUA30002 KGA00002
description	door seal profile 2755 Qty supplied by meter		
For models:	704UD		

fittings, hose and pipe connectors

push-in fittings

JOHN GUEST

Part No.	520497	Ref. No.	RAC30001
description	push-in fitting John Guest straight pipe connection ø8mm - ø8mm		
For models:	704UD		

Part No.	520585	Ref. No.	RAC30003
description	plug connector John Guest angled pipe connection ø8mm - ø8mm approval NSF, SK		
For models:	704UD		

water softeners

softener cartridges

BILT

accessories

Part No.	520585	Ref. No.	RAC30003
description	plug connector John Guest angled pipe connection ø8mm - ø8mm approval NSF, SK		
For models:	704UD		

fastening material

screws

flat-headed bolts

Part No.	560062	Ref. No.	VIT30018
description	flat-headed bolt thread M4 thread L 10mm SS DIN 7985/ISO 7045 Qty 20 pcs intake Phillips head ø 8mm head thickness 2mm		

nuts

miscellaneous

Part No.	551380	Ref. No.	DAD30010 KDD00010
description	cage nut thread M10 Qty 4 pcs		

GASTROPARTS.COM

