



**GASTROPARTS**

# Pavoni

**[EN]** Equipment

**[DE]** Geräte

**[ES]** Aparatos

**[FR]** Équipement

**[IT]** Attrezzature

**[PL]** Urządzenia

**[RU]** Оборудование

✉ [gastroparts@gastroparts.com](mailto:gastroparts@gastroparts.com)

☎ tel. +48 56 657 00 66

📘 [fb.com/gastroparts.global](https://fb.com/gastroparts.global)

**GASTROPARTS.COM**











# heating elements



## heating elements for coffee machine

			
<b>Part No.</b>	417133	<b>Ref. No.</b>	N/A
<b>description</b>	heating element 1300W 230V heating circuits 1 mounting ø 40mm hole distance 52mm L 323mm W 31mm H 59mm L1 30mm L2 55mm L3 235mm H1 9mm H2 50mm windings 1 hole ø 9mm tube ø 9mm immersion heater 3 hole flange suitable for PAVONI		

			
<b>Part No.</b>	417381	<b>Ref. No.</b>	331112
<b>description</b>	heating element 1500W 230V heating circuits 1 mounting ø 40mm hole distance 51mm L 133mm W 34mm H 29mm hole ø 9mm tube ø 8mm connection male faston 6.3mm immersion heater copper coffee machine parts		





			
<b>Part No.</b>	417045	<b>Ref. No.</b>	N/A
<b>description</b>	heating element 1800W 230V heating circuits 1 thread 1¼" L 135mm W 36mm H 39mm tube ø 8.5mm connection male faston 6.3mm immersion heater flange with thread		
<b>accessories for</b>	417045		
	<b>Part No.</b>	<b>Ref. No.</b>	—
	510405		
	flat gasket fibre ED ø 56mm ID ø 42mm thickness 2mm for thread 1¼" Qty 1 pcs		
	<b>Part No.</b>	<b>Ref. No.</b>	—
	528021		
	flat gasket PTFE ED ø 53mm ID ø 42.5mm thickness 3mm Qty 1 pcs equiv. no. 12001/02286 suitable for Astoria/Aurora/Brasilia/Wega		

			
<b>Part No.</b>	417382	<b>Ref. No.</b>	2310003001 331160
<b>description</b>	heating element 2870/3130W 230/240V heating circuits 3 mounting ø 40mm hole distance 51mm L 235mm W 32mm H 33mm hole ø 9mm length thermostat sleeves 140mm thermostat sleeves ø 6.5mm number of thermostat sleeves 1 thermostat sleeve centre not clinging tube ø 8mm connection male faston 6.3mm immersion heater 3 hole flange copper		
<b>accessories for</b>	417382		
	<b>Part No.</b>	<b>Ref. No.</b>	465016
	519179		
	O-ring EPDM thickness 3.53mm ID ø 41.28mm Qty 1 pcs		

			
<b>Part No.</b>	417062	<b>Ref. No.</b>	N/A
<b>description</b>	heating element 3000W 230/400V heating circuits 3 thread 1¼" L 238mm W 32mm H 26mm tube ø 8mm connection male faston 6.3mm immersion heater flange with thread		
<b>accessories for</b>	417062		
	<b>Part No.</b>	<b>Ref. No.</b>	—
	510405		
	flat gasket fibre ED ø 56mm ID ø 42mm thickness 2mm for thread 1¼" Qty 1 pcs		

<b>accessories for</b>	417062		
	<b>Part No.</b>	<b>Ref. No.</b>	—
	528021		
	flat gasket PTFE ED ø 53mm ID ø 42.5mm thickness 3mm Qty 1 pcs equiv. no. 12001/02286 suitable for Astoria/Aurora/Brasilia/Wega		

			
<b>Part No.</b>	417059	<b>Ref. No.</b>	331120 N/A
<b>description</b>	heating element 3000W 230V heating circuits 3 mounting ø 40mm hole distance 52mm L 240mm W 30mm H 67mm L1 40mm L2 60mm L3 140mm H1 31mm H2 34mm windings 3 hole ø 9mm tube ø 8.5mm connection male faston 6.3mm immersion heater suitable for PAVONI		

			
<b>Part No.</b>	417060	<b>Ref. No.</b>	N/A
<b>description</b>	heating element 4000W 230V heating circuits 3 mounting ø 40mm hole distance 52mm L 290mm W 30mm H 65mm L1 22mm L2 66mm L3 189mm H1 30mm H2 35mm windings 3 hole ø 10mm tube ø 8.5mm connection M3 immersion heater 3 hole flange suitable for PAVONI		
<b>accessories for</b>	417060		
	<b>Part No.</b>	<b>Ref. No.</b>	—
	527169		
	hexagonal nut thread M3 H 2.8mm WS 5.5 brass Qty 1 pcs		
	<b>Part No.</b>	<b>Ref. No.</b>	—
	560110		
	plain washer ID ø 3.2mm ED ø 7mm thickness 0.5mm SS Qty 20 pcs DIN 125A for thread M3		
	<b>Part No.</b>	<b>Ref. No.</b>	—
	560130		
	hexagonal nut thread M3 H 2.4mm WS 5.5 SS DIN/ISO DIN 934 / ISO 4032/8673 Qty 20 pcs		

			
<b>Part No.</b>	526625	<b>Ref. No.</b>	331114
<b>description</b>	heating element 4370/4760W 220/240V heating circuits 3 mounting ø 40mm hole distance 51mm L 315mm W 33mm H 33mm hole ø 9mm length thermostat sleeves 140mm thermostat sleeves ø 6.5mm number of thermostat sleeves 1 thermostat sleeve centre not clinging tube ø 8mm connection male faston 6.3mm immersion heater copper		

			
<b>Part No.</b>	417383	<b>Ref. No.</b>	2310004001 331153
<b>description</b>	heating element 4370/4760W 230/240V heating circuits 3 mounting ø 40mm hole distance 51mm L 313mm W 30mm H 34mm hole ø 9mm length thermostat sleeves 140mm thermostat sleeves ø 6.5mm number of thermostat sleeves 1 thermostat sleeve centre not clinging tube ø 8mm connection male faston 6.3mm immersion heater copper coffee machine parts		

→ electric components



			
1			
<b>Part No.</b>	417384	<b>Ref. No.</b>	2310005001 331154
<b>description</b>	heating element 5465/5950W 230/240V heating circuits 3 mounting $\varnothing$ 40mm hole distance 51mm L 405mm W 31mm H 33mm hole $\varnothing$ 9mm length thermostat sleeves 140mm thermostat sleeves $\varnothing$ 7mm number of thermostat sleeves 1 thermostat sleeve centre not clinging tube $\varnothing$ 8mm connection male faston 6.3mm immersion heater 3 hole flange copper coffee machine parts		

			
1			
<b>Part No.</b>	417385	<b>Ref. No.</b>	331335
<b>description</b>	heating element 920W 230V heating circuits 1 mounting $\varnothing$ 80mm hole distance 80mm L 50mm $\varnothing$ 59mm W 59mm H 96mm hole $\varnothing$ 9/6mm tube $\varnothing$ 6.5mm stainless steel		

## accessories

## sealing washers

## O-rings

			
1			
<b>Part No.</b>	510409	<b>Ref. No.</b>	N/A
<b>description</b>	O-ring EPDM thickness 5.34mm ID $\varnothing$ 56.52mm Qty 1 pcs		

			
1			
<b>Part No.</b>	532484	<b>Ref. No.</b>	GUAR0501
<b>description</b>	O-ring silicone thickness 2.62mm ID $\varnothing$ 37.77mm Qty 1 pcs		

## flange gaskets



			
1			
<b>Part No.</b>	528340	<b>Ref. No.</b>	361000
<b>description</b>	gasket ID $\varnothing$ 40.5mm fibre thickness 3mm hole $\varnothing$ 10mm hole distance 52mm for heating element coffee machine parts		

## thermostats



## bi-metal thermostats

## safety bi-metal thermostats

			
1			
<b>Part No.</b>	390711	<b>Ref. No.</b>	436040
<b>description</b>	bi-metal safety thermostat hole distancemm switch-off temp. 127°C 1NC 1-pole 16A connection F6.3 1 hole fixing		

			
1			
<b>Part No.</b>	390369	<b>Ref. No.</b>	OP189428200 OP189428200
<b>description</b>	bi-metal safety thermostat hole distancemm switch-off temp. 175°C 1NC 1-pole 16A connection F6.3		
<b>accessories for</b>	390369		
	<b>Part No.</b>	504736	<b>Ref. No.</b> —
	bracket for contact thermostat		

## bi-metal thermostats

			
1			
<b>Part No.</b>	390356	<b>Ref. No.</b>	000229 IS000229
<b>description</b>	bi-metal thermostat hole distancemm switch-off temp. 145°C 1NC 1-pole 16A connection F6.3		
<b>accessories for</b>	390356		
	<b>Part No.</b>	504736	<b>Ref. No.</b> —
	bracket for contact thermostat		
	<b>Part No.</b>	550389	<b>Ref. No.</b> —
	bracket for contact thermostat		



control and safety thermostats

EGO

safety thermostats

55.11\_ series



<b>Part No.</b>	375515	<b>Ref. No.</b>	436048
<b>description</b>	safety thermostat switch-off temp. 160°C 1-pole 1NC probe ø 6mm probe L 78mm capillary pipe 880mm capillary pipe isolated 840mm gland nut probe probe material SS		

switches and momentary switches

rocker/momentary rocker switches

30x22mm



<b>Part No.</b>	301003	<b>Ref. No.</b>	435061
<b>description</b>	rocker switch mounting measurements 30x22mm green 2NO 250V 16A illuminated 0-I connection male faston 6.3mm ambient temperature max. 125/55°C protection IP65		

<b>accessories for</b>	301003
	Part No. 301036 Ref. No. — protective cover internal size 30x22mm for rocker switch mounting measurementsmm



<b>Part No.</b>	301002	<b>Ref. No.</b>	435014
<b>description</b>	rocker switch mounting measurements 30x22mm orange 2NO 250V 16A illuminated 0-I connection male faston 6.3mm ambient temperature max. 85/125°C protection IP65		

<b>accessories for</b>	301002
	Part No. 301036 Ref. No. — protective cover internal size 30x22mm for rocker switch mounting measurementsmm



<b>Part No.</b>	301060	<b>Ref. No.</b>	5350002
<b>description</b>	rocker switch mounting measurements 30x22mm red 2NO 250V 16A illuminated connection male faston 6.3mm ambient temperature max. 125/55°C protection IP40		

	<b>Part No.</b>	301276	<b>Ref. No.</b>	5350009
<b>description</b>	momentary rocker switch mounting measurements 30x22mm black 2NO 250V 16A cup connection male faston 6.3mm ambient temperature max. 85°C protection IP40			

	<b>Part No.</b>	346111	<b>Ref. No.</b>	5350008
<b>description</b>	rocker switch mounting measurements 30x22mm red 2NO 250V 16A illuminated cup warmer connection male faston 6.3mm ambient temperature max. 125/55°C protection IP40			

	<b>Part No.</b>	301269	<b>Ref. No.</b>	5350005 5350007
<b>description</b>	rocker switch mounting measurements 30x22mm red 2NO 250V 16A illuminated heating large connection male faston 6.3mm ambient temperature max. 100/55°C protection IP40			



	<b>Part No.</b>	301268	<b>Ref. No.</b>	5350006
<b>description</b>	rocker switch mounting measurements 30x22mm red 2NO 250V 16A illuminated heating small connection male faston 6.3mm ambient temperature max. 125/55°C protection IP40			



with symbol

	<b>Part No.</b>	301264	<b>Ref. No.</b>	435076
<b>description</b>	rocker switch mounting measurements 30x22mm green 2NO 250V 16A illuminated cup warmer connection male faston 6.3mm ambient temperature max. 85°C protection IP65 with cover cap			

<b>spare parts for</b>	301264
	Part No. 301036 Ref. No. — protective cover internal size 30x22mm for rocker switch mounting measurementsmm

<b>accessories for</b>	301264
	Part No. 301036 Ref. No. — protective cover internal size 30x22mm for rocker switch mounting measurementsmm

			
1			
<b>Part No.</b>	301267	<b>Ref. No.</b>	435072
<b>description</b>	rocker switch mounting measurements 30x22mm green 2NO 250V 16A illuminated flash connection male faston 6.3mm ambient temperature max. 85°C protection IP65 with cover cap		
<b>accessories for</b>	301267		
	<b>Part No.</b>	301036	<b>Ref. No.</b> —
	protective cover internal size 30x22mm for rocker switch mounting measurementsmm		

			
1			
<b>Part No.</b>	301266	<b>Ref. No.</b>	435073
<b>description</b>	rocker switch mounting measurements 30x22mm green 2NO 250V 16A illuminated heating connection male faston 6.3mm ambient temperature max. 85°C protection IP65 with cover cap		
<b>spare parts for</b>	301266		
	<b>Part No.</b>	301036	<b>Ref. No.</b> —
	protective cover internal size 30x22mm for rocker switch mounting measurementsmm		
<b>accessories for</b>	301266		
	<b>Part No.</b>	301036	<b>Ref. No.</b> —
	protective cover internal size 30x22mm for rocker switch mounting measurementsmm		

36.5x22mm

			
1			
<b>Part No.</b>	346074	<b>Ref. No.</b>	N/A
<b>description</b>	rocker switch mounting measurements 37x21mm black 2NO/indicator light 250V 10A illuminated connection male faston 6.3mm ambient temperature max. 85°C protection IP40		

**lamps**

indicator lights

indicator lights (complete)

ø12mm

with screw socket

			
1			
<b>Part No.</b>	359048	<b>Ref. No.</b>	B7633617
<b>description</b>	indicator light ø 12mm 230V yellow connection male faston 6.3mm		

**contactors**

miscellaneous

power contactors

			
1			
<b>Part No.</b>	380919	<b>Ref. No.</b>	435102
<b>description</b>	power contactor 230V resistive load 30A (AC3/400V) 4kW main contacts 3NO auxiliary contacts 1NO connection screw type GH15BN ghisalba		

**relays**

level relays

GICAR

			
1			
<b>Part No.</b>	402103	<b>Ref. No.</b>	438050
<b>description</b>	level controller 230/240V voltage AC 50/60Hz connection F6.3 type NRL30/1E-2C/F		

**electronics**

central units

			
1			
<b>Part No.</b>	402547	<b>Ref. No.</b>	438232 438264
<b>description</b>	central unit 2-group 230V voltage AC		

1

<b>Part No.</b>	402546	<b>Ref. No.</b>	438270
<b>description</b>	central unit 3-group 230V voltage AC		



1

<b>Part No.</b>	402548	<b>Ref. No.</b>	438233 438265
<b>description</b>	central unit 3-group 230V voltage AC		

## keypads

### membrane keypads



1

<b>Part No.</b>	401443	<b>Ref. No.</b>	438300
<b>description</b>	membrane keypad buttons 5		

### keypad units



1

<b>Part No.</b>	400378	<b>Ref. No.</b>	N/A
<b>description</b>	keypad unit		

## solenoid valves

### solenoid valves (water)

metal

PARKER

3-way

VE-128 series



1

<b>Part No.</b>	370587	<b>Ref. No.</b>	451276
<b>description</b>	solenoid valve 3-ways 230VAC connection 1/8" inner cone DN 1.20mm slide-on receptacle DIN -20° up to 140°C PARKER type series VE 128R coil type ZB09 membranes ruby p max 10bar brass EPDM coffee machine parts flange 32x32mm		

## pressure switches

### for coffee machines

ø 33mm



1

<b>Part No.</b>	541745	<b>Ref. No.</b>	451302 451308
<b>description</b>	pressure control ø 33mm pressure range 0.5-1.2bar 16A 250V coffee machine parts connection 1/4" 1NC ambient temperature max. 125°C pressure connection 1/4"		

## electrodes



1

<b>Part No.</b>	402549	<b>Ref. No.</b>	438015 438023
<b>description</b>	level electrode 1/4" total length 125mm probe L 100mm insulated probe length 25mm angled connection F6.3 ø 2.5mm		



## pumps

### booster pumps II

#### pump heads

#### FLUID-O-TECH



1

<b>Part No.</b>	500064	<b>Ref. No.</b>	N/A
<b>description</b>	pump head PO204 FLUID-O-TECH L 82mm 200l/h connection 3/8" GAS with bypass brass clip connection for coffee machine shaft ø 4.8x11mm		
<b>accessories for</b>	500064		
	<b>Part No.</b>	520126	<b>Ref. No.</b> —
	clamp for pump/motor		

### vibration pumps



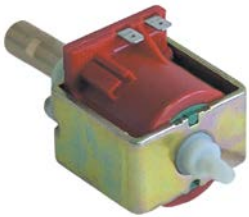

1

<b>Part No.</b>	500173	<b>Ref. No.</b>	ODMC006
<b>description</b>	vibration pump type EP 5 230V 48W 50Hz inlet ø 6 outlet ø 1/8" IT ULKA outlet flat plastic L 123mm		



1

<b>Part No.</b>	500124	<b>Ref. No.</b>	451001
<b>description</b>	vibration pump type EX 5 230V 48W 50/60Hz inlet ø 6 outlet ø 1/8" IT flat seal ULKA brass L 123mm		
<b>accessories for</b>	500124		
	<b>Part No.</b>	520152	<b>Ref. No.</b> —
	hose connector Santoprene grommet ø 7mm grommet length 14mm		
	<b>Part No.</b>	520330	<b>Ref. No.</b> —
	bracket rubber dimensions 69x44x4mm		



1

<b>Part No.</b>	500996	<b>Ref. No.</b>	OP12000140
<b>description</b>	vibration pump type EX 5 230V 48W 50Hz inlet ø 6 outlet ø 1/8" ULKA outlet conical brass L 123mm		

## equipment-specific units

### for espresso machines

#### filter holders

#### filter holders standard

#### filter holder without spout

1

<b>Part No.</b>		<b>Ref. No.</b>	N/A
<b>description</b>	filter holder suitable for PAVONI without outlet mounting ø 80.5mm outlet 3/8" ID ø 61mm wedge height 14mm wedge position diagonal number of wedges 2 lever inclined		

#### filter holders short



1

<b>Part No.</b>	525708	<b>Ref. No.</b>	3111164
<b>description</b>	filter holder mounting ø 65mm outlet 3/8" ID ø 54.1mm handle M12x1.75 wedge height 8mm wedge position horizontal number of wedges 2 lever straight chrome-plated brass		





1

<b>Part No.</b>	529034	<b>Ref. No.</b>	31109241 31109244
<b>description</b>	filter holder mounting ø 80.5mm outlet 3/8" ID ø 61mm handle M12x1.75 wedge height 14mm wedge position diagonal number of wedges 2 lever inclined chrome-plated brass		





handles			
with external thread			
			
1			
<b>Part No.</b>	529167	<b>Ref. No.</b>	N/A
<b>description</b>	handle ø 39mm thread M12x1.75 thread L 18mm L 126mm black		

with bore			
			
1			
<b>Part No.</b>	529105	<b>Ref. No.</b>	N/A
<b>description</b>	handle ø hexagon 34mm aperture 12x12mm L 115mm black		

spouts			
with thread 3/8"			
			
1			
<b>Part No.</b>	529008	<b>Ref. No.</b>	3111174
<b>description</b>	filter holder spout thread 3/8" 2-way curved outlet distance 33mm		

filters			
for 1 cup			
			
1			
<b>Part No.</b>	525710	<b>Ref. No.</b>	327054 327057
<b>description</b>	coffee filter ø 60mm mounting ø 53.5mm H 21mm cups 1 amount of coffeeg		

for 2 cups			
			
1			
<b>Part No.</b>	525709	<b>Ref. No.</b>	327053
<b>description</b>	coffee filter ø 60mm mounting ø 54mm H 25mm cups 2 amount of coffeeg		

filter holder springs			
			
1			
<b>Part No.</b>	525711	<b>Ref. No.</b>	311437
<b>description</b>	filter holder spring L 62mm W 56.5mm wire gauge ø 1mm for espresso filter holder		

			
1			
<b>Part No.</b>	531243	<b>Ref. No.</b>	N/A
<b>description</b>	filter holder spring L 70mm W 60mm wire gauge ø 1.3mm for espresso filter holder Qty 20 pcs		

brewing units			
shower screens			
with upstand and central hole			
			
1			
<b>Part No.</b>	525712	<b>Ref. No.</b>	327105 327106
<b>description</b>	shower screen ø 56.8mm H 6mm hole ø 5.5mm with upstand		

with upstand			
			
1			
<b>Part No.</b>	525707	<b>Ref. No.</b>	327115
<b>description</b>	shower screen ø 51mm H 14.3mm with upstand ID ø 50mm ED ø 54mm		

screws			
			
1			
<b>Part No.</b>	560414	<b>Ref. No.</b>	312304
<b>description</b>	hexagonal screw thread M6 thread L 14mm stainless steel Qty 1 pcs intake conical WS 10 L 20mm		

filter holder gaskets			
O-rings			
			
1			
<b>Part No.</b>	510409	<b>Ref. No.</b>	N/A
<b>description</b>	O-ring EPDM thickness 5.34mm ID ø 56.52mm Qty 1 pcs		





## miscellaneous



1

<b>Part No.</b>	525740	<b>Ref. No.</b>	361028 465301
<b>description</b>	filter holder gasket D1 ø 60mm D2 ø 50mm H 5.5mm edition from 1998 on		

## brewing units with solenoid valve

## gaskets



1

<b>Part No.</b>	525743	<b>Ref. No.</b>	362058
<b>description</b>	flat gasket PTFE ED ø 16.5mm ID ø 13mm thickness 2mm Qty 1 pcs		

## brewing units manual

## components

## drain units

## drain valves



1

<b>Part No.</b>	526002	<b>Ref. No.</b>	395229
<b>description</b>	valve support ø 16mm L 27mm brass shaft triangular D1 ø 10mm D2 ø 7mm		

## gaskets



1

<b>Part No.</b>	525745	<b>Ref. No.</b>	362069
<b>description</b>	flat gasket PTFE ED ø 26mm ID ø 22.5mm thickness 1mm Qty 1 pcs		

## gaskets



1

<b>Part No.</b>	525742	<b>Ref. No.</b>	362077
<b>description</b>	flat gasket PTFE ED ø 9.8mm ID ø 6.1mm thickness 1mm Qty 1 pcs		



1

<b>Part No.</b>	528494	<b>Ref. No.</b>	362027
<b>description</b>	gasket rubber ED ø 13mm ID ø 4mm thickness 4mm Qty 1 pcs		

## miscellaneous



1

<b>Part No.</b>	525718	<b>Ref. No.</b>	314133
<b>description</b>	bolt brass thread M4 ø 4.5mm L 35mm		



1

<b>Part No.</b>	525716	<b>Ref. No.</b>	312224
<b>description</b>	bolt square brass thread M3 L 11.8mm W 6mm H 6mm thread L 11.5mm		



1

<b>Part No.</b>	525717	<b>Ref. No.</b>	312225
<b>description</b>	bolt square brass thread M3 L 12mm W 6mm H 6mm thread L 8.5mm		



1

<b>Part No.</b>	525715	<b>Ref. No.</b>	312227
<b>description</b>	bolt square brass thread M3 L 13mm W 6mm H 6mm thread L 10mm		

## springs



1

<b>Part No.</b>	527934	<b>Ref. No.</b>	311419
<b>description</b>	compression spring ø 14.2mm L 45mm wire gauge ø 1.5mm SS		

## camshafts



1

<b>Part No.</b>	525646	<b>Ref. No.</b>	314077
<b>description</b>	camshaft shaft ø 8mm shaft intake ø 6.2mm L 86.5mm W 20mm H 17mm thread 12-28 UNF		

## valves



1



<b>Part No.</b>	525719	<b>Ref. No.</b>	314070
<b>description</b>	gasket support L 18mm ED ø 16mm ID ø 13mm shaft ø 10/7mm brass		

<b>accessories for</b>	525719	<b>Part No.</b>	528494	<b>Ref. No.</b>	362027
------------------------	--------	-----------------	--------	-----------------	--------



gasket rubber ED ø 13mm ID ø 4mm thickness 4mm Qty 1 pcs



 <p>1</p>			
<b>Part No.</b>	526008	<b>Ref. No.</b>	395227
<b>description</b>	valve group outflow L 54.3mm ED ø 16mm shaft ø 4.5mm brass		
<b>accessories for</b>	526008		
			
<b>Part No.</b>	526003	<b>Ref. No.</b>	—
<b>description</b>	compression spring ø 13.8mm L 54.5mm wire gauge ø 1.5mm windings 10 drain valve		
			
<b>Part No.</b>	532550	<b>Ref. No.</b>	—
<b>description</b>	O-ring NBR 787/70 thickness 2.62mm ID ø 9.13mm Qty 10 pcs		

 <p>1</p>			
<b>Part No.</b>	526007	<b>Ref. No.</b>	395228
<b>description</b>	valve group supply L 52.8mm ED ø 16mm shaft triangular		

brewing units with lever

drain valves

gaskets

 <p>1</p>			
<b>Part No.</b>	525729	<b>Ref. No.</b>	362055
<b>description</b>	gasket for drain assembly D1 ø 15mm D2 ø 6mm thickness 6mm rubber		

levers

levers

 <p>1</p>			
<b>Part No.</b>		<b>Ref. No.</b>	3954003 3954005
<b>description</b>	lever suitable for La Pavoni M12x1.75 gold plated total length 230mm		

components

shower supports

 <p>1</p>			
<b>Part No.</b>	525720	<b>Ref. No.</b>	31109171
<b>description</b>	shower support D1 ø 58mm D2 ø 51.5mm H 15.5mm for PAVONI hole ø 10.5mm		

nozzles

with thread

 <p>1</p>			
<b>Part No.</b>	528176	<b>Ref. No.</b>	314008
<b>description</b>	nozzle bore ø 0.7mm thread M5x0.75 conical		

 <p>1</p>			
<b>Part No.</b>	528486	<b>Ref. No.</b>	314068
<b>description</b>	nozzle bore ø 0.7mm thread M6x0.75 L 9mm WS 7		

springs

 <p>1</p>			
<b>Part No.</b>	526561	<b>Ref. No.</b>	311421
<b>description</b>	compression spring ø 14.3mm L 21mm wire gauge ø 1.8mm		

screws

 <p>1</p>			
<b>Part No.</b>	560373	<b>Ref. No.</b>	403203
<b>description</b>	cylinder head bolt thread M4 thread L 12mm WS 3 SS Qty 1 pcs intake internal hexagon DIN 912/ISO 4762		

 <p>1</p>			
<b>Part No.</b>	525721	<b>Ref. No.</b>	404013
<b>description</b>	threaded rod thread M8 L 22mm intake slotted		

water dispersions

water dispersions

group 3

 <p>1</p>			
<b>Part No.</b>	525714	<b>Ref. No.</b>	3141537
<b>description</b>	water distributor ø 30mm H 5.5mm hole ø 6mm		

 <p>1</p>			
<b>Part No.</b>	528846	<b>Ref. No.</b>	3141287
<b>description</b>	water distributor ø 30mm H 5.6mm hole ø 5mm		



## 2-piece



1

<b>Part No.</b>	525720	<b>Ref. No.</b>	31109171
<b>description</b>	shower support D1 ø 58mm D2 ø 51.5mm H 15.5mm for PAVONI hole ø 10.5mm		

## safety valves

## safety valves

## metric thread



1

<b>Part No.</b>	529330	<b>Ref. No.</b>	N/A
<b>description</b>	safety valve connection M22x1.25 triggering pressure 1.8bar		

## expansion valves



1

<b>Part No.</b>	529691	<b>Ref. No.</b>	N/A
<b>description</b>	expansion valve T1: 1/8" ET T2: 1/8" ET		

## with hose connection



1

<b>Part No.</b>	525703	<b>Ref. No.</b>	453201
<b>description</b>	expansion valve T1: 1/8" ET hose ø 9mm total length 47mm		

## drain pans

## covers



1

<b>Part No.</b>	525701	<b>Ref. No.</b>	371011
<b>description</b>	collecting pipe L 100mm W 42mm H 40mm hose ø 8mm		

## drain pans



1

<b>Part No.</b>	525700	<b>Ref. No.</b>	371010
<b>description</b>	drain pan L 100mm W 80mm H 47mm hose ø 12mm		

## aerators and air bleeders



1

<b>Part No.</b>	529303	<b>Ref. No.</b>	453203
<b>description</b>	aerator and air bleeder connection 1/4" only steam		

spare parts for 529303



<b>Part No.</b>	528687	<b>Ref. No.</b>	465014
-----------------	--------	-----------------	--------

O-ring Viton thickness 1.78mm ID ø 3.69mm Qty 1 pcs

## steam/water taps

## steam/water taps

## steam/water taps

1

<b>Part No.</b>	525625	<b>Ref. No.</b>	395119
<b>description</b>	steam/water tap		

1

<b>Part No.</b>	525623	<b>Ref. No.</b>	2951007
<b>description</b>	steam/water tap mounting pos. left/right for PAVONI		

1

<b>Part No.</b>	525624	<b>Ref. No.</b>	2951002
<b>description</b>	steam/water tap mounting pos. left/right suitable for PAVONI Tr18x4		





1

<b>Part No.</b>	525626	<b>Ref. No.</b>	394210
<b>description</b>	steam/water tap suitable for PAVONI		

**components**

**bushes**



1

<b>Part No.</b>	525728	<b>Ref. No.</b>	313118
<b>description</b>	bush for steam-/water-tap D1 ø 12mm D2 ø 8.5mm ID ø 6.5mm H 6mm brass		

**gaskets**



1

<b>Part No.</b>	525727	<b>Ref. No.</b>	361023
<b>description</b>	gasket D1 ø 12.4mm D2 ø 7mm thickness 5mm rubber		

**springs**



1

<b>Part No.</b>	526685	<b>Ref. No.</b>	311416
<b>description</b>	compression spring ø 14.3mm L 30.5mm wire gauge ø 1.8mm		

**levers**



1

<b>Part No.</b>	525724	<b>Ref. No.</b>	311501
<b>description</b>	lever for steam-/water-tap L 32mm T1: M6 ø 15mm shaft ø 5.5mm		

**washers**



1

<b>Part No.</b>	525734	<b>Ref. No.</b>	3130204
<b>description</b>	plain washer D1 ø 27mm D2 ø 21.2mm thickness 2mm SS for steam-/water-tap		

**miscellaneous**



1

<b>Part No.</b>	525723	<b>Ref. No.</b>	3431414
<b>description</b>	cover for steam-/water-tap ø 30mm L 79mm		
<b>accessories for</b>	525723		
	<b>Part No.</b>	525735	<b>Ref. No.</b>
			313016
<b>description</b>	ring for steam-/water-tap ø 31.2mm H 8mm		



1

<b>Part No.</b>	525735	<b>Ref. No.</b>	313016
<b>description</b>	ring for steam-/water-tap ø 31.2mm H 8mm		
<b>accessories for</b>	525735		
	<b>Part No.</b>	525723	<b>Ref. No.</b>
			3431414
<b>description</b>	cover for steam-/water-tap ø 30mm L 79mm		

**steam/water pipes**

**steam pipes**



1

<b>Part No.</b>	529695	<b>Ref. No.</b>	P1 3430264
<b>description</b>	steam pipe		



1

<b>Part No.</b>	525628	<b>Ref. No.</b>	395525NSF
<b>description</b>	steam pipe with nozzle L 175mm tube ø 10mm stainless steel approval NSF		



1

<b>Part No.</b>	525627	<b>Ref. No.</b>	395529NSF
<b>description</b>	steam pipe with nozzle L 210mm tube ø 10mm stainless steel approval NSF		



## nozzles for water pipes

## nozzles for water pipes



1

<b>Part No.</b>	525702	<b>Ref. No.</b>	3141497
<b>description</b>	nozzle D1 ø 18mm D2 ø 12.5mm H 30mm thread 1/8" for water pipe stainless steel approval NSF		



1

<b>Part No.</b>	525704	<b>Ref. No.</b>	314132 3141327 32413277
<b>description</b>	nozzle D1 ø 21mm D2 ø 10mm H 20mm for water pipe chrome-plated brass		

## accessories

## bushes



1

<b>Part No.</b>	529736	<b>Ref. No.</b>	313109
<b>description</b>	bush		

## gaskets

1

<b>Part No.</b>		<b>Ref. No.</b>	466013
<b>description</b>	slide ring PTFE D1 ø 12.3mm D2 ø 10.4mm thickness 2mm for water pipe		

## tube handles



1

<b>Part No.</b>	525152	<b>Ref. No.</b>	371081
<b>description</b>	handle for pipe ø 10mm L 40mm rubber		

## union nuts



1

<b>Part No.</b>	525705	<b>Ref. No.</b>	3133147
<b>description</b>	union nut thread 3/8" L 30mm hole ø 12mm SS for steam/water pipes		

## gaskets

## flat gaskets

## fibre gaskets



1

<b>Part No.</b>	525739	<b>Ref. No.</b>	362019
<b>description</b>	gasket D1 ø 93mm D2 ø 80mm thickness 1.6mm		

## rubber gaskets



1

<b>Part No.</b>	698834	<b>Ref. No.</b>	362068
<b>description</b>	group gasket D1 ø 53mm D2 ø 41.5mm thickness 7mm		



1

<b>Part No.</b>	698833	<b>Ref. No.</b>	361008
<b>description</b>	group gasket D1 ø 73mm D2 ø 57mm thickness 8mm		

## PTFE gaskets



1

<b>Part No.</b>	525745	<b>Ref. No.</b>	362069
<b>description</b>	flat gasket PTFE ED ø 26mm ID ø 22.5mm thickness 1mm Qty 1 pcs		

## piston seals



1

<b>Part No.</b>	525741	<b>Ref. No.</b>	361005
<b>description</b>	piston gasket D1 ø 43.5mm D2 ø 31.5mm thickness 5.5mm		

## fine filters

## fine filters



1

<b>Part No.</b>	528317	<b>Ref. No.</b>	327150
<b>description</b>	fine filter fabric ø 14mm H 12.5mm		



1

<b>Part No.</b>	525713	<b>Ref. No.</b>	327154
<b>description</b>	fine filter flat ø 14mm H 0.2mm		





			
1			
<b>Part No.</b>	529979	<b>Ref. No.</b>	327151
<b>description</b>	fine filter ø 8.8mm H 22mm		

intake valves

accessories

push buttons

			
1			
<b>Part No.</b>	111015	<b>Ref. No.</b>	475019
<b>description</b>	knob PUSH ø 36mm shaft ø 6mm for PAVONI		

			
1			
<b>Part No.</b>	525725	<b>Ref. No.</b>	212000404
<b>description</b>	pressure pin for filling valve ø 15.8mm L 45mm stainless steel		

level glasses

adapters

			
1			
<b>Part No.</b>	530437	<b>Ref. No.</b>	3132034
<b>description</b>	connection for level glass ø 13mm L 15mm for La Pavoni		

level glasses

gaskets



			
1			
<b>Part No.</b>	525730	<b>Ref. No.</b>	362020
<b>description</b>	gasket D1 ø 14.6mm D2 ø 8.6mm thickness 5mm silicone for level glass pipe		

			
1			
<b>Part No.</b>	526678	<b>Ref. No.</b>	361002
<b>description</b>	gasket D1 ø 16.5mm D2 ø 12mm H 11mm		

pressure rings

			
1			
<b>Part No.</b>	525733	<b>Ref. No.</b>	313004
<b>description</b>	press ring D1 ø 14.6mm D2 ø 9.6mm thickness 1.5mm brass for level glass pipe		

level glass pipes

			
1			
<b>Part No.</b>	525642	<b>Ref. No.</b>	453110
<b>description</b>	water level tube ø 12mm H 106mm marking red		
<b>accessories for</b>	525642		
	<b>Part No.</b>	526678	<b>Ref. No.</b>
			361002
		gasket D1 ø 16.5mm D2 ø 12mm H 11mm	

			
1			
<b>Part No.</b>	525637	<b>Ref. No.</b>	453101
<b>description</b>	water level tube ø 9mm H 132mm		

pipes

reduction washers

			
1			
<b>Part No.</b>	525722	<b>Ref. No.</b>	314109
<b>description</b>	reducing washer for pipe ø 10mm hole ø 2.5mm ø 12mm W 5mm		

non-return valves

complete

			
1			
<b>Part No.</b>	529335	<b>Ref. No.</b>	453200
<b>description</b>	non-return valve inlet 1/8" outlet 1/8" L 30mm		

1			
<b>Part No.</b>		<b>Ref. No.</b>	N/A
<b>description</b>	non-return valve T1: 1/8" T2: 1/8"		



## for coffee grinders

## adjustment mechanism

## lockable adjustment



1

<b>Part No.</b>	526336	<b>Ref. No.</b>	OBEB06
<b>description</b>	pressure pin for setting ring L 36mm W 20mm shaft ø 5mm shaft length 30mm		

## setting rings



1

<b>Part No.</b>	527413	<b>Ref. No.</b>	OBEB053
<b>description</b>	setting ring suitable for Obel for EB equiv. no. EB053		

## coffee beans containers

## container lids



1

<b>Part No.</b>	527333	<b>Ref. No.</b>	OBEB01
<b>description</b>	lid for coffee beans container ø 182mm		

## coffee beans containers



1

<b>Part No.</b>	527334	<b>Ref. No.</b>	OBEG02G	
<b>description</b>	coffee beans container ø 185mm H 211mm seat ø 65mm			
<b>spare parts for</b>	527334			
	<b>Part No.</b>	527333	<b>Ref. No.</b>	OBEB01
	lid for coffee beans container ø 182mm			

<b>spare parts for</b>	527334			
	<b>Part No.</b>	527567	<b>Ref. No.</b>	—
	protection cap with magnet			



1

<b>Part No.</b>	531183	<b>Ref. No.</b>	OBEB02 OBEB02G
<b>description</b>	coffee beans container with lid ø 185mm H 211mm seat ø 65mm		

## for cup coffee machines

## miscellaneous



1

<b>Part No.</b>	650242	<b>Ref. No.</b>	371101
<b>description</b>	equipment foot ø 30mm H 4mm mounting ø 10mm overall height 9.5mm rubber Qty 1 pcs		



1

<b>Part No.</b>	650243	<b>Ref. No.</b>	OP144650300
<b>description</b>	water filter ø 6mm L 60mm		

## for dishwashers

## door mechanics

## miscellaneous



1

<b>Part No.</b>	528224	<b>Ref. No.</b>	361007
<b>description</b>	gasket PTFE gasket		



knobs

steam/water taps

steam/water taps



1	<b>Part No.</b>	531193	<b>Ref. No.</b>	3710559
<b>description</b> turning handle ø 46mm black for PAVONI for tap				



1	<b>Part No.</b>	525630	<b>Ref. No.</b>	371055
<b>description</b> turning handle ø 46mm grey for PAVONI for tap				



1	<b>Part No.</b>	525631	<b>Ref. No.</b>	2711014 371020
<b>description</b> turning handle ø 50mm thread Tr18x4 black for steam-/water-tap				

knob dial plates



1	<b>Part No.</b>	525737	<b>Ref. No.</b>	313021
<b>description</b> plain washer with turning handle ø 20mm ID ø 6.4mm thickness 3mm brass				



1	<b>Part No.</b>	525632	<b>Ref. No.</b>	2710001
<b>description</b> symbol steam for steam tap ø 50mm chrome-plated				



1	<b>Part No.</b>	525634	<b>Ref. No.</b>	37102101 37102102
<b>description</b> symbol steam for steam tap ø 50mm grey for PAVONI				



1	<b>Part No.</b>	525633	<b>Ref. No.</b>	37102122
<b>description</b> symbol water for water tap ø 50mm grey for PAVONI				



1	<b>Part No.</b>	531145	<b>Ref. No.</b>	2710002
<b>description</b> symbol water ø 50mm ID ø 39mm chrome plastic				

accessories



1	<b>Part No.</b>	525732	<b>Ref. No.</b>	311429
<b>description</b> retainer clip L 14mm wire gauge ø 1.5mm SS Qty 1 pcs				



1	<b>Part No.</b>	525706	<b>Ref. No.</b>	475010
<b>description</b> star handle bore ø 6mm ø 40mm L1 21.5mm L2 7mm transverse bore ø 4.3mm				

handles and hand wheels

cylindrical handles

fixed



1	<b>Part No.</b>	525736	<b>Ref. No.</b>	475002
<b>description</b> cylindrical handle thread M6 ø 18mm L 45mm black				



1	<b>Part No.</b>	525641	<b>Ref. No.</b>	4750012
<b>description</b> cylindrical handle thread M8 ø 21mm L 50mm plastic grey				

cone handles



1	<b>Part No.</b>	525639	<b>Ref. No.</b>	371125
<b>description</b> cone handle ø 29mm L 92mm thread M12 black				





## star handles



<b>Part No.</b>	525706	<b>Ref. No.</b>	475010
<b>description</b>	star handle bore $\varnothing$ 6mm $\varnothing$ 40mm L1 21.5mm L2 7mm transverse bore $\varnothing$ 4.3mm		

## accessories

## miscellaneous



<b>Part No.</b>	525640	<b>Ref. No.</b>	3123547
<b>description</b>	threaded rod L 45mm SS M12x1.75		

## equipment feet and end caps

## equipment feet with stem



<b>Part No.</b>	650242	<b>Ref. No.</b>	371101
<b>description</b>	equipment foot $\varnothing$ 30mm H 4mm mounting $\varnothing$ 10mm overall height 9.5mm rubber Qty 1 pcs		

## gaskets

## O-rings

## EPDM

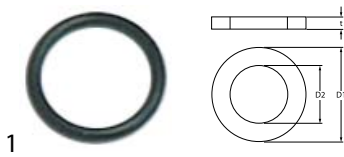

<b>Part No.</b>	510302	<b>Ref. No.</b>	465042
<b>description</b>	O-ring EPDM ID $\varnothing$ 12.42mm thickness 1.78mm Qty 1 pcs		



<b>Part No.</b>	528815	<b>Ref. No.</b>	465003
<b>description</b>	O-ring EPDM thickness 1.78mm ID $\varnothing$ 3.69mm Qty 1 pcs		



<b>Part No.</b>	528223	<b>Ref. No.</b>	465108
<b>description</b>	O-ring EPDM thickness 2.62mm ID $\varnothing$ 11.91mm Qty 1 pcs		

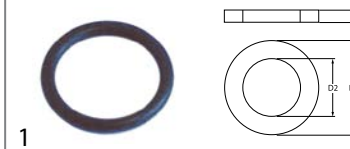

<b>Part No.</b>	507309	<b>Ref. No.</b>	465124
<b>description</b>	O-ring EPDM thickness 2.62mm ID $\varnothing$ 17.13mm Qty 1 pcs		

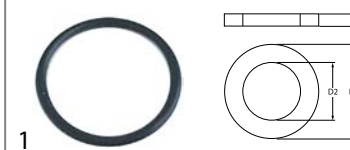

<b>Part No.</b>	502036	<b>Ref. No.</b>	465128
<b>description</b>	O-ring EPDM thickness 2.62mm ID $\varnothing$ 28.25mm Qty 1 pcs		

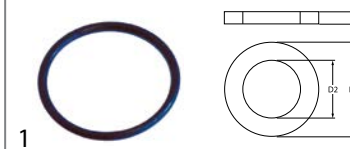

<b>Part No.</b>	507314	<b>Ref. No.</b>	GUAR0513
<b>description</b>	O-ring EPDM thickness 2.62mm ID $\varnothing$ 32.99mm		

accessories for 507314



<b>Part No.</b>	507314	<b>Ref. No.</b>	GUAR0513
<b>description</b>	O-ring EPDM thickness 2.62mm ID $\varnothing$ 32.99mm		



<b>Part No.</b>	511937	<b>Ref. No.</b>	465204
<b>description</b>	O-ring EPDM thickness 3.53mm ID $\varnothing$ 28.17mm Qty 1 pcs		

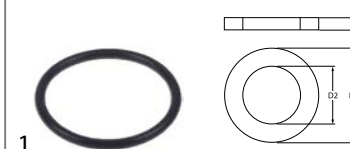

<b>Part No.</b>	519179	<b>Ref. No.</b>	465016
<b>description</b>	O-ring EPDM thickness 3.53mm ID $\varnothing$ 41.28mm Qty 1 pcs		

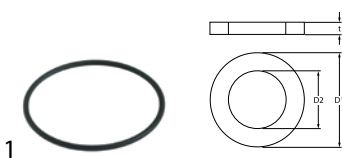



<b>Part No.</b>	504580	<b>Ref. No.</b>	465225
<b>description</b>	O-ring EPDM thickness 3.53mm ID ø 73.03mm Qty 1 pcs		



<b>Part No.</b>	510409	<b>Ref. No.</b>	N/A
<b>description</b>	O-ring EPDM thickness 5.34mm ID ø 56.52mm Qty 1 pcs		

**silicone**



<b>Part No.</b>	532520	<b>Ref. No.</b>	465121
<b>description</b>	O-ring silicone thickness 2.62mm ID ø 15.08mm Qty 1 pcs		

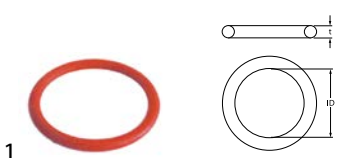

<b>Part No.</b>	532562	<b>Ref. No.</b>	465015
<b>description</b>	O-ring silicone thickness 2.62mm ID ø 20.63mm Qty 1 pcs		

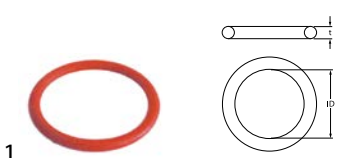

<b>Part No.</b>	532484	<b>Ref. No.</b>	GUAR0501
<b>description</b>	O-ring silicone thickness 2.62mm ID ø 37.77mm Qty 1 pcs		

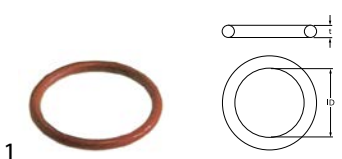

<b>Part No.</b>	532314	<b>Ref. No.</b>	GUAR0506
<b>description</b>	O-ring silicone thickness 3.53mm ID ø 29.75mm Qty 10 pcs		

**Viton**



<b>Part No.</b>	528687	<b>Ref. No.</b>	465014
<b>description</b>	O-ring Viton thickness 1.78mm ID ø 3.69mm Qty 1 pcs		

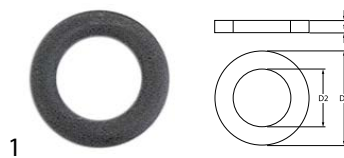

<b>Part No.</b>	101527	<b>Ref. No.</b>	465017
<b>description</b>	O-ring Viton thickness 1.78mm ID ø 6.75mm Qty 1 pcs		

**sealing washers**

**rubber gaskets**



<b>Part No.</b>	528494	<b>Ref. No.</b>	362027
<b>description</b>	gasket rubber ED ø 13mm ID ø 4mm thickness 4mm Qty 1 pcs		



<b>Part No.</b>	528495	<b>Ref. No.</b>	362028
<b>description</b>	gasket rubber ED ø 16mm ID ø 8mm thickness 4mm Qty 1 pcs		

**PTFE gaskets**



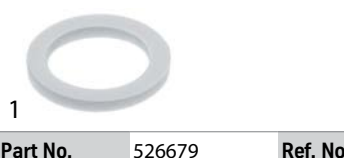

<b>Part No.</b>	525743	<b>Ref. No.</b>	362058
<b>description</b>	flat gasket PTFE ED ø 16.5mm ID ø 13mm thickness 2mm Qty 1 pcs		





<b>Part No.</b>	526679	<b>Ref. No.</b>	362012
<b>description</b>	flat gasket PTFE ED ø 18mm ID ø 13mm thickness 2mm Qty 1 pcs		



			
1			
<b>Part No.</b>	525745	<b>Ref. No.</b>	362069
<b>description</b>	flat gasket PTFE ED ø 26mm ID ø 22.5mm thickness 1mm Qty 1 pcs		

			
1			
<b>Part No.</b>	526014	<b>Ref. No.</b>	362026
<b>description</b>	flat gasket PTFE ED ø 35mm ID ø 30mm thickness 2mm Qty 1 pcs		

			
1			
<b>Part No.</b>	528524	<b>Ref. No.</b>	N/A
<b>description</b>	flat gasket PTFE ED ø 36.5mm ID ø 30.5mm thickness 2mm Qty 1 pcs		

			
1			
<b>Part No.</b>	525742	<b>Ref. No.</b>	362077
<b>description</b>	flat gasket PTFE ED ø 9.8mm ID ø 6.1mm thickness 1mm Qty 1 pcs		

## special gaskets

### group gaskets

			
1			
<b>Part No.</b>	525726	<b>Ref. No.</b>	361012
<b>description</b>	group gasket L 71.5mm W 70.5mm thickness 2mm aperture 56x26mm hole distance 57mm suitable for PAVONI		

			
1			
<b>Part No.</b>	528943	<b>Ref. No.</b>	N/A
<b>description</b>	group gasket L 77mm W 74mm thickness 2mm aperture 27x66mm hole distance 56mm fibre		

			
1			
<b>Part No.</b>	528164	<b>Ref. No.</b>	361016
<b>description</b>	group gasket L 72mm W 60mm thickness 1mm hole distance 55mm fibre suitable for PAVONI		

			
1			
<b>Part No.</b>	528141	<b>Ref. No.</b>	N/A
<b>description</b>	group gasket L 81mm W 55mm thickness 2mm hole distance 60mm equiv. no. 00814 suitable for BRASILIA, PAVONI		

			
1			
<b>Part No.</b>	528844	<b>Ref. No.</b>	N/A
<b>description</b>	group gasket thickness 1.5mm hole distance 56mm suitable for PAVONI PTFE		

			
1			
<b>Part No.</b>	528842	<b>Ref. No.</b>	N/A
<b>description</b>	group gasket L 71mm W 71mm thickness 2mm suitable for PAVONI hole distance 50mm		

## springs

### torsion springs

			
1			
<b>Part No.</b>		<b>Ref. No.</b>	IS000804
<b>description</b>	spring		

### compression springs

			
1			
<b>Part No.</b>	529737	<b>Ref. No.</b>	311409
<b>description</b>	compression spring ø 12mm L 22mm wire gauge ø 1.6mm		

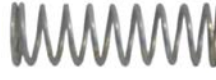
			
1			
<b>Part No.</b>	528835	<b>Ref. No.</b>	311405
<b>description</b>	compression spring ø 13.9mm L 45mm wire gauge ø 1.6mm		



			
1			
<b>Part No.</b>	527934	<b>Ref. No.</b>	311419
<b>description</b>	compression spring ø 14.2mm L 45mm wire gauge ø 1.5mm SS		

			
1			
<b>Part No.</b>	526561	<b>Ref. No.</b>	311421
<b>description</b>	compression spring ø 14.3mm L 21mm wire gauge ø 1.8mm		

			
1			
<b>Part No.</b>	526685	<b>Ref. No.</b>	311416
<b>description</b>	compression spring ø 14.3mm L 30.5mm wire gauge ø 1.8mm		

			
1			
<b>Part No.</b>	528475	<b>Ref. No.</b>	311420
<b>description</b>	compression spring ø 14.7mm L 33mm wire gauge ø 2mm		

## coffee accessories

### coffee grounds drawers

			
1			
<b>Part No.</b>	525281	<b>Ref. No.</b>	IS100014 KNB
<b>description</b>	coffee grounds drawer W 205mm D 308mm H 70mm		

## milk foamers

### milk foamers

			
1			
<b>Part No.</b>	525629	<b>Ref. No.</b>	2937002 393750R
<b>description</b>	milk foamer connection 6mm plastic		

## manometers

			
1			
<b>Part No.</b>	541233	<b>Ref. No.</b>	N/A
<b>description</b>	manometer double scale ø 60mm pressure range 0-2.5 / 0-15bar connection on the backside thread 1/8"		

			
1			
<b>Part No.</b>	541287	<b>Ref. No.</b>	N/A
<b>description</b>	manometer double scale ø 60mm pressure range 0-2.5 / 0-15bar connection on the backside thread 1/8"		

			
1			
<b>Part No.</b>	541222	<b>Ref. No.</b>	N/A
<b>description</b>	manometer double scale ø 60mm pressure range 0-2.5 / 0-16bar connection on the backside thread 1/8"		

			
1			
<b>Part No.</b>	541226	<b>Ref. No.</b>	N/A
<b>description</b>	manometer double scale ø 60mm pressure range 0-2.5 / 0-16bar connection on the backside thread 1/8"		



			
1			
<b>Part No.</b>	541288	<b>Ref. No.</b>	453006 453007
<b>description</b>	manometer double scale Ø 63mm pressure range 0-2.5 / 0-15bar connection on the backside thread 1/8"		

			
1			
<b>Part No.</b>	541511	<b>Ref. No.</b>	N/A
<b>description</b>	manometer Ø 41mm pressure range 0 up to 2.5bar thread 1/8" marking 1.1		

			
1			
<b>Part No.</b>	541748	<b>Ref. No.</b>	453040
<b>description</b>	manometer Ø 44mm pressure range 2.5bar connection 1/8" coffee machine parts		

			
1			
<b>Part No.</b>	541286	<b>Ref. No.</b>	453004
<b>description</b>	manometer Ø 60mm pressure range 0 up to 3bar thread 1/8" marking 1.5 connection on the backside		

			
1			
<b>Part No.</b>	541744	<b>Ref. No.</b>	453008
<b>description</b>	manometer pressure range 0-2.5bar Ø 52mm connection 1/8" capillary pipe 600mm		

## dosing pumps

### accessories

#### non-return valves

			
1			
<b>Part No.</b>	361488	<b>Ref. No.</b>	RACA0006
<b>description</b>	non-return valve inlet 4x6mm outlet 1/8" L 40mm Qty 1 pcs		

## fastening material

### screws

#### countersunk screws

			
1			
<b>Part No.</b>	560370	<b>Ref. No.</b>	312317
<b>description</b>	countersunk screw thread M5 L 16mm stainless steel DIN 965/ISO 7046 Qty 1 pcs intake Phillips head Ø 9mm		

#### cylinder head bolts

##### DIN 912/ISO 4762

			
1			
<b>Part No.</b>	560373	<b>Ref. No.</b>	403203
<b>description</b>	cylinder head bolt thread M4 thread L 12mm WS 3 SS Qty 1 pcs intake internal hexagon DIN 912/ISO 4762		

#### threaded rods

##### miscellaneous

			
1			
<b>Part No.</b>	525640	<b>Ref. No.</b>	3123547
<b>description</b>	threaded rod L 45mm SS M12x1.75		

			
1			
<b>Part No.</b>	525721	<b>Ref. No.</b>	404013
<b>description</b>	threaded rod thread M8 L 22mm intake slotted		



nuts

cap nuts

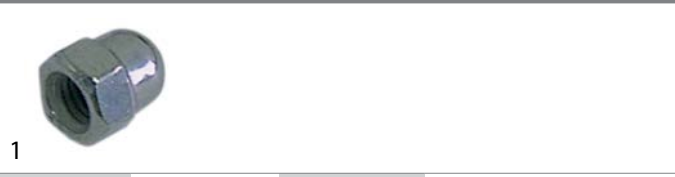

<b>Part No.</b>	560137	<b>Ref. No.</b>	402018
<b>description</b>	cap nuts thread M6 WS 10 SS Qty 20 pcs DIN/ISO DIN 1587		

fasteners

retainer clips



<b>Part No.</b>	525732	<b>Ref. No.</b>	311429
<b>description</b>	retainer clip L 14mm wire gauge ø 1.5mm SS Qty 1 pcs		

**GASTRO**PARTS.COM

