



GASTROPARTS

Öztiryakiler

- [EN]** Equipment
- [DE]** Geräte
- [ES]** Aparatos
- [FR]** Équipement
- [IT]** Attrezzature
- [PL]** Urządzenia
- [RU]** Оборудование

✉ gastroparts@gastroparts.com

☎ tel. +48 56 657 00 66

📘 fb.com/gastroparts.global

GASTROPARTS.COM





heating elements

heating elements for fryers

8 hole fixing

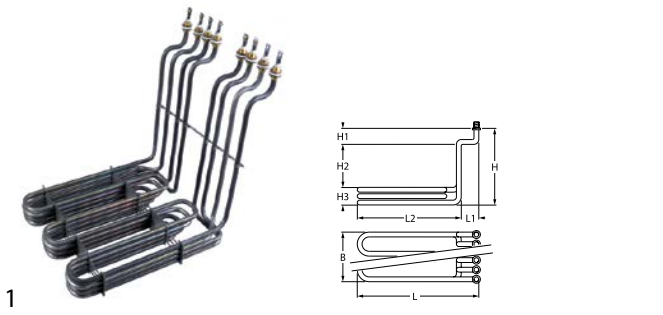

Part No.	418859	Ref. No.	6246.00045.00 6246.00045.05 6246.00047.00
description	heating element 4x4500W 440V L 350mm W 255mm H 325mm 8 hole fixing connection M4 L1 50mm L2 300mm H1 40mm H2 235mm H3 45mm heating circuits 4 immersion heater tube ø 8.5mm fryer		

heating elements for griddles



Part No.	417624	Ref. No.	6246.00011.03
description	heating element 1500W 230V heating circuits 1 L 430mm W 100mm H 65mm tube ø 8.5mm		

heating elements for contact grills

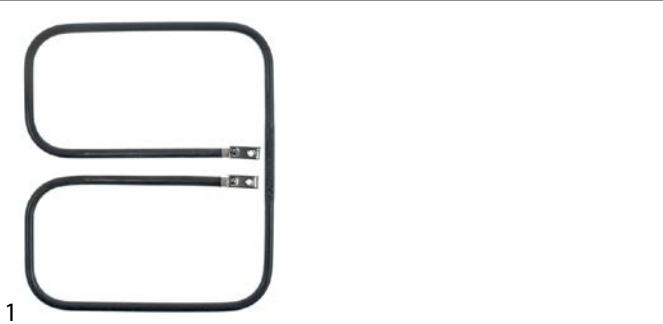

Part No.	420474	Ref. No.	6246.00035.00
description	heating element 750W 230V heating circuits 1 L 165mm W 195mm H 30mm connection distance 20mm tube ø 6.5mm windings 1 connection M4 dry heating element for contact grill/waffle iron		

immersion heating elements

3 hole flange ø47.5mm

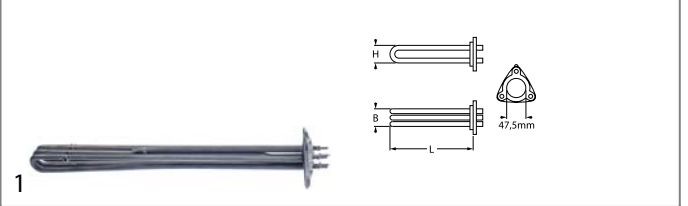

Part No.	417529	Ref. No.	6246.00001.03 6246.00006.00 6246.00006.03 9099.01000.06	
description	heating element 9000W 230V mounting ø 47.5mm heating circuits 3 L 440mm W 36mm H 31mm number of thermostat sleeves 1 thermostat sleeves ø 7mm length thermostat sleeves 255mm thermostat sleeve eccentric, clinging tube ø 8.5mm hole distance 61mm hole ø 10mm connection M4 3 hole flange immersion heater			
For models:	OBK1500			
accessories for	417529			
	Part No.	510408	Ref. No.	6228.00001.22 6228.00001.26
	O-ring EPDM thickness 5.34mm ID ø 47mm Qty 1 pcs			

with expansion flange 70 x 18mm



Part No.	420366	Ref. No.	9099.01000.03
description	heating element 2000/2500W 230V heating circuits 2 flange 70x18mm L 418mm W 64mm connection M4 tube ø 8.5mm immersion heater expansion flange		



Part No.	417717	Ref. No.	6246.00012.12 9099.01000.01
description	heating element 2950W 230V heating circuits 1 flange 70x18mm L 285mm W 70mm connection male faston 6.3mm tube ø 8.5mm immersion heater expansion flange		

heating elements for convection



Part No.	417622	Ref. No.	6246.00020.00
description	heating element 1500W 220V heating circuits 1 ID ø 198mm ED ø 210mm L 225mm H 35mm L1 8mm W1 30mm H1 13mm H2 20mm flange length 70mm flange width 22mm hole distance 56mm connection M4 tube ø 6.5mm convection heating element rectangular flange		



1

Part No.	420544	Ref. No.	6246.00049.05 7AYS.00008.17 7AYS.00008.18
description	heating element 1500W 230V heating circuits 1 ID ø 195mm ED ø 208mm L 210mm H 30mm W1 30mm H1 10mm H2 18mm flange length 70mm flange width 22mm hole distance 56mm connection F6.3 connection length 20mm tube ø 6.5mm		

radiation heaters



1

Part No.	417647	Ref. No.	2859.M0012.00 6802.00001.110 6802.00001.114
description	radiation heater rectangular L 230mm W 158mm H 50mm heating circuits 1		

foil heating elements



1

Part No.	416371	Ref. No.	62460000806 7AYS0000902
description	foil heating element L 400mm W 290mm 1000W 230V t.max. 140°C with temperature limiter silicone cable length 2000mm thickness 1mm		

accessories

sealing washers

O-rings

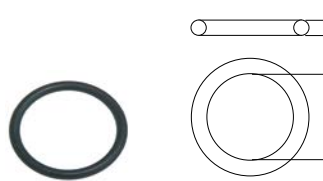

1

Part No.	510408	Ref. No.	6228.00001.22 6228.00001.26
description	O-ring EPDM thickness 5.34mm ID ø 47mm Qty 1 pcs		

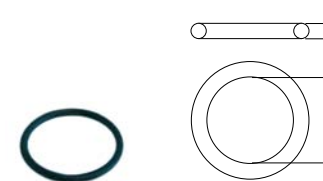

1

Part No.	510409	Ref. No.	6228.00002.14
description	O-ring EPDM thickness 5.34mm ID ø 56.52mm Qty 1 pcs		

hot plates

round

with radiused edge

for domestic and commercial kitchens



1

Part No.	490021	Ref. No.	6246.00013.02
description	hot plate ø 220mm 2600W 400V connection 4 screw clamps with 8mm spill ring		

energy regulators

EGO

1-circuit



1

Part No.	380019	Ref. No.	6234.00001.11
description	energy regulator 240V 13A single-circuit turn direction right shaft ø 6x4.6mm shaft L 23mm mounting thread M4 power release 6-100% no. 50.57071.010		



thermostats

control and safety thermostats

EGO

control thermostats

55.34_ series



Part No.	390979	Ref. No.	6234.00001.37
description	thermostat t.max. 129°C temperature range 34-129°C 3-pole 3NO 16A probe ø 6mm probe L 140mm capillary pipe 2260mm capillary pipe isolated 120mm gland nut shaft ø 6x4.6mm shaft L 23mm shaft position upper rotation 270° outer switch probe material SS probe thread screw connection disc ømm		

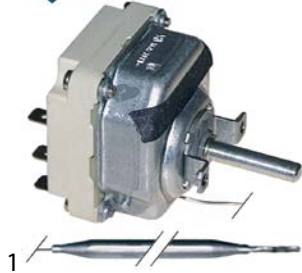

Part No.	375038	Ref. No.	6234.00001.14
description	thermostat t.max. 300°C temperature range 50-300°C 3-pole 3NO 16A probe ø 6mm probe L 79mm capillary pipe 1740mm capillary pipe isolated 800mm gland nut shaft ø 6x4.6mm shaft L 23mm shaft position upper rotation 270°		
accessories for	375038		
	Part No.	110123	Ref. No. —
	knob thermostat t.max. 300°C ø 50mm shaft ø 6x4.6mm shaft flat upper black temperature range 50-300°C rotation 270°		

safety thermostats

55.32_ series



Part No.	390141	Ref. No.	6234.00001.28
description	safety thermostat switch-off temp. 350°C 3-pole 3NC 20A probe ø 6mm probe L 77mm capillary pipe 1490mm capillary pipe isolated 800mm gland nut probe SS		

56_ series



Part No.	390714	Ref. No.	6234.00001.16 6234.00001.27
description	safety thermostat switch-off temp. 230°C 1-pole 1NC 16A probe ø 6mm probe L 75mm capillary pipe 740mm capillary pipe isolated 200mm gland nut probe SS		



Part No.	375973	Ref. No.	6234.00001.26
description	safety thermostat switch-off temp. 365°C 1-pole 20A probe ø 3.1mm probe L 160mm capillary pipe 910mm capillary pipe isolatedmm gland nut probe SS		



TECASA

control thermostats

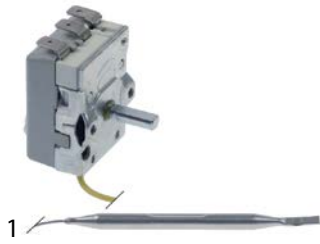

Part No.	390927	Ref. No.	6234.00001.080
description	thermostat t.max. 110°C temperature range 30-110°C 1-pole 1CO 16A probe ø 6mm probe L 91mm capillary pipe 880mm capillary pipe isolated 850mm gland nut shaft ø 6x4.6mm shaft L 18mm shaft position upper rotation 270° 400V		
For models:	OBK1500		



Part No.	375472	Ref. No.	6234.00001.17 6234.00001.40
description	thermostat t.max. 190°C temperature range 60-180°C 1-pole 1NO 16A probe ø 6mm probe L 70mm capillary pipe 2000mm capillary pipe isolated 490mm gland nut shaft ø 6x4.6mm shaft L 23mm shaft position lower° rotation 270° probe material SS		

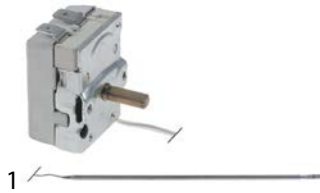

Part No.	375909	Ref. No.	6234.00001.05
description	thermostat t.max. 300°C temperature range 50-300°C 1-pole 1NO 16A probe ø 3mm probe L 165mm capillary pipe 870mm capillary pipe isolatedmm gland nut shaft ø 6x4.6mm shaft L 23mm shaft position upper rotation 270°		

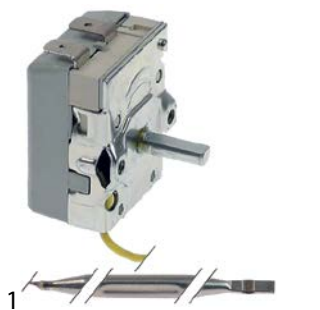

Part No.	390980	Ref. No.	6234.00001.18 6234.00001.42
description	thermostat t.max. 90°C temperature range 30-90°C 1-pole 1NO 16A probe ø 6mm probe L 95mm capillary pipe 1550mm capillary pipe isolated 1500mm gland nut shaft ø 6x4.6mm shaft L 16mm shaft position° shaft position upper rotation 270° outer switch probe material SS probe thread disc ømm screw connection		

safety thermostats



Part No.	390796	Ref. No.	6234.00001.04 6234.00001.21
description	safety thermostat switch-off temp. 150°C 1-pole 1NC 16A probe ø 6mm probe L 65mm capillary pipe 1480mm capillary pipe isolated 1450mm		
For models:	OBK1500		



Part No.	376000	Ref. No.	6234.00001.41
description	safety thermostat switch-off temp. 230°C 1-pole 1NO 16A probe ø 6mm probe L 58mm capillary pipe 2000mm capillary pipe isolated 490mm gland nut probe SS		

various

control thermostats



Part No.	390744	Ref. No.	6234.00001.34 6234.00001.40
description	thermostat t.max. 190°C temperature range 60-190°C 1-pole 1NO probe ø 6mm probe L 69mm capillary pipe 2040mm shaft ø 6x4.6mm shaft L 26mm shaft position upper rotation 270° probe material SS		

refrigeration thermostats

RANCO

K50 series



Part No.	390546	Ref. No.	6268.00013.01 7AYS0000228
description	thermostat RANCO type K50P1127 probe ømm probe Lmm capillary pipe 1200mm temperature range +1.5 up to +12.5°C		



switches and momentary switches

rocker/momentary rocker switches

30x22mm



1

Part No.	301003	Ref. No.	62320001900
description	rocker switch mounting measurements 30x22mm green 2NO 250V 16A illuminated 0-1 connection male faston 6.3mm ambient temperature max. 125/55°C protection IP65		
accessories for	301003		
	Part No.	301036	Ref. No. —
	protective cover internal size 30x22mm for rocker switch mounting measurementsmm		



1

Part No.	301251	Ref. No.	6232.00001.21 7AYS0000136
description	rocker switch mounting measurements 30x22mm green 2NO 250V 16A illuminated lighting connection male faston 6.3mm ambient temperature max. 85°C protection IP40		

ø20mm



1

Part No.	348204	Ref. No.	6232.00011.01 6232.00011.27
description	rocker switch mounting measurements 20mm green 1CO 250V 4A 0-1		



1

Part No.	348203	Ref. No.	6232.00011.00 6232.00011.28
description	rocker switch mounting measurements 20mm orange 1CO 250V 4A 0-1		

toggle switches

M12x1



1

Part No.	347340	Ref. No.	6232.00020.01
description	toggle switch thread M12x1 1NO 250V 15A ON-OFF screw		

position switches

PIZZATO

FR series



1

Part No.	345181	Ref. No.	6232.00010.33
description	position switch plastic 1NC/1NO 400V 3A L 92mm W 31mm H 31mm protection IP67 actuating force: 450g screw connection PG13.5 mounting distance 22mm screw		

miscellaneous



1



Part No.	347962	Ref. No.	6232.00006.00
description	position switch 1NO/1NC L 68mm W 30mm H 24mm		
For models:	OM10G, OM20G, OM40G, OM60G, PSM10, PSM20, PSM30		

cam switches

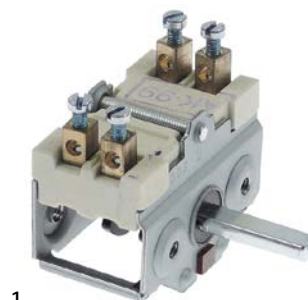
on/off



1

Part No.	300020	Ref. No.	6254.00005.03
description	cam switch 4 operating positions 2NO sequence 0-1-0-1 16A shaft ø 6x4.6mm shaft L 23mm connection screw ceramic		
accessories for	300020		
	Part No.	110135	Ref. No. —
	rosette knob up to ø 52mm		
	Part No.	110231	Ref. No. —
	knob switch 0-1-0-1 t.max.°C ø 50mm shaft ø 6x4.6mm shaft flat upper black		



7-position



1

Part No.	300106	Ref. No.	6254.00005.00
description	cam switch 7 operating positions 1NO/2CO sequence 0-1-2-3-4-5-6 32A shaft ø 6x4.6mm shaft L 23mm connection screw 7-position shaft flat upper		

operation switches



1

Part No.	300002	Ref. No.	6254.00005.04
description	cam switch 2 operating positions 4NO 16A sequence 0-1 shaft ø 6x4.6mm shaft L 23mm connection male faston 6.3mm ceramic		

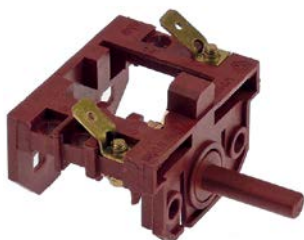

1

Part No.	300257	Ref. No.	6232.00024.10
description	operation switch 16A sequence 0-1 shaft ø 6x4.6mm shaft L 22mm connection male faston 6.3mm		

magnetic switches

miscellaneous



1

Part No.	347961	Ref. No.	6232.00005.10
description	magnetic switch 250V 3A P max. 750W 1NO connection cable L 12mm cable length 1000mm L1 37mm mounting measurements 58x13mm H 9mm mounting distance 49.5mm voltage AC nominal 5A		
For models:	OBK1500		
accessories for	347961		



Part No.	699294	Ref. No.	
magnet ø 20.8mm H 12.5mm ID ø 5mm with screw			

accessories

magnets



1

Part No.	699294	Ref. No.	621300002.03+626200004.01 6232.00004.17 siehe bemerkung
description	magnet ø 20.8mm H 12.5mm ID ø 5mm with screw		
For models:	OBK1500		

control equipment

MOELLER/EATON

push buttons - signal lamps



1

Part No.	346272	Ref. No.	6232.00012.08
description	push button mounting measurements ø22mm green		

switch blocks



1

Part No.	346292	Ref. No.	6232.00012.05
description	contact block screw 1NO		



1

Part No.	346293	Ref. No.	6232.00012.07
description	contact block holder triple		

LED signal elements





1

Part No.	348202	Ref. No.	6232.00012.04
description	indicator lamp yellow connection screw LED 85-264VAC		



miscellaneous

			
1			
Part No.	347964	Ref. No.	6232.00003.02
description	momentary push switch mounting measurements ø22mm green 1NO 10A 1-pole SMCX		
For models:	OM10G, OM20G, OM40G, OM60G, PSM10, PSM20, PSM30		

			
1			
Part No.	347963	Ref. No.	6232.00003.05 6232.00003.06
description	momentary push switch mounting measurements ø22mm red 1NC 10A 1-pole SMCX		
For models:	OM10G, OM20G, OM40G, OM60G, PSM10, PSM20, PSM30		

encoders and potentiometers

			
1			
Part No.	403313	Ref. No.	6229.00034.09
description	potentiometer 2.5KOhm cable length 130mm L 44mm ø 22.5mm		
For models:	OM10G		

lamps

indicator lights

indicator lights (complete)

ø10mm

with screw socket

			
1			
Part No.	360649	Ref. No.	6251.00004.10
description	indicator light ø 10mm green 240V cable length 300mm		

			
1			
Part No.	360652	Ref. No.	6251.00004.07
description	indicator light ø 10mm red 240V connection cable 300mm cable length 300mm		

30x22mm			
			
1			
Part No.	359302	Ref. No.	6232.00001.22 7AYS0000226
description	indicator light mounting measurements 30x22mm yellow 240V temp.-resist. 120°C		

fluorescent lamps

fluorescent lamps



complete with holder

			
1			
Part No.	359481	Ref. No.	6250.00001.35 7AYS0000232
description	fluorescent lamp L 1204mm 28W 230V		

oven lamps

universal oven lamps

mounting diameter 35.5mm

			
1			
Part No.	359718	Ref. No.	62600016006
description	oven lamp mounting ø 35.5mm 230V 15W socket E14 temp.-resist. 300°C connection male faston 6.3mm hard glas		
spare parts for	359718		
	Part No.	359701	Ref. No.
			—
		lamp socket socket E14 220-230V mounting ø 35.5mm connection male faston 6.3mm 15W	
	Part No.	359740	Ref. No.
			—
		light bulb t.max. 300°C socket E14 15W 230V ø 22mm L 48mm lens L 20mm for oven lamp IMPORT	

timers

mechanical timers

			
1			
Part No.	350204 ¹	Ref. No.	6259.00002.00
description	timer 600 2-pole operation time 4min impulse mechanical 2NO at 250V 16A permanent position no shaft ø 6x4.6mm shaft 6x4.6mm shaft L 21mm mounting distance 28mm connection male faston 6.3mm		
For models:	PSM10, PSM20, PSM30		

¹incl. knob and symbol



			
1			
Part No.	350205	Ref. No.	6259.00002.05
description	timer M11 with bell 1-pole operation time 90min impulse mechanical 1NO at 250V 16A permanent position yes shaft \varnothing 6x4.6mm shaft 6x4.6mm shaft L 25mm mounting distance 28mm mounting thread M4 connection male faston 6.3mm		
For models:	OM20G, OM40G, OM60G		

contactors

LS Industrial Systems

power contactors

			
1			
Part No.	380877	Ref. No.	6230.00014.06
description	power contactor resistive load 60A 230VAC (AC3/400V) 40A/18.5kW main contacts 3NO auxiliary contacts 2NO/2NC connection screw connection type GMC-40		

overload switches

			
1			
Part No.	381200	Ref. No.	6231.00001.00
description	motor protection circuit breaker setting range 1.6-2.5A type GTK-12M LS Industrial Systems		
For models:	PSM10		

MOELLER/EATON

power contactors



			
1			
Part No.	380171	Ref. No.	6230.00014.12
description	power contactor resistive load 20A 230VAC (AC3/400V) 9A/4kW main contacts 3NO auxiliary contacts 1NO connection screw connection type DILEM 10		

relays



power relays

with male contacts

bullet connectors, 11 contacts

			
1			
Part No.	380132	Ref. No.	6231.00023.12
description	power relays Italiana Relè 230VAC 10A 3CO connection plug-in connection round 11-pole manif. no. C43-230AC ZVE11 250V 11-pole		
For models:	OBK1500		
accessories for	380132		
	Part No.	380136	Ref. No. —
	relay socket 11-pole connection plug-in connection round 11-pole dimensions 65x28x40mm 250V voltage AC 10A Italiana Relè manif. no. ZVE11		

plug-in/print relays

			
1			
Part No.	380333	Ref. No.	6231.00020.02 6231.00023.15 6231.00025.07
description	print relay 230VAC 2CO at 250V 8A connection pins raster size 5mm FINDER manif. no. 40.52.8.230.0000 95.65/95.75		
For models:	OBK1500		
accessories for	380333		
	Part No.	380340	Ref. No. —
	relay socket dimensions 62x36x15mm 250V voltage AC 10A Italiana Relè manif. no. ZMEM/5		

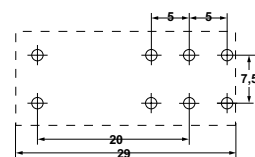





Table continues overleaf



accessories for 380333			
	Part No.	380505	Ref. No. —
	relay socket 2CO 40.52 dimensions 81.9x15.5x75mm 250V voltage AC 10A FINDER manuf. no. 95.95.3		
	Part No.	381181	Ref. No. —
	relay socket 2-pole 40.51/40.52/40.61 connection screw clamp dimensions 15.8x78.6mm 250V voltage AC 10A FINDER manuf. no. 95.75		

time relays

time relays

			
1			
Part No.	381201	Ref. No.	6231.00019.07
description	time relay INTER RR-W03D time range 0.1-3min 12/24VAC/DC-230VAC 5A connection screw clamp mounting measurements DIN railmm		
For models:	OBK1500		



			
1			
Part No.	381541	Ref. No.	6231.00019.05 6231.00019.22 RR-5T RR-W5TB
description	time relay INTER RR-W5TB connection grip connection		







electronic controllers

DIXELL

refrigeration controllers

built-in version

			
1			
Part No.	378256	Ref. No.	6234.00009.18 7AYS0000700
description	electronic controller DIXELL XR02CX-5N0C0 mounting measurements 71x29mm built-in depth 56mm 230V voltage AC NTC relay outputs 1 CO-8A(4) NTC protection IP54 defrosting function/time control -40 up to +110°C display 2½ digit		
spare parts for	378256		
	Part No.	379161	Ref. No. —
	temperature probe NTC 10kOhm cable thermoplastic probe -40 up to +110°C cable -40 up to +110°C probe ø6x14mm cable length 3m without screw connection 2-wire		

accessories for 378256			
	Part No.	378194	Ref. No. —
	temperature probe NTC 10kOhm cable PVC probe -20 up to +80°C cable -10 up to 100°C probe ø7x24.5mm cable length 1.5m without screw connection 2-wire		
	Part No.	379057	Ref. No. —
	temperature probe NTC 10kOhm cable PVC probe -20 up to +80°C cable -10 up to 100°C probe ø6x25mm cable length 3m 2-wire		
	Part No.	379160	Ref. No. 6234.00004.06
	temperature probe NTC 10kOhm cable thermoplastic probe -40 up to +110°C cable -40 up to +110°C probe ø6x14mm cable length 1.5m without screw connection 2-wire		
	Part No.	379161	Ref. No. —
	temperature probe NTC 10kOhm cable thermoplastic probe -40 up to +110°C cable -40 up to +110°C probe ø6x14mm cable length 3m without screw connection 2-wire		
	Part No.	379343	Ref. No. —
	temperature probe NTC 10kOhm cable silicone probe -40 up to +110°C cable -50 up to +180°C probe ø6x40mm cable length 3m 2-wire		
	Part No.	379458	Ref. No. —
	temperature probe NTC 10kOhm cable silicone probe -40 up to +110°C cable -50 up to +180°C probe ø6x40mm cable length 1.5m without screw connection 2-wire		

electronic thermometers

built-in version

			
1			
Part No.	378257	Ref. No.	6234.00009.19 7AYS0000703
description	thermometer DIXELL XT11S-500 mounting measurements 58x25.5mm 230V voltage AC NTC -40 up to +110°C display 3 digits 1 Templn1 NTC DigiIn1 defr. funct.		



EVCO - EVERY CONTROL

refrigeration controllers

built-in version

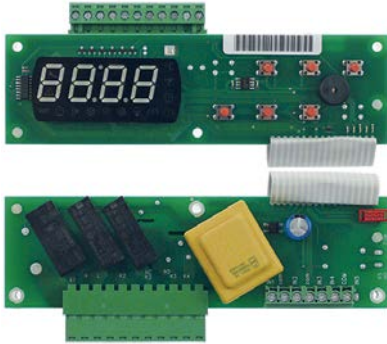

Part No.	381444	Ref. No.	6234.00009.27
description	electronic controller EVCO type EVX003N7XXBXX02 mounting measurements 155x45mm 230V voltage AC NTC relay outputs 4 NO-16A(5) NO-16A NO-16A NTC(PTC) NTC(PTC) for fridge front measurementsmm built-in depth 56mm protection IP00 yes -40 up to +99°C display 4 digits		

probes

universal probes

temperature probes



Part No.	379160	Ref. No.	6234.00004.06
description	temperature probe NTC 10kOhm cable thermoplastic probe -40 up to +110°C cable -40 up to +110°C probe ø6x14mm cable length 1.5m without screw connection 2-wire		
For models:	7919.06LMV.00, 7919.06NMV.00, 7919.12LMV.00, 7919.12NMV.00, 7919.27LMV.00, 7919.27NMV.00, 7919.37LMV.00, 7919.37NMV.00		

producer-specific probes

probes



Part No.	378515	Ref. No.	6234.00005.03
description	temperature probe thermocouple J (Fe-CuNi) cable Vetrotex probe -50 up to +750°C cable -50 up to +350°C connection 2-wire thread M6 probe ø4x65mm cable length 0.97m		

electronics

PCBs



Part No.	404025	Ref. No.	6234.00009.50
description	control PCB freezer V13.06 L 156mm edition WC3LDL0TC1701 H 44mm buttons 6 ELIWELL		
For models:	7919.06LMV.00, 7919.06NMV.00, 7919.27LMV.00, 7919.27NMV.00, 7919.37NMV.00		

keypads

front foils



Part No.	531271	Ref. No.	6800.00001.24
description	keypad foil refrigerator 791912MV/791927 L 170mm W 65mm buttons 6		
For models:	7919.12LMV.00, 7919.12NMV.00, 7919.27LMV.00, 7919.27NMV.00, 7919.37LMV.00, 7919.37NMV.00		

solenoid valves

solenoid valves (water)

ELTEK



Part No.	370750	Ref. No.	6262.00008.00
description	solenoid valve single straight 230VAC inlet 3/4" outlet 11.5mm DN10 t.max. 90°C ELTEK plastic flow regulating valve inlet blue		
For models:	OBK1500		



pressure switches

for warewashing

ø 58mm with coded plug



1

Part No.	542365	Ref. No.	6262.00007.00
description	pressure control pressure range 85/65mbar connection 6mm ø 58mm		

fans

refrigeration fans

refrigeration motors universal

ELCO

N series - standard



1

Part No.	601930	Ref. No.	6268.00008.06
description	fan motor ELCO 10W 230V 50/60Hz bearing slide bearing L1 55.5mm L2 91.5mm L3 119mm W 83mm cable length 2000mm 1300/1550rpm 5 mounting options VN10-20/929		
For models:	7919.06LMV.00, 7919.12LMV.00, 7919.12NMV.00, 7919.27LMV.00, 7919.27NMV.00, 7919.37LMV.00, 7919.37NMV.00		
spare parts for	601930		
	Part No.	601284	Ref. No. —
	fan wheel sucking ø 254mm fan wheel mounting 25.4mm blade angle 28° W 42mm aluminium		

miscellaneous



1

Part No.	602005	Ref. No.	6268.00008.05
description	fan motor 5W 230V 50/60Hz bearing slide bearing L1 40mm L2 59.6mm L3 74.2mm W 83mm connection cable 500mm cable length 500mm 1300/1550rpm 3 mounting options		
For models:	7919.06NMV.00		

hot air motors



1

Part No.	601503	Ref. No.	5FIR.35011.12
description	fan wheel D1 ø 350mm H1 125mm blades 12 D2 ø 13mm D3 ø 16mm		
accessories for	601503		
	Part No.	500505	Ref. No. —
	fan motor 220-240/380-415V 3 phase 50/60Hz 0.16-0.26kW 1440/1700rpm speeds 2 L1 140mm L2 27mm L3 35mm M10R IT 1.2/0.7A Cos(φ) 0.63 type L7zAw4D-014 D1 ø 17mm D2 ø 13mm		

hot air fans

miscellaneous



1

Part No.	602133	Ref. No.	6252.00072.09 7AYS.00008.09
description	fan 220/240V 38W L1 67mm L2 3mm L3 8mm L4 86mm fan wheel ø 85mm ROTTECH type SP-25-AF001 50/60Hz		



1

Part No.	602032	Ref. No.	6252.00072.10
description	fan motor 220-240V 38W 1600rpm L1 72mm L2mm L3mm L4 86mm		



motors

gear motors

for dishwashers



Part No.	601874	Ref. No.	6262.00015.00
description	gear motor AKSAN type AKWDKS 250W 380V voltage AC 50/60Hz 20rpm shaft ø 25mm L 370mm W 140mm H 235mm for dishwasher		
For models:	OBK1500		

pumps

wash and rinse pumps

LGB



Part No.	499132	Ref. No.	9099.ZF121.00
description	pump inlet ø 28mm outlet ø 26mm type ZF121SX 230V 50Hz 1 phase 0.11kW 0.15HP L 195mm rotation direction right capacitor 6.3µF LGB		
spare parts for	499132		
	Part No.	365012	Ref. No. —
	operating capacitor capacity 6.3µF 450V tolerance 5% 50Hz ambient temperature max. -25 to +85°C ø 30mm L 61mm M8 plastic connection male faston 6.3mm protection		
	Part No.	510703	Ref. No. —
	mechanical shaft seal for shaft ø 13mm slide ring H 13mm height counter ring 5.5mm ED ø 26mm		
	Part No.	521057	Ref. No. —
	pump cover LGB inlet ø 28mm outlet ø 26mm auxiliary pressure connection 12mm supporting pressure open turn direction right ø 102mm ID ø 77mm inner height 31mm		
	Part No.	521085	Ref. No. —
	impellor ø 72mm H 17mm thread M7L shaft ø 13mm shaft length 12mm blades 3		
	Part No.	528800	Ref. No. —
	O-ring EPDM thickness 2.62mm ID ø 75.87mm Qty 1 pcs		



Part No.	499306	Ref. No.	9099.ZF650.00
description	pump inlet ø 50mm outlet ø 48mm type ZF650SX 230V 50Hz 1 phase 1.47kW L 340mm rotation direction right LGB		
For models:	OBK1500		
spare parts for	499306		
	Part No.	365019	Ref. No. —
	operating capacitor capacity 20µF 400V tolerance 5% 50/60Hz ambient temperature max. -25 to +85°C ø 39.5mm L 70mm M8 plastic connection male faston 6.3mm 16.10.25. protection		
	Part No.	510551	Ref. No. —
	pump cover gasket ID ø 158.3mm pump type 1214/1293/1225/2243/1226/1204/3473/1241 thickness 3.53mm EPDM Qty 1 pcs		
	Part No.	510694	Ref. No. —
	mechanical shaft seal for shaft ø 13mm height counter ring 8mm ID ø 11.5mm H 16mm mounting ø 24/26mm int. ø 1 14mm		
	Part No.	521108	Ref. No. —
	pump cover LGB inlet ø 50mm outlet ø 50mm auxiliary pressure connection 12mm		
	Part No.	521240	Ref. No. —
	impellor ø 110mm H 32mm rotation direction left thread M8L shaft ø 20mm shaft length 10mm seat ø 8.2mm blades 6		

booster pumps I



Part No.	500540	Ref. No.	6262.00012.01
description	pump inlet ø 1" IT outlet ø 1" IT type PKM60 230V 50Hz 1 phase 0.37kW PEDRELLO 0.5HP		
For models:	OBK1500		
accessories for	500540		
	Part No.	365015	Ref. No. —
	operating capacitor capacity 10µF 400V tolerance 5%Hz ambient temperature max. -25 to +85°C ø 35.5mm L 59mm M8 plastic connection male faston 6.3mm protection		



drain pumps

ASKOLL



1

Part No.	499349	Ref. No.	6262.00016.00
description	drain pump 40W 220-240V inlet ø 30mm outlet ø 24mm 50Hz ASKOLL type M231 XP		



1

Part No.	499315	Ref. No.	6262.00016.00
description	drain pump inlet ø 24/30/35/39mm outlet ø 22/31mm 230V 40W 50Hz ASKOLL type M231 XP kit		





gas taps





PEL

20S series



1

Part No.	101094	Ref. No.	9GEV.10109.40 9PEL.10109.40
description	gas tap PEL type 20S gas inlet M16x1.5 (tube ø 10mm) bypass nozzle ø 0.35mm gas outlet M16x1.5 (tube ø 10/8mm) thermocouple connection M8x1 pilot connection shaft ø 8x6.5mm shaft L 22/15mm shaft flat lower		
spare parts for	101094		
	Part No.	100408	Ref. No. —
	bypass nozzle type PEL20/21 bore ø 0.35mm thread M5x0.5		
	Part No.	101060	Ref. No. —
	magnet unit standard L 39mm D1 ø 15.4mm D2 ø 11mm suitable for PEL20-21/JUNKERS/EGA		
	Part No.	101205	Ref. No. —
	gas tap front part shaft ø 8x6.5mm shaft L 22/15mm shaft flat upper/lower suitable for PEL20		
	Part No.	101230	Ref. No. —
	thermocouple nut T1: M8x1 T2: M18x1 aluminium		
accessories for	101094		
	Part No.	101278	Ref. No. —
	olive for pipe ø 10mm Qty 1 pcs		

accessories for	101094		
	Part No.	101300	Ref. No. —
	union nut thread M16x1.5 tube ø 10mm		
	Part No.	101450	Ref. No. —
	olive for pipe ø 8mm L 12.7mm Qty 1 pcs ED ø 10mm		
	Part No.	101451	Ref. No. —
	union nut thread M16x1.5 tube ø 8mm		
	Part No.	110081	Ref. No. —
	knob ø 70mm shaft ø 8x6.5mm shaft flat universal		
	Part No.	110083	Ref. No. —
	knob dial plate gas tap without ignition flame silver		

21S series







1

Part No.	101095	Ref. No.	9PEL.10109.50
description	gas tap PEL type 21S gas inlet M16x1.5 (tube ø 10mm) bypass nozzle ø 0.35mm gas outlet M16x1.5 (tube ø 10/8mm) thermocouple connection M8x1 pilot connection M10x1 shaft ø 8x6.5mm shaft L 22/15mm shaft flat lower		
spare parts for	101095		
	Part No.	100408	Ref. No. —
	bypass nozzle type PEL20/21 bore ø 0.35mm thread M5x0.5		
	Part No.	101060	Ref. No. —
	magnet unit standard L 39mm D1 ø 15.4mm D2 ø 11mm suitable for PEL20-21/JUNKERS/EGA		
	Part No.	101206	Ref. No. —
	gas tap front part shaft ø 8x6.5mm shaft L 22/15mm shaft flat upper/lower suitable for PEL21		
	Part No.	101230	Ref. No. —
	thermocouple nut T1: M8x1 T2: M18x1 aluminium		
accessories for	101095		
	Part No.	100908	Ref. No. —
	union screw thread M10x1 for pipe ø 4mm Qty 1 pcs		
	Part No.	100909	Ref. No. —
	union screw thread M10x1 for pipe ø 6mm Qty 1 pcs		
	Part No.	101246	Ref. No. —
	olive for pipe ø 4mm Qty 1 pcs		
	Part No.	101278	Ref. No. —
	olive for pipe ø 10mm Qty 1 pcs		
	Part No.	101286	Ref. No. —
	olive ID ø 6mm Qty 1 pcs		

Table continues overleaf



accessories for		101095		
Part No.	101300	Ref. No.	—	
	union nut thread M16x1.5 tube ø 10mm			
Part No.	101450	Ref. No.	—	
	olive for pipe ø 8mm L 12.7mm Qty 1 pcs ED ø 10mm			
Part No.	101451	Ref. No.	—	
	union nut thread M16x1.5 tube ø 8mm			
Part No.	110081	Ref. No.	—	
	knob ø 70mm shaft ø 8x6.5mm shaft flat universal			
Part No.	112206	Ref. No.	—	
	knob dial plate silver gas tap PEL21/22/23 t.max.°C ED ø 63mm ID ø 45.5mm			

AB

gas taps



1

Part No.	107905	Ref. No.	N/A	
description	gas tap AB type A60 gas inlet M16x1.5 (tube ø 10mm) gas outlet M16x1.5 (tube ø 10mm) thermocouple connection M9x1 pilot connection M10x1 front fixing shaft ø 8x6.5mm shaft L 22/15mm shaft flat lower			



1



Part No.	107910	Ref. No.	N/A	
description	gas tap AB type A62 gas inlet M20x1.5 (tube ø 12mm) gas outlet M20x1.5 (tube ø 12/10mm) thermocouple connection M9x1 pilot connection M10x1 front fixing shaft ø 10x8mm shaft L 26/16mm shaft flat lower			

ECA



1

Part No.	109096	Ref. No.	62670000503	
description	gas tap ECA gas inlet pipe flange ø21mm bypass nozzle ø 0.55mm gas outlet 1/4" (tube ø 8mm) thermocouple connection M8x1 shaft ø 8x6.5mm shaft L 19/13mm shaft flat upper front fixing M13x1 mounting thread M5			
spare parts for		109096		
Part No.	101051	Ref. No.	—	
	magnet unit L 27mm D1 ø 12.5mm D2 ø 8.5mm suitable for JUNKERS/EGA/MADEC/SABAF standard			

accessories for		109096		
Part No.	101277	Ref. No.	—	
	olive ID ø 8mm Qty 1 pcs			
Part No.	101351	Ref. No.	—	
	mounting strap for gas tap			
Part No.	520656	Ref. No.	—	
	union nut thread 1/4" tube ø 6/8mm			

gas thermostats

SIT

710 Minisit series



1

Part No.	103262	Ref. No.	9099.07106.53	
description	gas thermostat SIT type MINISIT 710 t.max. 270°C 70-270°C gas inlet 1/2" gas outlet 3/8" thermocouple connection M9x1 pilot connection M10x1 probe ø 5mm probe L 104mm capillary pipe 1050mm probe type type B1 pressure controller no			
accessories for		103262		
Part No.	110068	Ref. No.	—	
	knob suitable for Minisit ø 37mm			

PEL

25ST series



1







Part No.	101172	Ref. No.	90991011720 9PEL.10117.20	
description	gas thermostat PEL type 25ST 100-300°C gas inlet M16x1.5 (tube ø 10mm) bypass nozzle ø 0.35mm gas outlet M16x1.5 (tube ø 10/8mm) thermocouple connection M9x1 pilot connection M10x1 capillary pipe 1200mm probe ø 6mm probe L 100mm shaft ø 8x6.5mm shaft L 21/15mm shaft flat upper			
spare parts for		101172		
Part No.	100259	Ref. No.	—	
	bypass nozzle type PEL22 bore ø 0.35mm thread M6x0.5			
Part No.	101060	Ref. No.	—	
	magnet unit standard L 39mm D1 ø 15.4mm D2 ø 11mm suitable for PEL20-21/JUNKERS/EGA			
Part No.	106200	Ref. No.	—	
	nut thread M9x1 suitable for PEL 24/25S			

Table continues overleaf



accessories for		101172	
	Part No.	100908	Ref. No. —
union screw thread M10x1 for pipe ø 4mm Qty 1 pcs			
	Part No.	100909	Ref. No. —
union screw thread M10x1 for pipe ø 6mm Qty 1 pcs			
	Part No.	101246	Ref. No. —
olive for pipe ø 4mm Qty 1 pcs			
	Part No.	101278	Ref. No. —
olive for pipe ø 10mm Qty 1 pcs			
	Part No.	101286	Ref. No. —
olive ID ø 6mm Qty 1 pcs			
	Part No.	101300	Ref. No. —
union nut thread M16x1.5 tube ø 10mm			
	Part No.	101450	Ref. No. —
olive for pipe ø 8mm L 12.7mm Qty 1 pcs ED ø 10mm			
	Part No.	101451	Ref. No. —
union nut thread M16x1.5 tube ø 8mm			
	Part No.	110079	Ref. No. —
knob dial plate gas thermostat 1-8 silver			
	Part No.	110081	Ref. No. —
knob ø 70mm shaft ø 8x6.5mm shaft flat universal			

COPRECI

			
1			
Part No.	109089	Ref. No.	6267.00005.22
description	gas thermostat E.C.A./COPRECI 100-300°C gas inlet pipe flange ø21mm bypass nozzle ø 0.45mm gas outlet M14x1.5 pilot connection thermocouple connection M8x1 capillary pipe 840mm probe ø 4.5mm probe L 92mm shaft ø 6x4.6mm shaft L 27/14mm shaft flat lower		
spare parts for	109089		
	Part No.	101060	Ref. No. —
magnet unit standard L 39mm D1 ø 15.4mm D2 ø 11mm suitable for PEL20-21/JUNKERS/EGA			
	Part No.	101537	Ref. No. —
gasket ID ø 8mm ED ø 11.5mm H 3mm Qty 1 pcs			
accessories for	109089		
	Part No.	101538	Ref. No. —
clamp			



gas valves and ignition boxes

gas control valves

HONEYWELL

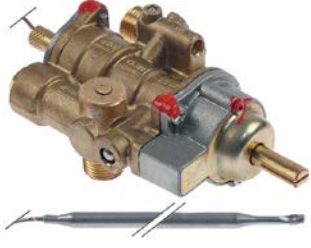
AB

			
1			
Part No.	107915	Ref. No.	03A00033 N/A
description	gas thermostat AB type A65T 100-300°C gas inlet M16x1.5 (tube ø 10mm) gas outlet M16x1.5 (tube ø 10/8mm) thermocouple connection M9x1 pilot connection M10x1 capillary pipe 36" - 915mm probe ø 5.3mm probe L 138mm shaft ø 8x6.15mm shaft L 26/15mm shaft flat lower		

			
1			
Part No.	106004	Ref. No.	6267.00005.30
description	gas valve type VK4105C 220-240V 50/60Hz gas inlet flange 32x32mm gas outlet flange 32x32mm thermocouple connection pilot connection pressure range 15-60mbar max 60mbar operator type pressure controller type V5306E 1234 1 suitable for HONEYWELL flange 32x32mm		
accessories for	106004		
	Part No.	102845	Ref. No. —
gas connection angled 1/2" flange 32x32mm hole distance 24x24mm Tandem			
	Part No.	102846	Ref. No. —
gas connection straight 1/2" flange 32x32mm hole distance 24x24mm suitable for Tandem			



ignition boxes

HONEYWELL

Honeywell



1

Part No.	102343	Ref. No.	6259.00020.061
description	ignition box HONEYWELL type S4565A 2019 1 electrodes 2 waiting times safety time 10s 220-240V 4VA 50/60Hz		

ignition parts







pilot burners

SIT

100 series



1

Part No.	106907	Ref. No.	6267.00023.07
description	pilot burner SIT type 100 series 3 flames nozzle \varnothing 0.35mm gas connection 6mm		
spare parts for	106907		
	Part No.	100246	Ref. No. —
	pilot burner nozzle natural gas bore \varnothing 0.35mm Qty 1 pcs thread M8x0.75		
	Part No.	100855	Ref. No. —
	pilot burner bracket triple		
	Part No.	100885	Ref. No. —
	air mixing sleeve for pilot burner Qty 1 pcs		
	Part No.	100916	Ref. No. —
	compression spring for pilot burner Qty 1 pcs		
	Part No.	100917	Ref. No. —
	gasket for pilot burner Qty 1 pcs aluminium		
	Part No.	100918	Ref. No. —
	screw for pilot burner		
	Part No.	107162	Ref. No. —
	pilot burner cap SIT 3 flames Hmm Lmm Qty 1 pcs		
	Part No.	107702	Ref. No. —
	pilot burner bottom part SIT 100 series nozzle \varnothing 0.35mm		

accessories for	106907		
	Part No.	100245	Ref. No. —
	pilot burner nozzle LPG code 20 bore \varnothing 0.2mm Qty 1 pcs thread M8x0.75		
	Part No.	100904	Ref. No. —
	locking screw M10x1 for pipe \varnothing 4mm Qty 1 pcs		
	Part No.	100905	Ref. No. —
	locking screw M10x1 for pipe \varnothing 6mm Qty 1 pcs		
	Part No.	102110	Ref. No. —
	pilot tube copper pipe \varnothing 4mm thickness 1mm L 3000mm		
	Part No.	102111	Ref. No. —
	pilot tube copper pipe \varnothing 6mm thickness 1mm L 3000mm		
	Part No.	107171	Ref. No. —
	pilot burner nozzle SIT natural/liquid gas bore \varnothing 0.25mm Qty 1 pcs		
	Part No.	107700	Ref. No. —
	pilot burner bottom part SIT 100 series nozzle \varnothing 0.25mm		
	Part No.	107701	Ref. No. —
	pilot burner bottom part SIT 100 series nozzle \varnothing 0.2mm		

ERTA



1









Part No.	102975	Ref. No.	6267.00023.03
description	pilot burner 2 flames natural gas code 14 gas connection 6mm right		
spare parts for	102975		
	Part No.	100234	Ref. No. —
	pilot burner nozzle natural gas gas pressure 20mbar code 14 Qty 1 pcs suitable for JUNKERS CB5050_		
	Part No.	100701	Ref. No. —
	ignition electrode connection M4 Qty 1 pcs		
	Part No.	100906	Ref. No. —
	screw connection thread M10x1 for ignition electrode brass Qty 1 pcs WS 10		
	Part No.	100909	Ref. No. —
	union screw thread M10x1 for pipe \varnothing 6mm Qty 1 pcs		
	Part No.	101288	Ref. No. —
	olive for pipe \varnothing 6mm L 6mm aluminium Qty 1 pcs ED \varnothing 8.5mm		
accessories for	102975		
	Part No.	100217	Ref. No. —
	pilot burner nozzle LPG gas pressure 30mbar code 3 Qty 1 pcs suitable for JUNKERS CB5050_		
	Part No.	101282	Ref. No. —
	olive for pipe \varnothing 4mm L 7.4mm Qty 1 pcs		

Table continues overleaf





accessories for	102975			
	Part No.	101283	Ref. No.	—
	union screw thread M10x1 for pipe ø 4mm Qty 1 pcs			

ignition cables

pre-assembled cables

1 			
Part No.	102150	Ref. No.	6267.00031.07
description	ignition cable cable length 1500mm connection ø2.4mm / ø4mm		

1 			
Part No.	100140	Ref. No.	6267.00031.01
description	ignition cable cable length 400mm connection ø2.4mm / ø4mm		

1 			
Part No.	100019	Ref. No.	6267.00031.05
description	ignition cable cable length 900mm connection ø2.4mm / ø4mm		

piezoelectric igniters

mounting diameter 18mm

1 			
Part No.	100003	Ref. No.	9GEV1000030
description	piezoelectric igniter body metal blowing mounting ø 18mm connection F2.8x0.8		

thermocouples

plug-in thermocouples

plug-in thermocouples standard

with barrel socket ø6(6.5)mm

thermocouples SIT

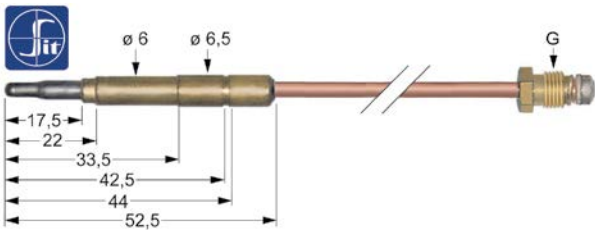
1 			
Part No.	107604	Ref. No.	6267.00024.04
description	thermocouple SIT M8x1 L 1200mm plug connection ø6.0(6.5)mm		

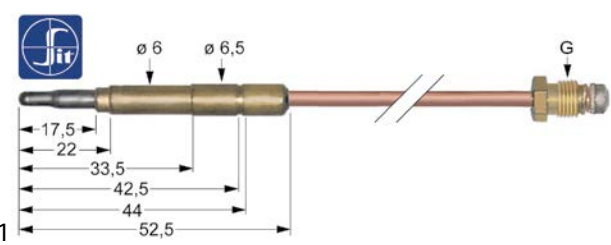
1 			
Part No.	107613	Ref. No.	6267.00024.07 T1005191200E
description	thermocouple SIT M9x1 L 1200mm plug connection ø6.0(6.5)mm		

gas burners

hob burners

producer-specific hob burners

ÖZTIRYAKILER

stockpot stoves

1 			
Part No.	104195	Ref. No.	62670000101
description	burner ø 150mm		

1 			
Part No.	104308	Ref. No.	62670000104
description	burner ø 250mm		

equipment-specific units

for potato peelers

drive shafts

1 			
Part No.	696573	Ref. No.	2840.00010.66
description	drive shaft lower for potato peeler device ø 35mm L 141mm PSM10		
For models:	PSM10		



1

Part No.	696574	Ref. No.	2840.00020.24
description	drive shaft lower for potato peeler device ø 41mm L 184mm PSM20		
For models:	PSM20		



1

Part No.	696575	Ref. No.	2840.00030.17
description	drive shaft lower for potato peeler device ø 41mm L 187mm PSM30		

lids



1

Part No.	696578	Ref. No.	6261.00013.10
description	lid for potato peeler device ø 410mm ID ø 330mm plastic mounting distance mm PSM10 H 100mm		
For models:	PSM10		



1

Part No.	696563	Ref. No.	2840.00010.54
description	lid for potato peeler device ø 410mm ID ø 330mm plastic mounting distance mm PSM10 H 79mm		
For models:	PSM10		



1

Part No.	696561	Ref. No.	2840.00020.08
description	lid for potato peeler device ø 510mm ID ø 440mm plastic mounting distance 160mm PSM20 H 81mm		
For models:	PSM20		



1

Part No.	696562	Ref. No.	2840.00030.11
description	lid for potato peeler device ø 610mm ID ø 540mm plastic mounting distance 155mm PSM30 H 82mm		
For models:	PSM30		

abrasive side elements

inserts



1

Part No.	696568	Ref. No.	6002.00015.00
description	abrasive band for potato peeler device ø mm L 1210mm mounting distance mm PSM10 W 300mm		
For models:	PSM10		

grinding discs



1

Part No.	696565	Ref. No.	2840.00010.11
description	grinding disc ø 365mm for potato peeler device PSM10		
For models:	PSM10		



1

Part No.	696564	Ref. No.	2840.00010.56
description	grinding disc ø 375mm for potato peeler device PSM10		
For models:	PSM10		

1

Part No.	696566	Ref. No.	2840.00020.03
description	grinding disc ø 460mm for potato peeler device PSM20		
For models:	PSM20		



1

Part No.	696567	Ref. No.	2840.00030.03
description	grinding disc ø 570mm for potato peeler device PSM30		
For models:	PSM30		

accessories



1

Part No.	696570	Ref. No.	2840.00020.20 2840.00030.12
description	handle for grinding disc model PSM20/30 ø 88mm L 140mm bore ø 8mm		
For models:	PSM20, PSM30		

miscellaneous

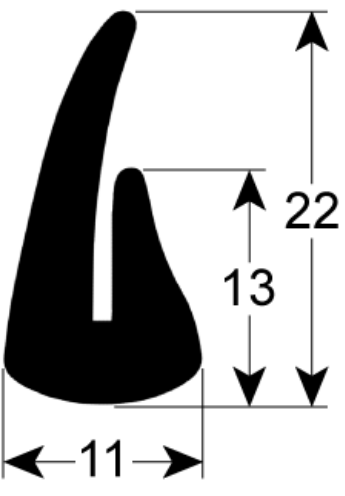

1

Part No.	696572	Ref. No.	6261.00010.10
description	gasket for potato peeler device L 1320mm model PSM		
For models:	PSM10		



1

Part No.	696571	Ref. No.	6261.00010.03
description	gasket for potato peeler device rubber L 205mm W 175mm H 17mm		
For models:	PSM10		



1

Part No.	696569	Ref. No.	2840.00010.51
description	housing for potato peeler device plastic L 250mm W 210mm H 200mm		
For models:	PSM10, PSM20, PSM30		

accessories



1

Part No.	696577	Ref. No.	2840.00020.21
description	coupling for drive shaft ID ø 41mm ED ø 70mm L 70mm for model PSM20		
For models:	PSM20		



1

Part No.	696576	Ref. No.	2840.00030.04
description	coupling for drive shaft ID ø 41mm ED ø 70mm L 70mm for model PSM30		
For models:	PSM30		



for planetary mixers

gearboxes



1

Part No.	698452	Ref. No.	2810.20200.26
description	drive shaft for dough hook L 155mm ø 40mm model 20 litres		
For models:	OM20G		



1

Part No.	698451	Ref. No.	2810.20200.17 6261.00018.52
description	drive shaft for gearbox L 220mm ø 43mm		
For models:	OM20G		



1

Part No.	698441	Ref. No.	2810.00010.51
description	internal gear for gearbox ø 170mm H 39mm model 10 litres		
For models:	OM10G		

dough hooks



1

Part No.	698425	Ref. No.	2810.00010.08
description	dough hook model 10 litres shaft ø 16mm H 220mm		
For models:	OM10G		



1

Part No.	698424	Ref. No.	2810.20200.59
description	dough hook model 20 litres shaft ø 22.5mm H 310mm		
For models:	OM20G		



1

Part No.	698423	Ref. No.	2810.40400.59
description	dough hook model 40 litres shaft ø 29mm H 410mm		
For models:	OM40G		

EQUIPMENT-SPECIFIC UNITS ÖZTIRYAKILER



1

Part No.	698422	Ref. No.	2810.60600.59
description	dough hook model 60 liters shaft ø 29mm H 460mm		
For models:	OM60G		

pulleys



1

Part No.	698434	Ref. No.	2810.20200.33
description	pulley bottom left disc ø 180mm ø 180mm shaft intake ø 32mm seat ø 54mm model 20 litres groove depth 65mm disc width 6mm overall width 56mm metal for planetary mixer		
For models:	OM20G		



1

Part No.	698440	Ref. No.	2810.40400.10
description	pulley bottom left disc ø 205mm ø 205mm shaft intake ø 32mm seat ø 50mm model 40/60 litres groove depth 70mm disc width 45mm overall width 57mm metal for planetary mixer		
For models:	OM40G, OM60G		



1

Part No.	698437	Ref. No.	2810.20200.10
description	pulley bottom right disc ø 180mm ø 180mm shaft intake ø 14mm seat ø 33mm model 20 litres groove depth 65mm disc width 3mm overall width 110mm metal for planetary mixer		
For models:	OM20G		



1

Part No.	698435	Ref. No.	2810.20200.34
description	pulley upper left disc ø 180mm ø 180mm shaft intake ø 19mm seat ø 45mm model 20 litres groove depth 60mm disc width 5mm overall width 129mm metal for planetary mixer shaft ø 32mm		
For models:	OM20G		



1

Part No.	698438	Ref. No.	2810.40400.33
description	pulley bottom right disc ø 180mm ø 180mm shaft intake ø 23mm seat ø 45mm model 40 litres groove depth 65mm disc width 5mm overall width 130mm metal for planetary mixer		
For models:	OM40G		



1

Part No.	698436	Ref. No.	2810.20200.09
description	pulley upper right disc ø 180mm ø 180mm shaft intake ø 32mm seat ø 50mm model 20 litres groove depth 65mm disc width 6mm overall width 60mm metal for planetary mixer		
For models:	OM20G		



1

Part No.	698439	Ref. No.	2810.40400.34
description	pulley upper right disc ø 180mm ø 180mm shaft intake ø 35mm seat ø 54mm model 40 litres groove depth 67mm disc width 6mm overall width 56mm metal for planetary mixer		
For models:	OM40G		



beaters



1

Part No.	698420	Ref. No.	2810.00010.13
description	beater model 10 litres shaft ø 16mm W 155mm H 210mm		
For models:	OM10G		



1

Part No.	698421	Ref. No.	2810.00020.50 2810.20200.58
description	beater model 20 litres shaft ø 22.5mm W 185mm H 310mm		
For models:	OM20G		



1

Part No.	698427	Ref. No.	2810.40400.58
description	beater model 40 litres shaft ø 29mm W 240mm H 305mm		
For models:	OM40G		



1

Part No.	698426	Ref. No.	2810.60600.58
description	beater model 60 liters shaft ø 29mm W 300mm H 330mm		
For models:	OM60G		

mixer bowls



1

Part No.	698432	Ref. No.	2810.00010.31
description	mixer bowl model 10 litres ø 280mm H 205mm		
For models:	OM10G		

EQUIPMENT-SPECIFIC UNITS ÖZTIRYAKILER



1

Part No.	698433	Ref. No.	2810.20200.49
description	mixer bowl model 20 litres ø 340mm H 275mm		
For models:	OM20G		

beaters



1

Part No.	698428	Ref. No.	2810.00010.16
description	whisk model 10 litres shaft ø 16mm ø 120mm H 220mm		
For models:	OM10G		



1

Part No.	698431	Ref. No.	2810.20200.57
description	whisk model 20 litres shaft ø 22.5mm ø 175mm H 310mm		
For models:	OM20G		



1

Part No.	698429	Ref. No.	2810.40400.57
description	whisk model 40 litres shaft ø 29mm ø 235mm H 400mm		
For models:	OM40G		



1

Part No.	698430	Ref. No.	2810.00060.17 2810.60600.57
description	whisk model 60 liters shaft ø 29mm ø 265mm H 460mm		
For models:	OM60G		



gear wheels



1

Part No.	698448	Ref. No.	6261.00017.22
description	gear wheel ø 52mm shaft intake ø 15mm W 24mm teeth 23 polyamide for model 10 litres		
For models:	OM10G		



1

Part No.	698450	Ref. No.	2810.20200.23
description	gear wheel ø 52mm shaft intake ø 18mm W 32mm teeth 18 polyamide for model 20 litres		
For models:	OM20G		



1

Part No.	698449	Ref. No.	2810.40400.23
description	gear wheel ø 60mm shaft intake ø 24mm W 40mm teeth 15 polyamide for model 40/60 litres		
For models:	OM40G, OM60G		

for espresso machines

brewing units

filter holder gaskets

O-rings



1

Part No.	510409	Ref. No.	6228.00002.14
description	O-ring EPDM thickness 5.34mm ID ø 56.52mm Qty 1 pcs		

for saladettes

housing and bezels



1

Part No.	692115	Ref. No.	2912.16894.W0.750.00 7AYS.00002.19
description	cover housing L 413mm H 337mm plate thickness max. 30mm		

for dishwashers

drain and intake components

ÖZTIRYAKILER

overflow pipes



1

Part No.	517824	Ref. No.	6262.00028.001
description	overflow pipe L 200mm ø 40mm		



miscellaneous

drain /intake bodies



1			
Part No.	517766	Ref. No.	6262.00027.000
description	drain unit with filter		
For models:	OBK1500		

overflow pipes



1			
Part No.	517765	Ref. No.	2710.20051.450 6262.00028.02 6262.00028.02+6228.00001.36
description	overflow pipe L 400mm ø 41mm		
For models:	OBK1500		

housing and bezels

model name plates



1			
Part No.	694812	Ref. No.	2999.NOVAT.LO
description	type plate NOVATEC metal L 70mm W 32mm		

miscellaneous



1			
Part No.	506160	Ref. No.	6215.00001.03
description	plain washer ID ø 8.6mm ED ø 16mm thickness 1.5mm SS Qty 1 pcs		

washing and rinsing systems



1			
Part No.	504857	Ref. No.	6262.00030.33 + 6262.00030.01 6262.00033.33
description	wash and rinse arm wash arm L 510mm rinse arm L 510mm w. jets 10 r. jets 6		

washing and rinsing systems (sorted by producer)

ÖZTIRYAKILER

rinse arm shafts



1			
Part No.	699582	Ref. No.	2KLP.460.626200041.04
description	nut L 14.5mm M8x1 for rinse arm shaft		



1			
Part No.	699581	Ref. No.	2KLP.460.626200041.03 6262.00041.03
description	rinse arm shaft L 67mm M8x1 ø 15mm hole ø 6mm		

wash arm supports



1			
Part No.	699580	Ref. No.	6262.00030.05
description	tap head ø 110mm ID ø 46mm H 8mm for wash arm support		



1

Part No.	513327	Ref. No.	2710.F0024.02 6262.00024.02
description	wash arm support ø 46mm ID ø 40mm H 150mm 2"		

for plate dispensers



1

Part No.	501497	Ref. No.	6260.00022.00
description	guide roller for plate dispensers W 27mm ø 30mm ID ø 8mm		

knobs

producer-specific knobs

ÖZTIRYAKILER



1

Part No.	112748	Ref. No.	6260.00015.45+6260.00015.38
description	knob 0-1-0-1 ø 75mm shaft ø 6x4.6mm shaft flat upper/lower black		



1

Part No.	112659	Ref. No.	6260.00015.40 6260.00015.46 6260.00015.46+6260.00015.40 62600001518
description	knob gas tap with ignition flame ø 75mm shaft ø 8x6.5mm shaft flat upper/lower black		



1

Part No.	112746	Ref. No.	6260.00015.45+6260.00015.37
description	knob thermostat 30-90°C ø 75mm shaft ø 6x4.6mm shaft flat upper/lower black		



1

Part No.	112747	Ref. No.	6260.00015.45+6260.00015.32
description	knob thermostat 50-300°C ø 75mm shaft ø 6x4.6mm shaft flat upper/lower black		



1

Part No.	112661	Ref. No.	6260.00015.20 6260.00015.47+6260.00015.44
description	knob without symbol ø 80mm shaft ø 10x8mm shaft flat upper/lower black		



1

Part No.	112809	Ref. No.	6262.00071.20
description	knob zero mark ø 58mm shaft ø 6x5mm shaft flat upper		



handles and hand wheels

hand wheels

hand wheels



1

Part No.	694672	Ref. No.	6261.00028.52
description	hand wheel ø 190mm D1 ø 43mm bore ø 16mm depth of bore 21mm thread M10x1.5 groove width 5mm groove depth 21mm L1 20mm L2 35mm handle lengthmm		
For models:	OM20G, OM40G, OM60G		

spare parts and accessories



1

Part No.	514443	Ref. No.	2810.40400.31 6261.00028.78
description	cone handle ø 28mm total length 100mm thread M10x1.5 plastic L 81mm		
For models:	OM20G, OM40G, OM60G		

cone handles



1

Part No.	514443	Ref. No.	2810.40400.31 6261.00028.78
description	cone handle ø 28mm total length 100mm thread M10x1.5 plastic L 81mm		
For models:	OM20G, OM40G, OM60G		

locks

edgemount latches

handle latches

producer-specific

ÖZTIRYAKILER

locks



1

Part No.	701581	Ref. No.	6201.00031.01 7AYS.00008.04
description	catch L 254mm mounting distance 116mm chrome-plated steel lockable		

hinges

door bearing



1

Part No.	701430	Ref. No.	6201.00030.50
description	door guides L 80mm W 24mm H 115mm mounting pos. left/right		

pullouts

drawer slides

producer-specific



1

Part No.	692608	Ref. No.	2919.17NTS.00.910.00 left
description	drawer rail L 555mm pull-out lengthmm W 53mm H 15mm mounting pos. left		





1

Part No.	692678	Ref. No.	2919.17NTS.00.910.00 2919.17NTS.00.910.00 right
description	drawer rail L 555mm pull-out lengthmm W 53mm H 15mm pair		

fittings for catering equipment

drain taps

accessories



1

Part No.	540222	Ref. No.	6228.00059.60
description	O-ring EPDM thickness 2.62mm ID ø 47.3mm Qty 1 pcs		

shelves and shelf rails

shelf rails and supports

producer-specific



1

Part No.	692607	Ref. No.	6260.00068.04
description	pair of setting bar L 550mm W 60mm inner height 12mm hook width 15mm mounting distance 490mm		



1

Part No.	692605	Ref. No.	siehe Bemerkung 03,08,16
description	pair of setting bar L 725mm W 30mm inner height 13mm hook width 15mm		



1

Part No.	692606	Ref. No.	siehe Bemerkung 03,08,16
description	pair of setting bar U-shape L 660mm W 30mm inner height 13mm hook width 15mm mounting pos. left/right		

gaskets

refrigeration gaskets

plug-in gaskets

profile 9175

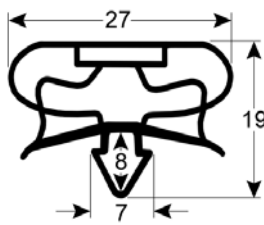

1

Part No.	902468	Ref. No.	6268.00012.26 6268.00012.30 7AYS.00008.21
description	refrigeration gasket profile 9175 W 615mm L 1387mm plug size		

profile 9014

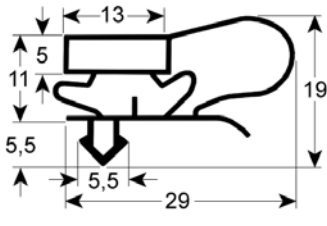

1

Part No.	902056	Ref. No.	6268.00012.10
description	refrigeration gasket profile 9014 W 380mm L 585mm plug size		

profile 9141

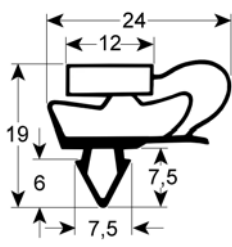

1

Part No.	901868	Ref. No.	6268.00012.32
description	refrigeration gasket profile 9041 W 574mm L 1530mm external size		
For models:	7919.06LMV.00, 7919.06NMV.00, 7919.12LMV.00, 7919.12NMV.00		

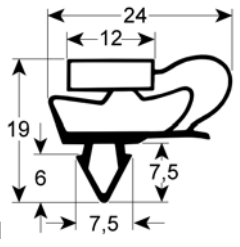
Part No.	901867	Ref. No.	6268.00012.60
description	refrigeration gasket profile 9141 W 400mm L 590mm		
For models:	7919.27LMV.00, 7919.27NMV.00, 7919.37LMV.00, 7919.37NMV.00		

O-rings

EPDM

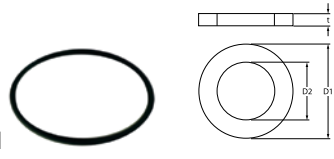

Part No.	540222	Ref. No.	6228.00059.60
description	O-ring EPDM thickness 2.62mm ID ø 47.3mm Qty 1 pcs		

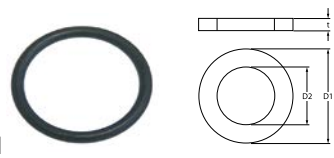

Part No.	510408	Ref. No.	6228.00001.22 6228.00001.26
description	O-ring EPDM thickness 5.34mm ID ø 47mm Qty 1 pcs		

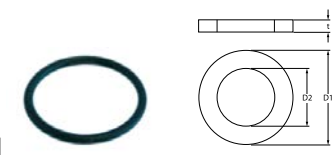

Part No.	510409	Ref. No.	6228.00002.14
description	O-ring EPDM thickness 5.34mm ID ø 56.52mm Qty 1 pcs		

shaft gaskets

shaft gaskets



Part No.	698453	Ref. No.	6228.00011.05
description	shaft sealing ID ø 25mm ED ø 42mm thickness 10mm type 6244		
For models:	PSM10		



Part No.	698454	Ref. No.	6228.00011.12
description	shaft sealing ID ø 40mm ED ø 62mm thickness 10mm type 6421		
For models:	PSM20, PSM30		

special gaskets

miscellaneous

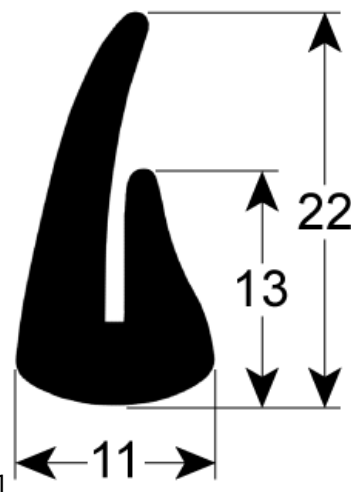

Part No.	696572	Ref. No.	6261.00010.10
description	gasket for potato peeler device L 1320mm model PSM		
For models:	PSM10		



Part No.	696571	Ref. No.	6261.00010.03
description	gasket for potato peeler device rubber L 205mm W 175mm H 17mm		
For models:	PSM10		



evaporators

for fridges

producer-specific



1

Part No.	750708	Ref. No.	6268.00011.60
description	evaporator L 420mm W 235mm H 115mm suitable for GN 600 NMV		
For models:	7919.06NMV.00		

transmission technology and ball bearings

ball bearings

deep-groove ball bearings 2RS



1

Part No.	523522	Ref. No.	6211.00210.01
description	deep-groove ball bearing type 6004-2RS shaft \varnothing 20mm ED \varnothing 42mm W 12mm with sealing discs deep-groove ball bearing DIN 625-1		
For models:	OM10G		



1

Part No.	523518	Ref. No.	6211.00243.00
description	deep-groove ball bearing type 6305-2RS shaft \varnothing 25mm ED \varnothing 62mm W 17mm with sealing discs deep-groove ball bearing DIN 625-1		
For models:	OM20G, OM40G, OM60G		

deep-groove ball bearings 2Z



1

Part No.	523032	Ref. No.	6211.00210.00
description	deep-groove ball bearing shaft \varnothing 20mm ED \varnothing 42mm W 12mm type 6004-2Z DIN 625-1		
For models:	OM10G, PSM10		



1

Part No.	523030	Ref. No.	6211.00222.00
description	deep-groove ball bearing shaft \varnothing 30mm ED \varnothing 62mm W 16mm type 6206-2Z DIN 625-1		
For models:	PSM20, PSM30		

drive belts

V-belts

profile A/13



1

Part No.	698444	Ref. No.	6263.00002.08
description	V-belt belt width 13mm L 875mm H 8mm CODE A34 1/2 profile A/13		
For models:	OM10G		

toothed belts



1

Part No.	698442	Ref. No.	6263.00003.02
description	toothed belt profile VX L 1025mm H 10mm teeth 150 splitting 5-4 rubber with textile insertion CODE 1025Li W 32mm		
For models:	OM60G		



1

Part No.	698443	Ref. No.	6263.00003.11
description	toothed belt profile VX L 820mm H 10mm teeth 82 splitting 8-4 rubber with textile insertion CODE 820Li W 32mm		
For models:	OM20G		



1

Part No.	698447	Ref. No.	6263.00003.10
description	toothed belt profile VX L 950mm H 10mm teeth 100 splitting 6-4 rubber with textile insertion CODE SD2006-002 W 32mm		
For models:	OM40G		

poly-v belts



Part No.	698445	Ref. No.	6263.00006.01
description	poly-v belt grooves 11 W 26mm L 559mm profile J		
For models:	PSM10		

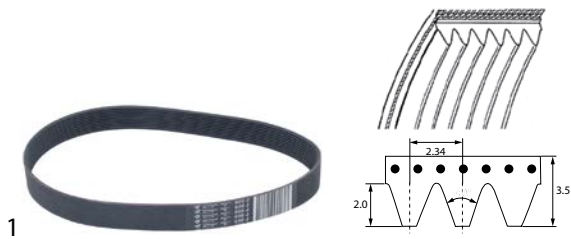

Part No.	698446	Ref. No.	6263.00006.02
description	poly-v belt grooves 11 W 26mm L 660mm profile J		
For models:	PSM20, PSM30		

springs

tension springs



Part No.	501496	Ref. No.	6205.00001.01
description	tension spring ø 14mm total length 139mm wire gauge ø 1.2mm		

dosing pumps

peristaltic dosing pumps

SEKO

built-in version

with frequency control



Part No.	361979 ¹	Ref. No.	6262.30666.14
description	dosing pump SEKO frequency control 0.4l/h 230VAC rinse aid hose ø 4x6mm hose type D hose Sekobril type NBR 0.4 with inlet and conveyor hose		

¹with accessories

hoses

supply hoses

PVC supply hoses

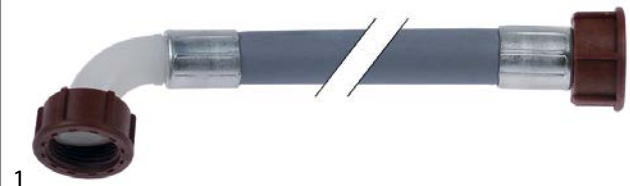

Part No.	520010	Ref. No.	6262.00021.12	
description	supply hose PVC straight-curved DN13 connections 3/4" L 1500mm operating p. 10bar burst p. 32bar t.max. 90°C blue approval VDE flat seal			
For models:	OBK1500			
accessories for	520010			
	Part No.	520053	Ref. No.	—
	screen connection 3/4" D1 ø 26mm D2 ø 15mm Qty 10 pcs rubber thickness 8mm			
	Part No.	520054	Ref. No.	—
	flat gasket rubber ED ø 23.5mm ID ø 14mm thickness 2.3mm Qty 10 pcs			

drain hoses



Part No.	530872	Ref. No.	6262.00021.13
description	drain hose DN31 L 2500mm A int. ø 40mm A ext. ø 47mm B int. ø 40mm B ext. ø 47mm		
For models:	OBK1500		

fittings, hose and pipe connectors

fittings

double nipples



Part No.	521192	Ref. No.	6222.00003.25
description	double nipple brass thread 1"-3/4" Qty 1 pcs		







drain systems and wash basins

wash basins



1

Part No.	542317	Ref. No.	7759.54483.10
description	hand-wash basin stainless steel W 500mm D 400mm H 390mm		
accessories for	542317		
	Part No.	515015	Ref. No. —
	U-bend basins 1 thread 1½" flexible hose outflow distance max. 150mm spout ø 40mm		
	Part No.	515045	Ref. No. —
	drain fitting size 1½" usable heightmm overall height 41mm ED ø 70mm chrome-plated brass		
	Part No.	515089	Ref. No. —
	drain fitting size 1½" usable heightmm overall height 40mm ED ø 71mm stainless steel		
	Part No.	515141	Ref. No. —
	drain fitting size 1 1/2" usable heightmm overall heightmm ED ø 70mm SS/plastic with plug		

fastening material

screws

hexagonal screws



1

Part No.	550682	Ref. No.	6262.00003.10
description	hexagonal screw thread M8 thread L 20mm SS WS 13 Qty 1 pcs DIN 933 / ISO 4017		

nuts

plate nuts



1

Part No.	560573	Ref. No.	6214.00009.00
description	plate nut hole ø 2.6mm L 17mm W 12mm		

hexagonal nuts

DIN 985



1

Part No.	560143	Ref. No.	6214.00013.15
description	hexagonal nut thread M8 H 8.5mm SS WS 13 Qty 20 pcs DIN/ISO DIN 985 self-locking		

washers

washers

miscellaneous



1

Part No.	506160	Ref. No.	6215.00001.03
description	plain washer ID ø 8.6mm ED ø 16mm thickness 1.5mm SS Qty 1 pcs		

tooth lock washers

DIN 6798A



1

Part No.	503121	Ref. No.	6216.00015.05
description	tooth lock washer ID ø 8.4mm ED ø 15mm SS Qty 1 pcs		

fasteners

mounting clips



1

Part No.	524043	Ref. No.	7AYS0000220
description	mounting clip plastic L 38mm W 19mm H 10mm		

GASTROPARTS.COM

