



GASTROPARTS

Omniwash

- [EN]** Equipment
- [DE]** Geräte
- [ES]** Aparatos
- [FR]** Équipement
- [IT]** Attrezzature
- [PL]** Urządzenia
- [RU]** Оборудование

✉ gastroparts@gastroparts.com

☎ tel. +48 56 657 00 66

📘 fb.com/gastroparts.global

GASTROPARTS.COM





heating elements

immersion heating elements

3 hole flange ø35.0mm

1

| | | | | |
|------------------------|---|-----------------|----------|---------|
| Part No. | 416210 | Ref. No. | CERB22 | |
| description | heating element 2200W 230V heating circuits 1 mounting ø 35mm L 253mm W 25mm H 25mm tube ø 6.5mm hole distance 44mm hole ø 10mm connection M5 immersion heater 3 hole flange connection length 16mm | | | |
| For models: | JOLLY AQ, JOLLY AT, JOLLY Q, JOLLY T | | | |
| accessories for | 416210 | | | |
| | Part No. | 507048 | Ref. No. | G42303S |
| | gasket ID ø 30mm silicone thickness 3mm hole ø 10mm hole distance 41mm for heating element warewashing | | | |

1

| | | | | |
|------------------------|--|-----------------|---------------------|---------|
| Part No. | 416211 | Ref. No. | CERB2712 CERB27R | |
| description | heating element 2700W 230V heating circuits 1 mounting ø 35mm L 300mm W 25mm H 24mm tube ø 6.3mm hole distance 44mm hole ø 10mm connection male faston 6.3mm immersion heater 3 hole flange connection length 15mm | | | |
| For models: | DUE ACLQ, DUE ACSQ, DUE AQ, UNO AQ, UNO CLQ, UNO CSQ, UNO Q | | | |
| accessories for | 416211 | | | |
| | Part No. | 507048 | Ref. No. | G42303S |
| | gasket ID ø 30mm silicone thickness 3mm hole ø 10mm hole distance 41mm for heating element warewashing | | | |

1

| | | | | |
|------------------------|--|-----------------|----------|---------|
| Part No. | 416212 | Ref. No. | CERB30 | |
| description | heating element 3000W 230V heating circuits 1 mounting ø 35mm L 330mm W 28.5mm H 25mm tube ø 6.25mm hole distance 44mm hole ø 10mm connection M5 immersion heater 3 hole flange connection length 15mm | | | |
| For models: | QUATTRO Q/82, QUATTRO T/82 | | | |
| accessories for | 416212 | | | |
| | Part No. | 507048 | Ref. No. | G42303S |
| | gasket ID ø 30mm silicone thickness 3mm hole ø 10mm hole distance 41mm for heating element warewashing | | | |

3 hole flange ø57.5mm

1

| | | | | |
|------------------------|---|-----------------|----------|---|
| Part No. | 416213 | Ref. No. | CERB453F | |
| description | heating element 4500W 230V mounting ø 57.5mm heating circuits 3 L 383mm W 50mm H 38mm number of thermostat sleeves 1 thermostat sleeves ø 8mm length thermostat sleeves 290mm thermostat sleeve eccentric, non clinging tube ø 8mm hole distance 70mm hole ø 8mm connection M5 3 hole flange immersion heater | | | |
| For models: | QUATTRO Q/82, QUATTRO T/82, SEI 1P, SEI 2P, SEI 2P/S | | | |
| accessories for | 416213 | | | |
| | Part No. | 550002 | Ref. No. | — |
| | tension strap H 10mm L 21mm W 10mm hole ø 6.5mm for heating element | | | |





1

| | | | | |
|------------------------|--|-----------------|----------|--------------------|
| Part No. | 416214 | Ref. No. | CERB603F | |
| description | heating element 6000W 230V mounting ø 57.5mm heating circuits 3 L 410mm W 32mm H 50mm thermostat sleeves ø 8.5mm length thermostat sleeves 270mm thermostat sleeve upper centre not clinging tube ø 8.5mm hole distance 70mm hole ø 10mm connection length 30mm connection M5 3 hole flange immersion heater | | | |
| For models: | QUATTRO Q/82, QUATTRO T/82, SEI 1P, SEI 2P, SEI 2P/S | | | |
| spare parts for | 416214 | | | |
| | Part No. | 510409 | Ref. No. | GUREBOT ORRB3F |
| | O-ring EPDM thickness 5.34mm ID ø 56.52mm Qty 1 pcs | | | |
| accessories for | 416214 | | | |
| | Part No. | 510409 | Ref. No. | GUREBOT ORRB3F |
| | O-ring EPDM thickness 5.34mm ID ø 56.52mm Qty 1 pcs | | | |
| | Part No. | 520332 | Ref. No. | GB083F GB083FV0 |
| | protection cap for heating element | | | |



1



| | | | |
|--------------------|---|-----------------|----------|
| Part No. | 416215 | Ref. No. | CERB903F |
| description | heating element 9000W 230V mounting ø 57.5mm heating circuits 3 L 410mm W 35mm H 52mm number of thermostat sleeves 1 thermostat sleeves ø 7.5mm length thermostat sleeves 290mm thermostat sleeve eccentric, non clinging tube ø 8mm hole distance 70mm hole ø 8mm connection M5 3 hole flange immersion heater | | |
| For models: | SEI 1P, SEI 2P, SEI 2P/S | | |







| 1 1/4" | | | |
|---|---|-----------------|--------------------------|
|  | | | |
| Part No. | 416218 | Ref. No. | CERV453F |
| description | heating element 4500W 230V heating circuits 3 thread 1 1/4" L 275mm W 95mm H 45mm L1 40mm L2 25mm L3 210mm W1 32mm W2 29mm H1 23mm H2 22mm connection male faston 6.3mm immersion heater flange with thread | | |
| For models: | SEI 1P, SEI 2P/S | | |
| spare parts for | 416218 | | |
|  | Part No. | 510405 | Ref. No. — |
| | flat gasket fibre ED ø 56mm ID ø 42mm thickness 2mm for thread 1 1/4" Qty 1 pcs | | |
| accessories for | 416218 | | |
|  | Part No. | 507333 | Ref. No. G50403GT |
| | flat gasket rubber ED ø 52mm ID ø 41.5mm thickness 3mm Qty 1 pcs equiv. no. G50403GT suitable for IME/Omniwash | | |
|  | Part No. | 528021 | Ref. No. — |
| | flat gasket PTFE ED ø 53mm ID ø 42.5mm thickness 3mm Qty 1 pcs equiv. no. 12001/02286 suitable for Astoria/Aurora/Brasilia/Wega | | |

| | | | |
|---|--|-----------------|---|
|  | | | |
| Part No. | 416216 | Ref. No. | CERV18 |
| description | heating element 1800W 230V heating circuits 1 L 330mm W 48mm H 32mm thread M12x1 mounting distance 40mm tube ø 8.5mm connection male faston 6.3mm 2 hole fixing immersion heater | | |
| For models: | DUE ACLQ, DUE ACSQ, DUE AQ, UNO AQ, UNO CLQ, UNO CSQ, UNO Q | | |
| accessories for | 416216 | | |
|  | Part No. | 507332 | Ref. No. G18122GT |
| | flat gasket fibre ED ø 18mm ID ø 12mm thickness 2mm Qty 1 pcs | | |
|  | Part No. | 511923 | Ref. No. CEPRV CEPRVVO CEPRVVOGR |
| | protection cap for heating element thread M12 | | |
|  | Part No. | 550681 | Ref. No. — |
| | nut thread M12x1.25 H 5mm WS 17 brass Qty 1 pcs | | |

| | | | |
|---|--|-----------------|-------------------|
|  | | | |
| Part No. | 418603 | Ref. No. | CERV22 |
| description | heating element 2200W 230V heating circuits 1 L 405mm W 160mm H 35mm thread M12x1 mounting distance 42mm tube ø 8.5mm 2 hole fixing connection male faston 6.3mm immersion heater L1 208mm L2 197mm W1 110mm W2 50mm | | |
| spare parts for | 418603 | | |
|  | Part No. | 528110 | Ref. No. — |
| | O-ring EPDM thickness 2.62mm ID ø 12.37mm Qty 1 pcs | | |
| accessories for | 418603 | | |
|  | Part No. | 520229 | Ref. No. — |
| | nut thread M12x1 H 4mm WS 16 zinc-coated steel Qty 1 pcs | | |

| | | | |
|---|---|--------|-------------------|
| accessories for | 418603 | | |
|  | Part No. | 521110 | Ref. No. — |
| | flat gasket fibre ED ø 20mm ID ø 13mm thickness 2mm Qty 1 pcs | | |
|  | Part No. | 521131 | Ref. No. — |
| | nut thread M12x1 H 3.5mm WS 17 SS Qty 1 pcs | | |

| | | | |
|--|---|-----------------|--------------------------|
|  | | | |
| Part No. | 416217 | Ref. No. | CERV25 |
| description | heating element 2500W 230V heating circuits 1 L 410mm W 147mm H 27mm thread M12x1 mounting distance 35mm tube ø 8.3mm connection male faston 6.3mm 2 hole fixing immersion heater L1 195mm L2 215mm W1 96mm W2 43mm | | |
| For models: | QUATTRO Q/82, QUATTROT/82 | | |
| accessories for | 416217 | | |
|  | Part No. | 507332 | Ref. No. G18122GT |
| | flat gasket fibre ED ø 18mm ID ø 12mm thickness 2mm Qty 1 pcs | | |

| | | | |
|---|---|-----------------|--------------------------|
|  | | | |
| Part No. | 416219 | Ref. No. | CERV8 |
| description | heating element 800W 230V heating circuits 1 L 317mm W 55mm H 32mm thread M12x1 mounting distance 46.5mm tube ø 8.5mm connection male faston 6.3mm 2 hole fixing immersion heater | | |
| For models: | JOLLY AQ, JOLLY AT, JOLLY Q, JOLLY T | | |
| accessories for | 416219 | | |
|  | Part No. | 507332 | Ref. No. G18122GT |
| | flat gasket fibre ED ø 18mm ID ø 12mm thickness 2mm Qty 1 pcs | | |
|  | Part No. | 520229 | Ref. No. — |
| | nut thread M12x1 H 4mm WS 16 zinc-coated steel Qty 1 pcs | | |

thermostats

bi-metal thermostats

safety bi-metal thermostats

| | | | |
|---|---|-----------------|---------|
|  | | | |
| Part No. | 390455 | Ref. No. | CESB454 |
| description | bi-metal safety thermostat hole distance 40mm switch-off temp. 100°C 2NC 2-pole 16A connection F6.3 2 hole fixing | | |
| For models: | DUE ACLQ, DUE ACSQ, DUE AQ, JOLLY AQ, JOLLY AT, JOLLY Q, JOLLY T, QUATTRO Q/82, QUATTRO T/82, SEI 1P, SEI 2P, SEI 2P/S, UNO AQ, UNO CLQ, UNO CSQ, UNO Q | | |



| | | | |
|---|--|-----------------|---------|
|  | | | |
| 1 | | | |
| Part No. | 390456 | Ref. No. | CESV001 |
| description | bi-metal safety thermostat hole distance 40mm switch-off temp. 85°C 2NC 2-pole 16A connection F6.3 2 hole fixing | | |
| For models: | SEI 1P, SEI 2P, SEI 2P/S | | |

control and safety thermostats

IMIT / TEMPOMATIC / ARTHERMO

control thermostats

| | | | |
|---|---|-----------------|---------------------|
|  | | | |
| 1 | | | |
| Part No. | 390186 | Ref. No. | CETV55 CETV55CAM |
| description | thermostat t.max. 52°C temperature range fixed 52°C 1-pole 1CO 16A probe ø 6.5mm probe L 95mm capillary pipe 1000mm capillary pipe isolated 1000mm gland nut shaft Lmm contacts 1CO | | |
| For models: | DUE ACLQ, DUE ACSQ, DUE AQ, JOLLY AQ, JOLLY AT, JOLLY Q, JOLLY T, QUATTRO Q/82, QUATTRO T/82, UNO AQ, UNO CLQ, UNO CSQ, UNO Q | | |

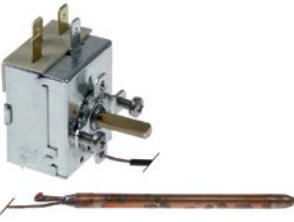

| | | | |
|--|---|-----------------|---------------------|
|  | | | |
| 1 | | | |
| Part No. | 390457 | Ref. No. | CETB85 CETB85CAM |
| description | thermostat t.max. 85°C temperature range 0-90°C 1-pole 1CO 16A probe ø 6.5mm probe L 110mm capillary pipe 1000mm capillary pipe isolated 950mm gland nut shaft ø 6x4.6mm shaft L 19mm shaft position upper shaft position +135° rotation 270° probe material copper | | |
| For models: | DUE ACLQ, DUE ACSQ, DUE AQ, JOLLY AQ, JOLLY AT, JOLLY Q, JOLLY T, QUATTRO Q/82, QUATTRO T/82, SEI 1P, SEI 2P, SEI 2P/S, UNO AQ, UNO CLQ, UNO CSQ, UNO Q | | |



switches and momentary switches

rocker/momentary rocker switches



30x22mm

| | | | |
|---|---|-----------------|----------|
|  | | | |
| 1 | | | |
| Part No. | 301135 | Ref. No. | CEPU6374 |
| description | momentary rocker switch mounting measurements 30x22mm orange 2NO 24V 16A illuminated connection male faston 6.3mm ambient temperature max. 100/55°C protection IP40 | | |



| | | | |
|---|--|-----------------|---------|
|  | | | |
| 1 | | | |
| Part No. | 301018 | Ref. No. | CEPUASL |
| description | momentary rocker switch mounting measurements 30x22mm orange 2NO 250V 16A illuminated 0-I connection male faston 6.3mm ambient temperature max. 125/55°C protection IP65 | | |
| For models: | DUE AQ, DUE AT, QUATTRO Q/82, QUATTRO T/82, UNO AQ, UNO AT, UNO Q, UNO T | | |
| accessories for | 301018 | | |
| |  | Part No. | 301036 |
| | | Ref. No. | — |
| | protective cover internal size 30x22mm for rocker switch mounting measurementsmm | | |

| | | | |
|---|---|-----------------|----------|
|  | | | |
| 1 | | | |
| Part No. | 301145 | Ref. No. | CEDV6364 |
| description | momentary rocker switch mounting measurements 30x22mm green 2CO 250V 16A illuminated connection male faston 6.3mm ambient temperature max. 85°C protection IP40 | | |
| accessories for | 301145 | | |
| |  | Part No. | 301036 |
| | | Ref. No. | — |
| | protective cover internal size 30x22mm for rocker switch mounting measurementsmm | | |

| | | | |
|--|---|-----------------|--------------------|
|  | | | |
| 1 | | | |
| Part No. | 301278 | Ref. No. | CEDV6364 CEDVRT |
| description | rocker switch mounting measurements 30x22mm green 2CO 24V 6A illuminated connection male faston 6.3mm ambient temperature max. 85°C protection IP40 | | |
| For models: | SEI 2P | | |

| | | | |
|---|---|-----------------|-----------|
|  | | | |
| 1 | | | |
| Part No. | 301017 | Ref. No. | CEDV01VSL |
| description | rocker switch mounting measurements 30x22mm green 2CO 250V 16A illuminated connection male faston 6.3mm ambient temperature max. 125/55°C protection IP40 | | |
| For models: | DUE AQ, DUE AT, QUATTRO Q/82, QUATTRO T/82, UNO AQ, UNO AT, UNO Q, UNO T | | |
| accessories for | 301017 | | |
| |  | Part No. | 301036 |
| | | Ref. No. | — |
| | protective cover internal size 30x22mm for rocker switch mounting measurementsmm | | |





| | | | |
|---|--|-----------------|-------------------|
|  | | | |
| 1 | | | |
| Part No. | 301140 | Ref. No. | CEDVC2 |
| description | rocker switch mounting measurements 30x22mm black 2CO 250V 16A I-II connection male faston 6.3mm ambient temperature max. 125/55°C protection IP40 | | |
| For models: | QUATTRO Q/82, QUATTRO T/82 | | |
| accessories for | 301140 | | |
|  | Part No. | 301036 | Ref. No. — |
| | protective cover internal size 30x22mm for rocker switch mounting measurementsmm | | |

| | | | |
|---|--|-----------------|----------|
|  | | | |
| 1 | | | |
| Part No. | 301288 | Ref. No. | CEPU6374 |
| description | momentary rocker switch mounting measurements 30x22mm orange 2NO 250V 16A illuminated connection male faston 6.3mm ambient temperature max. 100/55°C protection IP40 | | |
| For models: | SEI 2P | | |

| | | | |
|---|--|-----------------|--------|
|  | | | |
| 1 | | | |
| Part No. | 301136 | Ref. No. | CEPUC2 |
| description | momentary rocker switch mounting measurements 30x22mm orange 2NO/indicator light 250V 16A connection male faston 6.3mm ambient temperature max. 100/55°C protection IP40 | | |
| For models: | QUATTRO Q/82, QUATTRO T/82 | | |

| | | | |
|---|---|-----------------|---------|
|  | | | |
| 1 | | | |
| Part No. | 301132 | Ref. No. | CEPUVSL |
| description | momentary rocker switch mounting measurements 30x22mm green 2NO 250V 16A illuminated rinsing warm/cold connection male faston 6.3mm ambient temperature max. 85°C protection IP40 | | |
| For models: | DUE AQ, DUE AT, QUATTRO Q/82, QUATTRO T/82, UNO AQ, UNO AT, UNO Q, UNO T | | |

| | | | |
|---|--|-----------------|--------|
|  | | | |
| 1 | | | |
| Part No. | 301134 | Ref. No. | CEPUPS |
| description | momentary rocker switch mounting measurements 30x22mm orange 2NO 250V 16A illuminated outflow connection male faston 6.3mm ambient temperature max. 100/55°C protection IP40 | | |
| For models: | DUE AQ, DUE AT, QUATTRO Q/82, QUATTRO T/82, UNO AQ, UNO AT, UNO Q, UNO T | | |

| | | | |
|---|---|-----------------|---------|
|  | | | |
| 1 | | | |
| Part No. | 301133 | Ref. No. | CEPURIG |
| description | momentary rocker switch mounting measurements 30x22mm orange 2NO 250V 16A illuminated regeneration connection male faston 6.3mm ambient temperature max. 85/125°C protection IP40 | | |
| For models: | DUE AQ, DUE AT, QUATTRO Q/82, QUATTRO T/82, UNO AQ, UNO AT, UNO Q, UNO T | | |



34.2x12.6mm

| | | | |
|---|--|-----------------|-----------|
|  | | | |
| 1 | | | |
| Part No. | 301131 | Ref. No. | CEPUR3012 |
| description | momentary rocker switch mounting measurements 34.2x12.6mm orange 2NO 250V 16A illuminated rinsing warm/cold connection male faston 6.3mm | | |
| For models: | DUE ACLQ, DUE ACLT, JOLLY AQ, JOLLY AT, JOLLY Q, JOLLY T, UNO CLQ, UNO CLT | | |

| | | | |
|---|--|-----------------|-----------|
|  | | | |
| 1 | | | |
| Part No. | 301130 | Ref. No. | CEPUC3012 |
| description | momentary rocker switch mounting measurements 34.2x12.6mm orange 2NO 250V 16A illuminated ventilation connection male faston 6.3mm | | |
| For models: | DUE ACLQ, DUE ACLT, JOLLY AQ, JOLLY AT, JOLLY Q, JOLLY T, UNO CLQ, UNO CLT | | |

accessories

element holders

| | | | |
|---|-----------------------------------|-----------------|----------------------------|
|  | | | |
| 1 | | | |
| Part No. | 346938 | Ref. No. | CETP2230 |
| description | element holder dimensions 30x22mm | | |
| accessories for | 346938 | | |
|  | Part No. | 346950 | Ref. No. CETRP2230V |
| | push button L 25mm W 19.5mm green | | |





microswitches

lever actuated

| | | | |
|---|--|-----------------|----------|
|  | | | |
| 1 | | | |
| Part No. | 345515 | Ref. No. | CEMP12CL |
| description | microswitch 250V 16A 1CO connection male faston 6.3mm ambient temperature max. 125°C with plunger type EF83161.1 | | |

| | | | |
|---|--|-----------------|-----------|
|  | | | |
| 1 | | | |
| Part No. | 346946 | Ref. No. | CEMP12CLC |
| description | microswitch with lever 230V 4A 1NO connection male faston 6.3mm ambient temperature max. 85°C lever length 48/42mm | | |

| | | | |
|---|---|-----------------|-------------|
|  | | | |
| 1 | | | |
| Part No. | 347725 | Ref. No. | CEMP62PS306 |
| description | microswitch with lever 250V 16A 1CO connection male faston 6.3mm L 35mm ambient temperature max. 125°C mounting distance 22mm type VRSR01DA1 actuating force: 70g lever length 22mm | | |

| | | | |
|---|--|-----------------|-----------|
|  | | | |
| 1 | | | |
| Part No. | 346237 | Ref. No. | CEMP12CSC |
| description | microswitch with lever 250V 16A 1NO connection male faston 6.3mm L 46.5mm ambient temperature max. 125°C mounting distance 22.5mm with plunger type U83161.1 actuating force: 80g lever length 48/42mm | | |





| | | | |
|---|--|-----------------|----------|
|  | | | |
| 1 | | | |
| Part No. | 345529 | Ref. No. | CEMP12CS |
| description | microswitch with lever connection male faston | | |
| For models: | DUE AQ, DUE AT, JOLLY AQ, JOLLY AT, JOLLY Q, JOLLY T, QUATTRO Q/82, QUATTRO T/82, UNO AQ, UNO AT, UNO Q, UNO T | | |

| | | | |
|---|--------------------------|-----------------|-----------|
|  | | | |
| 1 | | | |
| Part No. | 345561 | Ref. No. | CEMP62PS3 |
| description | microswitch | | |
| For models: | SEI 1P, SEI 2P, SEI 2P/S | | |

| | | | |
|---|---|-----------------|----------|
|  | | | |
| 1 | | | |
| Part No. | 345560 | Ref. No. | CEMP62PS |
| description | microswitch with lever connection male faston | | |
| For models: | SEI 1P, SEI 2P, SEI 2P/S | | |

| | | | |
|---|---|-----------------|--------|
| <p>pin-plunger actuated</p>  | | | |
| 1 | | | |
| Part No. | 345528 | Ref. No. | CEMP12 |
| description | microswitch 250V 4A 1CO connection male faston 6.3mm ambient temperature max. 125°C mounting distance 22mm with plunger white | | |
| For models: | QUATTRO Q/82, QUATTRO T/82 | | |

| | | | |
|---|---|-----------------|----------|
|  | | | |
| 1 | | | |
| Part No. | 347847 | Ref. No. | CEMP12SM |
| description | microswitch with plunger 250V 4A 1CO connection male faston 6.3mm ambient temperature max. 125°C mounting distance 22.2mm type U83161.1 actuating force: 240g white | | |





| | | | |
|---|---|-----------------|----------------------------------|
| <p>non-standard</p>  | | | |
| 1 | | | |
| Part No. | 346888 | Ref. No. | CESMP61SC |
| description | microswitch with push button mounting distance 97mm 250V 16A 3CO connection male faston 6.3mm L 32mm ambient temperature max. 125°C type VRSR01DA1 actuating force: 1000g | | |
| accessories for | 346888 | | |
|  | Part No. | 346939 | Ref. No. CETAM62PS |
| | push button for microswitch | | |
|  | Part No. | 346940 | Ref. No. 18010943 CEMMP6S |
| | compression spring ø 9mm L 19mm wire gauge ø 0.7mm for micro-switch | | |
|  | Part No. | 346941 | Ref. No. CEMP6S |
| | bolt for microswitch thread M5x0.75 L 60mm ø 6mm | | |
|  | Part No. | 346943 | Ref. No. CEAZM62PS |
| | pressure plate for microswitch | | |



accessories



1

| | | | |
|---|--|-----------------|--------------------------------------|
| Part No. | 507402 | Ref. No. | CEMP1823 CEMP1823B CEMP1823BGR |
| description | actuator for microswitch thread 3/8" L 105mm complete ID ø 12mm ED ø 32mm | | |
| spare parts for | 507402 | | |
|  | Part No. | 507038 | Ref. No. CEMP20 |
| description | compression spring ø 8.8mm L 31mm wire gauge ø 0.7mm | | |
|  | Part No. | 507039 | Ref. No. CEMP21 |
| description | door shaft | | |
|  | Part No. | 507040 | Ref. No. CEMP22 |
| description | retaining ring E D1 ø 4mm D2 ø 9mm SS DIN 6799 thickness 0.7mm | | |
| accessories for | 507402 | | |
|  | Part No. | 347533 | Ref. No. — |
| description | microswitch with lever 250V 16A 1NO connection male faston 6.3mm ambient temperature max. 125°C for door lever length 74mm | | |



1

| | | | |
|--------------------|----------------------------|-----------------|--------------------------------|
| Part No. | 507037 | Ref. No. | CEMP18 CEMP18B CEMP18BGR |
| description | back part for microswitch | | |
| For models: | QUATTRO Q/82, QUATTRO T/82 | | |



1

| | | | |
|--------------------|--|-----------------|--------|
| Part No. | 346941 | Ref. No. | CEMP6S |
| description | bolt for microswitch thread M5x0.75 L 60mm ø 6mm | | |



1

| | | | |
|--------------------|----------------------------|-----------------|-------------------|
| Part No. | 507041 | Ref. No. | CEMP23 CEMP23B |
| description | front part for microswitch | | |
| For models: | QUATTRO Q/82, QUATTRO T/82 | | |



1

| | | | |
|--------------------|--|-----------------|----------|
| Part No. | 551057 | Ref. No. | CESMP6SC |
| description | housing with microswitch suitable for IME/Omniwash | | |



1

| | | | |
|--------------------|---------------------|-----------------|----------|
| Part No. | 507032 | Ref. No. | CECSM62P |
| description | lid microswitch box | | |



1

| | | | |
|--------------------|--------------------------------|-----------------|-----------|
| Part No. | 346943 | Ref. No. | CEAZM62PS |
| description | pressure plate for microswitch | | |



1

| | | | |
|--------------------|-----------------------------|-----------------|-----------|
| Part No. | 346939 | Ref. No. | CETAM62PS |
| description | push button for microswitch | | |



1

| | | | |
|--------------------|-----------|-----------------|--------|
| Part No. | 346944 | Ref. No. | CEMPPI |
| description | screw cap | | |

system switches (ROLD)



1

| | | | |
|--------------------|------------------|-----------------|----------|
| Part No. | 345721 | Ref. No. | CETP25SF |
| description | blank cap holder | | |



1



| | | | |
|--------------------|---|-----------------|---------|
| Part No. | 345546 | Ref. No. | CEPUD08 |
| description | momentary switch unit 1CO 250V 16A connection male faston 6.3mm | | |





1

| | | | |
|--------------------|---|-----------------|---------|
| Part No. | 345606 | Ref. No. | CEBP6FD |
| description | momentary switch unit 2CO 250V 16A connection male faston 6.3mm | | |





| | | | |
|---|---|-----------------|-----------------------------|
|  | | | |
| 1 | | | |
| Part No. | 347843 | Ref. No. | CEBPFDCOMP |
| description | momentary switch unit 2NO 250V 16A 2-pole | | |
| accessories for | 347843 | | |
|  | Part No. | 347844 | Ref. No. CETRP2230GR |
| | push button L 25mm W 19.5mm grey | | |

| | | | |
|---|---|-----------------|-------------|
|  | | | |
| 1 | | | |
| Part No. | 347147 | Ref. No. | CETRP2230AR |
| description | push button L 19.5mm W 25mm regeneration orange | | |

| | | | |
|--|---|-----------------|--------------|
|  | | | |
| 1 | | | |
| Part No. | 347134 | Ref. No. | CETRP2230ALV |
| description | push button L 19.5mm W 25mm short/long orange | | |

| | | | |
|---|-----------------------------------|-----------------|------------|
|  | | | |
| 1 | | | |
| Part No. | 346952 | Ref. No. | CETRP2230N |
| description | push button L 25mm W 19.5mm black | | |

| | | | |
|---|-----------------------------------|-----------------|------------|
|  | | | |
| 1 | | | |
| Part No. | 346950 | Ref. No. | CETRP2230V |
| description | push button L 25mm W 19.5mm green | | |

| | | | |
|---|---|-----------------|----------------------------|
|  | | | |
| 1 | | | |
| Part No. | 347844 | Ref. No. | CETRP2230GR |
| description | push button L 25mm W 19.5mm grey | | |
| accessories for | 347844 | | |
|  | Part No. | 347843 | Ref. No. CEBPFDCOMP |
| | momentary switch unit 2NO 250V 16A 2-pole | | |

| | | | |
|---|------------------------------------|-----------------|--------------------------|
|  | | | |
| 1 | | | |
| Part No. | 346951 | Ref. No. | CET2230APS CETRP2230A |
| description | push button L 25mm W 19.5mm orange | | |

| | | | |
|---|---|-----------------|--------------|
|  | | | |
| 1 | | | |
| Part No. | 347135 | Ref. No. | CETRP2230APS |
| description | push button L 25mm W 19.5mm orange drain pump | | |

| | | | |
|---|-------------------------|-----------------|---------|
|  | | | |
| 1 | | | |
| Part No. | 347136 | Ref. No. | CETP25B |
| description | push button ø 23mm blue | | |

| | | | |
|--|---------------------------------|-----------------|----------|
|  | | | |
| 1 | | | |
| Part No. | 347137 | Ref. No. | CETP25BR |
| description | push button ø 23mm blue heating | | |

| | | | |
|---|-----------------------------------|-----------------|----------|
|  | | | |
| 1 | | | |
| Part No. | 347145 | Ref. No. | CETSTBCL |
| description | push button ø 23mm blue programme | | |

| | | | |
|---|---------------------------------|-----------------|-----------|
|  | | | |
| 1 | | | |
| Part No. | 346949 | Ref. No. | CETP25V01 |
| description | push button ø 23mm green ON-OFF | | |





| | | | |
|---|--|-----------------|-----------|
|  | | | |
| 1 | | | |
| Part No. | 347133 | Ref. No. | CETP25VRF |
| description | push button ø 23mm green rinsing warm/cold | | |

| | | | |
|---|-------------------------|-----------------|----------|
|  | | | |
| 1 | | | |
| Part No. | 347141 | Ref. No. | CETP25GR |
| description | push button ø 23mm grey | | |

| | | | |
|---|-------------------------------|-----------------|-----------|
|  | | | |
| 1 | | | |
| Part No. | 347139 | Ref. No. | CETP25GPC |
| description | push button ø 23mm grey cycle | | |

| | | | |
|--|------------------------------------|-----------------|-----------|
|  | | | |
| 1 | | | |
| Part No. | 347144 | Ref. No. | CETP25GPS |
| description | push button ø 23mm grey drain pump | | |

| | | | |
|---|---------------------------------|-----------------|------------|
|  | | | |
| 1 | | | |
| Part No. | 347142 | Ref. No. | CETP25GRRS |
| description | push button ø 23mm grey heating | | |

| | | | |
|---|--------------------------------|-----------------|-----------|
|  | | | |
| 1 | | | |
| Part No. | 347138 | Ref. No. | CETP25G01 |
| description | push button ø 23mm grey ON-OFF | | |

| | | | |
|---|-----------------------------------|-----------------|----------|
|  | | | |
| 1 | | | |
| Part No. | 345523 | Ref. No. | CETSTGCL |
| description | push button ø 23mm grey programme | | |
| For models: | SEI 1P, SEI 2P/S | | |

| | | | |
|---|-----------------------------------|-----------------|-----------|
|  | | | |
| 1 | | | |
| Part No. | 347148 | Ref. No. | CETP25GLV |
| description | push button ø 23mm grey programme | | |

| | | | |
|---|--------------------------------------|-----------------|-----------|
|  | | | |
| 1 | | | |
| Part No. | 347143 | Ref. No. | CETP25GRR |
| description | push button ø 23mm grey regeneration | | |

| | | | |
|--|---|-----------------|-----------|
|  | | | |
| 1 | | | |
| Part No. | 347140 | Ref. No. | CETP25GRF |
| description | push button ø 23mm grey rinsing warm/cold | | |

| | | | |
|---|---------------------------------|-----------------|-----------|
|  | | | |
| 1 | | | |
| Part No. | 346947 | Ref. No. | CETP25APC |
| description | push button ø 23mm orange cycle | | |

| | | | |
|---|--------------------------------------|-----------------|-----------|
|  | | | |
| 1 | | | |
| Part No. | 346948 | Ref. No. | CETP25APS |
| description | push button ø 23mm orange drain pump | | |

1

| | | | |
|--------------------|--|-----------------|--------------|
| Part No. | 347845 | Ref. No. | CETP25ALVUSA |
| description | push button ø 23mm orange NORMAL/HEAVY | | |



1

| | | | |
|--------------------|-------------------------------------|-----------------|-----------|
| Part No. | 347146 | Ref. No. | CETP25ALV |
| description | push button ø 23mm orange programme | | |



1

| | | | |
|--------------------|--|-----------------|----------|
| Part No. | 347132 | Ref. No. | CETP25AR |
| description | push button ø 23mm orange regeneration | | |



1

| | | | |
|--------------------|-------------------------------|-----------------|----------|
| Part No. | 345524 | Ref. No. | CETSTR01 |
| description | push button ø 23mm red ON-OFF | | |
| For models: | SEI 1P, SEI 2P/S | | |



1

| | | | |
|--------------------|---|-----------------|-------------|
| Part No. | 348197 | Ref. No. | CETPED16G01 |
| description | push button size 17x13mm grey 0-1 white | | |



1

| | | | |
|--------------------|--|-----------------|-------------|
| Part No. | 348198 | Ref. No. | CETPED16GRF |
| description | push button size 17x13mm grey cold rinsing white | | |



1

| | | | |
|--------------------|---|-----------------|-------------|
| Part No. | 347846 | Ref. No. | CETPED16GPC |
| description | push button size 17x13mm grey START white | | |





1

| | | | |
|--------------------|--|-----------------|---------|
| Part No. | 345719 | Ref. No. | CEDPU08 |
| description | switch 1CO 250V 16A connection male faston 6.3mm | | |



1

| | | | | |
|---|--|-----------------|------------------------|------------|
| Part No. | 347467 | Ref. No. | CEDPPFD CEDPPFDCOMP | |
| description | switch 2CO 250V 16A 2-pole | | | |
| spare parts for | 347467 | | | |
|  | Part No. | 347098 | Ref. No. | — |
| description | switch 2CO 250V 16A connection male faston 6.3mm | | | |
| accessories for | 347467 | | | |
|  | Part No. | 346950 | Ref. No. | CETRP2230V |
| description | push button L 25mm W 19.5mm green | | | |



1

| | | | |
|--------------------|--|-----------------|----------|
| Part No. | 345651 | Ref. No. | CEDP62PS |
| description | switch 2CO 250V 16A connection male faston 6.3mm | | |
| For models: | SEI 1P, SEI 2P/S | | |

system switches

OMNIWASH

push buttons



1

| | | | |
|--------------------|---|-----------------|-----------|
| Part No. | 347983 | Ref. No. | CETPCBSIM |
| description | push button blue L 24.2mm W 19.2mm H 16.6mm | | |



1

| | | | |
|--------------------|---|-----------------|----------|
| Part No. | 347726 | Ref. No. | CETPCSIM |
| description | push button grey L 24.2mm W 19.2mm H 16.4mm | | |



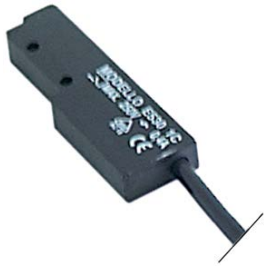

magnetic switches

65x20mm

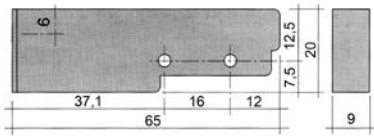

1



| | | | |
|---|--|-----------------|-------------------|
| Part No. | 345116 | Ref. No. | CERD6434 |
| description | magnetic switch L 65mm W 20mm 1NO 250V 0.4A P max. 100W connection cable cable length 3000mm | | |
| accessories for | 345116 | | |
|  | Part No. | 345399 | Ref. No. — |
| | magnet ø 3.3mm L 40mm H 8mm W 13mm hole distance 30mm M3 | | |

accessories

magnets

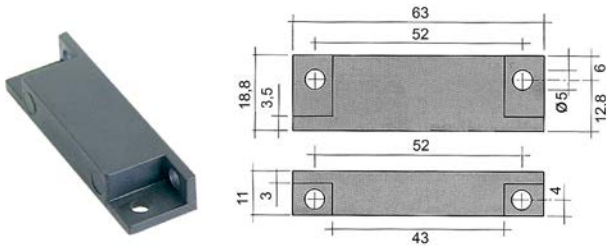

1

| | | | |
|--------------------|---|-----------------|----------|
| Part No. | 345336 | Ref. No. | CERM6444 |
| description | magnet ø 4.8mm L 63mm H 11mm W 18.8mm hole distance 51mm M4 | | |

control equipment

SIEMENS

3SB series ø22mm old

rotary switches



1

| | | | |
|--------------------|---|-----------------|-------------|
| Part No. | 345526 | Ref. No. | CEIN623A4NT |
| description | rotary selector mounting measurements ø22mm sequence 0-1 latching black | | |



1

| | | | |
|--------------------|---|-----------------|----------------------|
| Part No. | 345527 | Ref. No. | CEC6284 CEC6284NT |
| description | rotary selector mounting measurements ø22mm sequence 1-0-2 latching black | | |
| For models: | SEI 2P | | |

3SB series ø22mm new



1

| | | | |
|---|---|-----------------|-------------------|
| Part No. | 346630 | Ref. No. | CECNO6244NT |
| description | contact block SIEMENS 3SB3400-0B 1NO max 400V 10A black | | |
| accessories for | 346630 | | |
|  | Part No. | 347520 | Ref. No. — |
| | push button mounting measurements ø22mm non-illuminated black | | |



1

| | | | |
|--------------------|---|-----------------|--------------------------|
| Part No. | 346631 | Ref. No. | CECNC6294 (from 03/2005) |
| description | contact block SIEMENS 3SB3400-0C 1NC max 400V 10A black | | |

rotary switches



1





| | | | |
|---|---|-----------------|--|
| Part No. | 346601 | Ref. No. | CEIN623A4 |
| description | rotary selector mounting measurements ø22mm black latching sequence 0-1 | | |
| For models: | SEI 2P | | |
| accessories for | 346601 | | |
|  | Part No. | 346602 | Ref. No. — |
| | contact block SIEMENS 3SB3400-0D 2NO max 400V 10A black | | |
|  | Part No. | 346603 | Ref. No. — |
| | contact block SIEMENS 3SB3400-0E 2NC max 400V 10A black | | |
|  | Part No. | 346630 | Ref. No. CECNO6244NT |
| | contact block SIEMENS 3SB3400-0B 1NO max 400V 10A black | | |
|  | Part No. | 346631 | Ref. No. CECNC6294 (from 03/2005) |
| | contact block SIEMENS 3SB3400-0C 1NC max 400V 10A black | | |

Table continues overleaf



| | | | |
|---|---|--------|-----------------|
| accessories for | 346601 | | |
|  | Part No. | 346632 | Ref. No. |
| | | | — |
| | contact block SIEMENS 3SB3400-0D 1NC/1NO max 400V 10A black | | |

lamps

indicator lights

indicator light lenses

ø 6mm (type SQ-20)



1

| | | | |
|--------------------|--|-----------------|-------|
| Part No. | 359803 | Ref. No. | CEGV6 |
| description | indicator light lens green Qty 1 pcs ø 6mm | | |



1

| | | | |
|--------------------|--|-----------------|-------|
| Part No. | 359805 | Ref. No. | CEGA6 |
| description | indicator light lens red Qty 1 pcs ø 6mm | | |

ø10mm (type SRZ-2)



1

| | | | |
|--------------------|---|-----------------|----------|
| Part No. | 359359 | Ref. No. | CESP6224 |
| description | indicator light housings mounting measurements ø10mm green square | | |
| For models: | SEI 2P | | |



1

| | | | |
|--------------------|--|-----------------|----------|
| Part No. | 359358 | Ref. No. | CESP6274 |
| description | indicator light housings mounting measurements ø10mm orange square | | |
| For models: | SEI 2P | | |

ø10mm (type SRZ-3)



1

| | | | |
|---|--|-----------------|-----------------|
| Part No. | 359123 | Ref. No. | CESPE31 |
| description | indicator light housings mounting measurements ø10mm green round Qty 1 pcs | | |
| For models: | DUE ACLQ, DUE ACLT, JOLLY AQ, JOLLY AT, JOLLY Q, JOLLY T, SEI 1P, SEI 2P/S, UNO CLQ, UNO CLT | | |
| accessories for | 359123 | | |
|  | Part No. | 359132 | Ref. No. |
| | | | CESP27V |
| | indicator lamp green 250V connection male faston 6.3mm protection IP54 ambient temperature max. 85°C | | |



1

| | | | |
|--------------------|--|-----------------|---------|
| Part No. | 359124 | Ref. No. | CESPE32 |
| description | indicator light housings mounting measurements ø10mm yellow round Qty 1 pcs | | |
| For models: | DUE ACLQ, DUE ACLT, JOLLY AQ, JOLLY AT, JOLLY Q, JOLLY T, SEI 1P, SEI 2P/S, UNO CLQ, UNO CLT | | |

| | | | |
|---|--|--------|-----------------|
| accessories for | 359124 | | |
|  | Part No. | 359132 | Ref. No. |
| | | | CESP27V |
| | indicator lamp green 250V connection male faston 6.3mm protection IP54 ambient temperature max. 85°C | | |

indicator lamps for socket type SQ



1

| | | | |
|--------------------|--|-----------------|--------|
| Part No. | 359109 | Ref. No. | CESPV6 |
| description | indicator lamp 230V green connection male faston 6.3mm no lens ø 6mm | | |

| | | | |
|---|--|--------|-----------------|
| accessories for | 359109 | | |
|  | Part No. | 359806 | Ref. No. |
| | | | — |
| | indicator light lens clear Qty 1 pcs ø 6mm | | |



1

| | | | |
|--------------------|--|-----------------|--------|
| Part No. | 359110 | Ref. No. | CESPA6 |
| description | indicator lamp 230V white connection male faston 6.3mm no lens ø 6mm | | |

indicator lamps for socket type SRZ / SDK / SDY / SFK



1

| | | | |
|--------------------|--|-----------------|--------|
| Part No. | 359130 | Ref. No. | CESP27 |
| description | indicator lamp 230V clear connection male faston 6.3mm ø 8mm | | |
| For models: | DUE ACLQ, DUE ACLT, JOLLY AQ, JOLLY AT, JOLLY Q, JOLLY T, SEI 1P, SEI 2P/S, UNO CLQ, UNO CLT | | |



1

| | | | |
|--------------------|---|-----------------|----------|
| Part No. | 359129 | Ref. No. | CESP6394 |
| description | indicator lamp 24V clear connection male faston 6.3mm | | |
| For models: | SEI 2P | | |



1

| | | | |
|--------------------|--|-----------------|---------|
| Part No. | 359132 | Ref. No. | CESP27V |
| description | indicator lamp green 250V connection male faston 6.3mm protection IP54 ambient temperature max. 85°C | | |



indicator lights (complete)

30x22mm

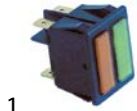

1

| | | | |
|--------------------|---|-----------------|-------------------|
| Part No. | 301138 | Ref. No. | CESDAV CESPDAV |
| description | indicator light mounting measurements 30x22mm 230V red/green connection male faston 6.3mm temp.-resist. 125/55°C type RL2 | | |
| For models: | DUE AQ, DUE AT, QUATTRO Q/82, QUATTRO T/82, UNO AQ, UNO AT, UNO Q, UNO T | | |

blank elements



1

| | | | |
|--------------------|--------|-----------------|----------|
| Part No. | 359784 | Ref. No. | CESB6334 |
| description | bezel | | |
| For models: | SEI 2P | | |



1

| | | | |
|--------------------|--------|-----------------|----------|
| Part No. | 359787 | Ref. No. | CESB6384 |
| description | bezel | | |
| For models: | SEI 2P | | |



1

| | | | |
|--------------------|--------------|-----------------|----------|
| Part No. | 359778 | Ref. No. | CESB6194 |
| description | bezel boiler | | |
| For models: | SEI 2P | | |



1

| | | | |
|--------------------|---------------------|-----------------|----------|
| Part No. | 359781 | Ref. No. | CESB6304 |
| description | bezel cycle 1-short | | |
| For models: | SEI 2P | | |



1

| | | | |
|--------------------|----------------------|-----------------|----------|
| Part No. | 359783 | Ref. No. | CESB6324 |
| description | bezel cycle 2-medium | | |
| For models: | SEI 2P | | |



1

| | | | |
|--------------------|--------------------|-----------------|----------|
| Part No. | 359782 | Ref. No. | CESB6314 |
| description | bezel cycle 3-long | | |
| For models: | SEI 2P | | |



1

| | | | |
|--------------------|---------|-----------------|----------|
| Part No. | 359777 | Ref. No. | CESB6184 |
| description | bezel O | | |
| For models: | SEI 2P | | |



1

| | | | |
|--------------------|--------------------|-----------------|----------|
| Part No. | 359776 | Ref. No. | CEGV2329 |
| description | bezel ø 10mm cycle | | |
| For models: | SEI 1P, SEI 2P/S | | |



1

| | | | |
|--------------------|---------------------|-----------------|----------|
| Part No. | 359773 | Ref. No. | CEGA2328 |
| description | bezel ø 10mm ON-OFF | | |
| For models: | SEI 1P, SEI 2P/S | | |



1

| | | | |
|--------------------|-------------------|-----------------|----------|
| Part No. | 359774 | Ref. No. | CEGV2307 |
| description | bezel ø 10mm tank | | |
| For models: | SEI 2P/S | | |



1

| | | | |
|--------------------|-------------------------------------|-----------------|----------|
| Part No. | 359775 | Ref. No. | CEGV2320 |
| description | bezel ø 13mm boiler mounting ø 10mm | | |
| For models: | SEI 1P, SEI 2P/S | | |





1

| | | | |
|--------------------|----------|-----------------|----------|
| Part No. | 359780 | Ref. No. | CESB6264 |
| description | bezel on | | |
| For models: | SEI 2P | | |



| | | | |
|--|---------------|-----------------|----------|
|  <p>1</p> | | | |
| Part No. | 359785 | Ref. No. | CESB6344 |
| description | bezel rinsing | | |
| For models: | SEI 2P | | |

| | | | |
|--|------------|-----------------|----------|
|  <p>1</p> | | | |
| Part No. | 359779 | Ref. No. | CESB6204 |
| description | bezel tank | | |
| For models: | SEI 2P | | |

| | | | |
|--|---------------|-----------------|----------|
|  <p>1</p> | | | |
| Part No. | 359786 | Ref. No. | CESB6354 |
| description | bezel washing | | |
| For models: | SEI 2P | | |

timers



programme timers

| | | | |
|--|--------|-----------------|--------|
|  <p>1</p> | | | |
| Part No. | 360226 | Ref. No. | CETR24 |
| description | timer | | |

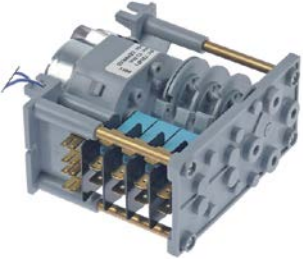

| | | | |
|--|--|-----------------|----------|
|  <p>1</p> | | | |
| Part No. | 360220 | Ref. No. | CETF150J |
| description | timer CDC 11803 engines 1 chambers 3 operation time 150s | | |

| | | | |
|---|---|-----------------|----------|
|  <p>1</p> | | | |
| Part No. | 360560 | Ref. No. | CEPRI150 |
| description | timer CDC 7804F engines 1 chambers 4 operation time 12min 230V 50Hz shaft ømm shaft Lmm manif. no. 7804 motor type M37RN voltage AC | | |

| | | | |
|---|---|-----------------|-------------|
|  <p>1</p> | | | |
| Part No. | 360689 | Ref. No. | CETD1224BGB |
| description | timer CDC 7805DV engines 2 chambers 5 operation time 40s/4min 230V 50Hz shaft ømm shaft Lmm | | |

| | | | | |
|--|--|-----------------|-----------------|---|
|  <p>1</p> | | | | |
| Part No. | 360216 | Ref. No. | CET2C6S | |
| description | timer CDC 7805DV engines 2 chambers 5 operation time 6s / 135s 230V shaft ømm shaft Lmm manif. no. 7805DV / CET2C6S motor type M37RN/M37LN | | | |
| For models: | SEI 2P/S | | | |
| spare parts for | 360216 | | | |
|  | Part No. | 360119 | Ref. No. | — |
| | motor CDC pinion ø 5.4mm teeth 12 230V turn direction right motor ø 37mm motor type M37RN for timer | | | |
|  | Part No. | 360131 | Ref. No. | — |
| | motor CDC pinion ø 5.4mm teeth 12 230V turn direction left motor ø 37mm motor type M37LN for timer | | | |





| | | | |
|---|--|-----------------|-------------------|
|  | | | |
| 1 | | | |
| Part No. | 360215 | Ref. No. | CET2C61P |
| description | timer CDC 7805DV engines 2 chambers 5 operation time 6s / 3min 230V shaft ømm shaft Lmm motor type M37RN/M37LN | | |
| For models: | SEI 1P | | |
| spare parts for | 360215 | | |
|  | Part No. | 360119 | Ref. No. — |
| motor CDC pinion ø 5.4mm teeth 12 230V turn direction right motor ø 37mm motor type M37RN for timer | | | |
|  | Part No. | 360131 | Ref. No. — |
| motor CDC pinion ø 5.4mm teeth 12 230V turn direction left motor ø 37mm motor type M37LN for timer | | | |



| | | | |
|---|--|-----------------|-----------|
|  | | | |
| 1 | | | |
| Part No. | 360451 | Ref. No. | CET2C65GB |
| description | timer CDC 7806DV engines 2 chambers 6 230V 50Hz manuf. no. 7806DV / CET2C65GB motor type M37RN/M37LN run-time 6/135s | | |

| | | | |
|---|--|-----------------|-----------|
|  | | | |
| 1 | | | |
| Part No. | 360561 | Ref. No. | CET2C6S08 |
| description | timer CDC 7806DV engines 2 chambers 6 operation time 6s / 2min 230V 50Hz shaft ømm shaft Lmm manuf. no. 7806DV motor type M37R/M37L voltage AC | | |

| | | | |
|---|--|-----------------|------------|
|  | | | |
| 1 | | | |
| Part No. | 360452 | Ref. No. | CET2C61PGB |
| description | timer CDC 7806DV engines 2 chambers 6 operation time 6s / 3min 230V 50Hz shaft ømm shaft Lmm manuf. no. 7806DV / CET2C61PGB motor type M37RN/M37LN | | |

| | | | |
|---|---|-----------------|--------------------------------|
|  | | | |
| 1 | | | |
| Part No. | 360217 | Ref. No. | CET3C4SC CET3C6 CET3C6NT |
| description | timer CDC 7807DV engines 2 chambers 7 operation time 6s / 3min 24V manuf. no. 7807DV motor type M37RN/M37LN | | |
| For models: | SEI 2P | | |
| spare parts for | 360217 | | |
|  | Part No. | 360324 | Ref. No. — |
| motor CDC pinion ø 5.4mm teeth 12 24V voltage AC turn direction right motor ø 37mm motor type M37RN | | | |
|  | Part No. | 360325 | Ref. No. — |
| motor CDC pinion ø 5.4mm teeth 12 24V voltage AC turn direction left motor ø 37mm motor type M37LN | | | |

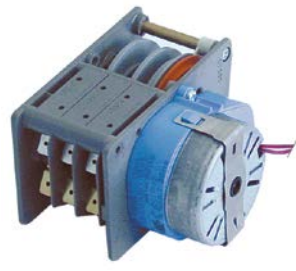
| | | | |
|---|---|-----------------|---------|
|  | | | |
| 1 | | | |
| Part No. | 360692 | Ref. No. | CEPSTFB |
| description | timer CDC CEPSTFB engines 1 chambers 2 operation time 180s 230V shaft ømm shaft Lmm manuf. no. 7802F10AEE000.0000 motor type M37R | | |
| For models: | QUATTRO Q/82, QUATTRO T/82 | | |

| | | | |
|--|--|-----------------|-------------------|
|  | | | |
| 1 | | | |
| Part No. | 360219 | Ref. No. | CETF12 |
| description | timer FIBER P25 engines 1 chambers 3 operation time 120s 230V shaft ømm shaft Lmm manuf. no. P255J03H3C1 motor type M51B-JOR6400 | | |
| spare parts for | 360219 | | |
|  | Part No. | 360673 | Ref. No. — |
| motor kit pinion ø 6.8mm teeth 15 230V voltage AC 50/60Hz turn direction clockwise motor ø 48mm H 18.5mm motor type UDS-40NE1RNZ165 cable length 150mm with holder | | | |





1

| | | | |
|---|--|-----------------|------------------------|
| Part No. | 360249 | Ref. No. | CETF150J CETF150J05 |
| description | timer FIBER P25 engines 1 chambers 3 operation time 150s 230V shaft ømm shaft Lmm manif. no. P255J03H4U7 motor type M51B-J0R6400 / 230V | | |
| For models: | JOLLY AQ, JOLLY AT, JOLLY Q, JOLLY T | | |
| spare parts for | 360249 | | |
|  | Part No. | 360673 | Ref. No. — |
| | motor kit pinion ø 6.8mm teeth 15 230V voltage AC 50/60Hz turn direction clockwise motor ø 48mm H 18.5mm motor type UDS-40NE1RNZ165 cable length 150mm with holder | | |



1

| | | | |
|---|--|-----------------|-------------------|
| Part No. | 360548 | Ref. No. | CETF24 |
| description | timer FIBER P25 engines 1 chambers 3 operation time 4min 230V shaft ømm shaft Lmm manif. no. P255J03H6Y3 | | |
| spare parts for | 360548 | | |
|  | Part No. | 360673 | Ref. No. — |
| | motor kit pinion ø 6.8mm teeth 15 230V voltage AC 50/60Hz turn direction clockwise motor ø 48mm H 18.5mm motor type UDS-40NE1RNZ165 cable length 150mm with holder | | |



1

| | | | |
|--------------------|---|-----------------|--------|
| Part No. | 360228 | Ref. No. | CEPSTF |
| description | timer FIBER P26 engines 1 chambers 2 operation time 180s 230V shaft ømm shaft Lmm manif. no. P265J02H545 motor type M61B40R6400 | | |



1

| | | | |
|--------------------|--|-----------------|-------------------|
| Part No. | 360221 | Ref. No. | CETF20 CETR20B |
| description | timer FIBER P26 engines 1 chambers 3 operation time 20min 230V shaft ømm shaft Lmm manif. no. P265J03L147 motor type M61B40R6400 | | |



1

| | | | |
|--------------------|---|-----------------|---------|
| Part No. | 360559 | Ref. No. | CETF12B |
| description | timer FIBER P26 engines 1 chambers 3 operation time 2min 230V shaft ømm shaft Lmm motor type M61B40R0000 type P265J03H346 | | |



1

| | | | |
|--------------------|--|-----------------|---------|
| Part No. | 360227 | Ref. No. | CETR24B |
| description | timer FIBER P26 engines 1 chambers 3 operation time 4min 230V shaft ø 6x4.6mm shaft L 19mm manif. no. P265J03H650 motor type M61B40L6400 | | |
| For models: | QUATTRO Q/82, QUATTRO T/82 | | |



1

| | | | |
|--------------------|---|-----------------|---------|
| Part No. | 360222 | Ref. No. | CETF24B |
| description | timer FIBER P26 engines 1 chambers 3 operation time 4min 230V shaft ømm shaft Lmm manif. no. P265J03H649 motor type M61B40R6400 | | |
| For models: | QUATTRO Q/82, QUATTRO T/82 | | |



spare parts and accessories

miscellaneous



1

| | | | |
|--------------------|--------|-----------------|-------------------|
| Part No. | 360229 | Ref. No. | CETF60 CETF60S |
| description | plug | | |
| For models: | SEI 2P | | |

contactors

ISKRA (FANAL)

power contactors



1

| | | | |
|--------------------|--|-----------------|--------|
| Part No. | 380415 | Ref. No. | TEBOFA |
| description | power contactor resistive load 16A 230VAC (AC3/400V) 8.5A/5.5kW main contacts 3NO auxiliary contacts 1NC connection male faston 6.3mm type Fanal DSL7 01 type ISKRA K07MF 01 | | |



1

| | | | |
|--------------------|--|-----------------|------|
| Part No. | 380212 | Ref. No. | CECT |
| description | power contactor resistive load 20A 230VAC (AC3/400V) 8.5A/5.5kW main contacts 3NO auxiliary contacts 1NC connection screw connection type Fanal K07M 01 type ISKRA DSL7 01 | | |



1

| | | | |
|--------------------|---|-----------------|---------|
| Part No. | 380411 | Ref. No. | CECT24P |
| description | power contactor resistive load 20A 24VAC (AC3/400V) 8.5A/5.5kW main contacts 3NO auxiliary contacts 1NC connection screw connection type Fanal DSL7 10 type ISKRA K07M 01 | | |
| For models: | SEI 2P | | |



1

| | | | |
|--------------------|--|-----------------|---------|
| Part No. | 380204 | Ref. No. | CECT24G |
| description | power contactor resistive load 25A 230VAC (AC3/400V) 9A/4kW main contacts 3NO auxiliary contacts 1NO connection screw connection type Fanal DSL9 10 type ISKRA KNL9 10 | | |
| For models: | SEI 2P | | |



1

| | | | |
|--------------------|---|-----------------|-----------|
| Part No. | 380420 | Ref. No. | CER16A2NO |
| description | power contactor resistive load 25A 24VAC (AC3/400V) 9A/4kW main contacts 3NO auxiliary contacts 1NO connection screw connection type Fanal DSL9 10 type ISKRA KNL9 10 | | |

SIEMENS

power contactors



1

| | | | |
|--------------------|---|-----------------|--------------------|
| Part No. | 380529 | Ref. No. | CECTF CER16A2NO |
| description | power contactor resistive load 16A 230VAC (AC3/400V) 8.4A/4kW main contacts 3NO auxiliary contacts 1NC connection male faston 6.3mm type 3TG10-01-1A2L2 | | |
| For models: | DUE AQ, DUE AT, JOLLY AQ, JOLLY AT, JOLLY Q, JOLLY T, QUATTRO Q/82, QUATTRO T/82, SEI 1P, SEI 2P/S, UNO AQ, UNO AT, UNO Q, UNO T | | |



relays

relay sockets

| | | | |
|---|------------------|-----------------|---------|
|  | | | |
| 1 | | | |
| Part No. | 360230 | Ref. No. | CETF60A |
| description | base | | |
| For models: | SEI 2P, SEI 2P/S | | |

transformers

open transformers

with clamp terminal

| | | | |
|---|--|-----------------|---------------------|
|  | | | |
| 1 | | | |
| Part No. | 400134 | Ref. No. | CETRS24 CETRS24E |
| description | transformer primary 230/400VAC secondary 24VAC 100VA secondary 5A H 95mm L 85mm W 85mm connection screw 50/60Hz type USE10BB | | |
| For models: | SEI 2P | | |

electronic controllers

ELIWELL

refrigeration controllers

built-in version 2-piece

| | | | |
|---|---|-----------------|---------|
|  | | | |
| 1 | | | |
| Part No. | 379398 | Ref. No. | TKS0312 |
| description | keypad unit ELIWELL type IS972LX model IS23DI0XCD000 mounting measurements 71x29mm 230V voltage AC relay outputs DI built-in depth 30mm °C display 3½ digits | | |
| accessories for | 379398 | | |
| | Part No. | Ref. No. | — |
| | 379533 | | |
| | load module ELIWELL type EWEM233 model DS34000DC700 mounting measurements 70x85mm 230V voltage AC NTC/PTC relay outputs 3 NO-15A(12) CO-10A(7) NO-16A(8) NTC/PTC NTC/PTC front measurements 70mm built-in depth 61mm protection IPx0 yes -55 up to +150°C display | | |
| | Part No. | Ref. No. | — |
| | 379534 | | |
| | connection cable type EC0000110 connection RJ45 L 1000mm for ELIWELL/universal | | |

probes

producer-specific probes

| | | | |
|--|---|-----------------|------------------|
|  | | | |
| 1 | | | |
| Part No. | 379823 | Ref. No. | CESTVBJ CESTM |
| description | temperature probe PTC 2kOhm cable PTFE probe -50 up to +150°C cable -40 up to +250°C connection plug thread probe ø6.5x25mm cable length 1.5m | | |

electronics

PCBs

| | | | |
|--|--|-----------------|-----------------------|
|  | | | |
| 1 | | | |
| Part No. | 403121 | Ref. No. | CEMTEM2BT CETEM2BT |
| description | keypad PCB dishwasher L 126mm W 22mm buttons 3 | | |

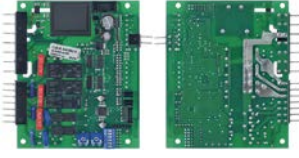
| | | | |
|---|--|-----------------|--------------|
|  | | | |
| 1 | | | |
| Part No. | 403772 | Ref. No. | CESEMM3500ST |
| description | main PCB dishwasher 3500ST L 122mm W 100mm | | |

keypads

front foils

| | | | |
|--|---|-----------------|-------------------------|
|  | | | |
| 1 | | | |
| Part No. | 519538 | Ref. No. | CETSHILTA4 TAORHIS42 |
| description | front foil grey/black suitable for IME L 585mm W 55mm | | |

control panel

| | | | |
|--|---|-----------------|----------------------------|
|  | | | |
| 1 | | | |
| Part No. | 502253 | Ref. No. | CEPC6214P1 CEPC6214P105 |
| description | control panel warewashing L 310mm W 133mm H 7mm black | | |



1

| | | | |
|--------------------|--|-----------------|-----------|
| Part No. | 511639 | Ref. No. | CEPC6214S |
| description | switch panel dishwasher L 312mm W 132mm blue suitable for IME/Omniwash | | |



1

| | | | |
|--------------------|--|-----------------|-------------|
| Part No. | 512435 | Ref. No. | CEPC6214S05 |
| description | switch panel dishwasher L 312mm W 132mm grey suitable for IME/Omniwash | | |



1

| | | | |
|--------------------|--|-----------------|------------|
| Part No. | 511686 | Ref. No. | CEPC621405 |
| description | switch panel for dishwasher L 312mm W 132mm suitable for IME/Omniwash grey | | |

accessories



1

| | | | |
|--------------------|---|-----------------|-------------|
| Part No. | 347147 | Ref. No. | CETRP2230AR |
| description | push button L 19.5mm W 25mm regeneration orange | | |





1

| | | | |
|--------------------|---|-----------------|--------------|
| Part No. | 347134 | Ref. No. | CETRP2230ALV |
| description | push button L 19.5mm W 25mm short/long orange | | |



1

| | | | |
|---|---|-----------------|-----------------------------|
| Part No. | 347844 | Ref. No. | CETRP2230GR |
| description | push button L 25mm W 19.5mm grey | | |
| accessories for | 347844 | | |
|  | Part No. | 347843 | Ref. No. CEPBPFDCOMP |
| | momentary switch unit 2NO 250V 16A 2-pole | | |



1

| | | | |
|--------------------|---|-----------------|--------------|
| Part No. | 347135 | Ref. No. | CETRP2230APS |
| description | push button L 25mm W 19.5mm orange drain pump | | |

solenoid valves

solenoid valves (water)

RPE



1

| | | | |
|--------------------|--|-----------------|---------|
| Part No. | 374054 | Ref. No. | CEEV124 |
| description | solenoid valve single straight 24V inlet 3/4" outlet 11.5mm DN10 | | |
| For models: | SEI 2P | | |

solenoid valves with reducers

















3-fold







1

| | | | |
|--------------------|---|-----------------|-------|
| Part No. | 370240 | Ref. No. | CEEV3 |
| description | solenoid valve triple straight 230VAC inlet 3/4" outlet 11.5mm t.max. 90°C RPE plastic output B 0.32-0.42l/min flow regulating valve outlet B green | | |
| For models: | DUE AQ, QUATTRO Q/82, QUATTRO T/82, UNO AQ, UNO Q | | |









| TP | | | |
|---|---|-----------------|------------|
|   1 | | | |
| Part No. | 370021 | Ref. No. | CEEV2 |
| description | solenoid valve double straight 230VAC inlet 3/4" outlet 11.5mm DN10 TP flow regulating valve inlet white | | |
| For models: | DUE ACLQ, DUE ACSQ, DUE AQ, JOLLY AQ, JOLLY AT, JOLLY Q, JOLLY T, QUATTRO Q/82, QUATTRO T/82, UNO AQ, UNO CLQ, UNO CSQ, UNO Q | | |
| spare parts for | 370021 | | |
|  | Part No. | 371013 | Ref. No. — |
| | solenoid coil TP 230VAC 50/60Hz | | |
| accessories for | 370021 | | |
|  | Part No. | 371220 | Ref. No. — |
| | reducer TP flow rate 3l/min red tolerance ±15% | | |
|  | Part No. | 371221 | Ref. No. — |
| | reducer TP flow rate 5.5l/min yellow tolerance ±15% | | |
|  | Part No. | 371222 | Ref. No. — |
| | reducer TP flow rate 6l/min grey tolerance ±15% | | |
|  | Part No. | 371223 | Ref. No. — |
| | reducer TP flow rate 10l/min white tolerance ±15% | | |
|  | Part No. | 371224 | Ref. No. — |
| | reducer TP flow rate 12l/min bronze tolerance ±15% | | |
|  | Part No. | 371225 | Ref. No. — |
| | reducer TP flow rate 16l/min light brown tolerance ±15% | | |
|  | Part No. | 371226 | Ref. No. — |
| | reducer TP flow rate 20l/min red tolerance ±15% | | |
|  | Part No. | 371230 | Ref. No. — |
| | reducer TP flow rate 0.25l/min red tolerance ±25% | | |
|  | Part No. | 371231 | Ref. No. — |
| | reducer TP flow rate 0.35l/min violet tolerance ±25% | | |
|  | Part No. | 371232 | Ref. No. — |
| | reducer TP flow rate 0.5l/min orange tolerance ±25% | | |
|  | Part No. | 371233 | Ref. No. — |
| | reducer TP flow rate 0.8l/min white tolerance ±25% | | |
|  | Part No. | 371234 | Ref. No. — |
| | reducer TP flow rate 1l/min light blue tolerance ±25% | | |
|  | Part No. | 371235 | Ref. No. — |
| | reducer TP flow rate 1.2l/min brown tolerance ±25% | | |
|  | Part No. | 371236 | Ref. No. — |
| | reducer TP flow rate 1.5l/min light brown tolerance ±25% | | |

| accessories for 370021 | | | |
|---|---|--------|------------|
|  | Part No. | 371237 | Ref. No. — |
| | reducer TP flow rate 2.5l/min yellow tolerance ±25% | | |
|  | Part No. | 371238 | Ref. No. — |
| | reducer TP flow rate 3.4l/min dark green tolerance ±25% | | |
|  | Part No. | 371239 | Ref. No. — |
| | reducer TP flow rate 5l/min black tolerance ±25% | | |
|  | Part No. | 371240 | Ref. No. — |
| | reducer TP flow rate 8l/min blue tolerance ±20% | | |

| TP | | | |
|--|--|-----------------|------------|
|   1 | | | |
| Part No. | 370017 | Ref. No. | CEEV1 |
| description | solenoid valve single straight 230VAC inlet 3/4" outlet 11.5mm DN10 TP p max 10bar | | |
| For models: | QUATTRO Q/82, QUATTRO T/82, SEI 1P, SEI 2P/S | | |
| spare parts for | 370017 | | |
|  | Part No. | 371013 | Ref. No. — |
| | solenoid coil TP 230VAC 50/60Hz | | |
| accessories for | 370017 | | |
|  | Part No. | 371220 | Ref. No. — |
| | reducer TP flow rate 3l/min red tolerance ±15% | | |
|  | Part No. | 371221 | Ref. No. — |
| | reducer TP flow rate 5.5l/min yellow tolerance ±15% | | |
|  | Part No. | 371222 | Ref. No. — |
| | reducer TP flow rate 6l/min grey tolerance ±15% | | |
|  | Part No. | 371223 | Ref. No. — |
| | reducer TP flow rate 10l/min white tolerance ±15% | | |
|  | Part No. | 371224 | Ref. No. — |
| | reducer TP flow rate 12l/min bronze tolerance ±15% | | |
|  | Part No. | 371225 | Ref. No. — |
| | reducer TP flow rate 16l/min light brown tolerance ±15% | | |
|  | Part No. | 371226 | Ref. No. — |
| | reducer TP flow rate 20l/min red tolerance ±15% | | |
|  | Part No. | 371230 | Ref. No. — |
| | reducer TP flow rate 0.25l/min red tolerance ±25% | | |
|  | Part No. | 371231 | Ref. No. — |
| | reducer TP flow rate 0.35l/min violet tolerance ±25% | | |
|  | Part No. | 371232 | Ref. No. — |
| | reducer TP flow rate 0.5l/min orange tolerance ±25% | | |

Table continues overleaf



| accessories for | | 370017 | | |
|--|----------|----------|----------|---|
| Part No. | Ref. No. | Ref. No. | Ref. No. | — |
|  | 371233 | Ref. No. | Ref. No. | — |
| reducer TP flow rate 0.8l/min white tolerance ±25% | | | | |
|  | 371234 | Ref. No. | Ref. No. | — |
| reducer TP flow rate 1l/min light blue tolerance ±25% | | | | |
|  | 371235 | Ref. No. | Ref. No. | — |
| reducer TP flow rate 1.2l/min brown tolerance ±25% | | | | |
|  | 371236 | Ref. No. | Ref. No. | — |
| reducer TP flow rate 1.5l/min light brown tolerance ±25% | | | | |
|  | 371237 | Ref. No. | Ref. No. | — |
| reducer TP flow rate 2.5l/min yellow tolerance ±25% | | | | |
|  | 371238 | Ref. No. | Ref. No. | — |
| reducer TP flow rate 3.4l/min dark green tolerance ±25% | | | | |
|  | 371239 | Ref. No. | Ref. No. | — |
| reducer TP flow rate 5l/min black tolerance ±25% | | | | |
|  | 371240 | Ref. No. | Ref. No. | — |
| reducer TP flow rate 8l/min blue tolerance ±20% | | | | |









| | | | |
|-----------------|--------|-----------------|---------|
| Part No. | 370029 | Ref. No. | CEEV124 |
|-----------------|--------|-----------------|---------|











description solenoid valve single straight 24VAC inlet 3/4" outlet 11.5mm DN10 TP flow regulating valve inlet white

spare parts for 370029

| | | | | |
|---|----------|--------|----------|---|
|  | Part No. | 371035 | Ref. No. | — |
| solenoid coil 24VAC | | | | |

accessories for 370029

| | | | | |
|---|----------|--------|----------|---|
|  | Part No. | 371220 | Ref. No. | — |
| reducer TP flow rate 3l/min red tolerance ±15% | | | | |
|  | Part No. | 371221 | Ref. No. | — |
| reducer TP flow rate 5.5l/min yellow tolerance ±15% | | | | |
|  | Part No. | 371222 | Ref. No. | — |
| reducer TP flow rate 6l/min grey tolerance ±15% | | | | |
|  | Part No. | 371223 | Ref. No. | — |
| reducer TP flow rate 10l/min white tolerance ±15% | | | | |
|  | Part No. | 371224 | Ref. No. | — |
| reducer TP flow rate 12l/min bronze tolerance ±15% | | | | |
|  | Part No. | 371225 | Ref. No. | — |
| reducer TP flow rate 16l/min light brown tolerance ±15% | | | | |
|  | Part No. | 371226 | Ref. No. | — |
| reducer TP flow rate 20l/min red tolerance ±15% | | | | |

| accessories for | | 370029 | | |
|---|----------|----------|----------|---|
| Part No. | Ref. No. | Ref. No. | Ref. No. | — |
|  | 371230 | Ref. No. | Ref. No. | — |
| reducer TP flow rate 0.25l/min red tolerance ±25% | | | | |
|  | 371231 | Ref. No. | Ref. No. | — |
| reducer TP flow rate 0.35l/min violet tolerance ±25% | | | | |
|  | 371232 | Ref. No. | Ref. No. | — |
| reducer TP flow rate 0.5l/min orange tolerance ±25% | | | | |
|  | 371233 | Ref. No. | Ref. No. | — |
| reducer TP flow rate 0.8l/min white tolerance ±25% | | | | |
|  | 371234 | Ref. No. | Ref. No. | — |
| reducer TP flow rate 1l/min light blue tolerance ±25% | | | | |
|  | 371235 | Ref. No. | Ref. No. | — |
| reducer TP flow rate 1.2l/min brown tolerance ±25% | | | | |
|  | 371236 | Ref. No. | Ref. No. | — |
| reducer TP flow rate 1.5l/min light brown tolerance ±25% | | | | |
|  | 371237 | Ref. No. | Ref. No. | — |
| reducer TP flow rate 2.5l/min yellow tolerance ±25% | | | | |
|  | 371238 | Ref. No. | Ref. No. | — |
| reducer TP flow rate 3.4l/min dark green tolerance ±25% | | | | |
|  | 371239 | Ref. No. | Ref. No. | — |
| reducer TP flow rate 5l/min black tolerance ±25% | | | | |
|  | 371240 | Ref. No. | Ref. No. | — |
| reducer TP flow rate 8l/min blue tolerance ±20% | | | | |

pressure switches

for warewashing

ø51 mm with coded plug



| | | | |
|-----------------|--------|-----------------|----------------------------|
| Part No. | 541784 | Ref. No. | CECBCMPR CEPR PRL110 |
|-----------------|--------|-----------------|----------------------------|

description pressure control pressure range 50/20mbar ø 51mm pressure connection horizontal warewashing pressure connection ø 5.5mm at 250V 10A



ø 58mm with male faston 6.3mm
with connection horizontal



1

| | | | |
|--------------------|--|-----------------|------|
| Part No. | 541889 | Ref. No. | CEPR |
| description | pressure control pressure range 50/20mbar connection 6mm ø 58mm | | |
| For models: | DUE AQ, DUE AT, JOLLY AQ, JOLLY AT, JOLLY Q, JOLLY T, QUATTRO Q/82, QUATTRO T/82, UNO AQ, UNO AT, UNO Q, UNO T | | |



1

| | | | |
|--------------------|--|-----------------|-------|
| Part No. | 541165 | Ref. No. | CEPRE |
| description | pressure control pressure range 60/30mbar connection 6mm ø 58mm pressure connection horizontal warewashing pressure connection ø 6mm | | |
| For models: | QUATTRO Q/82, QUATTRO T/82 | | |



1

| | | | |
|--------------------|--|-----------------|---------|
| Part No. | 541959 | Ref. No. | CEPR62P |
| description | pressure control pressure range 90/30mbar connection 6mm ø 58mm pressure connection horizontal warewashing pressure connection ø 6mm | | |

ø 79mm with coded plug



1

| | | | |
|--------------------|---|-----------------|---------|
| Part No. | 541874 | Ref. No. | CEPR2LE |
| description | pressure control 2 pressure ranges pressure range 27/12 41/26mbar connection 6mm ø 79mm warewashing pressure connection ø 6mm | | |

ø 84mm with coded plug



1

| | | | |
|--------------------|---|-----------------|-----------|
| Part No. | 541645 | Ref. No. | CEPRE2LUL |
| description | pressure control 2 pressure ranges pressure range 45/20 65/47mbar connection 6mm ø 84mm pressure connection ø 6mm | | |

pumps

wash and rinse pumps

ALBA (C&A)

pumps



1









| | | | |
|---|--|-----------------|-------------------------|
| Part No. | 500938 | Ref. No. | EP25CPG EP30 |
| description | pump inlet ø 30mm outlet ø 30mm type IM1629030 230V 50Hz 1 phase 0.22kW 0.3HP L 175mm rotation direction right capacitor 10µF auxiliary pressure connection 10mm supporting pressure open ALBA PUMPS (C&A) | | |
| For models: | JOLLY AQ, JOLLY AT, JOLLY Q, JOLLY T, UNO AQ, UNO AT, UNO Q, UNO T | | |
| spare parts for | 500938 | | |
|  | Part No. | 507065 | Ref. No. EP251TP |
| | pump cover | | |
|  | Part No. | 509018 | Ref. No. — |
| | O-ring EPDM thickness 3.53mm ID ø 107.5mm Qty 1 pcs | | |
|  | Part No. | 509028 | Ref. No. — |
| | impellor ø 87mm H 21mm rotation direction right thread M7L shaft ø 12mm | | |
|  | Part No. | 510693 | Ref. No. — |
| | mechanical shaft seal for shaft ø 12mm slide ring ext. ø 24mm slide ring H 15.5mm slide ring int. ø 11mm counter ring mounting ø 24mm height counter ring 8mm counter ring int. ø 13.5mm | | |

Table continues overleaf



| | | | |
|---|--|-----------------|--------|
| accessories for | 500938 | | |
| Part No. | 365014 | Ref. No. | CECN12 |
|  | operating capacitor capacity 12.5µF 450V tolerance 5%Hz ambient temperature max. -25 to +85°C ø 35mm L 70mm M8 plastic connection male faston 6.3mm 45S.C3DS.12.5 protection | | |









| | | | |
|---|--|-----------------|------------------------|
| Part No. | 500941 | Ref. No. | EP50CPG EP60 |
| description | pump inlet ø 30mm outlet ø 30mm type IM32591 230V 50Hz 1 phase 0.45kW 0.6HP L 200mm rotation direction right capacitor 12.5µF auxiliary pressure connection 11mm supporting pressure open ALBA PUMPS (C&A) | | |
| For models: | DUE AQ, DUE AT | | |
| spare parts for | 500941 | | |
|  | Part No. | 365014 | Ref. No. CECN12 |
| | operating capacitor capacity 12.5µF 450V tolerance 5%Hz ambient temperature max. -25 to +85°C ø 35mm L 70mm M8 plastic connection male faston 6.3mm 45S.C3DS.12.5 protection | | |
|  | Part No. | 509018 | Ref. No. — |
| | O-ring EPDM thickness 3.53mm ID ø 107.5mm Qty 1 pcs | | |
|  | Part No. | 510692 | Ref. No. — |
| | mechanical shaft seal for shaft ø 11mm slide ring ext. ø 24mm slide ring H 13mm counter ring mounting ø 26mm height counter ring 8mm counter ring int. ø 14mm | | |

FIR

pumps



| | | | |
|---|--|-----------------|-------------------|
| Part No. | 499137 | Ref. No. | ABPRF5213 |
| description | pump inlet ø 30mm outlet ø 26mm type 5213E2452 220/240V 50Hz 1 phase 0.07kW 0.1HP L 195mm rotation direction left capacitor 5µF FIR | | |
| spare parts for | 499137 | | |
|  | Part No. | 365017 | Ref. No. — |
| | operating capacitor capacity 5µF 450V tolerance 5% 50/60Hz ambient temperature max. -25 to +85°C ø 28mm L 54mm M8 plastic connection male faston 6.3mm 16.10.08 protection | | |
|  | Part No. | 502250 | Ref. No. — |
| | O-ring EPDM thickness 4mm ID ø 74mm Qty 1 pcs | | |
|  | Part No. | 502265 | Ref. No. — |
| | pump cover inlet ø 30mm outlet ø 26mm ID ø 89mm inner height 35mm | | |
|  | Part No. | 510695 | Ref. No. — |
| | mechanical shaft seal height counter ring 5.5mm ID ø 11mm | | |
|  | Part No. | 521203 | Ref. No. — |
| | impeller ø 72mm H 18mm thread M7 shaft ø 11mm shaft length 32mm blades 3 | | |
|  | Part No. | 532718 | Ref. No. — |
| | O-ring EPDM thickness 4mm ID ø 80mm Qty 1 pcs | | |
|  | Part No. | 699372 | Ref. No. — |
| | flange for pump with cover type 5213 L 103mm W 103mm H 69mm | | |

drain pumps

ASKOLL

| | | | |
|--------------------|---------------------------|-----------------|------------|
| Part No. | 500347 | Ref. No. | CEPS031482 |
| description | drain pump 230V 34W | | |
| For models: | QUATTRO Q/82, QUATTROT/82 | | |

1

| | | | |
|--------------------|--|-----------------|--------|
| Part No. | 499340 | Ref. No. | CEPS51 |
| description | drain pump 40W 220-240V inlet ø 30mm outlet ø 22mm 50Hz ASKOLL type M332 | | |



1

| | | | |
|--------------------|---|-----------------|---------|
| Part No. | 500346 | Ref. No. | CEPS031 |
| description | drain pump inlet ø 30mm outlet ø 22mm 230V 40W 50Hz ASKOLL type M231 XP with holder | | |

booster pumps II

accessories



1

| | | | |
|--------------------|--|-----------------|--------|
| Part No. | 365015 | Ref. No. | CECN10 |
| description | operating capacitor capacity 10µF 400V tolerance 5%Hz ambient temperature max. -25 to +85°C ø 35.5mm L 59mm M8 plastic connection male faston 6.3mm protection | | |
| For models: | JOLLY AQ, JOLLY AT, JOLLY Q, JOLLY T, UNO AQ, UNO AT, UNO Q, UNO T | | |

condensators & interference suppression filters

operating capacitors

plastic



1

| | | | |
|--------------------|--|-----------------|--------|
| Part No. | 365015 | Ref. No. | CECN10 |
| description | operating capacitor capacity 10µF 400V tolerance 5%Hz ambient temperature max. -25 to +85°C ø 35.5mm L 59mm M8 plastic connection male faston 6.3mm protection | | |
| For models: | JOLLY AQ, JOLLY AT, JOLLY Q, JOLLY T, UNO AQ, UNO AT, UNO Q, UNO T | | |



1

| | | | |
|--------------------|--|-----------------|--------|
| Part No. | 365014 | Ref. No. | CECN12 |
| description | operating capacitor capacity 12.5µF 450V tolerance 5%Hz ambient temperature max. -25 to +85°C ø 35mm L 70mm M8 plastic connection male faston 6.3mm 45S.C3DS.12.5 protection | | |
| For models: | DUE AQ, DUE AT, QUATTRO Q/82, QUATTRO T/82, SEI 1P, SEI 2P, SEI 2P/S | | |

filters

interference suppression filters



1

| | | | |
|--------------------|--|-----------------|------|
| Part No. | 365046 | Ref. No. | CEFA |
| description | interference suppression filter type 10S7E-G1474253105-Q 115/250V 50/60Hz conductor 2 with E connection male faston 6.3mm L 40mm ø 40mm Hmm Wmm M8 plastic Qty 1 pcs | | |
| For models: | DUE AQ, DUE AT, JOLLY AQ, JOLLY AT, JOLLY Q, JOLLY T, QUATTRO Q/82, QUATTRO T/82, SEI 1P, SEI 2P, SEI 2P/S, UNO AQ, UNO AT, UNO Q, UNO T | | |

fuses

fine fuses



1

| | | | |
|--------------------|---|-----------------|-----------|
| Part No. | 358074 | Ref. No. | CEFU5205A |
| description | fine fuse size ø5x20mm 5A fast-acting rated 250V Qty 10 pcs | | |



fine fuse holders

| | | | |
|---|--------------------------|-----------------|---------|
|  | | | |
| 1 | | | |
| Part No. | 358512 | Ref. No. | CEMFSTR |
| description | fuse holder | | |
| For models: | SEI 1P, SEI 2P, SEI 2P/S | | |

brewing units with solenoid valve

| | | | |
|---|--|-----------------|-------|
| gaskets | | | |
|  | | | |
| 1 | | | |
| Part No. | 532554 | Ref. No. | OR102 |
| description | O-ring silicone thickness 1.5mm ID ø 4.1mm Qty 1 pcs | | |

electric accessories

terminals

connection terminals with screw/faston connections

| | | | |
|---|--|-----------------|-------|
|  | | | |
| 1 | | | |
| Part No. | 550278 | Ref. No. | CEMOS |
| description | power terminal block 3-pole max. 40A max 400V connection ø6mm ² / F6.3 temp.-resist. 150°C cross section 6mm ² | | |

| | | | |
|--|--|-----------------|---------|
|  | | | |
| 1 | | | |
| Part No. | 550411 | Ref. No. | CEMOS3F |
| description | power terminal block 6-pole max. 40A max 450V connection ø6mm ² / F6.3 temp.-resist. 150°C cross section 6mm ² | | |
| For models: | QUATTRO Q/82, QUATTRO T/82, SEI 1P, SEI 2P, SEI 2P/S | | |

steam/water taps

steam/water pipes

accessories

gaskets

| | | | |
|---|--|-----------------|-------|
|  | | | |
| 1 | | | |
| Part No. | 510893 | Ref. No. | OR112 |
| description | O-ring EPDM thickness 2.62mm ID ø 9.92mm Qty 1 pcs | | |
| For models: | JOLLY AQ, JOLLY AT, JOLLY Q, JOLLY T, UNO AQ, UNO AT, UNO Q, UNO T | | |

for tilting bratt pans

spindles

| | | | |
|---|-------------------------------------|-----------------|----------|
|  | | | |
| 1 | | | |
| Part No. | 507405 | Ref. No. | CEPAMP6S |
| description | threaded rod thread M6 L 43mm ø 6mm | | |

for dishwashers

drain and intake components

OMNIWASH

drain /intake bodies

| | | | |
|---|---------------|-----------------|--------|
|  | | | |
| 1 | | | |
| Part No. | | Ref. No. | LI426F |
| description | drain fitting | | |
| For models: | QUATTRO Q/82 | | |

equipment-specific units

for espresso machines

brewing units

filter holder gaskets

O-rings



| | | | |
|---|---|-----------------|----------------|
|  | | | |
| 1 | | | |
| Part No. | 510409 | Ref. No. | GUREBOT ORRB3F |
| description | O-ring EPDM thickness 5.34mm ID ø 56.52mm Qty 1 pcs | | |

| | | | |
|---|--|-----------------|--------------------------|
|  | | | |
| 1 | | | |
| Part No. | 524838 | Ref. No. | GAPS1299B GAPS1299BGR |
| description | drain fitting straight ø 50mm H 68mm thread 1" | | |





| | | | |
|---|-----------------------------------|-----------------|-----------------|
|  | | | |
| 1 | | | |
| Part No. | 507204 | Ref. No. | GS117 GS117B |
| description | drain fitting thread 1" ID ø 25mm | | |

| | | | |
|---|----------------------------------|-----------------|-----------------|
|  | | | |
| 1 | | | |
| Part No. | 507086 | Ref. No. | GA111 GA111B |
| description | intake body thread 1¼" ID ø 30mm | | |

| | | | | |
|---|---|-----------------|-----------------------------|------------------|
|  | | | | |
| 1 | | | | |
| Part No. | 507209 | Ref. No. | GS317 GS317B GS317BGR | |
| description | drain fitting thread 1¼" ID ø 33mm | | | |
| For models: | QUATTRO Q/82, QUATTRO T/82 | | | |
| accessories for | 507209 | | | |
|  | Part No. | 507058 | Ref. No. | DP114 DP114GR |
| | screw connection thread 1¼" H 14mm WS 55 | | | |
|  | Part No. | 507315 | Ref. No. | OR3168 |
| | O-ring EPDM thickness 2.62mm ID ø 42.52mm | | | |



| | | | |
|---|--------|-----------------|------|
|  | | | |
| 1 | | | |
| Part No. | 507059 | Ref. No. | DP14 |
| description | nut | | |



| | | | |
|---|--|-----------------|--------------|
|  | | | |
| 1 | | | |
| Part No. | 507056 | Ref. No. | DP1 DP1GR |
| description | nut thread 1" H 14mm WS 46 ø 52mm | | |
| For models: | DUE ACLQ, DUE ACLT, DUE ACSQ, DUE ACST, DUE AQ, DUE AT, JOLLY AQ, JOLLY AT, JOLLY Q, JOLLY T, UNO ACSQ, UNO ACST, UNO AQ, UNO AT, UNO CLQ, UNO CLT, UNO CSQ, UNO CST, UNO Q, UNO T | | |

| | | | |
|--|------------------------------------|-----------------|--------|
|  | | | |
| 1 | | | |
| Part No. | 507046 | Ref. No. | GA311B |
| description | drain fitting thread 1½" ED ø 38mm | | |

| | | | |
|--|--|-----------------|------------------|
|  | | | |
| 1 | | | |
| Part No. | 507057 | Ref. No. | DP112 DP112GR |
| description | nut thread 1½" H 14mm WS 60 ø 65mm | | |
| For models: | QUATTRO Q/82, QUATTRO T/82, SEI 1P, SEI 2P, SEI 2P/S | | |

| | | | |
|---|--------------|-----------------|-------|
|  | | | |
| 1 | | | |
| Part No. | 507092 | Ref. No. | GA311 |
| description | intake body | | |
| For models: | QUATTRO Q/82 | | |

| | | | | |
|---|--|-----------------|-----------------|--------|
|  | | | | |
| 1 | | | | |
| Part No. | 507314 | Ref. No. | OR3131 | |
| description | O-ring EPDM thickness 2.62mm ID ø 32.99mm | | | |
| For models: | DUE ACLQ, DUE ACLT, DUE ACSQ, DUE ACST, DUE AQ, DUE AT, JOLLY AQ, JOLLY AT, JOLLY Q, JOLLY T, UNO ACSQ, UNO ACST, UNO AQ, UNO AT, UNO CLQ, UNO CLT, UNO CSQ, UNO CST, UNO Q, UNO T | | | |
| accessories for | 507314 | | | |
|  | Part No. | 507314 | Ref. No. | OR3131 |
| | O-ring EPDM thickness 2.62mm ID ø 32.99mm | | | |

| | | | | |
|---|--|-----------------|-------------------|------------------|
|  | | | | |
| 1 | | | | |
| Part No. | 507087 ¹ | Ref. No. | GA111T GA111TB | |
| description | intake body thread 1¼" ED ø 55mm H 30mm | | | |
| For models: | QUATTRO Q/82, QUATTRO T/82 | | | |
| accessories for | 507087 | | | |
|  | Part No. | 507057 | Ref. No. | DP112 DP112GR |
| | nut thread 1½" H 14mm WS 60 ø 65mm | | | |
|  | Part No. | 540222 | Ref. No. | OR3187 |
| | O-ring EPDM thickness 2.62mm ID ø 47.3mm Qty 1 pcs | | | |

| | | | |
|---|--|-----------------|--------|
|  | | | |
| 1 | | | |
| Part No. | 507315 | Ref. No. | OR3168 |
| description | O-ring EPDM thickness 2.62mm ID ø 42.52mm | | |
| For models: | DUE AQ, DUE AT, JOLLY AQ, JOLLY AT, JOLLY Q, JOLLY T, QUATTRO Q/82, QUATTRO T/82, SEI 1P, SEI 2P, SEI 2P/S, UNO AQ, UNO AT, UNO Q, UNO T | | |

¹for drain pump





| | | | |
|--------------------|---|-----------------|--------|
| 1 |  | | |
| Part No. | 540222 | Ref. No. | OR3187 |
| description | O-ring EPDM thickness 2.62mm ID ø 47.3mm Qty 1 pcs | | |
| For models: | QUATTRO Q/82, QUATTRO T/82, SEI 1P, SEI 2P, SEI 2P/S | | |

| | | | |
|--------------------|--|-----------------|------------------|
| 1 |  | | |
| Part No. | 507058 | Ref. No. | DP114 DP114GR |
| description | screw connection thread 1¼" H 14mm WS 55 | | |
| For models: | DUE AQ, DUE AT, JOLLY AQ, JOLLY AT, JOLLY Q, JOLLY T, QUATTRO Q/82, QUATTRO T/82, SEI 1P, SEI 2P, SEI 2P/S, UNO AQ, UNO AT, UNO Q, UNO T | | |

| | | | |
|--------------------|---|-----------------|---------|
| 1 |  | | |
| Part No. | 507237 | Ref. No. | LI430FC |
| description | wash arm support wash arm support | | |
| For models: | QUATTRO Q/82 | | |

filters

| | | | |
|--------------------|---|-----------------|--------|
| 1 |  | | |
| Part No. | 507084 | Ref. No. | GA012C |
| description | bar for filter | | |

| | | | |
|--------------------|---|-----------------|---------|
| 1 |  | | |
| Part No. | 507396 | Ref. No. | GASA12C |
| description | bar for filter L 140mm thread M6 | | |

| | | | |
|--------------------|---|-----------------|------------------------------|
| 1 |  | | |
| Part No. | 507082 | Ref. No. | GA012A GA012B GAGS1299 |
| description | bar for filter L 52mm thread M6 | | |
| For models: | QUATTRO Q/82, QUATTRO T/82 | | |

| | | | |
|--------------------|---|-----------------|------------------|
| 1 |  | | |
| Part No. | 507096 | Ref. No. | GA512 GA5120T |
| description | bar for filter L 74mm thread M6 | | |
| For models: | QUATTRO Q/82 | | |

| | | | |
|--------------------|---|-----------------|--------------------|
| 1 |  | | |
| Part No. | 507098 | Ref. No. | GA6122 GA61220T |
| description | bar for filter L 86mm thread M6 | | |
| For models: | QUATTRO Q/82, QUATTRO T/82, SEI 1P, SEI 2P, SEI 2P/S | | |

| | | | |
|--------------------|---|-----------------|---------|
| 1 |  | | |
| Part No. | 507339 | Ref. No. | GAGS599 |
| description | bar L 50mm thread M5 for filter | | |
| For models: | QUATTRO Q/82, QUATTRO T/82 | | |

| | | | |
|--------------------|--|-----------------|-----------------------|
| 1 |  | | |
| Part No. | 507247 | Ref. No. | LIF4V4TP LIF4V4TPC |
| description | filter | | |

| | | | |
|--------------------|--|-----------------|------------|
| 1 |  | | |
| Part No. | 507338 | Ref. No. | GA115SCOMP |
| description | filter | | |

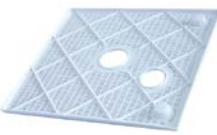
| | | | |
|--------------------|---|-----------------|------------------------|
| 1 |  | | |
| Part No. | 507243 | Ref. No. | LIF12V1P LIF12V1PV0 |
| description | flat filter | | |
| For models: | UNO ACSQ, UNO ACST, UNO AQ, UNO CLQ, UNO CLT, UNO CSQ, UNO CST, UNO Q | | |

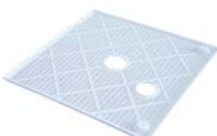
| | | | |
|--------------------|--|-----------------|----------|
| 1 |  | | |
| Part No. | 507244 | Ref. No. | LIF22V1P |
| description | flat filter | | |
| For models: | DUE ACLQ, DUE ACLT, DUE ACSQ, DUE ACST, DUE AQ | | |

| | | | |
|--------------------|---|-----------------|-------------------------|
| 1 |  | | |
| Part No. | 524919 | Ref. No. | LIF4V2PSX04GR REFO40 |
| description | flat filter for dishwasher H 15mm L 540mm W 288mm with hole plastic mounting pos. right | | |



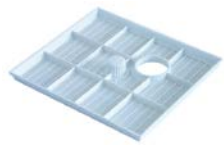

| | | | |
|--|---|-----------------|--------------|
|  <p>1</p> | | | |
| Part No. | 524918 | Ref. No. | LIF4V2PCSX04 |
| description | flat filter for dishwasher H 15mm L 540mm W 288mm without hole plastic mounting pos. left | | |

| | | | |
|--|------------------------------------|-----------------|---|
|  <p>1</p> | | | |
| Part No. | 507246 | Ref. No. | LIF4V4P LIF4V4PL LIF4V4PV0 LIF4V4PV0GR REFI40 |
| description | flat filter H 15mm L 230mm W 200mm | | |
| For models: | QUATTRO Q/82, SEI 1P, SEI 2P/S | | |

| | | | |
|--|--|-----------------|--------------------------|
|  <p>1</p> | | | |
| Part No. | 507248 | Ref. No. | LIF4V4TPP LIF4V4TPPGR |
| description | flat filter H 15mm L 230mm W 200mm with hole | | |
| For models: | QUATTRO Q/82 | | |



| | | | |
|--|--|-----------------|-------------|
|  <p>1</p> | | | |
| Part No. | 519489 | Ref. No. | LIF4V2PDX04 |
| description | flat filter H 15mm L 535mm W 285mm mounting pos. right | | |



| | | | |
|--|---|-----------------|-------------|
|  <p>1</p> | | | |
| Part No. | 519488 | Ref. No. | LIF4V2PSX04 |
| description | flat filter H 15mm L 535mm W 285mm with hole mounting pos. left | | |

| | | | |
|--|-----------------------------------|-----------------|---|
|  <p>1</p> | | | |
| Part No. | 507089 | Ref. No. | GA115RA GA115RAB GA115RABV0 GA115RABV0GR |
| description | flat filter H 27mm L 140mm W 95mm | | |
| For models: | QUATTRO Q/82, QUATTRO T/82 | | |

| | | | |
|---|--|-----------------|---|
|  <p>1</p> | | | |
| Part No. | 507094 | Ref. No. | GA315RA GA315RAV0 GA315RAV0GR GA315RCA |
| description | flat filter H 36mm L 170mm W 135mm | | |
| For models: | QUATTRO Q/82, QUATTRO T/82, SEI 1P, SEI 2P, SEI 2P/S | | |

| | | | |
|---|-----------------------------|-----------------|-------------------|
|  <p>1</p> | | | |
| Part No. | 507245 | Ref. No. | LIF4V4 LIF4V4C |
| description | flat filter L 230mm W 200mm | | |
| For models: | SEI 2P, SEI 2P/S | | |

| | | | | |
|---|---|-----------------|----------------------------|----------------------------------|
|  <p>1</p> | | | | |
| Part No. | 524916 | Ref. No. | GA115RCBV0 GA115RCBV0GR | |
| description | intake filter for dishwasher H 50mm L 140mm W 95mm complete | | | |
| spare parts for | 524916 | | | |
|  | Part No. | 507088 | Ref. No. | GA115R GA115RV0 GA115RV0GR |
| rectangular filter H 50mm L 137mm W 92mm | | | | |
|  | Part No. | 507515 | Ref. No. | GA115RAV0 GA115RAV0GR |
| lid for filter H 10mm L 140mm W 95mm | | | | |

| | | | | |
|---|--------------------------------------|-----------------|--------------------------|----------------------------------|
|  <p>1</p> | | | | |
| Part No. | 507515 | Ref. No. | GA115RAV0 GA115RAV0GR | |
| description | lid for filter H 10mm L 140mm W 95mm | | | |
| accessories for | 507515 | | | |
|  | Part No. | 507088 | Ref. No. | GA115R GA115RV0 GA115RV0GR |
| rectangular filter H 50mm L 137mm W 92mm | | | | |



1

| | | | |
|--------------------|---|-----------------|----------------------------|
| Part No. | 507085 | Ref. No. | GA013 GA013B GA013GR |
| description | nut for filter ED ø 32mm H 10mm thread M6 | | |
| For models: | QUATTRO Q/82, QUATTRO T/82 | | |





2

| | | | |
|--------------------|--------------------|-----------------|---------|
| Part No. | 507100 | Ref. No. | GAPS335 |
| description | rectangular filter | | |



1

| | | | | |
|---|--|-----------------|--|---|
| Part No. | 507362 | Ref. No. | GA315RAV0GR+GA315RVOGR GA315RCB GA315RCBV0 GA315RCBV0GR | |
| description | rectangular filter H 100mm L 170mm W 130mm | | | |
| For models: | QUATTRO Q/82, QUATTRO T/82 | | | |
| spare parts for | 507362 | | | |
|  | Part No. | 507093 | Ref. No. | GA315R GA315RV0 |
| | rectangular filter H 62mm L 168mm W 126mm | | | |
|  | Part No. | 507094 | Ref. No. | GA315RA GA315RAV0 GA315RAV0GR GA315RCA |
| | flat filter H 36mm L 170mm W 135mm | | | |



1

| | | | | |
|---|--|-----------------|----------------------------------|--------------------------|
| Part No. | 507088 | Ref. No. | GA115R GA115RV0 GA115RV0GR | |
| description | rectangular filter H 50mm L 137mm W 92mm | | | |
| For models: | DUE AQ, DUE AT, JOLLY AQ, JOLLY AT, JOLLY Q, JOLLY T, QUATTRO Q/82, QUATTRO T/82, UNO AQ, UNO AT, UNO Q, UNO T | | | |
| accessories for | 507088 | | | |
|  | Part No. | 507515 | Ref. No. | GA115RAV0 GA115RAV0GR |
| | lid for filter H 10mm L 140mm W 95mm | | | |



1

| | | | |
|--------------------|--|-----------------|--------------------|
| Part No. | 507093 | Ref. No. | GA315R GA315RV0 |
| description | rectangular filter H 62mm L 168mm W 126mm | | |
| For models: | QUATTRO Q/82, QUATTRO T/82, SEI 1P, SEI 2P, SEI 2P/S | | |



1

| | | | |
|--------------------|-----------------------------|-----------------|---------|
| Part No. | 507091 | Ref. No. | GA214AT |
| description | round filters H 52mm ø 62mm | | |
| For models: | QUATTRO Q/82, QUATTRO T/82 | | |

overflow pipes



1

| | | | |
|--------------------|---------------|-----------------|--------|
| Part No. | 507217 | Ref. No. | GSSA16 |
| description | overflow pipe | | |



1



| | | | |
|--------------------|------------------------------|-----------------|---|
| Part No. | 507203 | Ref. No. | GS116CCA GS116CC GS116CCAB GS116CCABGR |
| description | overflow pipe L 100mm ø 26mm | | |





1

| | | | |
|--------------------|------------------------------|-----------------|---------|
| Part No. | 507212 | Ref. No. | GS416CC |
| description | overflow pipe L 167mm ø 35mm | | |
| For models: | QUATTRO Q/82, QUATTRO T/82 | | |



| | | | |
|---|------------------------------------|-----------------|-----------|
|  <p>1</p> | | | |
| Part No. | 507410 | Ref. No. | GS416CCAB |
| description | overflow pipe L 167mm ø 35mm | | |
| accessories for | 507410 | | |
|  <p>Part No. 507209 Ref. No. GS317 GS317B GS317BGR</p> | | | |
| description | drain fitting thread 1¼" ID ø 33mm | | |

| | | | |
|--|------------------------------|-----------------|-------------|
|  <p>1</p> | | | |
| Part No. | 524836 | Ref. No. | GS416CCABGR |
| description | overflow pipe L 170mm ø 34mm | | |

| | | | |
|--|------------------------------|-----------------|--------------------------|
|  <p>1</p> | | | |
| Part No. | 507214 | Ref. No. | GS6013 GS6013B GS6013BGR |
| description | overflow pipe L 190mm ø 33mm | | |

| | | | |
|--|------------------------------|-----------------|-----------|
|  <p>1</p> | | | |
| Part No. | 507408 | Ref. No. | GSSA16PLB |
| description | overflow pipe L 205mm ø 33mm | | |

containers

container lids

| | | | |
|--|--|-----------------|-------|
|  <p>1</p> | | | |
| Part No. | 507020 | Ref. No. | AM030 |
| description | container lid suitable for rinse aid container | | |
| For models: | DUE AQ, DUE AT, QUATTRO Q/82, QUATTRO T/82, UNO AQ, UNO AT, UNO Q, UNO T | | |

| | | | |
|---|--|-----------------|----------|
|  <p>1</p> | | | |
| Part No. | 507050 | Ref. No. | CER150NT |
| description | lid for salt tank | | |
| For models: | DUE AQ, DUE AT, QUATTRO Q/82, QUATTRO T/82, UNO AQ, UNO AT, UNO Q, UNO T | | |

dosing containers

| | | | |
|---|--|-----------------|-------|
|  <p>1</p> | | | |
| Part No. | 507016 | Ref. No. | AM027 |
| description | rinse aid container | | |
| For models: | DUE AQ, DUE AT, QUATTRO Q/82, QUATTRO T/82, UNO AQ, UNO AT, UNO Q, UNO T | | |
| spare parts for | 507016 | | |
|  <p>Part No. 507020 Ref. No. AM030</p> | | | |
| description | container lid suitable for rinse aid container | | |

salt tanks

| | | | |
|---|--|-----------------|--------|
|  <p>1</p> | | | |
| Part No. | 524177 | Ref. No. | CER146 |
| description | lid ø 69mm H 20mm for salt tank ID ø 50mm | | |
| For models: | DUE AQ, DUE AT, QUATTRO Q/82, QUATTRO T/82, UNO AQ, UNO AT, UNO Q, UNO T | | |
| accessories for | 524177 | | |
|  <p>Part No. 524148 Ref. No. —</p> | | | |
| description | O-ring EPDM thickness 3.53mm ID ø 40.86mm Qty 1 pcs | | |



| | | | |
|---|--|-----------------|--------|
|  | | | |
| 1 | | | |
| Part No. | 510018 | Ref. No. | CERI45 |
| description | nut \varnothing 92mm H 10.5mm for salt tank ID \varnothing 64mm | | |
| For models: | DUE AQ, DUE AT, QUATTRO Q/82, QUATTRO T/82, UNO AQ, UNO AT, UNO Q, UNO T | | |

| | | | |
|---|--|-----------------|-------------------------|
|  | | | |
| 1 | | | |
| Part No. | 510929 | Ref. No. | CERI43 |
| description | salt tank \varnothing 120mm H 117mm hose \varnothing 10mm mounting \varnothing 70mm overall height 157mm | | |
| For models: | DUE AQ, DUE AT, QUATTRO Q/82, QUATTRO T/82, UNO AQ, UNO AT, UNO Q, UNO T | | |
| spare parts for | 510929 | | |
|  | Part No. | 506015 | Ref. No. CER146A |
| | O-ring EPDM thickness 3.53mm ID \varnothing 39.69mm Qty 1 pcs | | |
|  | Part No. | 510018 | Ref. No. CER145 |
| | nut \varnothing 92mm H 10.5mm for salt tank ID \varnothing 64mm | | |
|  | Part No. | 524177 | Ref. No. CER146 |
| | lid \varnothing 69mm H 20mm for salt tank ID \varnothing 50mm | | |
| accessories for | 510929 | | |
|  | Part No. | 510071 | Ref. No. — |
| | flat gasket rubber ED \varnothing 81mm ID \varnothing 68mm thickness 3mm for salt tank Qty 1 pcs | | |
|  | Part No. | 510654 | Ref. No. — |
| | gasket H 6mm D1 \varnothing 82mm D2 \varnothing 68mm | | |
|  | Part No. | 510883 | Ref. No. — |
| | gasket rubber ED \varnothing 86mm ID \varnothing 66mm thickness 2mm for salt tank Qty 1 pcs | | |

boilers

boilers for dishwashers

| | | | |
|--|--------|-----------------|------|
|  | | | |
| 1 | | | |
| Part No. | 507106 | Ref. No. | GB11 |
| description | boiler | | |

| | | | |
|--|---|-----------------|--------|
|  | | | |
| 1 | | | |
| Part No. | 507107 | Ref. No. | GB11NT |
| description | boiler | | |
| For models: | JOLLY AQ, JOLLY AT, JOLLY Q, JOLLY T, UNO AQ, UNO CLQ, UNO CSQ, UNO Q | | |

| | | | |
|--|--------|-----------------|------|
|  | | | |
| 1 | | | |
| Part No. | 507108 | Ref. No. | GB21 |
| description | boiler | | |

| | | | |
|--|--------|-----------------|---------|
|  | | | |
| 1 | | | |
| Part No. | 507110 | Ref. No. | GB4133F |
| description | boiler | | |

| | | | |
|--|----------------------------|-----------------|---------|
|  | | | |
| 1 | | | |
| Part No. | 507111 | Ref. No. | GB4821F |
| description | boiler | | |
| For models: | QUATTRO Q/82, QUATTRO T/82 | | |

| | | | |
|--|------------------------------------|-----------------|-----------|
|  | | | |
| 1 | | | |
| Part No. | 507508 | Ref. No. | GB21NTPR5 |
| description | boiler \varnothing 140mm L 365mm | | |



1

| | | | |
|--------------------|----------------------------|-----------------|---------|
| Part No. | 507112 | Ref. No. | GB4823F |
| description | boiler ø 150mm L 425mm | | |
| For models: | QUATTRO Q/82, QUATTRO T/82 | | |



1

| | | | |
|--------------------|------------------------|-----------------|------------|
| Part No. | 507047 | Ref. No. | GB413FNT05 |
| description | boiler ø 160mm L 440mm | | |



1

| | | | |
|--------------------|------------------------------------|-----------------|--------------------|
| Part No. | 507109 | Ref. No. | GB413F GB413FNT |
| description | boiler ø 160mm L 440mm hose ø 10mm | | |

accessories



1

| | | | |
|--------------------|--|-----------------|--------|
| Part No. | 507406 | Ref. No. | GBPBSA |
| description | insulating mat for boiler L 330mm W 330mm thickness 10mm | | |

rotation plates

rotation plates



1

| | | | |
|--------------------|----------------|-----------------|-------|
| Part No. | 507126 | Ref. No. | GG3TA |
| description | rotation plate | | |
| For models: | QUATTRO T/82 | | |



1

| | | | |
|--------------------|--|-----------------|-----------------------------|
| Part No. | 507321 | Ref. No. | GG1T1 GG1T1B GG1T1CGR |
| description | rotation plate ø 292mm | | |
| For models: | DUE AT, JOLLY AT, JOLLY T, UNO AT, UNO T | | |



1

| | | | |
|--------------------|--|-----------------|-----------------|
| Part No. | 507117 | Ref. No. | GG1TA GG1TAB |
| description | rotation plate ø 293mm plastic seat ø 15mm | | |



rotation plate bearings



1

| | | | |
|--------------------|--|-----------------|-------|
| Part No. | 507115 | Ref. No. | GG1T2 |
| description | bearing rotation plate | | |
| For models: | DUE AT, JOLLY AT, JOLLY T, UNO AT, UNO T | | |

accessories



1

| | | | |
|--------------------|--------------|-----------------|-------|
| Part No. | 507124 | Ref. No. | GG3T2 |
| description | bushing | | |
| For models: | QUATTRO T/82 | | |



1

| | | | |
|--------------------|-------------------|-----------------|---------|
| Part No. | 507132 | Ref. No. | GG4TFEG |
| description | spindle with ball | | |
| For models: | QUATTRO T/82 | | |



1

| | | | |
|--------------------|---|-----------------|-------------------|
| Part No. | 507123 | Ref. No. | GG1TH GG1THBGR |
| description | union screw for rotation plate \varnothing 19mm | | |
| For models: | JOLLY AT, JOLLY T | | |

softener cartridges

softening columns



1

| | | | |
|--------------------|--|-----------------|--------|
| Part No. | 530000 | Ref. No. | CERI47 |
| description | softener 4-fold L 380mm W 180mm | | |
| For models: | DUE AQ, DUE AT, QUATTRO Q/82, QUATTRO T/82, UNO AQ, UNO AT, UNO Q, UNO T | | |

housing and bezels

fascias



1

| | | | |
|--------------------|---|-----------------|--|
| Part No. | 699271 | Ref. No. | CEPC6214S05C CEPC6214S08C CEPC6214SGR12C |
| description | control panel for dishwasher assembled L 312mm W 132mm H 85mm | | |



1

| | | | |
|--------------------|--|-----------------|----------|
| Part No. | 502188 | Ref. No. | CEPC6214 |
| description | control panel LTM1600 L 400mm W 50mm H 159mm black | | |



1

| | | | |
|--------------------|---|-----------------|----------------------------|
| Part No. | 502253 | Ref. No. | CEPC6214P1 CEPC6214P105 |
| description | control panel warewashing L 310mm W 133mm H 7mm black | | |

miscellaneous



1

| | | | |
|--------------------|---------|-----------------|--------|
| Part No. | 507055 | Ref. No. | DOT14P |
| description | end cap | | |



1

| | | | |
|--------------------|------------------------------|-----------------|-----------|
| Part No. | 507569 | Ref. No. | DOT38PBGR |
| description | screw connection thread 3/8" | | |



hood mechanics for dishwashers

bolts

1 

| | | | |
|--------------------|---------------------|-----------------|----------|
| Part No. | 507166 | Ref. No. | GMMN6181 |
| description | bolt for hood joint | | |
| For models: | SEI 2P, SEI 2P/S | | |

bushes

1 

| | | | |
|--------------------|--------------------------|-----------------|----------|
| Part No. | 507167 | Ref. No. | GMMN6191 |
| description | bush for hood joint | | |
| For models: | SEI 1P, SEI 2P, SEI 2P/S | | |

spring holders

1 

| | | | |
|--------------------|------------------------------|-----------------|-----------|
| Part No. | 507156 | Ref. No. | GMMML6251 |
| description | spring holder hood mechanics | | |
| For models: | SEI 2P, SEI 2P/S | | |

linkage

1 

| | | | |
|--------------------|--------------------------|-----------------|-----------|
| Part No. | 507158 | Ref. No. | GMMML6271 |
| description | tie bar for hood spring | | |
| For models: | SEI 1P, SEI 2P, SEI 2P/S | | |

hood handles

1 

| | | | |
|--------------------|--------------------------|-----------------|----------|
| Part No. | 507159 | Ref. No. | GMMN6151 |
| description | hood handle | | |
| For models: | SEI 1P, SEI 2P, SEI 2P/S | | |

hood handle supports

1 

| | | | |
|--------------------|------------------------------|-----------------|----------|
| Part No. | 507163 | Ref. No. | GMMN6171 |
| description | handle holder hood mechanics | | |

1

| | | | |
|--------------------|------------------------------|-----------------|---------|
| Part No. | 507168 | Ref. No. | GMMN630 |
| description | handle holder hood mechanics | | |

1 

| | | | |
|--------------------|------------------------------|-----------------|--------------------------------------|
| Part No. | 507169 | Ref. No. | GMMN6301 GMMN6301GR GMMN6301P1 |
| description | handle holder hood mechanics | | |

1 

| | | | |
|--------------------|------------------------------|-----------------|-----------|
| Part No. | 507170 | Ref. No. | GMMN6301S |
| description | handle holder hood mechanics | | |
| For models: | SEI 1P, SEI 2P, SEI 2P/S | | |

1

| | | | |
|--------------------|--|-----------------|------------|
| Part No. | 507164 | Ref. No. | GMMN6171P1 |
| description | handle holder hood mechanics mounting pos. lower | | |

1 

| | | | |
|--------------------|--|-----------------|-----------|
| Part No. | 507165 | Ref. No. | GMMN6171S |
| description | handle holder hood mechanics mounting pos. lower | | |
| For models: | SEI 1P, SEI 2P, SEI 2P/S | | |

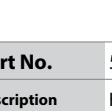

| | | | |
|---|--|-----------------|----------|
|  | | | |
| 1 | | | |
| Part No. | 507160 | Ref. No. | GMMN6161 |
| description | handle holder hood mechanics mounting pos. upper | | |

| | | | |
|---|--|-----------------|------------|
|  | | | |
| 1 | | | |
| Part No. | 507161 | Ref. No. | GMMN6161P1 |
| description | handle holder hood mechanics mounting pos. upper | | |

| | | | |
|---|--|-----------------|-----------|
|  | | | |
| 1 | | | |
| Part No. | 507162 | Ref. No. | GMMN6161S |
| description | handle holder hood mechanics mounting pos. upper | | |
| For models: | SEI 1P, SEI 2P, SEI 2P/S | | |

basket guides

guide bars

| | | | |
|---|--------------|-----------------|----------|
|  | | | |
| 1 | | | |
| Part No. | 971141 | Ref. No. | GMGC6461 |
| description | basket guide | | |

| | | | |
|---|--------------|-----------------|--------|
|  | | | |
| 1 | | | |
| Part No. | 971142 | Ref. No. | LISFA6 |
| description | basket guide | | |







| | | | |
|--|---------------------------------|-----------------|------------------------|
|  | | | |
| 1 | | | |
| Part No. | 517322 | Ref. No. | GMGC5SXI GMGC5SXINT |
| description | basket guide mounting pos. left | | |



| | | | |
|---|----------------------------------|-----------------|----------|
|  | | | |
| 1 | | | |
| Part No. | 517323 | Ref. No. | GMGC5DXI |
| description | basket guide mounting pos. right | | |

basket holders

| | | | |
|--|-------------------------------|-----------------|------------------------|
|  | | | |
| 1 | | | |
| Part No. | 971140 | Ref. No. | GMGC6401 GMGC6401FC |
| description | basket support L 500m W 500mm | | |





| air traps | | | |
|--|----------------------------|-----------------|--|
| air traps | | | |
|  <p>1</p> | | | |
| Part No. | 507171 | Ref. No. | GP025 GP025B GP025BGR |
| description | air trap | | |
| For models: | QUATTRO Q/82, QUATTRO T/82 | | |
| accessories for | 507171 | | |
|  | Part No. | 507052 | Ref. No. D034 |
| hexagonal nut thread 3/4" Qty 1 pcs | | | |
|  | Part No. | 507078 | Ref. No. G15253G G251525G |
| flat gasket rubber ED ø 25mm ID ø 14.5mm thickness 2.5mm Qty 1 pcs | | | |
|  | Part No. | 507080 | Ref. No. G382615G |
| flat gasket rubber ED ø 39mm ID ø 25mm thickness 1.5mm Qty 1 pcs | | | |
|  | Part No. | 507172 | Ref. No. GP026A GP026AB GP026ABGR |
| connection angle for air trap | | | |
|  | Part No. | 507173 | Ref. No. GP026B GP026BB GP026BBGR |
| nut for connection angle for air trap | | | |

| | | | |
|--|---|-----------------|--|
|  <p>1</p> | | | |
| Part No. | 507516 | Ref. No. | GP025BCOMP GP025BGRCOMP |
| description | air trap complete L 80mm W 30mm H 50mm hose ø 5mm plastic | | |
| spare parts for | 507516 | | |
|  | Part No. | 507052 | Ref. No. D034 |
| hexagonal nut thread 3/4" Qty 1 pcs | | | |
|  | Part No. | 507078 | Ref. No. G15253G G251525G |
| flat gasket rubber ED ø 25mm ID ø 14.5mm thickness 2.5mm Qty 1 pcs | | | |
|  | Part No. | 507080 | Ref. No. G382615G |
| flat gasket rubber ED ø 39mm ID ø 25mm thickness 1.5mm Qty 1 pcs | | | |
|  | Part No. | 507171 | Ref. No. GP025 GP025B GP025BGR |
| air trap | | | |
|  | Part No. | 507172 | Ref. No. GP026A GP026AB GP026ABGR |
| connection angle for air trap | | | |
|  | Part No. | 524463 | Ref. No. GP026BB GP026BBGR |
| union nut thread 3/4" H 13mm WS 32 plastic Qty 1 pcs for air trap | | | |

| | | | |
|---|--|-----------------|-------------------------------------|
|  <p>1</p> | | | |
| Part No. | 524917 | Ref. No. | GP02562PB GP02562PBGR SE12PCQ |
| description | air trap ø 60.5mm H 110mm thread 3/4" hose ø 6mm plastic | | |

| air trap accessories | | | |
|--|---|-----------------|--------------------------------|
|  <p>1</p> | | | |
| Part No. | 507172 | Ref. No. | GP026A GP026AB GP026ABGR |
| description | connection angle for air trap | | |
| For models: | DUE AQ, DUE AT, QUATTRO Q/82, QUATTRO T/82, UNO AQ, UNO AT, UNO Q, UNOT | | |

| | | | |
|---|---|-----------------|--------------------------------|
|  <p>1</p> | | | |
| Part No. | 507173 | Ref. No. | GP026B GP026BB GP026BBGR |
| description | nut for connection angle for air trap | | |
| For models: | DUE AQ, DUE AT, QUATTRO Q/82, QUATTRO T/82, UNO AQ, UNO AT, UNO Q, UNOT | | |

| miscellaneous | | | |
|--|---------------------------------------|-----------------|---------|
|  <p>1</p> | | | |
| Part No. | 506249 | Ref. No. | CETP6GR |
| description | blind plug D1 ø 6mm for control panel | | |

| | | | |
|--|---------|-----------------|--------|
|  <p>1</p> | | | |
| Part No. | 507219 | Ref. No. | LI027A |
| description | reducer | | |



door mechanics

doors



| | | | |
|--------------------|---|-----------------|--------|
| Part No. | 507400 | Ref. No. | GMP02A |
| description | door complete IME/Omniwash DUE AT suitable for dishwasher | | |



| | | | |
|--------------------|--|-----------------|-------|
| Part No. | 507401 | Ref. No. | GMP05 |
| description | door IME/Omniwash Quattro Q 4/82 suitable for dishwasher | | |



| | | | |
|--------------------|-------------------------------------|-----------------|-----------|
| Part No. | 694275 | Ref. No. | GMP05MPR5 |
| description | door W 555mm H 410mm thickness 22mm | | |

door bumpers

| | | | |
|--------------------|---|-----------------|-------|
| Part No. | 507490 | Ref. No. | AMPCP |
| description | door bumper H 10mm silicone L 33mm W 15mm | | |

door shafts

| | | | |
|--------------------|---|-----------------|----------|
| Part No. | 507023 | Ref. No. | AM112NTM |
| description | door shaft | | |
| For models: | JOLLY AQ, JOLLY AT, JOLLY Q, JOLLY T, UNO ACSQ, UNO ACST, UNO AT, UNO CLQ, UNO CLT, UNO CSQ, UNO CST, UNO T | | |



| | | | |
|------------------------|--|-----------------|------------------------|
| Part No. | 507039 | Ref. No. | CEMP21 |
| description | door shaft | | |
| For models: | DUE AQ, DUE AT, QUATTRO Q/82, QUATTRO T/82, UNO AQ, UNO AT, UNO Q, UNO T | | |
| accessories for | 507039 | | |
| | Part No. | 507040 | Ref. No. CEMP22 |
| | retaining ring E D1 ø 4mm D2 ø 9mm SS DIN 6799 thickness 0.7mm | | |

| | | | |
|------------------------|--|-----------------|-------------------------|
| Part No. | 507024 | Ref. No. | AM212NT |
| description | door shaft L 120mm | | |
| For models: | DUE AQ | | |
| accessories for | 507024 | | |
| | Part No. | 507015 | Ref. No. AM013NT |
| | retaining ring E D1 ø 7mm D2 ø 14mm SS DIN 6799 thickness 0.9mm for shaft ø 8-11mm | | |

| | | | |
|--------------------|----------------------------|-----------------|-------------------|
| Part No. | 507025 | Ref. No. | AM412 AM412NTM |
| description | door shaft L 170mm | | |
| For models: | QUATTRO Q/82, QUATTRO T/82 | | |

| | | | |
|------------------------|--|-----------------|-------------------------|
| Part No. | 507026 | Ref. No. | AM512 |
| description | door shaft L 175mm | | |
| For models: | QUATTRO Q/82, QUATTRO T/82 | | |
| accessories for | 507026 | | |
| | Part No. | 507015 | Ref. No. AM013NT |
| | retaining ring E D1 ø 7mm D2 ø 14mm SS DIN 6799 thickness 0.9mm for shaft ø 8-11mm | | |





| | | | |
|---|--|-----------------|-------------------------|
|  | | | |
| 1 | | | |
| Part No. | 507022 | Ref. No. | AM112NT |
| description | door shaft ø 8mm L 90mm | | |
| For models: | UNO AQ, UNO Q | | |
| accessories for | 507022 | | |
| | Part No. | 507015 | Ref. No. AM013NT |
| |  retaining ring E D1 ø 7mm D2 ø 14mm SS DIN 6799 thickness 0.9mm for shaft ø 8-11mm | | |

| locks | | | |
|---|--|-----------------|--|
|  | | | |
| 1 | | | |
| Part No. | 507011 | Ref. No. | AM011 AM011A+AM011C+AM011D+AM011E AM011R |
| description | door catch complete door locking catch | | |
| For models: | DUE ACLQ, DUE ACLT, DUE ACSQ, DUE ACST, DUE AQ, DUE AT, JOLLY AQ, JOLLY AT, JOLLY Q, JOLLY T, QUATTRO Q/82, QUATTRO T/82, UNO ACSQ, UNO ACST, UNO AQ, UNO AT, UNO CLQ, UNO CLT, UNO CSQ, UNO CST, UNO Q, UNO T | | |

| | | | |
|--|--------------------------|-----------------|---------------------------------------|
|  | | | |
| 1 | | | |
| Part No. | 518231 | Ref. No. | AM011NT AM011NT+011CNT+011ENT+011D |
| description | snap lock thread 1/4" SS | | |

| miscellaneous | | | |
|---|-------------|-----------------|-------|
|  | | | |
| 1 | | | |
| Part No. | 346945 | Ref. No. | AM014 |
| description | angle piece | | |

| | | | |
|---|---------------------------------|-----------------|--------|
|  | | | |
| 1 | | | |
| Part No. | 507034 | Ref. No. | CEMP13 |
| description | fastening angle for microswitch | | |
| For models: | QUATTRO Q/82, QUATTRO T/82 | | |

| | | | |
|---|---------------------------------|-----------------|----------|
|  | | | |
| 1 | | | |
| Part No. | 507035 | Ref. No. | CEMP13CL |
| description | fastening angle for microswitch | | |

| | | | |
|--|--|-----------------|----------|
|  | | | |
| 1 | | | |
| Part No. | 507036 | Ref. No. | CEMP13CS |
| description | fastening angle for microswitch | | |
| For models: | DUE AQ, DUE AT, JOLLY AQ, JOLLY AT, JOLLY Q, JOLLY T, QUATTRO Q/82, QUATTRO T/82, UNO AQ, UNO AT, UNO Q, UNO T | | |

| | | | |
|---|--|-----------------|----------|
|  | | | |
| 1 | | | |
| Part No. | 507031 | Ref. No. | AM0PFPPM |
| description | fixing plate for door | | |
| For models: | DUE ACLQ, DUE ACLT, DUE ACSQ, DUE ACST, DUE AQ, DUE AT, JOLLY AQ, JOLLY AT, JOLLY Q, JOLLY T, QUATTRO Q/82, QUATTRO T/82, UNO ACSQ, UNO ACST, UNO AQ, UNO AT, UNO CLQ, UNO CLT, UNO CSQ, UNO CST, UNO Q, UNO T | | |

| | | | |
|---|--------------|-----------------|------|
|  | | | |
| 1 | | | |
| Part No. | 507053 | Ref. No. | D038 |
| description | nut nut 3/8" | | |

| | | | |
|---|----------------------------|-----------------|-------|
|  | | | |
| 1 | | | |
| Part No. | 507012 | Ref. No. | AM012 |
| description | spacer ring bush | | |
| For models: | QUATTRO Q/82, QUATTRO T/82 | | |

| | | | |
|---|--|-----------------|--------|
|  | | | |
| 1 | | | |
| Part No. | 507013 | Ref. No. | AM012M |
| description | spacer ring bush | | |
| For models: | DUE ACLQ, DUE ACLT, DUE ACSQ, DUE ACST, DUE AQ, DUE AT, JOLLY AQ, JOLLY AT, JOLLY Q, JOLLY T, QUATTRO Q/82, QUATTRO T/82, UNO ACSQ, UNO ACST, UNO AQ, UNO AT, UNO CLQ, UNO CLT, UNO CSQ, UNO CST, UNO Q, UNO T | | |



screw connections



1

| | | | |
|--------------------|--------|-----------------|------|
| Part No. | 507059 | Ref. No. | DP14 |
| description | nut | | |



1

| | | | |
|--------------------|--|-----------------|--------------|
| Part No. | 507056 | Ref. No. | DP1 DP1GR |
| description | nut thread 1" H 14mm WS 46 ø 52mm | | |
| For models: | DUE ACLQ, DUE ACLT, DUE ACSQ, DUE ACST, DUE AQ, DUE AT, JOLLY AQ, JOLLY AT, JOLLY Q, JOLLY T, UNO ACSQ, UNO ACST, UNO AQ, UNO AT, UNO CLQ, UNO CLT, UNO CSQ, UNO CST, UNO Q, UNO T | | |



1

| | | | |
|--------------------|--|-----------------|------------------|
| Part No. | 507057 | Ref. No. | DP112 DP112GR |
| description | nut thread 1½" H 14mm WS 60 ø 65mm | | |
| For models: | QUATTRO Q/82, QUATTRO T/82, SEI 1P, SEI 2P, SEI 2P/S | | |



1

| | | | |
|--------------------|--|-----------------|------------------|
| Part No. | 507058 | Ref. No. | DP114 DP114GR |
| description | screw connection thread 1¼" H 14mm WS 55 | | |
| For models: | DUE AQ, DUE AT, JOLLY AQ, JOLLY AT, JOLLY Q, JOLLY T, QUATTRO Q/82, QUATTRO T/82, SEI 1P, SEI 2P, SEI 2P/S, UNO AQ, UNO AT, UNO Q, UNO T | | |



1

| | | | |
|--------------------|---|-----------------|----------------------|
| Part No. | 524463 | Ref. No. | GP026BB GP026BBGR |
| description | union nut thread ¾" H 13mm WS 32 plastic Qty 1 pcs for air trap | | |

washing and rinsing systems



1

| | | | |
|--------------------|--------------------|-----------------|---------|
| Part No. | 507251 | Ref. No. | LISA26F |
| description | connecting fitting | | |

1

| | | | |
|--------------------|------------------------------|-----------------|-------|
| Part No. | | Ref. No. | LI335 |
| description | counterpart wash arm support | | |
| For models: | QUATTRO Q/82 | | |

1

| | | | |
|--------------------|--------------------------------|-----------------|-------|
| Part No. | 507226 | Ref. No. | LI128 |
| description | extension for wash arm support | | |

1

| | | | |
|--------------------|--------------------------------|-----------------|-------|
| Part No. | 507230 | Ref. No. | LI228 |
| description | extension for wash arm support | | |

1

| | | | |
|--------------------|--------------------------------|-----------------|--------|
| Part No. | 507236 | Ref. No. | LI428F |
| description | extension for wash arm support | | |





| | | | |
|---|--------------------------------|-----------------|---------|
|  | | | |
| 1 | | | |
| Part No. | 507250 | Ref. No. | LISA26A |
| description | extension for wash arm support | | |

| | | | |
|---|--|-----------------|----------|
|  | | | |
| 1 | | | |
| Part No. | 507177 | Ref. No. | GR016PNT |
| description | hose connector brass straight | | |
| For models: | DUE AT, JOLLY AT, JOLLY T, QUATTRO T/82, UNO AT, UNO T | | |

| | | | |
|---|---|-----------------|---------------|
|  | | | |
| 1 | | | |
| Part No. | 507054 | Ref. No. | D038 D038A |
| description | nut thread 3/8" H 10mm brass WS 20 Qty 1 pcs | | |
| For models: | DUE ACLQ, DUE ACSQ, DUE AQ, DUE AT, JOLLY AT, JOLLY T, QUATTRO Q/82, QUATTRO T/82, SEI 1P, SEI 2P, SEI 2P/S, UNO AQ, UNO AT, UNO CLQ, UNO CSQ, UNO Q, UNO T | | |

| | | | |
|---|---------------------------------------|-----------------|--------|
|  | | | |
| 1 | | | |
| Part No. | 507178 | Ref. No. | GR019A |
| description | rinse arm support mounting pos. lower | | |
| For models: | QUATTRO T/82 | | |

| | | | |
|---|--|-----------------|----------|
|  | | | |
| 1 | | | |
| Part No. | 517414 | Ref. No. | L1133FOT |
| description | rinse arm support ø20mm H 44mm thread 1/4"/M10x1 WS 23 | | |
| For models: | DUE ACLQ, DUE ACLT, DUE ACSQ, DUE ACST, DUE AQ, JOLLY AQ, JOLLY Q, UNO ACSQ, UNO ACST, UNO AQ, UNO CLQ, UNO CLT, UNO CSQ, UNO CST, UNO Q | | |

| | | | |
|---|--------------------------------|-----------------|--------|
|  | | | |
| 1 | | | |
| Part No. | 507175 | Ref. No. | GR016A |
| description | screw connection for rinse arm | | |
| For models: | QUATTRO T/82 | | |

| | | | |
|--|--|-----------------|----------------------------------|
|  | | | |
| 1 | | | |
| Part No. | 507224 | Ref. No. | L1034P L1034PV0 L1034PV0GR |
| description | slide ring | | |
| For models: | DUE ACLQ, DUE ACLT, DUE ACSQ, DUE ACST, DUE AQ, JOLLY AQ, JOLLY Q, QUATTRO Q/82, SEI 1P, SEI 2P, SEI 2P/S, UNO ACSQ, UNO ACST, UNO AQ, UNO CLQ, UNO CLT, UNO CSQ, UNO CST, UNO Q | | |

| | | | |
|---|--------------|-----------------|-------|
|  | | | |
| 1 | | | |
| Part No. | 507235 | Ref. No. | L1428 |
| description | wash pipe | | |
| For models: | QUATTRO Q/82 | | |

| | | | |
|--|--|-----------------|---------|
|  | | | |
| 1 | | | |
| Part No. | 507227 | Ref. No. | L112830 |
| description | wash pipe L 160mm | | |
| For models: | JOLLY AQ, JOLLY Q, UNO ACSQ, UNO ACST, UNO AQ, UNO CLQ, UNO CLT, UNO CSQ, UNO CST, UNO Q | | |

| | | | |
|--|--|-----------------|---------|
|  | | | |
| 1 | | | |
| Part No. | 507231 | Ref. No. | L122830 |
| description | wash pipe L 195mm | | |
| For models: | DUE ACLQ, DUE ACLT, DUE ACSQ, DUE ACST, DUE AQ | | |



| | | | |
|--|-------------------------------|-----------------|--------|
|  | | | |
| 1 | | | |
| Part No. | 507407 | Ref. No. | LS6372 |
| description | wash pipe mounting pos. upper | | |

washing and rinsing systems (sorted by producer)

OMNIWASH

| | | | |
|--|--|-----------------|----------|
|  | | | |
| 1 | | | |
| Part No. | 507284 | Ref. No. | LSI16CSL |
| description | wash and rinse arm 2 wash arms/ 2 rinse arms | | |

| | | | |
|---|--|-----------------|---------------------------------|
|  | | | |
| 1 | | | |
| Part No. | 507276 | Ref. No. | LSI16 LSI16BBB LSI16BBBGR |
| description | wash and rinse arm wash arm L 315mm rinse arm L 320mm w. jets 5 r. jets 6 mounting ø 12/45mm mounting pos. upper/lower 2 wash arms/ 2 rinse arms | | |

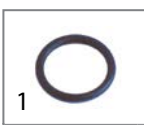
| | | | |
|--|--|-----------------|-------|
|  | | | |
| 1 | | | |
| Part No. | 507309 | Ref. No. | OR122 |
| description | O-ring EPDM thickness 2.62mm ID ø 17.13mm Qty 1 pcs | | |
| For models: | DUE ACLQ, DUE ACSQ, DUE AQ, DUE AT, JOLLY AQ, JOLLY AT, JOLLY Q, JOLLY T, QUATTRO Q/82, QUATTRO T/82, SEI 1P, SEI 2P, SEI 2P/S, UNO AQ, UNO AT, UNO CLQ, UNO CSQ, UNO Q, UNO T | | |

| | | | |
|--|--|-----------------|-------|
|  | | | |
| 1 | | | |
| Part No. | 504590 | Ref. No. | OR124 |
| description | O-ring EPDM thickness 2.62mm ID ø 18.72mm Qty 1 pcs | | |
| For models: | DUE ACLQ, DUE ACLT, DUE ACSQ, DUE ACST, DUE AQ, JOLLY AQ, JOLLY Q, QUATTRO Q/82, SEI 1P, SEI 2P, SEI 2P/S, UNO ACSQ, UNO ACST, UNO AQ, UNO CLQ, UNO CLT, UNO CSQ, UNO CST, UNO Q | | |

| | | | |
|---|-----------|-----------------|--------|
|  | | | |
| 1 | | | |
| Part No. | 507280 | Ref. No. | LSI16C |
| description | rinse arm | | |

| | | | |
|---|--|-----------------|--------------------------|
|  | | | |
| 1 | | | |
| Part No. | 507282 | Ref. No. | LSI16CDSB LSI16CDSBGR |
| description | rinse arm L 132mm nozzles 3 thread 1/2" mounting pos. lower grey | | |

| | | | |
|---|--|-----------------|---------|
|  | | | |
| 1 | | | |
| Part No. | 524837 | Ref. No. | LSI16CB |
| description | rinse arm L 132mm nozzles 3 thread 1/2" mounting pos. lower grey | | |

| | | | |
|---|----------------|-----------------|----------------------|
|  | | | |
| 1 | | | |
| Part No. | 507355 | Ref. No. | LSI020B LSI020BGR |
| description | rinse jet grey | | |
| For models: | SEI 1P | | |

| | | | |
|---|--------------|-----------------|--------|
|  | | | |
| 1 | | | |
| Part No. | 507267 | Ref. No. | LSI017 |
| description | union nut | | |
| For models: | QUATTRO Q/82 | | |

| | | | |
|---|-----------|-----------------|--------------------------------|
|  | | | |
| 1 | | | |
| Part No. | 507350 | Ref. No. | GHGELA LSI017B LSI017BGR |
| description | union nut | | |
| For models: | SEI 1P | | |

| | | | |
|---|-----------|-----------------|----------------------|
|  | | | |
| 1 | | | |
| Part No. | 507354 | Ref. No. | LSI021B LSI021BGR |
| description | union nut | | |
| For models: | SEI 1P | | |





| | | | |
|---|-------------------------|-----------------|--------|
|  | | | |
| 1 | | | |
| Part No. | 507270 | Ref. No. | LSI021 |
| description | union nut for rinse jet | | |
| For models: | QUATTRO Q/82 | | |

| | | | |
|---|--------------|-----------------|--------|
|  | | | |
| 1 | | | |
| Part No. | 507265 | Ref. No. | LSI015 |
| description | wash jet | | |
| For models: | QUATTRO Q/82 | | |

| | | | |
|---|---------------|-----------------|--------|
|  | | | |
| 1 | | | |
| Part No. | 507277 | Ref. No. | LSI16B |
| description | wash arm | | |
| For models: | UNO AQ, UNO Q | | |

| | | | |
|---|--------------|-----------------|--------|
|  | | | |
| 1 | | | |
| Part No. | 507266 | Ref. No. | LSI016 |
| description | wash jet | | |
| For models: | QUATTRO Q/82 | | |

| | | | |
|---|----------|-----------------|---------|
|  | | | |
| 1 | | | |
| Part No. | 507278 | Ref. No. | LSI16BD |
| description | wash arm | | |

| | | | |
|---|------------------------------------|-----------------|---------|
|  | | | |
| 1 | | | |
| Part No. | 507352 | Ref. No. | LSI015B |
| description | wash jet mounting pos. inner white | | |
| For models: | SEI 1P | | |

| | | | |
|---|----------|-----------------|---------|
|  | | | |
| 1 | | | |
| Part No. | 507279 | Ref. No. | LSI16BS |
| description | wash arm | | |

| | | | |
|---|--|-----------------|----------------------|
|  | | | |
| 1 | | | |
| Part No. | 507351 | Ref. No. | LSI016B LSI016BGR |
| description | wash jet mounting pos. left grey H 16mm ø 13mm | | |
| For models: | SEI 1P | | |

| | | | |
|---|---------------|-----------------|-----------------------|
|  | | | |
| 1 | | | |
| Part No. | 507272 | Ref. No. | LSI0607A LSI0607AN |
| description | wash arm boss | | |
| For models: | QUATTRO Q/82 | | |

| | | | |
|--|--|-----------------|-------|
|  | | | |
| 1 | | | |
| Part No. | 507285 | Ref. No. | LSI26 |
| description | wash and rinse arm 2 wash arms/ 2 rinse arms | | |

| | | | |
|---|---------------|-----------------|-------------------|
|  | | | |
| 1 | | | |
| Part No. | 507274 | Ref. No. | LSI06A LSI06AN |
| description | wash arm boss | | |

| | | | |
|--|--|-----------------|------------------------------------|
|  | | | |
| 1 | | | |
| Part No. | 507290 | Ref. No. | LSI26BBB LSI26BBBGR LSI26CSL |
| description | wash and rinse arm wash arm L 365mm rinse arm L 370mm w. jets 6 r. jets 6 mounting ø 12/45mm mounting pos. lower 2 wash arms/ 2 rinse arms | | |

| | | | |
|---|------------------------------------|-----------------|---------------------------|
|  | | | |
| 1 | | | |
| Part No. | 507341 | Ref. No. | LSI0607ABGR LSI0607ANT |
| description | wash arm boss L 83mm W 80mm H 54mm | | |

| | | | |
|---|--------------|-----------------|--------|
|  | | | |
| 1 | | | |
| Part No. | 507268 | Ref. No. | LSI018 |
| description | blank nozzle | | |
| For models: | QUATTRO Q/82 | | |





| | | | |
|---|--------------|-----------------|----------------------|
|  | | | |
| 1 | | | |
| Part No. | 507353 | Ref. No. | LSI018B LSI018BGR |
| description | blank nozzle | | |
| For models: | SEI 1P | | |

| | | | |
|---|----------------------------------|-----------------|----------------------|
|  | | | |
| 1 | | | |
| Part No. | 507356 | Ref. No. | LSI022B LSI022BGR |
| description | blank nozzle for rinse arm white | | |
| For models: | SEI 1P | | |

| | | | |
|---|--|-----------------|-------|
|  | | | |
| 1 | | | |
| Part No. | 504590 | Ref. No. | OR124 |
| description | O-ring EPDM thickness 2.62mm ID ø 18.72mm Qty 1 pcs | | |
| For models: | DUE ACLQ, DUE ACLT, DUE ACSQ, DUE ACST, DUE AQ, JOLLY AQ, JOLLY Q, QUATTRO Q/82, SEI 1P, SEI 2P, SEI 2P/S, UNO ACSQ, UNO ACST, UNO AQ, UNO CLQ, UNO CLT, UNO CSQ, UNO CST, UNO Q | | |

| | | | |
|--|-----------|-----------------|---------|
|  | | | |
| 1 | | | |
| Part No. | 507281 | Ref. No. | LSI26CD |
| description | rinse arm | | |

| | | | |
|---|-----------|-----------------|--------|
|  | | | |
| 1 | | | |
| Part No. | 507289 | Ref. No. | LSI26C |
| description | rinse arm | | |

| | | | |
|---|-----------------------------|-----------------|----------|
|  | | | |
| 1 | | | |
| Part No. | 507044 | Ref. No. | LSI26CSB |
| description | rinse arm L 160mm nozzles 3 | | |

| | | | |
|---|-----------------------------|-----------------|---------|
|  | | | |
| 1 | | | |
| Part No. | 507283 | Ref. No. | LSI26CS |
| description | rinse arm L 160mm nozzles 3 | | |

| | | | |
|---|------------------------|-----------------|----------|
|  | | | |
| 1 | | | |
| Part No. | 507415 | Ref. No. | LSI26CDB |
| description | rinse arm with nozzles | | |

| | | | |
|---|---------------------------|-----------------|---------|
|  | | | |
| 1 | | | |
| Part No. | 507416 | Ref. No. | LSI26CB |
| description | rinse arm without nozzles | | |

| | | | |
|---|----------------|-----------------|----------------------|
|  | | | |
| 1 | | | |
| Part No. | 507355 | Ref. No. | LSI020B LSI020BGR |
| description | rinse jet grey | | |
| For models: | SEI 1P | | |

| | | | |
|---|-----------|-----------------|--------------------------------|
|  | | | |
| 1 | | | |
| Part No. | 507350 | Ref. No. | GHGELA LSI017B LSI017BGR |
| description | union nut | | |
| For models: | SEI 1P | | |

| | | | |
|---|-----------|-----------------|----------------------|
|  | | | |
| 1 | | | |
| Part No. | 507354 | Ref. No. | LSI021B LSI021BGR |
| description | union nut | | |
| For models: | SEI 1P | | |

| | | | |
|---|----------|-----------------|--------|
|  | | | |
| 1 | | | |
| Part No. | 507286 | Ref. No. | LSI26B |
| description | wash arm | | |
| For models: | DUE AQ | | |

| | | | |
|---|----------|-----------------|---------|
|  | | | |
| 1 | | | |
| Part No. | 507287 | Ref. No. | LSI26BD |
| description | wash arm | | |





| | | | |
|---|----------|-----------------|---------|
|  | | | |
| 1 | | | |
| Part No. | 507288 | Ref. No. | LSI26BS |
| description | wash arm | | |

| | | | |
|---|---|-----------------|----------|
|  | | | |
| 1 | | | |
| Part No. | 507399 | Ref. No. | LSI26BSB |
| description | wash arm mounting pos. left complete with nozzles | | |

| | | | |
|---|--|-----------------|----------|
|  | | | |
| 1 | | | |
| Part No. | 507398 | Ref. No. | LSI26BDB |
| description | wash arm mounting pos. right L 155mm nozzles 3 | | |

| | | | |
|--|---------------|-----------------|-----------|
|  | | | |
| 1 | | | |
| Part No. | 507337 | Ref. No. | LSI0607AB |
| description | wash arm boss | | |
| For models: | SEI 1P | | |

| | | | |
|---|------------------------------------|-----------------|---------|
|  | | | |
| 1 | | | |
| Part No. | 507352 | Ref. No. | LSI015B |
| description | wash jet mounting pos. inner white | | |
| For models: | SEI 1P | | |

| | | | |
|---|--|-----------------|----------------------|
|  | | | |
| 1 | | | |
| Part No. | 507351 | Ref. No. | LSI016B LSI016BGR |
| description | wash jet mounting pos. left grey H 16mm ø 13mm | | |
| For models: | SEI 1P | | |

| | | | |
|--|--|-----------------|---|
|  | | | |
| 1 | | | |
| Part No. | 507342 | Ref. No. | LSI46 LSI46BBB LSI46BBBGR LSI66BBB LSI66BBBGR |
| description | wash and rinse arm wash arm L 500mm rinse arm L 500mm w. jets 8 r. jets 6 mounting ø 12/45mm mounting pos. upper/lower 2 wash arms/ 2 rinse arms | | |
| For models: | QUATTRO Q/82, SEI 1P | | |
| spare parts for | 507342 | | |
|  | Part No. | 504590 | Ref. No. OR124 |
| | O-ring EPDM thickness 2.62mm ID ø 18.72mm Qty 1 pcs | | |
|  | Part No. | 507309 | Ref. No. OR122 |
| | O-ring EPDM thickness 2.62mm ID ø 17.13mm Qty 1 pcs | | |
|  | Part No. | 507337 | Ref. No. LSI0607AB |
| | wash arm boss | | |
|  | Part No. | 507343 | Ref. No. LSI46CDB |
| | rinse arm mounting pos. right complete | | |
|  | Part No. | 507344 | Ref. No. LSI46CSB |
| | rinse arm L 220mm nozzles 3 thread 1/2" mounting pos. left white | | |
|  | Part No. | 507346 | Ref. No. LSI66BSB |
| | wash arm | | |
|  | Part No. | 507347 | Ref. No. LSI66BDB |
| | wash arm | | |
|  | Part No. | 507349 | Ref. No. LS09PB LS09PBGR |
| | Thumb screw | | |
|  | Part No. | 507350 | Ref. No. GHGELA LSI017B LSI017BGR |
| | union nut | | |
|  | Part No. | 507351 | Ref. No. LSI016B LSI016BGR |
| | wash jet mounting pos. left grey H 16mm ø 13mm | | |
|  | Part No. | 507352 | Ref. No. LSI015B |
| | wash jet mounting pos. inner white | | |
|  | Part No. | 507353 | Ref. No. LSI018B LSI018BGR |
| | blank nozzle | | |
|  | Part No. | 507354 | Ref. No. LSI021B LSI021BGR |
| | union nut | | |
|  | Part No. | 507355 | Ref. No. LSI020B LSI020BGR |
| | rinse jet grey | | |



| | | | |
|--------------------|--------------|-----------------|--------|
| Part No. | 507271 | Ref. No. | LSI022 |
| description | blank nozzle | | |
| For models: | QUATTRO Q/82 | | |



| | | | |
|--------------------|----------------------------------|-----------------|----------------------|
| Part No. | 507356 | Ref. No. | LSI022B LSI022BGR |
| description | blank nozzle for rinse arm white | | |
| For models: | SEI 1P | | |



| | | | |
|--------------------|--|-----------------|-------|
| Part No. | 507309 | Ref. No. | OR122 |
| description | O-ring EPDM thickness 2.62mm ID ø 17.13mm Qty 1 pcs | | |
| For models: | DUE ACLQ, DUE ACSQ, DUE AQ, DUE AT, JOLLY AQ, JOLLY AT, JOLLY Q, JOLLY T, QUATTRO Q/82, QUATTRO T/82, SEI 1P, SEI 2P, SEI 2P/S, UNO AQ, UNO AT, UNO CLQ, UNO CSQ, UNO Q, UNO T | | |



| | | | |
|--------------------|--|-----------------|-------|
| Part No. | 504590 | Ref. No. | OR124 |
| description | O-ring EPDM thickness 2.62mm ID ø 18.72mm Qty 1 pcs | | |
| For models: | DUE ACLQ, DUE ACLT, DUE ACSQ, DUE ACST, DUE AQ, JOLLY AQ, JOLLY Q, QUATTRO Q/82, SEI 1P, SEI 2P, SEI 2P/S, UNO ACSQ, UNO ACST, UNO AQ, UNO CLQ, UNO CLT, UNO CSQ, UNO CST, UNO Q | | |



| | | | |
|--------------------|-----------|-----------------|-------------------|
| Part No. | 507295 | Ref. No. | LSI46C LSI46CB |
| description | rinse arm | | |
| For models: | SEI 1P | | |



| | | | |
|--------------------|---|-----------------|-----------------------|
| Part No. | 507297 | Ref. No. | LSI46CS LSI46CSBGR |
| description | rinse arm L 220mm nozzles 3 thread 1/2" mounting pos. left grey | | |
| For models: | QUATTRO Q/82 | | |



| | | | |
|------------------------|--|-----------------|----------|
| Part No. | 507344 | Ref. No. | LSI46CSB |
| description | rinse arm L 220mm nozzles 3 thread 1/2" mounting pos. left white | | |
| For models: | SEI 1P | | |
| spare parts for | 507344 | | |



| | | | |
|-----------------|--------|-----------------|-------|
| Part No. | 507309 | Ref. No. | OR122 |
|-----------------|--------|-----------------|-------|

O-ring EPDM thickness 2.62mm ID ø 17.13mm Qty 1 pcs



| | | | |
|-----------------|--------|-----------------|----------------------|
| Part No. | 507354 | Ref. No. | LSI021B LSI021BGR |
|-----------------|--------|-----------------|----------------------|

union nut



| | | | |
|-----------------|--------|-----------------|----------------------|
| Part No. | 507355 | Ref. No. | LSI020B LSI020BGR |
|-----------------|--------|-----------------|----------------------|

rinse jet grey



| | | | |
|-----------------|--------|-----------------|----------------------|
| Part No. | 507356 | Ref. No. | LSI022B LSI022BGR |
|-----------------|--------|-----------------|----------------------|

blank nozzle for rinse arm white



| | | | |
|--------------------|--|-----------------|-----------------------|
| Part No. | 507296 | Ref. No. | LSI46CD LSI46CDBGR |
| description | rinse arm L 220mm nozzles 3 thread 1/2" mounting pos. right grey | | |
| For models: | QUATTRO Q/82 | | |



| | | | |
|------------------------|--|-----------------|----------|
| Part No. | 507343 | Ref. No. | LSI46CDB |
| description | rinse arm mounting pos. right complete | | |
| For models: | SEI 1P | | |
| spare parts for | 507343 | | |



| | | | |
|-----------------|--------|-----------------|-------|
| Part No. | 507309 | Ref. No. | OR122 |
|-----------------|--------|-----------------|-------|

O-ring EPDM thickness 2.62mm ID ø 17.13mm Qty 1 pcs



| | | | |
|-----------------|--------|-----------------|----------------------|
| Part No. | 507354 | Ref. No. | LSI021B LSI021BGR |
|-----------------|--------|-----------------|----------------------|

union nut



| | | | |
|-----------------|--------|-----------------|----------------------|
| Part No. | 507355 | Ref. No. | LSI020B LSI020BGR |
|-----------------|--------|-----------------|----------------------|

rinse jet grey





| | | | |
|-----------------|--------|-----------------|----------------------|
| Part No. | 507356 | Ref. No. | LSI022B LSI022BGR |
|-----------------|--------|-----------------|----------------------|

blank nozzle for rinse arm white





| | | | |
|---|----------------|-----------------|----------------------|
|  | | | |
| 1 | | | |
| Part No. | 507355 | Ref. No. | LSI020B LSI020BGR |
| description | rinse jet grey | | |
| For models: | SEI 1P | | |

| | | | |
|---|--------------|-----------------|-----------------------------|
|  | | | |
| 1 | | | |
| Part No. | 507261 | Ref. No. | LS09P LS09PB LS09PBGR |
| description | Thumb screw | | |
| For models: | QUATTRO Q/82 | | |

| | | | |
|---|-------------|-----------------|--------------------|
|  | | | |
| 1 | | | |
| Part No. | 507349 | Ref. No. | LS09PB LS09PBGR |
| description | Thumb screw | | |
| For models: | SEI 1P | | |





| | | | |
|--|-----------|-----------------|--------------------------------|
|  | | | |
| 1 | | | |
| Part No. | 507350 | Ref. No. | GHGELA LSI017B LSI017BGR |
| description | union nut | | |
| For models: | SEI 1P | | |







| | | | |
|---|-----------|-----------------|----------------------|
|  | | | |
| 1 | | | |
| Part No. | 507354 | Ref. No. | LSI021B LSI021BGR |
| description | union nut | | |
| For models: | SEI 1P | | |

| | | | |
|---|----------|-----------------|--------|
|  | | | |
| 1 | | | |
| Part No. | 507292 | Ref. No. | LSI46B |
| description | wash arm | | |

| | | | |
|---|--------------|-----------------|---------|
|  | | | |
| 1 | | | |
| Part No. | 507293 | Ref. No. | LSI46BD |
| description | wash arm | | |
| For models: | QUATTRO Q/82 | | |





| | | | |
|---|----------|-----------------|----------|
|  | | | |
| 1 | | | |
| Part No. | 507346 | Ref. No. | LSI66BSB |
| description | wash arm | | |
| For models: | SEI 1P | | |







| | | | | |
|---|---|--------|-----------------|--------------------------------|
| spare parts for | 507346 | | | |
|  | Part No. | 504590 | Ref. No. | OR124 |
| | O-ring EPDM thickness 2.62mm ID ø 18.72mm Qty 1 pcs | | | |
|  | Part No. | 507350 | Ref. No. | GHGELA LSI017B LSI017BGR |
| | union nut | | | |
|  | Part No. | 507351 | Ref. No. | LSI016B LSI016BGR |
| | wash jet mounting pos. left grey H 16mm ø 13mm | | | |
|  | Part No. | 507352 | Ref. No. | LSI015B |
| | wash jet mounting pos. inner white | | | |
|  | Part No. | 507353 | Ref. No. | LSI018B LSI018BGR |
| | blank nozzle | | | |

| | | | | |
|---|---|-----------------|-----------------|--------------------------------|
|  | | | | |
| 1 | | | | |
| Part No. | 507347 | Ref. No. | LSI66BDB | |
| description | wash arm | | | |
| For models: | SEI 1P | | | |
| spare parts for | 507347 | | | |
|  | Part No. | 504590 | Ref. No. | OR124 |
| | O-ring EPDM thickness 2.62mm ID ø 18.72mm Qty 1 pcs | | | |
|  | Part No. | 507350 | Ref. No. | GHGELA LSI017B LSI017BGR |
| | union nut | | | |
|  | Part No. | 507351 | Ref. No. | LSI016B LSI016BGR |
| | wash jet mounting pos. left grey H 16mm ø 13mm | | | |
|  | Part No. | 507352 | Ref. No. | LSI015B |
| | wash jet mounting pos. inner white | | | |
|  | Part No. | 507353 | Ref. No. | LSI018B LSI018BGR |
| | blank nozzle | | | |





| | | | |
|---|---|-----------------|------------------------|
|  | | | |
| 1 | | | |
| Part No. | 524835 | Ref. No. | LSI46BDB LSI46BDBGR |
| description | wash arm L 220mm nozzles 4 thread 3/4" mounting pos. lower grey | | |

| | | | |
|---|-----------------------------|-----------------|--------------------------------|
|  | | | |
| 1 | | | |
| Part No. | 507294 | Ref. No. | LSI46BS LSI46BSB |
| description | wash arm mounting pos. left | | |
| For models: | QUATTRO Q/82 | | |
| spare parts for | 507294 | | |
|  | Part No. | 507350 | Ref. No. |
| union nut | | | GHGELA LSI017B LSI017BGR |
|  | Part No. | 507351 | Ref. No. |
| wash jet mounting pos. left grey H 16mm ø 13mm | | | LSI016B LSI016BGR |
|  | Part No. | 507353 | Ref. No. |
| blank nozzle | | | LSI018B LSI018BGR |

| | | | |
|---|---|-----------------|--------------------------------|
|  | | | |
| 1 | | | |
| Part No. | 507348 | Ref. No. | LSI66BB |
| description | wash arm mounting pos. left/right without nozzles white | | |
| For models: | SEI 1P | | |
| accessories for | 507348 | | |
|  | Part No. | 504590 | Ref. No. |
| O-ring EPDM thickness 2.62mm ID ø 18.72mm Qty 1 pcs | | | OR124 |
|  | Part No. | 507350 | Ref. No. |
| union nut | | | GHGELA LSI017B LSI017BGR |
|  | Part No. | 507351 | Ref. No. |
| wash jet mounting pos. left grey H 16mm ø 13mm | | | LSI016B LSI016BGR |
|  | Part No. | 507352 | Ref. No. |
| wash jet mounting pos. inner white | | | LSI015B |
|  | Part No. | 507353 | Ref. No. |
| blank nozzle | | | LSI018B LSI018BGR |

| | | | |
|---|---------------|-----------------|-----------|
|  | | | |
| 1 | | | |
| Part No. | 507337 | Ref. No. | LSI0607AB |
| description | wash arm boss | | |
| For models: | SEI 1P | | |

| | | | |
|---|------------------------------------|-----------------|---------|
|  | | | |
| 1 | | | |
| Part No. | 507352 | Ref. No. | LSI015B |
| description | wash jet mounting pos. inner white | | |
| For models: | SEI 1P | | |

| | | | |
|---|--|-----------------|----------------------|
|  | | | |
| 1 | | | |
| Part No. | 507351 | Ref. No. | LSI016B LSI016BGR |
| description | wash jet mounting pos. left grey H 16mm ø 13mm | | |
| For models: | SEI 1P | | |

| | | | |
|---|--|-----------------|--------|
|  | | | |
| 1 | | | |
| Part No. | 507300 | Ref. No. | LSISA6 |
| description | wash and rinse arm 2 wash arms/ 2 rinse arms | | |











| | | | |
|--|---|-----------------|-----------------------------------|
|  | | | |
| 1 | | | |
| Part No. | 507301 | Ref. No. | 09GILR60 LSISA6B LSISA6BGR |
| description | wash and rinse arm wash arm L 500mm rinse arm L 500mm w. jets 10 r. jets 6 mounting ø 12/45mm mounting pos. upper/lower 2 wash arms/ 2 rinse arms | | |
| For models: | SEI 2P, SEI 2P/S | | |
| spare parts for | 507301 | | |
|  | Part No. | 507298 | Ref. No. |
| wash jet | | | LSISA15 LSISA15B LSISA15BGR |
|  | Part No. | 507299 | Ref. No. |
| wash jet | | | LSISA16 LSISA16B LSISA16BGR |
|  | Part No. | 507341 | Ref. No. |
| wash arm boss L 83mm W 80mm H 54mm | | | LSI0607ABGR LSI0607ANT |
|  | Part No. | 507350 | Ref. No. |
| union nut | | | GHGELA LSI017B LSI017BGR |

Table continues overleaf





| | | | |
|---|------------------------|-----------------|----------------------|
| spare parts for 507301 | | | |
|  | Part No. 507354 | Ref. No. | LSI021B LSI021BGR |
| union nut | | | |
|  | Part No. 507355 | Ref. No. | LSI020B LSI020BGR |
| rinse jet grey | | | |
|  | Part No. 507356 | Ref. No. | LSI022B LSI022BGR |
| blank nozzle for rinse arm white | | | |





| | | | |
|---|------------------------|-----------------|----------------------|
|  | Part No. 507356 | Ref. No. | LSI022B LSI022BGR |
| description blank nozzle for rinse arm white | | | |
| For models: SEI 1P | | | |

| | | | |
|---|------------------------|-----------------|-------|
|  | Part No. 507309 | Ref. No. | OR122 |
| description O-ring EPDM thickness 2.62mm ID ø 17.13mm Qty 1 pcs | | | |
| For models: DUE ACLQ, DUE ACSQ, DUE AQ, DUE AT, JOLLY AQ, JOLLY AT, JOLLY Q, JOLLY T, QUATTRO Q/82, QUATTRO T/82, SEI 1P, SEI 2P, SEI 2P/S, UNO AQ, UNO AT, UNO CLQ, UNO CSQ, UNO Q, UNO T | | | |





| | | | |
|---|------------------------|-----------------|-------|
|  | Part No. 504590 | Ref. No. | OR124 |
| description O-ring EPDM thickness 2.62mm ID ø 18.72mm Qty 1 pcs | | | |
| For models: DUE ACLQ, DUE ACLT, DUE ACSQ, DUE ACST, DUE AQ, JOLLY AQ, JOLLY Q, QUATTRO Q/82, SEI 1P, SEI 2P, SEI 2P/S, UNO ACSQ, UNO ACST, UNO AQ, UNO CLQ, UNO CLT, UNO CSQ, UNO CST, UNO Q | | | |

| | | | |
|---|------------------------|-----------------|-------------------|
|  | Part No. 507295 | Ref. No. | LSI46C LSI46CB |
| description rinse arm | | | |
| For models: SEI 1P | | | |

| | | | |
|---|------------------------|-----------------|-----------------------|
|  | Part No. 507297 | Ref. No. | LSI46CS LSI46CSBGR |
| description rinse arm L 220mm nozzles 3 thread 1/2" mounting pos. left grey | | | |
| For models: QUATTRO Q/82 | | | |

| | | | |
|---|------------------------|-----------------|----------------------|
|  | Part No. 507344 | Ref. No. | LSI46CSB |
| description rinse arm L 220mm nozzles 3 thread 1/2" mounting pos. left white | | | |
| For models: SEI 1P | | | |
| spare parts for 507344 | | | |
|  | Part No. 507309 | Ref. No. | OR122 |
| description O-ring EPDM thickness 2.62mm ID ø 17.13mm Qty 1 pcs | | | |
|  | Part No. 507354 | Ref. No. | LSI021B LSI021BGR |
| union nut | | | |
|  | Part No. 507355 | Ref. No. | LSI020B LSI020BGR |
| rinse jet grey | | | |
|  | Part No. 507356 | Ref. No. | LSI022B LSI022BGR |
| blank nozzle for rinse arm white | | | |

| | | | |
|---|------------------------|-----------------|----------------------|
|  | Part No. 507296 | Ref. No. | LSI46CD LSI46CDBR |
| description rinse arm L 220mm nozzles 3 thread 1/2" mounting pos. right grey | | | |
| For models: QUATTRO Q/82 | | | |

| | | | |
|---|------------------------|-----------------|----------------------|
|  | Part No. 507343 | Ref. No. | LSI46CDB |
| description rinse arm mounting pos. right complete | | | |
| For models: SEI 1P | | | |
| spare parts for 507343 | | | |
|  | Part No. 507309 | Ref. No. | OR122 |
| description O-ring EPDM thickness 2.62mm ID ø 17.13mm Qty 1 pcs | | | |
|  | Part No. 507354 | Ref. No. | LSI021B LSI021BGR |
| union nut | | | |
|  | Part No. 507355 | Ref. No. | LSI020B LSI020BGR |
| rinse jet grey | | | |
|  | Part No. 507356 | Ref. No. | LSI022B LSI022BGR |
| blank nozzle for rinse arm white | | | |





| | | | |
|---|----------------|-----------------|----------------------|
|  | | | |
| 1 | | | |
| Part No. | 507355 | Ref. No. | LSI020B LSI020BGR |
| description | rinse jet grey | | |
| For models: | SEI 1P | | |



| | | | |
|---|-----------|-----------------|--------------------------------|
|  | | | |
| 1 | | | |
| Part No. | 507350 | Ref. No. | GHGELA LSI017B LSI017BGR |
| description | union nut | | |
| For models: | SEI 1P | | |





| | | | |
|---|-----------|-----------------|----------------------|
|  | | | |
| 1 | | | |
| Part No. | 507354 | Ref. No. | LSI021B LSI021BGR |
| description | union nut | | |
| For models: | SEI 1P | | |

| | | | |
|--|----------|-----------------|----------|
|  | | | |
| 1 | | | |
| Part No. | 507303 | Ref. No. | LSISA6BS |
| description | wash arm | | |

| | | | |
|--|---|-----------------|-------------|
|  | | | |
| 1 | | | |
| Part No. | 507302 | Ref. No. | LSISA6BSBGR |
| description | wash arm L 223mm nozzles 1 left - 4 right thread 3/4" mounting pos. left grey | | |

| | | | |
|---|--|-----------------|-------------|
|  | | | |
| 1 | | | |
| Part No. | 507409 | Ref. No. | LSISA6BDBGR |
| description | wash arm L 223mm nozzles 1 right - 4 left thread 3/4" mounting pos. right grey | | |

| | | | |
|---|---|-----------------|-----------------------|
|  | | | |
| 1 | | | |
| Part No. | 507348 | Ref. No. | LSI66BB |
| description | wash arm mounting pos. left/right without nozzles white | | |
| For models: | SEI 1P | | |
| accessories for | 507348 | | |
|  | Part No. | 504590 | Ref. No. OR124 |
| O-ring EPDM thickness 2.62mm ID ø 18.72mm Qty 1 pcs | | | |

| | | | |
|---|-----------------|--------|--|
| accessories for | 507348 | | |
|  | Part No. | 507350 | Ref. No. GHGELA LSI017B LSI017BGR |
| union nut | | | |
|  | Part No. | 507351 | Ref. No. LSI016B LSI016BGR |
| wash jet mounting pos. left grey H 16mm ø 13mm | | | |
|  | Part No. | 507352 | Ref. No. LSI015B |
| wash jet mounting pos. inner white | | | |
|  | Part No. | 507353 | Ref. No. LSI018B LSI018BGR |
| blank nozzle | | | |

| | | | |
|---|---------------|-----------------|-----------|
|  | | | |
| 1 | | | |
| Part No. | 507337 | Ref. No. | LSI0607AB |
| description | wash arm boss | | |
| For models: | SEI 1P | | |

| | | | |
|---|----------|-----------------|-----------------------------------|
|  | | | |
| 1 | | | |
| Part No. | 507298 | Ref. No. | LSISA15 LSISA15B LSISA15BGR |
| description | wash jet | | |

| | | | |
|---|----------|-----------------|-----------------------------------|
|  | | | |
| 1 | | | |
| Part No. | 507299 | Ref. No. | LSISA16 LSISA16B LSISA16BGR |
| description | wash jet | | |

| | | | |
|--|--|-----------------|--------|
|  | | | |
| 1 | | | |
| Part No. | 507185 | Ref. No. | GR119C |
| description | rinse arm H 323mm L 273mm nozzles 5 mounting pos. left | | |
| For models: | JOLLY T, UNO T | | |

| | | | |
|--|---|-----------------|---------|
|  | | | |
| 1 | | | |
| Part No. | 507186 | Ref. No. | GR119IN |
| description | rinse arm H 323mm L 273mm nozzles 5 mounting pos. left complete with nozzle | | |
| For models: | JOLLY T | | |

1

| | | | |
|--------------------|--|-----------------|---------|
| Part No. | 507187 | Ref. No. | GR1A19C |
| description | rinse arm H 385mm L 270mm nozzles 5 mounting pos. left | | |
| For models: | JOLLY AT, UNO AT | | |



1

| | | | |
|--------------------|---|-----------------|-------|
| Part No. | 507201 | Ref. No. | GRS2Q |
| description | rinse arm H 430mm L 320mm nozzles 6 mounting pos. right without nozzles | | |
| For models: | DUE ACLQ, DUE ACLT, DUE ACSQ, DUE ACST | | |



1

| | | | |
|--------------------|--|-----------------|----------|
| Part No. | 507188 | Ref. No. | GR1A19IN |
| description | rinse arm H 385mm L 275mm nozzles 5 mounting pos. lower complete | | |
| For models: | JOLLY AT | | |



1

| | | | |
|--------------------|--|-----------------|---------------------|
| Part No. | 507202 | Ref. No. | GRS2QBCM GRS2QCM |
| description | rinse arm H 430mm L 320mm nozzles 6 mounting pos. upper complete | | |



1

| | | | |
|--------------------|--|-----------------|-----------|
| Part No. | 507568 | Ref. No. | GR119INGR |
| description | rinse arm H 390mm L 280mm nozzles 5 suitable for JOLLY | | |



1

| | | | |
|--------------------|---|-----------------|----------|
| Part No. | 507190 | Ref. No. | GR2A19IN |
| description | rinse arm H 435mm L 300mm nozzles 5 mounting pos. left complete with nozzle | | |



1

| | | | |
|--------------------|---|-----------------|---------------------|
| Part No. | 507200 | Ref. No. | GRS1QBCM GRS1QCM |
| description | rinse arm H 395mm L 275mm nozzles 6 mounting pos. left complete | | |
| For models: | JOLLY AQ, JOLLY Q, UNO ACSQ, UNO ACST, UNO CLQ, UNO CLT, UNO CSQ, UNO CST | | |



1

| | | | |
|--------------------|--|-----------------|---------|
| Part No. | 507189 | Ref. No. | GR2A19C |
| description | rinse arm H 435mm L 300mm nozzles 5 mounting pos. left without nozzles | | |
| For models: | DUE AT | | |



1

| | | | |
|--------------------|---|-----------------|-------|
| Part No. | 507199 | Ref. No. | GRS1Q |
| description | rinse arm H 395mm L 275mm nozzles 6 mounting pos. left without nozzles | | |
| For models: | JOLLY AQ, JOLLY Q, UNO ACSQ, UNO ACST, UNO CLQ, UNO CLT, UNO CSQ, UNO CST | | |











1

| | | | |
|--------------------|--|-----------------|--------|
| Part No. | 507191 | Ref. No. | GR419C |
| description | rinse arm H 475mm L 375mm nozzles 6 mounting pos. left | | |
| For models: | QUATTRO T/82 | | |



1



| | | | |
|---|--|-----------------|--------------------------------|
| Part No. | 507192 | Ref. No. | GR419IN |
| description | rinse arm H 475mm L 380mm nozzles 6 mounting pos. left suitable for IME/Omniwash type QUATTRO T-82 complete | | |
| For models: | QUATTRO T/82 | | |
| spare parts for | 507192 | | |
|  | Part No. | Ref. No. | GR019A |
| | rinse arm support mounting pos. lower | | |
|  | Part No. | Ref. No. | GR019B GR019BBGR |
| | rinse jet holder | | |
|  | Part No. | Ref. No. | GR019D GR019DB |
| | opposite support for rinse jet | | |
|  | Part No. | Ref. No. | GR019G GR019GB GR019GBGR |
| | end cap for rinse arm | | |
|  | Part No. | Ref. No. | GR020 GR020B GR020BGR |
| | rinse jet | | |
|  | Part No. | Ref. No. | GR021 GR021B GR021BGR |
| | swirl H 15mm ø 10mm 1.5mm H1 5mm | | |
|  | Part No. | Ref. No. | GR419C |
| | rinse arm H 475mm L 375mm nozzles 6 mounting pos. left | | |
|  | Part No. | Ref. No. | OR106 |
| | O-ring EPDM thickness 1.78mm ID ø 6.75mm Qty 1 pcs | | |
|  | Part No. | Ref. No. | — |
| | flat-headed bolt thread M4 thread L 10mm SS DIN 7985/ISO 7045 Qty 20 pcs intake Phillips head ø 8mm head thickness 2mm | | |

1



| | | | |
|--------------------|-----------------------|-----------------|--------------------------------|
| Part No. | 507182 | Ref. No. | GR019G GR019GB GR019GBGR |
| description | end cap for rinse arm | | |
| For models: | QUATTRO T/82 | | |

1



| | | | |
|--------------------|---------------------------------|-----------------|-------------------|
| Part No. | 507181 | Ref. No. | GR019D GR019DB |
| description | opposite support for rinse jet | | |
| For models: | JOLLY AQ, JOLLY Q, QUATTRO T/82 | | |

1



| | | | |
|--------------------|--------------------------------|-----------------|-------------------|
| Part No. | 507196 | Ref. No. | GRS04 GRS04BGR |
| description | opposite support for rinse jet | | |

1



| | | | |
|--------------------|--|-----------------|-------|
| Part No. | 510303 | Ref. No. | OR106 |
| description | O-ring EPDM thickness 1.78mm ID ø 6.75mm Qty 1 pcs | | |
| For models: | DUE ACLQ, DUE ACLT, DUE ACSQ, DUE ACST, DUE AQ, DUE AT, JOLLY AQ, JOLLY AT, JOLLY Q, JOLLY T, QUATTRO Q/82, QUATTRO T/82, UNO ACSQ, UNO ACST, UNO AQ, UNO AT, UNO CLQ, UNO CLT, UNO CSQ, UNO CST, UNO Q, UNO T | | |

1



| | | | |
|--------------------|---|-----------------|-------|
| Part No. | 505073 | Ref. No. | OR128 |
| description | O-ring EPDM thickness 2.62mm ID ø 20.63mm Qty 1 pcs | | |
| For models: | DUE ACLQ, DUE ACLT, DUE ACSQ, DUE ACST, DUE AT, JOLLY AQ, JOLLY AT, JOLLY Q, JOLLY T, QUATTRO T/82, UNO ACSQ, UNO ACST, UNO AQ, UNO AT, UNO CLQ, UNO CLT, UNO CSQ, UNO CST, UNO T | | |

1



| | | | |
|--------------------|---------------------------------------|-----------------|----------|
| Part No. | 507179 | Ref. No. | GR019ANT |
| description | rinse arm support mounting pos. upper | | |

1



| | | | |
|--------------------|---------------------------------------|-----------------|-----------------------------|
| Part No. | 507195 | Ref. No. | GRS03 GRS03B GRS03BGR |
| description | rinse arm support mounting pos. upper | | |

1



| | | | |
|--------------------|---------------------------------------|-----------------|-----------------------------|
| Part No. | 507197 | Ref. No. | GRS05 GRS05B GRS05BGR |
| description | rinse arm support mounting pos. upper | | |

1



| | | | |
|--------------------|---------------------------------------|-----------------|-----------------------------|
| Part No. | 507198 | Ref. No. | GRS06 GRS06B GRS06BGR |
| description | rinse arm support mounting pos. upper | | |





| | | | |
|--|--------------|-----------------|-----------------------------|
|  <p>1</p> | | | |
| Part No. | 507183 | Ref. No. | GR020 GR020B GR020BGR |
| description | rinse jet | | |
| For models: | QUATTRO T/82 | | |

| | | | |
|--|------------------|-----------------|---------------------|
|  <p>1</p> | | | |
| Part No. | 507180 | Ref. No. | GR019B GR019BBGR |
| description | rinse jet holder | | |
| For models: | QUATTRO T/82 | | |

| | | | |
|--|----------------------------------|-----------------|-----------------------------|
|  <p>1</p> | | | |
| Part No. | 507184 | Ref. No. | GR021 GR021B GR021BGR |
| description | swirl H 15mm ø 10mm 1.5mm H1 5mm | | |
| For models: | QUATTRO T/82 | | |

| | | | |
|---|---|-----------------|-------------------|
|  <p>1</p> | | | |
| Part No. | 507142 | Ref. No. | GL1T32 GL1T32B |
| description | end piece for wash pipe mounting pos. upper | | |

| | | | |
|--|---|-----------------|--------------------|
|  <p>1</p> | | | |
| Part No. | 507147 | Ref. No. | GL2T32 GL2T3BGR |
| description | end piece for wash pipe mounting pos. upper | | |

| | | | |
|--|--------------|-----------------|---------|
|  <p>1</p> | | | |
| Part No. | 507151 | Ref. No. | GL4T28I |
| description | wash arm | | |
| For models: | QUATTRO T/82 | | |

| | | | |
|---|--------------|-----------------|---------|
|  <p>1</p> | | | |
| Part No. | 507152 | Ref. No. | GL4T29I |
| description | wash arm | | |
| For models: | QUATTRO T/82 | | |
| spare parts for | 507152 | | |
|  <p>Part No. 507133 Ref. No. GL030 GL030B GL30BGR</p> <p>wash jet</p> | | | |
|  <p>Part No. 507134 Ref. No. GL031 GL031B GL031BGR</p> <p>swirl H 5mm ø 14.5mm 5.5mm</p> | | | |
|  <p>Part No. 507135 Ref. No. GL032 GL032B GL032BGR</p> <p>rinse jet holder</p> | | | |
|  <p>Part No. 507136 Ref. No. GL033 GL033B GL033BGR</p> <p>opposite support</p> | | | |
|  <p>Part No. 507137 Ref. No. GL034A GL034AB</p> <p>end cap</p> | | | |
|  <p>Part No. 507148 Ref. No. GL34T27A</p> <p>union nut wash jet</p> | | | |
|  <p>Part No. 510302 Ref. No. OR2050</p> <p>O-ring EPDM ID ø 12.42mm thickness 1.78mm Qty 1 pcs</p> | | | |
|  <p>Part No. 560340 Ref. No. VD4I</p> <p>hexagonal nut thread M4 H 3.2mm WS 7 SS DIN/ISO DIN 934 / ISO 4032/8673 Qty 1 pcs</p> | | | |

| | | | |
|---|-------------------|-----------------|----------|
|  <p>1</p> | | | |
| Part No. | 507140 | Ref. No. | GL1T28CM |
| description | wash arm complete | | |

| | | | |
|---|-------------------|-----------------|---------------------------|
|  <p>1</p> | | | |
| Part No. | 507143 | Ref. No. | GL2AT28BCMI GL2AT28CMI |
| description | wash arm complete | | |

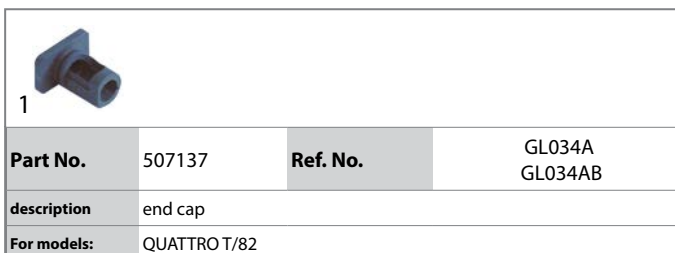
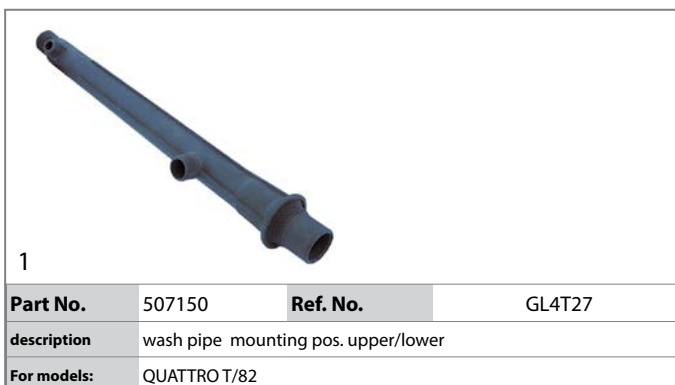
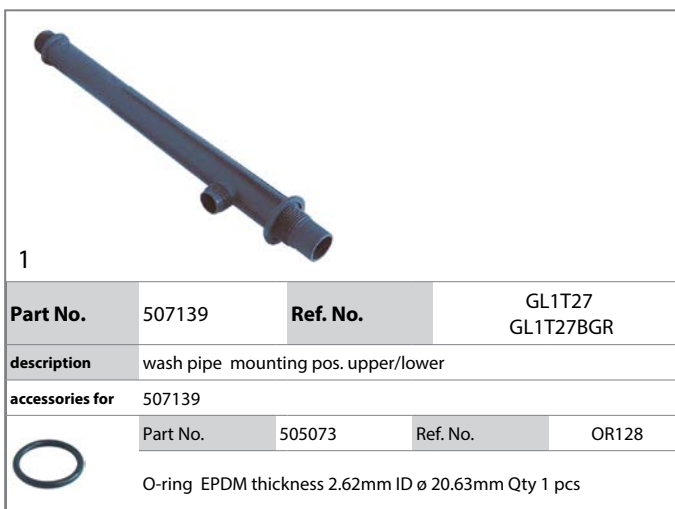
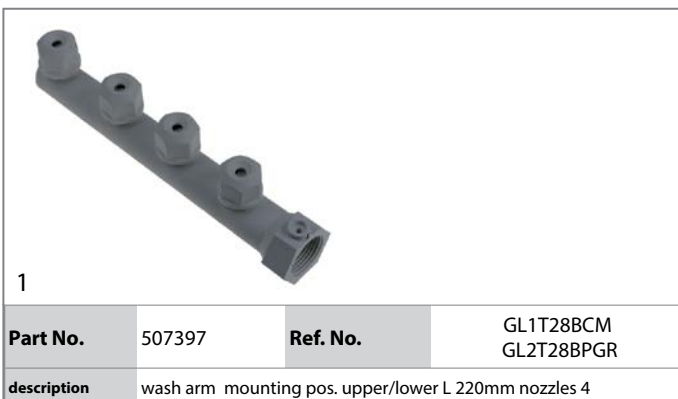
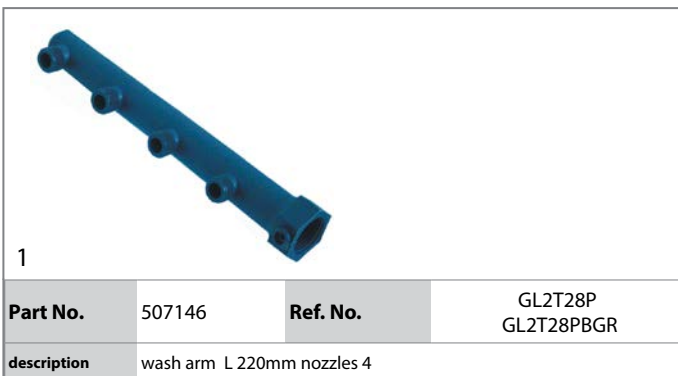
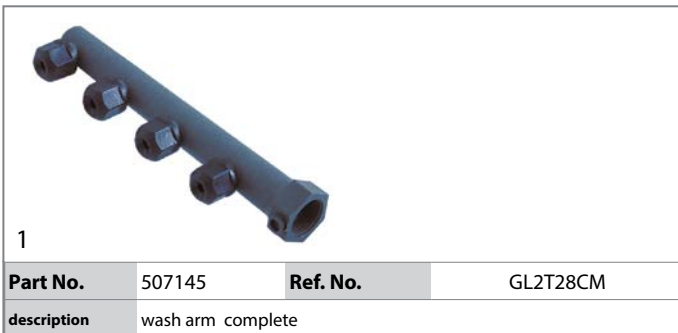







| | | | |
|---|--|-----------------|--------------|
|  | | | |
| 1 | | | |
| Part No. | 507056 | Ref. No. | DP1 DP1GR |
| description | nut thread 1" H 14mm WS 46 ø 52mm | | |
| For models: | DUE ACLQ, DUE ACLT, DUE ACSQ, DUE ACST, DUE AQ, DUE AT, JOLLY AQ, JOLLY AT, JOLLY Q, JOLLY T, UNO ACSQ, UNO ACST, UNO AQ, UNO AT, UNO CLQ, UNO CLT, UNO CSQ, UNO CST, UNO Q, UNO T | | |

| | | | |
|---|------------------|-----------------|-----------------------------|
|  | | | |
| 2 | | | |
| Part No. | 507136 | Ref. No. | GL033 GL033B GL033BGR |
| description | opposite support | | |
| For models: | QUATTRO T/82 | | |

| | | | |
|---|--|-----------------|--------|
|  | | | |
| 1 | | | |
| Part No. | 510302 | Ref. No. | OR2050 |
| description | O-ring EPDM ID ø 12.42mm thickness 1.78mm Qty 1 pcs | | |
| For models: | DUE ACLQ, DUE ACLT, DUE ACSQ, DUE ACST, DUE AQ, DUE AT, JOLLY AQ, JOLLY AT, JOLLY Q, JOLLY T, QUATTRO Q/82, QUATTRO T/82, UNO ACSQ, UNO ACST, UNO AQ, UNO AT, UNO CLQ, UNO CLT, UNO CSQ, UNO CST, UNO Q, UNO T | | |

| | | | |
|---|---|-----------------|-------|
|  | | | |
| 1 | | | |
| Part No. | 505073 | Ref. No. | OR128 |
| description | O-ring EPDM thickness 2.62mm ID ø 20.63mm Qty 1 pcs | | |
| For models: | DUE ACLQ, DUE ACLT, DUE ACSQ, DUE ACST, DUE AQ, DUE AT, JOLLY AQ, JOLLY AT, JOLLY Q, JOLLY T, QUATTRO T/82, UNO ACSQ, UNO ACST, UNO AT, UNO CLQ, UNO CLT, UNO CSQ, UNO CST, UNO T | | |

| | | | |
|---|--|-----------------|------------------------|
|  | | | |
| 1 | | | |
| Part No. | 507314 | Ref. No. | OR3131 |
| description | O-ring EPDM thickness 2.62mm ID ø 32.99mm | | |
| For models: | DUE ACLQ, DUE ACLT, DUE ACSQ, DUE ACST, DUE AQ, DUE AT, JOLLY AQ, JOLLY AT, JOLLY Q, JOLLY T, UNO ACSQ, UNO ACST, UNO AQ, UNO AT, UNO CLQ, UNO CLT, UNO CSQ, UNO CST, UNO Q, UNO T | | |
| accessories for | 507314 | | |
| | Part No. | 507314 | Ref. No. OR3131 |
| |  O-ring EPDM thickness 2.62mm ID ø 32.99mm | | |

| | | | |
|---|------------------|-----------------|-----------------------------|
|  | | | |
| 1 | | | |
| Part No. | 507135 | Ref. No. | GL032 GL032B GL032BGR |
| description | rinse jet holder | | |
| For models: | QUATTRO T/82 | | |

| | | | |
|---|----------------------------|-----------------|-----------------------------|
|  | | | |
| 1 | | | |
| Part No. | 507134 | Ref. No. | GL031 GL031B GL031BGR |
| description | swirl H 5mm ø 14.5mm 5.5mm | | |
| For models: | QUATTRO T/82 | | |

| | | | |
|---|--------------------|-----------------|----------|
|  | | | |
| 1 | | | |
| Part No. | 507148 | Ref. No. | GL34T27A |
| description | union nut wash jet | | |
| For models: | QUATTRO T/82 | | |

| | | | |
|---|--------------|-----------------|----------------------------|
|  | | | |
| 1 | | | |
| Part No. | 507133 | Ref. No. | GL030 GL030B GL30BGR |
| description | wash jet | | |
| For models: | QUATTRO T/82 | | |

miscellaneous

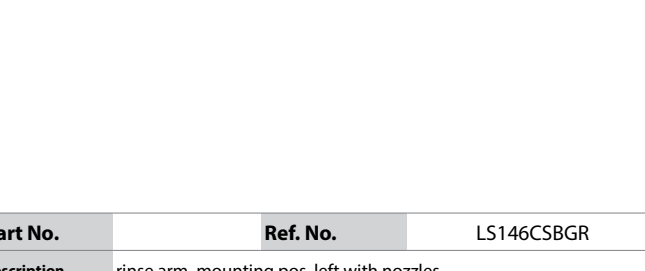
| | | | |
|---|---|-----------------|------------|
|  | | | |
| 1 | | | |
| Part No. | | Ref. No. | LS146CSBGR |
| description | rinse arm mounting pos. left with nozzles | | |

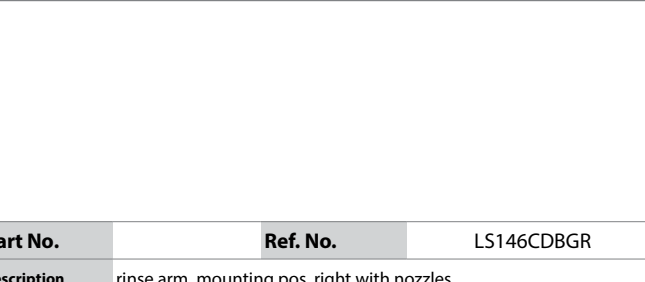
| | | | |
|--|--|-----------------|------------|
|  | | | |
| 1 | | | |
| Part No. | | Ref. No. | LS146CDBGR |
| description | rinse arm mounting pos. right with nozzles | | |

| | | | |
|---|---------------------------------|-----------------|------------|
|  | | | |
| 1 | | | |
| Part No. | 507517 | Ref. No. | LSI020VABS |
| description | rinse jet ø 12mm H 12mm plastic | | |

| | | | |
|---|--------------------------|-----------------|------------|
|  | | | |
| 1 | | | |
| Part No. | 507554 | Ref. No. | GR0190BBGR |
| description | rinse jet ø 3mm H 17.5mm | | |



1

| | | | |
|--------------------|--|-----------------|------------|
| Part No. | | Ref. No. | LS166BSBGR |
| description | wash arm mounting pos. left with nozzles | | |

1

| | | | |
|--------------------|---|-----------------|------------|
| Part No. | | Ref. No. | LS166BDBGR |
| description | wash arm mounting pos. right with nozzles | | |

1

| | | | |
|--------------------|---------------|-----------------|-------------------|
| Part No. | 507259 | Ref. No. | LS06 LS06ACBNT |
| description | wash arm boss | | |

1

| | | | |
|--------------------|-----------------------------|-----------------|-------|
| Part No. | 519433 | Ref. No. | LS015 |
| description | wash jet mounting pos. left | | |

1

| | | | |
|--------------------|--|-----------------|---------------------|
| Part No. | 507510 | Ref. No. | GELASD LSI015BGR |
| description | wash jet mounting pos. right H 16mm ø 13mm | | |

wash arm supports

1

| | | | |
|--------------------|-----------------------|-----------------|------------------------|
| Part No. | 507395 | Ref. No. | LI430FCB LI430FCBGR |
| description | angle piece wash pipe | | |

1

| | | | |
|--------------------|---|-----------------|-------------------------|
| Part No. | 507249 | Ref. No. | GLICQ1BCOMP LIGC1CSL |
| description | wash arm support complete mounting pos. lower | | |

1

| | | | |
|--------------------|--------------------------------------|-----------------|-------|
| Part No. | 507220 | Ref. No. | LI029 |
| description | wash arm support mounting pos. lower | | |
| For models: | QUATTRO Q/82 | | |

1

| | | | |
|--------------------|--------------------------------------|-----------------|---------|
| Part No. | 507221 | Ref. No. | LI029CA |
| description | wash arm support mounting pos. lower | | |
| For models: | QUATTRO Q/82 | | |

1

| | | | |
|--------------------|--------------------------------------|-----------------|-------------------|
| Part No. | 507222 | Ref. No. | LI029CB LI135D |
| description | wash arm support mounting pos. lower | | |

1

| | | | |
|------------------------|--------------------------------------|-----------------|-----------------------------------|
| Part No. | 507225 | Ref. No. | LI126FC LI126FCB LI126FCBGR |
| description | wash arm support mounting pos. lower | | |
| accessories for | 507225 | | |

1

| | | | |
|--------------------|-----------------------------------|-----------------|--------------|
| Part No. | 507056 | Ref. No. | DP1 DP1GR |
| description | nut thread 1" H 14mm WS 46 ø 52mm | | |

1

| | | | |
|--------------------|---|-----------------|--------|
| Part No. | 507314 | Ref. No. | OR3131 |
| description | O-ring EPDM thickness 2.62mm ID ø 32.99mm | | |

1

| | | | |
|--------------------|--------------------------------------|-----------------|-------|
| Part No. | | Ref. No. | LI135 |
| description | wash arm support mounting pos. lower | | |





| | | | |
|--|--------------------------------------|-----------------|---------------------|
|  <p>1</p> | | | |
| Part No. | 507358 | Ref. No. | LI029CAB SULRI30 |
| description | wash arm support mounting pos. lower | | |
| For models: | SEI 1P | | |



| | | | |
|--|--------------------------------------|-----------------|----------|
|  <p>1</p> | | | |
| Part No. | 507359 | Ref. No. | LI029CBB |
| description | wash arm support mounting pos. lower | | |

| | | | |
|--|--------------------------------------|-----------------|--------|
|  <p>1</p> | | | |
| Part No. | 507240 | Ref. No. | LI6012 |
| description | wash arm support mounting pos. upper | | |

| | | | |
|--|--------------------------------------|-----------------|------|
|  <p>1</p> | | | |
| Part No. | 507254 | Ref. No. | LS01 |
| description | wash arm support mounting pos. upper | | |

| | | | |
|--|---|-----------------|-----------------------|
|  <p>1</p> | | | |
| Part No. | 507263 | Ref. No. | LS5 LS5B LS5BGR |
| description | wash arm support mounting pos. upper | | |
| For models: | QUATTRO Q/82 | | |
| accessories for | 507263 | | |
| | Part No. | 507255 | Ref. No. LS02 |
| |  gasket D1 ø 45mm D2 ø 85mm thickness 2mm cork with 4 screw holes wash arm support equiv. no. LS02 | | |

| | | | |
|--|--------------------------------------|-----------------|--------|
|  <p>1</p> | | | |
| Part No. | 507264 | Ref. No. | LS6012 |
| description | wash arm support mounting pos. upper | | |

| | | | |
|--|---|-----------------|----------------------|
|  <p>1</p> | | | |
| Part No. | 507357 | Ref. No. | LS6012B LS6012BGR |
| description | wash arm support mounting pos. upper | | |
| For models: | SEI 1P | | |
| spare parts for | 507357 | | |
| | Part No. | 507229 | Ref. No. LI18F |
| |  rinse arm shaft | | |

| | | | |
|--|---------------------------|-----------------|------|
|  <p>1</p> | | | |
| Part No. | 507257 | Ref. No. | LS03 |
| description | disc for wash arm support | | |

| | | | |
|--|-------------------------------------|-----------------|------------------|
|  <p>1</p> | | | |
| Part No. | 507258 | Ref. No. | LS03P LS03PGR |
| description | flange for wash arm support | | |
| For models: | DUE AQ, QUATTRO Q/82, UNO AQ, UNO Q | | |

| | | | |
|--|--|-----------------|-------|
| rinse arm shafts | | | |
|  <p>1</p> | | | |
| Part No. | 507228 | Ref. No. | LI130 |
| description | rinse arm shaft | | |
| For models: | DUE ACLQ, DUE ACLT, DUE ACSQ, DUE ACST, DUE AQ, JOLLY AQ, JOLLY Q, UNO ACSQ, UNO ACST, UNO AQ, UNO CLQ, UNO CLT, UNO CSQ, UNO CST, UNO Q | | |

| | | | |
|--|--|-----------------|-------|
|  <p>1</p> | | | |
| Part No. | 507229 | Ref. No. | LI18F |
| description | rinse arm shaft | | |
| For models: | DUE ACLQ, DUE ACLT, DUE ACSQ, DUE ACST, DUE AQ, JOLLY AQ, JOLLY Q, SEI 1P, SEI 2P, SEI 2P/S, UNO ACSQ, UNO ACST, UNO AQ, UNO CLQ, UNO CLT, UNO CSQ, UNO CST, UNO Q | | |

| | | | |
|--|--|-----------------|-------|
|  <p>1</p> | | | |
| Part No. | 507232 | Ref. No. | LI330 |
| description | rinse arm shaft | | |
| For models: | QUATTRO Q/82, SEI 1P, SEI 2P, SEI 2P/S | | |



| | | | |
|---|-----------------|-----------------|--------------------|
|  | | | |
| 1 | | | |
| Part No. | 507239 | Ref. No. | LI533F LI533FOT |
| description | rinse arm shaft | | |
| For models: | QUATTRO Q/82 | | |

| | | | |
|---|--------------------------|-----------------|--------|
|  | | | |
| 1 | | | |
| Part No. | 507242 | Ref. No. | LI6333 |
| description | rinse arm shaft | | |
| For models: | SEI 1P, SEI 2P, SEI 2P/S | | |

| | | | |
|---|-----------------|-----------------|---------|
|  | | | |
| 1 | | | |
| Part No. | 507252 | Ref. No. | LISA33F |
| description | rinse arm shaft | | |

| | | | |
|---|---|-----------------|------|
|  | | | |
| 1 | | | |
| Part No. | 507260 | Ref. No. | LS08 |
| description | rinse arm shaft | | |
| For models: | DUE AQ, QUATTRO Q/82, SEI 1P, SEI 2P, SEI 2P/S, UNO AQ, UNO Q | | |

knobs

producer-specific knobs

OMNIWASH

| | | | |
|---|--|-----------------|-------|
|  | | | |
| 1 | | | |
| Part No. | 507043 | Ref. No. | CEMTR |
| description | knob timer ø 43mm shaft ø 6x4.6mm shaft flat lower | | |
| For models: | QUATTRO Q/82, QUATTRO T/82 | | |

handles and hand wheels

handle rails

handle rails

| | | | |
|---|--|-----------------|--------|
|  | | | |
| 1 | | | |
| Part No. | 507005 | Ref. No. | AM010F |
| description | handle rail | | |
| For models: | DUE ACLQ, DUE ACLT, DUE ACSQ, DUE ACST, DUE AQ, DUE AT, QUATTRO Q/82, QUATTRO T/82, UNO ACSQ, UNO ACST, UNO AQ, UNO AT, UNO CLQ, UNO CLT, UNO CSQ, UNO CST, UNO Q, UNO T | | |

| | | | |
|--|-------------|-----------------|--------|
|  | | | |
| 1 | | | |
| Part No. | 507006 | Ref. No. | AM010N |
| description | handle rail | | |

| | | | |
|--|--|-----------------|--------|
|  | | | |
| 1 | | | |
| Part No. | 507007 | Ref. No. | AM010P |
| description | handle rail | | |
| For models: | DUE ACLQ, DUE ACLT, DUE ACSQ, DUE ACST, DUE AQ, DUE AT, QUATTRO Q/82, QUATTRO T/82, UNO ACSQ, UNO ACST, UNO AQ, UNO AT, UNO CLQ, UNO CLT, UNO CSQ, UNO CST, UNO Q, UNO T | | |

| | | | |
|--|----------------------------|-----------------|--------|
|  | | | |
| 1 | | | |
| Part No. | 507010 | Ref. No. | AM010R |
| description | handle rail | | |
| For models: | QUATTRO Q/82, QUATTRO T/82 | | |

| | | | |
|--|--|-----------------|-----------|
|  | | | |
| 1 | | | |
| Part No. | 510664 | Ref. No. | AM010MD25 |
| description | handle rail L 250mm W 50mm H 50mm blue hole distance 120mm Qty 1 pcs | | |

bracket handles

| | | | |
|--|--|-----------------|--------------------|
|  | | | |
| 1 | | | |
| Part No. | 507008 | Ref. No. | AM010PA AM010SW |
| description | pull handle mounting distance 120mm | | |
| For models: | DUE ACLQ, DUE ACLT, DUE ACSQ, DUE ACST, DUE AQ, DUE AT, JOLLY AQ, JOLLY AT, JOLLY Q, JOLLY T, QUATTRO Q/82, QUATTRO T/82, UNO ACSQ, UNO ACST, UNO AQ, UNO AT, UNO CLQ, UNO CLT, UNO CSQ, UNO CST, UNO Q, UNO T | | |



recessed handles



1

| | | | |
|--------------------|--|-----------------|---------------------|
| Part No. | 507009 | Ref. No. | AM010MPC AM010PC |
| description | recessed handle | | |
| For models: | DUE ACLQ, DUE ACLT, DUE ACSQ, DUE ACST, DUE AQ, DUE AT, QUATTRO Q/82, QUATTRO T/82, UNO ACSQ, UNO ACST, UNO AQ, UNO AT, UNO CLQ, UNO CLT, UNO CSQ, UNO CST, UNO Q, UNO T | | |

miscellaneous



1

| | | | |
|--------------------|--|-----------------|-----------|
| Part No. | 507440 | Ref. No. | AM010CD25 |
| description | plate L 269mm W 80mm hole distance 120mm plastic for door handle | | |

locks

snap locks

producer-specific

OMNIWASH



1

| | | | |
|--------------------|--------------------------|-----------------|---------------------------------------|
| Part No. | 518231 | Ref. No. | AM011NT AM011NT+011CNT+011ENT+011D |
| description | snap lock thread 1/4" SS | | |

fittings for catering equipment

drain taps

accessories



1

| | | | |
|--------------------|--|-----------------|--------|
| Part No. | 540222 | Ref. No. | OR3187 |
| description | O-ring EPDM thickness 2.62mm ID ø 47.3mm Qty 1 pcs | | |
| For models: | QUATTRO Q/82, QUATTRO T/82, SEI 1P, SEI 2P, SEI 2P/S | | |

equipment feet and end caps

screw-in feet



1

| | | | |
|--------------------|---|-----------------|--------|
| Part No. | 701168 | Ref. No. | AM016C |
| description | equipment feet kit thread M10x1.5 thread L 25mm ø 38mm H 38mm | | |

baskets

warewashing baskets

plastic baskets round



1

| | | | |
|--------------------|--|-----------------|----------------------|
| Part No. | 970812 | Ref. No. | CT3617L CT3617PL2 |
| description | mix basket ED ø 367mm H 173mm seat ø 280mm mesh type wide-meshed/plastic | | |



1

| | | | |
|--------------------|---|-----------------|---------|
| Part No. | 970827 | Ref. No. | CT4117L |
| description | mix basket ED ø 410mm H 170mm seat ø 375mm mesh type straight | | |

steel wire baskets square

plate baskets



1

| | | | |
|--------------------|--|-----------------|---------|
| Part No. | 971088 | Ref. No. | CQ5018P |
| description | plate basket L 500mm W 500mm plates 18 | | |

plastic baskets square

mix baskets



1

| | | | |
|--------------------|------------------------------------|-----------------|-----------|
| Part No. | 971058 | Ref. No. | CQ3516LPL |
| description | mix basket L 350mm W 350mm H 150mm | | |

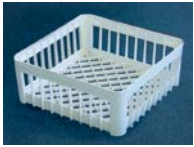

| | | | |
|--------------------|------------------------------------|-----------------|-----------|
| Part No. | 971078 | Ref. No. | CQ4016LPL |
| description | mix basket L 400mm W 400mm H 150mm | | |

accessories

cutlery inserts



| | | | |
|--------------------|---|-----------------|-------|
| Part No. | 970349 | Ref. No. | IP2PP |
| description | cutlery insert L 130mm W 57mm ømm H 110mm | | |

section inserts for glasses



| | | | |
|--------------------|---|-----------------|------------|
| Part No. | 971080 | Ref. No. | CQIB403FSP |
| description | section insert for glasses L 365mm W 365mm H 145mm number of rows 3 | | |

plate inserts



| | | | |
|--------------------|------------------------------|-----------------|----------|
| Part No. | 971079 | Ref. No. | CQIP408P |
| description | plate insert L 365mm W 365mm | | |

gaskets

O-rings

EPDM



| | | | |
|--------------------|--|-----------------|--------|
| Part No. | 510302 | Ref. No. | OR2050 |
| description | O-ring EPDM ID ø 12.42mm thickness 1.78mm Qty 1 pcs | | |
| For models: | DUE ACLQ, DUE ACLT, DUE ACSQ, DUE ACST, DUE AQ, DUE AT, JOLLY AQ, JOLLY AT, JOLLY Q, JOLLY T, QUATTRO Q/82, QUATTRO T/82, UNO ACSQ, UNO ACST, UNO AQ, UNO AT, UNO CLQ, UNO CLT, UNO CSQ, UNO CST, UNO Q, UNO T | | |

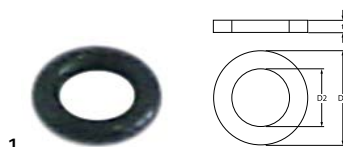

| | | | |
|--------------------|--|-----------------|-------|
| Part No. | 517035 | Ref. No. | OR103 |
| description | O-ring EPDM thickness 1.78mm ID ø 4.48mm Qty 1 pcs | | |



| | | | |
|--------------------|--|-----------------|-------|
| Part No. | 510303 | Ref. No. | OR106 |
| description | O-ring EPDM thickness 1.78mm ID ø 6.75mm Qty 1 pcs | | |
| For models: | DUE ACLQ, DUE ACLT, DUE ACSQ, DUE ACST, DUE AQ, DUE AT, JOLLY AQ, JOLLY AT, JOLLY Q, JOLLY T, QUATTRO Q/82, QUATTRO T/82, UNO ACSQ, UNO ACST, UNO AQ, UNO AT, UNO CLQ, UNO CLT, UNO CSQ, UNO CST, UNO Q, UNO T | | |

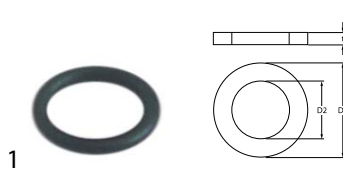

| | | | |
|--------------------|---|-----------------|-------|
| Part No. | 528333 | Ref. No. | OR117 |
| description | O-ring EPDM thickness 2.62mm ID ø 13.1mm Qty 1 pcs | | |
| For models: | DUE ACLQ, DUE ACLT, DUE ACSQ, DUE ACST, DUE AQ, JOLLY AQ, JOLLY AT, JOLLY Q, JOLLY T, UNO ACSQ, UNO ACST, UNO AQ, UNO CLQ, UNO CLT, UNO CSQ, UNO CST, UNO Q | | |

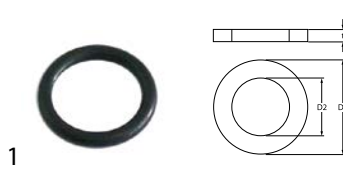

| | | | |
|--------------------|---|-----------------|--------|
| Part No. | 507313 | Ref. No. | OR3056 |
| description | O-ring EPDM thickness 2.62mm ID ø 13.95mm Qty 1 pcs | | |

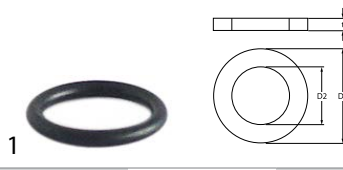

| | | | |
|--------------------|---|-----------------|-------|
| Part No. | 508008 | Ref. No. | OR121 |
| description | O-ring EPDM thickness 2.62mm ID ø 15.88mm Qty 1 pcs | | |

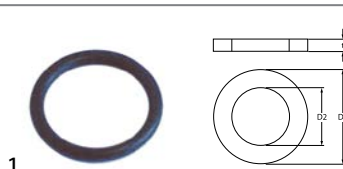

| | | | |
|--------------------|--|-----------------|-------|
| Part No. | 507309 | Ref. No. | OR122 |
| description | O-ring EPDM thickness 2.62mm ID ø 17.13mm Qty 1 pcs | | |
| For models: | DUE ACLQ, DUE ACSQ, DUE AQ, DUE AT, JOLLY AQ, JOLLY AT, JOLLY Q, JOLLY T, QUATTRO Q/82, QUATTRO T/82, SEI 1P, SEI 2P, SEI 2P/S, UNO AQ, UNO AT, UNO CLQ, UNO CSQ, UNO Q, UNO T | | |



| | | | |
|--------------------|--|-----------------|-------|
| Part No. | 504590 | Ref. No. | OR124 |
| description | O-ring EPDM thickness 2.62mm ID ø 18.72mm Qty 1 pcs | | |
| For models: | DUE ACLQ, DUE ACLT, DUE ACSQ, DUE ACST, DUE AQ, JOLLY AQ, JOLLY Q, QUATTRO Q/82, SEI 1P, SEI 2P, SEI 2P/S, UNO ACSQ, UNO ACST, UNO AQ, UNO CLQ, UNO CLT, UNO CSQ, UNO CST, UNO Q | | |

| | | | |
|--------------------|--|-----------------|--------|
| Part No. | 540222 | Ref. No. | OR3187 |
| description | O-ring EPDM thickness 2.62mm ID ø 47.3mm Qty 1 pcs | | |
| For models: | QUATTRO Q/82, QUATTRO T/82, SEI 1P, SEI 2P, SEI 2P/S | | |

| | | | |
|--------------------|---|-----------------|-------|
| Part No. | 505073 | Ref. No. | OR128 |
| description | O-ring EPDM thickness 2.62mm ID ø 20.63mm Qty 1 pcs | | |
| For models: | DUE ACLQ, DUE ACLT, DUE ACSQ, DUE ACST, DUE AT, JOLLY AQ, JOLLY AT, JOLLY Q, JOLLY T, QUATTRO T/82, UNO ACSQ, UNO ACST, UNO AT, UNO CLQ, UNO CLT, UNO CSQ, UNO CST, UNO T | | |

| | | | |
|--------------------|--|-----------------|-------|
| Part No. | 510893 | Ref. No. | OR112 |
| description | O-ring EPDM thickness 2.62mm ID ø 9.92mm Qty 1 pcs | | |
| For models: | JOLLY AQ, JOLLY AT, JOLLY Q, JOLLY T, UNO AQ, UNO AT, UNO Q, UNO T | | |

| | | | |
|------------------------|--|-----------------|--------|
| Part No. | 507314 | Ref. No. | OR3131 |
| description | O-ring EPDM thickness 2.62mm ID ø 32.99mm | | |
| For models: | DUE ACLQ, DUE ACLT, DUE ACSQ, DUE ACST, DUE AQ, DUE AT, JOLLY AQ, JOLLY AT, JOLLY Q, JOLLY T, UNO ACSQ, UNO ACST, UNO AQ, UNO AT, UNO CLQ, UNO CLT, UNO CSQ, UNO CST, UNO Q, UNO T | | |
| accessories for | 507314 | | |
| | Part No. | Ref. No. | OR3131 |
| | 507314 | | OR3131 |
| | O-ring EPDM thickness 2.62mm ID ø 32.99mm | | |

| | | | |
|--------------------|---|-----------------|-------|
| Part No. | 361345 | Ref. No. | OR422 |
| description | O-ring EPDM thickness 2mm ID ø 42.5mm Qty 1 pcs | | |

| | | | |
|--------------------|--|-----------------|---------|
| Part No. | 506015 | Ref. No. | CERI46A |
| description | O-ring EPDM thickness 3.53mm ID ø 39.69mm Qty 1 pcs | | |
| For models: | DUE AQ, DUE AT, QUATTRO Q/82, QUATTRO T/82, UNO AQ, UNO AT, UNO Q, UNO T | | |

| | | | |
|--------------------|--|-----------------|--------|
| Part No. | 507315 | Ref. No. | OR3168 |
| description | O-ring EPDM thickness 2.62mm ID ø 42.52mm | | |
| For models: | DUE AQ, DUE AT, JOLLY AQ, JOLLY AT, JOLLY Q, JOLLY T, QUATTRO Q/82, QUATTRO T/82, SEI 1P, SEI 2P, SEI 2P/S, UNO AQ, UNO AT, UNO Q, UNO T | | |

| | | | |
|--------------------|---|-----------------|----------------|
| Part No. | 510409 | Ref. No. | GUREBOT ORRB3F |
| description | O-ring EPDM thickness 5.34mm ID ø 56.52mm Qty 1 pcs | | |

| | | | |
|--------------------|---|-----------------|--------|
| Part No. | 512111 | Ref. No. | OR3181 |
| description | O-ring EPDM thickness 2.62mm ID ø 45.69mm Qty 1 pcs | | |
| For models: | QUATTRO Q/82, QUATTRO T/82 | | |

| | | | |
|--------------------|--|-----------------|--------|
| Part No. | 508109 | Ref. No. | OR6275 |
| description | O-ring EPDM thickness 5.34mm ID ø 69.22mm Qty 1 pcs | | |
| For models: | DUE AQ, DUE AT, QUATTRO Q/82, QUATTRO T/82, UNO AQ, UNO AT, UNO Q, UNO T | | |



silicone

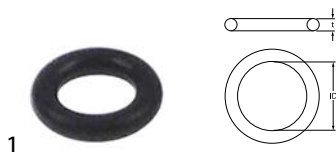

| | | | |
|--------------------|--|-----------------|-------|
| Part No. | 532554 | Ref. No. | OR102 |
| description | O-ring silicone thickness 1.5mm ID ø 4.1mm Qty 1 pcs | | |

sealing washers

fibre gaskets



| | | | |
|--------------------|---|-----------------|----------|
| Part No. | 507332 | Ref. No. | G18122GT |
| description | flat gasket fibre ED ø 18mm ID ø 12mm thickness 2mm Qty 1 pcs | | |
| For models: | DUE ACLQ, DUE ACSQ, DUE AQ, JOLLY AQ, JOLLY AT, JOLLY Q, JOLLY T, QUATTRO Q/82, QUATTRO T/82, UNO AQ, UNO CLQ, UNO CSQ, UNO Q | | |

rubber gaskets



| | | | |
|--------------------|--|-----------------|------------------------------|
| Part No. | 507075 | Ref. No. | G15101G G1510G G16101G |
| description | flat gasket rubber ED ø 15mm ID ø 10mm thickness 2mm Qty 1 pcs | | |
| For models: | DUE AQ, DUE AT, JOLLY AQ, JOLLY AT, JOLLY Q, JOLLY T, QUATTRO Q/82, QUATTRO T/82, SEI 1P, SEI 2P, SEI 2P/S, UNO AQ, UNO AT, UNO Q, UNO T | | |



| | | | |
|--------------------|--|-----------------|----------------------|
| Part No. | 512376 | Ref. No. | G18102G GDSDET62P |
| description | flat gasket rubber ED ø 18mm ID ø 10mm thickness 2mm Qty 1 pcs | | |
| For models: | SEI 1P, SEI 2P, SEI 2P/S | | |



| | | | |
|--------------------|--|-----------------|----------------------|
| Part No. | 507113 | Ref. No. | G18102G GDSDET62P |
| description | flat gasket rubber ED ø 24mm ID ø 11mm thickness 2.5mm Qty 1 pcs | | |



| | | | |
|--------------------|--|-----------------|---------------------|
| Part No. | 507078 | Ref. No. | G15253G G251525G |
| description | flat gasket rubber ED ø 25mm ID ø 14.5mm thickness 2.5mm Qty 1 pcs | | |
| For models: | DUE AQ, DUE AT, JOLLY AQ, JOLLY AT, JOLLY Q, JOLLY T, QUATTRO Q/82, QUATTRO T/82, SEI 1P, SEI 2P, SEI 2P/S, UNO AQ, UNO AT, UNO Q, UNO T | | |



| | | | |
|--------------------|--|-----------------|----------|
| Part No. | 507080 | Ref. No. | G382615G |
| description | flat gasket rubber ED ø 39mm ID ø 25mm thickness 1.5mm Qty 1 pcs | | |
| For models: | DUE AQ, DUE AT, JOLLY AQ, JOLLY AT, JOLLY Q, JOLLY T, QUATTRO Q/82, QUATTRO T/82, UNO AQ, UNO AT, UNO Q, UNO T | | |



| | | | |
|--------------------|--|-----------------|----------|
| Part No. | 507333 | Ref. No. | G50403GT |
| description | flat gasket rubber ED ø 52mm ID ø 41.5mm thickness 3mm Qty 1 pcs equiv. no. G50403GT suitable for IME/Omniwash | | |
| For models: | SEI 1P, SEI 2P, SEI 2P/S | | |



| | | | |
|--------------------|--|-----------------|--------------------|
| Part No. | 507045 | Ref. No. | CERI44 CERI44GS |
| description | flat gasket rubber ED ø 78mm ID ø 68mm thickness 3mm Qty 1 pcs | | |
| For models: | DUE AQ, DUE AT, QUATTRO Q/82, QUATTRO T/82, UNO AQ, UNO AT, UNO Q, UNO T | | |



| | | | |
|--------------------|--|-----------------|--------|
| Part No. | 507404 | Ref. No. | G1282G |
| description | gasket rubber ED ø 12mm ID ø 8mm thickness 3mm Qty 1 pcs | | |



special gaskets

gaskets for wash arm support



| | | | |
|--------------------|---|-----------------|------|
| Part No. | 507255 | Ref. No. | LS02 |
| description | gasket D1 ø 45mm D2 ø 85mm thickness 2mm cork with 4 screw holes wash arm support equiv. no. LS02 | | |
| For models: | DUE AQ, QUATTRO Q/82, UNO AQ, UNO Q | | |



| | | | |
|--------------------|---|-----------------|------------------|
| Part No. | 507256 | Ref. No. | GUSUW13 LS026 |
| description | gasket D2 ø 31mm thickness 3mm with 4 screw holes wash arm support equiv. no. LS026 suitable for IME/Omniwash L 70mm W 58mm hole ø 31mm | | |
| For models: | SEI 1P, SEI 2P, SEI 2P/S | | |

springs

torsion springs



| | | | |
|--------------------|--|-----------------|---------|
| Part No. | 507030 | Ref. No. | AMMP1SX |
| description | torsion spring mounting pos. left for door | | |
| For models: | JOLLY Q, JOLLY T, UNO AT, UNO CLQ, UNO CLT, UNO CSQ, UNO CST, UNO Q, UNO T | | |



| | | | |
|--------------------|--|-----------------|---------|
| Part No. | 507029 | Ref. No. | AMMP1DX |
| description | torsion spring mounting pos. right for door | | |
| For models: | JOLLY Q, JOLLY T, UNO CLQ, UNO CLT, UNO CSQ, UNO CST, UNO Q, UNO T | | |

| | | | |
|--------------------|--|-----------------|-----------------------|
| Part No. | 507027 | Ref. No. | AMMP1A2DX AMMP24DX |
| description | torsion spring ø 17mm L2 38mm wire gauge ø 2mm mounting pos. right L1 10mm L3 70mm Qty 1 pcs for door | | |
| For models: | DUE ACLQ, DUE ACLT, DUE ACSQ, DUE ACST, DUE AQ, DUE AT, JOLLY AQ, JOLLY AT, UNO ACSQ, UNO ACST, UNO AQ, UNO AT | | |

| | | | |
|--------------------|--|-----------------|-----------------------|
| Part No. | 507028 | Ref. No. | AMMP1A2SX AMMP24SX |
| description | torsion spring ø 17mm L2 70mm wire gauge ø 2mm mounting pos. left L1 10mm L3 38mm for door | | |
| For models: | DUE ACLQ, DUE ACLT, DUE ACSQ, DUE ACST, DUE AQ, DUE AT, JOLLY AQ, JOLLY AT, UNO ACSQ, UNO ACST, UNO AQ, UNO AT | | |

compression springs

| | | | |
|--------------------|--|-----------------|--------|
| Part No. | 507038 | Ref. No. | CEMP20 |
| description | compression spring ø 8.8mm L 31mm wire gauge ø 0.7mm | | |
| For models: | DUE AQ, DUE AT, JOLLY AQ, JOLLY AT, JOLLY Q, JOLLY T, QUATTRO Q/82, QUATTRO T/82, UNO AQ, UNO AT, UNO Q, UNO T | | |

| | | | |
|--------------------|---|-----------------|---------------------|
| Part No. | 346940 | Ref. No. | 18010943 CEMMP6S |
| description | compression spring ø 9mm L 19mm wire gauge ø 0.7mm for micro-switch | | |

tension springs

| | | | |
|--------------------|--|-----------------|----------|
| Part No. | 507157 | Ref. No. | GMML6261 |
| description | tension spring ø 37mm total length 875mm wire gauge ø 4.5mm L1 305mm L2 570mm for hood | | |
| For models: | SEI 1P, SEI 2P, SEI 2P/S | | |



dosing pumps

peristaltic dosing pumps

SEKO

built-in version

with frequency control

1

| | | | |
|--------------------|---|-----------------|------------|
| Part No. | | Ref. No. | DOSDETETLE |
| description | dosing pump frequency control 3l/h 230VAC detergent | | |



| | | | |
|--------------------|---|-----------------|------------|
| Part No. | 361923 | Ref. No. | DOSDETETLE |
| description | dosing pump SEKO frequency control 0.1-3l/h 230VAC detergent hose ø 6mm hose type I hose Santoprene suction level 1.5m type PBR | | |

spare parts for 361923

| | | | |
|--------------------|---|-----------------|------------|
| Part No. | 361238 | Ref. No. | DOSTSANSKC |
| description | pump hose SEKO detergent hose ø 6x10mm hose length 135mm hose ø 6mm hose type I hose Santoprene | | |

with time control



1

| | | | |
|--------------------|---|-----------------|------------|
| Part No. | 361887 | Ref. No. | DOSBRIETLE |
| description | dosing pump SEKO with single time control 0.7l/h 230VAC rinse aid hose ø 6mm hose type C hose Sekobril suction level 1.5m type PBM built-in version dosing time 1-20s | | |

spare parts for 361887

| | | | |
|--------------------|--|-----------------|---|
| Part No. | 361890 | Ref. No. | — |
| description | pump hose SEKO rinse aid hose ø 3x8mm hose length 128mm hose ø 6mm hose type C hose Sekobril | | |

spare parts



1

| | | | |
|--------------------|--|-----------------|-----------|
| Part No. | 361136 | Ref. No. | DOSPRRSKC |
| description | roller assembly for dosing pump hole ø 4.8x4mm | | |



1

| | | | |
|--------------------|---|-----------------|------------|
| Part No. | 361238 | Ref. No. | DOSTSANSKC |
| description | pump hose SEKO detergent hose ø 6x10mm hose length 135mm hose ø 6mm hose type I hose Santoprene | | |

spare parts for 361238

| | | | |
|--------------------|---|-----------------|---|
| Part No. | 361639 | Ref. No. | — |
| description | pump hose ED ø 10mm ID ø 6mm Shore 64° Santoprene dosing Qty 5m | | |

various

wall-mounted version

without control



1

| | | | |
|--------------------|--|-----------------|----------|
| Part No. | 361766 | Ref. No. | DOSDET72 |
| description | dosing pump detergent 230V hose ø 4x6mm peristaltic pump | | |



membrane dosing pumps

self-priming with supporting pressure

OMNIWASH



| | | | |
|-----------------|--------|-----------------|------------------------------------|
| Part No. | 361054 | Ref. No. | DSAM3NT DSAM3NTGR DSAM3NTSPL |
|-----------------|--------|-----------------|------------------------------------|

description dosing pump rinse aid pressure connection ø 6mm suction connection ø 6mm auxiliary pressure connection 10mm

For models: DUE ACLQ, DUE ACSQ, DUE AQ, JOLLY AQ, JOLLY AT, JOLLY Q, JOLLY T, QUATTRO Q/82, QUATTRO T/82, SEI 1P, SEI 2P, SEI 2P/S, UNO AQ, UNO CLQ, UNO CSQ, UNO Q

spare parts for 361054

| | | | | |
|--|-----------------|--------|-----------------|--------|
| | Part No. | 361308 | Ref. No. | DS06M3 |
|--|-----------------|--------|-----------------|--------|

membrane rinse aid pressure connection ømm suction connection ømm auxiliary pressure connectionmm

| | | | | |
|--|-----------------|--------|-----------------|---------------|
| | Part No. | 361348 | Ref. No. | DS085 DS85 |
|--|-----------------|--------|-----------------|---------------|

lip valve rinse aid pressure connection ømm suction connection ømm auxiliary pressure connectionmm

accessories for 361054

| | | | | |
|--|-----------------|--------|-----------------|---|
| | Part No. | 520252 | Ref. No. | — |
|--|-----------------|--------|-----------------|---|

nylon hose ID ø 6mm ED ø 8mm L 5m thickness 1mm operating p. 10bar burst p. 50bar t.max. 100°C white

| | | | | |
|--|-----------------|--------|-----------------|---|
| | Part No. | 520278 | Ref. No. | — |
|--|-----------------|--------|-----------------|---|

PVC hose ID ø 6mm ED ø 8mm L 2m thickness 1mm t.max. 60°C transparent



| | | | |
|-----------------|--------|-----------------|---------------|
| Part No. | 361348 | Ref. No. | DS085 DS85 |
|-----------------|--------|-----------------|---------------|

description lip valve rinse aid pressure connection ømm suction connection ømm auxiliary pressure connectionmm



| | | | |
|-----------------|--------|-----------------|--------|
| Part No. | 361308 | Ref. No. | DS06M3 |
|-----------------|--------|-----------------|--------|

description membrane rinse aid pressure connection ømm suction connection ømm auxiliary pressure connectionmm

accessories

hose couplings

metal



| | | | |
|--------------------|---|-----------------|------|
| Part No. | 361182 | Ref. No. | VDRV |
| description | nut thread 1/4" H 5mm nickel-plated brass WS 17 Qty 1 pcs | | |
| For models: | DUE ACLQ, DUE ACSQ, DUE AQ, JOLLY AQ, JOLLY AT, JOLLY Q, JOLLY T, QUATTRO Q/82, QUATTRO T/82, UNO AQ, UNO CLQ, UNO CSQ, UNO Q | | |

tank inlets



| | | | |
|--------------------|-------------------------------------|-----------------|------------|
| Part No. | 361858 | Ref. No. | DSDET040BC |
| description | tank inlet plastic M10 hose ø 5.5mm | | |



| | | | |
|--------------------|------------------------------|-----------------|---------------|
| Part No. | 361859 | Ref. No. | GSDETPI10COMP |
| description | tank inlet SS M10 hose ø 6mm | | |



| | | | |
|--------------------|------------------------------|-----------------|------------|
| Part No. | 361270 | Ref. No. | DSDTET62PC |
| description | tank inlet SS M12 hose ø 4mm | | |

hoses

stainless steel flexi hoses

universal hoses

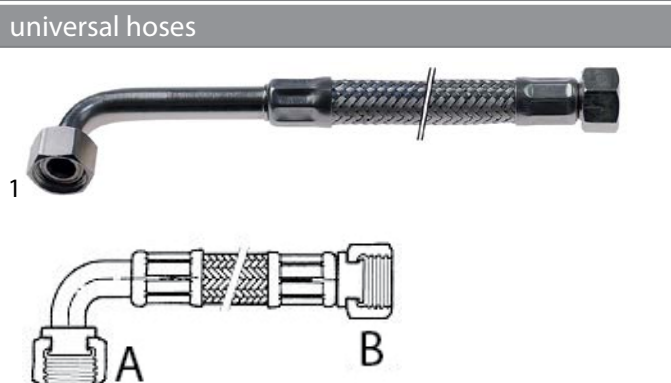

| | | | |
|--------------------|--|-----------------|------------|
| Part No. | 520576 | Ref. No. | GR6223FLEX |
| description | flex hose SS braid straight-curved DN6 connection 1: 3/8" connection 2: 3/8" L 290mm approval DVGW operating p. 10bar burst p. 95bar | | |



PVC supply hoses



| | | | |
|--------------------|---|-----------------|------|
| Part No. | 520011 | Ref. No. | TC34 |
| description | supply hose PVC straight-curved DN13 connections 3/4" L 2000mm operating p. 10bar burst p. 32bar t.max. 90°C approval VDE flat seal | | |

plastic/rubber hoses



| | | | |
|--------------------|---|-----------------|---------|
| Part No. | 520746 | Ref. No. | TC3/415 |
| description | supply hose DN DN10mm L 1500mm operating p. 10bar burst p. 32bar straight-curved connections 3/4" | | |

drain hoses



| | | | |
|--------------------|--|-----------------|---------|
| Part No. | 507329 | Ref. No. | CEPS032 |
| description | drain hose DN19 L 1500mm A int. ø 19mm A ext. ø 24mm B int. ø 21mm B ext. ø 28mm outer hose ø 24mm | | |
| For models: | DUE AQ, DUE AT, QUATTRO Q/82, QUATTRO T/82, UNO AQ, UNO AT, UNO Q, UNO T | | |



| | | | |
|--------------------|--|-----------------|-------|
| Part No. | 507207 | Ref. No. | GS130 |
| description | drain hose DN24 L 1500mm A int. ø 24mm A ext. ø 28mm B int. ø 24mm B ext. ø 28mm outer hose ø 28mm | | |
| For models: | DUE ACLQ, DUE ACSQ, DUE AQ, JOLLY AQ, JOLLY AT, JOLLY Q, JOLLY T, UNO AQ, UNO CLQ, UNO CSQ, UNO Q | | |



| | | | |
|--------------------|--|-----------------|-------|
| Part No. | 507211 | Ref. No. | GS330 |
| description | drain hose DN26 L 1500mm A int. ø 33mm A ext. ø 40mm B int. ø 32mm B ext. ø 40mm outer hose ø 35mm | | |
| For models: | QUATTRO Q/82, QUATTRO T/82, SEI 1P, SEI 2P, SEI 2P/S | | |

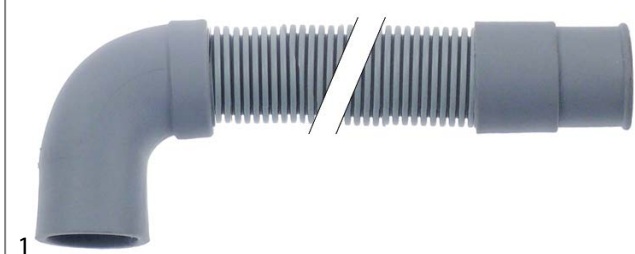

| | | | |
|--------------------|---|-----------------|-----------|
| Part No. | 530789 | Ref. No. | GSTS820PS |
| description | drain hose DN19 L 820mm straight ø inside 21mm straight ext. ø 27mm elbow ø inside 21mm elbow ext. ø 28mm outer hose ø 24mm | | |

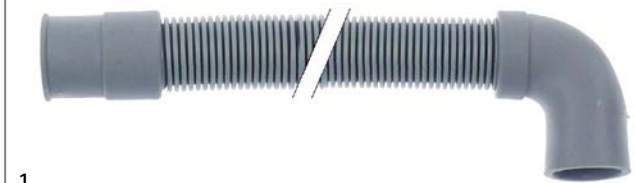

| | | | |
|--------------------|--|-----------------|------------|
| Part No. | 530382 | Ref. No. | GSTS2500PS |
| description | drain hose DN21 L 2575mm straight ø inside 20.5mm straight ext. ø 28mm elbow ø inside 20.5mm elbow ext. ø 26.5mm outer hose ø 24mm | | |

industrial hoses

nylon hoses



| | | | |
|--------------------|--|-----------------|------|
| Part No. | 520091 | Ref. No. | TN64 |
| description | nylon hose ID ø 4mm ED ø 6mm L 2m thickness 1mm operating p. 10bar burst p. 50bar t.max. 100°C transparent | | |

pressure control hoses



| | | | |
|--------------------|---|-----------------|---------------------|
| Part No. | 530560 | Ref. No. | TG510DS TG512FDA |
| description | pressure control hose ID ø 5mm ED ø 9mm L 5m operating p. 30bar burst p. 90bar temp.-resist. 60°C | | |

PVC hoses

PVC hoses without fabric







| | | | |
|--------------------|---|-----------------|------|
| Part No. | 570026 | Ref. No. | TC46 |
| description | PVC hose ID ø 4mm ED ø 6mm L 100m thickness 1mm t.max. 60°C transparent | | |

| | | | | |
|------------------------|--|--------|-----------------|---|
| accessories for | 570026 | | | |
| | Part No. | 361058 | Ref. No. | — |
| | container filter with non-return valve SS hose ø 4x6mm ø 20mm L 56mm | | | |
| | Part No. | 361066 | Ref. No. | — |
| | container filter straight SS hose ø 4x6mm L 37mm non return valve ball valve | | | |

Table continues overleaf



| accessories for | | 570026 | |
|--|----------|--------|------------|
|  | Part No. | 361106 | Ref. No. — |
| container filter with weight and non-return valve SS hose ø 4x6mm ø 21mm L 51mm non return valve lip valve | | | |
|  | Part No. | 361141 | Ref. No. — |
| container filter with weight ceramic hose ø 4mm | | | |
|  | Part No. | 361230 | Ref. No. — |
| container filter with weight stainless steel hose ø 4x6mm | | | |
|  | Part No. | 361462 | Ref. No. — |
| container filter with weight SS hose ø 4x6mm | | | |
|  | Part No. | 361728 | Ref. No. — |
| container filter with 4m 4x6 hose SS hose ø 4x6mm hose length 4000mm | | | |

| | | | |
|--|--|-----------------|------------|
|  | 1 | | |
| Part No. | 520026 | Ref. No. | TC46 |
| description | PVC hose ID ø 4mm ED ø 6mm L 10m thickness 1mm t.max. 60°C transparent | | |
| accessories for | 520026 | | |
|  | Part No. | 361058 | Ref. No. — |
| container filter with non-return valve SS hose ø 4x6mm ø 20mm L 56mm | | | |
|  | Part No. | 361066 | Ref. No. — |
| container filter straight SS hose ø 4x6mm L 37mm non return valve ball valve | | | |
|  | Part No. | 361106 | Ref. No. — |
| container filter with weight and non-return valve SS hose ø 4x6mm ø 21mm L 51mm non return valve lip valve | | | |
|  | Part No. | 361141 | Ref. No. — |
| container filter with weight ceramic hose ø 4mm | | | |
|  | Part No. | 361230 | Ref. No. — |
| container filter with weight stainless steel hose ø 4x6mm | | | |
|  | Part No. | 361462 | Ref. No. — |
| container filter with weight SS hose ø 4x6mm | | | |
|  | Part No. | 361728 | Ref. No. — |
| container filter with 4m 4x6 hose SS hose ø 4x6mm hose length 4000mm | | | |

| | | | |
|---|--|-----------------|------|
|  | 1 | | |
| Part No. | 520545 | Ref. No. | TC58 |
| description | PVC hose ID ø 5mm ED ø 8mm L 10m thickness 1.5mm t.max. 60°C transparent warewashing | | |

formed hoses

form L

| | | | |
|--|--|-----------------|------------|
|  | 1 | | |
| Part No. | 694923 | Ref. No. | GA18PS5USA |
| description | formed hose end piece A ext. ø 40mm end piece A int. ø 30mm AD2 ø 44mm end piece B 36mm L 90mm Qty 1 warewashing | | |

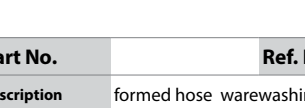
| | | | |
|--|-------------------------|-----------------|-------|
|  | 1 | | |
| Part No. | | Ref. No. | GASA6 |
| description | formed hose warewashing | | |

| | | | |
|---|---------------------------|-----------------|-----------|
|  | 1 | | |
| Part No. | 507414 | Ref. No. | GS120SPEC |
| description | formed hose warewashing L | | |

| | | | |
|--|--|-----------------|------|
|  | 1 | | |
| Part No. | 507090 | Ref. No. | GA18 |
| description | formed hose warewashing L-shape equiv. no. GA18 | | |
| For models: | DUE AQ, DUE AT, JOLLY AQ, JOLLY AT, JOLLY Q, JOLLY T, UNO AQ, UNO AT, UNO Q, UNO T | | |

| | | | |
|--|---|-----------------|------|
|  | 1 | | |
| Part No. | 507095 | Ref. No. | GA38 |
| description | formed hose warewashing L-shape equiv. no. GA38 | | |
| For models: | SEI 1P, SEI 2P, SEI 2P/S | | |





| | | | |
|---|--|-----------------|-------|
|  | | | |
| 1 | | | |
| Part No. | 507097 | Ref. No. | GA538 |
| description | formed hose warewashing L-shape equiv. no. GA538 | | |
| For models: | QUATTRO Q/82, QUATTRO T/82 | | |

| | | | |
|--|--|-----------------|-------|
|  | | | |
| 1 | | | |
| Part No. | 507213 | Ref. No. | GS520 |
| description | formed hose warewashing L-shape equiv. no. GS520 | | |
| For models: | QUATTRO Q/82, QUATTRO T/82 | | |

| | | | |
|---|--|-----------------|-------|
|  | | | |
| 1 | | | |
| Part No. | 507103 | Ref. No. | GASA8 |
| description | formed hose warewashing L-shape equiv. no. GASA8 | | |
| For models: | SEI 2P, SEI 2P/S | | |

| | | | |
|--|---|-----------------|--------|
|  | | | |
| 1 | | | |
| Part No. | 507328 | Ref. No. | GSMAPS |
| description | formed hose warewashing L-shape equiv. no. GSMAPS | | |
| For models: | DUE AQ, DUE AT, UNO AQ, UNO AT, UNO Q, UNO T | | |

| | | | |
|--|---|-----------------|--------|
|  | | | |
| 1 | | | |
| Part No. | 507216 | Ref. No. | GSMPS5 |
| description | formed hose warewashing L-shape equiv. no. GSMPS5 | | |
| For models: | QUATTRO Q/82, QUATTRO T/82 | | |

| | | | |
|---|---|-----------------|-------|
|  | | | |
| 1 | | | |
| Part No. | 507205 | Ref. No. | GS120 |
| description | formed hose warewashing L-shape equiv. no. GS120 hose int. ø 25mm | | |
| For models: | JOLLY AQ, JOLLY AT, JOLLY Q, JOLLY T, UNO AQ, UNO CLQ, UNO CSQ, UNO Q | | |

| | | | |
|--|--|-----------------|---------|
|  | | | |
| 1 | | | |
| Part No. | 507304 | Ref. No. | LSSA13A |
| description | formed hose warewashing L-shape equiv. no. LSSA13A | | |

| | | | |
|---|--|-----------------|-------|
|  | | | |
| 1 | | | |
| Part No. | 507208 | Ref. No. | GS220 |
| description | formed hose warewashing L-shape equiv. no. GS220 | | |
| For models: | DUE ACLQ, DUE ACSQ, DUE AQ | | |

| | | | |
|--|--|-----------------|----------|
| with branch | | | |
|  | | | |
| 1 | | | |
| Part No. | 507153 | Ref. No. | GLMSI61P |
| description | formed hose warewashing equiv. no. GLMSI61P with piggyback | | |
| For models: | SEI 1P | | |



1

| | | | |
|--------------------|---|-----------------|----------------------|
| Part No. | 507325 | Ref. No. | GLMSIC1 GLMSIC104 |
| description | formed hose warewashing equiv. no. GLMSIC1 with piggyback | | |
| For models: | UNO Q | | |



1

| | | | |
|--------------------|--|-----------------|------------------------|
| Part No. | 507326 | Ref. No. | GLMSIC2A GLMSIC2A04 |
| description | formed hose warewashing equiv. no. GLMSIC2A with piggyback | | |
| For models: | DUE AQ | | |



1

| | | | |
|--------------------|---|-----------------|----------------------|
| Part No. | 507327 | Ref. No. | GLMSIC4 GLMSIC404 |
| description | formed hose warewashing equiv. no. GLMSIC4 with piggyback | | |
| For models: | QUATTRO Q/82 | | |

form S



1

| | | | |
|--------------------|---|-----------------|---------|
| Part No. | 507253 | Ref. No. | LISA392 |
| description | formed hose for pump S-shape warewashing equiv. no. LISA392 mounting pos. upper | | |



1

| | | | |
|--------------------|---------------------------------|-----------------|--------|
| Part No. | 507241 | Ref. No. | LI6312 |
| description | formed hose S-shape warewashing | | |
| For models: | SEI 2P, SEI 2P/S | | |



1

| | | | |
|--------------------|---------------------------------|-----------------|-------|
| Part No. | 530818 | Ref. No. | DS327 |
| description | formed hose S-shape warewashing | | |

1

| | | | |
|--------------------|---|-----------------|--------|
| Part No. | 507138 | Ref. No. | GL1T22 |
| description | formed hose S-shape warewashing equiv. no. GL1T22 | | |
| For models: | JOLLY AQ, JOLLY AT, JOLLY Q, JOLLY T, UNO ACSQ, UNO ACST, UNO AT, UNO CLQ, UNO CLT, UNO CSQ, UNO CST, UNO T | | |



1

| | | | |
|--------------------|---|-----------------|--------|
| Part No. | 507144 | Ref. No. | GL2T22 |
| description | formed hose S-shape warewashing equiv. no. GL2T22 | | |
| For models: | DUE ACLQ, DUE ACLT, DUE ACSQ, DUE ACST, DUE AT | | |

form U



1

| | | | |
|--------------------|---------------------------------|-----------------|-----------|
| Part No. | 507394 | Ref. No. | LISA39206 |
| description | formed hose warewashing U-shape | | |

miscellaneous



1

| | | | |
|--------------------|---|-----------------|--------|
| Part No. | 507149 | Ref. No. | GL4T22 |
| description | formed hose warewashing equiv. no. GL4T22 | | |
| For models: | QUATTRO T/82 | | |

for dishwashers

miscellaneous

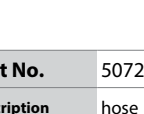

1

| | | | |
|--------------------|--------|-----------------|--------|
| Part No. | 507262 | Ref. No. | LS313B |
| description | hose | | |

fittings, hose and pipe connectors

hose connectors

without screw connection



1

| | | | |
|--------------------|--------------------------|-----------------|--------|
| Part No. | 507193 | Ref. No. | GR6183 |
| description | Y-piece | | |
| For models: | SEI 1P, SEI 2P, SEI 2P/S | | |



1

| | | | |
|--------------------|--------------------------------------|-----------------|--------|
| Part No. | 507174 | Ref. No. | GP RTP |
| description | T-piece plastic hose ø 4-4-4mm 3-way | | |
| For models: | QUATTRO Q/82, QUATTRO T/82 | | |



hose connectors

producer-specific





1

| | | | |
|------------------------|----------------------------|-----------------|-----------|
| Part No. | 507061 | Ref. No. | DSD ET040 |
| description | elbow connection | | |
| For models: | QUATTRO Q/82, QUATTRO T/82 | | |
| accessories for | 507061 | | |





| | | | | |
|---|--|--------|-----------------|------------------------------|
|  | Part No. | 507075 | Ref. No. | G15101G G1510G G16101G |
| | flat gasket rubber ED ø 15mm ID ø 10mm thickness 2mm Qty 1 pcs | | | |
|  | Part No. | 507330 | Ref. No. | VD101P1 |
| | nut thread M10x1 H 7mm WS 13 stainless steel Qty 1 pcs | | | |







| | | | |
|---|--------------------------|-----------------|----------|
|  | | | |
| 1 | | | |
| Part No. | 507063 | Ref. No. | DSEDT62P |
| description | elbow connection | | |
| For models: | SEI 1P, SEI 2P, SEI 2P/S | | |

| | | | |
|--|--|-----------------|-------------------|
|  | | | |
| 1 | | | |
| Part No. | 507194 | Ref. No. | GR193GR GR6193 |
| description | hose connector thread 3/8" angled L 23mm | | |
| For models: | SEI 1P, SEI 2P, SEI 2P/S | | |

| | | | |
|---|----------------|-----------------|--------|
|  | | | |
| 1 | | | |
| Part No. | 507176 | Ref. No. | GR016P |
| description | hose connector | | |
| For models: | QUATTRO T/82 | | |

| | | | |
|--|--|-----------------|--|
|  | | | |
| 1 | | | |
| Part No. | 520581 | Ref. No. | DSEDT040BGR |
| description | hose connector thread M10x1 for hose ID 5mm | | |
| accessories for | 520581 | | |
|  | Part No. | 507062 | Ref. No. DSEDT043 |
| | cap | | |
|  | Part No. | 507075 | Ref. No. G15101G G1510G G16101G |
| | flat gasket rubber ED ø 15mm ID ø 10mm thickness 2mm Qty 1 pcs | | |
|  | Part No. | 507330 | Ref. No. VD10IP1 |
| | nut thread M10x1 H 7mm WS 13 stainless steel Qty 1 pcs | | |

| | | | |
|---|---|-----------------|-------|
|  | | | |
| 1 | | | |
| Part No. | 507206 | Ref. No. | GS121 |
| description | hose connector | | |
| For models: | DUE ACLQ, DUE ACSQ, DUE AQ, JOLLY AQ, JOLLY AT, JOLLY Q, JOLLY T, UNO AQ, UNO CLQ, UNO CSQ, UNO Q | | |

| | | | |
|---|--|-----------------|--|
|  | | | |
| 1 | | | |
| Part No. | 521184 | Ref. No. | siehe Bemerkung |
| description | hose connector thread M10x1 for hose ID 5mm | | |
| spare parts for | 521184 | | |
|  | Part No. | 507062 | Ref. No. DSEDT043 |
| | cap | | |
|  | Part No. | 507075 | Ref. No. G15101G G1510G G16101G |
| | flat gasket rubber ED ø 15mm ID ø 10mm thickness 2mm Qty 1 pcs | | |
|  | Part No. | 507330 | Ref. No. VD10IP1 |
| | nut thread M10x1 H 7mm WS 13 stainless steel Qty 1 pcs | | |

| | | | |
|---|----------------------------|-----------------|-------|
|  | | | |
| 1 | | | |
| Part No. | 507210 | Ref. No. | GS321 |
| description | hose connector | | |
| For models: | QUATTRO Q/82, QUATTRO T/82 | | |

| | | | |
|---|--------------------------------|-----------------|------------|
|  | | | |
| 1 | | | |
| Part No. | 507340 | Ref. No. | DSEDTOT040 |
| description | hose connector connection 1/8" | | |

| | | | |
|---|----------------------------|-----------------|-----------|
|  | | | |
| 1 | | | |
| Part No. | 507004 | Ref. No. | ABPRIRS14 |
| description | hose connector thread 1/4" | | |

| | | | |
|--|--|-----------------|-------|
|  | | | |
| 1 | | | |
| Part No. | 507105 | Ref. No. | GB055 |
| description | manifold 4-way hose ø 13-13-13-13mm plastic | | |
| For models: | DUE ACLQ, DUE ACSQ, DUE AQ, JOLLY AQ, JOLLY Q, QUATTRO Q/82, QUATTRO T/82, UNO AQ, UNO CLQ, UNO CSQ, UNO Q | | |



| | | | |
|--------------------|------------------------------------|-----------------|-----------|
| | | | |
| 1 | | | |
| Part No. | 507001 | Ref. No. | ABPRIRA34 |
| description | screw connection T1: 3/4" T2: 1/4" | | |

| | | | |
|--------------------|---|-----------------|-------|
| | | | |
| 1 | | | |
| Part No. | 507104 | Ref. No. | GB017 |
| description | T-piece 3-way hose ø 13-13-13mm plastic | | |

| | | | |
|--------------------|---|-----------------|-------------------------|
| | | | |
| 1 | | | |
| Part No. | 560344 | Ref. No. | FAM46 FAM57 FAM58 |
| description | hose clamp ø 7-9mm wire gauge ø 1mm Qty 1 pcs | | |

| | | | |
|--------------------|--|-----------------|--------|
| | | | |
| 1 | | | |
| Part No. | 560503 | Ref. No. | FAM710 |
| description | hose clamp ø 8-10mm wire gauge ø 1mm Qty 1 pcs | | |

ancillary products

clamps

hose clamps

DIN 3017 - W2

| | | | |
|--------------------|--|-----------------|--------|
| | | | |
| 1 | | | |
| Part No. | 520115 | Ref. No. | FA3040 |
| description | hose clamp ø 25-40mm width 9mm Qty 10 pcs DIN 3017 | | |

DIN 3017 - W4

| | | | |
|--------------------|---|-----------------|--------|
| | | | |
| 1 | | | |
| Part No. | 520120 | Ref. No. | FA1220 |
| description | hose clamp SS W4 ø 12-20mm width 9mm Qty 1 pcs DIN 3017 | | |

double wire clamps

| | | | |
|--------------------|---|-----------------|---------|
| | | | |
| 1 | | | |
| Part No. | 520788 | Ref. No. | FAM4050 |
| description | hose clamp ø 43-50mm wire gauge ø 3.5mm Qty 1 pcs | | |

measuring equipment

thermometers

built-in thermometers

| | | | |
|--------------------|---|-----------------|-------|
| | | | |
| 1 | | | |
| Part No. | 541095 | Ref. No. | CETEM |
| description | thermometer mounting measurements 58x25.5mm 0 up to +120°C capillary pipe 3000mm probe ø 6.5mm probe L 20mm | | |
| For models: | SEI 2P | | |

fastening material

screws

sheet metal screws

| | | | |
|--------------------|---|-----------------|-----------|
| | | | |
| 1 | | | |
| Part No. | 560500 | Ref. No. | VATE4232Z |
| description | hexagonal screw ø 4mm L 35mm WS 7 zinc-plated Qty 1 pcs | | |

countersunk screws

| | | | |
|--------------------|---|-----------------|------------|
| | | | |
| 1 | | | |
| Part No. | 560044 | Ref. No. | VVTSEI616I |
| description | countersunk screw thread M6 L 16mm WS 4 SS DIN 7991/ISO 10642 Qty 20 pcs intake hexagonal | | |

| | | | |
|---|--|-----------------|------------|
|  | | | |
| 1 | | | |
| Part No. | 560337 | Ref. No. | VVTSEI625I |
| description | countersunk screw thread M6 L 20mm WS 4 SS DIN 7991/ISO 10642 Qty 1 pcs intake hexagonal | | |

| flat-headed bolts | | | |
|--------------------|---|-----------------|----------|
| | | | |
| 1 | | | |
| Part No. | 507320 | Ref. No. | VVTC410I |
| description | screw | | |
| For models: | DUE ACLQ, DUE ACLT, DUE ACSQ, DUE ACST, DUE AT, JOLLY AQ, JOLLY AT, JOLLY Q, JOLLY T, QUATTRO T/82, UNO ACSQ, UNO ACST, UNO AT, UNO CLQ, UNO CLT, UNO CSQ, UNO CST, UNO T | | |

| hexagonal screws | | | |
|--|---|-----------------|----------|
|  | | | |
| 1 | | | |
| Part No. | 560339 | Ref. No. | VVTE810I |
| description | hexagonal screw thread M8 thread L 10mm SS WS 13 Qty 1 pcs DIN 933 / ISO 4017 | | |

| cylinder head bolts | | | |
|---|--|-----------------|-----|
| DIN 912/ISO 4762 | | | |
|  | | | |
| 1 | | | |
| Part No. | 560025 | Ref. No. | N/A |
| description | cylinder head bolt thread M4 thread L 10mm WS 3 SS Qty 20 pcs DIN 912/ISO 4762 | | |

| | | | |
|---|---|-----------------|----------|
|  | | | |
| 1 | | | |
| Part No. | 560335 | Ref. No. | VVEI520I |
| description | cylinder head bolt thread M5 thread L 20mm WS 4 SS Qty 1 pcs DIN 912/ISO 4762 | | |

| | | | |
|---|---|-----------------|----------|
|  | | | |
| 1 | | | |
| Part No. | 560338 | Ref. No. | VVEI655I |
| description | cylinder head bolt thread M6 L 55mm thread L 25mm WS 4 intake hexagonal SS Qty 1 pcs DIN 912/ISO 4762 | | |

nuts

hexagonal nuts

DIN 934 / ISO 4032/8673

| | | | |
|---|---|-----------------|------|
|  | | | |
| 1 | | | |
| Part No. | 560340 | Ref. No. | VD4I |
| description | hexagonal nut thread M4 H 3.2mm WS 7 SS DIN/ISO DIN 934 / ISO 4032/8673 Qty 1 pcs | | |

| | | | |
|---|---|-----------------|------|
|  | | | |
| 1 | | | |
| Part No. | 560341 | Ref. No. | VD5I |
| description | hexagonal nut thread M5 H 3.5mm WS 8 SS DIN/ISO DIN 934 / ISO 4032/8673 Qty 1 pcs | | |

| | | | |
|---|--|-----------------|------|
|  | | | |
| 1 | | | |
| Part No. | 511212 | Ref. No. | VD6I |
| description | hexagonal nut thread M6 H 5mm WS 10 SS DIN/ISO DIN 934 / ISO 4032/8673 Qty 1 pcs | | |

| | | | |
|---|--|-----------------|----------|
|  | | | |
| 1 | | | |
| Part No. | 507331 | Ref. No. | VVDET62P |
| description | nut thread M12 H 10mm WS 19 SS DIN/ISO DIN 934 / ISO 4032/8673 Qty 1 pcs | | |

| hexagonal nuts metric (without norm) | | | |
|---|--|-----------------|---------|
|  | | | |
| 1 | | | |
| Part No. | 507330 | Ref. No. | VD10IP1 |
| description | nut thread M10x1 H 7mm WS 13 stainless steel Qty 1 pcs | | |
| For models: | DUE AQ, DUE AT, JOLLY AQ, JOLLY AT, JOLLY Q, JOLLY T, QUATTRO Q/82, QUATTRO T/82, UNO AQ, UNO AT, UNO Q, UNO T | | |



hexagonal nuts inch thread



1

| | | | |
|-----------------|--------|-----------------|------|
| Part No. | 507052 | Ref. No. | D034 |
|-----------------|--------|-----------------|------|

| | |
|--------------------|-------------------------------------|
| description | hexagonal nut thread 3/4" Qty 1 pcs |
|--------------------|-------------------------------------|



1

| | | | |
|-----------------|--------|-----------------|------|
| Part No. | 361182 | Ref. No. | VDRV |
|-----------------|--------|-----------------|------|

| | |
|--------------------|---|
| description | nut thread 1/4" H 5mm nickel-plated brass WS 17 Qty 1 pcs |
|--------------------|---|

| | |
|--------------------|---|
| For models: | DUE ACLQ, DUE ACSQ, DUE AQ, JOLLY AQ, JOLLY AT, JOLLY Q, JOLLY T, QUATTRO Q/82, QUATTRO T/82, UNO AQ, UNO CLQ, UNO CSQ, UNO Q |
|--------------------|---|



1

| | | | |
|-----------------|--------|-----------------|------|
| Part No. | 507051 | Ref. No. | D014 |
|-----------------|--------|-----------------|------|

| | |
|--------------------|---|
| description | nut thread 1/4" H 7.5mm brass WS 17 Qty 1 pcs |
|--------------------|---|



1

| | | | |
|-----------------|--------|-----------------|---------------|
| Part No. | 507054 | Ref. No. | D038 D038A |
|-----------------|--------|-----------------|---------------|

| | |
|--------------------|--|
| description | nut thread 3/8" H 10mm brass WS 20 Qty 1 pcs |
|--------------------|--|

| | |
|--------------------|---|
| For models: | DUE ACLQ, DUE ACSQ, DUE AQ, DUE AT, JOLLY AT, JOLLY T, QUATTRO Q/82, QUATTRO T/82, SEI 1P, SEI 2P, SEI 2P/S, UNO AQ, UNO AT, UNO CLQ, UNO CSQ, UNO Q, UNO T |
|--------------------|---|

washers

spring rings



1

| | | | |
|-----------------|--------|-----------------|-------|
| Part No. | 560336 | Ref. No. | VRG4I |
|-----------------|--------|-----------------|-------|

| | |
|--------------------|---|
| description | lock washer ID ø 4.2mm ED ø 8mm SS DIN127 Qty 1 pcs for thread M4 |
|--------------------|---|

washers

DIN 125A



1

| | | | |
|-----------------|--------|-----------------|--------|
| Part No. | 560334 | Ref. No. | VRP18I |
|-----------------|--------|-----------------|--------|

| | |
|--------------------|---|
| description | plain washer ID ø 19mm ED ø 34mm for thread M18 |
|--------------------|---|



1

| | | | |
|-----------------|--------|-----------------|-------|
| Part No. | 560333 | Ref. No. | VRP6I |
|-----------------|--------|-----------------|-------|

| | |
|--------------------|---|
| description | plain washer ID ø 6.4mm ED ø 12mm thickness 1.6mm SS Qty 1 pcs DIN 125A for thread M6 |
|--------------------|---|

miscellaneous



1

| | | | |
|-----------------|--------|-----------------|-----------------|
| Part No. | 507114 | Ref. No. | GG0T4 VRP16I |
|-----------------|--------|-----------------|-----------------|

| | |
|--------------------|--|
| description | disc D1 ø 30mm D2 ø 17mm thickness 3mm |
|--------------------|--|

| | |
|--------------------|--|
| For models: | DUE AT, JOLLY AT, JOLLY T, QUATTRO T/82, UNO AT, UNO T |
|--------------------|--|

tooth lock washers

DIN 6798A



1

| | | | |
|-----------------|--------|-----------------|------|
| Part No. | 560342 | Ref. No. | VR6I |
|-----------------|--------|-----------------|------|

| | |
|--------------------|---|
| description | tooth lock washer ID ø 6.5mm ED ø 11mm SS Qty 1 pcs for thread M6 |
|--------------------|---|

fasteners

clamps

hose clamps

DIN 3017 - W2





1

| | | | |
|-----------------|--------|-----------------|--------|
| Part No. | 520115 | Ref. No. | FA3040 |
|-----------------|--------|-----------------|--------|

| | |
|--------------------|--|
| description | hose clamp ø 25-40mm width 9mm Qty 10 pcs DIN 3017 |
|--------------------|--|





| DIN 3017 - W4 | | | |
|---|---|-----------------|--------|
|  | | | |
| 1 | | | |
| Part No. | 520120 | Ref. No. | FA1220 |
| description | hose clamp SS W4 ø 12-20mm width 9mm Qty 1 pcs DIN 3017 | | |

| double wire clamps | | | |
|---|---|-----------------|---------|
|  | | | |
| 1 | | | |
| Part No. | 520788 | Ref. No. | FAM4050 |
| description | hose clamp ø 43-50mm wire gauge ø 3.5mm Qty 1 pcs | | |

| | | | |
|---|---|-----------------|-------------------------|
|  | | | |
| 1 | | | |
| Part No. | 560344 | Ref. No. | FAM46 FAM57 FAM58 |
| description | hose clamp ø 7-9mm wire gauge ø 1mm Qty 1 pcs | | |

| | | | |
|---|--|-----------------|--------|
|  | | | |
| 1 | | | |
| Part No. | 560503 | Ref. No. | FAM710 |
| description | hose clamp ø 8-10mm wire gauge ø 1mm Qty 1 pcs | | |

| retaining rings | | | |
|---|-------------------------------------|-----------------|-------|
| DIN 471 | | | |
|  | | | |
| 1 | | | |
| Part No. | 507130 | Ref. No. | GG3TE |
| description | retaining ring shaft ø 12mm DIN 471 | | |
| For models: | QUATTRO T/82 | | |

| | | | |
|---|--|-----------------|-------|
|  | | | |
| 1 | | | |
| Part No. | 507121 | Ref. No. | GG1TE |
| description | retaining ring shaft ø 9mm DIN 471 | | |
| For models: | DUE AT, JOLLY AT, JOLLY T, UNO AT, UNO T | | |

| DIN 6799 | | | |
|---|--|-----------------|--------|
|  | | | |
| 1 | | | |
| Part No. | 507040 | Ref. No. | CEMP22 |
| description | retaining ring E D1 ø 4mm D2 ø 9mm SS DIN 6799 thickness 0.7mm | | |
| For models: | DUE AQ, DUE AT, JOLLY AQ, JOLLY AT, JOLLY Q, JOLLY T, QUATTRO Q/82, QUATTRO T/82, SEI 1P, SEI 2P, SEI 2P/S, UNO AQ, UNO AT, UNO Q, UNO T | | |

| | | | |
|---|---|-----------------|-------|
|  | | | |
| 1 | | | |
| Part No. | 507014 | Ref. No. | AM013 |
| description | retaining ring E D1 ø 7mm D2 ø 14mm SS DIN 6799 thickness 0.9mm | | |

| | | | |
|---|--|-----------------|---------|
|  | | | |
| 1 | | | |
| Part No. | 507015 | Ref. No. | AM013NT |
| description | retaining ring E D1 ø 7mm D2 ø 14mm SS DIN 6799 thickness 0.9mm for shaft ø 8-11mm | | |
| For models: | QUATTRO Q/82, QUATTRO T/82 | | |

consumables

fuses

fine fuses

| | | | |
|--|---|-----------------|-----------|
|  | | | |
| 1 | | | |
| Part No. | 358074 | Ref. No. | CEFU5205A |
| description | fine fuse size ø5x20mm 5A fast-acting rated 250V Qty 10 pcs | | |

fine fuse holders

| | | | |
|---|--------------------------|-----------------|---------|
|  | | | |
| 1 | | | |
| Part No. | 358512 | Ref. No. | CEMFSTR |
| description | fuse holder | | |
| For models: | SEI 1P, SEI 2P, SEI 2P/S | | |

GASTROPARTS.COM

