



**GASTROPARTS**

# Offcar

- [EN]** Equipment
- [DE]** Geräte
- [ES]** Aparatos
- [FR]** Équipement
- [IT]** Attrezzature
- [PL]** Urządzenia
- [RU]** Оборудование

✉ [gastroparts@gastroparts.com](mailto:gastroparts@gastroparts.com)

☎ tel. +48 56 657 00 66

📘 [fb.com/gastroparts.global](https://fb.com/gastroparts.global)

**GASTROPARTS.COM**





# heating elements

## heating elements for ovens

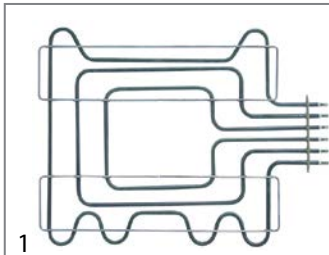

<b>Part No.</b>	416666	<b>Ref. No.</b>	843641
<b>description</b>	heating element 1800W 230/400V heating circuits 3 L 535mm W 448mm L1 75mm L2 460mm W1 150mm W2 128mm flange length 160mm flange width 22mm hole distance 144mm tube ø 8.5mm connection male faston 6.3mm rectangular flange oven mounting thread M5		

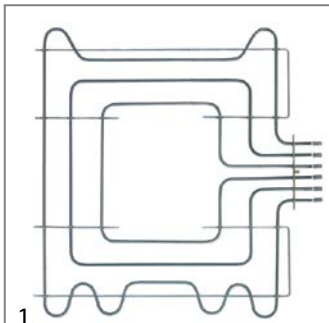

<b>Part No.</b>	416667	<b>Ref. No.</b>	843645
<b>description</b>	heating element 2750W 230/400V heating circuits 3 L 555mm W 618mm L1 58mm L2 497mm W1 248mm W2 122mm flange length 160mm flange width 22mm hole distance 144mm hole ø 4mm tube ø 8.5mm connection male faston 6.3mm connection length 58mm rectangular flange dry heating element oven		

## heating elements for fryers

### off-center connection

### with thread

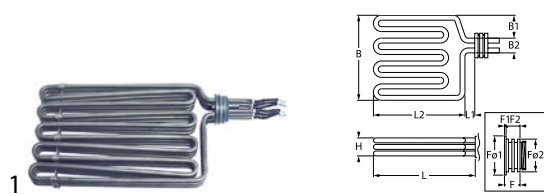

<b>Part No.</b>	416070	<b>Ref. No.</b>	862029
<b>description</b>	heating element 10200W 230/400V heating circuits 3 L 300mm W 180mm H 33mm flange length 19.5mm flange length 1 9.5mm flange length 2 9.8mm flange ø1 62mm flange ø2 57mm thermostat sleeves ø 6.5mm sensor screw connection 2x M10x1 thermostat sleeve upper/lower L1 18mm L2 282mm W1 30mm W2 35mm thread M54x1.5 windings 5 tube ø 8.5mm cable length 450mm rotation flange immersion heater fryer connection length 130mm 2		

<b>spare parts for</b>	416070			
	<b>Part No.</b>	510243	<b>Ref. No.</b>	—
		O-ring Viton thickness 3.53mm ID ø 55.56mm Qty 1 pcs		
	<b>Part No.</b>	550496	<b>Ref. No.</b>	—
		O-ring Viton thickness 3.53mm ID ø 50.39mm Qty 1 pcs		
<b>accessories for</b>	416070			
	<b>Part No.</b>	510243	<b>Ref. No.</b>	—
		O-ring Viton thickness 3.53mm ID ø 55.56mm Qty 1 pcs		

<b>accessories for</b>	416070			
	<b>Part No.</b>	550662	<b>Ref. No.</b>	862047
		ring nut thread M54x1.5 H 7mm		

	<b>Part No.</b>		<b>Ref. No.</b>	862029
<b>description</b>	heating element 10200W 230V heating circuits 3			

	<b>Part No.</b>		<b>Ref. No.</b>	862021
<b>description</b>	heating element 15000W 230V heating circuits 3			

### center connection

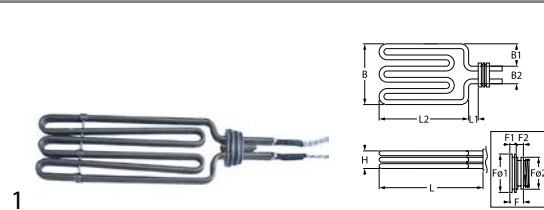

<b>Part No.</b>	415297	<b>Ref. No.</b>	862033
<b>description</b>	heating element 6800W 230/400V heating circuits 3 L 299mm W 107mm H 35mm flange length 19.5mm flange length 1 9.5mm flange length 2 9.8mm flange ø1 62mm flange ø2 57mm thermostat sleeves ø 8.5mm sensor screw connection 2x M10x1 thermostat sleeve upper/lower L1 16mm L2 283mm W1 30mm W2 77mm thread M54x1.5 tube ø 8.5mm cable length 450mm rotation flange immersion heater		

<b>accessories for</b>	415297			
	<b>Part No.</b>	510243	<b>Ref. No.</b>	—
		O-ring Viton thickness 3.53mm ID ø 55.56mm Qty 1 pcs		
	<b>Part No.</b>	510245	<b>Ref. No.</b>	862051 ACQ6507 ACQ6508
		O-ring Viton thickness 3.53mm ID ø 50.8mm Qty 1 pcs		
	<b>Part No.</b>	550447	<b>Ref. No.</b>	—
		ring nut thread M54x1.5		

## heating elements for griddles



<b>Part No.</b>	416668	<b>Ref. No.</b>	843627
<b>description</b>	heating element 1600W 230V heating circuits 1 L 366mm W 65mm H 62mm tube ø 8.5mm connection male faston 6.3mm dry heating element		





			
<b>Part No.</b>	416669	<b>Ref. No.</b>	843629
<b>description</b>	heating element 2000W 230V L 520mm W 83mm H 64mm tube ø 8.5mm connection male faston 6.3mm griddle dry heating element		

## heating elements for tilting bratt pan

			
<b>Part No.</b>	416692	<b>Ref. No.</b>	FX40400082
<b>description</b>	heating element tilting bratt pan 2900W 230V L 312mm W 200mm H 82mm connection M5 dry heating element heating circuits 1 tube ø 8.5mm W1 66mm W2 68mm connection distance 61mm		

## heating elements for pasta cookers

			
<b>Part No.</b>	416671	<b>Ref. No.</b>	443651 898983
<b>description</b>	heating element 1800W 230V heating circuits 1 L 315mm flange with thread thread 1 1/2" ø 30mm flange ø 70mm flange width 60mm thermostat sleeves ø 6.5mm length thermostat sleeves 255mm cable length 1000mm number of thermostat sleeves 1 pasta cooker thermostat sleeve eccentric, non clinging immersion heater		
<b>For models:</b>	CPE726, CPE730, CPE760		

			
<b>Part No.</b>	416670	<b>Ref. No.</b>	443655 898981
<b>description</b>	heating element 1800W 230V heating circuits 1 L 315mm Wmm Hmm flange with thread thread 1" ø 30mm flange ø 50mm flange width 45mm cable length 1000mm immersion heater		
<b>For models:</b>	CPE726, CPE730, CPE760		

			
<b>Part No.</b>	416686	<b>Ref. No.</b>	443681 898986
<b>description</b>	heating element 2500W 230V heating circuits 1 L 490mm flange with thread thread 1 1/2" ø 30mm flange ø 70mm flange width 60mm thermostat sleeves ø 6.5mm length thermostat sleeves 255mm cable length 1000mm number of thermostat sleeves 1 pasta cooker immersion heater		

			
<b>Part No.</b>	416685	<b>Ref. No.</b>	443685 898985
<b>description</b>	heating element 2500W 230V heating circuits 1 L 490mm Wmm Hmm thread 1" ø 30mm flange ø 50mm flange width 45mm cable length 1000mm pasta cooker immersion heater		

## heating cartridges

			
<b>Part No.</b>	416671	<b>Ref. No.</b>	443651 898983
<b>description</b>	heating element 1800W 230V heating circuits 1 L 315mm flange with thread thread 1 1/2" ø 30mm flange ø 70mm flange width 60mm thermostat sleeves ø 6.5mm length thermostat sleeves 255mm cable length 1000mm number of thermostat sleeves 1 pasta cooker thermostat sleeve eccentric, non clinging immersion heater		
<b>For models:</b>	CPE726, CPE730, CPE760		

			
<b>Part No.</b>	416670	<b>Ref. No.</b>	443655 898981
<b>description</b>	heating element 1800W 230V heating circuits 1 L 315mm Wmm Hmm flange with thread thread 1" ø 30mm flange ø 50mm flange width 45mm cable length 1000mm immersion heater		
<b>For models:</b>	CPE726, CPE730, CPE760		

			
<b>Part No.</b>	416686	<b>Ref. No.</b>	443681 898986
<b>description</b>	heating element 2500W 230V heating circuits 1 L 490mm flange with thread thread 1 1/2" ø 30mm flange ø 70mm flange width 60mm thermostat sleeves ø 6.5mm length thermostat sleeves 255mm cable length 1000mm number of thermostat sleeves 1 pasta cooker immersion heater		

			
<b>Part No.</b>	416685	<b>Ref. No.</b>	443685 898985
<b>description</b>	heating element 2500W 230V heating circuits 1 L 490mm Wmm Hmm thread 1" ø 30mm flange ø 50mm flange width 45mm cable length 1000mm pasta cooker immersion heater		



immersion heating elements

3 hole flange ø47.5mm

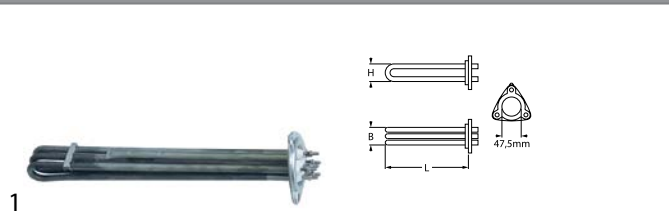

<b>Part No.</b>	416834	<b>Ref. No.</b>	FX40400040
-----------------	--------	-----------------	------------

**description** heating element 8000W 230V mounting ø 47.5mm heating circuits 3 L 323mm W 35mm H 45mm number of thermostat sleeves 1 thermostat sleeves ø 7mm length thermostat sleeves 263mm thermostat sleeve eccentric, clinging tube ø 8.5mm hole distance 64mm hole ø 8mm connection M4 3 hole flange immersion heater

**accessories for** 416834

<b>Part No.</b>	510408	<b>Ref. No.</b>	FX10500100
-----------------	--------	-----------------	------------

 O-ring EPDM thickness 5.34mm ID ø 47mm Qty 1 pcs

<b>Part No.</b>	510562	<b>Ref. No.</b>	—
-----------------	--------	-----------------	---

 O-ring silicone thickness 5.34mm ID ø 47mm Qty 1 pcs

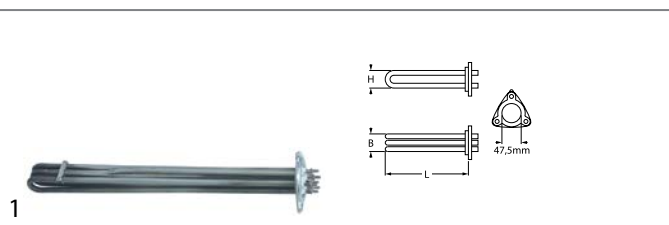

<b>Part No.</b>	416835	<b>Ref. No.</b>	FX40400042
-----------------	--------	-----------------	------------

**description** heating element 9000W 230V mounting ø 47.5mm heating circuits 3 L 415mm W 30mm H 46mm number of thermostat sleeves 1 thermostat sleeves ø 7.5mm length thermostat sleeves 255mm thermostat sleeve eccentric, clinging hole distance 62mm hole ø 8mm connection M4 3 hole flange immersion heater

**accessories for** 416835

<b>Part No.</b>	510408	<b>Ref. No.</b>	FX10500100
-----------------	--------	-----------------	------------

 O-ring EPDM thickness 5.34mm ID ø 47mm Qty 1 pcs

<b>Part No.</b>	510562	<b>Ref. No.</b>	—
-----------------	--------	-----------------	---

 O-ring silicone thickness 5.34mm ID ø 47mm Qty 1 pcs

foil heating elements

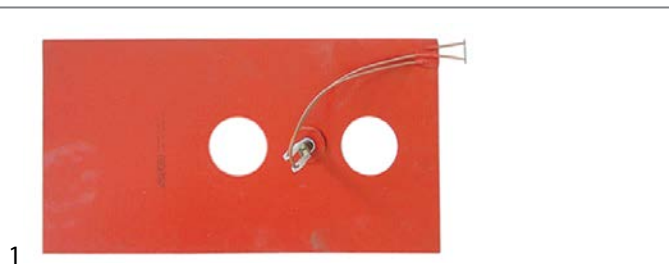

<b>Part No.</b>	416687	<b>Ref. No.</b>	843613
-----------------	--------	-----------------	--------

**description** foil heating element L 460mm W 250mm 1000W 230V t.max. 175°C with temperature limiter silicone cable length 500mm thickness 1mm



<b>Part No.</b>	416688	<b>Ref. No.</b>	843611
-----------------	--------	-----------------	--------

**description** foil heating element L 500mm W 290mm 1350W 230V t.max. 175°C with temperature limiter silicone cable length 500mm thickness 1mm

accessories

ring nuts

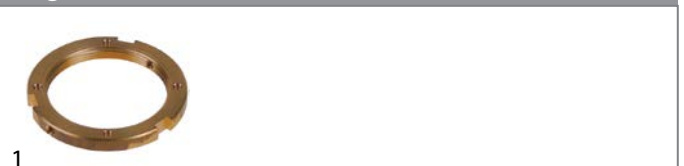

<b>Part No.</b>	550662	<b>Ref. No.</b>	862047
-----------------	--------	-----------------	--------

**description** ring nut thread M54x1.5 H 7mm

**accessories for** 550662

<b>Part No.</b>	550449	<b>Ref. No.</b>	—
-----------------	--------	-----------------	---

 special wrench for ring nut

sealing washers

O-rings

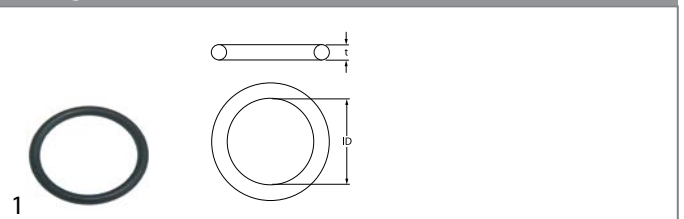

<b>Part No.</b>	510408	<b>Ref. No.</b>	FX10500100
-----------------	--------	-----------------	------------

**description** O-ring EPDM thickness 5.34mm ID ø 47mm Qty 1 pcs

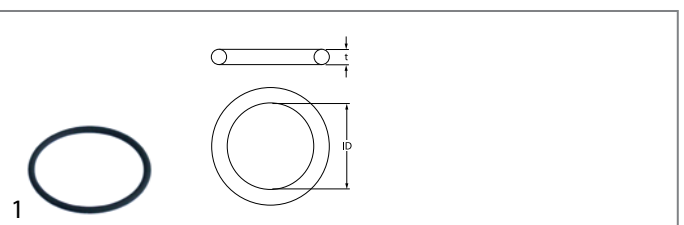

<b>Part No.</b>	510245	<b>Ref. No.</b>	862051 ACQ6507 ACQ6508
-----------------	--------	-----------------	------------------------------

**description** O-ring Viton thickness 3.53mm ID ø 50.8mm Qty 1 pcs



# hot plates

## square & rectangular

### with radiused edge



1

<b>Part No.</b>	490066 <sup>1</sup>	<b>Ref. No.</b>	843405
<b>description</b>	hot plate dimensions 220x220mm 2600W 230V with spill ring connection 4 screw clamps protector yes square		

<sup>1</sup>incl. protector



1

<b>Part No.</b>	490068 <sup>1</sup>	<b>Ref. No.</b>	843402
<b>description</b>	hot plate dimensions 220x220mm 2600W 400V with spill ring connection 4 screw clamps protector yes square		

<sup>1</sup>incl. protector



1

<b>Part No.</b>	490070	<b>Ref. No.</b>	843401
<b>description</b>	hot plate dimensions 300x300mm 3000W 230V with spill ring connection 4 screw clamps protector no square		



1

<b>Part No.</b>	490057 <sup>1</sup>	<b>Ref. No.</b>	843407
<b>description</b>	hot plate dimensions 300x300mm 3000W 400V with spill ring connection 4 screw clamps protector yes square		

<sup>1</sup>incl. protector



1

<b>Part No.</b>	490071 <sup>1</sup>	<b>Ref. No.</b>	843373
<b>description</b>	hot plate dimensions 300x300mm 4000W 230V with spill ring connection 4 screw clamps protector yes square		

<sup>1</sup>incl. protector

## round

### with radiused edge

#### for domestic and commercial kitchens



1

<b>Part No.</b>	490020	<b>Ref. No.</b>	843412 843413
<b>description</b>	hot plate ø 220mm 2600W 230V connection 4 screw clamps with 8mm spill ring		

<b>accessories for</b>	490020		
------------------------	--------	--	--

<b>Part No.</b>	550796	<b>Ref. No.</b>	—
-----------------	--------	-----------------	---

fixing plate for hot plate ø220mm

## thermostats

### control and safety thermostats

#### EGO

#### control thermostats

#### 55.10/19\_ series

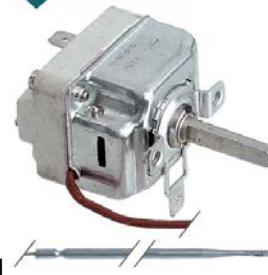

1

<b>Part No.</b>	375363	<b>Ref. No.</b>	FX40100050
-----------------	--------	-----------------	------------

<b>description</b>	thermostat t.max. 161°C temperature range 73-161°C 1-pole 1NO 16A probe ø 3mm probe L 144mm capillary pipe 1600mm capillary pipe isolated 1600mm gland nut shaft ø 6x4.6mm shaft L 23mm shaft position upper rotation 270°		
--------------------	--	--	--



**E·G·O**



**Part No.** 375270      **Ref. No.** FX40100042

**description** thermostat t.max. 295°C temperature range 45-295°C 1-pole 1NO 16A probe ø 4mm probe L 100mm capillary pipe 900mm capillary pipe isolated 350mm gland nut shaft L 23mm shaft position upper rotation 270°

safety thermostats

55.10/19\_ series

**E·G·O**



**Part No.** 375376      **Ref. No.** 862133

**description** safety thermostat capillary pipe 870mm probe ø 6mm 1-pole probe L 133mm 0.5A capillary pipe isolatedmm gland nut M10x1 switch-off temp. 224°C probe

55.13\_ series

**E·G·O**



**Part No.** 375492      **Ref. No.** 862115  
990301

**description** thermostat t.max. 190°C temperature range 94-190°C 1-pole 1NO 16A probe ø 6mm probe L 94mm capillary pipe 1090mm capillary pipe isolated 960mm gland nut M10x1 shaft ø 6x4.6mm shaft L 23mm shaft position upper rotation 310° probe material SS

55.32\_ series

**E·G·O**



**Part No.** 375993      **Ref. No.** 898979

**description** safety thermostat switch-off temp. 135°C 3-pole 1CO/2NC 20A probe ø 6mm probe L 89mm capillary pipe 390mm capillary pipe isolated 380mm gland nut

55.34\_ series

**E·G·O**



**Part No.** 375362      **Ref. No.** 843735

**description** thermostat t.max. 320°C temperature range 55-320°C 3-pole 3NO 10A probe ø 4mm probe L 128mm capillary pipe 900mm capillary pipe isolatedmm gland nut shaft ø 6x4.6mm shaft L 23mm shaft position upper rotation 270°

**E·G·O**



**Part No.** 375364      **Ref. No.** FX40100041

**description** safety thermostat switch-off temp. 190°C 3-pole 20A probe ø 4mm probe L 120mm capillary pipe 3000mm capillary pipe isolated 3000mm gland nut probe



E-G-O



<b>Part No.</b>	375984	<b>Ref. No.</b>	862124
<b>description</b>	safety thermostat switch-off temp. 225°C 3-pole 3NC 20A probe ø 6mm probe L 94mm capillary pipe 900mm capillary pipe isolated 670mm gland nut M10x1 probe SS		

E-G-O



<b>Part No.</b>	375375	<b>Ref. No.</b>	862123
<b>description</b>	safety thermostat switch-off temp. 230°C 3-pole 20A probe ø 6mm probe L 94mm capillary pipe 900mm capillary pipe isolated 670mm gland nut M10x1 probe SS		

E-G-O



<b>Part No.</b>	375228	<b>Ref. No.</b>	843737
<b>description</b>	safety thermostat switch-off temp. 350°C 3-pole 20A probe ø 3mm probe L 188mm capillary pipe 900mm capillary pipe isolated 900mm gland nut probe SS		

E-G-O

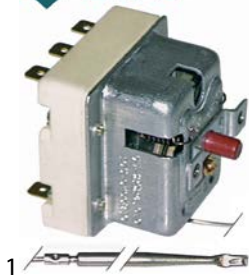

<b>Part No.</b>	375350	<b>Ref. No.</b>	FX40100062
<b>description</b>	safety thermostat switch-off temp. 360°C 3-pole 20A probe ø 4mm probe L 120mm capillary pipe 1800mm capillary pipe isolated 1800mm gland nut probe SS		

E-G-O

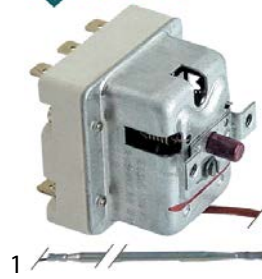

<b>Part No.</b>	390227	<b>Ref. No.</b>	FX40100062
<b>description</b>	safety thermostat switch-off temp. 360°C 3-pole 20A probe ø 4mm probe L 120mm capillary pipe 1800mm capillary pipe isolated 1800mm gland nut probe SS		

## 56.\_series

E-G-O



<b>Part No.</b>	375783	<b>Ref. No.</b>	ACQ6000
<b>description</b>	safety thermostat switch-off temp. 240°C 1-pole 0.5A probe ø 6mm probe L 77mm capillary pipe 860mm capillary pipe isolated 750mm gland nut M10x1 probe SS		

## IMIT / TEMPOMATIC / ARTHERMO

## control thermostats



<b>Part No.</b>	375564	<b>Ref. No.</b>	843791
<b>description</b>	thermostat t.max. 90°C temperature range 0-90°C 1-pole 1CO 15A probe ø 11mm probe L 36mm capillary pipe 600mm capillary pipe isolated 600mm gland nut shaft ø 6x4.6mm shaft L 19mm shaft position upper rotation 270° screw-in probe probe thread M14x1		

accessories for 375564



<b>Part No.</b>	550261	<b>Ref. No.</b>	—
nut thread M14x1 H 4mm WS 19 SS Qty 1 pcs			

## accessories

## connecting bows



<b>Part No.</b>	550060	<b>Ref. No.</b>	843753
<b>description</b>	connecting bow long for thermostat Qty 1 pcs		



## switches and momentary switches

### rocker/momentary rocker switches

30x22mm

labelled



1

<b>Part No.</b>	300125	<b>Ref. No.</b>	849451
-----------------	--------	-----------------	--------

**description** rocker switch mounting measurements 30x22mm green 2NO 230V 16A 0-1 connection male faston 6.3mm ambient temperature max. 125/55°C protection IP65 with cover cap

**accessories for** 300125



<b>Part No.</b>	301036	<b>Ref. No.</b>	—
<b>description</b>	protective cover internal size 30x22mm for rocker switch mounting measurementsmm		

### microswitches

lever actuated



1

<b>Part No.</b>	345254	<b>Ref. No.</b>	862311
-----------------	--------	-----------------	--------

**description** microswitch with lever 250V 16A 1CO connection male faston 6.3mm ambient temperature max. 120°C mounting distance 22mm actuating force: 60g lever length 58mm



1

<b>Part No.</b>	345044	<b>Ref. No.</b>	FX4010007
-----------------	--------	-----------------	-----------

**description** microswitch with lever 250V 16A 1CO connection male faston 6.3mm ambient temperature max. 85°C mounting distance 25mm type C99ZP3 actuating force: 25g lever length 71mm

### cam switches

on/off



1

<b>Part No.</b>	300129	<b>Ref. No.</b>	862323
-----------------	--------	-----------------	--------

**description** cam switch 2 operating positions 2NO sequence 0-1 16A shaft ø 6x4.6mm shaft L 23mm connection male faston 6.3mm ceramic

7-position



1

<b>Part No.</b>	300025	<b>Ref. No.</b>	843751
-----------------	--------	-----------------	--------

**description** cam switch 7 operating positions 1NO/2CO sequence 0-1-2-3-4-5-6 16A shaft ø 6x4.6mm shaft L 23mm connection screw 7-position ceramic

**accessories for** 300025



<b>Part No.</b>	112172	<b>Ref. No.</b>	—
<b>description</b>	knob universal ø 70mm black without adaptor/dial plate		



<b>Part No.</b>	112213	<b>Ref. No.</b>	—
<b>description</b>	knob dial plate silver switch 7-position t.max.°C ED ø 63mm ID ø 45.5mm		



<b>Part No.</b>	112311	<b>Ref. No.</b>	—
<b>description</b>	knob adapter shaft ø 6x4.6mm L 0mm with spring		

3 operating positions



1

<b>Part No.</b>	300167	<b>Ref. No.</b>	FX4010004 FX-SMP0936-00 FX-SMP0938-00
-----------------	--------	-----------------	---

**description** cam switch 3 operating positions 2NO/1CO sequence 0-1-2 16A shaft ø 6x4.6mm shaft L 23mm connection screw

4 operating positions



1

<b>Part No.</b>	300145	<b>Ref. No.</b>	898973
-----------------	--------	-----------------	--------

**description** cam switch 4 operating positions 4NO sequence 0-1-2-3 32A shaft ø 6x4.6mm shaft L 23mm connection screw ceramic

**For models:** CPE





## operation switches

E-G-O



1

<b>Part No.</b>	300166	<b>Ref. No.</b>	862317
<b>description</b>	cam switch 2 operating positions 4NO 16A sequence 0-1 shaft ø 6x4.6mm shaft L 23mm connection male faston 6.3mm ceramic 4-pole ambient temperature max. 318°C		

E-G-O



1

<b>Part No.</b>	300080	<b>Ref. No.</b>	843746 FX40100006
<b>description</b>	cam switch 2 operating positions 4NO 16A sequence 0-1 shaft ø 6x4.6mm shaft L 23mm connection screw operation switch ceramic ambient temperature max. 150°C		

accessories for 300080

	<b>Part No.</b>	551456	<b>Ref. No.</b>	—
	gasket for switch ED ø 14mm ID ø 2.5mm thickness 3.5mm white			



1

<b>Part No.</b>	300115	<b>Ref. No.</b>	843745
<b>description</b>	cam switch 2 operating positions operation switch sequence 0-1 shaft ø 6x4.6mm connection screw clamp 5-pole ambient temperature max. 318°C		

## rotary switches

BREMAS

A3200 series



1

<b>Part No.</b>	345817	<b>Ref. No.</b>	862325
<b>description</b>	rotary switch 2 0-1 sets of contacts 4 type CS0327690 600V 32A shaft ø 5x5mm shaft L 26mm shaft square connection screw		

## lamps

## indicator lights

## indicator light lenses

ø13mm (type SFK-3)



1

<b>Part No.</b>	359225	<b>Ref. No.</b>	862339 863339
<b>description</b>	indicator light housings mounting measurements ø13mm clear Qty 1 pcs		



1

<b>Part No.</b>	359126	<b>Ref. No.</b>	862333
<b>description</b>	indicator light housings mounting measurements ø13mm green Qty 1 pcs		

## indicator lamps for socket type SRZ / SDK / SDY / SFK



1

<b>Part No.</b>	359130	<b>Ref. No.</b>	862337
<b>description</b>	indicator lamp 230V clear connection male faston 6.3mm ø 8mm		



1

<b>Part No.</b>	359133	<b>Ref. No.</b>	FX40200154
<b>description</b>	indicator lamp 400V green connection male faston 6.3mm		



1

<b>Part No.</b>	359132	<b>Ref. No.</b>	862331
<b>description</b>	indicator lamp green 250V connection male faston 6.3mm protection IP54 ambient temperature max. 85°C		

## indicator lights (complete)

ø12mm

with screw socket





1

<b>Part No.</b>	359291	<b>Ref. No.</b>	FX40200152
<b>description</b>	indicator light ø 12mm 400V green connection male faston 6.3mm		



			
1			
<b>Part No.</b>	359292	<b>Ref. No.</b>	FX40200148
<b>description</b>	indicator light ø 12mm 400V red connection male faston 6.3mm		

			
1			
<b>Part No.</b>	359290	<b>Ref. No.</b>	FX40200150
<b>description</b>	indicator light ø 12mm 400V yellow connection male faston 6.3mm		

30x22mm			
			
1			
<b>Part No.</b>	359157	<b>Ref. No.</b>	849461
<b>description</b>	indicator light mounting measurements 30x22mm 230V green connection male faston 6.3mm temp.-resist. 125/55°C type RL2		
<b>accessories for</b>	359157		
	<b>Part No.</b>	<b>Ref. No.</b>	
	301036	—	
	protective cover internal size 30x22mm for rocker switch mounting measurementsmm		

			
1			
<b>Part No.</b>	359156	<b>Ref. No.</b>	849457
<b>description</b>	indicator light mounting measurements 30x22mm 230V yellow connection male faston 6.3mm temp.-resist. 125/55°C type RL2		

## contactors

### GENERAL ELECTRIC (AEG)

power contactors			
			
1			
<b>Part No.</b>	380244	<b>Ref. No.</b>	FX40100023
<b>description</b>	power contactor resistive load 25A 230VAC (AC3/400V) 9A/4kW main contacts 3NO auxiliary contacts 1NO connection screw connection type AEG LS4K 10A type GE CL00A 310		

### ISKRA (FANAL)

#### power contactors

			
1			
<b>Part No.</b>	380204	<b>Ref. No.</b>	862329
<b>description</b>	power contactor resistive load 25A 230VAC (AC3/400V) 9A/4kW main contacts 3NO auxiliary contacts 1NO connection screw connection type Fanal DSL9 10 type ISKRA KNL9 10		

### SIEMENS

#### power contactors

			
1			
<b>Part No.</b>	380389	<b>Ref. No.</b>	862329
<b>description</b>	power contactor resistive load 22A 230VAC (AC3/400V) 9A/4kW main contacts 3NO auxiliary contacts 1NO connection screw connection type 3RT10-16-1AP01		

## probes

### universal probes

#### temperature probes

			
1			
<b>Part No.</b>	379222 <sup>1</sup>	<b>Ref. No.</b>	862143
<b>description</b>	temperature probe Pt100 cable Vetrotex probe -200 up to +600°C cable -50 up to +350°C probe ø4x110mm cable length 1.4m 3-wire		

<sup>1</sup>3-wire



## electronics

## PCBs



1

<b>Part No.</b>	401171	<b>Ref. No.</b>	6010084
<b>description</b>	PCB combi-steamer		



1

<b>Part No.</b>	401167	<b>Ref. No.</b>	862221
<b>description</b>	PCB combi-steamer VE 06/10 230V 50/60Hz		

accessories for 401167

	<b>Part No.</b>	401062	<b>Ref. No.</b>	—
	buzzer board 230VAC L 48mm W 45mm connection Faston 6.3mm			

## fuses

## fine fuses



1

<b>Part No.</b>	358597	<b>Ref. No.</b>	40200084
<b>description</b>	fine fuse size ø5x20mm 0.5A slow-acting rated 250V Qty 10 pcs		



1

<b>Part No.</b>	358605	<b>Ref. No.</b>	40200080 FX-40200084
<b>description</b>	fine fuse size ø5x20mm 3.15A slow-acting rated 250V Qty 10 pcs		

## gas taps

## PEL

## 21S series



1

<b>Part No.</b>	101397	<b>Ref. No.</b>	401101
-----------------	--------	-----------------	--------

**description** gas tap PEL type 21S gas inlet M16x1.5 (tube ø 10mm) bypass nozzle ø 0.35mm gas outlet M16x1.5 (tube ø 10/8mm) thermocouple connection M9x1 pilot connection M10x1 shaft ø 8x6.5mm shaft L 22/15mm shaft flat lower

spare parts for 101397

	<b>Part No.</b>	100408	<b>Ref. No.</b>	—
	bypass nozzle type PEL20/21 bore ø 0.35mm thread M5x0.5			

	<b>Part No.</b>	101060	<b>Ref. No.</b>	835337
	magnet unit standard L 39mm D1 ø 15.4mm D2 ø 11mm suitable for PEL20-21/JUNKERS/EGA			

	<b>Part No.</b>	101206	<b>Ref. No.</b>	—
	gas tap front part shaft ø 8x6.5mm shaft L 22/15mm shaft flat upper/lower suitable for PEL21			

	<b>Part No.</b>	101231	<b>Ref. No.</b>	—
	thermocouple nut T1: M9x1 T2: M18x1			

accessories for 101397

	<b>Part No.</b>	100908	<b>Ref. No.</b>	—
	union screw thread M10x1 for pipe ø 4mm Qty 1 pcs			

	<b>Part No.</b>	100909	<b>Ref. No.</b>	—
	union screw thread M10x1 for pipe ø 6mm Qty 1 pcs			

	<b>Part No.</b>	101246	<b>Ref. No.</b>	—
	olive for pipe ø 4mm Qty 1 pcs			

	<b>Part No.</b>	101278	<b>Ref. No.</b>	—
	olive for pipe ø 10mm Qty 1 pcs			

	<b>Part No.</b>	101286	<b>Ref. No.</b>	—
	olive ID ø 6mm Qty 1 pcs			

	<b>Part No.</b>	101300	<b>Ref. No.</b>	—
	union nut thread M16x1.5 tube ø 10mm			

	<b>Part No.</b>	101450	<b>Ref. No.</b>	—
	olive for pipe ø 8mm L 12.7mm Qty 1 pcs ED ø 10mm			

	<b>Part No.</b>	101451	<b>Ref. No.</b>	—
	union nut thread M16x1.5 tube ø 8mm			





	<b>Part No.</b>	110081	<b>Ref. No.</b>	—
	knob ø 70mm shaft ø 8x6.5mm shaft flat universal			

	<b>Part No.</b>	112206	<b>Ref. No.</b>	—
	knob dial plate silver gas tap PEL21/22/23 t.max.°C ED ø 63mm ID ø 45.5mm			



			
1			
<b>Part No.</b>	106145	<b>Ref. No.</b>	401121
<b>description</b>	gas tap PEL type 21S gas inlet pipe flange ø21mm bypass nozzle ø 0.35mm gas outlet M16x1.5 (tube ø 10/8mm) thermocouple connection M9x1 pilot connection M10x1 shaft ø 8x6.5mm shaft L 22/15mm shaft flat lower		
<b>spare parts for</b>	106145		
	<b>Part No.</b>	100408	<b>Ref. No.</b> —
	bypass nozzle type PEL20/21 bore ø 0.35mm thread M5x0.5		
	<b>Part No.</b>	101060	<b>Ref. No.</b> 835337
	magnet unit standard L 39mm D1 ø 15.4mm D2 ø 11mm suitable for PEL20-21/JUNKERS/EGA		
	<b>Part No.</b>	101231	<b>Ref. No.</b> —
	thermocouple nut T1: M9x1 T2: M18x1		
	<b>Part No.</b>	101880	<b>Ref. No.</b> —
	gasket Viton ED ø 14mm ID ø 9mm thickness 7.7mm Qty 1 pcs		
<b>accessories for</b>	106145		
	<b>Part No.</b>	101277	<b>Ref. No.</b> —
	olive ID ø 8mm Qty 1 pcs		
	<b>Part No.</b>	101278	<b>Ref. No.</b> —
	olive for pipe ø 10mm Qty 1 pcs		
	<b>Part No.</b>	101300	<b>Ref. No.</b> —
	union nut thread M16x1.5 tube ø 10mm		
	<b>Part No.</b>	101451	<b>Ref. No.</b> —
	union nut thread M16x1.5 tube ø 8mm		

22S/O series

			
1			
<b>Part No.</b>	101086	<b>Ref. No.</b>	401151
<b>description</b>	gas tap PEL type 22S/O gas inlet M20x1.5 (tube ø 12mm) bypass nozzle ø 0.35mm gas outlet M20x1.5 (tube ø 12/10mm) thermocouple connection M9x1 pilot connection M10x1 shaft ø 10x8mm shaft L 25/17mm shaft flat lower		
<b>spare parts for</b>	101086		
	<b>Part No.</b>	100259	<b>Ref. No.</b> —
	bypass nozzle type PEL22 bore ø 0.35mm thread M6x0.5		
	<b>Part No.</b>	101058	<b>Ref. No.</b> —
	magnet unit L 39mm D1 ø 15.4mm D2 ø 13.5mm suitable for PEL22/EGA24197 standard		
	<b>Part No.</b>	101201	<b>Ref. No.</b> —
	gas tap front part shaft ø 10x8mm shaft L 25/17mm shaft flat upper/lower suitable for PEL22		
	<b>Part No.</b>	101231	<b>Ref. No.</b> —
	thermocouple nut T1: M9x1 T2: M18x1		

<b>spare parts for</b>	101086		
	<b>Part No.</b>	101240	<b>Ref. No.</b> —
	gas connection thread M20x1.5 tube ø 12/10mm for PEL gas taps with gasket and screws horizontal		
	<b>Part No.</b>	101460	<b>Ref. No.</b> —
	O-ring ø 12.37mm D1 ø 2.62mm suitable for PEL22		
	<b>Part No.</b>	101461	<b>Ref. No.</b> —
	screw kit suitable for PEL22 Qty 4 pcs		
<b>accessories for</b>	101086		
	<b>Part No.</b>	100908	<b>Ref. No.</b> —
	union screw thread M10x1 for pipe ø 4mm Qty 1 pcs		
	<b>Part No.</b>	100909	<b>Ref. No.</b> —
	union screw thread M10x1 for pipe ø 6mm Qty 1 pcs		
	<b>Part No.</b>	101241	<b>Ref. No.</b> —
	gas connection thread M20x1.5 tube ø 12/10mm for PEL gas taps vertical		
	<b>Part No.</b>	101246	<b>Ref. No.</b> —
	olive for pipe ø 4mm Qty 1 pcs		
	<b>Part No.</b>	101248	<b>Ref. No.</b> —
	olive for pipe ø 12mm Qty 1 pcs suitable for PEL		
	<b>Part No.</b>	101249	<b>Ref. No.</b> 835325
	olive for pipe ø 10mm Qty 1 pcs		
	<b>Part No.</b>	101250	<b>Ref. No.</b> —
	union nut thread M20x1.5 for pipe ø 10mm		
	<b>Part No.</b>	101251	<b>Ref. No.</b> —
	union nut thread M20x1.5 for pipe ø 12mm		
	<b>Part No.</b>	101286	<b>Ref. No.</b> —
	olive ID ø 6mm Qty 1 pcs		
	<b>Part No.</b>	110080	<b>Ref. No.</b> —
	knob ø 70mm shaft ø 10x8mm shaft flat universal		
	<b>Part No.</b>	112206	<b>Ref. No.</b> —
	knob dial plate silver gas tap PEL21/22/23 t.max.°C ED ø 63mm ID ø 45.5mm		















			
1			
<b>Part No.</b>	101892	<b>Ref. No.</b>	FX30100009
<b>description</b>	gas tap PEL type 22S/O gas inlet M20x1.5 (tube ø 12mm) bypass nozzle ø 0.35mm gas outlet M20x1.5 (tube ø 12/10mm) thermocouple connection M9x1 pilot connection M10x1 shaft ø 10x8mm shaft L 25/17mm shaft flat lower		
<b>spare parts for</b>	101892		
	<b>Part No.</b>	101058	<b>Ref. No.</b> —
	magnet unit L 39mm D1 ø 15.4mm D2 ø 13.5mm suitable for PEL22/EGA24197 standard		

Table continues overleaf



spare parts for		101892	
	Part No.	101201	Ref. No. —
gas tap front part shaft $\varnothing$ 10x8mm shaft L 25/17mm shaft flat upper/lower suitable for PEL22			
	Part No.	101231	Ref. No. —
thermocouple nut T1: M9x1 T2: M18x1			
	Part No.	101240	Ref. No. —
gas connection thread M20x1.5 tube $\varnothing$ 12/10mm for PEL gas taps with gasket and screws horizontal			
	Part No.	101460	Ref. No. —
O-ring $\varnothing$ 12.37mm D1 $\varnothing$ 2.62mm suitable for PEL22			
	Part No.	101461	Ref. No. —
screw kit suitable for PEL22 Qty 4 pcs			
accessories for		101892	
	Part No.	100908	Ref. No. —
union screw thread M10x1 for pipe $\varnothing$ 4mm Qty 1 pcs			
	Part No.	100909	Ref. No. —
union screw thread M10x1 for pipe $\varnothing$ 6mm Qty 1 pcs			
	Part No.	101246	Ref. No. —
olive for pipe $\varnothing$ 4mm Qty 1 pcs			
	Part No.	101248	Ref. No. —
olive for pipe $\varnothing$ 12mm Qty 1 pcs suitable for PEL			
	Part No.	101249	Ref. No. 835325
olive for pipe $\varnothing$ 10mm Qty 1 pcs			
	Part No.	101250	Ref. No. —
union nut thread M20x1.5 for pipe $\varnothing$ 10mm			
	Part No.	101251	Ref. No. —
union nut thread M20x1.5 for pipe $\varnothing$ 12mm			
	Part No.	101286	Ref. No. —
olive ID $\varnothing$ 6mm Qty 1 pcs			
	Part No.	110080	Ref. No. —
knob $\varnothing$ 70mm shaft $\varnothing$ 10x8mm shaft flat universal			
	Part No.	112206	Ref. No. —
knob dial plate silver gas tap PEL21/22/23 t.max.°C ED $\varnothing$ 63mm ID $\varnothing$ 45.5mm			

## 23S/O series



















Part No.	101893	Ref. No.	FX30100003
<b>description</b>	gas tap PEL type 23S/O gas inlet M28x1.5 (tube $\varnothing$ 20mm) bypass nozzle $\varnothing$ 0.35mm gas outlet M24x1.5 (tube $\varnothing$ 16mm) thermocouple connection M9x1 pilot connection M10x1 shaft $\varnothing$ 10x8mm shaft L 25/17mm shaft flat lower		
spare parts for		101893	
	Part No.	101045	Ref. No. —
magnet unit T1: M9x1 T2: M22x1 L 46mm $\varnothing$ 18mm suitable for PEL23S M9x1			
	Part No.	101204	Ref. No. —
gas tap front part shaft $\varnothing$ 10x8mm shaft L 25/17mm shaft flat upper/lower suitable for PEL23S			
	Part No.	101244	Ref. No. —
gas connection thread M24x1.5 tube $\varnothing$ 12/16mm horizontal for PEL gas taps			
	Part No.	101463	Ref. No. —
screw suitable for PEL23S Qty 4 pcs			
	Part No.	528455	Ref. No. —
O-ring Viton thickness 2.62mm ID $\varnothing$ 18.72mm Qty 1 pcs			
accessories for		101893	
	Part No.	100908	Ref. No. —
union screw thread M10x1 for pipe $\varnothing$ 4mm Qty 1 pcs			
	Part No.	100909	Ref. No. —
union screw thread M10x1 for pipe $\varnothing$ 6mm Qty 1 pcs			
	Part No.	101246	Ref. No. —
olive for pipe $\varnothing$ 4mm Qty 1 pcs			
	Part No.	101252	Ref. No. —
union nut thread M24x1.5 for pipe $\varnothing$ 12mm			
	Part No.	101253	Ref. No. —
union nut thread M24x1.5 PEL for pipe $\varnothing$ 16mm			
	Part No.	101254	Ref. No. —
union nut thread M28x1.5 tube $\varnothing$ 20mm			
	Part No.	101255	Ref. No. —
olive for pipe $\varnothing$ 12mm Qty 1 pcs			
	Part No.	101256	Ref. No. —
olive for pipe $\varnothing$ 16mm Qty 1 pcs			
	Part No.	101257	Ref. No. —
olive for pipe $\varnothing$ 20mm Qty 1 pcs			
	Part No.	101286	Ref. No. —
olive ID $\varnothing$ 6mm Qty 1 pcs			

Table continues overleaf















<b>accessories for</b>	101893			
	Part No.	110080	Ref. No.	—
	knob ø 70mm shaft ø 10x8mm shaft flat universal			
	Part No.	112206	Ref. No.	—
	knob dial plate silver gas tap PEL21/22/23 t.max.°C ED ø 63mm ID ø 45.5mm			

## gas thermostats

### SIT

#### 630 Eurosit series

				
<b>Part No.</b>	101125	<b>Ref. No.</b>	FX30100080	
<b>description</b>	gas thermostat type 630 Eurosit series t.max. 340°C 100-340°C gas inlet 3/8" gas outlet 3/8" thermocouple connection M9x1 pilot connection M10x1 probe ø 4mm probe L 72mm capillary pipe 1050mm SIT			
<b>accessories for</b>	101125			
	Part No.	100825	Ref. No.	—
	gas tap spindle shaft ø 8x6.5mm shaft L 22/14mm suitable for EUROSIT			
	Part No.	100904	Ref. No.	—
	locking screw M10x1 for pipe ø 4mm Qty 1 pcs			
	Part No.	100905	Ref. No.	—
	locking screw M10x1 for pipe ø 6mm Qty 1 pcs			
	Part No.	100949	Ref. No.	—
	gasket suitable for 630 Eurosit series			
	Part No.	101273	Ref. No.	—
	olive for pipe ø 12mm L 9.5mm brass Qty 1 pcs suitable for universal			
	Part No.	101276	Ref. No.	—
	union screw thread 3/8" tube ø 12mm Qty 1 pcs			
	Part No.	101333	Ref. No.	—
	plug thread 3/8" with O-ring			
	Part No.	101390	Ref. No.	—
	gas tap spindle shaft ø 6x4.6mm shaft L 32/15mm gas tap with ignition flame suitable for ZANUSSI, MARENO for gas thermostat EUROSIT			
	Part No.	101392	Ref. No.	—
	adapter suitable for 630 Eurosit series			
	Part No.	110357	Ref. No.	—
	gas tap spindle shaft ø 8x6.5mm shaft L 36/12mm suitable for 630 Eurosit series			
	Part No.	110358	Ref. No.	—
	adapter shaft ø 10x8mm shaft L 29/18mm suitable for 630 Eurosit series			

#### 710 Minisit series













				
<b>Part No.</b>	101135	<b>Ref. No.</b>	863811	
<b>description</b>	gas thermostat SIT type MINISIT 710 t.max. 190°C 110-190°C gas inlet 1/2" gas outlet 3/8" thermocouple connection M9x1 pilot connection M10x1 probe ø 6mm probe L 102mm capillary pipe 1050mm probe type type A3 pressure controller no pressure regulatormbar gland nut			
<b>spare parts for</b>	101135			
	Part No.	101053	Ref. No.	837119
	magnet unit T1: M9x1 T2: M24x1 L 45mm ø 17mm suitable for Minisit			
	Part No.	102118	Ref. No.	863801
	probe 110-190°C probe ø 6mm probe L 102mm capillary pipe 1050mm t.max. 190°C fryer probe type type A3 suitable for MINISIT 710			
<b>accessories for</b>	101135			
	Part No.	100809	Ref. No.	—
	O-ring EPDM thickness 2mm ID ø 21mm Qty 1 pcs			
	Part No.	100820	Ref. No.	—
	gland duct ET M14x1.5 IT M10x0.75 probe ø max. 6.5mm WS 22			
	Part No.	100904	Ref. No.	—
	locking screw M10x1 for pipe ø 4mm Qty 1 pcs			
	Part No.	100905	Ref. No.	—
	locking screw M10x1 for pipe ø 6mm Qty 1 pcs			
	Part No.	101054	Ref. No.	—
	magnet unit T1: M10x1 T2: M24x1 L 45mm ø 17mm suitable for Minisit			
	Part No.	101136	Ref. No.	835729
	piezoelectric igniter suitable for Minisit with cover cap ømm connection F6.3x0.8			
	Part No.	101137	Ref. No.	—
	cover cap without piezoelectric igniter			
	Part No.	101267	Ref. No.	—
	reducer IT 3/8" ET 1/2" L 21mm			
	Part No.	101268	Ref. No.	—
	gas connection thread 3/8" angled with O-ring MINISIT 710			
	Part No.	101269	Ref. No.	—
	gas connection thread 1/2" angled with O-ring MINISIT 710			
	Part No.	101270	Ref. No.	—
	screw connection IT 3/8" ET 3/8" L 28mm			
	Part No.	101272	Ref. No.	—
	screw connection IT 1/2" ET 3/8" L 57mm			

Table continues overleaf



accessories for		101135		
Part No.	101273	Ref. No.	—	
	olive for pipe ø 12mm L 9.5mm brass Qty 1 pcs suitable for universal			
Part No.	101274	Ref. No.	—	
	olive for pipe ø 16mm Qty 1 pcs			
Part No.	101275	Ref. No.	—	
	union screw thread 1/2" for pipe ø 16mm Qty 1 pcs			
Part No.	101276	Ref. No.	—	
	union screw thread 3/8" tube ø 12mm Qty 1 pcs			
Part No.	110068	Ref. No.	835721	
	knob suitable for Minisit ø 37mm			

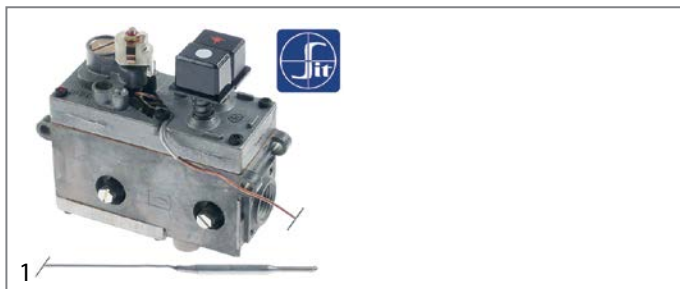

Part No.	101132	Ref. No.	835701	
----------	--------	----------	--------	--

**description**  
gas thermostat SIT type MINISIT 710 t.max. 340°C 100-340°C gas inlet 1/2" gas outlet 3/8" thermocouple connection M9x1 pilot connection M10x1 probe ø 5mm probe L 68mm capillary pipe 1050mm probe type type B1 pressure controller no pressure regulator mbar gland nut ignition gas no

**spare parts for** 101132

Part No.	101053	Ref. No.	837119	
----------	--------	----------	--------	--

magnet unit T1: M9x1 T2: M24x1 L 45mm ø 17mm suitable for Minisit

Part No.	102102	Ref. No.	837111	
----------	--------	----------	--------	--

probe 100-340°C probe ø 5mm probe L 68mm capillary pipe 1750mm t.max. 340°C oven/grill probe type type B1 suitable for MINISIT 710

**accessories for** 101132

Part No.	100809	Ref. No.	—	
----------	--------	----------	---	--

O-ring EPDM thickness 2mm ID ø 21mm Qty 1 pcs

Part No.	100904	Ref. No.	—	
----------	--------	----------	---	--

locking screw M10x1 for pipe ø 4mm Qty 1 pcs

Part No.	100905	Ref. No.	—	
----------	--------	----------	---	--

locking screw M10x1 for pipe ø 6mm Qty 1 pcs

Part No.	101054	Ref. No.	—	
----------	--------	----------	---	--

magnet unit T1: M10x1 T2: M24x1 L 45mm ø 17mm suitable for Minisit

Part No.	101136	Ref. No.	835729	
----------	--------	----------	--------	--

piezoelectric igniter suitable for Minisit with cover cap ømm connection F6.3x0.8

Part No.	101137	Ref. No.	—	
----------	--------	----------	---	--

cover cap without piezoelectric igniter

Part No.	101267	Ref. No.	—	
----------	--------	----------	---	--

reducer IT 3/8" ET 1/2" L 21mm

Part No.	101268	Ref. No.	—	
----------	--------	----------	---	--

gas connection thread 3/8" angled with O-ring MINISIT 710

Part No.	101269	Ref. No.	—	
----------	--------	----------	---	--

gas connection thread 1/2" angled with O-ring MINISIT 710

Part No.	101270	Ref. No.	—	
----------	--------	----------	---	--

screw connection IT 3/8" ET 3/8" L 28mm

Part No.	101272	Ref. No.	—	
----------	--------	----------	---	--

screw connection IT 1/2" ET 3/8" L 57mm

Part No.	101273	Ref. No.	—	
----------	--------	----------	---	--

olive for pipe ø 12mm L 9.5mm brass Qty 1 pcs suitable for universal

Part No.	101274	Ref. No.	—	
----------	--------	----------	---	--

olive for pipe ø 16mm Qty 1 pcs

Part No.	101275	Ref. No.	—	
----------	--------	----------	---	--

union screw thread 1/2" for pipe ø 16mm Qty 1 pcs

Part No.	101276	Ref. No.	—	
----------	--------	----------	---	--

union screw thread 3/8" tube ø 12mm Qty 1 pcs

Part No.	110068	Ref. No.	835721	
----------	--------	----------	--------	--

knob suitable for Minisit ø 37mm

accessories for		101132		
Part No.	101268	Ref. No.	—	
	gas connection thread 3/8" angled with O-ring MINISIT 710			
Part No.	101269	Ref. No.	—	
	gas connection thread 1/2" angled with O-ring MINISIT 710			
Part No.	101270	Ref. No.	—	
	screw connection IT 3/8" ET 3/8" L 28mm			
Part No.	101272	Ref. No.	—	
	screw connection IT 1/2" ET 3/8" L 57mm			
Part No.	101273	Ref. No.	—	
	olive for pipe ø 12mm L 9.5mm brass Qty 1 pcs suitable for universal			
Part No.	101274	Ref. No.	—	
	olive for pipe ø 16mm Qty 1 pcs			
Part No.	101275	Ref. No.	—	
	union screw thread 1/2" for pipe ø 16mm Qty 1 pcs			
Part No.	101276	Ref. No.	—	
	union screw thread 3/8" tube ø 12mm Qty 1 pcs			
Part No.	110068	Ref. No.	835721	
	knob suitable for Minisit ø 37mm			

**accessories**

**probes**



Part No.	102102	Ref. No.	837111	
----------	--------	----------	--------	--

**description**  
probe 100-340°C probe ø 5mm probe L 68mm capillary pipe 1750mm t.max. 340°C oven/grill probe type type B1 suitable for MINISIT 710

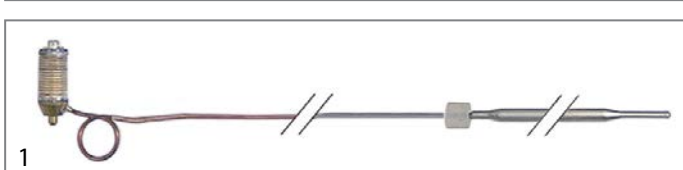

Part No.	102118	Ref. No.	863801	
----------	--------	----------	--------	--

**description**  
probe 110-190°C probe ø 6mm probe L 102mm capillary pipe 1050mm t.max. 190°C fryer probe type type A3 suitable for MINISIT 710

**accessories for** 102118

Part No.	100820	Ref. No.	—	
----------	--------	----------	---	--





gland duct ET M14x1.5 IT M10x0.75 probe ø max. 6.5mm WS 22



PEL

24ST series



<b>Part No.</b>	101076	<b>Ref. No.</b>	401201
<b>description</b>	gas thermostat PEL type 24ST 120-320°C gas inlet M20x1.5 (tube ø 12mm) bypass nozzle ø 0.35mm gas outlet M20x1.5 (tube ø 12/10mm) thermocouple connection M9x1 pilot connection M10x1 capillary pipe 1200mm probe ø 6mm probe L 100mm shaft ø 10x8mm shaft L 27/17mm shaft flat upper		
<b>spare parts for</b>	101076		
	Part No.	100455	Ref. No. —
	bypass nozzle type PEL23/24 bore ø 0.35mm thread M8x0.5		
	Part No.	101058	Ref. No. —
	magnet unit L 39mm D1 ø 15.4mm D2 ø 13.5mm suitable for PEL22/EGA24197 standard		
	Part No.	106200	Ref. No. —
	nut thread M9x1 suitable for PEL 24/255		
<b>accessories for</b>	101076		
	Part No.	100908	Ref. No. —
	union screw thread M10x1 for pipe ø 4mm Qty 1 pcs		
	Part No.	100909	Ref. No. —
	union screw thread M10x1 for pipe ø 6mm Qty 1 pcs		
	Part No.	101246	Ref. No. —
	olive for pipe ø 4mm Qty 1 pcs		
	Part No.	101248	Ref. No. —
	olive for pipe ø 12mm Qty 1 pcs suitable for PEL		
	Part No.	101249	Ref. No. 835325
	olive for pipe ø 10mm Qty 1 pcs		
	Part No.	101250	Ref. No. —
	union nut thread M20x1.5 for pipe ø 10mm		
	Part No.	101251	Ref. No. —
	union nut thread M20x1.5 for pipe ø 12mm		
	Part No.	101286	Ref. No. —
	olive ID ø 6mm Qty 1 pcs		
	Part No.	110079	Ref. No. —
	knob dial plate gas thermostat 1-8 silver		
	Part No.	110080	Ref. No. —
	knob ø 70mm shaft ø 10x8mm shaft flat universal		

25ST series



<b>Part No.</b>	101172	<b>Ref. No.</b>	401251
<b>description</b>	gas thermostat PEL type 25ST 100-300°C gas inlet M16x1.5 (tube ø 10mm) bypass nozzle ø 0.35mm gas outlet M16x1.5 (tube ø 10/8mm) thermocouple connection M9x1 pilot connection M10x1 capillary pipe 1200mm probe ø 6mm probe L 100mm shaft ø 8x6.5mm shaft L 21/15mm shaft flat upper		
<b>spare parts for</b>	101172		
	Part No.	100259	Ref. No. —
	bypass nozzle type PEL22 bore ø 0.35mm thread M6x0.5		
	Part No.	101060	Ref. No. 835337
	magnet unit standard L 39mm D1 ø 15.4mm D2 ø 11mm suitable for PEL20-21/JUNKERS/EGA		
	Part No.	106200	Ref. No. —
	nut thread M9x1 suitable for PEL 24/255		
<b>accessories for</b>	101172		
	Part No.	100908	Ref. No. —
	union screw thread M10x1 for pipe ø 4mm Qty 1 pcs		
	Part No.	100909	Ref. No. —
	union screw thread M10x1 for pipe ø 6mm Qty 1 pcs		
	Part No.	101246	Ref. No. —
	olive for pipe ø 4mm Qty 1 pcs		
	Part No.	101278	Ref. No. —
	olive for pipe ø 10mm Qty 1 pcs		
	Part No.	101286	Ref. No. —
	olive ID ø 6mm Qty 1 pcs		
	Part No.	101300	Ref. No. —
	union nut thread M16x1.5 tube ø 10mm		
	Part No.	101450	Ref. No. —
	olive for pipe ø 8mm L 12.7mm Qty 1 pcs ED ø 10mm		
	Part No.	101451	Ref. No. —
	union nut thread M16x1.5 tube ø 8mm		
	Part No.	110079	Ref. No. —
	knob dial plate gas thermostat 1-8 silver		
	Part No.	110081	Ref. No. —
	knob ø 70mm shaft ø 8x6.5mm shaft flat universal		





			
1			
<b>Part No.</b>	101901	<b>Ref. No.</b>	401261
<b>description</b>	gas thermostat PEL type 25ST 50-300°C gas inlet pipe flange ø21mm bypass nozzle ø 0.35mm gas outlet M16x1.5 (tube ø 10/8mm) thermocouple connection M9x1 pilot connection M10x1 capillary pipe 1200mm probe ø 6mm probe L 100mm shaft ø 8x6.5mm shaft L 21/15mm shaft flat upper		
<b>spare parts for</b>	101901		
	<b>Part No.</b>	100259	<b>Ref. No.</b> —
	bypass nozzle type PEL22 bore ø 0.35mm thread M6x0.5		
	<b>Part No.</b>	101060	<b>Ref. No.</b> 835337
	magnet unit standard L 39mm D1 ø 15.4mm D2 ø 11mm suitable for PEL20-21/JUNKERS/EGA		
	<b>Part No.</b>	106200	<b>Ref. No.</b> —
	nut thread M9x1 suitable for PEL 24/25S		
<b>accessories for</b>	101901		
	<b>Part No.</b>	100908	<b>Ref. No.</b> —
	union screw thread M10x1 for pipe ø 4mm Qty 1 pcs		
	<b>Part No.</b>	100909	<b>Ref. No.</b> —
	union screw thread M10x1 for pipe ø 6mm Qty 1 pcs		
	<b>Part No.</b>	101246	<b>Ref. No.</b> —
	olive for pipe ø 4mm Qty 1 pcs		
	<b>Part No.</b>	101278	<b>Ref. No.</b> —
	olive for pipe ø 10mm Qty 1 pcs		
	<b>Part No.</b>	101286	<b>Ref. No.</b> —
	olive ID ø 6mm Qty 1 pcs		
	<b>Part No.</b>	101300	<b>Ref. No.</b> —
	union nut thread M16x1.5 tube ø 10mm		
	<b>Part No.</b>	101450	<b>Ref. No.</b> —
	olive for pipe ø 8mm L 12.7mm Qty 1 pcs ED ø 10mm		
	<b>Part No.</b>	101451	<b>Ref. No.</b> —
	union nut thread M16x1.5 tube ø 8mm		
	<b>Part No.</b>	110079	<b>Ref. No.</b> —
	knob dial plate gas thermostat 1-8 silver		
	<b>Part No.</b>	110081	<b>Ref. No.</b> —
	knob ø 70mm shaft ø 8x6.5mm shaft flat universal		

## ignition parts









## pilot burners

SIT

100 series



1

<b>Part No.</b>	106901	<b>Ref. No.</b>	837201 899969
<b>description</b>	pilot burner SIT type 100 series 1 flame nozzle ø 0.2mm gas connection 6mm		
<b>spare parts for</b>	106901		
	<b>Part No.</b>	100854	<b>Ref. No.</b> —
	pilot burner bracket double		
	<b>Part No.</b>	100916	<b>Ref. No.</b> —
	compression spring for pilot burner Qty 1 pcs		
	<b>Part No.</b>	100917	<b>Ref. No.</b> —
	gasket for pilot burner Qty 1 pcs aluminium		
	<b>Part No.</b>	100918	<b>Ref. No.</b> —
	screw for pilot burner		
<b>accessories for</b>	106901		
	<b>Part No.</b>	100904	<b>Ref. No.</b> —
	locking screw M10x1 for pipe ø 4mm Qty 1 pcs		
	<b>Part No.</b>	100905	<b>Ref. No.</b> —
	locking screw M10x1 for pipe ø 6mm Qty 1 pcs		
	<b>Part No.</b>	102110	<b>Ref. No.</b> —
	pilot tube copper pipe ø 4mm thickness 1mm L 3000mm		
	<b>Part No.</b>	102111	<b>Ref. No.</b> —
	pilot tube copper pipe ø 6mm thickness 1mm L 3000mm		
	<b>Part No.</b>	102742	<b>Ref. No.</b> —
	pilot burner nozzle LPG code 25 bore ø 0.25mm Qty 1 pcs		

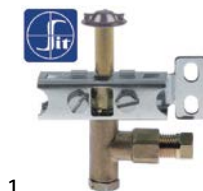

1

























<b>Part No.</b>	106906	<b>Ref. No.</b>	837221
<b>description</b>	pilot burner SIT type 100 series 3 flames nozzle ø 0.2mm gas connection 6mm		
<b>spare parts for</b>	106906		
	<b>Part No.</b>	100245	<b>Ref. No.</b> 837297
	pilot burner nozzle LPG code 20 bore ø 0.2mm Qty 1 pcs thread M8x0.75		

Table continues overleaf



<b>spare parts for</b> 106906	
	Part No. 100855 Ref. No. — pilot burner bracket triple
	Part No. 100885 Ref. No. — air mixing sleeve for pilot burner Qty 1 pcs
	Part No. 100916 Ref. No. — compression spring for pilot burner Qty 1 pcs
	Part No. 100917 Ref. No. — gasket for pilot burner Qty 1 pcs aluminium
	Part No. 100918 Ref. No. — screw for pilot burner
	Part No. 107162 Ref. No. — pilot burner cap SIT 3 flames Hmm Lmm Qty 1 pcs
	Part No. 107701 Ref. No. — pilot burner bottom part SIT 100 series nozzle ø 0.2mm
<b>accessories for</b> 106906	
	Part No. 100245 Ref. No. 837297 pilot burner nozzle LPG code 20 bore ø 0.2mm Qty 1 pcs thread M8x0.75
	Part No. 100246 Ref. No. — pilot burner nozzle natural gas bore ø 0.35mm Qty 1 pcs thread M8x0.75
	Part No. 100904 Ref. No. — locking screw M10x1 for pipe ø 4mm Qty 1 pcs
	Part No. 100905 Ref. No. — locking screw M10x1 for pipe ø 6mm Qty 1 pcs
	Part No. 102110 Ref. No. — pilot tube copper pipe ø 4mm thickness 1mm L 3000mm
	Part No. 102111 Ref. No. — pilot tube copper pipe ø 6mm thickness 1mm L 3000mm
	Part No. 107171 Ref. No. — pilot burner nozzle SIT natural/liquid gas bore ø 0.25mm Qty 1 pcs
	Part No. 107700 Ref. No. — pilot burner bottom part SIT 100 series nozzle ø 0.25mm
	Part No. 107702 Ref. No. — pilot burner bottom part SIT 100 series nozzle ø 0.35mm

<b>accessories</b>			
<b>pilot burner brackets</b>			
<b>producer-specific</b>			
			
1			
<b>Part No.</b>	105457	<b>Ref. No.</b>	831841
<b>description</b>	pilot burner bracket suitable for 100 series		
<b>accessories for</b>	105457		
	Part No. 105454	Ref. No.	828125
	burner cap ø 90mm with central hole		
	Part No. 105455	Ref. No.	827345
	burner head for burner cap ø 90mm		
	Part No. 105456	Ref. No.	827665+829591 827665+829593
	burner holder for burner cap ø 90/115mm H 122mm with mixing sleeve		

			
1			
<b>Part No.</b>	105460	<b>Ref. No.</b>	831837
<b>description</b>	pilot burner bracket suitable for 100 series		
<b>accessories for</b>	105460		
	Part No. 105456	Ref. No.	827665+829591 827665+829593
	burner holder for burner cap ø 90/115mm H 122mm with mixing sleeve		
	Part No. 105458	Ref. No.	828131
	burner cap ø 115mm with central hole		
	Part No. 105459	Ref. No.	827351
	burner head for burner cap ø 115mm		





			
1			
<b>Part No.</b>	105464	<b>Ref. No.</b>	831847
<b>description</b>	pilot burner bracket suitable for 100 series		
<b>accessories for</b>	105464		
	Part No. 105461	Ref. No.	828137 828137/1
	burner cap ø 135mm with central hole		
	Part No. 105462	Ref. No.	827357 827357/1
	burner head for burner cap ø 135mm		







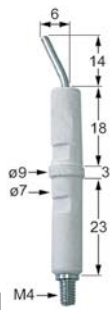

Table continues overleaf



















<b>accessories for</b>	105464		
	<b>Part No.</b>	105463	<b>Ref. No.</b> 827661+829589
	burner holder for burner cap ø 135mm H 102mm with mixing sleeve		

<b>pilot burner nozzles</b>			
			
<b>Part No.</b>	100245	<b>Ref. No.</b>	837297
<b>description</b>	pilot burner nozzle LPG code 20 bore ø 0.2mm Qty 1 pcs thread M8x0.75		

<b>ignition electrodes</b>			
			
<b>Part No.</b>	100706	<b>Ref. No.</b>	835911
<b>description</b>	ignition electrode connection M4 Qty 1 pcs		



<b>140 - 145 -150 series</b>			
			
<b>Part No.</b>	100126	<b>Ref. No.</b>	865881
<b>description</b>	pilot burner SIT type 140 series 1 flame nozzle ømm gas connectionmm		
<b>accessories for</b>	100126		
	<b>Part No.</b>	100204	<b>Ref. No.</b> —
	pilot burner nozzle SIT LPG code 14 bore ø 0.18/0.20mm Qty 1 pcs suitable for 140 series		
	<b>Part No.</b>	100205	<b>Ref. No.</b> —
	pilot burner nozzle SIT LPG code 19 bore ø 0.23/0.26mm Qty 1 pcs suitable for SIT 150 series		
	<b>Part No.</b>	100206	<b>Ref. No.</b> —
	pilot burner nozzle SIT natural gas code 36 bore ø 0.60/0.55mm Qty 1 pcs suitable for SIT 150 series		
	<b>Part No.</b>	100207	<b>Ref. No.</b> —
	pilot burner nozzle SIT natural gas code 27 bore ø 0.40/0.38mm suitable for SIT 140 series		
	<b>Part No.</b>	100216	<b>Ref. No.</b> —
	pilot burner nozzle SIT natural gas code 38 bore ø 0.45mm Qty 1 pcs suitable for SIT 150 series		
	<b>Part No.</b>	100701	<b>Ref. No.</b> 835915
	ignition electrode connection M4 Qty 1 pcs		
	<b>Part No.</b>	100897	<b>Ref. No.</b> —
	olive for pipe ø 4mm Qty 1 pcs for pilot burner		
	<b>Part No.</b>	100898	<b>Ref. No.</b> —
	olive for pipe ø 6mm Qty 1 pcs for pilot burner		

<b>accessories for</b>	100126		
	<b>Part No.</b>	100906	<b>Ref. No.</b> —
	screw connection thread M10x1 for ignition electrode brass Qty 1 pcs WS 10		
	<b>Part No.</b>	100907	<b>Ref. No.</b> —
	screw connection thread M10x1 Qty 1 pcs type SEF 1 ømm for thermocouple		
	<b>Part No.</b>	100908	<b>Ref. No.</b> —
	union screw thread M10x1 for pipe ø 4mm Qty 1 pcs		
	<b>Part No.</b>	100909	<b>Ref. No.</b> —
	union screw thread M10x1 for pipe ø 6mm Qty 1 pcs		





			
<b>Part No.</b>	107114 <sup>1</sup>	<b>Ref. No.</b>	837223
<b>description</b>	pilot burner SIT type 140 series 2 flames nozzle ømm gas connectionmm		
<b>spare parts for</b>	107114		
	<b>Part No.</b>	100907	<b>Ref. No.</b> —
	screw connection thread M10x1 Qty 1 pcs type SEF 1 ømm for thermocouple		
<b>accessories for</b>	107114		
	<b>Part No.</b>	100204	<b>Ref. No.</b> —
	pilot burner nozzle SIT LPG code 14 bore ø 0.18/0.20mm Qty 1 pcs suitable for 140 series		
	<b>Part No.</b>	100205	<b>Ref. No.</b> —
	pilot burner nozzle SIT LPG code 19 bore ø 0.23/0.26mm Qty 1 pcs suitable for SIT 150 series		
	<b>Part No.</b>	100206	<b>Ref. No.</b> —
	pilot burner nozzle SIT natural gas code 36 bore ø 0.60/0.55mm Qty 1 pcs suitable for SIT 150 series		
	<b>Part No.</b>	100207	<b>Ref. No.</b> —
	pilot burner nozzle SIT natural gas code 27 bore ø 0.40/0.38mm suitable for SIT 140 series		
	<b>Part No.</b>	100216	<b>Ref. No.</b> —
	pilot burner nozzle SIT natural gas code 38 bore ø 0.45mm Qty 1 pcs suitable for SIT 150 series		
	<b>Part No.</b>	100701	<b>Ref. No.</b> 835915
	ignition electrode connection M4 Qty 1 pcs		
	<b>Part No.</b>	100801	<b>Ref. No.</b> —
	gasket for pilot burner Qty 1 pcs		
	<b>Part No.</b>	100897	<b>Ref. No.</b> —
	olive for pipe ø 4mm Qty 1 pcs for pilot burner		
	<b>Part No.</b>	100898	<b>Ref. No.</b> —
	olive for pipe ø 6mm Qty 1 pcs for pilot burner		
	<b>Part No.</b>	100906	<b>Ref. No.</b> —
	screw connection thread M10x1 for ignition electrode brass Qty 1 pcs WS 10		
	<b>Part No.</b>	100908	<b>Ref. No.</b> —
	union screw thread M10x1 for pipe ø 4mm Qty 1 pcs		

<sup>1</sup>incl. thermocouple fitting  
Table continues overleaf



<b>accessories for</b>	107114		
	Part No.	100909	Ref. No. —
	union screw thread M10x1 for pipe ø 6mm Qty 1 pcs		
	Part No.	102110	Ref. No. —
	pilot tube copper pipe ø 4mm thickness 1mm L 3000mm		
	Part No.	102111	Ref. No. —
	pilot tube copper pipe ø 6mm thickness 1mm L 3000mm		

160 series

	1		
<b>Part No.</b>	100056	<b>Ref. No.</b>	898969
<b>description</b>	pilot burner SIT type 160 series 3 flames nozzle ømm gas connectionmm		
<b>spare parts for</b>	100056		
	Part No.	100907	Ref. No. —
	screw connection thread M10x1 Qty 1 pcs type SEF 1 ømm for thermocouple		
<b>accessories for</b>	100056		
	Part No.	100202	Ref. No. —
	pilot burner nozzle natural gas code 41 Qty 1 pcs nozzle ø 0.41mm		
	Part No.	100203	Ref. No. —
	pilot burner nozzle LPG code 25 Qty 1 pcs nozzle ø 0.25mm		
	Part No.	100701	Ref. No. 835915
	ignition electrode connection M4 Qty 1 pcs		
	Part No.	100801	Ref. No. —
	gasket for pilot burner Qty 1 pcs		
	Part No.	100869	Ref. No. —
	pilot burner nozzle natural gas code 51 Qty 1 pcs suitable for 160 series nozzle ø 0.51mm		
	Part No.	100870	Ref. No. —
	olive for pipe ø 4mm Qty 1 pcs suitable for 160 series for pilot burner		
	Part No.	100906	Ref. No. —
	screw connection thread M10x1 for ignition electrode brass Qty 1 pcs WS 10		
	Part No.	100908	Ref. No. —
	union screw thread M10x1 for pipe ø 4mm Qty 1 pcs		
	Part No.	100909	Ref. No. —
	union screw thread M10x1 for pipe ø 6mm Qty 1 pcs		
	Part No.	101287	Ref. No. —
	olive for pipe ø 6mm Qty 1 pcs		
	Part No.	102110	Ref. No. —
	pilot tube copper pipe ø 4mm thickness 1mm L 3000mm		
	Part No.	102111	Ref. No. —
	pilot tube copper pipe ø 6mm thickness 1mm L 3000mm		

<b>accessories for</b>	100056		
	Part No.	107650	Ref. No. —
	pilot burner nozzle SIT LPG code 30 Qty 1 pcs		

POLIDORO

pilot burners















	1		
<b>Part No.</b>	100051	<b>Ref. No.</b>	863981
<b>description</b>	pilot burner POLIDORO 3 flames code gas connectionmm		
<b>spare parts for</b>	100051		
	Part No.	100907	Ref. No. —
	screw connection thread M10x1 Qty 1 pcs type SEF 1 ømm for thermocouple		
<b>accessories for</b>	100051		
	Part No.	100000	Ref. No. —
	pilot burner nozzle POLIDORO LPG code 22 bore ø 0.22mm Qty 1 pcs		
	Part No.	100208	Ref. No. —
	pilot burner nozzle POLIDORO LPG code 20 bore ø 0.2mm Qty 1 pcs		
	Part No.	100209	Ref. No. —
	pilot burner nozzle POLIDORO natural gas code 40 bore ø 0.4mm Qty 1 pcs		
	Part No.	100701	Ref. No. 835915
	ignition electrode connection M4 Qty 1 pcs		
	Part No.	100906	Ref. No. —
	screw connection thread M10x1 for ignition electrode brass Qty 1 pcs WS 10		
	Part No.	100907	Ref. No. —
	screw connection thread M10x1 Qty 1 pcs type SEF 1 ømm for thermocouple		
	Part No.	100908	Ref. No. —
	union screw thread M10x1 for pipe ø 4mm Qty 1 pcs		
	Part No.	100909	Ref. No. —
	union screw thread M10x1 for pipe ø 6mm Qty 1 pcs		
	Part No.	102110	Ref. No. —
	pilot tube copper pipe ø 4mm thickness 1mm L 3000mm		
	Part No.	102111	Ref. No. —
	pilot tube copper pipe ø 6mm thickness 1mm L 3000mm		
	Part No.	102508	Ref. No. —
	union screw thread M10x1 for pipe ø 4mm Qty 5 pcs		
	Part No.	102509	Ref. No. —
	union screw thread M10x1 for pipe ø 6mm Qty 5 pcs		
	Part No.	102699	Ref. No. —
	pilot burner nozzle POLIDORO natural gas code 25.2 bore ø 2x0.25mm Qty 1 pcs 2 bores		

Table continues overleaf



accessories for		100051		
	Part No.	102795	Ref. No.	—
	olive for pipe ø 4mm Qty 1 pcs			
	Part No.	102797	Ref. No.	—
	olive for pipe ø 6mm Qty 1 pcs			
	Part No.	106703	Ref. No.	—
	pilot burner nozzle POLIDORO natural gas code 27.2 bore ø 2x0.27mm Qty 1 pcs			
	Part No.	106704	Ref. No.	—
	pilot burner nozzle POLIDORO LPG code 16.2 bore ø 2x0.16mm Qty 1 pcs			
	Part No.	106763	Ref. No.	—
	pilot burner nozzle POLIDORO natural gas code 27.2A bore ø 2x0.27mm Qty 1 pcs			
	Part No.	106859	Ref. No.	—
	pilot burner nozzle POLIDORO LPG code 24 bore ø 0.24mm Qty 1 pcs			

### electrodes

	<b>Part No.</b>	100701	<b>Ref. No.</b>	835915
	<b>description</b>	ignition electrode connection M4 Qty 1 pcs		
	<b>accessories for</b>	100701		
	Part No.	100906	Ref. No.	—
	screw connection thread M10x1 for ignition electrode brass Qty 1 pcs WS 10			

	<b>Part No.</b>	100706	<b>Ref. No.</b>	835911
	<b>description</b>	ignition electrode connection M4 Qty 1 pcs		

### ignition cables

#### pre-assembled cables

	<b>Part No.</b>	100176	<b>Ref. No.</b>	835905
	<b>description</b>	ignition cable cable length 1000mm connection ø2.4mm / ø4mm permanent temperature 200°C		

	<b>Part No.</b>	100026	<b>Ref. No.</b>	835901
	<b>description</b>	ignition cable cable length 1000mm connection ø4mm / F6.3mm		

### piezoelectric igniters

#### mounting diameter 22mm

	<b>Part No.</b>	100013	<b>Ref. No.</b>	835733
	<b>description</b>	piezoelectric igniter body plastic blowing mounting ø 22mm connection ø2.4mm cable lengthmm		
	<b>accessories for</b>	100013		
	Part No.	100023	Ref. No.	—
	female bullet size 2.3mm 0.5-1.5mm <sup>2</sup> CuZn t.max. 125°C Qty 20 pcs			

### miscellaneous

	<b>Part No.</b>	nla <sup>1</sup>	<b>Ref. No.</b>	835729
	<b>description</b>	piezoelectric igniter suitable for Minisit with cover cap ømm connection F6.3x0.8		
	<b>spare parts for</b>	101136		
	Part No.	100001	Ref. No.	—
	piezoelectric igniter suitable for Minisit connection F6.3x0.8 ømm			

<sup>1</sup>no longer available

### ignition switches

	<b>Part No.</b>	107783	<b>Ref. No.</b>	835925
	<b>description</b>	ignition switch for battery type AA 1.5V mounting ø 22mm built-in depth 68mm connection F 2.8 mounting distancemm dimensions 98x58x35mm outputs 1		



thermocouples

plug-in thermocouples

plug-in thermocouples standard

with barrel socket ø6(6.5)mm

thermocouples SIT

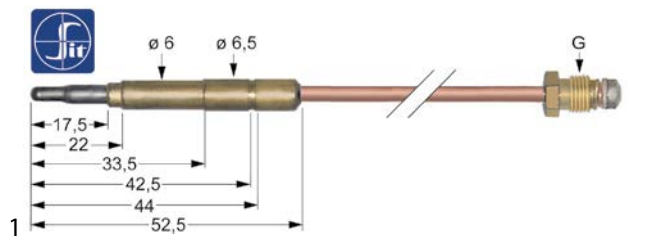

<b>Part No.</b>	107612	<b>Ref. No.</b>	837253
<b>description</b>	thermocouple SIT M9x1 L 1000mm plug connection ø6.0(6.5)mm		

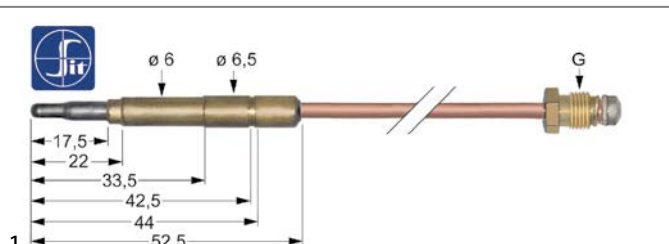

<b>Part No.</b>	107606	<b>Ref. No.</b>	837233
<b>description</b>	thermocouple SIT M9x1 L 320mm plug connection ø6.0(6.5)mm		

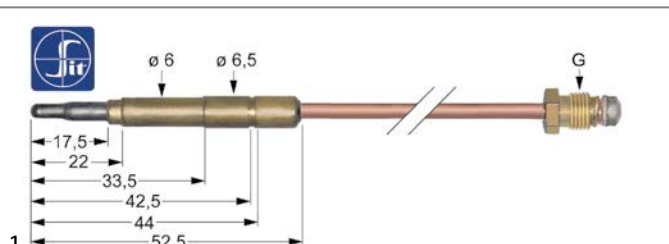

<b>Part No.</b>	107608	<b>Ref. No.</b>	837243
<b>description</b>	thermocouple SIT M9x1 L 500mm plug connection ø6.0(6.5)mm		

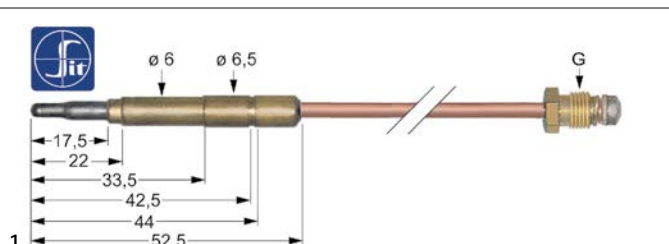

<b>Part No.</b>	107609	<b>Ref. No.</b>	837243
<b>description</b>	thermocouple SIT M9x1 L 600mm plug connection ø6.0(6.5)mm		

extensions



<b>Part No.</b>	102013	<b>Ref. No.</b>	837261
<b>description</b>	thermocouple extension thread M9x1 L 500mm		
<b>accessories for</b>	102013		
	<b>Part No.</b>	101261	<b>Ref. No.</b> —
	thermocouple fitting thread M9x1 Qty 1 pcs		

gas burners

hob burners

producer-specific hob burners

OFFCAR

serie 700, 900 (old)

	<b>Part No.</b>	104444	<b>Ref. No.</b>	827451
<b>description</b>	burner cap ø 105mm			

	<b>Part No.</b>	104445	<b>Ref. No.</b>	827405
<b>description</b>	burner cap ø 130mm			

	<b>Part No.</b>	104443	<b>Ref. No.</b>	827505
<b>description</b>	burner cap ø 85mm			

700, 900 (new) series

	<b>Part No.</b>	105458	<b>Ref. No.</b>	828131
<b>description</b>	burner cap ø 115mm with central hole			

<b>accessories for</b>	105458			
------------------------	--------	--	--	--

	<b>Part No.</b>	105456	<b>Ref. No.</b>	827665+829591 827665+829593
	burner holder for burner cap ø 90/115mm H 122mm with mixing sleeve			



	<b>Part No.</b>	105459	<b>Ref. No.</b>	827351
	burner head for burner cap ø 115mm			

	<b>Part No.</b>	105460	<b>Ref. No.</b>	831837
	pilot burner bracket suitable for 100 series			





1



<b>Part No.</b>	105461	<b>Ref. No.</b>	828137 828137/1
<b>description</b>	burner cap ø 135mm with central hole		
<b>accessories for</b>	105461		
	<b>Part No.</b>	105462	<b>Ref. No.</b> 827357 827357/1
	burner head for burner cap ø 135mm		
	<b>Part No.</b>	105463	<b>Ref. No.</b> 827661+829589
	burner holder for burner cap ø 135mm H 102mm with mixing sleeve		
	<b>Part No.</b>	105464	<b>Ref. No.</b> 831847
	pilot burner bracket suitable for 100 series		



1



<b>Part No.</b>	105462	<b>Ref. No.</b>	827357 827357/1
<b>description</b>	burner head for burner cap ø 135mm		
<b>accessories for</b>	105462		
	<b>Part No.</b>	105461	<b>Ref. No.</b> 828137 828137/1
	burner cap ø 135mm with central hole		
	<b>Part No.</b>	105463	<b>Ref. No.</b> 827661+829589
	burner holder for burner cap ø 135mm H 102mm with mixing sleeve		
	<b>Part No.</b>	105464	<b>Ref. No.</b> 831847
	pilot burner bracket suitable for 100 series		



1



<b>Part No.</b>	105454	<b>Ref. No.</b>	828125
<b>description</b>	burner cap ø 90mm with central hole		
<b>accessories for</b>	105454		
	<b>Part No.</b>	105455	<b>Ref. No.</b> 827345
	burner head for burner cap ø 90mm		
	<b>Part No.</b>	105456	<b>Ref. No.</b> 827665+829591 827665+829593
	burner holder for burner cap ø 90/115mm H 122mm with mixing sleeve		
	<b>Part No.</b>	105457	<b>Ref. No.</b> 831841
	pilot burner bracket suitable for 100 series		



1



<b>Part No.</b>	105455	<b>Ref. No.</b>	827345
<b>description</b>	burner head for burner cap ø 90mm		
<b>accessories for</b>	105455		
	<b>Part No.</b>	105454	<b>Ref. No.</b> 828125
	burner cap ø 90mm with central hole		
	<b>Part No.</b>	105456	<b>Ref. No.</b> 827665+829591 827665+829593
	burner holder for burner cap ø 90/115mm H 122mm with mixing sleeve		
	<b>Part No.</b>	105457	<b>Ref. No.</b> 831841
	pilot burner bracket suitable for 100 series		



1



<b>Part No.</b>	105459	<b>Ref. No.</b>	827351
<b>description</b>	burner head for burner cap ø 115mm		
<b>accessories for</b>	105459		
	<b>Part No.</b>	105456	<b>Ref. No.</b> 827665+829591 827665+829593
	burner holder for burner cap ø 90/115mm H 122mm with mixing sleeve		
	<b>Part No.</b>	105458	<b>Ref. No.</b> 828131
	burner cap ø 115mm with central hole		
	<b>Part No.</b>	105460	<b>Ref. No.</b> 831837
	pilot burner bracket suitable for 100 series		

1



<b>Part No.</b>	105463	<b>Ref. No.</b>	827661+829589
<b>description</b>	burner holder for burner cap ø 135mm H 102mm with mixing sleeve		
<b>accessories for</b>	105463		
	<b>Part No.</b>	105461	<b>Ref. No.</b> 828137 828137/1
	burner cap ø 135mm with central hole		
	<b>Part No.</b>	105462	<b>Ref. No.</b> 827357 827357/1
	burner head for burner cap ø 135mm		
	<b>Part No.</b>	105464	<b>Ref. No.</b> 831847
	pilot burner bracket suitable for 100 series		





 <p>1</p>			
<b>Part No.</b>	105456	<b>Ref. No.</b>	827665+829591 827665+829593
<b>description</b>	burner holder for burner cap ø 90/115mm H 122mm with mixing sleeve		
<b>accessories for</b>	105456		
	<b>Part No.</b>	105454	<b>Ref. No.</b> 828125
	burner cap ø 90mm with central hole		
	<b>Part No.</b>	105455	<b>Ref. No.</b> 827345
	burner head for burner cap ø 90mm		
	<b>Part No.</b>	105457	<b>Ref. No.</b> 831841
	pilot burner bracket suitable for 100 series		

reducers for pan supports			
 <p>1</p>			
<b>Part No.</b>	210050	<b>Ref. No.</b>	831733 Mod. RID9-7
<b>description</b>	reducer for pan support L 260mm W 260mm chrome-plated steel suitable for universal		

spillage trays			
 <p>1</p>			
<b>Part No.</b>	105465	<b>Ref. No.</b>	440081
<b>description</b>	drain tray L 380mm W 350mm for burner cap ø 110mm		

 <p>1</p>			
<b>Part No.</b>	105466	<b>Ref. No.</b>	440083
<b>description</b>	drain tray L 380mm W 350mm for burner cap ø 130mm		

 <p>1</p>			
<b>Part No.</b>	105467	<b>Ref. No.</b>	440059
<b>description</b>	drain tray L 560mm W 345mm		

accessories			
reducers for pan supports			
 <p>1</p>			
<b>Part No.</b>	210050	<b>Ref. No.</b>	831733 Mod. RID9-7
<b>description</b>	reducer for pan support L 260mm W 260mm chrome-plated steel suitable for universal		

spillage trays			
 <p>1</p>			
<b>Part No.</b>	105465	<b>Ref. No.</b>	440081
<b>description</b>	drain tray L 380mm W 350mm for burner cap ø 110mm		

 <p>1</p>			
<b>Part No.</b>	105466	<b>Ref. No.</b>	440083
<b>description</b>	drain tray L 380mm W 350mm for burner cap ø 130mm		







			
1			
<b>Part No.</b>	105467	<b>Ref. No.</b>	440059
<b>description</b>	drain tray L 560mm W 345mm		

## bar burners

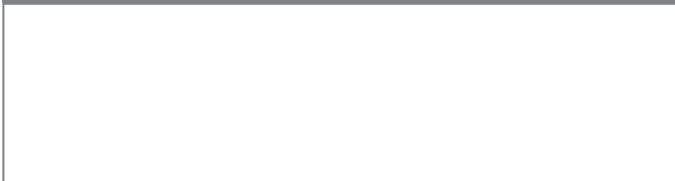
## bar burners

			
1			
<b>Part No.</b>		<b>Ref. No.</b>	865861
<b>description</b>	bar burner		

			
1			
<b>Part No.</b>	105474	<b>Ref. No.</b>	865851
<b>description</b>	bar burner 2 row L 370mm W 220mm ømm chargrill		

			
1			
<b>Part No.</b>	105687	<b>Ref. No.</b>	865851
<b>description</b>	bar burner 2 row L 370mm W 220mm ømm H 50mm chargrill		

			
1			
<b>Part No.</b>	105475	<b>Ref. No.</b>	865861
<b>description</b>	bar burner 2 row L 575mm W 225mm ømm H 45mm 11kW chargrill		

			
1			
<b>Part No.</b>	105481	<b>Ref. No.</b>	FX30400060
<b>description</b>	bar burner ø 40mm Wmm Hmm L 325mm flange ø 61mm tilting bratt pan		

			
1			
<b>Part No.</b>	105482	<b>Ref. No.</b>	FX30400050
<b>description</b>	bar burner ø 40mm Wmm Hmm L 396mm flange ø 61mm tilting bratt pan		

			
1			
<b>Part No.</b>	105473	<b>Ref. No.</b>	841261
<b>description</b>	bar burner ø 40mm Wmm Hmm L 505mm griddle		

			
1			
<b>Part No.</b>	105469	<b>Ref. No.</b>	841111
<b>description</b>	bar burner ø 50mm Wmm Hmm L 425mm flange ø 75mm flange width 71mm oven		

			
1			
<b>Part No.</b>	105470	<b>Ref. No.</b>	841211
<b>description</b>	bar burner ø 50mm Wmm Hmm L 505mm flange ø 75mm flange width 71mm oven		



 <p>1</p>			
<b>Part No.</b>	105471	<b>Ref. No.</b>	841219
<b>description</b>	bar burner ø 50mm Wmm Hmm L 610mm flange ø 75mm flange width 71mm oven		

 <p>1</p>			
<b>Part No.</b>	105476	<b>Ref. No.</b>	841041 898963
<b>description</b>	bar burner ø 60mm Wmm Hmm L 258mm pasta cooker		

 <p>1</p>			
<b>Part No.</b>	105477	<b>Ref. No.</b>	898961
<b>description</b>	bar burner ø 60mm Wmm Hmm L 385mm flange width 67mm flange length 67mm pasta cooker		

 <p>1</p>			
<b>Part No.</b>	105639	<b>Ref. No.</b>	841091 898961
<b>description</b>	bar burner ø 60mm Wmm Hmm L 390mm 1-row with bolt bolt ø 10x45mm flange width 67mm flange length 67mm pasta cooker		

tube burners

 <p>1</p>			
<b>Part No.</b>	105480	<b>Ref. No.</b>	862519
<b>description</b>	tubular burner L 295mm W 55mm H 70mm mounting pos. centre oval		

 <p>1</p>			
<b>Part No.</b>	105479	<b>Ref. No.</b>	862513
<b>description</b>	tubular burner L 295mm W 55mm H 70mm mounting pos. left for fryer oval		

 <p>1</p>			
<b>Part No.</b>	105478	<b>Ref. No.</b>	862511
<b>description</b>	tubular burner L 295mm W 55mm H 70mm mounting pos. right for fryer oval		

solid top burners

 <p>1</p>			
<b>Part No.</b>	105468	<b>Ref. No.</b>	827981
<b>description</b>	solid top burner ø 120mm H 102mm L 340mm suitable for 700/900 series		

gas nozzles

main nozzles

gas nozzles M10x1

 <p>1</p>			
<b>Part No.</b>	106631	<b>Ref. No.</b>	8293579
<b>description</b>	gas injector thread M10x1 WS 11 bore ø 1.9mm inner peaked		

 <p>1</p>			
<b>Part No.</b>	106295	<b>Ref. No.</b>	829314
<b>description</b>	gas injector thread M10x1 WS 11 bore ø 0.9mm code 90		



1

<b>Part No.</b>	100793	<b>Ref. No.</b>	829317-150
<b>description</b>	gas injector thread M10x1 WS 11 bore ø 1.5mm		



1

<b>Part No.</b>	106493	<b>Ref. No.</b>	829317-175
<b>description</b>	gas injector thread M10x1 WS 11 bore ø 1.75mm		



1

<b>Part No.</b>	106440	<b>Ref. No.</b>	829317-185
<b>description</b>	gas injector thread M10x1 WS 11 bore ø 1.85mm		



1

<b>Part No.</b>	106498	<b>Ref. No.</b>	829317-195
<b>description</b>	gas injector thread M10x1 WS 11 bore ø 1.95mm		

## pilot burner nozzles

### pilot burner nozzles SIT

#### 100 series



1

<b>Part No.</b>	100245	<b>Ref. No.</b>	837297
<b>description</b>	pilot burner nozzle LPG code 20 bore ø 0.2mm Qty 1 pcs thread M8x0.75		

## auxiliary gas parts

### screw connections

#### olives



1

<b>Part No.</b>	101249	<b>Ref. No.</b>	835325
<b>description</b>	olive for pipe ø 10mm Qty 1 pcs		
<b>accessories for</b>	101249		



<b>Part No.</b>	101250	<b>Ref. No.</b>	—
<b>description</b>	union nut thread M20x1.5 for pipe ø 10mm		

## equipment-specific units

### for dough mixers

#### flange bearings



1

<b>Part No.</b>	693112	<b>Ref. No.</b>	FX20400012
<b>description</b>	flange bearing type UCF204 shaft ø 20mm 4 hole flange hole distance 64mm H 33mm flange length 86mm flange width 86mm hole ø 12mm flange F204 ball bearing UC204G2 FH 25.5mm		

### for convection ovens/combi-steamers

#### door mechanics

#### miscellaneous



1

<b>Part No.</b>	900708	<b>Ref. No.</b>	4614005 814811
<b>description</b>	frame for door seal		

### for tilting bratt pans

#### spindles



1

<b>Part No.</b>	693110	<b>Ref. No.</b>	FXSMB012800
<b>description</b>	threaded rod L 363mm ø 20mm		

#### miscellaneous



1

<b>Part No.</b>	693111	<b>Ref. No.</b>	FXSMB013000
<b>description</b>	spindle		



1

<b>Part No.</b>	693114	<b>Ref. No.</b>	FXSMB063000
<b>description</b>	spindle		





1

<b>Part No.</b>	693109	<b>Ref. No.</b>	FXSC02200
<b>description</b>	threaded bush for tilting bratt pan brass thread TR20x4		

for boiling pans

filters



1

<b>Part No.</b>	514503	<b>Ref. No.</b>	FX-30700122
<b>description</b>	drain filter for kettle size 76x145mm		

miscellaneous



1

<b>Part No.</b>	540639	<b>Ref. No.</b>	FX10400058
<b>description</b>	extension		

for ovens

housing and bezels



1

<b>Part No.</b>	901358	<b>Ref. No.</b>	814821
<b>description</b>	frame W 371mm L 997mm L-shape stainless steel		

knobs

producer-specific knobs

OFFCAR



1

<b>Part No.</b>	110985	<b>Ref. No.</b>	401401
<b>description</b>	knob gas tap with ignition flame t.max.°C ø 70mm shaft ø 10x8mm shaft flat lower black		



1

<b>Part No.</b>	110980	<b>Ref. No.</b>	401405
<b>description</b>	knob gas tap with ignition flame t.max.°C ø 70mm shaft ø 8x6.5mm shaft flat lower black		



1

<b>Part No.</b>	110983	<b>Ref. No.</b>	401411
<b>description</b>	knob gas thermostat 1-8 ø 70mm shaft ø 10x8mm shaft flat upper black		



1

<b>Part No.</b>	110982	<b>Ref. No.</b>	401415 (old version)
<b>description</b>	knob gas thermostat 1-8 t.max.°C ø 70mm shaft ø 8x6.5mm shaft flat upper black		



1

<b>Part No.</b>	112806	<b>Ref. No.</b>	401415
<b>description</b>	knob gas thermostat t.max. 300°C 100-300°C ø 70mm shaft ø 8x6.5mm shaft flat upper black		

1

<b>Part No.</b>	110988	<b>Ref. No.</b>	401469
<b>description</b>	knob switch 0-1 t.max.°C ø 70mm shaft ø 6x4.6mm shaft flat upper black		



1

<b>Part No.</b>	110989	<b>Ref. No.</b>	401461
<b>description</b>	knob thermostat t.max. 200°C ø 70mm shaft ø 6x4.6mm shaft flat upper temperature range 140-200°C		



1

<b>Part No.</b>	110992	<b>Ref. No.</b>	401477
<b>description</b>	knob switch 0-1-2 ø 70mm shaft ø 6x4.6mm shaft flat upper		



1

<b>Part No.</b>	110990	<b>Ref. No.</b>	401421
<b>description</b>	knob thermostat t.max. 300°C ø 70mm shaft ø 6x4.6mm shaft flat upper black temperature range 50-300°C		



1

<b>Part No.</b>	110986	<b>Ref. No.</b>	401451
<b>description</b>	knob switch 4-position ø 70mm shaft ø 6x4.6mm shaft flat upper black		



1

<b>Part No.</b>	110987	<b>Ref. No.</b>	401431
<b>description</b>	knob thermostat t.max. 90°C ø 70mm shaft ø 6x4.6mm shaft flat upper black temperature range 15-90°C rotation 270°		



1

<b>Part No.</b>	110981	<b>Ref. No.</b>	401441
<b>description</b>	knob switch 7-position ø 70mm shaft ø 6x4.6mm shaft flat upper black		



1

<b>Part No.</b>	110991	<b>Ref. No.</b>	401483
<b>description</b>	knob thermostat ø 70mm shaft ø 6x4.6mm shaft flat lower		

## handles and hand wheels

### hand wheels

### hand wheels



1

<b>Part No.</b>	692443	<b>Ref. No.</b>	FXSMB013600
<b>description</b>	hand wheel ø 150mm D1 ø 38mm bore ø 14mm thread groove width 6mm groove depth 13mm mounting distance 18mm L1 40mm L2 43mm handle length 65mm with folding handle		





1

<b>Part No.</b>	692430	<b>Ref. No.</b>	FXSMB063600
<b>description</b>	hand wheel $\varnothing$ 200mm D1 $\varnothing$ 50mm bore $\varnothing$ 20mm thread groove width 6mm groove depth 13mm mounting distance 30mm L1 47mm L2 50mm handle length 90mm with folding handle		

## hinges

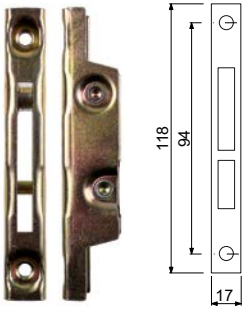
### oven hinges





1

<b>Part No.</b>	700001	<b>Ref. No.</b>	844589
<b>description</b>	opposite support L 118mm W 17mm mounting distance 94mm		



1

<b>Part No.</b>	700006	<b>Ref. No.</b>	844581	
<b>description</b>	oven hinge mounting distance 173mm mounting distance 2 105mm lug mounting 14mm lever length 120mm groove distance 11mm spring thickness 3.5mm mounting ear position left spring length 112mm W 25mm			
<b>accessories for</b>	700006			
	<b>Part No.</b>	700001	<b>Ref. No.</b>	844589
	opposite support L 118mm W 17mm mounting distance 94mm			
	<b>Part No.</b>	700007	<b>Ref. No.</b>	844583
<b>description</b>	oven hinge mounting distance 173mm mounting distance 2 105mm lug mounting 14mm lever length 120mm groove distance 11mm spring thickness 3.5mm mounting ear position right spring length 112mm W 25mm			

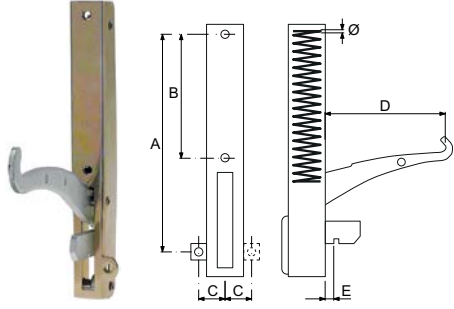

1

<b>Part No.</b>	700007	<b>Ref. No.</b>	844583	
<b>description</b>	oven hinge mounting distance 173mm mounting distance 2 105mm lug mounting 14mm lever length 120mm groove distance 11mm spring thickness 3.5mm mounting ear position right spring length 112mm W 25mm			
<b>accessories for</b>	700007			
	<b>Part No.</b>	700001	<b>Ref. No.</b>	844589
	opposite support L 118mm W 17mm mounting distance 94mm			

## fittings for catering equipment

### inlet taps



1

<b>Part No.</b>	693108	<b>Ref. No.</b>	FX3020005
<b>description</b>	shut-off valve		

### drain taps

#### brass

### drain taps





1



<b>Part No.</b>	540275	<b>Ref. No.</b>	FX30200198	
<b>description</b>	drain tap 2" IT with union nut A 90mm B 151mm B1 80mm chrome-plated brass			
<b>spare parts for</b>	540275			
	<b>Part No.</b>	540214	<b>Ref. No.</b>	—
	handle ID $\varnothing$ 6mm L 145mm			

Table continues overleaf



<b>accessories for</b>	540275		
	<b>Part No.</b>	529484	<b>Ref. No.</b> —
	flat gasket fibre ED ø 58mm ID ø 50mm thickness 2mm Qty 1 pcs		
	<b>Part No.</b>	542448	<b>Ref. No.</b> —
	gasket silicone 60x49x2 for drain tap 2"		



<b>Part No.</b>	540276	<b>Ref. No.</b>	FX30200196
<b>description</b>	drain tap connection with union nut thread 1½"		
<b>spare parts for</b>	540276		
	<b>Part No.</b>	532374	<b>Ref. No.</b> —
	O-ring silicone thickness 5.34mm ID ø 43.82mm Qty 10 pcs		
<b>accessories for</b>	540276		
	<b>Part No.</b>	514251	<b>Ref. No.</b> —
	gasket fibre ED ø 46mm ID ø 38mm thickness 2mm Qty 1 pcs		



<b>Part No.</b>	540649	<b>Ref. No.</b>	FX30200198
<b>description</b>	drain tap connection with union nut thread 2"		

### accessories



<b>Part No.</b>	540956	<b>Ref. No.</b>	FX10500062
<b>description</b>	gasket for drain tap hose ext. ø 46mm ID ø 38mm H 2mm		



<b>Part No.</b>	540959	<b>Ref. No.</b>	FX10500060
<b>description</b>	gasket for drain tap hose ext. ø 60mm ID ø 50mm H 2mm		



<b>Part No.</b>	540958	<b>Ref. No.</b>	FX10200002
<b>description</b>	rosette for drain tap hose ext. ø 120mm ID ø 60mm H 13mm		



<b>Part No.</b>	540955	<b>Ref. No.</b>	FX10200004
<b>description</b>	rosette for drain tap thread 1½"		



<b>Part No.</b>	540954	<b>Ref. No.</b>	FX-10400009
<b>description</b>	screw-in socket for drain tap thread 1½"		



<b>Part No.</b>	540957	<b>Ref. No.</b>	FX10400006
<b>description</b>	screw-in socket for drain tap thread 2" L 120mm		



test taps

test taps

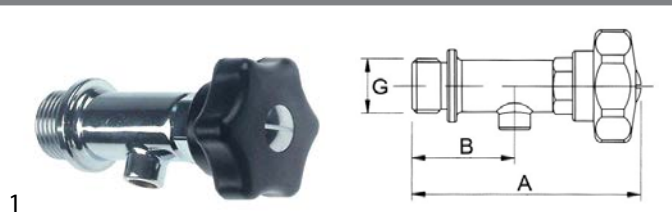

<b>Part No.</b>	540818	<b>Ref. No.</b>	FX30200050
<b>description</b>	test tap thread 1/2" ET W 88mm W1 38mm		

safety fittings

accessories



<b>Part No.</b>	540835	<b>Ref. No.</b>	FX10400061
<b>description</b>	screw cap thread 3/4"		
<b>spare parts for</b>	540835		

<b>Part No.</b>	513016	<b>Ref. No.</b>	—
<b>description</b>	O-ring EPDM thickness 3.53mm ID ø 26.58mm Qty 1 pcs		

<b>Part No.</b>	513016	<b>Ref. No.</b>	—
<b>description</b>	O-ring EPDM thickness 3.53mm ID ø 26.58mm Qty 1 pcs		

baskets

fryer baskets

OFFCAR



<b>Part No.</b>	970362	<b>Ref. No.</b>	863066
<b>description</b>	fryer basket L1 310mm W1 145mm H1 120mm chrome-plated steel		

gaskets

refrigeration gaskets

plug-in gaskets

profile 9794

We offer custom-made gaskets for this profile

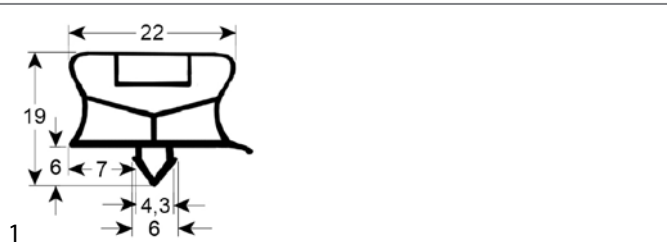

<b>Part No.</b>	901955	<b>Ref. No.</b>	G504330653
<b>description</b>	refrigeration gasket profile 9794 W 408mm L 630mm plug size L1 653mm W1 433mm external size		

gaskets for heated units

door seals

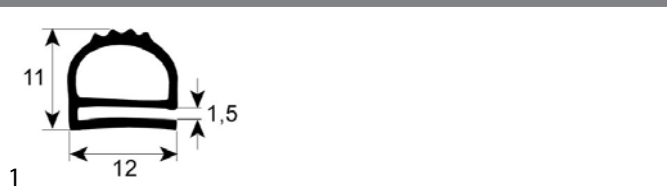

<b>Part No.</b>	901357 <sup>1</sup>	<b>Ref. No.</b>	844445
<b>description</b>	door seal profile 2255 L 1000mm W 360mm external size 3-sided		

<sup>1</sup>3-sided, long side open



<b>Part No.</b>	900707 <sup>1</sup>	<b>Ref. No.</b>	844491
<b>description</b>	door seal profile 2255 W 300mm L 570mm external size Qty 1 3-piece		

<sup>1</sup>3-sided, long side open



<b>Part No.</b>	901359 <sup>1</sup>	<b>Ref. No.</b>	844441
<b>description</b>	door seal profile 2255 W 570mm L 300mm external size 3-sided		

<sup>1</sup>3-sided, long side open

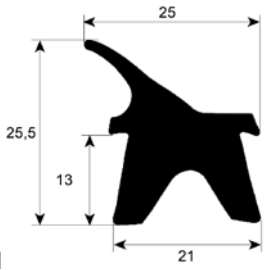

<b>Part No.</b>	901158	<b>Ref. No.</b>	862055
<b>description</b>	door seal profile 2402 W 640mm L 740mm		

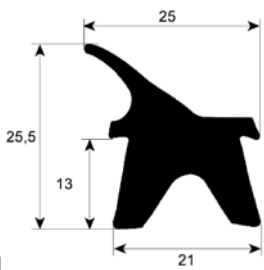

<b>Part No.</b>	900834	<b>Ref. No.</b>	862073
<b>description</b>	door seal profile 2402 W 670mm L 750mm plug size Qty 1		

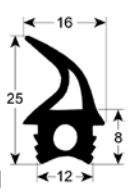

<b>Part No.</b>	902409	<b>Ref. No.</b>	862075
<b>description</b>	door seal profile 2714 Qty supplied by meter suitable for GIORIK		

**door seals with fixing hook**



<b>Part No.</b>	900256	<b>Ref. No.</b>	844453
<b>description</b>	door seal W 540mm H 200mm		



<b>Part No.</b>	900399	<b>Ref. No.</b>	844454
<b>description</b>	door seal W 540mm with mounting clip H 190mm		



<b>Part No.</b>	900411	<b>Ref. No.</b>	844475
<b>description</b>	door seal W 750mm with mounting clip H 280mm		

**O-rings**

**EPDM**

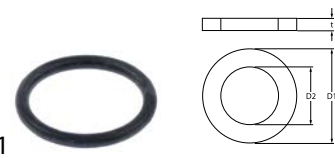

<b>Part No.</b>	511937	<b>Ref. No.</b>	FX10500110
<b>description</b>	O-ring EPDM thickness 3.53mm ID ø 28.17mm Qty 1 pcs		



<b>Part No.</b>	532118	<b>Ref. No.</b>	862053
<b>description</b>	O-ring EPDM thickness 3.53mm ID ø 55.56mm Qty 10 pcs		



<b>Part No.</b>	510408	<b>Ref. No.</b>	FX10500100
<b>description</b>	O-ring EPDM thickness 5.34mm ID ø 47mm Qty 1 pcs		

**Viton**



<b>Part No.</b>	510245	<b>Ref. No.</b>	862051 ACQ6507 ACQ6508
<b>description</b>	O-ring Viton thickness 3.53mm ID ø 50.8mm Qty 1 pcs		

**transmission technology and ball bearings**

**ball bearings**



**flange bearings**



<b>Part No.</b>	693112	<b>Ref. No.</b>	FX20400012
<b>description</b>	flange bearing type UCF204 shaft ø 20mm 4 hole flange hole distance 64mm H 33mm flange length 86mm flange width 86mm hole ø 12mm flange F204 ball bearing UC204G2 FH 25.5mm		











## manometers

			
1			
<b>Part No.</b>	541062	<b>Ref. No.</b>	FX30300022
<b>description</b>	manometer ø 63mm pressure range 0 up to 1bar connection marking adjustable kettle thread 1/4"		
<b>spare parts for</b>	541062		
	<b>Part No.</b>	541130	<b>Ref. No.</b> —
	glass panel ø 58mm thickness 2mm		

## valves and tank inlets

### shut-off valves

#### universal

			
1			
<b>Part No.</b>	693107	<b>Ref. No.</b>	FX30200008
<b>description</b>	shut-off valve connection 1/2" 1/2" cold total length 54mm L1 27mm L2 30mm marking blue rosette thread G2 26x19G connection ø M4x0.7 ITmm		
<b>spare parts for</b>	693107		
	<b>Part No.</b>	514085	<b>Ref. No.</b> —
	rosette connection 26x19G chrome-plated total lengthmm mounting pos.		
	<b>Part No.</b>	514086	<b>Ref. No.</b> —
	hexagonal nut connection 26x19G brass total lengthmm mounting pos. H 6mm WS 34 Qty 1 pcs		
	<b>Part No.</b>	540672	<b>Ref. No.</b> —
	gasket suitable for tap head		
	<b>Part No.</b>	547711	<b>Ref. No.</b> —
	hood handle shaft intake ø 8mm marking blue metal H2 21mm D1 ø 33mm type D suitable for MONOLITH shaft length H1 8mm		
	<b>Part No.</b>	548168	<b>Ref. No.</b> —
	star handle connection hot total lengthmm mounting pos. ø 57mm marking red		
	<b>Part No.</b>	548169	<b>Ref. No.</b> —
	star handle connection cold total lengthmm mounting pos. chrome-plated ø 57mm		
<b>accessories for</b>	693107		
	<b>Part No.</b>	514086	<b>Ref. No.</b> —
	hexagonal nut connection 26x19G brass total lengthmm mounting pos. H 6mm WS 34 Qty 1 pcs		

			
1			
<b>Part No.</b>	693105	<b>Ref. No.</b>	898871
<b>description</b>	shut-off valve connection 1/2" 1/2" straight total length 45mm mounting pos.		

### accessories

			
1			
<b>Part No.</b>	694767	<b>Ref. No.</b>	401683
<b>description</b>	handle plastic thread 7.5 ø 46.5mm H 35mm WS black shaft star-shaped		

### accessories

#### turning handles

			
1			
<b>Part No.</b>	691461	<b>Ref. No.</b>	833485
<b>description</b>	handle suitable for intake tap		

			
1			
<b>Part No.</b>	693106	<b>Ref. No.</b>	833463+833467 898873
<b>description</b>	star handle intake tap		

## consumables

### fuses

#### fine fuses

			
1			
<b>Part No.</b>	358597	<b>Ref. No.</b>	40200084
<b>description</b>	fine fuse size ø5x20mm 0.5A slow-acting rated 250V Qty 10 pcs		



			
1			
<b>Part No.</b>	358605	<b>Ref. No.</b>	40200080 FX-40200084
<b>description</b>	fine fuse size ø5x20mm 3.15A slow-acting rated 250V Qty 10 pcs		

**GASTRO**PARTS.COM

