



GASTROPARTS

OEM

[EN] Equipment

[DE] Geräte

[ES] Aparatos

[FR] Équipement

[IT] Attrezzature

[PL] Urządzenia

[RU] Оборудование

✉ gastroparts@gastroparts.com

☎ +48 56 657 00 66

📘 fb.com/gastroparts.global







GASTROPARTS.COM





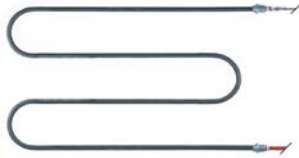
heating elements

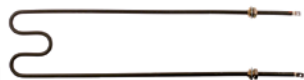
heating elements for coffee machine


			
1			
Part No.	415193	Ref. No.	EE003
description	heating element 3000W 230V heating circuits 3 mounting ø 42mm hole distance 74mm L 310mm W 35mm H 43mm L1 35mm L2 45mm L3 230mm H1 13mm hole ø 10mm connection M4 immersion heater 2 hole flange		
accessories for	415193		
	Part No.	521103	Ref. No. —
	nut thread M4 H 3mm WS 7 brass Qty 20 pcs		
	Part No.	521104	Ref. No. —
	washer ID ø 4.3mm ED ø 8mm thickness 0.5mm brass Qty 20 pcs for thread M4		
	Part No.	521125	Ref. No. AD036
	flat gasket rubber ED ø 52mm ID ø 42.5mm thickness 4mm Qty 1 pcs		
	Part No.	560111	Ref. No. —
	plain washer ID ø 4.3mm ED ø 9mm thickness 0.8mm SS Qty 20 pcs DIN 125A for thread M4		
	Part No.	560131	Ref. No. —
	hexagonal nut thread M4 H 3.2mm WS 7 SS DIN/ISO DIN 934 / ISO 4032/8673 Qty 20 pcs		




			
1			
Part No.	415194	Ref. No.	EE005
description	heating element 4500W 230V heating circuits 3 mounting ø 42mm hole distance 74mm L 318mm W 32mm H 44mm L1 35mm L2 45mm L3 235mm H1 29mm H2 15mm hole ø 9mm tube ø 8.5mm connection M4 immersion heater 2 hole flange		
accessories for	415194		
	Part No.	521103	Ref. No. —
	nut thread M4 H 3mm WS 7 brass Qty 20 pcs		
	Part No.	521104	Ref. No. —
	washer ID ø 4.3mm ED ø 8mm thickness 0.5mm brass Qty 20 pcs for thread M4		
	Part No.	560111	Ref. No. —
	plain washer ID ø 4.3mm ED ø 9mm thickness 0.8mm SS Qty 20 pcs DIN 125A for thread M4		
	Part No.	560131	Ref. No. —
	hexagonal nut thread M4 H 3.2mm WS 7 SS DIN/ISO DIN 934 / ISO 4032/8673 Qty 20 pcs		

heating elements for pizza ovens

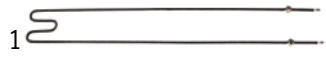


			
1			
Part No.	416461	Ref. No.	EE15700
description	heating element 1000W 230V L 473mm W 275mm thread 1/4" mounting distance 262mm connection length 40mm connection cable tube ø 8.5mm cable length 490mm heating circuits 1 dry heating element 2 hole fixing pizza oven		


			
1			
Part No.	416470	Ref. No.	EE10400
description	heating element 1100W 230V L 580mm W 160mm thread 3/8" mounting distance 151mm connection length 104mm tube ø 8.5mm heating circuits 1 dry heating element pizza oven		
For models:	109, 111, 66, 69, 77, 96, 99		




			
1			
Part No.	416466	Ref. No.	EE10800
description	heating element 1100W 230V L 880mm W 120mm thread 3/8" mounting distance 111mm connection length 104mm connection M5 tube ø 8.5mm dry heating element 2 hole fixing pizza oven		
For models:	109, 111, 23, 66, 69, 77, 96, 99		


			
1			
Part No.	416472	Ref. No.	EE10600
description	heating element 1100W 400V L 580mm W 165mm thread 3/8" mounting distance 157mm connection length 90mm connection male faston 6.3mm tube ø 8.5mm heating circuits 1 dry heating element 2 hole fixing		
For models:	96, R-109-1, R-109-2, R-109-3, R-111-1, R-111-2, R-111-3, R-66-1, R-66-2, R-66-3, R-69-1, R-69-2, R-69-3, R-77-1, R-77-2, R-77-3, R-96-1, R-96-2, R-96-3, R-99-1, R-99-2, R-99-3, RE-109-1, RE-109-2, RE-109-3, RE-111-1, RE-111-2, RE-111-3, RE-66-1, RE-66-2, RE-66-3, RE-69-1, RE-69-2, RE-69-3, RE-77-1, RE-77-2, RE-77-3, RE-96-1, RE-96-2, RE-96-3, RE-99-1, RE-99-2, RE-99-3, S-109-1, S-109-2, S-109-3, S-111-1, S-111-2, S-111-3, S-66-1...(Other models you can see in the webshop)		
accessories for	416472		
	Part No.	361183	Ref. No. —
	nut thread 3/8" H 6mm nickel-plated brass WS 20 Qty 1 pcs		
	Part No.	521137	Ref. No. —
	flat gasket fibre ED ø 20mm ID ø 18mm thickness 1.5mm for thread 3/8" Qty 1 pcs		







			
Part No.	416468	Ref. No.	EE11000
description	heating element 1100W 400V L 884mm W 125mm thread 3/8" mounting distance 117mm connection length 86mm connection male faston 6.3mm tube ø 8.5mm heating circuits 1 dry heating element 2 hole fixing		
For models:	69, R-109-1, R-109-2, R-109-3, R-111-1, R-111-2, R-111-3, R-66-1, R-66-2, R-66-3, R-69-1, R-69-2, R-69-3, R-77-1, R-77-2, R-77-3, R-96-1, R-96-2, R-96-3, R-99-1, R-99-2, R-99-3, RE-109-1, RE-109-2, RE-109-3, RE-111-1, RE-111-2, RE-111-3, RE-66-1, RE-66-2, RE-66-3, RE-69-1, RE-69-2, RE-69-3, RE-77-1, RE-77-2, RE-77-3, RE-96-1, RE-96-2, RE-96-3, RE-99-1, RE-99-2, RE-99-3, S-109-1, S-109-2, S-109-3, S-111-1, S-111-2, S-111-3, S-66-1...(Other models you can see in the webshop)		
accessories for	416468		
	Part No.	361183	Ref. No. —
	nut thread 3/8" H 6mm nickel-plated brass WS 20 Qty 1 pcs		
	Part No.	521137	Ref. No. —
	flat gasket fibre ED ø 20mm ID ø 18mm thickness 1.5mm for thread 3/8" Qty 1 pcs		


			
Part No.	420435	Ref. No.	EE247 EE24700
description	heating element 1300W 230V L 568mm W 158mm mounting distance 148mm connection F6.3 tube ø 8.5mm heating circuits 1		
For models:	R-109-1, R-109-2, R-109-3, R-111-1, R-111-2, R-111-3, R-66-1, R-66-2, R-66-3, R-69-1, R-69-2, R-69-3, R-77-1, R-77-2, R-77-3, R-96-1, R-96-2, R-96-3, R-99-1, R-99-2, R-99-3, RE-109-1, RE-109-2, RE-109-3, RE-111-1, RE-111-2, RE-111-3, RE-66-1, RE-66-2, RE-66-3, RE-69-1, RE-69-2, RE-69-3, RE-77-1, RE-77-2, RE-77-3, RE-96-1, RE-96-2, RE-96-3, RE-99-1, RE-99-2, RE-99-3, S-109-1, S-109-2, S-109-3, S-111-1, S-111-2, S-111-3, S-66-1, S-66-2...(Other models you can see in the webshop)		

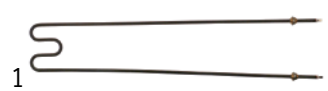
			
Part No.	416473	Ref. No.	EE11300
description	heating element 1300W 230V L 880mm W 163mm thread 3/8" mounting distance 153mm connection length 93mm connection M5 tube ø 10mm heating circuits 1 dry heating element 2 hole fixing		
For models:	109, 111, 66, 69, 77, 96, 99		
accessories for	416473		
	Part No.	361183	Ref. No. —
	nut thread 3/8" H 6mm nickel-plated brass WS 20 Qty 1 pcs		
	Part No.	521137	Ref. No. —
	flat gasket fibre ED ø 20mm ID ø 18mm thickness 1.5mm for thread 3/8" Qty 1 pcs		

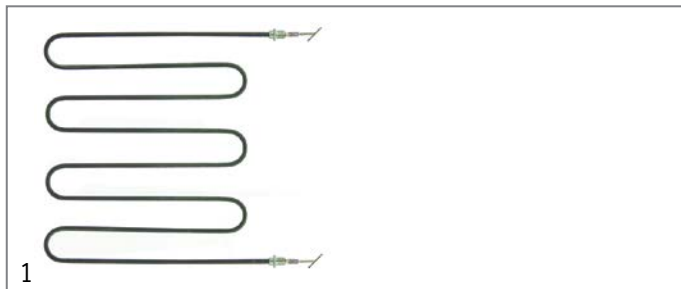
			
Part No.	420436	Ref. No.	EE12800
description	heating element 1300W 400V L 570mm W 162mm mounting distance 152mm connection F6.3 tube ø 10mm heating circuits 1		
For models:	R-109-1, R-109-2, R-109-3, R-111-1, R-111-2, R-111-3, R-66-1, R-66-2, R-66-3, R-69-1, R-69-2, R-69-3, R-77-1, R-77-2, R-77-3, R-96-1, R-96-2, R-96-3, R-99-1, R-99-2, R-99-3, RE-109-1, RE-109-2, RE-109-3, RE-111-1, RE-111-2, RE-111-3, RE-66-1, RE-66-2, RE-66-3, RE-69-1, RE-69-2, RE-69-3, RE-77-1, RE-77-2, RE-77-3, RE-96-1, RE-96-2, RE-96-3, RE-99-1, RE-99-2, RE-99-3, S-109-1, S-109-2, S-109-3, S-111-1, S-111-2, S-111-3, S-66-1, S-66-2...(Other models you can see in the webshop)		




			
Part No.	416475	Ref. No.	EE11500
description	heating element 1300W 400V L 880mm W 160mm thread 3/8" mounting distance 155mm connection length 109mm tube ø 10mm heating circuits 1 dry heating element 2 hole fixing		
For models:	99		
spare parts for	416475		
	Part No.	521137	Ref. No. —
	flat gasket fibre ED ø 20mm ID ø 18mm thickness 1.5mm for thread 3/8" Qty 1 pcs		
accessories for	416475		
	Part No.	361183	Ref. No. —
	nut thread 3/8" H 6mm nickel-plated brass WS 20 Qty 1 pcs		

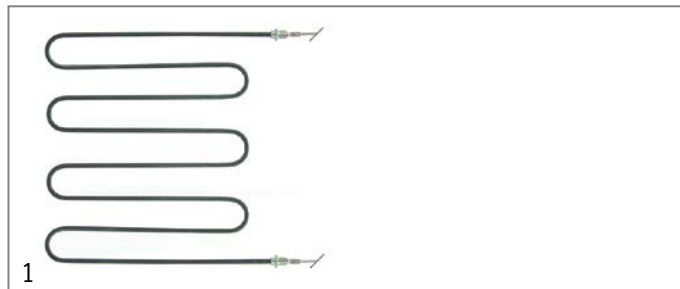
			
Part No.	416474	Ref. No.	EE08400
description	heating element 1600W 230V		
For models:	109, 111, 66, 69, 77, 96, 99		

			
Part No.	417540	Ref. No.	EE24400
description	heating element 1600W 230V L 895mm W 200mm thread 1/4" (tube ø 8mm) tube ø 8.5mm heating circuits 1		

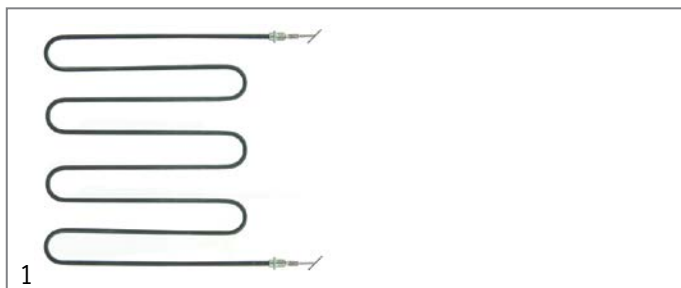
			
Part No.	416476	Ref. No.	EE11400
description	heating element 1600W 400V L 880mm W 155mm thread 3/8" mounting distance 145mm connection length 103mm tube ø 10mm heating circuits 1 dry heating element pizza oven		
For models:	99, R-109-1, R-109-2, R-109-3, R-111-1, R-111-2, R-111-3, R-66-1, R-66-2, R-66-3, R-69-1, R-69-2, R-69-3, R-77-1, R-77-2, R-77-3, R-96-1, R-96-2, R-96-3, R-99-1, R-99-2, R-99-3, RE-109-1, RE-109-2, RE-109-3, RE-111-1, RE-111-2, RE-111-3, RE-66-1, RE-66-2, RE-66-3, RE-69-1, RE-69-2, RE-69-3, RE-77-1, RE-77-2, RE-77-3, RE-96-1, RE-96-2, RE-96-3, RE-99-1, RE-99-2, RE-99-3, S-109-1, S-109-2, S-109-3, S-111-1, S-111-2, S-111-3, S-66-1...(Other models you can see in the webshop)		



Part No.	416462	Ref. No.	EE07000
description	heating element 1650W 230V L 470mm W 450mm thread 1/4" mounting distance 442mm connection length 40mm connection cable tube ø 8.5mm cable length 480mm heating circuits 1 dry heating element 2 hole fixing		
spare parts for	416462		
	Part No.	510417	Ref. No. —
	flat gasket fibre ED ø 20mm ID ø 14mm thickness 2mm Qty 1 pcs		
accessories for	416462		
	Part No.	361182	Ref. No. —
	nut thread 1/4" H 5mm nickel-plated brass WS 17 Qty 1 pcs		
	Part No.	520228	Ref. No. —
	tooth lock washer ID ø 15.3mm ED ø 24mm steel Qty 1 pcs for thread M14		
	Part No.	550262	Ref. No. —
	flat gasket copper ED ø 20mm ID ø 14mm thickness 2mm		



Part No.	416464	Ref. No.	EE17700 EE28200
description	heating element 2000W 230V L 600mm W 572mm thread 1/4" mounting distance 563mm connection length 45mm tube ø 8.6mm cable length 643mm heating circuits 1 dry heating element 2 hole fixing		
accessories for	416464		
	Part No.	361182	Ref. No. —
	nut thread 1/4" H 5mm nickel-plated brass WS 17 Qty 1 pcs		
	Part No.	510417	Ref. No. —
	flat gasket fibre ED ø 20mm ID ø 14mm thickness 2mm Qty 1 pcs		
	Part No.	520228	Ref. No. —
	tooth lock washer ID ø 15.3mm ED ø 24mm steel Qty 1 pcs for thread M14		
	Part No.	550262	Ref. No. —
	flat gasket copper ED ø 20mm ID ø 14mm thickness 2mm		



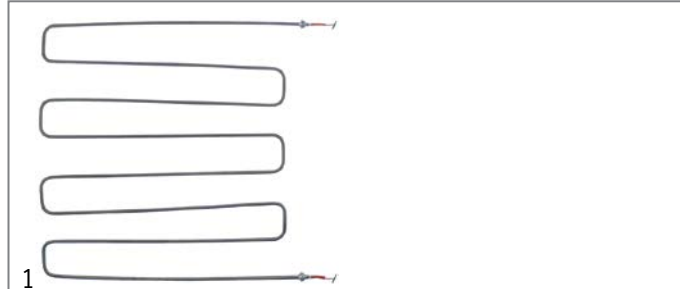
Part No.	416463	Ref. No.	EE23000
description	heating element 1700W 230V mounting pos. upper pizza oven		



Part No.	418889	Ref. No.	EE24800
description	heating element 2000W 230V L 880mm W 160mm thread 3/8" mounting distance 150mm connection length 105mm connection male faston 6.3mm tube ø 10mm heating circuits 1 dry heating element pizza oven		
For models:	R-109-1, R-109-2, R-109-3, R-111-1, R-111-2, R-111-3, R-66-1, R-66-2, R-66-3, R-69-1, R-69-2, R-69-3, R-77-1, R-77-2, R-77-3, R-96-1, R-96-2, R-96-3, R-99-1, R-99-2, R-99-3, RE-109-1, RE-109-2, RE-109-3, RE-111-1, RE-111-2, RE-111-3, RE-66-1, RE-66-2, RE-66-3, RE-69-1, RE-69-2, RE-69-3, RE-77-1, RE-77-2, RE-77-3, RE-96-1, RE-96-2, RE-96-3, RE-99-1, RE-99-2, RE-99-3, S-109-1, S-109-2, S-109-3, S-111-1, S-111-2, S-111-3, S-66-1, S-66-2...(Other models you can see in the webshop)		








Part No.	418888	Ref. No.	EE15000
description	heating element 1900W 400V L 880mm W 160mm thread 3/8" mounting distance 150mm connection length 105mm connection male faston 6.3mm tube ø 10mm heating circuits 1 dry heating element pizza oven		
For models:	R-109-1, R-109-2, R-109-3, R-111-1, R-111-2, R-111-3, R-66-1, R-66-2, R-66-3, R-69-1, R-69-2, R-69-3, R-77-1, R-77-2, R-77-3, R-96-1, R-96-2, R-96-3, R-99-1, R-99-2, R-99-3, RE-109-1, RE-109-2, RE-109-3, RE-111-1, RE-111-2, RE-111-3, RE-66-1, RE-66-2, RE-66-3, RE-69-1, RE-69-2, RE-69-3, RE-77-1, RE-77-2, RE-77-3, RE-96-1, RE-96-2, RE-96-3, RE-99-1, RE-99-2, RE-99-3, S-109-1, S-109-2, S-109-3, S-111-1, S-111-2, S-111-3, S-66-1, S-66-2...(Other models you can see in the webshop)		





Part No.	420437	Ref. No.	EE28100
description	heating element 3000W 230V L 672mm W 657mm mounting distance 647mm tube ø 8.5mm heating circuits 1		














			
Part No.	415804	Ref. No.	N/A
description	heating element 500W 400V L 515mm W 105mm thread 1/4" mounting distance 100mm connection length 24mm tube ø 8.5mm cable length 1000mm heating circuits 1 dry heating element 2 hole fixing		
accessories for	415804		
	Part No.	510417	Ref. No. —
	flat gasket fibre ED ø 20mm ID ø 14mm thickness 2mm Qty 1 pcs		
	Part No.	520228	Ref. No. —
	tooth lock washer ID ø 15.3mm ED ø 24mm steel Qty 1 pcs for thread M14		
	Part No.	550262	Ref. No. —
	flat gasket copper ED ø 20mm ID ø 14mm thickness 2mm		

			
Part No.	418640	Ref. No.	EE054 EE05400
description	heating element 600W 230V L 530mm W 106mm thread 1/4" mounting distance 98mm connection length 47mm connection cable tube ø 8.5mm cable length 980mm heating circuits 1 dry heating element 2 hole fixing		
For models:	MF 4		

			
Part No.	415943	Ref. No.	EE13300
description	heating element 600W 230V L 575mm W 127mm thread 1/4" mounting distance 119mm connection length 50mm tube ø 8.5mm cable length 1180mm heating circuits 1 dry heating element 2 hole fixing		
accessories for	415943		
	Part No.	361182	Ref. No. —
	nut thread 1/4" H 5mm nickel-plated brass WS 17 Qty 1 pcs		
	Part No.	510417	Ref. No. —
	flat gasket fibre ED ø 20mm ID ø 14mm thickness 2mm Qty 1 pcs		
	Part No.	520228	Ref. No. —
	tooth lock washer ID ø 15.3mm ED ø 24mm steel Qty 1 pcs for thread M14		
	Part No.	550262	Ref. No. —
	flat gasket copper ED ø 20mm ID ø 14mm thickness 2mm		

			
Part No.	415945	Ref. No.	EE13500
description	heating element 600W 400V L 575mm W 131mm thread 1/4" mounting distance 125mm connection length 34mm tube ø 8.5mm cable length 1200mm heating circuits 1 dry heating element 2 hole fixing		

			
Part No.	415944	Ref. No.	EE13200
description	heating element 700W 230V L 580mm W 122mm thread 1/4" mounting distance 109mm connection length 45mm tube ø 8.5mm cable length 1200mm heating circuits 1 dry heating element 2 hole fixing		
spare parts for	415944		
	Part No.	510417	Ref. No. —
	flat gasket fibre ED ø 20mm ID ø 14mm thickness 2mm Qty 1 pcs		
accessories for	415944		
	Part No.	361182	Ref. No. —
	nut thread 1/4" H 5mm nickel-plated brass WS 17 Qty 1 pcs		
	Part No.	520228	Ref. No. —
	tooth lock washer ID ø 15.3mm ED ø 24mm steel Qty 1 pcs for thread M14		
	Part No.	521012	Ref. No. —
	gasket graphite ED ø 15mm ID ø 5mm thickness 1.2mm Qty 1 pcs		
	Part No.	550262	Ref. No. —
	flat gasket copper ED ø 20mm ID ø 14mm thickness 2mm		

			
Part No.	415946	Ref. No.	EE13400
description	heating element 700W 400V L 575mm W 120mm thread 1/4" mounting distance 112mm connection length 28mm connection cable tube ø 8.5mm cable length 1180mm heating circuits 1 dry heating element 2 hole fixing		
spare parts for	415946		
	Part No.	510417	Ref. No. —
	flat gasket fibre ED ø 20mm ID ø 14mm thickness 2mm Qty 1 pcs		
accessories for	415946		
	Part No.	361182	Ref. No. —
	nut thread 1/4" H 5mm nickel-plated brass WS 17 Qty 1 pcs		
	Part No.	520228	Ref. No. —
	tooth lock washer ID ø 15.3mm ED ø 24mm steel Qty 1 pcs for thread M14		
	Part No.	550262	Ref. No. —
	flat gasket copper ED ø 20mm ID ø 14mm thickness 2mm		




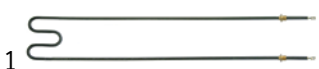



			
Part No.	416469	Ref. No.	EE10500
description	heating element 900W 230V L 583mm W 167mm thread 3/8" mounting distance 158mm connection length 90mm connection M5 tube ø 8.7mm heating circuits 1 dry heating element 2 hole fixing		
For models:	109, 111, 66, 69, 77, 96, 99		
accessories for	416469		
	Part No.	361183	Ref. No. —
	nut thread 3/8" H 6mm nickel-plated brass WS 20 Qty 1 pcs		

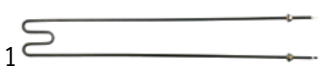


Table continues overleaf



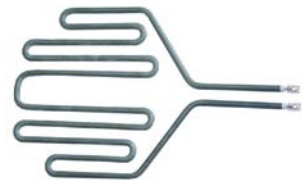
accessories for	416469		
	Part No.	521137	Ref. No. —
	flat gasket fibre ED ø 20mm ID ø 18mm thickness 1.5mm for thread 3/8" Qty 1 pcs		

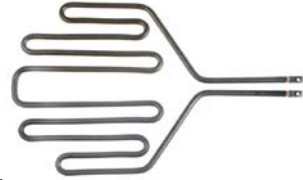
	1		
Part No.	416465	Ref. No.	EE10900
description	heating element 900W 230V L 875mm W 125mm thread 3/8" mounting distance 120mm connection length 70mm connection M5 tube ø 8.5mm heating circuits 1 dry heating element 2 hole fixing pizza oven		
For models:	109, 111, 66, 69, 77, 96, 99		

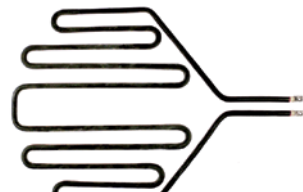
	1		
Part No.	416471	Ref. No.	EE10700
description	heating element 900W 400V L 580mm W 160mm thread 3/8" mounting distance 152mm connection length 86mm connection male faston 6.3mm tube ø 8.5mm heating circuits 1 dry heating element 2 hole fixing		
For models:	96		
accessories for	416471		
	Part No.	361183	Ref. No. —
	nut thread 3/8" H 6mm nickel-plated brass WS 20 Qty 1 pcs		
	Part No.	521137	Ref. No. —
	flat gasket fibre ED ø 20mm ID ø 18mm thickness 1.5mm for thread 3/8" Qty 1 pcs		

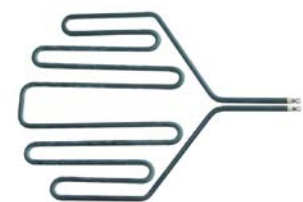
	1		
Part No.	416467	Ref. No.	EE11100
description	heating element 900W 400V L 979mm W 120mm thread 3/8" mounting distance 112mm connection length 89mm connection male faston 6.3mm tube ø 8.5mm heating circuits 1 dry heating element 2 hole fixing		
For models:	69		
spare parts for	416467		
	Part No.	521137	Ref. No. —
	flat gasket fibre ED ø 20mm ID ø 18mm thickness 1.5mm for thread 3/8" Qty 1 pcs		
accessories for	416467		
	Part No.	361183	Ref. No. —
	nut thread 3/8" H 6mm nickel-plated brass WS 20 Qty 1 pcs		

heating elements for pizza presses

	1		
Part No.	416477	Ref. No.	EE02800
description	heating element 1500W 230V L 364mm W 235mm connection M5 connection length 23mm L1 180mm L2 184mm W1 103mm W2 29mm dry heating element tube ø 8.5mm windings 5		
For models:	PF33MT		

	1		
Part No.	416478	Ref. No.	EE18100
description	heating element 1500W 400V L 369mm W 235mm heating circuits 1 connection M5 connection length 22mm L1 108mm L2 261mm W1 97mm W2 26mm dry heating element tube ø 8.5mm windings 5		
For models:	PF33MT		

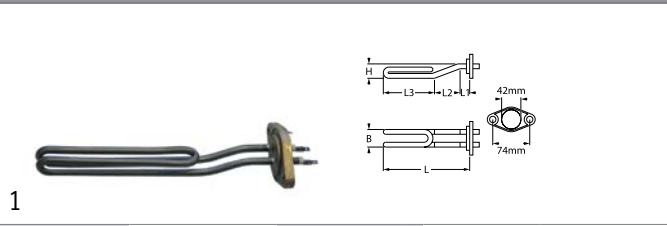
	1		
Part No.	416479	Ref. No.	EE03000 EE16300
description	heating element 3000W 230V L 493mm W 355mm connection M5 connection length 30mm L1 115mm L2 355mm W1 162mm W2 31mm dry heating element tube ø 10mm windings 5		
For models:	PF45HT, PF45MT-E		

	1		
Part No.	416480	Ref. No.	EE16200
description	heating element 3000W 400V L 490mm W 332mm connection male faston connection length 25mm L1 125mm L2 365mm W1 153mm W2 26mm dry heating element tube ø 10mm windings 5		
For models:	PF45HT, PF45MTE, PF45MT-E		







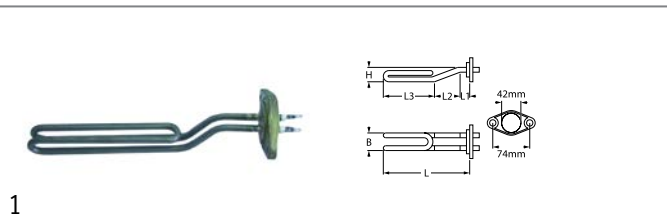
immersion heating elements

2 hole flange 74mm






Part No.	415191	Ref. No.	EE002
description	heating element 2300W 220V heating circuits 1 mounting ϕ 42mm L 240mm W 29mm H 27mm L1 35mm L2 35mm L3 170mm tube ϕ 8.5mm hole distance 74mm hole ϕ 8mm connection M4 immersion heater 2 hole flange H1 8mm H2 23mm flange length 94mm flange width 58mm		

accessories for	415191			
	Part No.	521103	Ref. No.	—
	nut thread M4 H 3mm WS 7 brass Qty 20 pcs			
	Part No.	521104	Ref. No.	—
	washer ID ϕ 4.3mm ED ϕ 8mm thickness 0.5mm brass Qty 20 pcs for thread M4			
	Part No.	560111	Ref. No.	—
	plain washer ID ϕ 4.3mm ED ϕ 9mm thickness 0.8mm SS Qty 20 pcs DIN 125A for thread M4			
	Part No.	560131	Ref. No.	—
	hexagonal nut thread M4 H 3.2mm WS 7 SS DIN/ISO DIN 934 / ISO 4032/8673 Qty 20 pcs			



Part No.	415192	Ref. No.	EE010
description	heating element 3000W 220V heating circuits 1 mounting ϕ 42mm L 225mm W 29mm H 39mm L1 20mm L2 35mm L3 170mm hole distance 74mm hole ϕ 9mm connection male faston 6.3mm immersion heater 2 hole flange		

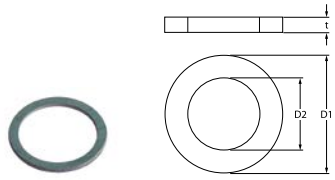


Part No.	415195	Ref. No.	EE001	
description	heating element 2500W 230V heating circuits 1 thread 1" L 200mm W 20mm H 20mm tube ϕ 8.5mm connection male faston 6.3mm immersion heater flange with thread			
accessories for	415195			
	Part No.	510404	Ref. No.	—
	flat gasket fibre ED ϕ 44mm ID ϕ 34mm thickness 2mm Qty 1 pcs			
	Part No.	510422	Ref. No.	—
	gasket copper ED ϕ 37.7mm ID ϕ 32.5mm thickness 2.7mm for thread 1"			
	Part No.	520233	Ref. No.	—
	nut thread 1" H 6mm brass WS 47 Qty 1 pcs			

accessories

sealing washers

rubber gaskets



Part No.	521125	Ref. No.	AD036
description	flat gasket rubber ED ϕ 52mm ID ϕ 42.5mm thickness 4mm Qty 1 pcs		


thermostats

control and safety thermostats

EGO

control thermostats

55.10/19_ series



Part No.	375309	Ref. No.	ED036R0 ED04800
description	thermostat t.max. 180°C temperature range 95-180°C 1-pole 1NO 16A probe ϕ 6mm probe L 130mm capillary pipe 1500mm capillary pipe isolated 1100mm gland nut shaft L 23mm shaft position upper rotation 270°		
For models:	PF33MT, PF45HT		



Part No.	375313	Ref. No.	ED00700
description	thermostat t.max. 358°C temperature range 60-358°C 1-pole 1NO 16A probe ϕ 3.03mm probe L 178mm capillary pipe 870mm capillary pipe isolated 870mm gland nut shaft L 23mm shaft position upper rotation 270°		




Part No.	376004	Ref. No.	ED05800
description	thermostat t.max. 422°C temperature range 65-422°C 1-pole 1CO 16A probe ø 4mm probe L 230mm capillary pipe 900mm capillary pipe isolated 630mm gland nut shaft L 23mm shaft position upper		

safety thermostats

55.10/19_ series



Part No.	375311	Ref. No.	ED04900
description	safety thermostat switch-off temp. 250°C 1-pole 16A probe ø 6mm probe L 87mm capillary pipe 1470mm capillary pipe isolated 1460mm gland nut probe SS		
For models:	PF33MT, PF45HT, PF45MTE, PF45MT-E		



Part No.	375191	Ref. No.	ED02300
description	safety thermostat switch-off temp. 500°C 1-pole 16A probe ø 3.9mm probe L 230mm capillary pipe 870mm capillary pipe isolated 660mm gland nut probe		
For models:	R-109-1, R-109-2, R-109-3, R-111-1, R-111-2, R-111-3, R-66-1, R-66-2, R-66-3, R-69-1, R-69-2, R-69-3, R-77-1, R-77-2, R-77-3, R-96-1, R-96-2, R-96-3, R-99-1, R-99-2, R-99-3, RE-109-1, RE-109-2, RE-109-3, RE-111-1, RE-111-2, RE-111-3, RE-66-1, RE-66-2, RE-66-3, RE-69-1, RE-69-2, RE-69-3, RE-77-1, RE-77-2, RE-77-3, RE-96-1, RE-96-2, RE-96-3, RE-99-1, RE-99-2, RE-99-3, S-109-1, S-109-2, S-109-3, S-111-1, S-111-2, S-111-3, S-66-1, S-66-2...(Other models you can see in the webshop)		


55.32_ series




Part No.	375065	Ref. No.	ED05500
description	safety thermostat switch-off temp. 500°C 3-pole 3NC 20A probe ø 4mm probe L 308mm capillary pipe 890mm capillary pipe isolatedmm gland nut probe SS		



IMIT / TEMPOMATIC / ARTHERMO

control thermostats



Part No.	390186	Ref. No.	ED002
description	thermostat t.max. 52°C temperature range fixed 52°C 1-pole 1CO 16A probe ø 6.5mm probe L 95mm capillary pipe 1000mm capillary pipe isolated 1000mm gland nut shaft Lmm contacts 1CO		



Part No.	390006	Ref. No.	ED001 ED00100	
description	thermostat t.max. 86°C temperature range 0-86°C 1-pole 1CO 16A probe ø 6.5mm probe L 95mm capillary pipe 1500mm capillary pipe isolatedmm gland nut shaft ø 6x4.6mm shaft L 19mm rotation 270°			
accessories for	390006			
	Part No.	110100	Ref. No.	—
	knob thermostat t.max. 90°C 0-90°C ø 42mm shaft ø 6x4.6mm shaft flat -135° black			
	Part No.	110105	Ref. No.	—
	rosette knob ø 42mm ø 56mm zero mark			



INVENSYS / ROBERTSHAW

control thermostats



Part No.	390636	Ref. No.	P8905-03
description	thermostat t.max. 204°C temperature range 93-204°C 1-pole 1NO 0.67A probe ø 9.5mm probe L 123mm capillary pipe 915mm capillary pipe isolatedmm gland nut 1/4" NPT shaft ø 6x4.6mm shaft L 21mm shaft position lower rotation 315° probe material nickel-plated probe thread 1/4" US		



Part No.	390771	Ref. No.	P5047585
description	thermostat temperature range 121-190°C 1-pole probe ø 8mm probe L 260mm capillary pipe 1200mm shaft ø 6x4.6mm shaft L 25mm shaft position lower rotation 315° operating temperature range 200-375°F		

control thermostats with actual value



Part No.	379039	Ref. No.	ED02200
description	thermostat t.max. 500°C temperature range 0-500°C 1CO 5A probe ø 8mm probe L 150mm capillary pipe 1100mm mounting ø 60mm front measurements 72x72mm		
For models:	109, 111, 22, 23, 32, 33 220V, 33 380V, 34 220V, 34 380V, 66, 69, 77, 96, 99, SG22, SG23, SG33		

switches and momentary switches

rocker/momentary rocker switches

30x11mm




Part No.	301013	Ref. No.	EF02300
description	rocker switch mounting measurements 30x11mm black 1CO 250V 16A connection male faston 6.3mm ambient temperature max. 85/125°C protection IP40		
For models:	22, 23, 32, 33 220V, 33 380V, 34 220V, 34 380V, R-109-1, R-109-2, R-109-3, R-111-1, R-111-2, R-111-3, R-66-1, R-66-2, R-66-3, R-69-1, R-69-2, R-69-3, R-77-1, R-77-2, R-77-3, R-96-1, R-96-2, R-96-3, R-99-1, R-99-2, R-99-3, S-109-1, S-109-2, S-109-3, S-111-1, S-111-2, S-111-3, S-66-1, S-66-2, S-66-3, S-69-1, S-69-2, S-69-3, S-77-1, S-77-2, S-77-3, S-96-1, S-96-2, S-96-3, S-99-1, S-99-2, S-99-3, SG22...(Other models you can see in the webshop)		

30x22mm



Part No.	345512	Ref. No.	EF00400
description	rocker switch mounting measurements 30x22mm orange 2NO 400V 16A illuminated O-I connection male faston 6.3mm ambient temperature max. 85/125°C protection IP40		
For models:	109, 111, 22, 23, 32, 33 220V, 33 380V, 34 220V, 34 380V, 66, 69, 77, 96, 99, PF33MT, PF45MTE, PF45MT-E, R-109-1, R-109-2, R-109-3, R-111-1, R-111-2, R-111-3, R-66-1, R-66-2, R-66-3, R-69-1, R-69-2, R-69-3, R-77-1, R-77-2, R-77-3, R-96-1, R-96-2, R-96-3, R-99-1, R-99-2, R-99-3, S-109-1, S-109-2, S-109-3, S-111-1, S-111-2, S-111-3, S-66-1, S-66-2, S-66-3, S-69-1, S-69-2, S-69-3...(Other models you can see in the webshop)		



Part No.	301004	Ref. No.	EF02400
description	rocker switch mounting measurements 30x22mm black 2CO 250V 16A connection male faston 6.3mm ambient temperature max. 125/55°C protection IP40		
accessories for	301004		
	Part No.	301036	Ref. No. —
	protective cover internal size 30x22mm for rocker switch mounting measurementsmm		


push/momentary push switches


ø16mm





Part No.	101029	Ref. No.	EF04800+EF04900+5000
description	momentary push switch mounting ø 16mm white 1NO 250V 16A connection male faston 6.3mm protection IP40 ambient temperature max. 150°C		





miscellaneous			
			
1			
Part No.	346475	Ref. No.	EF04400 EF08300
description	momentary push switch green illuminated display 220V connection male faston 6.3mm ambient temperature max. 125/85°C protection IP40		


microswitches			
pin-plunger actuated			
M10			
			
1			
Part No.	345032	Ref. No.	EG001 EG00100
description	microswitch with plunger thread M10x1 thread L 12mm 250V 16A 1CO connection male faston 6.3mm stroke 7mm mounting distance 22mm L 28mm ambient temperature max. 125°C type SP9603 actuating force: 180g		
For models:	PF33MT		


M12			
			
1			
Part No.	345694	Ref. No.	EG03100
description	microswitch with plunger mounting distance 25mm thread M12x1 thread L 14mm 250V 16A 1CO connection screw stroke 4mm L 49mm ambient temperature max. 125°C type MS10 actuating force: 350g		
For models:	PF33MT		

roller actuated			
roller 0°			
			
1			
Part No.	345693	Ref. No.	EG03200
description	microswitch with roller plunger 230V 16A 1CO connection screw ambient temperature max. 125°C thread L 14mm thread M10		
For models:	PF33MT, PF45HT		

roller 90°			
			
1			
Part No.	347096	Ref. No.	EG03700
description	microswitch with roller plunger 250V 20A 1CO connection screw L1 49mm ambient temperature max. 125°C thread L 14.5mm thread M12x1 mounting distance 25mm actuating force: 370g type Z15G1318		
For models:	PF33MT		

position switches			
PIZZATO			
FA series			
			
1			
Part No.	345697	Ref. No.	EG04100 EG04410
description	position switch		
For models:	PF45MTE, PF45MT-E		

			
1			
Part No.	345696	Ref. No.	EG04010
description	position switch cast aluminum 1NO/1NC 400V 3A L 86mm W 30mm H 16mm protection IP67 actuating force: 1000g screw connection mounting distance 20mm thr.ø M12mm cable 1800 thread L 15mm		
For models:	PF45MTE, PF45MT-E		

cam switches			
on/off			
			
1			
Part No.	300139	Ref. No.	EH01800
description	cam switch ON-OFF connection male faston		



rotary switches

BREMAS

A1600 series



1

Part No.	345762	Ref. No.	EH00900 EH00900+AC06200
-----------------	--------	-----------------	----------------------------

description rotary switch 3 1-0-2 sets of contacts 6 type CS0167085 400V 16A shaft ø 5x5mm shaft L 23mm shaft square connection screw

For models: 109, 111, 22, 23, 32, 33 380V, 34 380V, 66, 69, 77, 96, 99, R-109-1, R-109-2, R-109-3, R-111-1, R-111-2, R-111-3, R-66-1, R-66-2, R-66-3, R-69-1, R-69-2, R-69-3, R-77-1, R-77-2, R-77-3, R-96-1, R-96-2, R-96-3, R-99-1, R-99-2, R-99-3, S-109-1, S-109-2, S-109-3, S-111-1, S-111-2, S-111-3, S-66-1, S-66-2, S-66-3, S-69-1, S-69-2, S-69-3, S-77-1, S-77-2, S-77-3, S-96-1, S-96-2...(Other models you can see in the webshop)

accessories for 345762



Part No.	110932	Ref. No.	AC06200
-----------------	--------	-----------------	---------

knob switch zero mark t.max.°C ø 42mm shaft ø 6x4.6mm shaft flat upper black



1

Part No.	348174	Ref. No.	OMEH00900
-----------------	--------	-----------------	-----------

description rotary switch sets of contacts 6 3 1-0-2 type CA0167085V 400V 16A shaft ø 5x5mm shaft L 23mm shaft square connection screw

A2500 series



1

Part No.	346105	Ref. No.	EH00600
-----------------	--------	-----------------	---------

description rotary switch 2 0-1 sets of contacts 3 type CA0250003V 690V 32A shaft ø 5x5mm shaft L 23mm shaft square connection screw

For models: PF45HT

miscellaneous

1

Part No.	300223	Ref. No.	EH010 EH01000
-----------------	--------	-----------------	------------------

description rotary switch 3 1-0-2 500V 25A shaft ø 5x5mm shaft square connection screw ambient temperature max. 75°C

magnetic switches

M12x1



1

Part No.	345698	Ref. No.	EN06800
-----------------	--------	-----------------	---------

description magnetic switch thread M12x1 1NC 24-240V AC/DCV 0.005-0.2A connection cable cable length 2000mm L 42mm

For models: PF45MTE, PF45MT-E

miscellaneous

1

Part No.	692022	Ref. No.	EF057 EF05700
-----------------	--------	-----------------	------------------

description emergency stop switch

control equipment

MOELLER/EATON

push buttons - signal lamps



1

Part No.	345705	Ref. No.	EF05400 EF10000 EF10010
-----------------	--------	-----------------	-------------------------------

description push button mounting measurements ø22mm black tipping

For models: PF33MT, PF45MT-E

accessories for 345705



Part No.	345707	Ref. No.	EF04010 EF09600 EF09610
-----------------	--------	-----------------	-------------------------------

contact block 1NC/1NO

switch blocks




1


Part No.	345707	Ref. No.	EF04010 EF09600 EF09610
-----------------	--------	-----------------	-------------------------------


description contact block 1NC/1NO

For models: PF45MT-E




 <p>1</p>			
Part No.	345706	Ref. No.	EF04510 EF09800 EF09810
description	contact block 1NO		
For models:	PF33MT		

 <p>1</p>			
Part No.	346292	Ref. No.	50MAA78015
description	contact block screw 1NO		
For models:	PF33MT		


 <p>1</p>			
Part No.	346293	Ref. No.	50MAA78014
description	contact block holder triple		
For models:	PF33MT		


miscellaneous


 <p>1</p>			
Part No.	692026	Ref. No.	EF058 EF05800
description	contact block		


lamps

indicator lights

indicator light lenses			
ø10mm (type SRZ-2)			
 <p>1</p>			
Part No.	359358	Ref. No.	EL00200
description	indicator light housings mounting measurements ø10mm orange square		


indicator lamps for socket type SRZ / SDK / SDY / SFK			
 <p>1</p>			
Part No.	359132	Ref. No.	EL00300
description	indicator lamp green 250V connection male faston 6.3mm protection IP54 ambient temperature max. 85°C		

indicator lights (complete)			
30x11mm			
 <p>1</p>			
Part No.	359159	Ref. No.	EL01200
description	indicator light mounting measurements 30x11mm 230V yellow connection male faston 6.3mm temp.-resist. 125°C		


 <p>1</p>			
Part No.	359268	Ref. No.	EL03500
description	indicator light mounting measurements 30x11mm 400V yellow		
For models:	PF33MT, PF45HT		


screw-on/push-on fit

halogen lamp			
for socket E14 / E27			
 <p>1</p>			
Part No.	359728	Ref. No.	EL06600
description	halogen lamp socket E14 230V 40W ø 25mm lens L 54mm L 80mm temp.-resist. 300°C Qty 1		

for socket G4 / G6.35 / G9			
 <p>1 500°C</p>			
Part No.	359074	Ref. No.	EL062 EL06200
description	halogen lamp socket G6.35 12V 35W temp.-resist. 500°C		
For models:	R-109-1, R-109-2, R-109-3, R-111-1, R-111-2, R-111-3, R-66-1, R-66-2, R-66-3, R-69-1, R-69-2, R-69-3, R-77-1, R-77-2, R-77-3, R-96-1, R-96-2, R-96-3, R-99-1, R-99-2, R-99-3, RE-109-1, RE-109-2, RE-109-3, RE-111-1, RE-111-2, RE-111-3, RE-66-1, RE-66-2, RE-66-3, RE-69-1, RE-69-2, RE-69-3, RE-77-1, RE-77-2, RE-77-3, RE-96-1, RE-96-2, RE-96-3, RE-99-1, RE-99-2, RE-99-3, S-109-1, S-109-2, S-109-3, S-111-1, S-111-2, S-111-3, S-66-1, S-66-2...(Other models you can see in the webshop)		



			
1			
Part No.	359946	Ref. No.	EL07400
description	halogen lamp socket G9 230V 40W temp.-resist. 300°C		


			
1			
Part No.	359370	Ref. No.	EL04000
description	halogen lamp socket G6.35 12V 50W temp.-resist. 300°C ø 10mm L 44mm clear		
For models:	109, 111, 22, 23, 32, 33 220V, 33 380V, 34 220V, 34 380V, 66, 69, 77, 96, 99, SG22, SG23, SG33		



oven lamps


universal oven lamps

mounting diameter 35.5mm

			
1			
Part No.	359427	Ref. No.	EL073R0
description	lamp socket socket G9 mounting ø 35.5mm connection male faston 6.3mm		


			
1			
Part No.	359709	Ref. No.	AL19500
description	oven lamp glass thr. ø 33.5mm ø 42mm hard glas temp.-resist. 350°C		


			
1			
Part No.	359661	Ref. No.	AL201 AL20100
description	oven lamp glass thread 32.1 ø 58mm hard glas temp.-resist. 350°C		
For models:	R-109-1, R-109-2, R-109-3, R-111-1, R-111-2, R-111-3, R-66-1, R-66-2, R-66-3, R-69-1, R-69-2, R-69-3, R-77-1, R-77-2, R-77-3, R-96-1, R-96-2, R-96-3, R-99-1, R-99-2, R-99-3, RE-109-1, RE-109-2, RE-109-3, RE-111-1, RE-111-2, RE-111-3, RE-66-1, RE-66-2, RE-66-3, RE-69-1, RE-69-2, RE-69-3, RE-77-1, RE-77-2, RE-77-3, RE-96-1, RE-96-2, RE-96-3, RE-99-1, RE-99-2, RE-99-3, S-109-1, S-109-2, S-109-3, S-111-1, S-111-2, S-111-3, S-66-1, S-66-2...(Other models you can see in the webshop)		
accessories for	359661		
	Part No.	359700	Ref. No. AL26600
	gasket for pizza oven fibre glass ID ø 32.5mm ED ø 55mm thickness 5mm		



			
1			
Part No.	359700	Ref. No.	AL26600
description	gasket for pizza oven fibre glass ID ø 32.5mm ED ø 55mm thickness 5mm		
For models:	R-109-1, R-109-2, R-109-3, R-111-1, R-111-2, R-111-3, R-66-1, R-66-2, R-66-3, R-69-1, R-69-2, R-69-3, R-77-1, R-77-2, R-77-3, R-96-1, R-96-2, R-96-3, R-99-1, R-99-2, R-99-3, RE-109-1, RE-109-2, RE-109-3, RE-111-1, RE-111-2, RE-111-3, RE-66-1, RE-66-2, RE-66-3, RE-69-1, RE-69-2, RE-69-3, RE-77-1, RE-77-2, RE-77-3, RE-96-1, RE-96-2, RE-96-3, RE-99-1, RE-99-2, RE-99-3, S-109-1, S-109-2, S-109-3, S-111-1, S-111-2, S-111-3, S-66-1, S-66-2...(Other models you can see in the webshop)		

producer-specific oven lamps


OEM


			
1			
Part No.	359700	Ref. No.	AL26600
description	gasket for pizza oven fibre glass ID ø 32.5mm ED ø 55mm thickness 5mm		
For models:	R-109-1, R-109-2, R-109-3, R-111-1, R-111-2, R-111-3, R-66-1, R-66-2, R-66-3, R-69-1, R-69-2, R-69-3, R-77-1, R-77-2, R-77-3, R-96-1, R-96-2, R-96-3, R-99-1, R-99-2, R-99-3, RE-109-1, RE-109-2, RE-109-3, RE-111-1, RE-111-2, RE-111-3, RE-66-1, RE-66-2, RE-66-3, RE-69-1, RE-69-2, RE-69-3, RE-77-1, RE-77-2, RE-77-3, RE-96-1, RE-96-2, RE-96-3, RE-99-1, RE-99-2, RE-99-3, S-109-1, S-109-2, S-109-3, S-111-1, S-111-2, S-111-3, S-66-1, S-66-2...(Other models you can see in the webshop)		


			
1			
Part No.	359639	Ref. No.	EL06900
description	lamp socket socket E14 with grip fixing		



			
1			
Part No.	359661	Ref. No.	AL201 AL20100
description	oven lamp glass thread 32.1 ø 58mm hard glas temp.-resist. 350°C		
For models:	R-109-1, R-109-2, R-109-3, R-111-1, R-111-2, R-111-3, R-66-1, R-66-2, R-66-3, R-69-1, R-69-2, R-69-3, R-77-1, R-77-2, R-77-3, R-96-1, R-96-2, R-96-3, R-99-1, R-99-2, R-99-3, RE-109-1, RE-109-2, RE-109-3, RE-111-1, RE-111-2, RE-111-3, RE-66-1, RE-66-2, RE-66-3, RE-69-1, RE-69-2, RE-69-3, RE-77-1, RE-77-2, RE-77-3, RE-96-1, RE-96-2, RE-96-3, RE-99-1, RE-99-2, RE-99-3, S-109-1, S-109-2, S-109-3, S-111-1, S-111-2, S-111-3, S-66-1, S-66-2...(Other models you can see in the webshop)		
accessories for	359661		
	Part No.	359700	Ref. No. AL26600
	gasket for pizza oven fibre glass ID ø 32.5mm ED ø 55mm thickness 5mm		






 <p>1</p>			
Part No.	698562	Ref. No.	QAT2200
description	reflector L 120mm W 108mm ø 120mm H 33mm for pizza oven		
For models:	R-109-1, R-109-2, R-109-3, R-111-1, R-111-2, R-111-3, R-66-1, R-66-2, R-66-3, R-69-1, R-69-2, R-69-3, R-77-1, R-77-2, R-77-3, R-96-1, R-96-2, R-96-3, R-99-1, R-99-2, R-99-3, RE-109-1, RE-109-2, RE-109-3, RE-111-1, RE-111-2, RE-111-3, RE-66-1, RE-66-2, RE-66-3, RE-69-1, RE-69-2, RE-69-3, RE-77-1, RE-77-2, RE-77-3, RE-96-1, RE-96-2, RE-96-3, RE-99-1, RE-99-2, RE-99-3, S-109-1, S-109-2, S-109-3, S-111-1, S-111-2, S-111-3, S-66-1, S-66-2...(Other models you can see in the webshop)		


 <p>1</p>			
Part No.	698561	Ref. No.	HAT6400 HAT6410
description	bracket H 40mm L 178mm W 98mm for lamp		
For models:	R-109-1, R-109-2, R-109-3, R-111-1, R-111-2, R-111-3, R-66-1, R-66-2, R-66-3, R-69-1, R-69-2, R-69-3, R-77-1, R-77-2, R-77-3, R-96-1, R-96-2, R-96-3, R-99-1, R-99-2, R-99-3, RE-109-1, RE-109-2, RE-109-3, RE-111-1, RE-111-2, RE-111-3, RE-66-1, RE-66-2, RE-66-3, RE-69-1, RE-69-2, RE-69-3, RE-77-1, RE-77-2, RE-77-3, RE-96-1, RE-96-2, RE-96-3, RE-99-1, RE-99-2, RE-99-3, S-109-1, S-109-2, S-109-3, S-111-1, S-111-2, S-111-3, S-66-1, S-66-2...(Other models you can see in the webshop)		


 <p>1</p>			
Part No.	359700	Ref. No.	AL26600
description	gasket for pizza oven fibre glass ID ø 32.5mm ED ø 55mm thickness 5mm		
For models:	R-109-1, R-109-2, R-109-3, R-111-1, R-111-2, R-111-3, R-66-1, R-66-2, R-66-3, R-69-1, R-69-2, R-69-3, R-77-1, R-77-2, R-77-3, R-96-1, R-96-2, R-96-3, R-99-1, R-99-2, R-99-3, RE-109-1, RE-109-2, RE-109-3, RE-111-1, RE-111-2, RE-111-3, RE-66-1, RE-66-2, RE-66-3, RE-69-1, RE-69-2, RE-69-3, RE-77-1, RE-77-2, RE-77-3, RE-96-1, RE-96-2, RE-96-3, RE-99-1, RE-99-2, RE-99-3, S-109-1, S-109-2, S-109-3, S-111-1, S-111-2, S-111-3, S-66-1, S-66-2...(Other models you can see in the webshop)		


 <p>1</p>				
Part No.	359320	Ref. No.	EI03100 EL05600	
description	lamp socket 24V socket G6.35 cable length 280mm connection male faston 6.3mm ø 16mm H 10mm mounting distance 26mm holder length 32mm Qty 1 pcs			
For models:	109, 111, 22, 23, 32, 33 220V, 33 380V, 34 220V, 34 380V, 66, 69, 77, 96, 99, R-109-1, R-109-2, R-109-3, R-111-1, R-111-2, R-111-3, R-66-1, R-66-2, R-66-3, R-69-1, R-69-2, R-69-3, R-77-1, R-77-2, R-77-3, R-96-1, R-96-2, R-96-3, R-99-1, R-99-2, R-99-3, RE-109-1, RE-109-2, RE-109-3, RE-111-1, RE-111-2, RE-111-3, RE-66-1, RE-66-2, RE-66-3, RE-69-1, RE-69-2, RE-69-3, RE-77-1, RE-77-2, RE-77-3...(Other models you can see in the webshop)			
accessories for	359320			
	Part No.	359370	Ref. No.	EL04000
	 halogen lamp socket G6.35 12V 50W temp.-resist. 300°C ø 10mm L 44mm clear			

accessories for	359320			
	Part No.	359661	Ref. No.	AL201 AL20100
	 oven lamp glass thread 32.1 ø 58mm hard glas temp.-resist. 350°C			


 <p>1</p>				
Part No.	359661	Ref. No.	AL201 AL20100	
description	oven lamp glass thread 32.1 ø 58mm hard glas temp.-resist. 350°C			
For models:	R-109-1, R-109-2, R-109-3, R-111-1, R-111-2, R-111-3, R-66-1, R-66-2, R-66-3, R-69-1, R-69-2, R-69-3, R-77-1, R-77-2, R-77-3, R-96-1, R-96-2, R-96-3, R-99-1, R-99-2, R-99-3, RE-109-1, RE-109-2, RE-109-3, RE-111-1, RE-111-2, RE-111-3, RE-66-1, RE-66-2, RE-66-3, RE-69-1, RE-69-2, RE-69-3, RE-77-1, RE-77-2, RE-77-3, RE-96-1, RE-96-2, RE-96-3, RE-99-1, RE-99-2, RE-99-3, S-109-1, S-109-2, S-109-3, S-111-1, S-111-2, S-111-3, S-66-1, S-66-2...(Other models you can see in the webshop)			
accessories for	359661			
	Part No.	359700	Ref. No.	AL26600
	 gasket for pizza oven fibre glass ID ø 32.5mm ED ø 55mm thickness 5mm			


 <p>1</p>			
Part No.	698562	Ref. No.	QAT2200
description	reflector L 120mm W 108mm ø 120mm H 33mm for pizza oven		
For models:	R-109-1, R-109-2, R-109-3, R-111-1, R-111-2, R-111-3, R-66-1, R-66-2, R-66-3, R-69-1, R-69-2, R-69-3, R-77-1, R-77-2, R-77-3, R-96-1, R-96-2, R-96-3, R-99-1, R-99-2, R-99-3, RE-109-1, RE-109-2, RE-109-3, RE-111-1, RE-111-2, RE-111-3, RE-66-1, RE-66-2, RE-66-3, RE-69-1, RE-69-2, RE-69-3, RE-77-1, RE-77-2, RE-77-3, RE-96-1, RE-96-2, RE-96-3, RE-99-1, RE-99-2, RE-99-3, S-109-1, S-109-2, S-109-3, S-111-1, S-111-2, S-111-3, S-66-1, S-66-2...(Other models you can see in the webshop)		


 <p>1</p>			
Part No.	359324	Ref. No.	HAT0110
description	frame for lamp		
For models:	SG22, SG23, SG33		


 <p>1</p>			
Part No.	359325	Ref. No.	AL03220
description	gasket		
For models:	SG22, SG23, SG33		







			
1			
Part No.	359323	Ref. No.	AL04000 AL04000 + AL03220
description	lamp glass with gasket L 154mm W 63mm thickness 8mm		
For models:	22, 23, 32, 33 220V, 33 380V, 34 220V, 34 380V, SG22, SG23, SG33		


			
1			
Part No.	359323	Ref. No.	AL04000 AL04000 + AL03220
description	lamp glass with gasket L 154mm W 63mm thickness 8mm		
For models:	22, 23, 32, 33 220V, 33 380V, 34 220V, 34 380V, SG22, SG23, SG33		


			
1			
Part No.	359322	Ref. No.	HAT5910
description	lamp holder for bulb socket		
For models:	SG22, SG23, SG33		


			
1			
Part No.	359639	Ref. No.	EL06900
description	lamp socket socket E14 with grip fixing		

			
1			
Part No.	359320	Ref. No.	EI03100 EL05600
description	lamp socket 24V socket G6.35 cable length 280mm connection male faston 6.3mm ø 16mm H 10mm mounting distance 26mm holder length 32mm Qty 1 pcs		
For models:	109, 111, 22, 23, 32, 33 220V, 33 380V, 34 220V, 34 380V, 66, 69, 77, 96, 99, R-109-1, R-109-2, R-109-3, R-111-1, R-111-2, R-111-3, R-66-1, R-66-2, R-66-3, R-69-1, R-69-2, R-69-3, R-77-1, R-77-2, R-77-3, R-96-1, R-96-2, R-96-3, R-99-1, R-99-2, R-99-3, RE-109-1, RE-109-2, RE-109-3, RE-111-1, RE-111-2, RE-111-3, RE-66-1, RE-66-2, RE-66-3, RE-69-1, RE-69-2, RE-69-3, RE-77-1, RE-77-2, RE-77-3...(Other models you can see in the webshop)		
accessories for	359320		
	Part No.	359370	Ref. No. EL04000
	Part No.	359661	Ref. No. AL201 AL20100

lamps			
halogen lamps			
for socket E14 / E27			
			
1			
Part No.	359728	Ref. No.	EL06600
description	halogen lamp socket E14 230V 40W ø 25mm lens L 54mm L 80mm temp.-resist. 300°C Qty 1		

for socket G4 / G6.35 / G9			
			
1 500°C			
Part No.	359074	Ref. No.	EL062 EL06200
description	halogen lamp socket G6.35 12V 35W temp.-resist. 500°C		
For models:	R-109-1, R-109-2, R-109-3, R-111-1, R-111-2, R-111-3, R-66-1, R-66-2, R-66-3, R-69-1, R-69-2, R-69-3, R-77-1, R-77-2, R-77-3, R-96-1, R-96-2, R-96-3, R-99-1, R-99-2, R-99-3, RE-109-1, RE-109-2, RE-109-3, RE-111-1, RE-111-2, RE-111-3, RE-66-1, RE-66-2, RE-66-3, RE-69-1, RE-69-2, RE-69-3, RE-77-1, RE-77-2, RE-77-3, RE-96-1, RE-96-2, RE-96-3, RE-99-1, RE-99-2, RE-99-3, S-109-1, S-109-2, S-109-3, S-111-1, S-111-2, S-111-3, S-66-1, S-66-2...(Other models you can see in the webshop)		


			
1			
Part No.	359325	Ref. No.	AL03220
description	gasket		
For models:	SG22, SG23, SG33		

			
1			
Part No.	359946	Ref. No.	EL07400
description	halogen lamp socket G9 230V 40W temp.-resist. 300°C		




timers

programme timers




1

Part No.	360035	Ref. No.	EC016
description	timer CDC 4902F engines 1 chambers 2 operation time 120s 230V shaft \varnothing 6x4.6mm shaft L 17mm manuf. no. 4902F1 / 3322050 motor type M48L ATS		
spare parts for	360035		
	Part No.	360083	Ref. No. —
	motor CDC pinion \varnothing 4.9mm teeth 10 230V turn direction left motor \varnothing 47mm H 19.3mm motor type M48L ATS for timer		



1

Part No.	360040	Ref. No.	EC030
description	timer CDC 9003F engines 1 chambers 3 operation time 6min 230V shaft \varnothing 6x4.6mm shaft L 21mm manuf. no. 9003F3 / PRCIH5 motor type M48R ATS		
spare parts for	360040		
	Part No.	360118	Ref. No. —
	motor CDC pinion \varnothing 4.9mm teeth 10 230V voltage AC 50/60Hz turn direction right motor \varnothing 47mm H 19.3mm motor type M48R ATS for timer cable length 260mm 1.9/2.5W		
accessories for	360040		
	Part No.	110197	Ref. No. —
	knob switch zero mark \varnothing 42mm shaft \varnothing 6x4.6mm shaft flat adjustable black		

contactors

ISKRA (FANAL)

power contactors



1

Part No.	380204	Ref. No.	EN00500 EN08200
description	power contactor resistive load 25A 230VAC (AC3/400V) 9A/4kW main contacts 3NO auxiliary contacts 1NO connection screw connection type Fanal DSL9 10 type ISKRA KNL9 10		


LOVATO

power contactors



1

Part No.	380914	Ref. No.	EN13900
description	power contactor resistive load 20A 230VAC (AC3/400V) 9A/4kW main contacts 6NO auxiliary contacts 2NC connection screw connection type 11BGR0901A230		
For models:	PF45MT-E		



1




Part No.	380855	Ref. No.	EN00500 EN08200
description	power contactor resistive load 25A 230VAC (AC3/400V) 4.2kW main contacts 3NO auxiliary contacts 1NO		
For models:	109, 111, 22, 23, 32, 33 380V, 34 380V, 66, 69, 77, 96, 99, PF45HT, PF45MTE, PF45MT-E, R-109-1, R-109-2, R-109-3, R-111-1, R-111-2, R-111-3, R-66-1, R-66-2, R-66-3, R-69-1, R-69-2, R-69-3, R-77-1, R-77-2, R-77-3, R-96-1, R-96-2, R-96-3, R-99-1, R-99-2, R-99-3, S-109-1, S-109-2, S-109-3, S-111-1, S-111-2, S-111-3, S-66-1, S-66-2, S-66-3, S-69-1, S-69-2, S-69-3, S-77-1, S-77-2...(Other models you can see in the webshop)		
accessories for	380855		
	Part No.	380055	Ref. No. —
	RC circuit voltage AC/DC suitable for BF09-32 rated 240V		


Table continues overleaf



accessories for	380855		
	Part No.	380118	Ref. No.
			—
description	auxiliary contact contacts 1NO/1NC AC1 10A for contactors BF series connection screw type G480/11		

	1		
Part No.	380714	Ref. No.	EN08200 EN17000
description	power contactor resistive load 25A 230VAC (AC3/400V) 9A/4.2kW main contacts 3NO auxiliary contacts 1NO connection screw connection type BF0910A230		


auxiliary contacts

	1		
Part No.	380057	Ref. No.	EN13100
description	auxiliary contact contacts 1NO/1NC AC1 10A for contactors BG series connection screw type BGX1011		
For models:	PF45MT-E		

relays


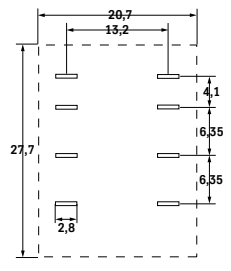




power relays

with bracket mounting


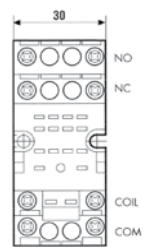

	1		
Part No.	380139	Ref. No.	EN12500
description	power relays FINDER 230VAC 16A 2CO connection F6.3 bracket mounting dimensions 68x38.2x35.8mm manuf. no. 62.82.8.230.0000		

with male contacts



female contact 2.0mm

	1		
			
Part No.	380377	Ref. No.	EN01600
description	power relays FINDER 220-240VAC 10A 2CO connection F2 plug-in connection manuf. no. 55.32.8.230.0000 94.92.3 250V		
For models:	PF45HT, PF45MTE, PF45MT-E		
accessories for	380377		
	Part No.	380341	Ref. No.
			—
description	relay socket 4-pole contacts 12 300V voltage AC 6A Italiana Relè manuf. no. ZMD4		
	Part No.	380378	Ref. No.
			EN01700
description	relay socket 2-pole 55/85 dimensions 70.5x30x27mm 250V voltage AC 10A FINDER manuf. no. 94.72		
	Part No.	380384	Ref. No.
			—
description	relay socket 2-pole contacts male faston 2.8mm 250V voltage AC 10A W 23mm for		
	Part No.	380399	Ref. No.
			—
description	relay socket 4-pole dimensions 76.2x27x86.1mm 250V voltage AC 1A FINDER manuf. no. 94.94.3		

relay sockets


	1		
			
Part No.	380378	Ref. No.	EN01700
description	relay socket 2-pole 55/85 dimensions 70.5x30x27mm 250V voltage AC 10A FINDER manuf. no. 94.72		
For models:	PF45HT, PF45MTE, PF45MT-E		
accessories for	380378		
	Part No.	380804	Ref. No.
			—
description	support bracket		



			
1			
Part No.	380137	Ref. No.	EC02700
description	relay socket 8-pole connection plug-in connection round 8-pole dimensions 65x28x40mm 380V voltage AC 10A Italiana Relè manuf. no. ZVE8		
For models:	PF33MT, PF45HT		
accessories for	380137		
	Part No.	Ref. No.	—
	 support bracket		


encapsulated transformers

PMA

			
1			
Part No.	379054	Ref. No.	EH03200
description	transformer primary 230VAC secondary 12VAC 3VA secondary 0.25A H 40mm L 45mm W 50mm connection screw 50/60Hz type 153/M		
For models:	PF45MTE		

time relays

time relays


			
1			
Part No.	360693	Ref. No.	EC03900
description	time relay CDC Sc.741 time range 3s-60min 48-230V mounting measurements 35x35mm connection P.35.002		
For models:	PF33MT, PF45HT		

electronic controllers

ELIWELL


universal controllers

built-in version

			
1			
Part No.	379568	Ref. No.	ED051 ED077
description	electronic controller ELIWELL type ICPPlus915 model ICP22JI750000 mounting measurements 71x29mm 230V voltage AC Pt100/TC (J,K) relay outputs 2 CO-8A(4) CO-8A(4) Pt100/TC (J,K,S) DI front measurements 78x37mm built-in depth 60mm mode of operation cooking protection IPx0 accuracy 1% built-in version defr. funct. no -150 to 1350°C display 3½ digits		
accessories for	379568		
	Part No.	Ref. No.	—
	alarm device AKO type AKO-520641 mounting measurements 214x214mm 230V voltage AC relay outputs 1 CO-8A(4) up to 4 front measurements 222x222mm yes yes		
	Part No.	Ref. No.	—
	temperature probe thermocouple J (Fe-CuNi) cable Vetrotex probe -50 up to +750°C cable -50 up to +350°C probe ø3x100mm cable length 3m without screw connection 2-wire		
	Part No.	Ref. No.	—
	temperature probe thermocouple K (NiCr-Ni) cable Vetrotex probe -50 up to 1150°C cable -50 up to +350°C probe ø4.5x150mm cable length 3m without screw connection 2-wire		
	Part No.	Ref. No.	—
	temperature probe Pt100 cable Vetrotex probe -200 up to +600°C cable -50 up to +350°C probe ø6x100mm cable length 2.7m without screw connection 3-wire		
	Part No.	Ref. No.	—
	temperature probe thermocouple J (Fe-CuNi) cable Vetrotex probe -50 up to +750°C cable -50 up to +350°C probe ø6x50mm cable length 3m without screw connection 2-wire		

transformers

toroidal core transformers

			
1			
Part No.	101028	Ref. No.	EH03300 EH04500 EH04510
description	transformer primary 0-230VAC secondary 0-12VAC 50VA H 30mm L 80mm W 80mm connection grip connection 50/60Hz type 147340F for ignition		
For models:	R-109-1, R-109-2, R-109-3, R-111-1, R-111-2, R-111-3, R-66-1, R-66-2, R-66-3, R-69-1, R-69-2, R-69-3, R-77-1, R-77-2, R-77-3, R-96-1, R-96-2, R-96-3, R-99-1, R-99-2, R-99-3, RE-109-1, RE-109-2, RE-109-3, RE-111-1, RE-111-2, RE-111-3, RE-66-1, RE-66-2, RE-66-3, RE-69-1, RE-69-2, RE-69-3, RE-77-1, RE-77-2, RE-77-3, RE-96-1, RE-96-2, RE-96-3, RE-99-1, RE-99-2, RE-99-3, S-109-1, S-109-2, S-109-3, S-111-1, S-111-2, S-111-3, S-66-1, S-66-2...(Other models you can see in the webshop)		



refrigeration controllers

built-in version



1

Part No.	379018	Ref. No.	ED05100 ED07700
description	electronic controller ELIWELL type EWPC902T thermocouple J		
For models:	PF45MT-E, R-109-1, R-109-2, R-109-3, R-111-1, R-111-2, R-111-3, R-66-1, R-66-2, R-66-3, R-69-1, R-69-2, R-69-3, R-77-1, R-77-2, R-77-3, R-96-1, R-96-2, R-96-3, R-99-1, R-99-2, R-99-3, S-109-1, S-109-2, S-109-3, S-111-1, S-111-2, S-111-3, S-66-1, S-66-2, S-66-3, S-69-1, S-69-2, S-69-3, S-77-1, S-77-2, S-77-3, S-96-1, S-96-2, S-96-3, S-99-1, S-99-2, S-99-3		

PIXSYS

universal controllers

built-in version



1

Part No.	379857	Ref. No.	ED01800
description	electronic controller PIXSYS type ATR150-2AB mounting measurements 66.5x66.5mm 24/230V voltage AC PTC/Pt100/TC(J/K/S) relay outputs 1 relay defr. funct. no display 4 digits TempIn1 yes 8A		
For models:	22, 23, 32, 33, 34		

SHANGFANG

accessories



1

Part No.	379054	Ref. No.	EH03200
description	transformer primary 230VAC secondary 12VAC 3VA secondary 0.25A H 40mm L 45mm W 50mm connection screw 50/60Hz type 153/M		
For models:	PF45MTE		

probes

producer-specific probes

probes

1

Part No.	379457	Ref. No.	E023200
description	extension for probe		
For models:	PF45MTE		

1

Part No.	378457	Ref. No.	ED08320
description	temperature probe Pt1000 cable silicone probe -100 up to 450°C cable -50 up to +180°C connection plug thread probe ø3x280mm cable length 1.95m		

1

Part No.	379000	Ref. No.	ED07100
description	temperature probe thermocouple J (Fe-CuNi) cable red/blue cable length 0.7m probe ø 2mm probe L 2000mm		

1

Part No.	379451	Ref. No.	ED01900 ED06500
description	temperature probe thermocouple J cable silicone probe -50 up to 1150°C cable -50 up to +180°C connection 2-wire thread probe ø2x250mm cable length 1.5m		
For models:	109, 111, 66, 69, 77, 96, 99, R-109-1, R-109-2, R-109-3, R-111-1, R-111-2, R-111-3, R-66-1, R-66-2, R-66-3, R-69-1, R-69-2, R-69-3, R-77-1, R-77-2, R-77-3, R-96-1, R-96-2, R-96-3, R-99-1, R-99-2, R-99-3, RE-109-1, RE-109-2, RE-109-3, RE-111-1, RE-111-2, RE-111-3, RE-66-1, RE-66-2, RE-66-3, RE-69-1, RE-69-2, RE-69-3, RE-77-1, RE-77-2, RE-77-3, RE-96-1, RE-96-2, RE-96-3, RE-99-1, RE-99-2, RE-99-3, S-109-1...(Other models you can see in the webshop)		

1


Part No.	379454	Ref. No.	ED05200 ED06600
description	temperature probe thermocouple K (NiCr-Ni) cable silicone probe -50 up to 1150°C cable -50 up to +180°C connection male faston thread probe ø2x250mm cable length 2.5m		
For models:	PF45MTE, PF45MT-E		



electronics


PCBs

1




Part No.	403457	Ref. No.	HE185 HE18500 OMHE23400
description	main PCB pizza oven 430DS L 91mm W 84mm suitable for OEM 230V		

1



Part No.	401631	Ref. No.	SR8H000 SR8H510
description	PCB		

1




Part No.	401939	Ref. No.	HE12400
description	PCB		

1

Part No.	692023	Ref. No.	R3H00 R3H0000
description	PCB		

Triacs


1



Part No.	400576	Ref. No.	HE05600
description	Triac		
For models:	22, 23, 32, 33, 34		

central units

1




Part No.	401092	Ref. No.	50PAA78246
description	control box 400V		

keypads

membrane keypads

1




Part No.	401420	Ref. No.	96.00364
description	membrane keypad 6 buttons		

solenoid valves

solenoid valves (gas)

ASCO

1



Part No.	101378	Ref. No.	EB01800
description	solenoid valve 2-ways 230VAC connection 1/2" L 58mm Asco p max 0.14bar slide-on receptacle DIN gas		
For models:	SG22, SG23, SG33		

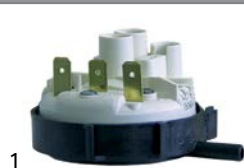


pressure switches

for warewashing

ø 58mm with male faston 6.3mm

with connection horizontal



Part No.	541011	Ref. No.	EI002
description	pressure control pressure range 110/70mbar connection 6mm ø 58mm pressure connection horizontal warewashing		





Part No.	541010	Ref. No.	EI001
description	pressure control pressure range 50/30mbar connection 6mm ø 58mm pressure connection horizontal warewashing		

fans

axial fans

import



Part No.	601080 ¹	Ref. No.	ES22700
description	axial fan L 119mm W 119mm H 38mm 230VAC 50/60Hz 23/20W bearing ball bearing connection male faston 2.8mm metal ADDA fan wheel ø 110mm temp.-resist. 70°C		
accessories for	601080		
	Part No.	550898	Ref. No. —
	connecting cable cable length 2000mm connection F 2.8 connection distance 7.9mm for axial flow fan		
	Part No.	692519	Ref. No. —
	guard L 120mm W 120mm plastic		

¹with ball bearings

motors

motors

universal



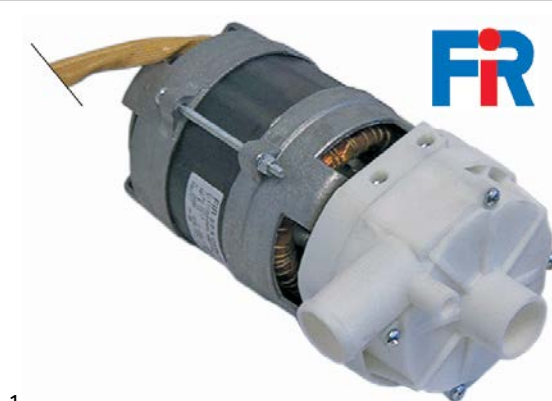
Part No.	501371	Ref. No.	ES11200
description	motor 250W 230/400V 50Hz 3 phase shaft ø 11mm flange ø 140mm 1400rpm type 63 BA.M.E. flange B5 0.25kW		
For models:	PF33MT		



pumps

wash and rinse pumps

FIR

pumps



Part No.	500037	Ref. No.	EA009
description	pump inlet ø 28mm outlet ø 26mm type 2211.1410 230V 50Hz 1 phase 0.074kW 0.1HP L 190mm rotation direction left capacitor 5µF FIR		
spare parts for	500037		
	Part No.	365017	Ref. No. —
	operating capacitor capacity 5µF 450V tolerance 5% 50/60Hz ambient temperature max. -25 to +85°C ø 28mm L 54mm M8 plastic connection male faston 6.3mm 16.10.08 protection		
	Part No.	510384	Ref. No. —
	pump cover inlet ø 28mm outlet ø 26mm ø 100mm ID ø 76mm		
	Part No.	510695	Ref. No. —
	mechanical shaft seal height counter ring 5.5mm ID ø 11mm		
	Part No.	521203	Ref. No. —
	impeller ø 72mm H 18mm thread M7 shaft ø 11mm shaft length 32mm blades 3		
	Part No.	521703	Ref. No. —
	pump cover gasket EPDM thickness 2.5mm ID ø 75mm Qty 1 pcs		



1

Part No.	500038	Ref. No.	EA003
description	pump inlet \varnothing 45mm outlet \varnothing 40mm type 3911.1425 230V 50Hz 1 phase 0.55kW 0.75HP L 205mm rotation direction right capacitor 10 μ F FIR		
spare parts for	500038		
	Part No.	365015	Ref. No. —
	operating capacitor capacity 10 μ F 400V tolerance 5%Hz ambient temperature max. -25 to +85°C \varnothing 35.5mm L 59mm M8 plastic connection male faston 6.3mm protection		
	Part No.	510508	Ref. No. —
	pump cover FIR inlet \varnothing 45mm outlet \varnothing 40mm pump type PU 0.5/3911 turn direction right \varnothing 160mm ID \varnothing 125mm inner height 25mm		
	Part No.	510610	Ref. No. —
	impellor \varnothing 95.5mm H 23mm shaft intake \varnothing 9/8mm rotation direction right seat \varnothing 16mm blades 6		
	Part No.	510692	Ref. No. —
	mechanical shaft seal for shaft \varnothing 11mm slide ring ext. \varnothing 24mm slide ring H 13mm counter ring mounting \varnothing 26mm height counter ring 8mm counter ring int. \varnothing 14mm		
	Part No.	521702	Ref. No. —
	pump cover gasket thickness 3.5x4.5mm Qty 1 pcs		
accessories for	500038		
	Part No.	551286	Ref. No. —
	adapter L 120mm 4-pole for Meiko pump suitable for 500038 plug type dependent on equipment		

fuses


fine fuses

fine fuse holders



1

Part No.	550537	Ref. No.	HE05800
description	fuse holder		
For models:	22, 23, 32, 33, 34		

	Part No.	358383	Ref. No.	HE05800
description	fuse holder suitable fuse \varnothing 5x20mm \varnothing 13.1mm 10A rated 250V connection soldering connection			




gas taps

PEL

21N series



1

















Part No.	101894	Ref. No.	GA11600
description	gas tap PEL type 21N gas inlet M16x1.5 (tube \varnothing 10mm) bypass nozzle \varnothing 0mm gas outlet M16x1.5 (tube \varnothing 10/8mm) thermocouple connection pilot connection closed shaft \varnothing 8x6.5mm shaft L 23/15mm shaft flat upper		
spare parts for	101894		
	Part No.	100551	Ref. No. —
	bypass nozzle type PEL20/21 bore \varnothing 0.6mm thread M5x0.5		
	Part No.	101205	Ref. No. —
	gas tap front part shaft \varnothing 8x6.5mm shaft L 22/15mm shaft flat upper/lower suitable for PEL20		
accessories for	101894		
	Part No.	101278	Ref. No. —
	olive for pipe \varnothing 10mm Qty 1 pcs		
	Part No.	101300	Ref. No. —
	union nut thread M16x1.5 tube \varnothing 10mm		
	Part No.	101450	Ref. No. —
	olive for pipe \varnothing 8mm L 12.7mm Qty 1 pcs ED \varnothing 10mm		
	Part No.	101451	Ref. No. —
	union nut thread M16x1.5 tube \varnothing 8mm		
	Part No.	110081	Ref. No. —
	knob \varnothing 70mm shaft \varnothing 8x6.5mm shaft flat universal		
	Part No.	110083	Ref. No. —
	knob dial plate gas tap without ignition flame silver		





22S/O series



1

Part No.	101086	Ref. No.	GA05300
description	gas tap PEL type 22S/O gas inlet M20x1.5 (tube \varnothing 12mm) bypass nozzle \varnothing 0.35mm gas outlet M20x1.5 (tube \varnothing 12/10mm) thermocouple connection M9x1 pilot connection M10x1 shaft \varnothing 10x8mm shaft L 25/17mm shaft flat lower		
For models:	SG22, SG23, SG33		
spare parts for	101086		
	Part No.	100259	Ref. No. —
	bypass nozzle type PEL22 bore \varnothing 0.35mm thread M6x0.5		
	Part No.	101058	Ref. No. —
	magnet unit L 39mm D1 \varnothing 15.4mm D2 \varnothing 13.5mm suitable for PEL22/EGA24197 standard		
	Part No.	101201	Ref. No. —
	gas tap front part shaft \varnothing 10x8mm shaft L 25/17mm shaft flat upper/lower suitable for PEL22		
	Part No.	101231	Ref. No. —
	thermocouple nut T1: M9x1 T2: M18x1		
	Part No.	101240	Ref. No. —
	gas connection thread M20x1.5 tube \varnothing 12/10mm for PEL gas taps with gasket and screws horizontal		
	Part No.	101460	Ref. No. —
	O-ring \varnothing 12.37mm D1 \varnothing 2.62mm suitable for PEL22		
	Part No.	101461	Ref. No. —
	screw kit suitable for PEL22 Qty 4 pcs		
accessories for	101086		
	Part No.	100908	Ref. No. —
	union screw thread M10x1 for pipe \varnothing 4mm Qty 1 pcs		
	Part No.	100909	Ref. No. —
	union screw thread M10x1 for pipe \varnothing 6mm Qty 1 pcs		
	Part No.	101241	Ref. No. —
	gas connection thread M20x1.5 tube \varnothing 12/10mm for PEL gas taps vertical		
	Part No.	101246	Ref. No. —
	olive for pipe \varnothing 4mm Qty 1 pcs		
	Part No.	101248	Ref. No. —
	olive for pipe \varnothing 12mm Qty 1 pcs suitable for PEL		
	Part No.	101249	Ref. No. —
	olive for pipe \varnothing 10mm Qty 1 pcs		
	Part No.	101250	Ref. No. —
	union nut thread M20x1.5 for pipe \varnothing 10mm		
	Part No.	101251	Ref. No. —
	union nut thread M20x1.5 for pipe \varnothing 12mm		
	Part No.	101286	Ref. No. —
	olive ID \varnothing 6mm Qty 1 pcs		

accessories for	101086		
	Part No.	110080	Ref. No. —
	knob \varnothing 70mm shaft \varnothing 10x8mm shaft flat universal		
	Part No.	112206	Ref. No. —
	knob dial plate silver gas tap PEL21/22/23 t.max.°C ED \varnothing 63mm ID \varnothing 45.5mm		



















Part No.	101510	Ref. No.	GA053
description	gas tap PEL type 22S/O gas inlet M20x1.5 (tube \varnothing 12mm) bypass nozzle \varnothing 0mm gas outlet M20x1.5 (tube \varnothing 12/10mm) thermocouple connection M9x1 pilot connection M10x1 shaft \varnothing 10x8mm shaft L 25/17mm shaft flat lower		
spare parts for	101510		
	Part No.	101058	Ref. No. —
	magnet unit L 39mm D1 \varnothing 15.4mm D2 \varnothing 13.5mm suitable for PEL22/EGA24197 standard		
	Part No.	101201	Ref. No. —
	gas tap front part shaft \varnothing 10x8mm shaft L 25/17mm shaft flat upper/lower suitable for PEL22		
	Part No.	101231	Ref. No. —
	thermocouple nut T1: M9x1 T2: M18x1		
	Part No.	101240	Ref. No. —
	gas connection thread M20x1.5 tube \varnothing 12/10mm for PEL gas taps with gasket and screws horizontal		
	Part No.	101460	Ref. No. —
	O-ring \varnothing 12.37mm D1 \varnothing 2.62mm suitable for PEL22		
	Part No.	101461	Ref. No. —
	screw kit suitable for PEL22 Qty 4 pcs		
accessories for	101510		
	Part No.	100908	Ref. No. —
	union screw thread M10x1 for pipe \varnothing 4mm Qty 1 pcs		
	Part No.	100909	Ref. No. —
	union screw thread M10x1 for pipe \varnothing 6mm Qty 1 pcs		
	Part No.	101241	Ref. No. —
	gas connection thread M20x1.5 tube \varnothing 12/10mm for PEL gas taps vertical		
	Part No.	101246	Ref. No. —
	olive for pipe \varnothing 4mm Qty 1 pcs		
	Part No.	101248	Ref. No. —
	olive for pipe \varnothing 12mm Qty 1 pcs suitable for PEL		
	Part No.	101249	Ref. No. —
	olive for pipe \varnothing 10mm Qty 1 pcs		
	Part No.	101250	Ref. No. —
	union nut thread M20x1.5 for pipe \varnothing 10mm		













Table continues overleaf



accessories for		101510		
Part No.		101251	Ref. No.	—
	union nut	thread M20x1.5 for pipe ø 12mm		
	olive	ID ø 6mm Qty 1 pcs		
	knob	ø 70mm shaft ø 10x8mm shaft flat universal		
	knob dial plate	silver gas tap PEL21/22/23 t.max.°C ED ø 63mm ID ø 45.5mm		

accessories for		106033		
Part No.		101257	Ref. No.	—
	olive	for pipe ø 20mm Qty 1 pcs		

23S/O series

	1			
Part No.	106033	Ref. No.	GA05800	
description	gas tap PEL type 23S/O gas inlet M28x1.5 (tube ø 20mm) bypass nozzle ø 0.35mm gas outlet M24x1.5 (tube ø 16/12mm) thermocouple connection M10x1 pilot connection M10x1 shaft ø 10x8mm shaft L 25/17mm shaft flat lower			
spare parts for	106033			
	Part No.	100455	Ref. No.	—
	bypass nozzle type PEL23/24 bore ø 0.35mm thread M8x0.5			
	Part No.	101059	Ref. No.	—
	magnet unit T1: M10x1 T2: M22x1 L 46mm ø 18mm suitable for PEL23S M10x1			
	Part No.	101204	Ref. No.	—
	gas tap front part shaft ø 10x8mm shaft L 25/17mm shaft flat upper/lower suitable for PEL23S			
	Part No.	101244	Ref. No.	—
	gas connection thread M24x1.5 tube ø 12/16mm horizontal for PEL gas taps			
	Part No.	101463	Ref. No.	—
	screw suitable for PEL23S Qty 4 pcs			
	Part No.	528455	Ref. No.	—
	O-ring Viton thickness 2.62mm ID ø 18.72mm Qty 1 pcs			
accessories for		106033		
	Part No.	101252	Ref. No.	—
	union nut thread M24x1.5 for pipe ø 12mm			
	Part No.	101253	Ref. No.	—
	union nut thread M24x1.5 PEL for pipe ø 16mm			
	Part No.	101254	Ref. No.	—
	union nut thread M28x1.5 tube ø 20mm			
	Part No.	101255	Ref. No.	—
	olive for pipe ø 12mm Qty 1 pcs			
	Part No.	101256	Ref. No.	—
	olive for pipe ø 16mm Qty 1 pcs			

gas valves and ignition boxes

gas solenoid valves

ASCO



1

Part No.	101378	Ref. No.	EB01800
description	solenoid valve 2-ways 230VAC connection 1/2" L 58mm Asco p max 0.14bar slide-on receptacle DIN gas		
For models:	SG22, SG23, SG33		

ignition parts

pilot burners

POLIDORO

pilot burners



1

Part No.	107577	Ref. No.	GA11100
description	pilot burner POLIDORO 2 flames code gas connection 6mm		

electrodes




1

Part No.	100750	Ref. No.	GA01400 GA01410
description	ignition electrode flange length 23mm flange width 15mm D1 ø 7mm L1 28mm L2 18mm L3 23mm L4 14mm BL1 21mm BL2 28mm fixing dimensions ø5x4mm with flange connection ø 4mm		
For models:	SG22, SG23		




			
1			
Part No.	102491	Ref. No.	GA29900
description	ignition electrode flange length 40mm flange width 19mm D1 ø 9.4mm L1 52mm BL1 50mm BL2 60mm connection male faston 2.8mm		

ignition units

			
1			
Part No.	101026	Ref. No.	EH02100
description	ignition unit outputs 4		
For models:	SG22, SG23, SG33		

ignition switches

			
1			
Part No.	101029	Ref. No.	EF04800+EF04900+5000
description	momentary push switch mounting ø 16mm white 1NO 250V 16A connection male faston 6.3mm protection IP40 ambient temperature max. 150°C		

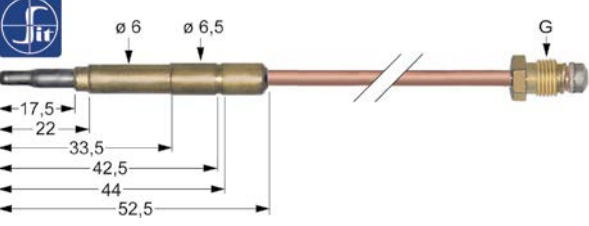
thermocouples

plug-in thermocouples

plug-in thermocouples standard

with barrel socket ø6(6.5)mm


thermocouples SIT


			
1			
Part No.	107612	Ref. No.	GA24100
description	thermocouple SIT M9x1 L 1000mm plug connection ø6.0(6.5)mm		


gas burners


bar burners

bar burners

			
1			
Part No.	105234	Ref. No.	GA00800
description	bar burner ø 25mm Wmm Hmm L 1047mm pizza oven		
For models:	SG33		

			
1			
Part No.	105116	Ref. No.	GA007 GA00700
description	bar burner ø 25mm Wmm Hmm L 740mm pizza oven		
For models:	SG22, SG23		

			
1			
Part No.	105199	Ref. No.	GA07200
description	bar burner ø 50mm Wmm Hmm L 520mm flange width 57mm flange length 57mm pizza oven		
For models:	SG22		

			
1			
Part No.	105201	Ref. No.	GA07100
description	bar burner ø 50mm Wmm Hmm L 800mm flange width 57mm flange length 57mm pizza oven		
For models:	SG23, SG33		



ceramic burners

accessories

burner grids



1

Part No.	101511	Ref. No.	KB61110
description	burner grid L 41mm W 16mm		
For models:	SG22, SG23, SG33		

sealing strips



1

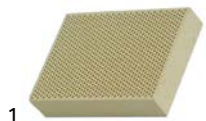
Part No.	101513	Ref. No.	AL13600 AL13610
description	sealing strip L 230/310mm W 20mm thickness 3mm fibre glass		
For models:	SG22		



1

Part No.	101512	Ref. No.	52.00066 AL13500 AL13510
description	sealing strip L 550mm W 20mm thickness 3mm fibre glass		
For models:	SG23, SG33		

ceramic plates



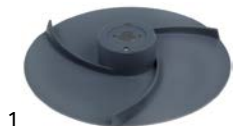
1

Part No.	101514	Ref. No.	GA02600
description	ceramic plate L 68mm W 48mm H 13mm		
For models:	SG22, SG23, SG33		

equipment-specific units

for vegetable slicers

ejector discs



1

Part No.	699110	Ref. No.	50SCA78300
description	ejector disc flat H 10mm ø 200mm seat ø 50mm shaft diameter 19mm hole distance 39mm		

for dough mixers

drive shafts



1

Part No.	692036	Ref. No.	AOEMKE100 KE10000 KE10020
description	drive shaft D1 ø 29mm for dough hook ø 20mm with flange L 140mm thread M10 D2 ø 100mm		
For models:	R201M/T		

spacer rings



1

Part No.	692028	Ref. No.	AE03100 AE03120
description	spacer bush ø 27mm ID ø 21mm H 7mm		



1

Part No.	692031	Ref. No.	AE14700 AE14720
description	spacer bush ø 30mm D1 ø 25mm ID ø 21mm H 10.6mm		



1

Part No.	697990	Ref. No.	AE75
description	spacer ring ø 35mm ID ø 31mm H 11mm zinc-coated steel		



1

Part No.	697991	Ref. No.	AE76
description	spacer ring ø 37mm ID ø 30.5mm H 20mm zinc-coated steel		



dough hooks

with mounting groove



1

Part No.	697312	Ref. No.	AH095 AH10
description	dough hook shaft ø 30mm usable height 435mm		

bearing blocks



1

Part No.	692038	Ref. No.	KE16510
description	bearing block		



1

Part No.	692032	Ref. No.	KE02600 KE02620
description	bearing block mounting pos. upper int. ø 1 42mm int. ø 2 47mm H 60mm		

for dough dividers

1

Part No.	690884	Ref. No.	AH23
description	divider funnel portions of 120-160g ø 135mm L 160mm mounting distance 180mm		



1

Part No.	690885	Ref. No.	AH24
description	divider funnel portions of 150-190g ø 135mm L 160mm mounting distance 180mm		



1

Part No.	690886	Ref. No.	AH25
description	divider funnel portions of 180-220g ø 135mm L 160mm mounting distance 180mm		

1

Part No.	690887	Ref. No.	AH26
description	divider funnel portions of 210-260g ø 135mm L 160mm mounting distance 180mm		



1

Part No.	690888	Ref. No.	AH44
description	divider funnel portions of 240-280g ø 135mm L 160mm mounting distance 180mm		

1			
Part No.	690881	Ref. No.	AH27
description	divider funnel portions of 50-70g		

1			
Part No.	690882	Ref. No.	AH21
description	divider funnel portions of 60-100g ø 135mm L 160mm mounting distance 180mm		

1			
Part No.	690883	Ref. No.	AH22
description	divider funnel portions of 90-130g ø 135mm L 160mm mounting distance 180mm		

for dough roller

rollers



1

Part No.	692014	Ref. No.	RC05200 KF073
description	roller for dough rolling machine L 300mm ø 49mm mounting pos. bottom at the back		



1

Part No.	692015	Ref. No.	KF072 RC048R0
description	roller for dough rolling machine L 306mm ø 49mm mounting pos. bottom in the front		

1			
Part No.	692016	Ref. No.	KF074 KF07400
description	roller for dough rolling machine mounting pos. upper at the back		

1			
Part No.	692017	Ref. No.	KF071 KF07100
description	roller for dough rolling machine mounting pos. upper in the front		



holders




1

Part No.	692002	Ref. No.	R3K10R0 RC058R0
description	lever hole \varnothing 10mm H 20mm hole distance 31mm		

couplings




1

Part No.	692012	Ref. No.	KF07600	
description	coupling \varnothing 35mm ID \varnothing 25mm H 14mm			
accessories for	692012			
	Part No.	692011	Ref. No.	KF07500
	coupling \varnothing 41.5mm ID \varnothing 25mm H 12mm			



1

Part No.	692011	Ref. No.	KF07500	
description	coupling \varnothing 41.5mm ID \varnothing 25mm H 12mm			
accessories for	692011			
	Part No.	692012	Ref. No.	KF07600
	coupling \varnothing 35mm ID \varnothing 25mm H 14mm			

pinions

rear mounting

1

Part No.	692009	Ref. No.	KF07820
description	pinion		



1

Part No.	692008	Ref. No.	KF07720
description	pinion \varnothing 47.5mm H 34mm mounting pos. rear ID \varnothing 25mm for dough roller		



1

Part No.	697109	Ref. No.	RC057R0
description	pinion \varnothing 47.5mm H 35mm mounting pos. rear ID \varnothing 25mm for dough roller		

front mounting



1

Part No.	697108	Ref. No.	RC056R0
description	pinion \varnothing 47.5mm H 35mm mounting pos. front ID \varnothing 14mm for dough roller		

springs



1

Part No.	693920	Ref. No.	MC114 RC055R0
description	spring for pinion \varnothing 49mm thickness 1.5mm Qty 2 pcs		

roller covers

upper



1

Part No.	697342	Ref. No.	RC418R0
description	hand protection mounting pos. upper P30		



side parts



Part No.	692024	Ref. No.	KD05020
description	side panel mounting pos. right W 39mm L 125mm H 100mm F/30		



Part No.	692025	Ref. No.	KF061
description	side panel mounting pos. left W 25mm L 122mm H 80mm F/30		

spindles



Part No.	692005	Ref. No.	KF062 KF06200
description	spindle ø 24mm L 160mm		

spindles

eccentric



Part No.	692019	Ref. No.	KF063
description	spindle ø 25mm L 380mm mounting pos. bottom in the front eccentric for dough rolling machine		

Part No.	692021	Ref. No.	KF064 KF06400
description	spindle ø 25mm mounting pos. upper in the front eccentric for dough rolling machine		

cylindric



Part No.	692018	Ref. No.	KF069 KF06900
description	spindle ø 25mm L 350mm mounting pos. bottom at the back cylindrical for dough rolling machine		

Part No.	692020	Ref. No.	KF068 KF06800
description	spindle ø 25mm mounting pos. upper at the back cylindrical for dough rolling machine		

miscellaneous

Part No.	692007	Ref. No.	AD174
description	lid		



Part No.	693921	Ref. No.	AD174
description	lid for side part ø 30.5mm H 11mm		
For models:	PF45MTE		

for display coolers

funnels

Part No.	690884	Ref. No.	AH23
description	divider funnel portions of 120-160g ø 135mm L 160mm mounting distance 180mm		



1

Part No.	690885	Ref. No.	AH24
description	divider funnel portions of 150-190g ø 135mm L 160mm mounting distance 180mm		



1

Part No.	690886	Ref. No.	AH25
description	divider funnel portions of 180-220g ø 135mm L 160mm mounting distance 180mm		

1

Part No.	690887	Ref. No.	AH26
description	divider funnel portions of 210-260g ø 135mm L 160mm mounting distance 180mm		



1

Part No.	690888	Ref. No.	AH44
description	divider funnel portions of 240-280g ø 135mm L 160mm mounting distance 180mm		

1

Part No.	690881	Ref. No.	AH27
description	divider funnel portions of 50-70g		

1

Part No.	690882	Ref. No.	AH21
description	divider funnel portions of 60-100g ø 135mm L 160mm mounting distance 180mm		

1

Part No.	690883	Ref. No.	AH22
description	divider funnel portions of 90-130g ø 135mm L 160mm mounting distance 180mm		



for convection ovens/combi-steamers

glass panels



1

Part No.	700162	Ref. No.	AL01100 AL27600
description	glass panel L 410mm W 131mm thickness 4mm rectangular		
For models:	R-109-1, R-109-2, R-109-3, R-111-1, R-111-2, R-111-3, R-66-1, R-66-2, R-66-3, R-69-1, R-69-2, R-69-3, R-77-1, R-77-2, R-77-3, R-96-1, R-96-2, R-96-3, R-99-1, R-99-2, R-99-3, RE-109-1, RE-109-2, RE-109-3, RE-111-1, RE-111-2, RE-111-3, RE-66-1, RE-66-2, RE-66-3, RE-69-1, RE-69-2, RE-69-3, RE-77-1, RE-77-2, RE-77-3, RE-96-1, RE-96-2, RE-96-3, RE-99-1, RE-99-2, RE-99-3, S-109-1, S-109-2, S-109-3, S-111-1, S-111-2, S-111-3, S-66-1, S-66-2...(Other models you can see in the webshop)		

doors



1

Part No.	694291	Ref. No.	E4M2000
description	stop bolt ø 11.5mm L 25mm thread M8 WS 15		

door mechanics

bolts



1

Part No.	694291	Ref. No.	E4M2000
description	stop bolt ø 11.5mm L 25mm thread M8 WS 15		

for tilting bratt pans

miscellaneous

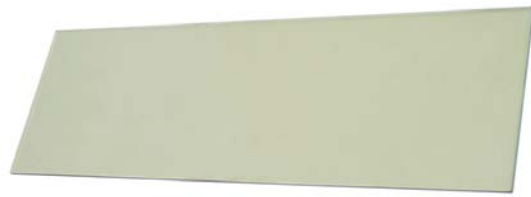


1

Part No.	523510	Ref. No.	50IBA71269
description	deep-groove ball bearing type 6202-2RS shaft ø 15mm ED ø 35mm W 11mm with sealing discs deep-groove ball bearing DIN 625-1		

for pizza ovens

glass panels



1

Part No.	700162	Ref. No.	AL01100 AL27600
description	glass panel L 410mm W 131mm thickness 4mm rectangular		
For models:	R-109-1, R-109-2, R-109-3, R-111-1, R-111-2, R-111-3, R-66-1, R-66-2, R-66-3, R-69-1, R-69-2, R-69-3, R-77-1, R-77-2, R-77-3, R-96-1, R-96-2, R-96-3, R-99-1, R-99-2, R-99-3, RE-109-1, RE-109-2, RE-109-3, RE-111-1, RE-111-2, RE-111-3, RE-66-1, RE-66-2, RE-66-3, RE-69-1, RE-69-2, RE-69-3, RE-77-1, RE-77-2, RE-77-3, RE-96-1, RE-96-2, RE-96-3, RE-99-1, RE-99-2, RE-99-3, S-109-1, S-109-2, S-109-3, S-111-1, S-111-2, S-111-3, S-66-1, S-66-2...(Other models you can see in the webshop)		

1

Part No.	700163	Ref. No.	AL01100
description	glass panel L 410mm W 133mm thickness 5mm rectangular		
For models:	109, 111, 22, 23, 32, 33 220V, 33 380V, 34 220V, 34 380V, 66, 69, 77, 96, 99, SG22, SG23, SG33		

firebricks




1


Part No.	850007	Ref. No.	AL15500
description	firebrick L 495mm W 315mm H 14mm delivery freight forwarding company only		

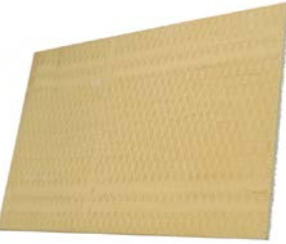
1


Part No.	850008	Ref. No.	AL14400
description	firebrick L 515mm W 495mm H 19mm delivery freight forwarding company only		




			
1			
Part No.	850009	Ref. No.	AL15100
description	firebrick L 622mm W 606mm H 25mm delivery freight forwarding company only		
For models:	22, 66, R-109-1, R-109-2, R-109-3, R-111-1, R-111-2, R-111-3, R-66-1, R-66-2, R-66-3, R-69-1, R-69-2, R-69-3, R-77-1, R-77-2, R-77-3, R-96-1, R-96-2, R-96-3, R-99-1, R-99-2, R-99-3, RE-109-1, RE-109-2, RE-109-3, RE-111-1, RE-111-2, RE-111-3, RE-66-1, RE-66-2, RE-66-3, RE-69-1, RE-69-2, RE-69-3, RE-77-1, RE-77-2, RE-77-3, RE-96-1, RE-96-2, RE-96-3, RE-99-1, RE-99-2, RE-99-3, S-109-1, S-109-2, S-109-3, S-111-1, S-111-2, S-111-3...(Other models you can see in the webshop)		


			
1			
Part No.	850013	Ref. No.	AL17900
description	firebrick L 913mm W 455mm H 19mm delivery freight forwarding company only		
For models:	33 220V, 33 380V, 99, R-109-1, R-109-2, R-109-3, R-111-1, R-111-2, R-111-3, R-66-1, R-66-2, R-66-3, R-69-1, R-69-2, R-69-3, R-77-1, R-77-2, R-77-3, R-96-1, R-96-2, R-96-3, R-99-1, R-99-2, R-99-3, RE-109-1, RE-109-2, RE-109-3, RE-111-1, RE-111-2, RE-111-3, RE-66-1, RE-66-2, RE-66-3, RE-69-1, RE-69-2, RE-69-3, RE-77-1, RE-77-2, RE-77-3, RE-96-1, RE-96-2, RE-96-3, RE-99-1, RE-99-2, RE-99-3, S-109-1, S-109-2, S-109-3, S-111-1, S-111-2...(Other models you can see in the webshop)		


			
1			
Part No.	850012	Ref. No.	AL18200
description	firebrick L 913mm W 606mm H 19mm delivery freight forwarding company only		
For models:	23, 32, 69, 96, R-109-1, R-109-2, R-109-3, R-111-1, R-111-2, R-111-3, R-66-1, R-66-2, R-66-3, R-69-1, R-69-2, R-69-3, R-77-1, R-77-2, R-77-3, R-96-1, R-96-2, R-96-3, R-99-1, R-99-2, R-99-3, RE-109-1, RE-109-2, RE-109-3, RE-111-1, RE-111-2, RE-111-3, RE-66-1, RE-66-2, RE-66-3, RE-69-1, RE-69-2, RE-69-3, RE-77-1, RE-77-2, RE-77-3, RE-96-1, RE-96-2, RE-96-3, RE-99-1, RE-99-2, RE-99-3, S-109-1, S-109-2, S-109-3, S-111-1...(Other models you can see in the webshop)		

			
1			
Part No.	850006	Ref. No.	AL14500
description	firebrick L 913mm W 606mm H 25mm delivery freight forwarding company only		

miscellaneous

			
1			
Part No.	698558	Ref. No.	E1K0300
description	bush L 20.5mm ø 16mm ID ø 10mm		

			
1			
Part No.	698560	Ref. No.	E1K0200
description	hinge L 40mm W 50mm H 73mm mounting pos. left		

			
1			
Part No.	698559	Ref. No.	E1K01 E1K0100
description	hinge L 40mm W 50mm H 73mm mounting pos. right		



for dishwashers

door mechanics

locks



1

Part No.	506157	Ref. No.	AC046
description	door catch catch		

washing and rinsing systems

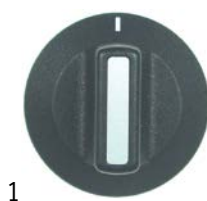


1

Part No.	510194	Ref. No.	DB031R0
description	swirl		

knobs

universal knobs



1

Part No.	111985	Ref. No.	AC00600
description	knob switch zero mark t.max.°C ø 42mm shaft ø 6x4.6mm shaft flat lower black		



1

Part No.	110932	Ref. No.	AC06200
description	knob switch zero mark t.max.°C ø 42mm shaft ø 6x4.6mm shaft flat upper black		
For models:	109, 111, 22, 23, 32, 33 380V, 34 380V, 66, 69, 77, 96, 99, PF33MT, PF45HT, R-109-1, R-109-2, R-109-3, R-111-1, R-111-2, R-111-3, R-66-1, R-66-2, R-66-3, R-69-1, R-69-2, R-69-3, R-77-1, R-77-2, R-77-3, R-96-1, R-96-2, R-96-3, R-99-1, R-99-2, R-99-3, S-109-1, S-109-2, S-109-3, S-111-1, S-111-2, S-111-3, S-66-1, S-66-2, S-66-3, S-69-1, S-69-2, S-69-3, S-77-1, S-77-2, S-77-3...(Other models you can see in the webshop)		

producer-specific knobs

OEM



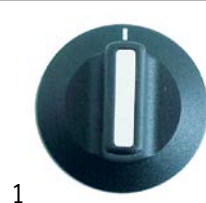
1

Part No.	110162	Ref. No.	AC05100
description	knob potentiometer ø 18.5mm shaft ø 6mm black		
For models:	22, 23, 32, 33, 34, PF33MT, PF45HT		



1

Part No.	111985	Ref. No.	AC00600
description	knob switch zero mark t.max.°C ø 42mm shaft ø 6x4.6mm shaft flat lower black		



1

Part No.	110932	Ref. No.	AC06200
description	knob switch zero mark t.max.°C ø 42mm shaft ø 6x4.6mm shaft flat upper black		
For models:	109, 111, 22, 23, 32, 33 380V, 34 380V, 66, 69, 77, 96, 99, PF33MT, PF45HT, R-109-1, R-109-2, R-109-3, R-111-1, R-111-2, R-111-3, R-66-1, R-66-2, R-66-3, R-69-1, R-69-2, R-69-3, R-77-1, R-77-2, R-77-3, R-96-1, R-96-2, R-96-3, R-99-1, R-99-2, R-99-3, S-109-1, S-109-2, S-109-3, S-111-1, S-111-2, S-111-3, S-66-1, S-66-2, S-66-3, S-69-1, S-69-2, S-69-3, S-77-1, S-77-2, S-77-3...(Other models you can see in the webshop)		

miscellaneous



1

Part No.	110205	Ref. No.	AC04000
description	knob ø 27mm shaft ø 5x5mm		
For models:	PF45HT		



handles and hand wheels

cylindrical handles

fixed



1

Part No.	690158	Ref. No.	AC06600
description	cylindrical handle thread M8 ø 29mm L 112mm		
For models:	22, 23, 32, 33 220V, 33 380V, 34 220V, 34 380V, R-109-1, R-109-2, R-109-3, R-111-1, R-111-2, R-111-3, R-66-1, R-66-2, R-66-3, R-69-1, R-69-2, R-69-3, R-77-1, R-77-2, R-77-3, R-96-1, R-96-2, R-96-3, R-99-1, R-99-2, R-99-3, RE-109-1, RE-109-2, RE-109-3, RE-111-1, RE-111-2, RE-111-3, RE-66-1, RE-66-2, RE-66-3, RE-69-1, RE-69-2, RE-69-3, RE-77-1, RE-77-2, RE-77-3, RE-96-1, RE-96-2, RE-96-3, RE-99-1, RE-99-2, RE-99-3, S-109-1...(Other models you can see in the webshop)		

handle bars

consoles



1

Part No.	690116	Ref. No.	HDTV0300
description	console for handle rod		

door handles

door handles



1

Part No.	690112	Ref. No.	H9N6020
description	handle		



1

Part No.	691257	Ref. No.	HDM0010
description	handle		

miscellaneous



1

Part No.	690055	Ref. No.	H9N5020
description	handle holder mounting pos. right		

accessories

miscellaneous



1

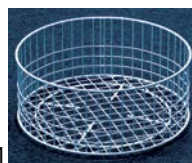
Part No.	690149	Ref. No.	AC07100
description	hand protection for door handle		
For models:	22, 23, 32, 33 220V, 33 380V, 34 220V, 34 380V, R-109-1, R-109-2, R-109-3, R-111-1, R-111-2, R-111-3, R-66-1, R-66-2, R-66-3, R-69-1, R-69-2, R-69-3, R-77-1, R-77-2, R-77-3, R-96-1, R-96-2, R-96-3, R-99-1, R-99-2, R-99-3, RE-109-1, RE-109-2, RE-109-3, RE-111-1, RE-111-2, RE-111-3, RE-66-1, RE-66-2, RE-66-3, RE-69-1, RE-69-2, RE-69-3, RE-77-1, RE-77-2, RE-77-3, RE-96-1, RE-96-2, RE-96-3, RE-99-1, RE-99-2, RE-99-3, S-109-1...(Other models you can see in the webshop)		

baskets

warewashing baskets

steel wire baskets round

mix baskets



1

Part No.	970579	Ref. No.	AB013
description	mix basket ED ø 360mm H 140mm seat ø 280mm		



gaskets

sealing washers

rubber gaskets



1

Part No.	521125	Ref. No.	AD036
description	flat gasket rubber ED ø 52mm ID ø 42.5mm thickness 4mm Qty 1 pcs		

shaft gaskets

shaft gaskets



1

Part No.	516246	Ref. No.	50IAA71178
description	shaft seal ID ø 17mm ED ø 35mm thickness 7mm		

special gaskets

miscellaneous



1

Part No.	693441	Ref. No.	AL27810
description	gasket L 430mm W 155mm glass fibre		
For models:	R-109-1, R-109-2, R-109-3, R-111-1, R-111-2, R-111-3, R-66-1, R-66-2, R-66-3, R-69-1, R-69-2, R-69-3, R-77-1, R-77-2, R-77-3, R-96-1, R-96-2, R-96-3, R-99-1, R-99-2, R-99-3, RE-109-1, RE-109-2, RE-109-3, RE-111-1, RE-111-2, RE-111-3, RE-66-1, RE-66-2, RE-66-3, RE-69-1, RE-69-2, RE-69-3, RE-77-1, RE-77-2, RE-77-3, RE-96-1, RE-96-2, RE-96-3, RE-99-1, RE-99-2, RE-99-3, S-109-1, S-109-2, S-109-3, S-111-1, S-111-2, S-111-3, S-66-1, S-66-2...(Other models you can see in the webshop)		

transmission technology and ball bearings

ball bearings

deep-groove ball bearings 2RS



1

Part No.	523522	Ref. No.	AB047 AB04700
description	deep-groove ball bearing type 6004-2RS shaft ø 20mm ED ø 42mm W 12mm with sealing discs deep-groove ball bearing DIN 625-1		
For models:	PF45MT-E		



1

Part No.	523510	Ref. No.	50IBA71269
description	deep-groove ball bearing type 6202-2RS shaft ø 15mm ED ø 35mm W 11mm with sealing discs deep-groove ball bearing DIN 625-1		



1

Part No.	523512	Ref. No.	AB04800
description	deep-groove ball bearing type 6204-2RS shaft ø 20mm ED ø 47mm W 14mm with sealing discs deep-groove ball bearing DIN 625-1		
For models:	PF45MTE, PF45MT-E		

deep-groove ball bearings 2Z



1

Part No.	523508	Ref. No.	AB119 AB11900
description	deep-groove ball bearing shaft ø 10mm ED ø 30mm W 9mm type 6200-2Z DIN 625-1		



1

Part No.	692000	Ref. No.	50IBA71268 AB117 AB11700
description	deep-groove ball bearing shaft \varnothing 15mm ED \varnothing 35mm W 11mm type 6202-2Z DIN 625-1		



1

Part No.	692033	Ref. No.	AB10900 AB11400
description	deep-groove ball bearing shaft \varnothing 25mm ED \varnothing 47mm W 12mm type 6005-2Z DIN 625-1		

thrust ball bearings



1

Part No.	523536	Ref. No.	50IBA71241 50IBA78008
description	thrust ball bearing shaft \varnothing 20mm ED \varnothing 40mm W 14mm type 51204 DIN 711		

drive belts

high-performance V-belts, cogged



1

Part No.	691963	Ref. No.	AD184 AD18400
description	V-belt belt width 13mm L 1050mm H 8mm CODE AX40 profile AX/X13		
For models:	PF45MT-E		



1

Part No.	697781	Ref. No.	AD088 AD08800
description	V-belt belt width 13mm L 890mm H 8mm CODE AX35 profile AX/X13		

toothed belts



1


Part No.	697786	Ref. No.	AD11800
description	toothed belt profile H L 762mm Hmm teeth 60 splitting rubber with textile insertion CODE H300 W 25mm		

chains

roller chains 08B-2 double



1

Part No.	698398	Ref. No.	KE03410
description	chain DIN/ISO 08 B-2 splitting 1/2" / 12.7mm links 48 internal width 7.75mm roller \varnothing 8.51mm double		
accessories for	698398		
	Part No.	698399	Ref. No. KE041 KE04100
	connector double DIN/ISO 08 B-2 splitting 1/2" links 1		

connectors



1

Part No.	698399	Ref. No.	KE041 KE04100
description	connector double DIN/ISO 08 B-2 splitting 1/2" links 1		

springs


torsion springs





1

Part No.	698557	Ref. No.	MD10700
description	spring \varnothing 19.2mm L2 33.3mm wire gauge \varnothing 3mm L1 48mm		



			
1			
Part No.	692094	Ref. No.	MD04900
description	torsion spring ø 17mm L2 32mm wire gauge ø 2.5mm L1 45mm L3mm Qty 1 pcs		
For models:	R-109-1, R-109-2, R-109-3, R-111-1, R-111-2, R-111-3, R-66-1, R-66-2, R-66-3, R-69-1, R-69-2, R-69-3, R-77-1, R-77-2, R-77-3, R-96-1, R-96-2, R-96-3, R-99-1, R-99-2, R-99-3, RE-109-1, RE-109-2, RE-109-3, RE-111-1, RE-111-2, RE-111-3, RE-66-1, RE-66-2, RE-66-3, RE-69-1, RE-69-2, RE-69-3, RE-77-1, RE-77-2, RE-77-3, RE-96-1, RE-96-2, RE-96-3, RE-99-1, RE-99-2, RE-99-3, S-109-1, S-109-2, S-109-3, S-111-1, S-111-2, S-111-3, S-66-1, S-66-2...(Other models you can see in the webshop)		

			
1			
Part No.	700872	Ref. No.	KD019 KD01900
description	torsion spring ø 31mm mounting pos. left		
For models:	PF45MT-E		


			
1			
Part No.	700871	Ref. No.	KD018 KD01800
description	torsion spring ø 31mm mounting pos. right		
For models:	PF45MT-E		

measuring equipment

thermometers

built-in thermometers


ø60mm

			
1			
Part No.	541879	Ref. No.	ED07500
description	thermometer mounting ø 60mm 0 up to +500°C probe ø 8mm probe L 155mm capillary pipe 1000mm		

fastening material


screws

countersunk screws

			
1			
Part No.	692037	Ref. No.	MB15700 MB22000
description	countersunk screw thread M10 L 20mm WS 6 SS DIN 7991/ISO 10642 Qty 1 pcs intake hexagonal		


nuts

knurled nuts

			
1			
Part No.	691258	Ref. No.	HST0320
description	knurled nut thread M6 ø 19mm H 15mm chrome-plated steel		

hexagonal nuts


DIN 934 / ISO 4032/8673

			
1			
Part No.	505200	Ref. No.	50BBA76593
description	nut thread M12x1.75 H 10mm WS 19 SS DIN/ISO DIN 934 / ISO 4032/8673 Qty 1 pcs		

washers


washers

miscellaneous


			
1			
Part No.	692034	Ref. No.	AE14200
description	disc		


fasteners

slot nuts

			
1			
Part No.	692006	Ref. No.	MD048 MD04800
description	slot nut W 5mm H 5mm L 20mm		




1			
Part No.	692035	Ref. No.	MD06100
description	slot nut W 6mm H 6mm L 25mm		


1			
Part No.	560285	Ref. No.	MD41
description	slot nut W 8mm H 7mm L 30mm		


retaining rings


DIN 471

1			
Part No.	691403	Ref. No.	MC033
description	retaining ring shaft \varnothing 19mm thickness 1.2mm stainless steel DIN 471		

DIN 472

1			
Part No.	698003	Ref. No.	50BHA76670
description	retaining ring bore \varnothing 35mm thickness 1.5mm steel DIN 472		

1			
Part No.	692029	Ref. No.	MC03500
description	retaining ring bore \varnothing 47mm thickness 1.8mm steel DIN 472		
For models:	PF45MTE, PF45MT-E		

1			
Part No.	523103	Ref. No.	MC043 MC04300
description	retaining ring bore \varnothing 52mm thickness 2mm steel DIN 472		

miscellaneous

1			
Part No.	692003	Ref. No.	MC062 MC06200
description	retaining ring		
For models:	PF33MT		

1			
Part No.	692004	Ref. No.	MC115 MC11500
description	retaining ring		

roll pins


1			
Part No.	692013	Ref. No.	MD09700
description	roll pin \varnothing 3mm L 16mm		

consumables

fuses

fine fuses

fine fuse holders

1			
Part No.	550537	Ref. No.	HE05800
description	fuse holder		
For models:	22, 23, 32, 33, 34		

GASTROPARTS.COM

