



**GASTROPARTS**

# Obel

- [EN]** Equipment
- [DE]** Geräte
- [ES]** Aparatos
- [FR]** Équipement
- [IT]** Attrezzature
- [PL]** Urządzenia
- [RU]** Оборудование

✉ [gastroparts@gastroparts.com](mailto:gastroparts@gastroparts.com)

☎ +48 56 657 00 66

📘 [fb.com/gastroparts.global](https://fb.com/gastroparts.global)

**GASTROPARTS.COM**





## switches and momentary switches

### rocker/momentary rocker switches

30x22mm



1

<b>Part No.</b>	301002	<b>Ref. No.</b>	EB079 EB079T MQ79
-----------------	--------	-----------------	-------------------------

**description** rocker switch mounting measurements 30x22mm orange 2NO 250V 16A illuminated 0-I connection male faston 6.3mm ambient temperature max. 85/125°C protection IP65

**accessories for** 301002



<b>Part No.</b>	301036	<b>Ref. No.</b>	—
-----------------	--------	-----------------	---

protective cover internal size 30x22mm for rocker switch mounting measurementsmm



1

<b>Part No.</b>	301001	<b>Ref. No.</b>	EB079
-----------------	--------	-----------------	-------

**description** rocker switch mounting measurements 30x22mm red 2NO 250V 16A illuminated 0-I connection male faston 6.3mm ambient temperature max. 125/55°C protection IP65

**accessories for** 301001



<b>Part No.</b>	301036	<b>Ref. No.</b>	—
-----------------	--------	-----------------	---

protective cover internal size 30x22mm for rocker switch mounting measurementsmm

### push/momentary push switches

ø15.2mm



1

<b>Part No.</b>	346154	<b>Ref. No.</b>	EB076M
-----------------	--------	-----------------	--------

**description** momentary push switch mounting ø 15.2mm black 1NO 250V 0.7A connection screw ambient temperature max. 85°C protection IP40



1

<b>Part No.</b>	346155	<b>Ref. No.</b>	EB076A EB077A
-----------------	--------	-----------------	------------------

**description** momentary push switch mounting ø 15.2mm red 1NC 250V 0.7A connection screw ambient temperature max. 85°C protection IP40

## microswitches

### lever actuated



1

<b>Part No.</b>	347270	<b>Ref. No.</b>	EB066MC EB068
-----------------	--------	-----------------	------------------

**description** microswitch with lever 250V 16A 1CO connection male faston 6.3mm L 22mm ambient temperature max. 120°C lever length 14.2mm

### pin-plunger actuated



1

<b>Part No.</b>	346156	<b>Ref. No.</b>	EB066 EB066A EB066AC
-----------------	--------	-----------------	----------------------------

**description** microswitch 250V 16A 1CO connection male faston 6.3mm ambient temperature max. 125°C mounting distance 22mm with plunger black

## relays

### power relays

#### with male contacts

#### female contact 4.8mm



1

<b>Part No.</b>	380907	<b>Ref. No.</b>	EB073 MQ74ATT
-----------------	--------	-----------------	------------------

**description** power relays 230VAC 10A 3CO raster size 10mm plug-in connection 250V connection 4.8mm

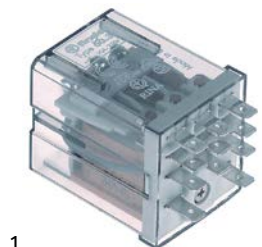

1

<b>Part No.</b>	380355	<b>Ref. No.</b>	EB073 EB074T
-----------------	--------	-----------------	-----------------

**description** power relays 400VAC 10A 3CO raster size 10mm plug-in connection 250V connection 4.8mm



## electronics

## PCBs



1

<b>Part No.</b>	400568	<b>Ref. No.</b>	J693/220
<b>description</b>	PCB		

## motors

## motors

## for coffee grinders

## complete



1

<b>Part No.</b>	500240	<b>Ref. No.</b>	DF15
<b>description</b>	motor 300W 230V 50/60Hz 1 phase shaft length 47mm thread M8L 1400rpm type 102.000C ø 125mm H 200mm 0.3kW		



1

<b>Part No.</b>	500241	<b>Ref. No.</b>	DF15
<b>description</b>	motor 90W 230V 50Hz 1 phase shaft ø 10mm shaft length 38mm thread M8L 1340rpm type C002801 ø 95mm H 160mm capacitor 5/6µF RPM 0.09kW		

## components



1

<b>Part No.</b>	500239	<b>Ref. No.</b>	EB73
<b>description</b>	motor 230V 50Hz 1 phase ø 100mm ID ø 65mm H 195mm shaft ø 16mm type T48		

## condensators &amp; interference suppression filters

## operating capacitors

## plastic



1

<b>Part No.</b>	365014	<b>Ref. No.</b>	EB075
<b>description</b>	operating capacitor capacity 12.5µF 450V tolerance 5%Hz ambient temperature max. -25 to +85°C ø 35mm L 70mm M8 plastic connection male faston 6.3mm 45S.C3DS.12.5 protection		



1

<b>Part No.</b>	365223	<b>Ref. No.</b>	EB075MG MQ75
<b>description</b>	operating capacitor capacity 16µF 400V tolerance 5% 50/60Hz ambient temperature max. °C ø 35mm L 70mm plastic connection F6.3 protection		



1

<b>Part No.</b>	365126	<b>Ref. No.</b>	EB075MG (old version) MQ75 (old version)
<b>description</b>	operating capacitor capacity 16µF 400V tolerance 5% 50/60Hz ambient temperature max. °C ø 35mm L 70mm plastic protection		



1

<b>Part No.</b>	365093	<b>Ref. No.</b>	DF75
<b>description</b>	operating capacitor capacity 6µF 400V tolerance 5% 50/60Hz ambient temperature max. -25 to +85°C ø 31.5mm L 55mm M8 plastic connection male faston 6.3mm protection		



## equipment-specific units

### for coffee grinders

#### grinding burrs

#### grinding burrs straight

#### standard



1

<b>Part No.</b>	526216	<b>Ref. No.</b>	DF8
<b>description</b>	grinding burrs pair turn direction left D1 ø 50mm ID ø 30mm H 7.5mm tooth spacing 3mm hole ø 4.6mm bore ø 7.6mm mounting ø 38		



1

<b>Part No.</b>	527229	<b>Ref. No.</b>	DF8
<b>description</b>	grinding burrs pair turn direction left D1 ø 50mm ID ø 31mm H 8mm tooth spacing 3mm hole ø 4.5mm bore ø 7.5mm mounting ø 40 suitable for RANCILIO, OBEL		



1

<b>Part No.</b>	527233	<b>Ref. No.</b>	EB08
<b>description</b>	grinding burrs pair turn direction left D1 ø 63.5mm ID ø 37.5mm H 9mm tooth spacing 3mm hole ø 5.5mm bore ø 8.5mm mounting ø 50 straight suitable for OBEL, CARIMALI, BEZZERA, PAVONI		

#### grinding burrs holders



1

<b>Part No.</b>	527264	<b>Ref. No.</b>	EB090
<b>description</b>	grinding burr holder type EB suitable for Obel equiv. no. EB090		



1

<b>Part No.</b>	527265	<b>Ref. No.</b>	DF90
<b>description</b>	grinding burr holder type JUNIOR suitable for Obel equiv. no. DF90		

#### spillage trays



1

<b>Part No.</b>	526354	<b>Ref. No.</b>	EB022
<b>description</b>	drain tray L 181mm W 154mm		

#### miscellaneous



1

<b>Part No.</b>	526355	<b>Ref. No.</b>	DF85M
<b>description</b>	cover ø 98mm for setting ring		

#### dosing containers

#### dosing containers (complete)



1

<b>Part No.</b>	527538	<b>Ref. No.</b>	DF71CC
<b>description</b>	dosing pump complete with lid		

**spare parts for** 527538



<b>Part No.</b>	527341	<b>Ref. No.</b>	DF44
<b>description</b>	glass cylinder for dosing pump ø 109mm H 88mm plexiglas		



## dosing container lids

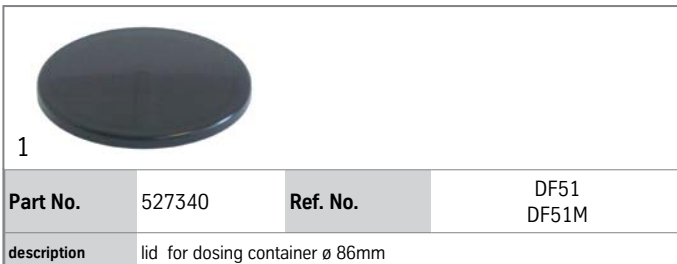

## adjusting screws

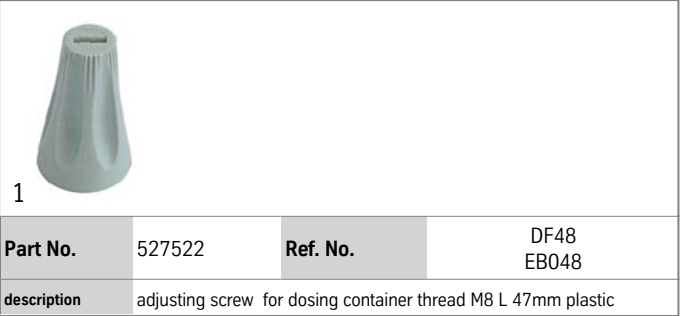

## springs

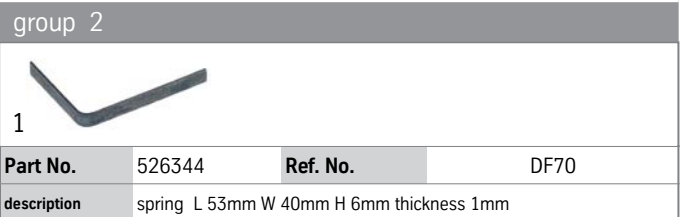

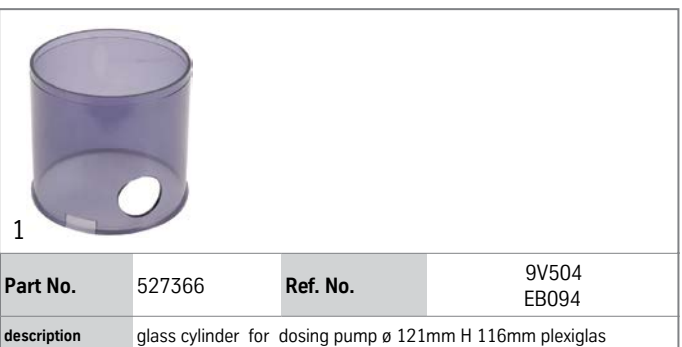
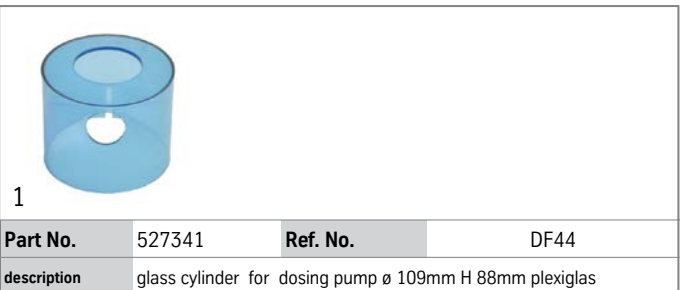
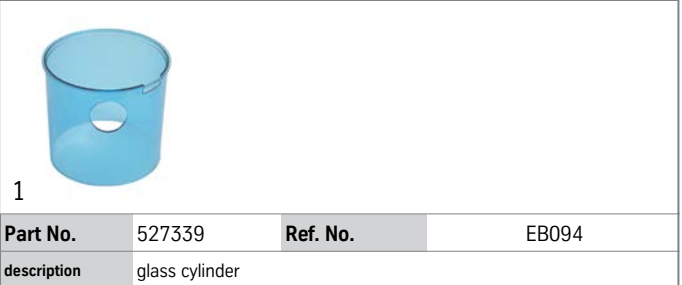

## glass cylinders







levers			
handles			
			
1			
<b>Part No.</b>	526362	<b>Ref. No.</b>	DF28
<b>description</b>	handle for lever L 37mm W 10mm H 17mm rubber		

			
1			
<b>Part No.</b>	526363	<b>Ref. No.</b>	EB029A
<b>description</b>	handle for lever L 50mm W 10mm H 17mm rubber		

levers			
			
1			
<b>Part No.</b>	526356	<b>Ref. No.</b>	EB029P
<b>description</b>	lever left hole ø 17mm plastic		

			
1			
<b>Part No.</b>	526357	<b>Ref. No.</b>	DF29
<b>description</b>	lever right for dosing container hole ø 17mm brass		

coffee presses			
components			
bolts			
			
1			
<b>Part No.</b>	526353	<b>Ref. No.</b>	EB045
<b>description</b>	bolt D1 ø 8mm D2 ø 12mm L 128mm T1: M8x1.25 T2: M8x1.25		

holders			
			
1			
<b>Part No.</b>	526358	<b>Ref. No.</b>	EB039P
<b>description</b>	bracket for coffee press H 74mm L 40mm plastic		

pressers			
			
1			
<b>Part No.</b>	527534	<b>Ref. No.</b>	E72 EB037
<b>description</b>	coffee press ø 56mm H 15.5mm thread M8		

buttons			
			
1			
<b>Part No.</b>	111308	<b>Ref. No.</b>	EB047
<b>description</b>	mushroom cap handle thread M8x1.25 handle ø 41mm L 25mm plastic black		

coffee presses			
			
1			
<b>Part No.</b>	527565	<b>Ref. No.</b>	N/A
<b>description</b>	coffee press		

			
1			
<b>Part No.</b>	526346	<b>Ref. No.</b>	EB041
<b>description</b>	compression spring ø 10.7mm L 89mm wire gauge ø 0.8mm for coffee press		

automatic grinding			
automatic grinding			
			
1			
<b>Part No.</b>	527338	<b>Ref. No.</b>	EB086
<b>description</b>	ring for dosing container ø 118mm H 19mm plastic		

sector plates			
			
1			
<b>Part No.</b>	527525	<b>Ref. No.</b>	EB060
<b>description</b>	sector plates		



			
1			
<b>Part No.</b>	527531	<b>Ref. No.</b>	DF60
<b>description</b>	sector plates		

## ratches

## ratches

			
1			
<b>Part No.</b>	526360	<b>Ref. No.</b>	EB092
<b>description</b>	ratchet for dosing unit $\varnothing$ 29.7mm inner cone int. $\varnothing$ 1 11.5mm int. $\varnothing$ 2 15mm H 12mm brass		

			
1			
<b>Part No.</b>	526361	<b>Ref. No.</b>	DF92
<b>description</b>	ratchet for dosing unit $\varnothing$ 29.7mm inner cone int. $\varnothing$ 1 12mm int. $\varnothing$ 2 15mm brass		

## pins

			
1			
<b>Part No.</b>	526350	<b>Ref. No.</b>	EB056
<b>description</b>	pin for ratchet $\varnothing$ 4mm D2 $\varnothing$ 2.5mm L 20mm		

## stars

## central

			
1			
<b>Part No.</b>	527532	<b>Ref. No.</b>	DF59
<b>description</b>	star mounting pos. centre $\varnothing$ 103mm hole $\varnothing$ 8.2mm H 35mm		

			
1			
<b>Part No.</b>	527526	<b>Ref. No.</b>	EB059
<b>description</b>	star mounting pos. centre $\varnothing$ 115mm		



## upper

			
1			
<b>Part No.</b>	527530	<b>Ref. No.</b>	DF42
<b>description</b>	star mounting pos. upper		

			
1			
<b>Part No.</b>	527523	<b>Ref. No.</b>	EB042
<b>description</b>	star mounting pos. upper $\varnothing$ 112mm hole $\varnothing$ 22mm		

## bottom

			
1			
<b>Part No.</b>	527533	<b>Ref. No.</b>	DF062 DF62
<b>description</b>	star mounting pos. lower $\varnothing$ 103mm shaft $\varnothing$ 8 shaft length 100mm thread M8		

				
1				
<b>Part No.</b>	527528	<b>Ref. No.</b>	EB062	
<b>description</b>	star mounting pos. lower $\varnothing$ 115mm shaft $\varnothing$ 8 shaft length 111mm thread M8			
<b>accessories for</b>	527528			
	<b>Part No.</b>	111273	<b>Ref. No.</b>	DS43 EB043
	cotter pin $\varnothing$ 1.3mm L 25mm			

## accessories

			
1			
<b>Part No.</b>	527524	<b>Ref. No.</b>	EB050
<b>description</b>	brush L 80mm plastic		



adjustment mechanism

lockable adjustment



1

<b>Part No.</b>	526343	<b>Ref. No.</b>	DF6
<b>description</b>	pressure pin for setting ring L 36mm W 18mm shaft ø 5mm shaft length 30mm		



1

<b>Part No.</b>	526336	<b>Ref. No.</b>	EB06
<b>description</b>	pressure pin for setting ring L 36mm W 20mm shaft ø 5mm shaft length 30mm		

setting rings



1

<b>Part No.</b>	527413	<b>Ref. No.</b>	EB053
<b>description</b>	setting ring suitable for Obel for EB equiv. no. EB053		



1

<b>Part No.</b>	527414	<b>Ref. No.</b>	DF53
<b>description</b>	setting ring suitable for Obel for JUNIOR equiv. no. DF53		

accessories

stickers



1

<b>Part No.</b>	526275	<b>Ref. No.</b>	MQ82
<b>description</b>	sticker for setting ring L 60mm W 10mm		

coffee beans containers

container lids



1

<b>Part No.</b>	527333	<b>Ref. No.</b>	EB01
<b>description</b>	lid for coffee beans container ø 182mm		



1

<b>Part No.</b>	527335	<b>Ref. No.</b>	DF1
<b>description</b>	lid for coffee beans container ø 182mm		

coffee beans containers



1

<b>Part No.</b>	527336	<b>Ref. No.</b>	DF2
<b>description</b>	coffee beans container ø 125mm H 116mm seat ø 58mm		

spare parts for 527336



1



<b>Part No.</b>	527335	<b>Ref. No.</b>	DF1
<b>description</b>	lid for coffee beans container ø 182mm		





1



<b>Part No.</b>	527334	<b>Ref. No.</b>	EB02 G02
<b>description</b>	coffee beans container ø 185mm H 211mm seat ø 65mm		
<b>spare parts for</b>	527334		
	<b>Part No.</b>	527333	<b>Ref. No.</b> EB01
	lid for coffee beans container ø 182mm		
	<b>Part No.</b>	527567	<b>Ref. No.</b> —
	protection cap with magnet		

support for filter holder

	<b>Part No.</b>	527536	<b>Ref. No.</b> DF33
	description bracket for filter holder L 66mm W 45mm H 17mm		

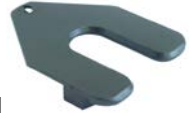
	<b>Part No.</b>	527535	<b>Ref. No.</b> EB033
	description filter holder support for dosing pump		

	<b>Part No.</b>	526364	<b>Ref. No.</b> EB033S MQ33
	description filter holder support for dosing unit L 140mm W 79mm H 41mm		

counters

	<b>Part No.</b>	526352	<b>Ref. No.</b> EB054
	description counter suitable for Obel		

knobs  
steam/water taps

	<b>Part No.</b>	111273	<b>Ref. No.</b> DS43 EB043
	description cotter pin ø 1.3mm L 25mm		

handles and hand wheels  
mushroom cap handles

	<b>Part No.</b>	111308	<b>Ref. No.</b> EB047
	description mushroom cap handle thread M8x1.25 handle ø 41mm L 25mm plastic black		

equipment feet and end caps  
screw-in feet

	<b>Part No.</b>	530773	<b>Ref. No.</b> EB019
	description equipment foot thread M5 ø 19mm H 18mm		

	<b>Part No.</b>	526345	<b>Ref. No.</b> EB019 / old version
	description equipment foot thread M5 thread L 5mm ø 20mm H 12.25mm Qty 1 pcs		



equipment feet with stem

 <p>1</p>			
<b>Part No.</b>	526359	<b>Ref. No.</b>	DF19J
<b>description</b>	equipment foot push-in ø 13mm H 4mm mounting ø 10mm overall height 11mm rubber Qty 1 pcs		

springs

compression springs

 <p>1</p>			
<b>Part No.</b>	526346	<b>Ref. No.</b>	EB041
<b>description</b>	compression spring ø 10.7mm L 89mm wire gauge ø 0.8mm for coffee press		

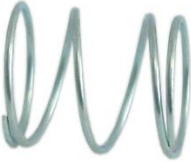
 <p>1</p>			
<b>Part No.</b>	527527	<b>Ref. No.</b>	DF061 EB061
<b>description</b>	compression spring ø 28.9mm L 35mm wire gauge ø 1.9mm		

 <p>1</p>			
<b>Part No.</b>	526347	<b>Ref. No.</b>	EB05
<b>description</b>	compression spring ø 4.5mm L 25mm wire gauge ø 0.55mm		

 <p>1</p>			
<b>Part No.</b>	526349	<b>Ref. No.</b>	EB057
<b>description</b>	compression spring ø 4mm L 33mm wire gauge ø 0.3mm		

tension springs

 <p>1</p>			
<b>Part No.</b>	526348	<b>Ref. No.</b>	EB055
<b>description</b>	tension spring ø 11mm total length 49mm wire gauge ø 1mm L1 30mm		

 <p>1</p>			
<b>Part No.</b>	526351	<b>Ref. No.</b>	EB028
<b>description</b>	tension spring ø 5.2mm total length 51mm wire gauge ø 0.55mm L1 29mm		

fastening material

fasteners

cotter pins

 <p>1</p>			
<b>Part No.</b>	111273	<b>Ref. No.</b>	DS43 EB043
<b>description</b>	cotter pin ø 1.3mm L 25mm		

**GASTRO**PARTS.COM

