



GASTROPARTS

NW

- [EN]** Equipment
- [DE]** Geräte
- [ES]** Aparatos
- [FR]** Équipement
- [IT]** Attrezzature
- [PL]** Urządzenia
- [RU]** Оборудование

✉ gastroparts@gastroparts.com

☎ tel. +48 56 657 00 66

📘 fb.com/gastroparts.global



GASTROPARTS.COM











heating elements

heating elements for coffee machine

 <p>1</p>			
Part No.	417453	Ref. No.	098645
description	heating element 1000W 220V heating circuits 1 ø 55mm H 62mm W1 44mm H1 32mm H2 30mm mounting distance 40mm thread M10x1 stainless steel windings 4 tube ø 6mm coffee machine screw		
accessories for	417453		
	Part No.	510416	Ref. No. —
	flat gasket fibre ED ø 19mm ID ø 10.5mm thickness 1.5mm for thread M10 Qty 1 pcs		
	Part No.	510893	Ref. No. —
	O-ring EPDM thickness 2.62mm ID ø 9.92mm Qty 1 pcs		
	Part No.	520231	Ref. No. —
	nut thread M10x1 H 6mm WS 14 zinc-coated steel Qty 1 pcs		
	Part No.	521129	Ref. No. —
	nut thread M10 H 6mm SS WS 17 Qty 1 pcs DIN/ISO DIN 439		

flow heaters

 <p>1</p>			
Part No.	417214	Ref. No.	0V2506
description	flow heater 1000W 220V ø 88mm L 110mm Wmm complete coffee machine suitable for KORO ES/Tank C252X02		
spare parts for	417214		
	Part No.	370477	Ref. No. 098761 258743
	solenoid valve brass 230VAC outlet 1/8" 5-way body outer cone slide-on receptacle DIN ODE coil type BDA/LBA p max 15bar coffee machine		
	Part No.	390624	Ref. No. 0V1318
	bi-metal safety thermostat hole distance 40mm switch-off temp. 125°C 2NC 2-pole 16A connection F6.3 2 hole fixing		
	Part No.	402078	Ref. No. 094372 094872 259898
	temperature probe NTC 10kOhm cable probe -40 up to +110°C cable°C connection male faston 6.3mm thread 1/4" probe ø10x25mm cable lengthm		
	Part No.	417453	Ref. No. 098645
	heating element 1000W 220V heating circuits 1 ø 55mm H 62mm W1 44mm H1 32mm H2 30mm mounting distance 40mm thread M10x1 stainless steel windings 4 tube ø 6mm coffee machine screw		
	Part No.	528110	Ref. No. 093347 095624
	O-ring EPDM thickness 2.62mm ID ø 12.37mm Qty 1 pcs		

spare parts for	417214		
	Part No.	528500	Ref. No. 098701
	O-ring EPDM thickness 3.53mm ID ø 72.62mm Qty 1 pcs		

thermostats

bi-metal thermostats



safety bi-metal thermostats

 <p>1</p>			
Part No.	390624	Ref. No.	0V1318
description	bi-metal safety thermostat hole distance 40mm switch-off temp. 125°C 2NC 2-pole 16A connection F6.3 2 hole fixing		

switches and momentary switches



rocker/momentary rocker switches

30x22mm

 <p>1</p>			
Part No.	346377	Ref. No.	251858
description	rocker switch mounting measurements 30x22mm black 2CO 230V 16A 0-1 connection male faston 6.3mm ambient temperature max. 125/55°C protection IP40		
accessories for	346377		
	Part No.	301036	Ref. No. —
	protective cover internal size 30x22mm for rocker switch mounting measurementsmm		

accessories

push buttons

 <p>1</p>			
Part No.	527289	Ref. No.	251787
description	button grey		
accessories for	527289		
	Part No.	402089	Ref. No. 251865
	keypad PCB for coffee machine		
	Part No.	402110	Ref. No. 251785
	push button set 8-piece transparent		



microswitches

roller-lever actuated

microswitches



1

Part No.	347028	Ref. No.	251861
description	microswitch with handle with a switch 250V 10A 1NO connection male faston 6.3mm L 28mm ambient temperature max. 125°C black/green lever length 26mm		

non-standard



1

Part No.	347026	Ref. No.	096355
description	microswitch with handle with a switch 250V 5A 1CO connection soldering connection L 12.5mm L1 20mm ambient temperature max. 85°C mounting distance 10mm actuating force: 55g lever length 16.6mm		

pin-plunger actuated



1

Part No.	300092	Ref. No.	097796
description	microswitch with plunger 400V 16A 2NO connection male faston 6.3mm ambient temperature max. 85°C mounting distance 22mm type XTD22A21 actuating force: 150g fryer black		

with push button

switches with snap-fit



1

Part No.	347027	Ref. No.	0V2378
description	microswitch with push button 250V 1A 1CO connection male faston 2.8mm L 26x12mm ambient temperature max. 85°C type XKA-304B1AAJ11 actuating force: 50g		

accessories



1

Part No.	347031	Ref. No.	090681
description	insulating mat for microswitch L 42mm W 28mm		

float switches

floats



1

Part No.	527288	Ref. No.	251851
description	float for drip pan		



1

Part No.	527287	Ref. No.	251876
description	float with magnet ømm L 23.5mm W 16mm H 17mm plastic		

magnetic switches

29x19mm



1

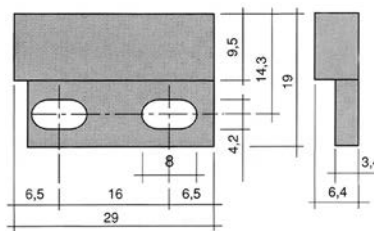

Part No.	347030 ¹	Ref. No.	251860
description	magnetic switch L 29mm W 19mm 1NO 250V cable length 360mm		

¹with coded connector



transformers

open transformers

with cable connection

 <p>1</p>			
Part No.	400058	Ref. No.	098792
description	transformer primary 230V secondary 15V 15VA connection cable 250mm 50/60Hz		

probes

producer-specific probes

probes



 <p>1</p>											
Part No.	402078	Ref. No.	094372 094872 259898								
description	temperature probe NTC 10kOhm cable probe -40 up to +110°C cable°C connection male faston 6.3mm thread 1/4" probe ø10x25mm cable lengthm										
spare parts for	402078										
 <table border="1"> <tr> <td>Part No.</td> <td>528110</td> <td>Ref. No.</td> <td>093347 095624</td> </tr> <tr> <td colspan="4">O-ring EPDM thickness 2.62mm ID ø 12.37mm Qty 1 pcs</td> </tr> </table>				Part No.	528110	Ref. No.	093347 095624	O-ring EPDM thickness 2.62mm ID ø 12.37mm Qty 1 pcs			
Part No.	528110	Ref. No.	093347 095624								
O-ring EPDM thickness 2.62mm ID ø 12.37mm Qty 1 pcs											

electronics

PCBs

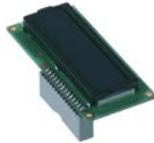
 <p>1</p>			
Part No.	402088	Ref. No.	0V2143
description	control PCB coffee machine KORO		

 <p>1</p>			
Part No.	402090	Ref. No.	0V3458 251653
description	display coffee machine KORO		



 <p>1</p>											
Part No.	402089	Ref. No.	251865								
description	keypad PCB for coffee machine										
accessories for	402089										
 <table border="1"> <tr> <td>Part No.</td> <td>402110</td> <td>Ref. No.</td> <td>251785</td> </tr> <tr> <td colspan="4">push button set 8-piece transparent</td> </tr> </table>				Part No.	402110	Ref. No.	251785	push button set 8-piece transparent			
Part No.	402110	Ref. No.	251785								
push button set 8-piece transparent											
 <table border="1"> <tr> <td>Part No.</td> <td>527289</td> <td>Ref. No.</td> <td>251787</td> </tr> <tr> <td colspan="4">button grey</td> </tr> </table>				Part No.	527289	Ref. No.	251787	button grey			
Part No.	527289	Ref. No.	251787								
button grey											

 <p>1</p>			
Part No.	402091	Ref. No.	252604
description	PCB coffee machine KORO 16Bit		

keypads

accessories

 <p>1</p>			
Part No.	402111	Ref. No.	251786
description	push button L 60mm W 11 mm H 9mm grey		

 <p>1</p>											
Part No.	402110	Ref. No.	251785								
description	push button set 8-piece transparent										
accessories for	402110										
 <table border="1"> <tr> <td>Part No.</td> <td>402089</td> <td>Ref. No.</td> <td>251865</td> </tr> <tr> <td colspan="4">keypad PCB for coffee machine</td> </tr> </table>				Part No.	402089	Ref. No.	251865	keypad PCB for coffee machine			
Part No.	402089	Ref. No.	251865								
keypad PCB for coffee machine											
 <table border="1"> <tr> <td>Part No.</td> <td>527289</td> <td>Ref. No.</td> <td>251787</td> </tr> <tr> <td colspan="4">button grey</td> </tr> </table>				Part No.	527289	Ref. No.	251787	button grey			
Part No.	527289	Ref. No.	251787								
button grey											



solenoid valves

solenoid valves (water)

various



1

Part No.	372216	Ref. No.	251895 253818
description	solenoid valve with pressure switch single, angled 230VAC outlet 11mm inlet 3/4"mm		

metal

ODE

5-way



1

Part No.	370477	Ref. No.	098761 258743
description	solenoid valve brass 230VAC outlet 1/8" 5-way body outer cone slide-on receptacle DIN ODE coil type BDA/LBA p max 15bar coffee machine		

spare parts for 370477

	Part No.	371150	Ref. No.	099057
	description	solenoid coil ODE 230VAC 16VA coil type BDV seat ø 13.5mm 750Ohm		
	Part No.	371191	Ref. No.	099056
	description	solenoid coil ODE 230VAC 10VA 50Hz coil type LBA seat ø 10mm		
	Part No.	371192	Ref. No.	099105
	description	solenoid valve body ø 13mm		
	Part No.	371193	Ref. No.	097472
	description	valve insert L 30mm ø 12mm Viton		
	Part No.	371194	Ref. No.	0V1953
	description	solenoid valve body ø 10mm		
	Part No.	371195	Ref. No.	099058
	description	valve insert L 24mm ø 9mm Viton		
	Part No.	510177	Ref. No.	094594
	description	O-ring EPDM thickness 1.78mm ID ø 7.66mm Qty 1 pcs		
	Part No.	520333	Ref. No.	095529
	description	hose connector brass straight thread 1/8" hose ø 7mm Qty 1 pcs		
	Part No.	520334	Ref. No.	0V2509
	description	angle piece thread 1/8" with coupling angled hose ø 5mm		

spare parts and accessories

gaskets



1

Part No.	371196	Ref. No.	099059
description	O-ring ø 12mm for valve body		

solenoid coils



1

Part No.	371191	Ref. No.	099056
description	solenoid coil ODE 230VAC 10VA 50Hz coil type LBA seat ø 10mm		



1

Part No.	371150	Ref. No.	099057
description	solenoid coil ODE 230VAC 16VA coil type BDV seat ø 13.5mm 750Ohm		

valve inserts



1

Part No.	371195	Ref. No.	099058
description	valve insert L 24mm ø 9mm Viton		



1

Part No.	371193	Ref. No.	097472
description	valve insert L 30mm ø 12mm Viton		

valve bodies



1

Part No.	371194	Ref. No.	0V1953
description	solenoid valve body ø 10mm		



			
1			
Part No.	371192	Ref. No.	099105
description	solenoid valve body ø 13mm		

flow meters and flow sensors

flow meters

GICAR

			
1			
Part No.	400782	Ref. No.	098707
description	flow meter hose ø 6mm plastic plug-in connection approval NSF		

fans

axial fans

ebm-papst

			
1			
Part No.	601496 ¹	Ref. No.	251867
description	axial fan L 60mm W 60mm H 25mm 12VDC 0.8W bearing ball bearing manuf. no. 612NME plastic connection cable 310mm ebm-papst fan wheel ø 55mm with plug		

¹with ball bearings

motors

gear motors

for automatic coffee machines

			
1			
Part No.	601486	Ref. No.	252030
description	gear motor 90W 230V 50Hz 48rpm shaft ø 15mm L 95mm W 61mm H 90mm for coffee machine		

			
1			
Part No.	601488	Ref. No.	251866
description	gear motor 90W 230V 50Hz 70rpm shaft ø 15mm L 96mm W 55mm H 90mm for coffee machine		

			
1			
Part No.	601490	Ref. No.	098708
description	gear motor LIP type 111 48W 230V 50Hz 8rpm shaft ø 6x8.5mm L 110mm W 71mm H 80mm		

motors

for automatic coffee machines

			
1			
Part No.	601494	Ref. No.	251777
description	motor for coffee grinder 230V 48W 50/60Hz 1 phase shaft ø 7.5mm shaft length 24mm H 70mm L 120mm W 70mm KORO- ESPRESSO FISE		





1

Part No.	601495	Ref. No.	098808
description	motor for mixer 230V 50/60Hz 1 phase shaft ø 4mm shaft length 27mm KORO- ESPRESSO		
accessories for	601495		
	Part No.	527278	Ref. No. 097916
	impellor ø 32mm		



1

Part No.	500124	Ref. No.	098760
description	vibration pump type EX 5 230V 48W 50/60Hz inlet ø 6 outlet ø 1/8" IT flat seal ULKA brass L 123mm		
accessories for	500124		
	Part No.	520152	Ref. No. 252021
	hose connector Santoprene grommet ø 7mm grommet length 14mm		
	Part No.	520330	Ref. No. 0V4275
	bracket rubber dimensions 69x44x4mm		

pumps

vibration pumps



1

Part No.	520330	Ref. No.	0V4275
description	bracket rubber dimensions 69x44x4mm		



1

Part No.	520152	Ref. No.	252021
description	hose connector Santoprene grommet ø 7mm grommet length 14mm		



1

Part No.	390625	Ref. No.	0V1301
description	thermal fuse switch-off temp. 110°C suitable for ULKA pump Klixon		

condensators & interference suppression filters

filters

line filters

with housing



1

Part No.	365077	Ref. No.	097155 0V3512
description	line filter type 411524410 250V 50/60Hz conductor 2 with E connection male faston 6.3mm L 50mm ø 38mm Hmm Wmm M8 plastic Qty 1 pcs		

fuses

fine fuses



1

Part No.	358593	Ref. No.	097544
description	fine fuse size ø5x20mm 0.125A slow-acting rated 250V Qty 10 pcs		



1

Part No.	358601	Ref. No.	097103
description	fine fuse size ø5x20mm 1.25A slow-acting rated 250V Qty 10 pcs		





			
1			
Part No.	358851	Ref. No.	095636
description	fuse size ø6.3x32mm 15A slow-acting rated 250V Qty 1 pcs		

fine fuse holders			
			
1			
Part No.	358852	Ref. No.	251863
description	fuse holder suitable fuse ø6.3x32mm ø 16mm 1-pole 16A rated 250V L 52mm connection male faston 4.8mm/6.3mm		

electric accessories

terminals

terminal blocks with fuse holder			
			
1			
Part No.	358391	Ref. No.	097241
description	lustre terminal 2-pole max. 24A max 450V suitable fuse ø5x20mm cross section 2.5mm ² with fuse holder		

			
1			
Part No.	358393	Ref. No.	098793
description	lustre terminal 4-pole max. 24A max 450V suitable fuse ø5x20mm cross section 2.5mm ² with fuse holder		

connection terminals with screw/faston connections



			
1			
Part No.	550458	Ref. No.	251856
description	power terminal block 3-pole max. 25A max 450V connection ø2.5mm ² / F6.3 temp.-resist. 150°C		

equipment-specific units

for espresso machines

non-return valves

complete

			
1			
Part No.	529889	Ref. No.	099101
description	non-return valve thread 1/8" IT - 1/8" ET		
accessories for	529889		
	Part No.	Ref. No.	
	691535	251143	
	disc ID ø 10mm ED ø 14mm thicknessmm aluminium Qty 1 pcs		

screw connections

washers

			
1			
Part No.	691535	Ref. No.	251143
description	disc ID ø 10mm ED ø 14mm thicknessmm aluminium Qty 1 pcs		

for coffee grinders

coffee beans containers

container lids

			
1			
Part No.	527843	Ref. No.	252423
description	lid L 180mm W 160mm H 3mm plastic transparent for coffee beans container		

coffee beans containers

			
1			
Part No.	527572	Ref. No.	251770
description	coffee grinder		
spare parts for	527572		
	Part No.	Ref. No.	
	402076	251779	
	sensor for coffee grinder complete		
	Part No.	Ref. No.	
	527249	095840	
	grinding burr turn direction right D1 ø 63mm ID ø 38mm H 9mm tooth spacing 3mm hole ø 5.5mm bore ø 8.5mm mounting ø 48 straight suitable for N & W		
	Part No.	Ref. No.	
	601494	251777	
	motor for coffee grinder 230V 48W 50/60Hz 1 phase shaft ø 7.5mm shaft length 24mm H 70mm L 120mm W 70mm KORO- ESPRESSO FISE		



for cup coffee machines

instant mixer units



1

Part No.	527279	Ref. No.	251833
description	coffee device type Z3000		



1

Part No.	527277	Ref. No.	251869
description	flange for mixing hopper		



1

Part No.	527278	Ref. No.	097916
description	impellor ø 32mm		



1

Part No.	527275	Ref. No.	251768
description	intake body plastic		

accessories for 527275

	Part No.	527276	Ref. No.	251767
	description	lid plastic for intake body		



1

Part No.	527276	Ref. No.	251767
description	lid plastic for intake body		



1

Part No.	527274	Ref. No.	251874
description	mixing hopper plastic		

coffee spouts

coffee spouts



1

Part No.	527283	Ref. No.	096868
description	coffee spout for coffee powder container rectangular		



1

Part No.	527282	Ref. No.	098939
description	coffee spout for coffee powder container round		

coffee beans containers

container lids



1

Part No.	527843	Ref. No.	252423
description	lid L 180mm W 160mm H 3mm plastic transparent for coffee beans container		



coffee beans containers



1

Part No.	527280	Ref. No.	251908
description	container complete incl. coil, lift and scraper for instant unit		
accessories for	527280		
	Part No.	527282	Ref. No. 098939
	coffee spout for coffee powder container round		



1

Part No.	527281	Ref. No.	251875
description	container with auger gear for instant unit		
accessories for	527281		
	Part No.	527282	Ref. No. 098939
	coffee spout for coffee powder container round		

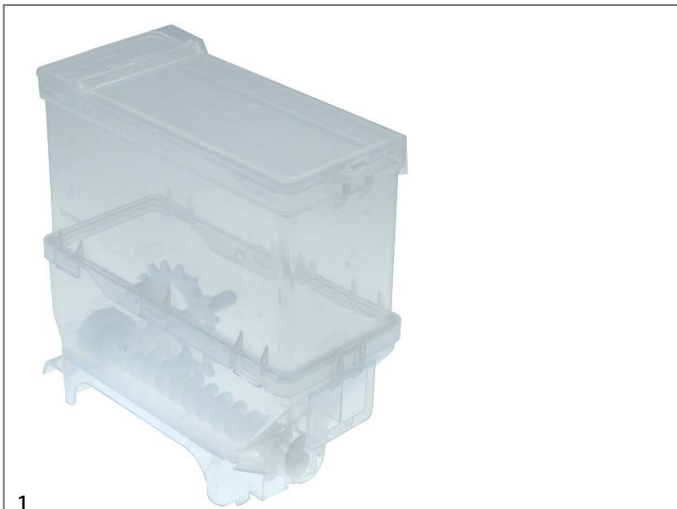

1

Part No.	527834	Ref. No.	252462
description	container standard		
accessories for	527834		
	Part No.	527283	Ref. No. 096868
	coffee spout for coffee powder container rectangular		

accessories



1

Part No.	527285	Ref. No.	252424
description	base part for coffee beans container		
accessories for	527285		
	Part No.	527284	Ref. No. 252536
	increasing for coffee beans container		



1

Part No.	527284	Ref. No.	252536
description	increasing for coffee beans container		
accessories for	527284		
	Part No.	527843	Ref. No. 252423
	lid L 180mm W 160mm H 3mm plastic transparent for coffee beans container		



grinding units

automatic grinding



1

Part No.	402076	Ref. No.	251779
-----------------	--------	-----------------	--------

description sensor for coffee grinder complete

grinding burrs



1

Part No.	527249	Ref. No.	095840
-----------------	--------	-----------------	--------

description grinding burr turn direction right D1 ø 63mm ID ø 38mm H 9mm tooth spacing 3mm hole ø 5.5mm bore ø 8.5mm mounting ø 48 straight suitable for N & W

mechanical components



1

Part No.	520334	Ref. No.	0V2509
-----------------	--------	-----------------	--------

description angle piece thread 1/8" with coupling angled hose ø 5mm

keys



1

Part No.	527290	Ref. No.	097812 0V1654
-----------------	--------	-----------------	------------------

description service key

water containers



1

Part No.	527286	Ref. No.	251873
-----------------	--------	-----------------	--------

description water container complete

spare parts for 527286



Part No.	527287	Ref. No.	251876
-----------------	--------	-----------------	--------

description float with magnet ømm L 23.5mm W 16mm H 17mm plastic

counters



1

Part No.	527273	Ref. No.	251862
-----------------	--------	-----------------	--------

description counter coffee machine impulse 10imp/s mounting measurements 22x30mm 12VDC

locks

locking devices

producer-specific

N&W



1

Part No.	691527	Ref. No.	252137
-----------------	--------	-----------------	--------

description key cylinder with key

gaskets

O-rings

EPDM

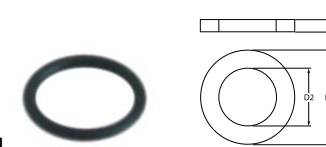

1

Part No.	529545	Ref. No.	092140 252684
-----------------	--------	-----------------	------------------

description O-ring EPDM thickness 1.78mm ID ø 10.82mm Qty 1 pcs

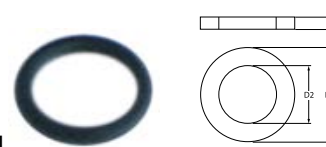

1

Part No.	510177	Ref. No.	094594
-----------------	--------	-----------------	--------

description O-ring EPDM thickness 1.78mm ID ø 7.66mm Qty 1 pcs

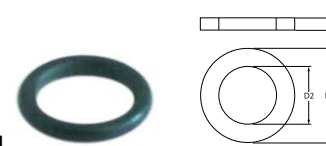

1

Part No.	528110	Ref. No.	093347 095624
-----------------	--------	-----------------	------------------

description O-ring EPDM thickness 2.62mm ID ø 12.37mm Qty 1 pcs



Part No.	528500	Ref. No.	098701
description	O-ring EPDM thickness 3.53mm ID ø 72.62mm Qty 1 pcs		

Part No.	520840	Ref. No.	097513
description	silicone hose ID ø 9mm ED ø 13mm L 1m thickness 2mm operating pressure without pressure burst pressure non defined t.max. 200°C brown		

hoses

industrial hoses

PTFE hoses

Part No.	520845 ¹	Ref. No.	252658
description	PTFE hose ED ø 6mm ID ø 3mm thickness 1.5mm Lm		

¹by the meter

silicone hoses

without fabric

Part No.	520842	Ref. No.	097529
description	silicone hose ID ø 3mm ED ø 6mm L 1m thickness 1.5mm t.max. 200°C brown		

Part No.	520843	Ref. No.	097510
description	silicone hose ID ø 5mm ED ø 9mm L 1m thickness 2mm operating pressure without pressure burst pressure non defined t.max. 200°C brown		

Part No.	520844	Ref. No.	097511
description	silicone hose ID ø 6mm ED ø 9mm L 1m thickness 1.5mm operating pressure without pressure burst pressure non defined t.max. 200°C brown		

fittings, hose and pipe connectors

hose connectors

brass

Part No.	520333	Ref. No.	095529
description	hose connector brass straight thread 1/8" hose ø 7mm Qty 1 pcs		

fastening material

screws

flat-headed bolts

Part No.	560062	Ref. No.	252917
description	flat-headed bolt thread M4 thread L 10mm SS DIN 7985/ISO 7045 Qty 20 pcs intake Phillips head ø 8mm head thickness 2mm		

washers

washers

miscellaneous

Part No.	691535	Ref. No.	251143
description	disc ID ø 10mm ED ø 14mm thicknessmm aluminium Qty 1 pcs		



consumables

fuses

fine fuses



1

Part No.	358593	Ref. No.	097544
description	fine fuse size ø5x20mm 0.125A slow-acting rated 250V Qty 10 pcs		



1

Part No.	358601	Ref. No.	097103
description	fine fuse size ø5x20mm 1.25A slow-acting rated 250V Qty 10 pcs		

ø6.3x32mm 250V



1

Part No.	358851	Ref. No.	095636
description	fuse size ø6.3x32mm 15A slow-acting rated 250V Qty 1 pcs		

GASTROPARTS.COM

