



GASTROPARTS

Multi

[EN] Equipment

[DE] Geräte

[ES] Aparatos

[FR] Équipement

[IT] Attrezzature

[PL] Urządzenia

[RU] Оборудование

✉ gastroparts@gastroparts.com

☎ tel. +48 56 657 00 66

📘 fb.com/gastroparts.global

GASTROPARTS.COM





heating elements

heating elements for bain maries

1 

Part No.	415927	Ref. No.	665004
description	heating element 1200W 240V heating circuits 1 L 405mm W 88mm H 32mm lug length 40mm lug width 18mm dry heating element hole distance 44mm connection M5 bracket mounting mounting thread M5		

1 

Part No.	415926	Ref. No.	665003
description	heating element 1800W 240V heating circuits 1 L 403mm W 128mm H 32mm lug length 40mm lug width 18mm tube ø 8.5mm dry heating element hole distance 80mm bracket mounting mounting thread M5		

heating elements for fryers

side connection

miscellaneous

1 

Part No.	418077	Ref. No.	537026800
description	heating element 19500W 230/400V heating circuits 3 mounting pos. right L 458mm W 190mm H 35mm flange length 36.5mm flange length 1 3mm flange length 2 33.5mm flange ø1 65mm flange ø2 60mm thermostat sleeves ø 6mm length thermostat sleeves 180mm number of thermostat sleeves 2 thermostat sleeve eccentric, clinging/not clinging L1 18mm L2 440mm W1 38mm W2 152mm tube ø 8.5mm cable length 500mm rotation flange fryer heaters connection length 30mm		
accessories for	418077		
	Part No.	550494	Ref. No. —
	O-ring Viton thickness 3.53mm ID ø 47.22mm Qty 1 pcs		

2 hole fixing







1 

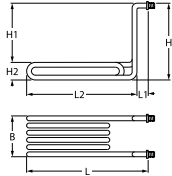

Part No.	420177	Ref. No.	665001
description	heating element 2100W 230V heating circuits 1 L 293mm W 40mm H 205mm L1 23mm L2 270mm H1 165mm H2 40mm thread M14x1.5 mounting distance 35mm tube ø 8.5mm 2 hole fixing connection M5 connection length 23mm immersion heater windings 4		

1 



Part No.	415929	Ref. No.	665028
description	heating element 2500W 230V heating circuits 1 L 293mm W 40mm H 205mm L1 23mm L2 270mm H1 165mm H2 40mm thread M14x1.5 mounting distance 35mm tube ø 8.5mm 2 hole fixing connection M5 connection length 23mm immersion heater windings 4		
spare parts for	415929		
	Part No.	510417	Ref. No. —
	flat gasket fibre ED ø 20mm ID ø 14mm thickness 2mm Qty 1 pcs		
accessories for	415929		
	Part No.	520228	Ref. No. —
	tooth lock washer ID ø 15.3mm ED ø 24mm steel Qty 1 pcs for thread M14		
	Part No.	520230	Ref. No. —
	nut thread M14x1.5 H 5mm WS 19 zinc-coated steel Qty 1 pcs		
	Part No.	521101	Ref. No. —
	nut thread M14x1.5 H 5mm WS 19 SS Qty 1 pcs		
	Part No.	550262	Ref. No. —
	flat gasket copper ED ø 20mm ID ø 14mm thickness 2mm		
	Part No.	560112	Ref. No. —
	plain washer ID ø 5.3mm ED ø 10mm thickness 1mm SS Qty 20 pcs DIN 125A for thread M5		
	Part No.	560132	Ref. No. —
	hexagonal nut thread M5 H 4mm WS 8 SS DIN/ISO DIN 934 / ISO 4032/8673 Qty 20 pcs		

heating elements for griddles

1 

Part No.	415928	Ref. No.	665002
description	heating element 1800W 240V heating circuits 1 L 470mm W 90mm H 65mm tube ø 8.5mm connection M5 connection distance 82mm dry heating element		

1 

Part No.	415932	Ref. No.	965000
description	heating element 2186/2380W 230/240V heating circuits 1 L 650mm W 78mm H 72mm tube ø 8.5mm connection M5 connection length 20mm griddle connection distance 65mm dry heating element		







			
1			
Part No.	415933	Ref. No.	965008
description	heating element 2580W 240V heating circuits 1 L 530mm W 130mm H 65mm tube ø 8.5mm W1 40mm W2 50mm connection M5 connection length 21mm tilting bratt pan connection distance 35mm dry heating element		

heating elements for tilting bratt pan







			
1			
Part No.	415930	Ref. No.	965007
description	heating element tilting bratt pan 3440W 240V L 530mm W 205mm H 60mm connection M4 dry heating element heating circuits 1 tube ø 8.5mm W1 30mm W2 140mm connection distance 130mm		





heating elements for pasta cookers

			
1			
Part No.	416535	Ref. No.	665032
description	heating element 3000W 230V heating circuits 1 L 303mm W 170mm H 6mm 2 hole fixing connection M4 thread M10x1 tube ø 6.3mm mounting distance 164mm immersion heater		
spare parts for	416535		
	Part No.	510893	Ref. No. —
	O-ring EPDM thickness 2.62mm ID ø 9.92mm Qty 1 pcs		



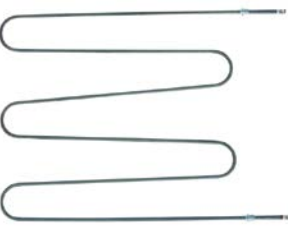

			
1			
Part No.	418046	Ref. No.	465000
description	heating element 3800W 230V heating circuits 3 L 250mm W 41mm H 34mm round flange connection male faston 6.3mm tube ø 6.3mm mounting ø 57.5mm immersion heater with gasket		
spare parts for	418046		
	Part No.	510409	Ref. No. —
	O-ring EPDM thickness 5.34mm ID ø 56.52mm Qty 1 pcs		
accessories for	418046		
	Part No.	550002	Ref. No. —
	tension strap H 10mm L 21mm W 10mm hole ø 6.5mm for heating element		

heating elements for pizza ovens

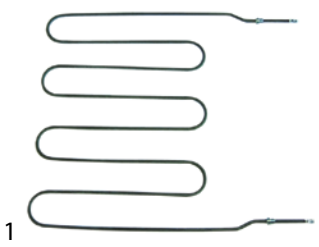
			
1			
Part No.	415941	Ref. No.	501001
description	heating element 2000W 230V L 470mm W 506mm L1 30mm L2 50mm L3 390mm W1 18mm W2 470mm thread 1/4" mounting distance 461mm connection length 115mm connection M5 windings 4 tube ø 8.5mm heating circuits 1 dry heating element 2 hole fixing pizza oven		
spare parts for	415941		
	Part No.	510417	Ref. No. —
	flat gasket fibre ED ø 20mm ID ø 14mm thickness 2mm Qty 1 pcs		
accessories for	415941		
	Part No.	361182	Ref. No. —
	nut thread 1/4" H 5mm nickel-plated brass WS 17 Qty 1 pcs		
	Part No.	520228	Ref. No. —
	tooth lock washer ID ø 15.3mm ED ø 24mm steel Qty 1 pcs for thread M14		
	Part No.	550262	Ref. No. —
	flat gasket copper ED ø 20mm ID ø 14mm thickness 2mm		
	Part No.	560112	Ref. No. —
	plain washer ID ø 5.3mm ED ø 10mm thickness 1mm SS Qty 20 pcs DIN 125A for thread M5		
	Part No.	560132	Ref. No. —
	hexagonal nut thread M5 H 4mm WS 8 SS DIN/ISO DIN 934 / ISO 4032/8673 Qty 20 pcs		



			
1			
Part No.	416638	Ref. No.	501131
description	heating element 2100W 230V L 580mm W 460mm thread 1/4" mounting distance 425mm connection length 102mm connection M5 tube ø 8.5mm heating circuits 1 dry heating element 2 hole fixing		
accessories for	416638		
	Part No.	361182	Ref. No. —
	nut thread 1/4" H 5mm nickel-plated brass WS 17 Qty 1 pcs		
	Part No.	510417	Ref. No. —
	flat gasket fibre ED ø 20mm ID ø 14mm thickness 2mm Qty 1 pcs		
	Part No.	520228	Ref. No. —
	tooth lock washer ID ø 15.3mm ED ø 24mm steel Qty 1 pcs for thread M14		
	Part No.	550262	Ref. No. —
	flat gasket copper ED ø 20mm ID ø 14mm thickness 2mm		

Part No.	415942	Ref. No.	501022
description	heating element 2280W 230V L 600mm W 610mm L1 30mm L2 50mm L3 520mm W1 20mm W2 570mm thread 1/4" mounting distance 561mm connection length 101mm connection M5 windings 4 tube ø 8.6mm heating circuits 1 dry heating element 2 hole fixing		
accessories for	415942		
	Part No.	361182	Ref. No. —
	nut thread 1/4" H 5mm nickel-plated brass WS 17 Qty 1 pcs		
	Part No.	510417	Ref. No. —
	flat gasket fibre ED ø 20mm ID ø 14mm thickness 2mm Qty 1 pcs		
	Part No.	520228	Ref. No. —
	tooth lock washer ID ø 15.3mm ED ø 24mm steel Qty 1 pcs for thread M14		
	Part No.	550262	Ref. No. —
	flat gasket copper ED ø 20mm ID ø 14mm thickness 2mm		

with round flange ø57.5mm



Part No.	415265	Ref. No.	130011
description	heating element 9000W 230V heating circuits 3 mounting ø 57.5mm L 470mm W 35mm H 41mm round flange connection M5 immersion heater tube ø 8.5mm connection length upper centre not clinging-mm thermostat sleeves ø 7.5mm number of thermostat sleeves 1 length thermostat sleeves 295mm		
spare parts for	415265		
	Part No.	510409	Ref. No. —
	O-ring EPDM thickness 5.34mm ID ø 56.52mm Qty 1 pcs		
accessories for	415265		
	Part No.	550002	Ref. No. —
	tension strap H 10mm L 21mm W 10mm hole ø 6.5mm for heating element		

immersion heating elements

3 hole flange ø47.5mm

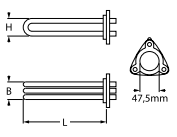
Part No.	419032	Ref. No.	150023
description	heating element 4500W 230V mounting ø 47.5mm heating circuits 3 L 285mm W 32mm H 40mm number of thermostat sleeves 1 thermostat sleeves ø 7.5mm length thermostat sleeves 233mm thermostat sleeve eccentric, clinging tube ø 6.3mm hole distance 63mm hole ø 8mm connection length 25mm connection M4 3 hole flange immersion heater		
accessories for	419032		
	Part No.	510408	Ref. No. 0835534701 107000 130040
	O-ring EPDM thickness 5.34mm ID ø 47mm Qty 1 pcs		

heating elements for convection



Part No.	415925	Ref. No.	665008
description	heating element 1260W 230V heating circuits 1 ID ø 180mm L 380mm H 19mm L1 188mm W1 32mm flange length 100mm flange width 22mm hole distance 86mm ED ø 192mm connection M5 connection length 30mm tube ø 6.3mm convection heating element hole ø 5mm rectangular flange		

accessories

sealing washers

O-rings

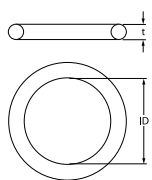
Part No.	510408	Ref. No.	0835534701 107000 130040
description	O-ring EPDM thickness 5.34mm ID ø 47mm Qty 1 pcs		

with compression flange 62 x 26mm

Part No.	415270	Ref. No.	130805
description	heating element 2700W 230V heating circuits 1 compression flange flange 62x26mm L 335mm W 43mm H 25mm tube ø 6.3mm connection male faston 6.3mm immersion heater		

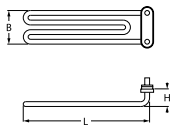

thermostats

bi-metal thermostats

safety bi-metal thermostats



1

Part No.	390480	Ref. No.	130803
description	bi-metal safety thermostat hole distance 23.8mm switch-off temp. 105°C 1NC 1-pole 16A connection F6.3 2 hole fixing		

control and safety thermostats

EGO

control thermostats

55.34_ series



1

Part No.	375092	Ref. No.	661005
description	thermostat t.max. 90°C temperature range 30-90°C 3-pole capillary pipe isolatedmm gland nut		

safety thermostats

55.10/19_ series



1

Part No.	390063	Ref. No.	661021
description	safety thermostat switch-off temp. 220°C 1-pole 1NC 15A probe ø 6mm probe L 77mm capillary pipe 870mm capillary pipe isolatedmm gland nut starting temperature 205°C probe SS		

55.31_ series



1

Part No.	390168	Ref. No.	661009
description	safety thermostat switch-off temp. 230°C 3-pole 3NC 20A probe ø 6mm probe L 239mm capillary pipe 830mm capillary pipe isolatedmm gland nut M9x1 probe SS		

55.32_ series

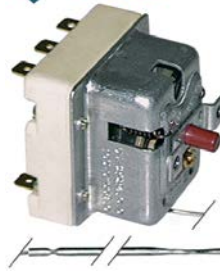

1

Part No.	390142	Ref. No.	661045
description	safety thermostat switch-off temp. 360°C 3-pole 20A probe ø 3.1mm probe L 188mm capillary pipe 1490mm capillary pipe isolated 800mm gland nut probe SS		

IMIT / TEMPOMATIC / ARTHERMO

safety thermostats



1

Part No.	375500	Ref. No.	150026
description	safety thermostat switch-off temp. 140°C 1-pole 1CO 15A probe ø 5mm probe L 125mm capillary pipe 1000mm capillary pipe isolated 900mm gland nut probe		



switches and momentary switches

push/momentary push switches

28.5x77.5mm



1

Part No.	345866	Ref. No.	130825
description	switch combination latching mounting measurements 28.5x77.5mm green 2NO/1NO/indicator light 250V 16A START/indicator light/on-off connection male faston 6.3mm ambient temperature max. 85°C protection IP40		



1

Part No.	345868	Ref. No.	130827
description	switch combination momentary mounting measurements 28.5x77.5mm green 2NO/indicator light 250V 16A drain/temperature connection male faston 6.3mm ambient temperature max. 85°C protection IP40		

microswitches

pin-plunger actuated

M10



1

Part No.	345032	Ref. No.	800267
description	microswitch with plunger thread M10x1 thread L 12mm 250V 16A 1CO connection male faston 6.3mm stroke 7mm mounting distance 22mm L 28mm ambient temperature max. 125°C type SP9603 actuating force: 180g		

timers

programme timers



1

Part No.	360356	Ref. No.	150045
description	timer CDC 7804F engines 1 chambers 4 operation time 144s 230V shaft ømm shaft Lmm manuf. no. 7804F1/ 46103600 motor type M37RN		
spare parts for	360356		
	Part No.	360119	Ref. No. —
	motor CDC pinion ø 5.4mm teeth 12 230V turn direction right motor ø 37mm motor type M37RN for timer		

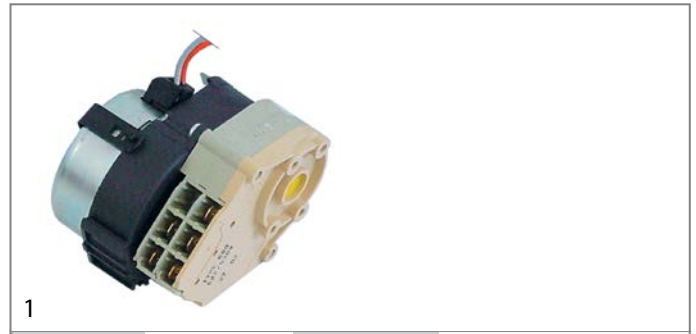

1

Part No.	360289	Ref. No.	130831
description	timer CROUZET engines 1 chambers 2 operation time 120s 230V shaft ømm shaft Lmm manuf. no. 627/5309 motor type 600		

contactors

ISKRA (FANAL)

power contactors



1

Part No.	380547	Ref. No.	150348
description	power contactor resistive load 20A 230VAC (AC3/400V) 5A/2.2kW main contacts 3NO auxiliary contacts 1NC connection screw connection type Fanal DSL3 01 type ISKRA K03M 01		

electronics

PCBs



1

Part No.	402953	Ref. No.	M500086900
description	control PCB dishwasher MB630/930 L 133mm W 82mm		



pressure switches

for warewashing

ø 58mm with male faston 6.3mm

with connection horizontal



1

Part No.	541314	Ref. No.	10706/A
description	pressure control pressure range 46/26mbar connection 6mm ø 58mm pressure connection horizontal warewashing pressure connection ø 6mm		



1

Part No.	541140	Ref. No.	130002
description	pressure control pressure range 55/30mbar connection 6mm ø 58mm pressure connection horizontal warewashing		



1

Part No.	541311	Ref. No.	130014
description	pressure control pressure range 76/38mbar connection 6mm ø 58mm pressure connection horizontal warewashing pressure connection ø 6mm		

fans

hot air motors



1

Part No.	601178	Ref. No.	664000	
description	fan motor 230V 1 phase 50Hz 0.12kW 1400rpm speeds 1 L1 120mm L2 77mm D1 ø 12mm 1.1A suitable capacitor at 50Hz 230V type MA711TYP01DX			
spare parts for	601178			
	Part No.	365013	Ref. No.	—
	operating capacitor capacity 8µF 400V tolerance 5%Hz ambient temperature max. -25 to +85°C ø 31.5mm L 55mm M8 plastic connection male faston 6.3mm protection			

pumps



wash and rinse pumps

FIR

pumps



1

Part No.	500527	Ref. No.	133025	
description	pump inlet ø 60mm outlet ø 50/30mm type 2233.B140 230V 50Hz 1 phase 0.55kW 0.75HP L 210mm rotation direction right capacitor 12.5µF FIR inlet ø 60mm			
spare parts for	500527			
	Part No.	365014	Ref. No.	—
	operating capacitor capacity 12.5µF 450V tolerance 5%Hz ambient temperature max. -25 to +85°C ø 35mm L 70mm M8 plastic connection male faston 6.3mm 45S.C3DS.12.5 protection			
	Part No.	510552	Ref. No.	—
	pump cover gasket pump type 1292-2/3942/3981/3911/3983			
	Part No.	510608	Ref. No.	—
	impellor ø 93mm H 32mm shaft intake ø 9/8mm blades 6 inner height 11mm			
	Part No.	510692	Ref. No.	—
	mechanical shaft seal for shaft ø 11mm slide ring ext. ø 24mm slide ring H 13mm counter ring mounting ø 26mm height counter ring 8mm counter ring int. ø 14mm			
	Part No.	521511	Ref. No.	—
	pump cover inlet ø 60mm outlet ø 50/30mm supporting pressure M12x1.75 supporting pressure open pump type 2233 turn direction right ø 160mm ID ø 120mm inner height 23mm			









OLYMPIA

pumps



1

Part No.	500521	Ref. No.	131125
description	pump inlet \varnothing 1" IT outlet \varnothing 26mm type T33 230V 50Hz 1 phase 0.25kW 0.34HP L 225mm rotation direction right capacitor 5 μ F auxiliary pressure connection 11mm supporting pressure closed OLYMPIA		
spare parts for	500521		
	Part No.	365017	Ref. No. —
	operating capacitor capacity 5 μ F 450V tolerance 5% 50/60Hz ambient temperature max. -25 to +85°C \varnothing 28mm L 54mm M8 plastic connection male faston 6.3mm 16.10.08 protection		
	Part No.	510693	Ref. No. —
	mechanical shaft seal for shaft \varnothing 12mm slide ring ext. \varnothing 24mm slide ring H 15.5mm slide ring int. \varnothing 11mm counter ring mounting \varnothing 24mm height counter ring 8mm counter ring int. \varnothing 13.5mm		
	Part No.	521256	Ref. No. —
	impellor \varnothing 74mm H 14mm thread M10L shaft \varnothing 12mm shaft length 7.5mm blades 8		
	Part No.	521554	Ref. No. —
	pump cover OLYMPIA inlet 1" \varnothing 90mm ID \varnothing 66mm inner height 5mm		
	Part No.	521724	Ref. No. —
	O-ring EPDM thickness 1.78mm ID \varnothing 72.75mm Qty 1 pcs		
	Part No.	528800	Ref. No. —
	O-ring EPDM thickness 2.62mm ID \varnothing 75.87mm Qty 1 pcs		



1

Part No.	500519	Ref. No.	133029
description	pump inlet \varnothing 33mm outlet \varnothing 30mm type T33 230V 50Hz 1 phase 0.25kW 0.34HP L 195mm rotation direction left capacitor 5 μ F OLYMPIA		
spare parts for	500519		
	Part No.	365017	Ref. No. —
	operating capacitor capacity 5 μ F 450V tolerance 5% 50/60Hz ambient temperature max. -25 to +85°C \varnothing 28mm L 54mm M8 plastic connection male faston 6.3mm 16.10.08 protection		
	Part No.	510693	Ref. No. —
	mechanical shaft seal for shaft \varnothing 12mm slide ring ext. \varnothing 24mm slide ring H 15.5mm slide ring int. \varnothing 11mm counter ring mounting \varnothing 24mm height counter ring 8mm counter ring int. \varnothing 13.5mm		
	Part No.	521257	Ref. No. —
	impellor \varnothing 80mm H 12mm rotation direction left thread M10R shaft \varnothing 12mm shaft length 7.5mm blades 6		
	Part No.	521553	Ref. No. —
	pump cover OLYMPIA inlet \varnothing 33mm outlet \varnothing 30mm turn direction left \varnothing 103mm ID \varnothing 93mm inner height 25mm		
	Part No.	521723	Ref. No. —
	pump cover gasket EPDM thickness 2mm ID \varnothing 90mm Qty 1 pcs		

drain pumps

PLASET

1

Part No.	500514	Ref. No.	130010
description	drain pump inlet \varnothing 30mm outlet \varnothing 22mm 230V 34W		



gas thermostats





SIT

710 Minisit series



1





Part No.	101132	Ref. No.	671033
description	gas thermostat SIT type MINISIT 710 t.max. 340°C 100-340°C gas inlet 1/2" gas outlet 3/8" thermocouple connection M9x1 pilot connection M10x1 probe ø 5mm probe L 68mm capillary pipe 1050mm probe type type B1 pressure controller no pressure regulator bar gland nut ignition gas no		
spare parts for	101132		
	Part No.	101053	Ref. No. —
	magnet unit T1: M9x1 T2: M24x1 L 45mm ø 17mm suitable for Minisit		
	Part No.	102102	Ref. No. —
	probe 100-340°C probe ø 5mm probe L 68mm capillary pipe 1750mm t.max. 340°C oven/grill probe type type B1 suitable for MINISIT 710		
accessories for	101132		
	Part No.	100809	Ref. No. —
	O-ring EPDM thickness 2mm ID ø 21mm Qty 1 pcs		
	Part No.	100904	Ref. No. —
	locking screw M10x1 for pipe ø 4mm Qty 1 pcs		
	Part No.	100905	Ref. No. —
	locking screw M10x1 for pipe ø 6mm Qty 1 pcs		
	Part No.	101054	Ref. No. —
	magnet unit T1: M10x1 T2: M24x1 L 45mm ø 17mm suitable for Minisit		
	Part No.	101136	Ref. No. —
	piezoelectric igniter suitable for Minisit with cover cap ømm connection F6.3x0.8		
	Part No.	101137	Ref. No. —
	cover cap without piezoelectric igniter		
	Part No.	101267	Ref. No. —
	reducer IT 3/8" ET 1/2" L 21mm		
	Part No.	101268	Ref. No. —
	gas connection thread 3/8" angled with O-ring MINISIT 710		
	Part No.	101269	Ref. No. —
	gas connection thread 1/2" angled with O-ring MINISIT 710		
	Part No.	101270	Ref. No. —
	screw connection IT 3/8" ET 3/8" L 28mm		
	Part No.	101272	Ref. No. —
	screw connection IT 1/2" ET 3/8" L 57mm		

accessories for	101132		
	Part No.	101273	Ref. No. —
	olive for pipe ø 12mm L 9.5mm brass Qty 1 pcs suitable for universal		
	Part No.	101274	Ref. No. —
	olive for pipe ø 16mm Qty 1 pcs		
	Part No.	101275	Ref. No. —
	union screw thread 1/2" for pipe ø 16mm Qty 1 pcs		
	Part No.	101276	Ref. No. —
	union screw thread 3/8" tube ø 12mm Qty 1 pcs		
	Part No.	110068	Ref. No. —
	knob suitable for Minisit ø 37mm		

SABAF



1

Part No.	101692	Ref. No.	671002
description	gas thermostat SABAF t.max. 300°C gas inlet M13x1 IT (tube ø 8mm) bypass nozzle ø 0.5mm gas outlet 3/8" ET (tube ø 10mm) gas outlet 2 thermocouple connection M8x1 pilot connection capillary pipe 850mm probe ø 4mm probe L 140mm shaft ø 8x6.5mm shaft L 34/14mm shaft flat upper		
spare parts for	101692		
	Part No.	101060	Ref. No. —
	magnet unit standard L 39mm D1 ø 15.4mm D2 ø 11mm suitable for PEL20-21/JUNKERS/EGA		
	Part No.	106660	Ref. No. —
	bypass nozzle bore ø 0.85mm thread M4x0.5 SABAF		
	Part No.	106661	Ref. No. —
	bypass nozzle bore ø 0.54mm thread M4x0.5 SABAF		
accessories for	101692		
	Part No.	101277	Ref. No. —
	olive ID ø 8mm Qty 1 pcs		
	Part No.	101278	Ref. No. —
	olive for pipe ø 10mm Qty 1 pcs		
	Part No.	101476	Ref. No. —
	union nut thread M13x1 for pipe ø 8mm		
	Part No.	101478	Ref. No. —
	union nut thread 3/8" for pipe ø 10mm		



ignition parts

pilot burners

SIT











100 series

accessories

pilot burner bottom parts



1

Part No.	107701	Ref. No.	672.094.00
description	pilot burner bottom part SIT 100 series nozzle \varnothing 0.2mm		
spare parts for	107701		
	Part No.	100245	Ref. No. —
	pilot burner nozzle LPG code 20 bore \varnothing 0.2mm Qty 1 pcs thread M8x0.75		
	Part No.	100916	Ref. No. —
	compression spring for pilot burner Qty 1 pcs		
	Part No.	100917	Ref. No. —
	gasket for pilot burner Qty 1 pcs aluminium		
	Part No.	100918	Ref. No. —
	screw for pilot burner		
accessories for	107701		
	Part No.	100246	Ref. No. —
	pilot burner nozzle natural gas bore \varnothing 0.35mm Qty 1 pcs thread M8x0.75		
	Part No.	100904	Ref. No. —
	locking screw M10x1 for pipe \varnothing 4mm Qty 1 pcs		
	Part No.	100905	Ref. No. —
	locking screw M10x1 for pipe \varnothing 6mm Qty 1 pcs		
	Part No.	102110	Ref. No. —
	pilot tube copper pipe \varnothing 4mm thickness 1mm L 3000mm		
	Part No.	102111	Ref. No. —
	pilot tube copper pipe \varnothing 6mm thickness 1mm L 3000mm		
	Part No.	102742	Ref. No. —
	pilot burner nozzle LPG code 25 bore \varnothing 0.25mm Qty 1 pcs		

miscellaneous



1

Part No.	100967	Ref. No.	623241
description	pilot burner bracket		

160 series



1















Part No.	100056	Ref. No.	672042
description	pilot burner SIT type 160 series 3 flames nozzle \varnothing mm gas connectionmm		
spare parts for	100056		
	Part No.	100907	Ref. No. —
	screw connection thread M10x1 Qty 1 pcs type SEF 1 \varnothing mm for thermocouple		
accessories for	100056		
	Part No.	100202	Ref. No. —
	pilot burner nozzle natural gas code 41 Qty 1 pcs nozzle \varnothing 0.41mm		
	Part No.	100203	Ref. No. —
	pilot burner nozzle LPG code 25 Qty 1 pcs nozzle \varnothing 0.25mm		
	Part No.	100701	Ref. No. —
	ignition electrode connection M4 Qty 1 pcs		
	Part No.	100801	Ref. No. —
	gasket for pilot burner Qty 1 pcs		
	Part No.	100869	Ref. No. —
	pilot burner nozzle natural gas code 51 Qty 1 pcs suitable for 160 series nozzle \varnothing 0.51mm		
	Part No.	100870	Ref. No. —
	olive for pipe \varnothing 4mm Qty 1 pcs suitable for 160 series for pilot burner		
	Part No.	100906	Ref. No. —
	screw connection thread M10x1 for ignition electrode brass Qty 1 pcs WS 10		
	Part No.	100908	Ref. No. —
	union screw thread M10x1 for pipe \varnothing 4mm Qty 1 pcs		
	Part No.	100909	Ref. No. —
	union screw thread M10x1 for pipe \varnothing 6mm Qty 1 pcs		
	Part No.	101287	Ref. No. —
	olive for pipe \varnothing 6mm Qty 1 pcs		
	Part No.	102110	Ref. No. —
	pilot tube copper pipe \varnothing 4mm thickness 1mm L 3000mm		

Table continues overleaf



accessories for	100056			
	Part No.	102111	Ref. No.	—
	pilot tube copper pipe ϕ 6mm thickness 1mm L 3000mm			
	Part No.	107650	Ref. No.	674052
	pilot burner nozzle SIT LPG code 30 Qty 1 pcs			

electrodes

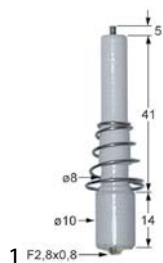

Part No.	100729	Ref. No.	672005
description	ignition electrode L1 5mm D1 ϕ 8mm D2 ϕ 10mm BL1 41mm BL2 14mm connection F 2.8x0.8mm to clip with spring		

thermocouples

threaded thermocouples

threaded thermocouples standard

with socket with thread M8x1

SIT

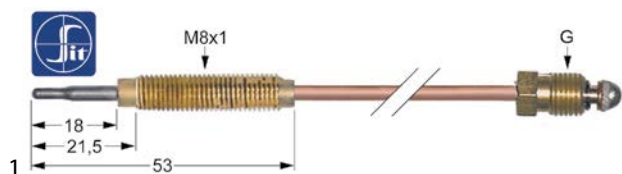

Part No.	107636	Ref. No.	672000	
description	thermocouple SIT M9x1 L 600mm M8x1			
accessories for	107636			
	Part No.	102067	Ref. No.	—
	nut thread M8x1 H 3mm brass Qty 1 pcs type SEF 1			

gas burners

hob burners

accessories

pan supports



1				
Part No.	210132	Ref. No.	681008	
description	pan support W 340mm L 570mm suitable for 700 series			
accessories for	210132			
	Part No.	210050	Ref. No.	—
	reducer for pan support L 260mm W 260mm chrome-plated steel suitable for universal			



1			
Part No.	210137	Ref. No.	681019
description	pan support W 400mm L 400mm suitable for 900 series		

air mixers













1				
Part No.	103127	Ref. No.	672016	
description	air mixing sleeve L 36mm ED ϕ 40mm ID ϕ 36mm aluminium			
accessories for	103127			
	Part No.	103118	Ref. No.	672044
	burner cap ϕ 61mm			
	Part No.	103119	Ref. No.	672051 672098
	burner ring for burner cap ϕ 61mm			
	Part No.	103120	Ref. No.	—
	burner head for burner cap ϕ 61mm			
	Part No.	103121	Ref. No.	672010
	venturi			
	Part No.	103122	Ref. No.	673020
	burner holder ϕ 35mm H 82mm nozzle mounting M10x1 mounting distance 55mm connection M16x1.5mm with nozzle holder			
	Part No.	103124	Ref. No.	672101
	burner head E ϕ 150mm for burner cap ϕ 110mm 7.5kW code 672.077 A			
	Part No.	103125	Ref. No.	672079
	burner cap D ϕ 110mm 5.5kW bore ϕ 2.6mm with central hole			

Table continues overleaf



accessories for		103127	
	Part No.	103126	Ref. No. 672093
burner cap E ø 110mm 7.5kW bore ø 3mm with central hole			
	Part No.	105067	Ref. No. —
burner cap C ø 84mm 3.5kW			
	Part No.	105069	Ref. No. 672076
burner head C for burner cap ø 84mm 3.5kW			
	Part No.	105070	Ref. No. —
burner head D ø 150mm for burner cap ø 110mm 5.5kW code 672.077 E			

bar burners

bar burners



1

Part No.	104174	Ref. No.	672052
description	bar burner 2 row L 485mm W 240mm ømm H 170mm gril		



1

Part No.	104173	Ref. No.	672029
description	bar burner 3 row L 507mm W 240mm ømm H 50mm griddle		



1

Part No.	104171	Ref. No.	672030
description	bar burner angled L 450mm W 185mm ømm Hmm oven		

tube burners



1

Part No.	104172	Ref. No.	672031
description	tubular burner ø 74mm L 180mm H 60mm round for fryer		

gas nozzles

pilot burner nozzles

pilot burner nozzles SIT

160 series



1

Part No.	107650	Ref. No.	674052
description	pilot burner nozzle SIT LPG code 30 Qty 1 pcs		

equipment-specific units

for dishwashers

drain and intake components

miscellaneous

filters



1

Part No.	517019	Ref. No.	130075
description	round filters		

containers

dosing containers



1

Part No.	517380	Ref. No.	131051
description	cleaner container L 94mm W 80mm H 130mm suitable for Dihr		



salt tanks



1

Part No.	524177	Ref. No.	130975 16067/D
description	lid ø 69mm H 20mm for salt tank ID ø 50mm		
accessories for	524177		
	Part No.	524148	Ref. No. —
	O-ring EPDM thickness 3.53mm ID ø 40.86mm Qty 1 pcs		

boilers

boilers for dishwashers



1

Part No.	517302	Ref. No.	130066
description	boiler with insulation ø 160mm L 500mm		
accessories for	517302		
	Part No.	517337	Ref. No. —
	insulating mat boiler ø 160mm		

housing and bezels

miscellaneous



1

Part No.	524803	Ref. No.	131197
description	bracket for dishwasher rack SS L 25mm ED ø 10mm thread M6		

air traps

air traps



1

Part No.	517171	Ref. No.	130025
description	air trap L 90mm W 55mm H 31mm		
accessories for	517171		
	Part No.	517173	Ref. No. —
	flat gasket FIBER ED ø 14mm ID ø 8mm thickness 1.5mm Qty 1 pcs		

accessories for 517171



Part No.	517174	Ref. No.	—
	nut thread M8 H 6.5mm WS 13 SS DIN/ISO DIN 934 / ISO 4032/8673 Qty 1 pcs		

backflow preventers

backflow preventers



1

Part No.	506210	Ref. No.	150077
description	backflow preventer dishwasher		

miscellaneous

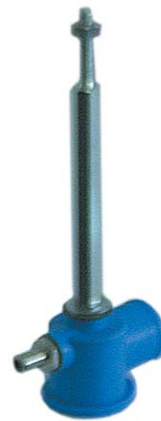

1



Part No.	517018	Ref. No.	130057
description	supply tube complete		

door mechanics



hinges





1

Part No.	517267	Ref. No.	130955
description	door hinge hinge mounting pos. left		
accessories for	517267		
	Part No.	517266	Ref. No. 130953
	door hinge hinge mounting pos. right		
	Part No.	517268	Ref. No. —
	bush ID ø 8mm H 9mm bush thread M11x1 WS 13		





 <p>1</p>			
Part No.	517266	Ref. No.	130953
description	door hinge hinge mounting pos. right		
accessories for	517266		
 <p>door hinge hinge mounting pos. left</p>			
Part No.	517267	Ref. No.	130955
 <p>bush ID ø 8mm H 9mm bush thread M11x1 WS 13</p>			
Part No.	517268	Ref. No.	—



screw connections			
 <p>1</p>			
Part No.	511919	Ref. No.	150061
description	quick-fit retaining nut		

washing and rinsing systems			
 <p>1</p>			
Part No.	517012	Ref. No.	130047
description	bush		

 <p>1</p>			
Part No.	504370	Ref. No.	131040
description	cover for rinse arm shaft mounting pos. lower H 102mm D1 ø 27.5mm D2 ø 30mm L1 32mm L2 59mm ID ø 25mm		

 <p>1</p>			
Part No.	517154	Ref. No.	130818
description	nut mounting pos. upper for wash arm support		

 <p>1</p>			
Part No.	517016	Ref. No.	130813
description	rinse arm shaft		

 <p>1</p>			
Part No.	517143	Ref. No.	130659
description	rinse arm support mounting pos. upper		
accessories for	517143		
 <p>Thumb screw thread M8 thread L 8mm ø 30mm H 3mm SS mounting pos. upper</p>			
Part No.	517066	Ref. No.	—

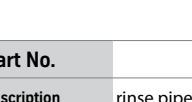
 <p>1</p>			
Part No.		Ref. No.	130678
description	rinse pipe		

 <p>1</p>			
Part No.	517126	Ref. No.	130965
description	rinse pipe		

 <p>1</p>			
Part No.	517140	Ref. No.	131216
description	rinse pipe mounting pos. lower		

 <p>1</p>			
Part No.	517139	Ref. No.	131219
description	throttle disc		



1			
Part No.	517014	Ref. No.	131099
description	wash pipe SS		

gaskets

gaskets for heated units

door seals with tension springs



1			
Part No.	514001	Ref. No.	260003
description	spring L 655mm for gasket mounting pos. upper		

O-rings

EPDM

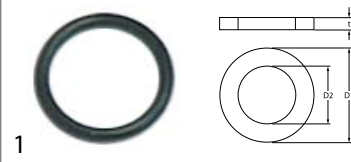

1			
Part No.	510302	Ref. No.	131036
description	O-ring EPDM ID ø 12.42mm thickness 1.78mm Qty 1 pcs		

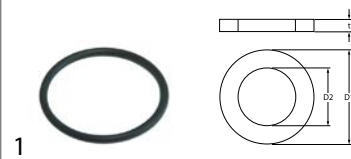

1			
Part No.	517004	Ref. No.	130554
description	O-ring EPDM thickness 2.62mm ID ø 34.6mm Qty 1 pcs		

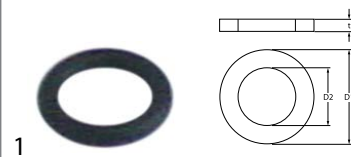

1			
Part No.	517056	Ref. No.	130603
description	O-ring EPDM thickness 2mm ID ø 6.5mm Qty 1 pcs		

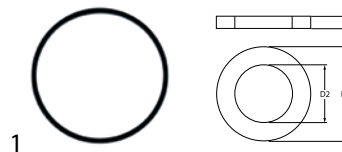

1			
Part No.	510009	Ref. No.	150060
description	O-ring EPDM thickness 3.53mm ID ø 101.2mm Qty 1 pcs		



1			
Part No.	510408	Ref. No.	0835534701 107000 130040
description	O-ring EPDM thickness 5.34mm ID ø 47mm Qty 1 pcs		

miscellaneous

1

Part No.		Ref. No.	130555
description	O-ring		

sealing washers

fibre gaskets



1			
Part No.	510730	Ref. No.	150130
description	flat gasket fibre ED ø 25mm ID ø 12mm thickness 2mm Qty 1 pcs		



dosing pumps



membrane dosing pumps

self-priming with supporting pressure

DIHR



1







Part No.	361744	Ref. No.	130997
description	dosing pump type DW with auxiliary pressure connection rinse aid inlet 4mm outlet 8mm suction connection \varnothing 4mm auxiliary pressure connection 10mm		
spare parts for	361744		
	Part No.	520026	Ref. No. —
	PVC hose ID \varnothing 4mm ED \varnothing 6mm L 10m thickness 1mm t.max. 60°C transparent		
	Part No.	520090	Ref. No. —
	PVC hose ID \varnothing 4mm ED \varnothing 6mm L 2m thickness 1mm t.max. 60°C transparent		





GERMAC

type 2000



1

Part No.	361536	Ref. No.	150331
description	dosing pump type 2000 rinse aid inlet 4x6mm outlet 8mm suction connection \varnothing 4x6mm supporting pressure 11mm rebound ball PTFE 1mm GERMAC CODE VNR/D3		
spare parts for	361536		
	Part No.	361550	Ref. No. —
	hose connector hose \varnothing 4x6mm		
	Part No.	361551	Ref. No. —
	compression spring wire gauge \varnothing 1mm		
	Part No.	361701	Ref. No. —
	hose connector thread M10x1 grommet \varnothing 7.5mm		
	Part No.	361705	Ref. No. —
	gasket for hose connector M12x1		
	Part No.	510298	Ref. No. —
	lip valve dosing pump suitable for DB2/DS5		
accessories for	361536		
	Part No.	361553	Ref. No. —
	membrane EPDM		
	Part No.	361700	Ref. No. —
	hose connector rotary hose \varnothing 4x6mm plastic connection M10x1		

accessories for	361536		
	Part No.	361702	Ref. No. —
	hose connector brass hose \varnothing 4x6mm		
	Part No.	361703	Ref. No. —
	hose connector thread M10x1 brass pipe connection \varnothing 4x6mmmm		
	Part No.	361704	Ref. No. —
	hose connector brass straight thread M12x1 hose \varnothing 11mm Qty 1 pcs		
	Part No.	510296	Ref. No. —
	membrane silicone		
	Part No.	520022	Ref. No. —
	PVC hose ID \varnothing 8mm ED \varnothing 12mm L 10m thickness 2mm t.max. 60°C transparent		

hoses

drain hoses



1

Part No.	508043	Ref. No.	150062
description	drain hose DN19 L 2000mm straight \varnothing inside 19/30mm straight ext. \varnothing 26/34mm outer hose \varnothing 25mm		

formed hoses

form U



1

Part No.	517252	Ref. No.	131008
description	formed hose ext. \varnothing 35 D1 \varnothing 28mm D2 \varnothing 28mm warewashing U-shape		

fittings, hose and pipe connectors

fittings

double nipples



1

Part No.	517005	Ref. No.	130550
description	double nipple		

hose connectors

producer-specific



1

Part No.	691661	Ref. No.	150073
description	angle piece thread M12x1 for hose ID 12mm		

measuring equipment

thermometers

built-in thermometers



1

Part No.	541095	Ref. No.	130060
description	thermometer mounting measurements 58x25.5mm 0 up to +120°C capillary pipe 3000mm probe ø 6.5mm probe L 20mm		

fastening material

screws

knurled screws



1

Part No.	517075	Ref. No.	131447
description	Thumb screw thread M8 SS ø 30mm H 3mm thread L 8mm		

nuts

hexagonal nuts

hexagonal nuts inch thread



1

Part No.	520499	Ref. No.	130620
description	nut thread 1¼" H 6mm WS 50 brass Qty 1 pcs		

GASTROPARTS.COM

