



GASTROPARTS

Movilfrit

- [EN]** Equipment
- [DE]** Geräte
- [ES]** Aparatos
- [FR]** Équipement
- [IT]** Attrezzature
- [PL]** Urządzenia
- [RU]** Оборудование

✉ gastroparts@gastroparts.com

☎ tel. +48 56 657 00 66

📘 fb.com/gastroparts.global

GASTROPARTS.COM





heating elements

heating elements for fryers

2 hole fixing

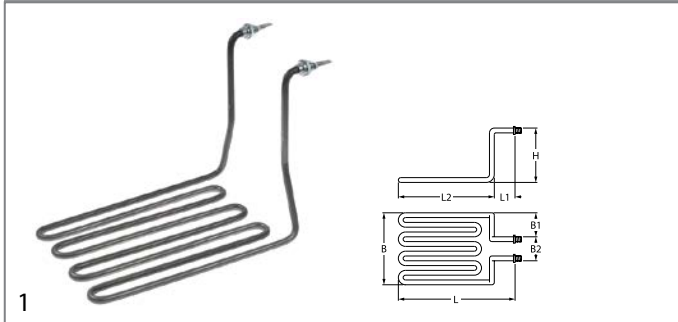

Part No.	417705	Ref. No.	901690
description	heating element 4000W 230V heating circuits 1 L 290mm W 177mm H 205mm fryer heaters L1 55mm L2 260mm W1 40mm W2 125mm tube ø 8.5mm		

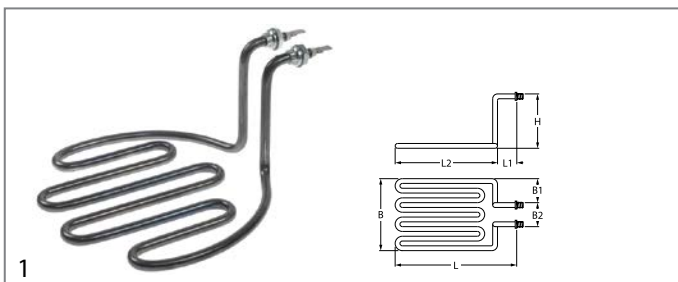

Part No.	417704	Ref. No.	901701
description	heating element 2000W 230V heating circuits 1 L 240mm W 195mm H 105mm 2 hole fixing fryer heaters L1 60mm L2 180mm W2 50mm		

heaters



Part No.	970937	Ref. No.	907024
description	heater fryer 4000W 230V heating circuits 1 t.max. 200°C 60-200°C L 385mm W 245mm H 340mm cable length 1300mm F10		



Part No.	970936	Ref. No.	907023
description	heater fryer 4000W 230V heating circuits 1 t.max. 200°C 60-200°C L 390mm W 245mm H 290mm cable length 1300mm FA9		

thermostats

control and safety thermostats

EGO

control thermostats

56._ series

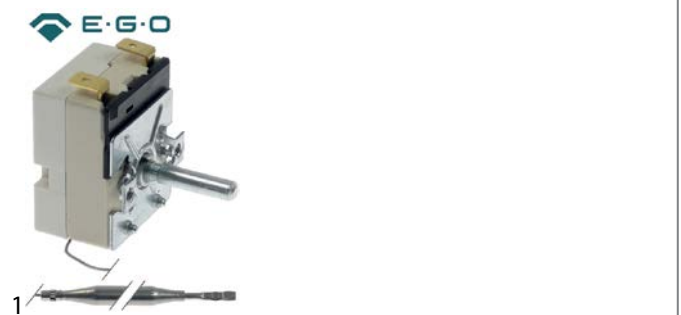

Part No.	376076	Ref. No.	907110
description	thermostat t.max. 200°C temperature range 60-200°C 16A probe ø 6mm probe L 78mm capillary pipe 870mm		

IMIT / TEMPOMATIC / ARTHERMO

safety thermostats



Part No.	375941	Ref. No.	901770
description	safety thermostat switch-off temp. 238°C 1-pole 1NC 16A probe ø 5mm probe L 100mm capillary pipe 1050mm capillary pipe isolated-mm gland nut 250V		

→ electric components



switches and momentary switches

rotary switches

producer-specific rotary switches

GAVE



1

Part No.	305003	Ref. No.	901405
description	rotary switch 0-1 latching ON-OFF 32A shaft ø 5x5mm shaft L 21.5mm		



1

Part No.	305000	Ref. No.	901404
description	rotary switch 0-1 latching ON-OFF 40A shaft ø 5x5mm shaft L 20mm		

lamps

indicator lights

indicator lights (complete)

ø10mm

with screw socket



1

Part No.	359529	Ref. No.	901582
description	indicator light ø 10mm 400V clear connection male faston 6.3mm socket screw base		

with plug-in socket



1

Part No.	359020	Ref. No.	901581
description	indicator light ø 10mm red 400V connection male faston 6.3mm Qty 1 pcs		



1

Part No.	359034	Ref. No.	901580
description	indicator light ø 10mm yellow 400V connection male faston 6.3mm Qty 1 pcs		

1

Part No.		Ref. No.	901583
description	indicator light ø 10mm red 230V cable length 200mm plastic fryer for MOD.5		

30x13mm



1

Part No.	346547	Ref. No.	901572
description	indicator light mounting measurements 27.4x12.4mm 230V red connection male faston 6.3mm temp.-resist. 120°C		

contactors

ABB

power contactors



1

Part No.	381441	Ref. No.	901155
description	power contactor resistive load 25A 250-500V AC/DC (AC3/400V) 8A/5.5kW main contacts 3NO auxiliary contacts 1NC connection screw connection type AF09-30-01-14		

electric accessories

cables

power supply cables



1

Part No.	551343	Ref. No.	901055
description	power lead CEE7/7 type E+F 3-pole contacts P+N+E 1.5mm² max. 16A max 230V 1.5m H05VV-F 3G1.5		



accessories

cable glands

threaded cable glands

screw connections



1

Part No.	551344	Ref. No.	901620
description	cable gland thread PG11 cable ø 10mm mounting ø 18mm WS 22 plastic Qty 1 pcs		



1

Part No.	551345	Ref. No.	901622
description	cable gland thread PG21 cable ø 18mm mounting ø 28.5mm WS 33 plastic Qty 1 pcs		

equipment-specific units

for deep fryers

spouts



1

Part No.	696740	Ref. No.	907088
description	drain pipe complete ø 20mm L 175mm W 55mm H 30mm		

fasteners



1

Part No.	970942	Ref. No.	905329
description	bracket L 12mm W 10mm H 10mm Mod.10		



1

Part No.	970945	Ref. No.	905029
description	bracket probes hole distance 21mm L 55mm W 15mm H 10mm MOD.35		



1

Part No.	970944	Ref. No.	905030
description	bracket probes distance 34mm L 66mm W 15mm H 10mm MOD.17 TRIFASICO		



1

Part No.	970941	Ref. No.	905028
description	bracket probes L 28mm W 8mm H 13mm MOD.4/6/9/10/17/25		



1

Part No.	970943	Ref. No.	905036
description	bracket probes L 32mm W 8mm H 13mm MOD.5		



1

Part No.	970940	Ref. No.	905420
description	fixing support fryer L 125mm W 30mm H 83mm		

lids



1

Part No.	907000	Ref. No.	905116
description	lid plastic for fryer H 10mm ø 235mm black		

housing and bezels

1

Part No.		Ref. No.	905361
description	base for fryer H 65mm ø 235mm plastic black		



			
1			
Part No.	699256	Ref. No.	905451
description	cover fryer L 117mm W 73mm H 23mm MOD.5		

lifting device			
couplings			
			
1			
Part No.	973123	Ref. No.	908104
description	coupling ED ø 32mm ID ø 11mm thickness 12mm		

level glasses			
			
1			
Part No.	692713	Ref. No.	907103
description	level glass ø 65mm ID ø 32mm thickness 18mm for MOD.25/35 with adapter adapter ø 90mm		

			
1			
Part No.	692712	Ref. No.	907032
description	level glass ø 65mm ID ø 33mm thickness 18mm for MOD.10/17/25/35		

knobs

producer-specific knobs

MOVILFRIT			
			
1			
Part No.	112805	Ref. No.	901504
description	knob thermostat t.max. 200°C 60-200°C ø 50mm shaft ø 6x4.6mm shaft flat upper black thermostat		

accessories

fascias

			
1			
Part No.	112804	Ref. No.	901510
description	bezel with knob t.max.°C°C switch 0-1 ø 47mm dimensions 65x65mm 0-1		

baskets

fryer baskets

MOVILFRIT			
baskets			
			
1			
Part No.	970768	Ref. No.	907043
description	fryer basket BH 160mm overall height 215mm W 330mm total length 445mm stainless steel		

			
1			
Part No.	970933	Ref. No.	907038
description	fryer basket H 130mm W 183mm L 260mm stainless steel		

			
1			
Part No.	970932	Ref. No.	907041
description	fryer basket H 140mm W 205mm L 297mm stainless steel		

			
1			
Part No.	970934	Ref. No.	907047
description	fryer basket H 143mm W 210mm L 285mm stainless steel BH 90mm		



1 

Part No.	970931	Ref. No.	907042
description	fryer basket H 144mm W 235mm L 340mm stainless steel		

1 

Part No.	970935	Ref. No.	907044
description	fryer basket H 160mm W 210mm L 270mm stainless steel BH 110mm		

handles

1 

Part No.	970948	Ref. No.	907081
description	handle L 145mm W 66mm H 105mm handle length 135mm handle material plastic		

1 

Part No.	970938	Ref. No.	907085
description	handle W 40mm H 20mm handle length 135mm handle material plastic		

1 

Part No.	970939	Ref. No.	907080
description	handle W 40mm H 25mm handle length 125mm handle material plastic		

crumb screens

1

Part No.		Ref. No.	901099
description	crumb screen ø 197mm H 172mm stainless steel BH 70mm		

gaskets

sealing washers

fibre gaskets

1 

Part No.	504431	Ref. No.	908252
description	flat gasket FIBER ED ø 12mm ID ø 6mm thickness 2mm Qty 1 pcs		

paper gasket

1 

Part No.	512486	Ref. No.	905225
description	flat gasket paper ED ø 10mm ID ø 5mm thickness 2mm fryer		

special gaskets

for deep fryers

1 

Part No.	530784	Ref. No.	908255
description	flat gasket ED ø 38mm thickness 3.5mm ID ø 26mm fibre outflow fryer		

1 

Part No.	530785	Ref. No.	908257
description	flat gasket ED ø 40mm thickness 2mm level glass fibre fryer ID ø 34mm		



			
1			
Part No.	530783	Ref. No.	908251
description	flat gasket ED ø 62mm thickness 2.5mm drain system fibre fryer		

			
1			
Part No.	530786	Ref. No.	908253
description	flat gasket ED ø 69mm thickness 4mm level glass fibre fryer ID ø 37mm for MOD.10/17/25/35		

			
1			
Part No.	512486	Ref. No.	905225
description	flat gasket paper ED ø 10mm ID ø 5mm thickness 2mm fryer		

valves and tank inlets

ball valves

universal

mini ball valves

			
1			
Part No.	520962	Ref. No.	901371
description	ball valve connection 3/4" ET - 3/4" IT total length 53mm		

fastening material

screws

oval head screws

			
1			
Part No.	560595	Ref. No.	908701
description	oval head screw thread M5 thread L 16mm L 19mm head ø 12.5mm ø 5mm		

hexagonal screws

			
1			
Part No.	560079	Ref. No.	908501
description	hexagonal screw thread M6 thread L 12mm SS WS 10 Qty 20 pcs DIN 933 / ISO 4017		

nuts

hexagonal nuts

DIN 934 / ISO 4032/8673

			
1			
Part No.	560129	Ref. No.	908761
description	hexagonal nut thread M5 H 4mm WS 8 SS DIN/ISO DIN 934 / ISO 4032/8673 Qty 1 pcs		

GASTROPARTS.COM

