



GASTROPARTS

Morice

[EN] Equipment

[DE] Geräte

[ES] Aparatos

[FR] Équipement

[IT] Attrezzature

[PL] Urządzenia

[RU] Оборудование

✉ gastroparts@gastroparts.com

☎ tel. +48 56 657 00 66

📘 fb.com/gastroparts.global





GASTROPARTS.COM









heating elements

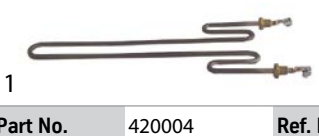

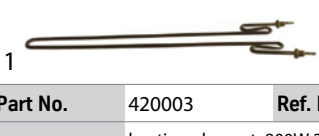

heating elements for ovens

			
Part No.	418453	Ref. No.	RS0889
description	heating element 1150W 230V heating circuits 1 L 735mm W 128mm L1 75mm L2 660mm thread M12x1 mounting distance 119mm tube ø 8.6mm connection length 36mm 2 hole fixing connection M4 dry heating element		
accessories for	418453		
	Part No.	520229	Ref. No. —
	nut thread M12x1 H 4mm WS 16 zinc-coated steel Qty 1 pcs		
	Part No.	521110	Ref. No. —
	flat gasket fibre ED ø 20mm ID ø 13mm thickness 2mm Qty 1 pcs		
	Part No.	521131	Ref. No. —
	nut thread M12x1 H 3.5mm WS 17 SS Qty 1 pcs		
	Part No.	528110	Ref. No. —
	O-ring EPDM thickness 2.62mm ID ø 12.37mm Qty 1 pcs		

			
Part No.	420004	Ref. No.	RS0886
description	heating element 666W 230V heating circuits 1 L 345mm W 115mm L1 70mm L2 273mm thread M12x1 mounting distance 104mm tube ø 8.8mm 2 hole fixing connection M4 dry heating element		
accessories for	420004		
	Part No.	511508	Ref. No. —
	O-ring EPDM thickness 2.62mm ID ø 12.37mm Qty 10 pcs		
	Part No.	520229	Ref. No. —
	nut thread M12x1 H 4mm WS 16 zinc-coated steel Qty 1 pcs		
	Part No.	521110	Ref. No. —
	flat gasket fibre ED ø 20mm ID ø 13mm thickness 2mm Qty 1 pcs		
	Part No.	521131	Ref. No. —
	nut thread M12x1 H 3.5mm WS 17 SS Qty 1 pcs		

			
Part No.	420003	Ref. No.	RS0888
description	heating element 800W 230V heating circuits 1 L 545mm W 110mm L1 80mm L2 263mm thread M12x1 mounting distance 102mm tube ø 8.5mm 2 hole fixing connection grip connection dry heating element		

heating elements for bain maries

			
Part No.	420012	Ref. No.	RS0905
description	heating element 850W 230V heating circuits 1 L 420mm W 40mm connection M5 tube ø 6.5mm 2 hole fixing thread M12x1 immersion heater mounting distance 34mm		
accessories for	420012		
	Part No.	511508	Ref. No. —
	O-ring EPDM thickness 2.62mm ID ø 12.37mm Qty 10 pcs		
	Part No.	520229	Ref. No. —
	nut thread M12x1 H 4mm WS 16 zinc-coated steel Qty 1 pcs		
	Part No.	521110	Ref. No. —
	flat gasket fibre ED ø 20mm ID ø 13mm thickness 2mm Qty 1 pcs		
	Part No.	521131	Ref. No. —
	nut thread M12x1 H 3.5mm WS 17 SS Qty 1 pcs		

heating elements for frying pans

			
Part No.	419118	Ref. No.	RS0878
description	heating element 2400W 230V heating circuits 1 L 365mm W 200mm connection M4 tube ø 10mm dry heating element for frying pan H 98mm connection distance 70mm		

			
Part No.	420258	Ref. No.	RS0960
description	heating element 5500W 230V heating circuits 1 L 560mm W 185mm connection M4 tube ø 10mm dry heating element for frying pan H 48mm connection distance 170mm		



heating elements for fryers



Part No.	419123	Ref. No.	RS0863 RS0965 RS965
description	heating element 1100W 230V heating circuits 1 L 323mm W 9mm H 255mm rectangular flange connection M4 dry heating element H1 208mm H2 47mm tube ø 6.5mm		

heating elements for griddles



Part No.	420010	Ref. No.	RS0911
description	heating element 1200W 230V heating circuits 1 L 400mm W 70mm tube ø 6.3mm 2 hole fixing connection M4 mounting distance 64mm gril dry heating element		



Part No.	420008	Ref. No.	RS0856
description	heating element 2000W 230V heating circuits 1 L 535mm W 90mm H 74mm tube ø 10mm W1 13mm W2 56mm connection M4 griddle connection distance 46mm dry heating element		



Part No.	420009	Ref. No.	RS0864
description	heating element 2250W 230V heating circuits 1 L 590mm W 110mm tube ø 6.5mm 2 hole fixing connection M4 thread M12x1 mounting distance 104mm gril dry heating element		

accessories for 420009

	Part No.	511508	Ref. No.	—
	O-ring EPDM thickness 2.62mm ID ø 12.37mm Qty 10 pcs			
	Part No.	520229	Ref. No.	—
	nut thread M12x1 H 4mm WS 16 zinc-coated steel Qty 1 pcs			
	Part No.	521110	Ref. No.	—
	flat gasket fibre ED ø 20mm ID ø 13mm thickness 2mm Qty 1 pcs			
	Part No.	521131	Ref. No.	—
	nut thread M12x1 H 3.5mm WS 17 SS Qty 1 pcs			

heating elements for tilting bratt pan



Part No.	420256	Ref. No.	RS0909
description	heating element 1000W 230V L 460mm W 100mm H 64mm connection M4 dry heating element heating circuits 1 tube ø 6.3mm 2 hole fixing connection distance 94mm		



Part No.	420257	Ref. No.	RS0898
description	heating element 2000W 230V L 445mm W 100mm H 72mm connection M4 dry heating element tube ø 10mm W1 8mm W2 81mm 2 hole fixing connection distance 71mm		

heating elements for pasta cookers



Part No.	420214	Ref. No.	RS0935
description	heating element 5000W 240V heating circuits 3 L 375mm W 57mm H 59mm flange tube ø 6.5mm thermostat sleeves ø 7mm length thermostat sleeves 200mm mounting ø 96mm number of thermostat sleeves 1 for pasta cooker thermostat sleeve eccentric, non clinging immersion heater		

heating elements for pizza ovens



Part No.	420260	Ref. No.	RS0921
description	heating element 400W 230V L 640mm W 49mm thread M12x1 mounting distance 42mm connection M4 tube ø 6.5mm heating circuits 1 dry heating element 2 hole fixing for pizza oven		



Part No.	418456	Ref. No.	RS0922
description	heating element 650W 230V L 707mm W 80mm thread 1/4" mounting distance 68mm connection length 22mm connection M5 tube ø 8.5mm heating circuits 1 dry heating element 2 hole fixing		





accessories for 418456

	Part No.	361182	Ref. No.	—
	nut thread 1/4" H 5mm nickel-plated brass WS 17 Qty 1 pcs			
	Part No.	510417	Ref. No.	—
	flat gasket fibre ED ø 20mm ID ø 14mm thickness 2mm Qty 1 pcs			
	Part No.	520228	Ref. No.	—
	tooth lock washer ID ø 15.3mm ED ø 24mm steel Qty 1 pcs for thread M14			
	Part No.	550262	Ref. No.	—
	flat gasket copper ED ø 20mm ID ø 14mm thickness 2mm			

Part No.	419120	Ref. No.	RS0927
description	heating element 650W 400V L 700mm W 73mm thread M12x1 mounting distance 65mm connection M4 tube ø 8mm heating circuits 1 dry heating element pizza oven		







Part No.	418455	Ref. No.	RS0923
description	heating element 750W 230V heating circuits 1 L 937mm W 80mm thread 1/4" mounting distance 72mm tube ø 8.5mm dry heating element 2 hole fixing connection length 34mm		
accessories for	418455		
	Part No.	361182	Ref. No. —
	nut thread 1/4" H 5mm nickel-plated brass WS 17 Qty 1 pcs		
	Part No.	510417	Ref. No. —
	flat gasket fibre ED ø 20mm ID ø 14mm thickness 2mm Qty 1 pcs		
	Part No.	520228	Ref. No. —
	tooth lock washer ID ø 15.3mm ED ø 24mm steel Qty 1 pcs for thread M14		
	Part No.	550262	Ref. No. —
	flat gasket copper ED ø 20mm ID ø 14mm thickness 2mm		



Part No.	419121	Ref. No.	RS0928
description	heating element 750W 400V L 930mm W 73mm thread M12x1 mounting distance 65mm connection M4 tube ø 8mm heating circuits 1 dry heating element 2 hole fixing pizza oven		

heating elements for salamanders/toast-



Part No.	420011	Ref. No.	RS0867
description	heating element 2000W 230V L 385mm W 210mm 2 hole fixing thread M10x1 mounting distance 200mm connection M5 dry heating element tube ø 6.3mm heating circuits 1		
accessories for	420011		
	Part No.	510416	Ref. No. —
	flat gasket fibre ED ø 19mm ID ø 10.5mm thickness 1.5mm for thread M10 Qty 1 pcs		
	Part No.	520231	Ref. No. —
	nut thread M10x1 H 6mm WS 14 zinc-coated steel Qty 1 pcs		
	Part No.	521129	Ref. No. —
	nut thread M10 H 6mm SS WS 17 Qty 1 pcs DIN/ISO DIN 439		
	Part No.	532049	Ref. No. —
	O-ring EPDM thickness 2.62mm ID ø 9.92mm Qty 10 pcs		



Part No.	419126	Ref. No.	RS0920
description	heating element 2000W 400V heating circuits 1 L 340mm W 205mm H 45mm thread M12x1 mounting distance 197mm tube ø 8mm connection M4 2 hole fixing dry heating element salamander grill		



heating rods



Part No.	418459	Ref. No.	RS0859
description	heating element 1000W 240V connection M5 L 630mm W 38mm H 8mm hole distance 650mm hole ø 8mm		

coil heating elements



Part No.	418395	Ref. No.	RS0881 RS0969
description	heating element 1000W 230V L 513mm W 50mm H 25mm tube ø 8.5mm thread M14x1 connection M4 connection length 18mm dry heating element heating circuits 1 2 hole fixing		
accessories for	418395		
	Part No.	510417	Ref. No. —
	flat gasket fibre ED ø 20mm ID ø 14mm thickness 2mm Qty 1 pcs		
	Part No.	520228	Ref. No. —
	tooth lock washer ID ø 15.3mm ED ø 24mm steel Qty 1 pcs for thread M14		
	Part No.	550261	Ref. No. —
	nut thread M14x1 H 4mm WS 19 SS Qty 1 pcs		









Part No.	418396	Ref. No.	RS0892
description	heating element 1500W 230V L 765mm W 50mm H 25mm tube ø 8.5mm thread M14x1.5 connection 1/8" connection length 20mm dry heating element heating circuits 1 2 hole fixing		
accessories for	418396		
	Part No.	510417	Ref. No. —
	flat gasket fibre ED ø 20mm ID ø 14mm thickness 2mm Qty 1 pcs		
	Part No.	520228	Ref. No. —
	tooth lock washer ID ø 15.3mm ED ø 24mm steel Qty 1 pcs for thread M14		
	Part No.	520230	Ref. No. —
	nut thread M14x1.5 H 5mm WS 19 zinc-coated steel Qty 1 pcs		





Table continues overleaf



accessories for	418396			
	Part No.	521101	Ref. No.	—
	nut thread M14x1.5 H 5mm WS 19 SS Qty 1 pcs			
	Part No.	550262	Ref. No.	—
	flat gasket copper ED ø 20mm ID ø 14mm thickness 2mm			

	1		
Part No.	418393	Ref. No.	RS0880
description	heating element 500W 230V L 305mm W 50mm H 25mm tube ø 8.5mm thread M14x1.5 connection M4 dry heating element heating circuits 1 2 hole fixing		

spare parts for	418393			
	Part No.	510417	Ref. No.	—
	flat gasket fibre ED ø 20mm ID ø 14mm thickness 2mm Qty 1 pcs			

accessories for	418393			
	Part No.	520228	Ref. No.	—
	tooth lock washer ID ø 15.3mm ED ø 24mm steel Qty 1 pcs for thread M14			
	Part No.	520230	Ref. No.	—
	nut thread M14x1.5 H 5mm WS 19 zinc-coated steel Qty 1 pcs			
	Part No.	521101	Ref. No.	—
	nut thread M14x1.5 H 5mm WS 19 SS Qty 1 pcs			
	Part No.	550262	Ref. No.	—
	flat gasket copper ED ø 20mm ID ø 14mm thickness 2mm			

immersion heating elements

3 hole flange ø57.5mm

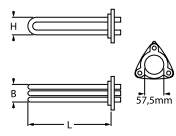
	1		
			

Part No.	415021	Ref. No.	RS0963
description	heating element 6000W 230V mounting ø 57.5mm heating circuits 3 L 343mm W 37mm H 50mm number of thermostat sleeves 1 thermostat sleeves ø 7mm length thermostat sleeves 294mm thermostat sleeve not clinging tube ø 8.5mm hole distance 72mm hole ø 8mm connection M5 3 hole flange		

spare parts for	415021			
	Part No.	510409	Ref. No.	DM0578
	O-ring EPDM thickness 5.34mm ID ø 56.52mm Qty 1 pcs			



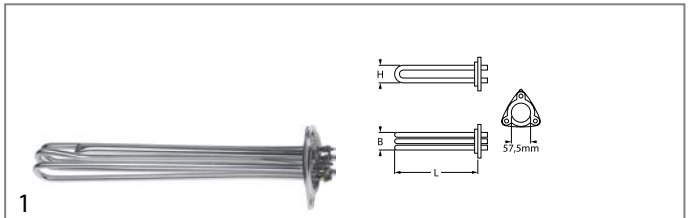

accessories for	415021			
	Part No.	550002	Ref. No.	—
	tension strap H 10mm L 21mm W 10mm hole ø 6.5mm for heating element			



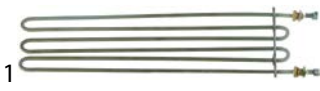

Part No.	419127	Ref. No.	RS0961
description	heating element 7000W 230/400V mounting ø 57.5mm heating circuits 3 L 340mm W 32mm H 53mm number of thermostat sleeves 1 thermostat sleeves ø 8.5mm length thermostat sleeves 268mm thermostat sleeve eccentric, non clinging tube ø 7.8mm hole distance 74mm hole ø 8mm connection M4 3 hole flange immersion heater		

	1		
Part No.	419119	Ref. No.	RS0890
description	heating element 1950W 230V heating circuits 1 L 460mm W 106mm thread M12x1 tube ø 6.5mm connection M4 dry heating element 2 hole fixing connection length 25mm thermostat sleeves ø 5.6mm length thermostat sleeves 255mm number of thermostat sleeves 1 thermostat sleeve clinging		

	1		
Part No.	418454	Ref. No.	RS0884
description	heating element 1950W 230V heating circuits 1 L 462mm W 107mm thread M12x1 mounting distance 100mm tube ø 6.7mm connection M5 immersion heater 2 hole fixing connection length 27mm		

accessories for	418454			
	Part No.	520229	Ref. No.	—
	nut thread M12x1 H 4mm WS 16 zinc-coated steel Qty 1 pcs			
	Part No.	521110	Ref. No.	—
	flat gasket fibre ED ø 20mm ID ø 13mm thickness 2mm Qty 1 pcs			
	Part No.	521131	Ref. No.	—
	nut thread M12x1 H 3.5mm WS 17 SS Qty 1 pcs			
	Part No.	528110	Ref. No.	—
	O-ring EPDM thickness 2.62mm ID ø 12.37mm Qty 1 pcs			

	1		
Part No.	420255	Ref. No.	RS0908
description	heating element 2600W 230V heating circuits 1 L 435mm W 225mm H 23mm thread M12x1 mounting distance 219mm tube ø 6.3mm connection M4 immersion heater 2 hole fixing		

1

Part No.	418446	Ref. No.	RS0905
description	heating element 900W 230V heating circuits 1 L 420mm W 45mm thread M12x1 mounting distance 36mm tube ø 8.5mm 2 hole fixing immersion heater		

heating elements for convection

1

Part No.	420006	Ref. No.	RS0933
description	heating element 6000W 230V ED ø 315mm		



1

Part No.	420007	Ref. No.	RS0930
description	heating element 7500W 230V heating circuits 3 ID ø 300mm L 460mm H 57mm L1 148mm W1 32mm flange length 120mm flange width 72mm hole distance 100mm ED ø 312mm connection M4 tube ø 6.6mm convection heating element hole ø 7mm rectangular flange		

1

Part No.	420005	Ref. No.	RS0950
description	heating element 9000W 230V		

radiation heaters

square



1

Part No.	490008	Ref. No.	DE0253
description	radiation heater L 300mm W 300mm 4000W 400V heating circuits 2 connections 3 square connection type male faston 6.3mm without pan detection EGO		
spare parts for	490008		
	Part No.	Ref. No.	—
	499157		
	protection pipe for temperature probe ceramic L 297mm ED ø 7mm ID ø 5mm		

accessories

sealing washers

O-rings

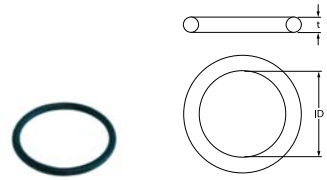

1

Part No.	510409	Ref. No.	DM0578
description	O-ring EPDM thickness 5.34mm ID ø 56.52mm Qty 1 pcs		

hot plates

square & rectangular

with radiused edge



1

Part No.	490068 ¹	Ref. No.	PQ0887
description	hot plate dimensions 220x220mm 2600W 400V with spill ring connection 4 screw clamps protector yes square		

¹incl. protector



1

Part No.	490071 ¹	Ref. No.	052199
description	hot plate dimensions 300x300mm 4000W 230V with spill ring connection 4 screw clamps protector yes square		

¹incl. protector



1

Part No.	490074 ¹	Ref. No.	PQ0786
description	hot plate dimensions 300x300mm 4000W 400V with spill ring connection 4 screw clamps protector yes square		

¹incl. protector



with cast edge

with screw connection

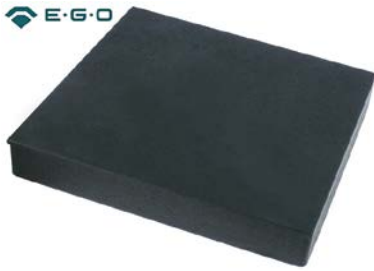

1

Part No.	490161	Ref. No.	PQ0889
description	hot plate dimensions 300x300mm 4000W 400V with cast edge H 42mm connection 4 screw clamps		

tiltable

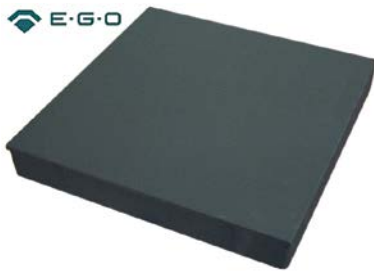

1

Part No.	490089	Ref. No.	PQ0839
description	hot plate dimensions 300x300mm 4000W 230V with cast edge tilt boiling plate connection 4 screw clamps H 43mm square		

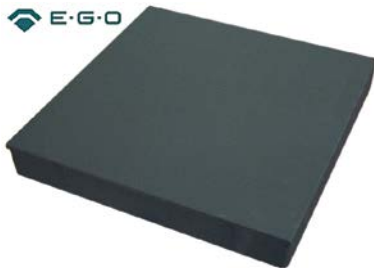

1

Part No.	490090	Ref. No.	PQ0840
description	hot plate dimensions 300x300mm 4000W 400V with cast edge tilt boiling plate connection 4 screw clamps H 43mm square		

round

with radiused edge

for domestic and commercial kitchens



1

Part No.	490016	Ref. No.	PQ0781
description	hot plate ø 180mm 2000W 230V connection 4 screw clamps with 8mm spill ring		



1

Part No.	490017	Ref. No.	PQ0782
description	hot plate ø 180mm 2000W 400V connection 4 screw clamps with 8mm spill ring		



1

Part No.	490020	Ref. No.	PQ0783
description	hot plate ø 220mm 2600W 230V connection 4 screw clamps with 8mm spill ring		

accessories for 490020

	Part No.	550796	Ref. No.	—
		fixing plate for hot plate ø220mm		



1

Part No.	490021	Ref. No.	PQ0784
description	hot plate ø 220mm 2600W 400V connection 4 screw clamps with 8mm spill ring		

energy regulators

EGO

1-circuit



1

Part No.	380015	Ref. No.	DE0952
description	energy regulator 230V 13A single-circuit turn direction right shaft ø 6x4.6mm shaft L 23mm mounting thread M4 power release 6-100% no. 50.57021.010		





1

Part No.	380013	Ref. No.	DE0953
description	energy regulator 400V 7A single-circuit turn direction right shaft ø 6x4.6mm mounting thread M4 no. 50.57031.010		



DIAMOND

			
1			
Part No.	380039	Ref. No.	DE0426
description	energy regulator 400V 13.5A turn direction right shaft ø 6x4.6mm mounting thread 3/8"-24UNF equiv. no. 35ERE104400V		
accessories for	380039		
	Part No.	361181	Ref. No. —
	nut thread 1/8" H 4.5mm nickel-plated brass WS 14 Qty 1 pcs		

accessories

knobs

			
1			
Part No.	110075	Ref. No.	DE0951
description	knob energy regulator 1-3 t.max.°C ø 50mm shaft ø 6x4.6mm shaft flat upper black		
accessories for	110075		
	Part No.	110135	Ref. No. TH1067
	rosette knob up to ø 52mm		

thermostats

bi-metal thermostats

safety bi-metal thermostats

			
1			
Part No.	375751	Ref. No.	DE0450
description	bi-metal safety thermostat hole distance 23.5mm switch-off temp. 85°C 1NC 1-pole 16A connection F6.3 2 hole fixing		

bi-metal thermostats

			
1			
Part No.	390825	Ref. No.	DE0670
description	bi-metal thermostat hole distance 23.5mm switch-off temp. 45°C 1NO 1-poleA 230V connection F6.3		

control and safety thermostats

EGO

control thermostats

55.10/19_ series

			
1			
Part No.	375001	Ref. No.	TH1081
description	thermostat t.max. 112°C temperature range 30-110°C 1-pole 1NO 16A probe ø 6mm probe L 130mm capillary pipe 900mm capillary pipe isolatedmm gland nut M9x1 shaft L 23mm shaft position upper rotation 270°		

			
1			
Part No.	375468	Ref. No.	TH1112 TH112
description	thermostat t.max. 180°C temperature range 80-180°C 1-pole 1NO 16A probe ø 6mm probe L 135mm capillary pipe 900mm capillary pipe isolatedmm gland nut M9x1 shaft ø 6x4.6mm shaft L 23mm shaft position upper rotation 270°		

			
1			
Part No.	376054	Ref. No.	FT4040
description	thermostat t.max. 200°C temperature range 65-200°C 1CO 6.3A probe ø 6mm probe L 78mm capillary pipe 900mm capillary pipe isolatedmm gland nut M12 shaft ø 6x4.6mm shaft L 23mm rotation 270° probe material SS screw connection M9x1 disc ø 7.7mm		
accessories for	376054		
	Part No.	110121	Ref. No. —
	knob thermostat t.max. 200°C ø 50mm shaft ø 6x4.6mm shaft flat upper black temperature range 60-200°C rotation 270°		
	Part No.	110135	Ref. No. TH1067
	rosette knob up to ø 52mm		



E·G·O



Part No.	390824	Ref. No.	TH1123
description	thermostat t.max. 60°C temperature range fixed 60°C 1-pole 1NO 16A probe ø 6mm probe L 134mm capillary pipe 1800mm capillary pipe isolatedmm gland nut shaft Lmm shaft position° shaft position rotation°		

55.13_series

E·G·O



Part No.	375705	Ref. No.	TH0117
description	thermostat t.max. 110°C temperature range 30-110°C 1-pole 1NO 16A probe ø 6mm probe L 115mm capillary pipe 1430mm capillary pipe isolatedmm gland nut M9x1 shaft ø 6x4.6mm shaft L 23mm shaft position upper rotation 270°		

E·G·O



Part No.	375460	Ref. No.	TH0111
description	thermostat t.max. 255°C temperature range 55-255°C 1-pole 1NO 16A probe ø 3.1mm probe L 201mm capillary pipe 1170mm capillary pipe isolated 1100mm gland nut shaft ø 6x4.6mm shaft L 23mm shaft position upper		

55.34_series

E·G·O



Part No.	375143	Ref. No.	TH1084
description	thermostat t.max. 110°C temperature range 32-110°C 3-pole 3NO 16A probe ø 6mm probe L 138mm capillary pipe 1480mm capillary pipe isolated 1100mm gland nut M9x1 shaft ø 6x4.6mm shaft L 23mm shaft position upper rotation 270°		

E·G·O



Part No.	390055	Ref. No.	TH1084
description	thermostat t.max. 160°C temperature range 66-160°C 3-pole 3NO 16A probe ø 8mm probe L 115mm capillary pipe 800mm capillary pipe isolatedmm gland nut shaft ø 6x4.6mm shaft L 23mm shaft position upper° rotation 270° with disc probe thread M14x1 disc ø 12.5mm		

E·G·O



Part No.	375043	Ref. No.	TH1079
description	thermostat t.max. 200°C temperature range 65-200°C 3-pole 3NO 16A probe ø 6mm probe L 77mm capillary pipe 880mm capillary pipe isolated 800mm gland nut M9x1 shaft ø 6x4.6mm shaft L 23mm shaft position upper rotation 270°		

E·G·O



Part No.	375417	Ref. No.	TH1079
description	thermostat t.max. 200°C temperature range 65-200°C 3-pole 3NO 16A probe ø 6mm probe L 79mm capillary pipe 840mm capillary pipe isolatedmm gland nut M9x1 shaft ø 6x4.6mm shaft L 23mm rotation 270°		



Part No.	375038	Ref. No.	TH1086
description	thermostat t.max. 300°C temperature range 50-300°C 3-pole 3NO 16A probe ø 6mm probe L 79mm capillary pipe 1740mm capillary pipe isolated 800mm gland nut shaft ø 6x4.6mm shaft L 23mm shaft position upper rotation 270°		
accessories for	375038		
	Part No.	110123	Ref. No. —
	knob thermostat t.max. 300°C ø 50mm shaft ø 6x4.6mm shaft flat upper black temperature range 50-300°C rotation 270°		



Part No.	375026	Ref. No.	TH1088
description	thermostat t.max. 350°C temperature range 100-350°C 3-pole 3NO 16A probe ø 6mm probe L 77mm capillary pipe 2430mm capillary pipe isolated 1100mm gland nut shaft ø 6x4.6mm shaft L 23mm shaft position upper rotation 270°		



Part No.	390038	Ref. No.	DE1237
description	thermostat t.max. 90°C temperature range 30-90°C 3-pole 3CO 16A probe ø 6mm probe L 215mm capillary pipe 900mm capillary pipe isolatedmm gland nut shaft Lmm		

safety thermostats

55.13_ series



Part No.	375214	Ref. No.	TH1290
description	safety thermostat switch-off temp. 140°C 1-pole 16A probe ø 6mm probe L 77mm capillary pipe 1540mm capillary pipe isolated 1350mm gland nut probe SS		



Part No.	375619	Ref. No.	TH1120
description	safety thermostat switch-off temp. 220°C 1-pole 1NO 16A probe ø 6mm probe L 77mm capillary pipe 830mm capillary pipe isolatedmm gland nut M9x1 probe		

55.32_ series



Part No.	375290	Ref. No.	TH1087
description	safety thermostat switch-off temp. 240°C 3-pole 20A probe ø 6mm probe L 87mm capillary pipe 2000mm capillary pipe isolated 1800mm gland nut probe SS		



E-G-O

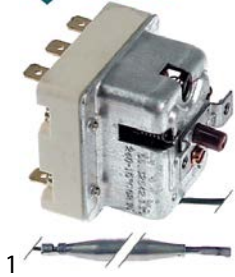

Part No.	375704	Ref. No.	TH1087
description	safety thermostat switch-off temp. 240°C 3-pole 20A probe ø 6mm probe L 87mm capillary pipe 890mm capillary pipe isolated 600mm gland nut probe SS		

E-G-O

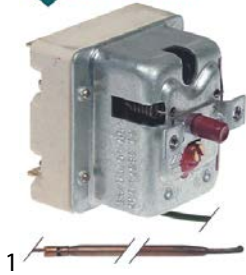

Part No.	375706	Ref. No.	TH1122
description	safety thermostat switch-off temp. 400°C 3-pole 3NC 20A probe ø 3.9mm probe L 228mm capillary pipe 1190mm capillary pipe isolatedmm gland nut probe SS		

55.33_ series

E-G-O



Part No.	375467	Ref. No.	TH0118
description	safety thermostat switch-off temp. 220°C 3-pole 3NC 20A probe ø 6mm probe L 75mm capillary pipe 1500mm capillary pipe isolatedmm gland nut M9x1 probe SS		

E-G-O





Part No.	375985	Ref. No.	TH0108
description	safety thermostat switch-off temp. 230°C 3-pole 1NC probe ø 6mm probe L 75mm capillary pipe 1780mm capillary pipe isolatedmm gland nut M12x0.75 starting temperature 16°C probe screw connection M10x0.75		

control thermostats with operation switch

55.10/19_ series

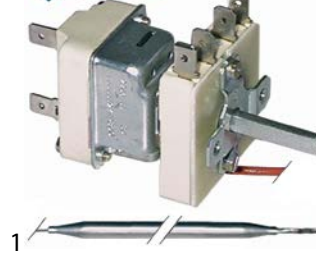
E-G-O



Part No.	390039	Ref. No.	DE0426	
description	thermostat t.max. 90°C temperature range 30-90°C 1-pole 1CO 16A probe ø 6mm probe L 173mm capillary pipe 980mm capillary pipe isolated 980mm gland nut shaft ø 6x4.6mm shaft L 23mm shaft position upper rotation 270° outer switch 2NO			
accessories for	390039			
	Part No.	111934	Ref. No.	—
	knob thermostat t.max. 90°C ø 50mm shaft ø 6x4.6mm shaft flat upper black temperature range 30-90°C rotation 270°			

55.34_ series

E-G-O

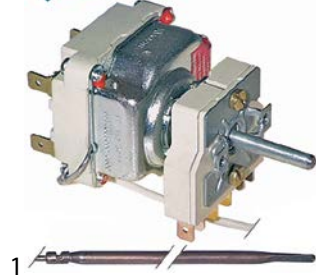

Part No.	375246	Ref. No.	DE0254
description	thermostat t.max. 645°C temperature range 100-615/645°C 2-pole 2NO 16A probe ø 4mm probe L 230mm capillary pipe 1100mm capillary pipe isolated 600mm gland nut shaft ø 6x4.6mm shaft L 25mm shaft position lower rotation 270° outer switch 2NO probe material copper		

accessories

connecting bows



Part No.	550059	Ref. No.	DM0348
description	connecting bow short for switch Qty 1 pcs		



switches and momentary switches

rocker/momentary rocker switches

30x22mm



Part No.	347791	Ref. No.	DE3055
description	rocker switch mounting measurements 30x22mm green 2NO 230V 20A illuminated 0-1 connection male faston 6.3mm ambient temperature max. 125/55°C protection IP65 with rubber collar		

push/momentary push switches

miscellaneous



Part No.	347737	Ref. No.	DE0040 1
description	momentary push switch mounting ø 12mm black 1CO 250V 6A with protecting cover connection male faston 4.8mm ambient temperature max. 100/55°C protection IP54		

toggle switches

M12x0.75



Part No.	347595	Ref. No.	DE0257
description	toggle switch thread M12x0.75 2CO 250V 15A ON-ON screw		

M12x1



Part No.	347738	Ref. No.	DE0206
description	toggle switch thread M12x1 1NO 250V 15A connection male faston 6.3mm		

accessories



Part No.	346525	Ref. No.	DE0258
description	protection cap L 23.5mm W 17.3mm protection cap rubber thread M11		

position switches

TELEMECANIQUE (EFA)



Part No.	347736	Ref. No.	DE0663
description	position switch plastic 1NO/1NC 600V 10A L 63mm W 21mm H 59mm protection IP44 actuating force: 300g screw connection mounting distance 75mm type XC1-ZB21		

float switches



Part No.	403024	Ref. No.	DE0986
description	float switch thread 1" 2NO ø 25mm L 200mm mounting ø 1"mm 230V 0.5A cable cable length 2000mm		

cam switches

on/off



Part No.	300248	Ref. No.	DE0204
description	cam switch ON-OFF 16A shaft ø 6x4.6mm connection screw clamp 3-pole		

7-position







Part No.	300025	Ref. No.	DE0781
description	cam switch 7 operating positions 1NO/2CO sequence 0-1-2-3-4-5-6 16A shaft ø 6x4.6mm shaft L 23mm connection screw 7-position ceramic		
accessories for	300025		
	Part No.	112172	Ref. No. —
	knob universal ø 70mm black without adaptor/dial plate		



Table continues overleaf

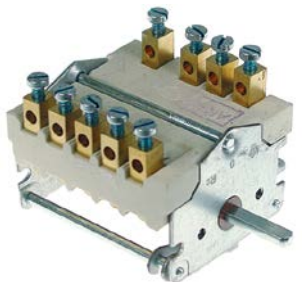

accessories for	300025			
	Part No.	112213	Ref. No.	—
	knob dial plate silver switch 7-position t.max.°C ED ø 63mm ID ø 45.5mm			
	Part No.	112311	Ref. No.	—
	knob adapter shaft ø 6x4.6mm L 0mm with spring			

				
				
1				
Part No.	300106	Ref. No.	DE0785	
description	cam switch 7 operating positions 1NO/2CO sequence 0-1-2-3-4-5-6 32A shaft ø 6x4.6mm shaft L 23mm connection screw 7-position shaft flat upper			

4 operating positions				
				
1				
Part No.	300360	Ref. No.	DE0205	
description	cam switch 4 operating positions 3NO/1CO sequence 0-1-2-3 32A shaft ø 6x4.6mm shaft L 23mm connection screw ceramic			

operation switches				
				
				
1				
Part No.	300091	Ref. No.	DE0197	
description	operation switch EGO 2 operating positions 2NO 16A sequence 0-1 shaft ø 6x4.6mm shaft L 23mm connection screw ceramic			

magnetic switches

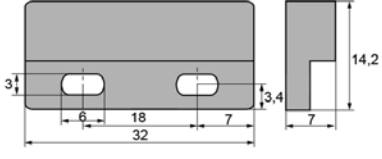

32x15mm				
				
1				
				
Part No.	345109	Ref. No.	DE0192	
description	magnetic switch L 32mm W 15mm 1NO 250V 1A P max. 40W connection cable cable length 2000mm			

accessories

magnets				
				
1				
Part No.	347739	Ref. No.	DE0216	
description	magnet ømm L 32mm H 7mm W 15mm hole distance 17mm M4 hole ø 4x6mm			

control equipment





SIEMENS

3SB series ø22mm new				
				
1				
Part No.	346630	Ref. No.	DE1108	
description	contact block SIEMENS 3SB3400-0B 1NO max 400V 10A black			
accessories for	346630			
	Part No.	347520	Ref. No.	—
	push button mounting measurements ø22mm non-illuminated black			

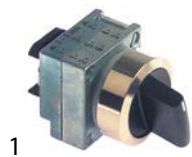

rotary switches



Part No.	346601	Ref. No.	DE1091
description	rotary selector mounting measurements ø22mm black latching sequence 0-1		
accessories for	346601		
	Part No.	346602	Ref. No. —
	contact block SIEMENS 3SB3400-0D 2NO max 400V 10A black		
	Part No.	346603	Ref. No. —
	contact block SIEMENS 3SB3400-0E 2NC max 400V 10A black		
	Part No.	346630	Ref. No. DE1108
	contact block SIEMENS 3SB3400-0B 1NO max 400V 10A black		
	Part No.	346631	Ref. No. —
	contact block SIEMENS 3SB3400-0C 1NC max 400V 10A black		
	Part No.	346632	Ref. No. —
	contact block SIEMENS 3SB3400-0D 1NC/1NO max 400V 10A black		

lamps

indicator lights

indicator lights (complete)

ø12mm

with screw socket



Part No.	359893	Ref. No.	DE0581
description	indicator light ø 12mm 400V green connection cable 200mm		



Part No.	359895	Ref. No.	DE0584
description	indicator light ø 12mm 400V yellow connection cable 200mm		



Part No.	359894	Ref. No.	DE0577
description	indicator light ø 12mm 400V red connection cable 200mm		

ø22mm



Part No.	357000	Ref. No.	DE0582 1
description	indicator light ø 22.5mm 400V green connection screw clamp		

screw-on/push-on fit

light bulbs

for ovens







Part No.	359610	Ref. No.	DE0016
description	light bulb t.max. 300°C socket E14 15W 230V ø 22mm L 47mm lens L 20mm for oven lamp type Philips		

oven lamps

universal oven lamps

mounting diameter 35.5mm



Part No.	359720	Ref. No.	DE0576
description	oven lamp mounting ø 35.5mm 230V 15W socket E14 temp.-resist. 300°C connection male faston 6.3mm hard glas		
spare parts for	359720		
	Part No.	359701	Ref. No. —
	lamp socket socket E14 220-230V mounting ø 35.5mm connection male faston 6.3mm 15W		
	Part No.	359705	Ref. No. DM0501
	oven lamp glass thr.ø 33.5mm ø 52mm hard glas temp.-resist. 350°C		
	Part No.	359721	Ref. No. DM0495
	gasket silicone ED ø 48mm ID ø 39.5mm thickness 5mm Qty 1 pcs		
	Part No.	359740	Ref. No. —
	light bulb t.max. 300°C socket E14 15W 230V ø 22mm L 48mm lens L 20mm for oven lamp IMPORT		



			
1			
Part No.	359705	Ref. No.	DM0501
description	oven lamp glass thr.ø 33.5mm ø 52mm hard glas temp.-resist. 350°C		
accessories for	359705		
	Part No.	359610	Ref. No. DE0016
	light bulb t.max. 300°C socket E14 15W 230V ø 22mm L 47mm lens L 20mm for oven lamp type Philips		
	Part No.	359700	Ref. No. —
	gasket for pizza oven fibre glass ID ø 32.5mm ED ø 55mm thickness 5mm		
	Part No.	359721	Ref. No. DM0495
	gasket silicone ED ø 48mm ID ø 39.5mm thickness 5mm Qty 1 pcs		
	Part No.	359837	Ref. No. —
	gasket ID ø 33mm ED ø 46mm thickness 1mm graphite		
	Part No.	359838	Ref. No. —
	gasket ID ø 33mm ED ø 45mm		

			
1			
Part No.	359721	Ref. No.	DM0495
description	gasket silicone ED ø 48mm ID ø 39.5mm thickness 5mm Qty 1 pcs		

lamps

light bulbs

			
1			
Part No.	359610	Ref. No.	DE0016
description	light bulb t.max. 300°C socket E14 15W 230V ø 22mm L 47mm lens L 20mm for oven lamp type Philips		

timers

mechanical timers

			
1			
Part No.	350094	Ref. No.	DE0657
description	timer C53 4-pole operation time 60min impulse mechanical 2NO/2NC at 250V 16A permanent position no shaft ømm shaftmm shaft L 24mm mounting distance 28mm connection lateral front measurements 72x72mm		

audible timers

			
1			
Part No.	350014	Ref. No.	DE0659
description	audible timer operation time 15min ø 56mm shaft ø 6x4.6mm shaft L 24mm mounting distance 28mm		



			
1			
Part No.	350036	Ref. No.	DE0656
description	audible timer operation time 60min ø 55mm shaft ø 6x4.6mm shaft L 22mm mounting distance 28mm		

contactors

ABB

power contactors

			
1			
Part No.	380108	Ref. No.	DE0210
description	power contactor resistive load 30A 230VAC (AC3/400V) 17A/7.5kW main contacts 3NO auxiliary contacts 1NO connection screw connection type A16-30-10		

			
1			
Part No.	380112	Ref. No.	D02000
description	power contactor resistive load 45A 230VAC (AC3/400V) 26A/11kW main contacts 3NO auxiliary contacts 1NO connection screw connection type A26-30-10		
accessories for	380112		
	Part No.	381031	Ref. No. —
	auxiliary contact contacts 1NO/1NC AC1 16A AC15 3A connection screw connection for contactors B6/B7/VB7		



GENERAL ELECTRIC (AEG)

power contactors



1

Part No.	380261	Ref. No.	DE0209
description	power contactor resistive load 32A 230VAC (AC3/400V) 17A/7.5kW main contacts 3NO auxiliary contacts 1NO connection screw connection type AEG LS7K 10A type GE CL02A 310		



1

Part No.	380264	Ref. No.	DE0110
description	power contactor resistive load 45A 230VAC (AC3/400V) 25A/11kW main contacts 3NO auxiliary contacts connection screw connection type AEG LS11K 00A type GE CL25A 300		

auxiliary contacts



1

Part No.	380270	Ref. No.	DE0111
description	auxiliary contact contacts 1NO/1NC for contactors CL+LS_K connection screw AC-12 10A type AEG HS08K 11 type GE BCLL 11		

SIEMENS

power contactors



1

Part No.	380526	Ref. No.	DE0140
description	power contactor resistive load 20A 230VAC (AC3/400V) 8.4A/4kW main contacts 4NO auxiliary contacts connection screw connection type 3TG10-10-0A2L2		

relays

level relays

miscellaneous



1

Part No.	380961	Ref. No.	DE0960
description	level controller 1-pole 230V voltage AC type CNRVA1 FLT		

probes

universal probes

temperature probes



1

Part No.	375051	Ref. No.	DE0972
description	temperature probe thermocouple J (Fe-CuNi) cable Vetrotex probe -50 up to +750°C cable -50 up to +350°C probe ø4x150mm cable length 1.5m 2-wire		

electronics

PCBs



1

Part No.	403134	Ref. No.	DE3052
description	keypad PCB induction device L 85mm W 45mm with ribbon cable buttons 2		



1

Part No.	403023	Ref. No.	DE3020 DE3105
description	PCB L 135mm W 85mm with screws for fryer		



pressure switches

for warewashing

ø 84mm with coded plug

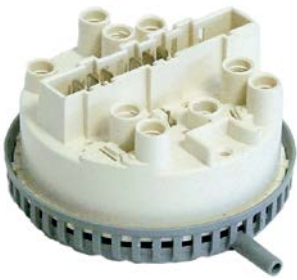

1

Part No.	541176	Ref. No.	RB0655
description	pressure control 2 pressure ranges pressure range 60/20 110/80mbar connection 6mm ø 84mm pressure connection horizontal warewashing suitable for ZANUSSI		

electrodes



1

Part No.	403136	Ref. No.	DV0850 1
description	level electrode M4 total length 150mm probe L 145mm insulated probe length 130mm connection F6.3 ø 4mm		



1

Part No.	403135	Ref. No.	DV0851 1
description	level electrode M4 total length 200mm probe L 12mm insulated probe length 180mm connection male faston 6.3mm ø 6/4mm		



fans

axial fans

ebm-papst



1

Part No.	601030 ¹	Ref. No.	DE0669
description	axial fan L 119mm W 119mm H 38mm 230VAC 50Hz 18W bearing ball bearing manuf. no. 4656Z metal connection male faston 2.8mm ebm-papst fan wheel ø 110mm temp.-resist. 75°C		
accessories for	601030		
	Part No.	550898	Ref. No. —
	connecting cable cable length 2000mm connection F 2.8 connection distance 7.9mm for axial flow fan		
	Part No.	692497	Ref. No. —
	guard ø 105mm mounting distance 150mm for axial fan ebm-papst-mm		

¹with ball bearings

1

Part No.	601038 ¹	Ref. No.	DE0710
description	axial fan L 80mm W 80mm H 38mm 230VAC 50/60Hz 12W bearing ball bearing manuf. no. 8556N metal connection cable 300mm ebm-papst fan wheel ø 75mm temp.-resist. 90°C airflow 50m ³ /h		
accessories for	601038		
	Part No.	691102	Ref. No. —
	guard ø 75mm mounting distance 71mm for axial fan 80mm		

¹with ball bearings

cross flow fans

COPREL

with standard coil



1

Part No.	601453	Ref. No.	DE0155
description	cross flow fan TFR 180 roller ø 60mm roller length 180mm laminated core thickness 16mm motor position right 230V/50-60Hz 17W universal bearing silicone connection male faston 6.3mm airflow 100m ³ /h -30 up to +100°C 230V 50Hz		
accessories for	601453		
	Part No.	415114	Ref. No. —
	heater battery mounting distance 185mm W 40mm H 35mm 2000W 230V temperature restriction 105°C heating circuits 2 connection cable cable length 150mm L 192mm for cross flow fan		



hot air fans

ebm-papst



1

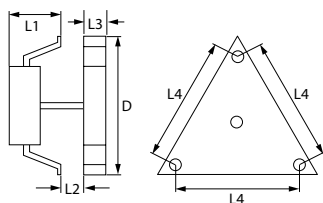

Part No.	601014	Ref. No.	DE0684
description	hot air fan 230V 32W 0.27A L1 60mm L2 28mm L3 20mm L4 157mm fan wheel ø 150mm ebm-papst type R2K150-AC01-25 2000rpm		

condensators & interference suppression filters

operating capacitors

plastic



1

Part No.	365021	Ref. No.	DE0084
description	operating capacitor capacity 16µF 425V tolerance 5% 50/60Hz ambient temperature max. -25 to +85°C ø 35mm L 73mm single M8 plastic connection male faston 6.3mm 416.10.99 protection		

fuses

fine fuses



1

Part No.	358608	Ref. No.	DE0839
description	fine fuse size ø5x20mm 10A slow-acting rated 250V Qty 10 pcs		

fine fuse holders



1

Part No.	358113	Ref. No.	DE3051
description	fuse holder suitable fuse ø5x20mm ø 15mm thread M12x0.75 1-pole 10A rated 250V L 34mm connection male faston 2.8mm		

electric accessories

plugs - couplings - power sockets

appliance sockets/plugs

low temperature appliances 70°C



1

Part No.	551133 ¹	Ref. No.	DE0836
description	appliance inlet C14 max 10A/250V T70 mounting distance 51mm hole ø 3.3mm plastic male faston 4.8mm with switch temp.-resist. 100°C		

¹incl. rocker switch

terminals and connectors

not insulated

female bullets



1

Part No.	100112	Ref. No.	DE0092
description	female bullet size 2mm 0.25-1.0mm ² CuZn gal Sn t.max. 125°C Qty 20 pcs		

terminals

connection terminals with screw connection



1

Part No.	550507	Ref. No.	DE0083
description	power terminal block 4-pole max. 40A max 400V connection M6/M6 temp.-resist. 150°C		







			
1			
Part No.	550355	Ref. No.	DE0082
description	power terminal block 6-pole max. 40A max 400V connection M6/M6 temp.-resist. 150°C cross section 6mm ² hole distance 122mm		

gas taps

PEL

20S series

			
1			
Part No.	101491	Ref. No.	RB1213
description	gas tap PEL type 20S gas inlet M16x1.5 (tube ø 10mm) bypass nozzle ø 0.35mm gas outlet M16x1.5 (tube ø 10/8mm) thermocouple connection M9x1 pilot connection shaft ø 8x6.5mm shaft L 22/15mm shaft flat lower		
spare parts for	101491		
	Part No.	100408	Ref. No. —
	bypass nozzle type PEL20/21 bore ø 0.35mm thread M5x0.5		
	Part No.	101060	Ref. No. RB0661
	magnet unit standard L 39mm D1 ø 15.4mm D2 ø 11mm suitable for PEL20-21/JUNKERS/EGA		
	Part No.	101205	Ref. No. —
	gas tap front part shaft ø 8x6.5mm shaft L 22/15mm shaft flat upper/lower suitable for PEL20		
	Part No.	101231	Ref. No. —
	thermocouple nut T1: M9x1 T2: M18x1		
accessories for	101491		
	Part No.	101287	Ref. No. —
	olive for pipe ø 6mm Qty 1 pcs		
	Part No.	101300	Ref. No. —
	union nut thread M16x1.5 tube ø 10mm		
	Part No.	101450	Ref. No. —
	olive for pipe ø 8mm L 12.7mm Qty 1 pcs ED ø 10mm		
	Part No.	101451	Ref. No. —
	union nut thread M16x1.5 tube ø 8mm		
	Part No.	110081	Ref. No. —
	knob ø 70mm shaft ø 8x6.5mm shaft flat universal		
	Part No.	110083	Ref. No. —
	knob dial plate gas tap without ignition flame silver		

















21S series



			
1			
Part No.	101397	Ref. No.	RB1214
description	gas tap PEL type 21S gas inlet M16x1.5 (tube ø 10mm) bypass nozzle ø 0.35mm gas outlet M16x1.5 (tube ø 10/8mm) thermocouple connection M9x1 pilot connection M10x1 shaft ø 8x6.5mm shaft L 22/15mm shaft flat lower		
spare parts for	101397		
	Part No.	100408	Ref. No. —
	bypass nozzle type PEL20/21 bore ø 0.35mm thread M5x0.5		
	Part No.	101060	Ref. No. RB0661
	magnet unit standard L 39mm D1 ø 15.4mm D2 ø 11mm suitable for PEL20-21/JUNKERS/EGA		
	Part No.	101206	Ref. No. —
	gas tap front part shaft ø 8x6.5mm shaft L 22/15mm shaft flat upper/lower suitable for PEL21		
	Part No.	101231	Ref. No. —
	thermocouple nut T1: M9x1 T2: M18x1		
accessories for	101397		
	Part No.	100908	Ref. No. —
	union screw thread M10x1 for pipe ø 4mm Qty 1 pcs		
	Part No.	100909	Ref. No. —
	union screw thread M10x1 for pipe ø 6mm Qty 1 pcs		
	Part No.	101246	Ref. No. —
	olive for pipe ø 4mm Qty 1 pcs		
	Part No.	101278	Ref. No. —
	olive for pipe ø 10mm Qty 1 pcs		
	Part No.	101286	Ref. No. —
	olive ID ø 6mm Qty 1 pcs		
	Part No.	101300	Ref. No. —
	union nut thread M16x1.5 tube ø 10mm		
	Part No.	101450	Ref. No. —
	olive for pipe ø 8mm L 12.7mm Qty 1 pcs ED ø 10mm		
	Part No.	101451	Ref. No. —
	union nut thread M16x1.5 tube ø 8mm		
	Part No.	110081	Ref. No. —
	knob ø 70mm shaft ø 8x6.5mm shaft flat universal		
	Part No.	112206	Ref. No. —
	knob dial plate silver gas tap PEL21/22/23 t.max.°C ED ø 63mm ID ø 45.5mm		



22S/O series



Part No.	101086	Ref. No.	RB1219
description	gas tap PEL type 22S/O gas inlet M20x1.5 (tube ø 12mm) bypass nozzle ø 0.35mm gas outlet M20x1.5 (tube ø 12/10mm) thermocouple connection M9x1 pilot connection M10x1 shaft ø 10x8mm shaft L 25/17mm shaft flat lower		
spare parts for	101086		
	Part No.	100259	Ref. No. —
	bypass nozzle type PEL22 bore ø 0.35mm thread M6x0.5		
	Part No.	101058	Ref. No. RB0660
	magnet unit L 39mm D1 ø 15.4mm D2 ø 13.5mm suitable for PEL22/EGA24197 standard		
	Part No.	101201	Ref. No. —
	gas tap front part shaft ø 10x8mm shaft L 25/17mm shaft flat upper/lower suitable for PEL22		
	Part No.	101231	Ref. No. —
	thermocouple nut T1: M9x1 T2: M18x1		
	Part No.	101240	Ref. No. —
	gas connection thread M20x1.5 tube ø 12/10mm for PEL gas taps with gasket and screws horizontal		
	Part No.	101460	Ref. No. —
	O-ring ø 12.37mm D1 ø 2.62mm suitable for PEL22		
	Part No.	101461	Ref. No. —
	screw kit suitable for PEL22 Qty 4 pcs		
accessories for	101086		
	Part No.	100908	Ref. No. —
	union screw thread M10x1 for pipe ø 4mm Qty 1 pcs		
	Part No.	100909	Ref. No. —
	union screw thread M10x1 for pipe ø 6mm Qty 1 pcs		
	Part No.	101241	Ref. No. —
	gas connection thread M20x1.5 tube ø 12/10mm for PEL gas taps vertical		
	Part No.	101246	Ref. No. —
	olive for pipe ø 4mm Qty 1 pcs		
	Part No.	101248	Ref. No. —
	olive for pipe ø 12mm Qty 1 pcs suitable for PEL		
	Part No.	101249	Ref. No. —
	olive for pipe ø 10mm Qty 1 pcs		
	Part No.	101250	Ref. No. —
	union nut thread M20x1.5 for pipe ø 10mm		
	Part No.	101251	Ref. No. —
	union nut thread M20x1.5 for pipe ø 12mm		
	Part No.	101286	Ref. No. —
	olive ID ø 6mm Qty 1 pcs		

accessories for	101086		
	Part No.	110080	Ref. No. —
	knob ø 70mm shaft ø 10x8mm shaft flat universal		
	Part No.	112206	Ref. No. —
	knob dial plate silver gas tap PEL21/22/23 t.max.°C ED ø 63mm ID ø 45.5mm		









Part No.	107201	Ref. No.	RB1003
description	gas tap PEL type 22S/O gas inlet M20x1.5 (tube ø 12mm) bypass nozzle ø 0mm gas outlet M20x1.5 (tube ø 12/10mm) thermocouple connection M9x1 pilot connection M10x1 shaft ø 7x7mm shaft L 16/7mm shaft flat diagonal		
spare parts for	107201		
	Part No.	101058	Ref. No. RB0660
	magnet unit L 39mm D1 ø 15.4mm D2 ø 13.5mm suitable for PEL22/EGA24197 standard		
	Part No.	101231	Ref. No. —
	thermocouple nut T1: M9x1 T2: M18x1		
	Part No.	101366	Ref. No. —
	gas connection thread M20x1.5 tube ø 14mm for PEL gas taps horizontal		
	Part No.	101460	Ref. No. —
	O-ring ø 12.37mm D1 ø 2.62mm suitable for PEL22		
	Part No.	101461	Ref. No. —
	screw kit suitable for PEL22 Qty 4 pcs		
	Part No.	106162	Ref. No. —
	gas tap front part shaft ø 7x7mm shaft L 16/7mm shaft flat diagonal suitable for PEL22		
	Part No.	106191	Ref. No. —
	bypass nozzle type PEL22 bore ø 0mm thread M6x0.5		
accessories for	107201		
	Part No.	100908	Ref. No. —
	union screw thread M10x1 for pipe ø 4mm Qty 1 pcs		
	Part No.	100909	Ref. No. —
	union screw thread M10x1 for pipe ø 6mm Qty 1 pcs		
	Part No.	101241	Ref. No. —
	gas connection thread M20x1.5 tube ø 12/10mm for PEL gas taps vertical		
	Part No.	101246	Ref. No. —
	olive for pipe ø 4mm Qty 1 pcs		
	Part No.	101248	Ref. No. —
	olive for pipe ø 12mm Qty 1 pcs suitable for PEL		
	Part No.	101249	Ref. No. —
	olive for pipe ø 10mm Qty 1 pcs		

Table continues overleaf









accessories for		107201		
	Part No.	101250	Ref. No.	—
	union nut thread M20x1.5 for pipe ø 10mm			
	Part No.	101251	Ref. No.	—
	union nut thread M20x1.5 for pipe ø 12mm			
	Part No.	101286	Ref. No.	—
	olive ID ø 6mm Qty 1 pcs			
	Part No.	110080	Ref. No.	—
	knob ø 70mm shaft ø 10x8mm shaft flat universal			
	Part No.	112206	Ref. No.	—
	knob dial plate silver gas tap PEL21/22/23 t.max.°C ED ø 63mm ID ø 45.5mm			

22S/V series



1

Part No.	107200	Ref. No.	RB1005	
description	gas tap PEL type 22S/V gas inlet M20x1.5 (tube ø 12mm) bypass nozzle ø 0.35mm gas outlet M20x1.5 (tube ø 12/10mm) thermocouple connection M9x1 pilot connection M10x1 shaft ø 7x7mm shaft L 16/7mm shaft flat horizontal			
spare parts for		107200		
	Part No.	100259	Ref. No.	—
	bypass nozzle type PEL22 bore ø 0.35mm thread M6x0.5			
	Part No.	101058	Ref. No.	RB0660
	magnet unit L 39mm D1 ø 15.4mm D2 ø 13.5mm suitable for PEL22/EGA24197 standard			
	Part No.	101230	Ref. No.	—
	thermocouple nut T1: M8x1 T2: M18x1 aluminium			
	Part No.	101241	Ref. No.	—
	gas connection thread M20x1.5 tube ø 12/10mm for PEL gas taps vertical			
	Part No.	101460	Ref. No.	—
	O-ring ø 12.37mm D1 ø 2.62mm suitable for PEL22			
	Part No.	101461	Ref. No.	—
	screw kit suitable for PEL22 Qty 4 pcs			
	Part No.	106162	Ref. No.	—
	gas tap front part shaft ø 7x7mm shaft L 16/7mm shaft flat diagonal suitable for PEL22			
accessories for		107200		
	Part No.	100908	Ref. No.	—
	union screw thread M10x1 for pipe ø 4mm Qty 1 pcs			
	Part No.	100909	Ref. No.	—
	union screw thread M10x1 for pipe ø 6mm Qty 1 pcs			

accessories for		107200		
	Part No.	101240	Ref. No.	—
	gas connection thread M20x1.5 tube ø 12/10mm for PEL gas taps with gasket and screws horizontal			
	Part No.	101246	Ref. No.	—
	olive for pipe ø 4mm Qty 1 pcs			
	Part No.	101248	Ref. No.	—
	olive for pipe ø 12mm Qty 1 pcs suitable for PEL			
	Part No.	101249	Ref. No.	—
	olive for pipe ø 10mm Qty 1 pcs			
	Part No.	101250	Ref. No.	—
	union nut thread M20x1.5 for pipe ø 10mm			
	Part No.	101251	Ref. No.	—
	union nut thread M20x1.5 for pipe ø 12mm			
	Part No.	101286	Ref. No.	—
	olive ID ø 6mm Qty 1 pcs			

23S/V series



1



















Part No.	101093	Ref. No.	RB1217	
description	gas tap PEL type 23S/V gas inlet M28x1.5 (tube ø 20mm) bypass nozzle ø 0.35mm thermocouple connection M10x1 pilot connection M10x1 shaft ø 10x8mm shaft L 25/17mm shaft flat lower			
spare parts for		101093		
	Part No.	100455	Ref. No.	—
	bypass nozzle type PEL23/24 bore ø 0.35mm thread M8x0.5			
	Part No.	101059	Ref. No.	—
	magnet unit T1: M10x1 T2: M22x1 L 46mm ø 18mm suitable for PEL23S M10x1			
	Part No.	101204	Ref. No.	—
	gas tap front part shaft ø 10x8mm shaft L 25/17mm shaft flat upper/lower suitable for PEL23S			
	Part No.	101245	Ref. No.	—
	gas connection thread M24x1.5 tube ø 12/16mm vertical for PEL gas taps			
	Part No.	101463	Ref. No.	—
	screw suitable for PEL23S Qty 4 pcs			
	Part No.	528455	Ref. No.	—
	O-ring Viton thickness 2.62mm ID ø 18.72mm Qty 1 pcs			
accessories for		101093		
	Part No.	100908	Ref. No.	—
	union screw thread M10x1 for pipe ø 4mm Qty 1 pcs			

Table continues overleaf



accessories for		101093		
Part No.		100909	Ref. No.	—
	union screw	thread M10x1 for pipe ø 6mm	Qty 1 pcs	
Part No.		101246	Ref. No.	—
	olive	for pipe ø 4mm	Qty 1 pcs	
Part No.		101252	Ref. No.	—
	union nut	thread M24x1.5 for pipe ø 12mm		
Part No.		101253	Ref. No.	—
	union nut	thread M24x1.5 PEL for pipe ø 16mm		
Part No.		101254	Ref. No.	—
	union nut	thread M28x1.5 tube ø 20mm		
Part No.		101255	Ref. No.	—
	olive	for pipe ø 12mm	Qty 1 pcs	
Part No.		101256	Ref. No.	—
	olive	for pipe ø 16mm	Qty 1 pcs	
Part No.		101257	Ref. No.	—
	olive	for pipe ø 20mm	Qty 1 pcs	
Part No.		101286	Ref. No.	—
	olive	ID ø 6mm	Qty 1 pcs	
Part No.		110080	Ref. No.	—
	knob	ø 70mm shaft ø 10x8mm shaft flat universal		
Part No.		112206	Ref. No.	—
	knob dial plate	silver gas tap PEL21/22/23 t.max.°C ED ø 63mm ID ø 45.5mm		

STN3R

	1		
Part No.	106176	Ref. No.	RB0927
description	gas tap STN3R gas inlet 3/8" (tube ø 10/8mm) bypass nozzle ø 0mm gas outlet 3/8" (tube ø 10/8mm) thermocouple connection pilot connection M10x1 shaft ø 7x7mm shaft L 18.5/7mm shaft flat diagonal suitable for MORICE pilot connection M10x1		

miscellaneous

	1		
Part No.	103106	Ref. No.	RB0935
description	gas tap shaft ø 6x7mm shaft L 21mm gas outlet 1/4"		

gas thermostats

SIT

710 Minisit series

	1			
Part No.	101132	Ref. No.	RB0657	
description	gas thermostat SIT type MINISIT 710 t.max. 340°C 100-340°C gas inlet 1/2" gas outlet 3/8" thermocouple connection M9x1 pilot connection M10x1 probe ø 5mm probe L 68mm capillary pipe 1050mm probe type type B1 pressure controller no pressure regulator mbar gland nut ignition gas no			
spare parts for	101132			
	Part No.	101053	Ref. No.	—
	magnet unit T1: M9x1 T2: M24x1 L 45mm ø 17mm suitable for Minisit			
	Part No.	102102	Ref. No.	—
	probe 100-340°C probe ø 5mm probe L 68mm capillary pipe 1750mm t.max. 340°C oven/grill probe type type B1 suitable for MINISIT 710			
accessories for	101132			
	Part No.	100809	Ref. No.	—
	O-ring EPDM thickness 2mm ID ø 21mm Qty 1 pcs			
	Part No.	100904	Ref. No.	—
	locking screw M10x1 for pipe ø 4mm Qty 1 pcs			
	Part No.	100905	Ref. No.	—
	locking screw M10x1 for pipe ø 6mm Qty 1 pcs			
	Part No.	101054	Ref. No.	—
	magnet unit T1: M10x1 T2: M24x1 L 45mm ø 17mm suitable for Minisit			
	Part No.	101136	Ref. No.	—
	piezoelectric igniter suitable for Minisit with cover cap ømm connection F6.3x0.8			
	Part No.	101137	Ref. No.	—
	cover cap without piezoelectric igniter			
	Part No.	101267	Ref. No.	—
	reducer IT 3/8" ET 1/2" L 21mm			



Table continues overleaf



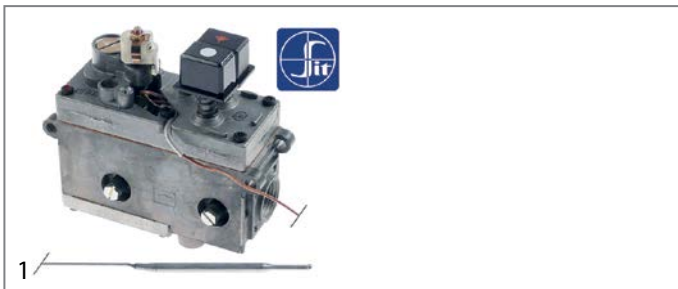

accessories for		101132	
	Part No.	101268	Ref. No. —
gas connection thread 3/8" angled with O-ring MINISIT 710			
	Part No.	101269	Ref. No. —
gas connection thread 1/2" angled with O-ring MINISIT 710			
	Part No.	101270	Ref. No. —
screw connection IT 3/8" ET 3/8" L 28mm			
	Part No.	101272	Ref. No. —
screw connection IT 1/2" ET 3/8" L 57mm			
	Part No.	101273	Ref. No. —
olive for pipe ø 12mm L 9.5mm brass Qty 1 pcs suitable for universal			
	Part No.	101274	Ref. No. —
olive for pipe ø 16mm Qty 1 pcs			
	Part No.	101275	Ref. No. —
union screw thread 1/2" for pipe ø 16mm Qty 1 pcs			
	Part No.	101276	Ref. No. —
union screw thread 3/8" tube ø 12mm Qty 1 pcs			
	Part No.	110068	Ref. No. RB0652
knob suitable for Minisit ø 37mm			



Part No.	101131	Ref. No.	RB0666
description	gas thermostat without cap, button and angle SIT type MINISIT 710 t.max. 190°C 50-190°C gas inlet 1/2" gas outlet 3/8" thermocouple connection M9x1 pilot connection M10x1 probe ø 5mm probe L 98mm capillary pipe 1200mm probe type type A2 pressure controller no pressure regulator or bar gland nut		

spare parts for		101131	
	Part No.	101053	Ref. No. —
magnet unit T1: M9x1 T2: M24x1 L 45mm ø 17mm suitable for Minisit			
	Part No.	102103	Ref. No. —
probe 60-200°C probe ø 5mm probe L 98mm capillary pipe 1050mm t.max. 200°C fryer probe type type A2 suitable for MINISIT 710			

accessories for		101131	
	Part No.	100809	Ref. No. —
O-ring EPDM thickness 2mm ID ø 21mm Qty 1 pcs			
	Part No.	100820	Ref. No. —
gland duct ET M14x1.5 IT M10x0.75 probe ø max. 6.5mm WS 22			
	Part No.	100904	Ref. No. —
locking screw M10x1 for pipe ø 4mm Qty 1 pcs			

accessories for		101131	
	Part No.	100905	Ref. No. —
locking screw M10x1 for pipe ø 6mm Qty 1 pcs			
	Part No.	101054	Ref. No. —
magnet unit T1: M10x1 T2: M24x1 L 45mm ø 17mm suitable for Minisit			
	Part No.	101136	Ref. No. —
piezoelectric igniter suitable for Minisit with cover cap ømm connection F6.3x0.8			
	Part No.	101137	Ref. No. —
cover cap without piezoelectric igniter			
	Part No.	101267	Ref. No. —
reducer IT 3/8" ET 1/2" L 21mm			
	Part No.	101268	Ref. No. —
gas connection thread 3/8" angled with O-ring MINISIT 710			
	Part No.	101269	Ref. No. —
gas connection thread 1/2" angled with O-ring MINISIT 710			
	Part No.	101270	Ref. No. —
screw connection IT 3/8" ET 3/8" L 28mm			
	Part No.	101272	Ref. No. —
screw connection IT 1/2" ET 3/8" L 57mm			
	Part No.	101273	Ref. No. —
olive for pipe ø 12mm L 9.5mm brass Qty 1 pcs suitable for universal			
	Part No.	101274	Ref. No. —
olive for pipe ø 16mm Qty 1 pcs			
	Part No.	101275	Ref. No. —
union screw thread 1/2" for pipe ø 16mm Qty 1 pcs			
	Part No.	101276	Ref. No. —
union screw thread 3/8" tube ø 12mm Qty 1 pcs			
	Part No.	110068	Ref. No. RB0652
knob suitable for Minisit ø 37mm			

PEL

25ST series



Part No.	101172	Ref. No.	RB1216
description	gas thermostat PEL type 25ST 100-300°C gas inlet M16x1.5 (tube ø 10mm) bypass nozzle ø 0.35mm gas outlet M16x1.5 (tube ø 10/8mm) thermocouple connection M9x1 pilot connection M10x1 capillary pipe 1200mm probe ø 6mm probe L 100mm shaft ø 8x6.5mm shaft L 21/15mm shaft flat upper		
spare parts for		101172	
	Part No.	100259	Ref. No. —
bypass nozzle type PEL22 bore ø 0.35mm thread M6x0.5			

Table continues overleaf



spare parts for		101172	
Part No.	101060	Ref. No.	RB0661
	magnet unit standard L 39mm D1 ø 15.4mm D2 ø 11mm suitable for PEL20-21/JUNKERS/EGA		
Part No.	106200	Ref. No.	—
	nut thread M9x1 suitable for PEL 24/25S		
accessories for		101172	
Part No.	100908	Ref. No.	—
	union screw thread M10x1 for pipe ø 4mm Qty 1 pcs		
Part No.	100909	Ref. No.	—
	union screw thread M10x1 for pipe ø 6mm Qty 1 pcs		
Part No.	101246	Ref. No.	—
	olive for pipe ø 4mm Qty 1 pcs		
Part No.	101278	Ref. No.	—
	olive for pipe ø 10mm Qty 1 pcs		
Part No.	101286	Ref. No.	—
	olive ID ø 6mm Qty 1 pcs		
Part No.	101300	Ref. No.	—
	union nut thread M16x1.5 tube ø 10mm		
Part No.	101450	Ref. No.	—
	olive for pipe ø 8mm L 12.7mm Qty 1 pcs ED ø 10mm		
Part No.	101451	Ref. No.	—
	union nut thread M16x1.5 tube ø 8mm		
Part No.	110079	Ref. No.	—
	knob dial plate gas thermostat 1-8 silver		
Part No.	110081	Ref. No.	—
	knob ø 70mm shaft ø 8x6.5mm shaft flat universal		

gas valves and ignition boxes







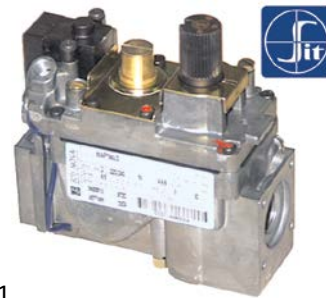



gas control valves

SIT











NOVASIT







1

Part No.	101162	Ref. No.	RB1200
description	gas valve SIT series Novasit 820 230V 50Hz gas inlet 1/2" gas outlet 1/2" thermocouple connection M9x1 pilot connection M10x1 ignition pressure 3-5mbar pressure range 3-30mbar pressure regulator connection blind equiv. no. 0.820.010		
spare parts for		101162	
	Part No.	101065	Ref. No. —
magnet unit with cable L 44mm D1 ø 30mm D2 ø 20mm suitable for NOVASIT			
	Part No.	101313	Ref. No. RB1197
solenoid coil 230V 50Hz			
accessories for		101162	
	Part No.	100006	Ref. No. —
piezoelectric igniter suitable for ELETROSIT body plastic blowing connection ø2.4mm ø 14mm			
	Part No.	101305	Ref. No. —
gas connection straight 1/2" flange 45x45mm ELETROSIT/V4400/4600/4605 suitable for SIT/HONEYWELL hole distance 36x36mm			
	Part No.	101306	Ref. No. RB1224
gas connection angled flange 45x45mm hole distance 36x36mm 1/2" ELETROSIT/V4400/4600/4605 screw with O-ring suitable for SIT/HONEYWELL			
	Part No.	101307	Ref. No. RB1225
gas connection straight flange 45x45mm hole distance 36x36mm 3/4" ELETROSIT/V4400/4600/4605 screw with O-ring suitable for SIT/HONEYWELL			
	Part No.	101308	Ref. No. —
gas connection angled flange 45x45mm hole distance 36x36mm 3/4" ELETROSIT/V4400/4600/4605 screw with O-ring suitable for SIT/HONEYWELL			
	Part No.	101312	Ref. No. RB1199
microswitch			
	Part No.	101314	Ref. No. —
solenoid coil 24V 50Hz			
	Part No.	101317	Ref. No. RB1201
plug with cable L 1000mm suitable for NOVASIT			
	Part No.	101318	Ref. No. —
cover cap for solenoid coil suitable for NOVASIT			





			
1			
Part No.	101540	Ref. No.	RB0983
description	gas valve SIT series Novasit 822 230V 50Hz gas inlet 1/2" gas outlet 1/2" thermocouple connection pilot connection closed ignition pressure 3-5mbar pressure range 3-30mbar pressure regulator connection blind equiv. no. 0.822.113		
spare parts for	101540		
	Part No.	101313	Ref. No. RB1197
	solenoid coil 230V 50Hz		
	Part No.	101542	Ref. No. RB1196
	solenoid coil 50Hz NOVA 822/826/827 suitable for NOVASIT 230V		
accessories for	101540		
	Part No.	101305	Ref. No. —
	gas connection straight 1/2" flange 45x45mm ELETTROSIT/V4400/4600/4605 suitable for SIT/HONEYWELL hole distance 36x36mm		
	Part No.	101306	Ref. No. RB1224
	gas connection angled flange 45x45mm hole distance 36x36mm 1/2" ELETTROSIT/V4400/4600/4605 screw with O-ring suitable for SIT/HONEYWELL		
	Part No.	101307	Ref. No. RB1225
	gas connection straight flange 45x45mm hole distance 36x36mm 3/4" ELETTROSIT/V4400/4600/4605 screw with O-ring suitable for SIT/HONEYWELL		
	Part No.	101308	Ref. No. —
	gas connection angled flange 45x45mm hole distance 36x36mm 3/4" ELETTROSIT/V4400/4600/4605 screw with O-ring suitable for SIT/HONEYWELL		
	Part No.	101317	Ref. No. RB1201
	plug with cable L 1000mm suitable for NOVASIT		
	Part No.	101503	Ref. No. —
	O-ring EPDM thickness 2mm ID ø 32mm Qty 1 pcs		
	Part No.	101924	Ref. No. —
	plug with cable L 1090mm suitable for NOVA 822/826/827		

accessories			
			
1			
Part No.	101306	Ref. No.	RB1224
description	gas connection angled flange 45x45mm hole distance 36x36mm 1/2" ELETTROSIT/V4400/4600/4605 screw with O-ring suitable for SIT/HONEYWELL		
spare parts for	101306		
	Part No.	517104	Ref. No. —
	O-ring EPDM thickness 2.62mm ID ø 31.42mm Qty 1 pcs		



			
1			
Part No.	101307	Ref. No.	RB1225
description	gas connection straight flange 45x45mm hole distance 36x36mm 3/4" ELETTROSIT/V4400/4600/4605 screw with O-ring suitable for SIT/HONEYWELL		
spare parts for	101307		
	Part No.	101503	Ref. No. —
	O-ring EPDM thickness 2mm ID ø 32mm Qty 1 pcs		

			
1			
Part No.	101312	Ref. No.	RB1199
description	microswitch		

			
1			
Part No.	101317	Ref. No.	RB1201
description	plug with cable L 1000mm suitable for NOVASIT		

			
1			
Part No.	101776	Ref. No.	RB0984
description	plug with cable L 905mm suitable for NOVA 822/826/827		

			
1			
Part No.	109128	Ref. No.	RB0600
description	pressure controller brass L 25mm ø 11.5mm thread M13x1 for gas valve suitable for gas valves Qty 1 pcs		













			
1			
Part No.	101313	Ref. No.	RB1197
description	solenoid coil 230V 50Hz		
accessories for	101313		
	Part No.	550896	Ref. No. —
	gasket with screw gas valves NOVASIT		







			
1			
Part No.	101542	Ref. No.	RB1196
description	solenoid coil 50Hz NOVA 822/826/827 suitable for NOVASIT 230V		

ignition parts

pilot burners

SIT			
100 series			
			
1			
Part No.	106904	Ref. No.	RB1004
description	pilot burner SIT type 100 series 1 flame nozzle ø 0.2mm gas connection 6mm		
spare parts for	106904		
	Part No.	100245	Ref. No. —
	pilot burner nozzle LPG code 20 bore ø 0.2mm Qty 1 pcs thread M8x0.75		
	Part No.	100855	Ref. No. —
	pilot burner bracket triple		
	Part No.	100885	Ref. No. RB0704
	air mixing sleeve for pilot burner Qty 1 pcs		
	Part No.	100916	Ref. No. —
	compression spring for pilot burner Qty 1 pcs		
	Part No.	100917	Ref. No. —
	gasket for pilot burner Qty 1 pcs aluminium		
	Part No.	100918	Ref. No. —
	screw for pilot burner		
	Part No.	107160	Ref. No. RB0675
	pilot burner cap SIT 1 flame Hmm Lmm Qty 1 pcs		
	Part No.	107166	Ref. No. —
	pilot burner head SIT 1 flame Hmm Lmm Qty 1 pcs		
	Part No.	107701	Ref. No. —
	pilot burner bottom part SIT 100 series nozzle ø 0.2mm		
accessories for	106904		
	Part No.	100246	Ref. No. —
	pilot burner nozzle natural gas bore ø 0.35mm Qty 1 pcs thread M8x0.75		
	Part No.	100904	Ref. No. —
	locking screw M10x1 for pipe ø 4mm Qty 1 pcs		
	Part No.	100905	Ref. No. —
	locking screw M10x1 for pipe ø 6mm Qty 1 pcs		

accessories for	106904		
	Part No.	102110	Ref. No. —
	pilot tube copper pipe ø 4mm thickness 1mm L 3000mm		
	Part No.	102111	Ref. No. —
	pilot tube copper pipe ø 6mm thickness 1mm L 3000mm		
	Part No.	107171	Ref. No. —
	pilot burner nozzle SIT natural/liquid gas bore ø 0.25mm Qty 1 pcs		
	Part No.	107700	Ref. No. —
	pilot burner bottom part SIT 100 series nozzle ø 0.25mm		
	Part No.	107702	Ref. No. —
	pilot burner bottom part SIT 100 series nozzle ø 0.35mm		













			
1			
Part No.	106907	Ref. No.	RB0664
description	pilot burner SIT type 100 series 3 flames nozzle ø 0.35mm gas connection 6mm		
spare parts for	106907		
	Part No.	100246	Ref. No. —
	pilot burner nozzle natural gas bore ø 0.35mm Qty 1 pcs thread M8x0.75		
	Part No.	100855	Ref. No. —
	pilot burner bracket triple		
	Part No.	100885	Ref. No. RB0704
	air mixing sleeve for pilot burner Qty 1 pcs		
	Part No.	100916	Ref. No. —
	compression spring for pilot burner Qty 1 pcs		
	Part No.	100917	Ref. No. —
	gasket for pilot burner Qty 1 pcs aluminium		
	Part No.	100918	Ref. No. —
	screw for pilot burner		
	Part No.	107162	Ref. No. —
	pilot burner cap SIT 3 flames Hmm Lmm Qty 1 pcs		
	Part No.	107702	Ref. No. —
	pilot burner bottom part SIT 100 series nozzle ø 0.35mm		
accessories for	106907		
	Part No.	100245	Ref. No. —
	pilot burner nozzle LPG code 20 bore ø 0.2mm Qty 1 pcs thread M8x0.75		
	Part No.	100904	Ref. No. —
	locking screw M10x1 for pipe ø 4mm Qty 1 pcs		

Table continues overleaf



accessories for		106907	
	Part No.	100905	Ref. No. —
locking screw M10x1 for pipe ø 6mm Qty 1 pcs			
	Part No.	102110	Ref. No. —
pilot tube copper pipe ø 4mm thickness 1mm L 3000mm			
	Part No.	102111	Ref. No. —
pilot tube copper pipe ø 6mm thickness 1mm L 3000mm			
	Part No.	107171	Ref. No. —
pilot burner nozzle SIT natural/liquid gas bore ø 0.25mm Qty 1 pcs			
	Part No.	107700	Ref. No. —
pilot burner bottom part SIT 100 series nozzle ø 0.25mm			
	Part No.	107701	Ref. No. —
pilot burner bottom part SIT 100 series nozzle ø 0.2mm			

accessories			
pilot burner caps			
	1		
Part No.	107160	Ref. No.	RB0675
description pilot burner cap SIT 1 flame Hmm Lmm Qty 1 pcs			

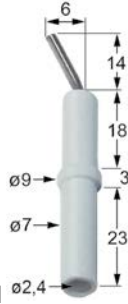
ignition electrodes			
	1		
Part No.	100707	Ref. No.	DM0092
description ignition electrode D1 ø 7mm D2 ø 9mm connection ø 2.4mm L1 14mm L2 6mm BL1 18mm BL2 3mm BL3 23mm to clip Qty 1 pcs			

miscellaneous			
	1		
Part No.	100885	Ref. No.	RB0704
description air mixing sleeve for pilot burner Qty 1 pcs			

ROBERTSHAW

pilot burners

universal series - type 6

Width of caps:
 6CH10 = 1" (25,4mm)
 6CH14 = 1½" (38,1mm)
 6CH24 = 2½" (63,5mm)
 6CH30 = 3" (76,2mm)

	1		
Part No.	106346	Ref. No.	DM1164
description pilot burner ROBERTSHAW type 6CH14-10 3 flames natural gas code 22 for pipe ø 1/4" CCT gas connection 1/4" CCTmm			

producer-specific pilot burners

ILLICO











	1		
Part No.	107518	Ref. No.	RB0664-10
description pilot burner 1 flame nozzle ø 0.2mm burner bearing upper			
spare parts for 107518			
	Part No.	100245	Ref. No. —
pilot burner nozzle LPG code 20 bore ø 0.2mm Qty 1 pcs thread M8x0.75			
	Part No.	107701	Ref. No. —
pilot burner bottom part SIT 100 series nozzle ø 0.2mm			
accessories for 107518			
	Part No.	100246	Ref. No. —
pilot burner nozzle natural gas bore ø 0.35mm Qty 1 pcs thread M8x0.75			
	Part No.	100904	Ref. No. —
locking screw M10x1 for pipe ø 4mm Qty 1 pcs			
	Part No.	100905	Ref. No. —
locking screw M10x1 for pipe ø 6mm Qty 1 pcs			
	Part No.	102110	Ref. No. —
pilot tube copper pipe ø 4mm thickness 1mm L 3000mm			
	Part No.	102111	Ref. No. —
pilot tube copper pipe ø 6mm thickness 1mm L 3000mm			

Table continues overleaf



accessories for	107518			
	Part No.	102742	Ref. No.	—
	pilot burner nozzle LPG code 25 bore \varnothing 0.25mm Qty 1 pcs			

1 				
Part No.	104450	Ref. No.	DM1158	
description	pilot burner 1 natural gas nozzle \varnothing 0.25mm			

1 				
Part No.	104623	Ref. No.	DM1159	
description	pilot burner 2 LPG nozzle \varnothing 0.148mm			

1 				
Part No.	104449	Ref. No.	DE0005 DM0298	
description	ignition electrode flange length 64mm flange width 30mm D1 \varnothing 8mm			

electrodes

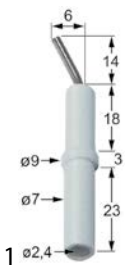
				
Part No.	100707	Ref. No.	DM0092	
description	ignition electrode D1 \varnothing 7mm D2 \varnothing 9mm connection \varnothing 2.4mm L1 14mm L2 6mm BL1 18mm BL2 3mm BL3 23mm to clip Qty 1 pcs			

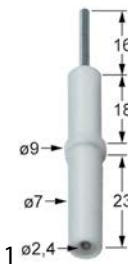
				
Part No.	102330	Ref. No.	DM5092	
description	ignition electrode D1 \varnothing 7mm D2 \varnothing 9mm L1 16mm BL1 18mm BL2 3mm BL3 23mm to clip connection \varnothing 2.4mm			

ignition cables

terminals and connectors

1 				
Part No.	100112	Ref. No.	DE0092	
description	female bullet size 2mm 0.25-1.0mm ² CuZn gal Sn t.max. 125°C Qty 20 pcs			

ignition units

1 				
Part No.	102388	Ref. No.	DE0264	
description	ignition unit outputs 4 230VAC dimensions 111x23x34mm mounting distance 100mm inlet F6.3x0.8 outlet F2.8x0.8 type WAC-T4 0.6VA 50/60Hz			

thermocouples

thermocouple sets universal

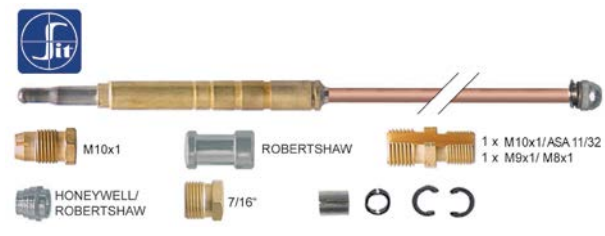
1 				
Part No.	107647	Ref. No.	RB0710	
description	thermocouple set SIT 11-piece L 900mm			



1

Part No.	102003	Ref. No.	RB0710
description	thermocouple set 10-piece L 900mm		

plug-in thermocouples
 plug-in thermocouples standard
 with barrel socket $\varnothing 6(6.5)$ mm
 thermocouples SIT

1

Part No.	107612	Ref. No.	RB0714
description	thermocouple SIT M9x1 L 1000mm plug connection $\varnothing 6.0(6.5)$ mm		

1

Part No.	107614	Ref. No.	RB0713
description	thermocouple SIT M9x1 L 1500mm plug connection $\varnothing 6.0(6.5)$ mm		

1

Part No.	107609	Ref. No.	RB0712
description	thermocouple SIT M9x1 L 600mm plug connection $\varnothing 6.0(6.5)$ mm		

plug-in thermocouples with interruption

1

Part No.	102238	Ref. No.	RB0715
description	thermocouple with interrupter M9x1 L 600mm M10x1 F 6.3mm		

extensions

1

Part No.	102241	Ref. No.	RB1223
description	thermocouple extension flexible thread M9x1 - M9x1 L 500mm		

1

Part No.	102013	Ref. No.	RB0711	
description	thermocouple extension thread M9x1 L 500mm			
accessories for	102013			
	Part No.	101261	Ref. No.	—
	thermocouple fitting thread M9x1 Qty 1 pcs			

accessories

interrupters

1

Part No.	101265	Ref. No.	RB0658
description	interrupter thread M9x1		



gas burners

hob burners

producer-specific hob burners

MORICE

859 series



1			
Part No.	107058	Ref. No.	N/A
description	burner type 859 ø 80mm L 175mm complete		



1			
Part No.	108002	Ref. No.	N/A
description	burner head ø 79mm seat ø 32mm H 50mm		



1			
Part No.	108001	Ref. No.	BR0182 1
description	burner ring ø 73mm		





universal



1			
Part No.	107033	Ref. No.	BR0107 BR0107 1
description	burner ø 115mm complete		



1			
Part No.	107031	Ref. No.	BR0101 BR0101 1
description	burner ø 60mm complete		

1			
Part No.	107032	Ref. No.	BR0095 BR0095 1
description	burner ø 88mm complete		
spare parts for	107032		
	Part No.	108029	Ref. No.
			BR0097
	burner cap ø 88mm with ring		
	Part No.	108122	Ref. No.
			BR0095.100 N/A
	burner head for burner cap ø 88mm		
accessories for	107032		
	Part No.	106535	Ref. No.
			—
	gas injector thread 3/8" WS 17 bore ø 1.3mm		
	Part No.	106540	Ref. No.
			—
	gas injector thread 3/8" WS 17 bore ø 1.8mm		

1			
Part No.	108030	Ref. No.	BR0109
description	burner cap ø 115mm with ring		

1			
Part No.	108028	Ref. No.	BR0103
description	burner cap ø 60mm with ring		

1			
Part No.	108029	Ref. No.	BR0097
description	burner cap ø 88mm with ring		

1			
Part No.	108123	Ref. No.	N/A
description	burner head for burner cap ø 115mm		



			
1			
Part No.	108121	Ref. No.	N/A
description	burner head for burner cap ø 60mm		

			
1			
Part No.	108122	Ref. No.	BR0095.100 N/A
description	burner head for burner cap ø 88mm		

			
1			
Part No.	107034	Ref. No.	BR0079
description	burner ø 145mm complete		

			
1			
Part No.	107192	Ref. No.	DM1249
description	burner cap ø 145mm		

pan supports

			
1			
Part No.	107100	Ref. No.	GI9037 PQ8755
description	pan support W 290mm L 320mm		

			
1			
Part No.	107101	Ref. No.	5756 1 GI9036
description	pan support W 330mm L 440mm		

			
1			
Part No.	107102	Ref. No.	5757 1 PQ0757
description	pan support W 330mm L 440mm		

reducers for pan supports

			
1			
Part No.	107035	Ref. No.	PQ0758 PQ0758 1
description	reducer for pan support L 170mm W 170mm		

spillage trays

			
1			
Part No.	109127	Ref. No.	DV8241 1
description	drain tray L 430mm W 318mm H 42mm ø 140mm hole ø 6mm hole distance 303mm		

accessories

reducers for pan supports

			
1			
Part No.	107035	Ref. No.	PQ0758 PQ0758 1
description	reducer for pan support L 170mm W 170mm		



1			
Part No.	210057	Ref. No.	GI9035
description	reducer for pan support L 188mm W 188mm		

pan supports			
1			
Part No.	107100	Ref. No.	GI9037 PQ8755
description	pan support W 290mm L 320mm		

1			
Part No.	107101	Ref. No.	5756 1 GI9036
description	pan support W 330mm L 440mm		

1			
Part No.	107102	Ref. No.	5757 1 PQ0757
description	pan support W 330mm L 440mm		

spillage trays			
1			
Part No.	109127	Ref. No.	DV8241 1
description	drain tray L 430mm W 318mm H 42mm ø 140mm hole ø 6mm hole distance 303mm		

gas nozzles

main nozzles

gas nozzles 3/8"

1			
Part No.	106529	Ref. No.	IN0483
description	gas injector thread 3/8" WS 17 bore ø 0.9mm		

1			
Part No.	106533	Ref. No.	IN0488
description	gas injector thread 3/8" WS 17 bore ø 1.15mm		

1			
Part No.	106538	Ref. No.	IN0514
description	gas injector thread 3/8" WS 17 bore ø 1.6mm		

burner nozzles

1			
Part No.	102899	Ref. No.	DM1186
description	burner nozzle LPG code BP148 type F111		

1			
Part No.	102898	Ref. No.	DM1185
description	burner nozzle natural gas type F111		



auxiliary gas parts

gas pressure regulators

Standard pressure according to country:

Germany 50mbar

France 37mbar

Italy 30mbar

Spain 37/50mbar

UK 20mbar



1

Part No.	250010	Ref. No.	RB1303
-----------------	--------	-----------------	--------

description	gas pressure regulator 8kg/h output pressure 37mbar		
--------------------	---	--	--

gas hoses

NF D36-123



1

Part No.	250025	Ref. No.	DM0383
-----------------	--------	-----------------	--------

description	gas hose L 1000mm 3/4" ET - 3/4" ET flex hose plastic-coated NF D36-123 with Viton gasket p max 2bar DN20		
--------------------	---	--	--

accessories for	250025		
------------------------	--------	--	--

Part No.	104663	Ref. No.	—
-----------------	--------	-----------------	---

description	snap-on connection thread 3/4" - 3/4" 3/4" - 3/4"		
--------------------	---	--	--

Part No.	250122	Ref. No.	—
-----------------	--------	-----------------	---

description	screw connection thread 3/4" DN15 Qty 1 pcs		
--------------------	---	--	--



1

Part No.	250020	Ref. No.	DM0411
-----------------	--------	-----------------	--------

description	gas hose L 1250mm 1/2" IT - 1/2" IT flex hose plastic-coated NF D36-123 with Viton gasket p max 2bar DN15		
--------------------	---	--	--

accessories for	250020		
------------------------	--------	--	--

Part No.	104662	Ref. No.	—
-----------------	--------	-----------------	---

description	snap-on connection thread 1/2" - 1/2" 1/2" - 1/2"		
--------------------	---	--	--

Part No.	250097	Ref. No.	—
-----------------	--------	-----------------	---

description	connection set with gasket thread 1/2" AG - 1/2" IG & 1/2" AG - M20x1,5 IG adaptor 1/2" ET - M20x1.5 IT angle piece 1/2" IT - 1/2" ET 2 gaskets		
--------------------	---	--	--

equipment-specific units

for espresso machines

brewing units

filter holder gaskets

O-rings



1

Part No.	510409	Ref. No.	DM0578
-----------------	--------	-----------------	--------

description	O-ring EPDM thickness 5.34mm ID ø 56.52mm Qty 1 pcs		
--------------------	---	--	--

for deep fryers

miscellaneous



1

Part No.	696488	Ref. No.	DV0890 1
-----------------	--------	-----------------	----------

description	connecting piece for fryer L 250mm W 20mm H 1mm		
--------------------	---	--	--

for convection ovens/combi-steamers

doors



1

Part No.	696430	Ref. No.	DM0933
-----------------	--------	-----------------	--------

description	bush L 11mm H 11mm D1 ø 11mm D2 ø 16mm ID ø 6.5mm		
--------------------	---	--	--



1

Part No.	696431	Ref. No.	DM0334
-----------------	--------	-----------------	--------

description	suppressor for glass plate H 10mm ø 20mm ID ø 8.5mm		
--------------------	---	--	--



door mechanics

miscellaneous



1

Part No.	696430	Ref. No.	DM0933
description	bush L 11mm H 11mm D1 ø 11mm D2 ø 16mm ID ø 6.5mm		



1

Part No.	696431	Ref. No.	DM0334
description	suppressor for glass plate H 10mm ø 20mm ID ø 8.5mm		

for ovens

level glasses



1

Part No.	696486	Ref. No.	DV1113 1 DV113 1
description	level glass ø 50mm chrome-plated for oven		

for pizza ovens

miscellaneous



1

Part No.	696487	Ref. No.	DV2002 DV2002 1
description	fixing plate for door spring L 90mm W 25mm H 3mm		

knobs

universal knobs



1

Part No.	110253	Ref. No.	DE0203
description	knob switch zero mark t.max.°C ø 50mm shaft ø 6x4.6mm shaft flat upper black		



1

Part No.	110245	Ref. No.	TH1075
description	knob thermostat t.max. 300°C ø 50mm shaft ø 6x4.6mm shaft flat upper black temperature range 50-300°C		



1

Part No.	110247	Ref. No.	TH1077
description	knob thermostat t.max. 350°C ø 50mm shaft ø 6x4.6mm shaft flat upper black temperature range 100-350°C		



1

Part No.	110075	Ref. No.	DE0951
description	knob energy regulator 1-3 t.max.°C ø 50mm shaft ø 6x4.6mm shaft flat upper black		

accessories for 110075



Part No.	110135	Ref. No.	TH1067
description	rosette knob up to ø 52mm		



producer-specific knobs

MORICE



1

Part No.	110075	Ref. No.	DE0951
description	knob energy regulator 1-3 t.max.°C° 50mm shaft ø 6x4.6mm shaft flat upper black		
accessories for	110075		
	Part No.	110135	Ref. No. TH1067
	rosette knob up to ø 52mm		



1

Part No.	112202	Ref. No.	DM1155 2
description	knob gas tap without ignition flame ø 52mm shaft ø 7x7mm black		



1

Part No.	112203	Ref. No.	DM2111 DM2111 1
description	knob gas tap without ignition flame ø 72mm shaft ø 8x6.5mm shaft flat lower black		



1

Part No.	112632	Ref. No.	DM2111 DM2111 1
description	knob gas tap without ignition flame ø 73mm shaft ø 8x6.5mm shaft flat lower black/red		



1

Part No.	112204	Ref. No.	DM2119
description	knob gas tap without ignition flame t.max.°C° ø 72mm shaft ø 10x8mm shaft flat right black		



1

Part No.	110253	Ref. No.	DE0203
description	knob switch zero mark t.max.°C° ø 50mm shaft ø 6x4.6mm shaft flat upper black		



1

Part No.	112631	Ref. No.	DM1152 DM1152 1
description	knob t.max.°C° ø 73mm shaft ø 7x7mm black/red		



1

Part No.	110245	Ref. No.	TH1075
description	knob thermostat t.max. 300°C ø 50mm shaft ø 6x4.6mm shaft flat upper black temperature range 50-300°C		



1

Part No.	110247	Ref. No.	TH1077
description	knob thermostat t.max. 350°C ø 50mm shaft ø 6x4.6mm shaft flat upper black temperature range 100-350°C		



accessories

knob adaptors



Part No.	696432	Ref. No.	DM9555
description	knob adaptor shaft ø 6.3x7.7mm		

rosettes



Part No.	110135	Ref. No.	TH1067
description	rosette knob up to ø 52mm		

locks

turning lever locks

universal

RAHRBACH



Part No.	690027	Ref. No.	DM0792
description	handle latch left L 150mm H 59mm		

accessories for 690027

	Part No.	690045	Ref. No.	—
	door catch mounting pos. left off-set 20mm L 110mm H 56mm W 33mm mounting distance 68/68mm zinc die cast series 6300			

	Part No.	690135	Ref. No.	DM0803
	door catch mounting pos. left off-set 38mm L 110mm H 74mm W 33mm mounting distance 68/68mm zinc die cast series 1750			

	Part No.	690137	Ref. No.	—
	sliding plate mounting pos. left L 28mm H 3mm W 21mm H2 12.5mm			



Part No.	690044	Ref. No.	DM0791
description	handle latch right L 185mm H 59mm handle material plastic type 6300 series		

accessories for 690044

	Part No.	690136	Ref. No.	—
	sliding plate mounting pos. right L 28mm H 3mm W 21mm H2 12.5mm			

accessories for 690044

	Part No.	700091	Ref. No.	—
	door catch mounting pos. right off-set 20mm L 110mm H 56mm W 33mm mounting distance 68/68mm zinc die cast series 6300			

	Part No.	700098	Ref. No.	DM0802
	door catch mounting pos. right off-set 38mm L 110mm H 74mm W 33mm mounting distance 68/68mm series 1750			



Part No.	690135	Ref. No.	DM0803
description	door catch mounting pos. left off-set 38mm L 110mm H 74mm W 33mm mounting distance 68/68mm zinc die cast series 1750		

spare parts for 690135

	Part No.	690137	Ref. No.	—
	sliding plate mounting pos. left L 28mm H 3mm W 21mm H2 12.5mm			



Part No.	700098	Ref. No.	DM0802
-----------------	--------	-----------------	--------

description door catch mounting pos. right off-set 38mm L 110mm H 74mm W 33mm mounting distance 68/68mm series 1750

spare parts for 700098

	Part No.	690136	Ref. No.	—
	sliding plate mounting pos. right L 28mm H 3mm W 21mm H2 12.5mm			

accessories for 700098

	Part No.	514281	Ref. No.	—
	base plate L 110mm W 35mm for door catch thickness 10mm			

STUV



Part No.	700098	Ref. No.	DM0802
-----------------	--------	-----------------	--------

description door catch mounting pos. right off-set 38mm L 110mm H 74mm W 33mm mounting distance 68/68mm series 1750

spare parts for 700098

	Part No.	690136	Ref. No.	—
	sliding plate mounting pos. right L 28mm H 3mm W 21mm H2 12.5mm			

accessories for 700098

	Part No.	514281	Ref. No.	—
	base plate L 110mm W 35mm for door catch thickness 10mm			





edgmount latches

handle latches

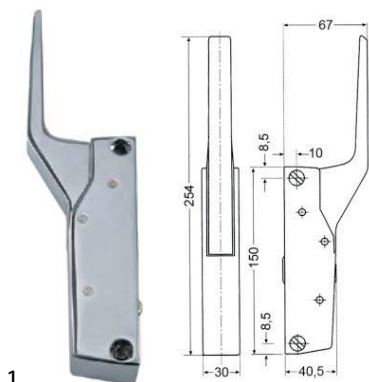
CAFF/FERMOD



1

Part No.	700060	Ref. No.	DM3460
description	handle latch L 150mm mounting distance 133mm non lockable heated units G 791		
accessories for	700060		
	Part No.	700061	Ref. No. —
	door catch L 58mm W 20mm H 35mm mounting distance 42mm chrome-plated brass for headed units		
	Part No.	700062	Ref. No. —
	handle protection heated units		

baskets

fryer baskets

MORICE



1

Part No.	970495	Ref. No.	DM0824
description	fryer basket L1 285mm W1 235mm H1 140mm L2 470mm H2 250mm SS		



1

Part No.	970783	Ref. No.	DM0825
description	fryer basket W1 235mm L1 370mm H1 140mm chrome-plated steel		

equipment feet and end caps

equipment feet

with screw mounting



1

Part No.	701097	Ref. No.	TP8001 1
description	equipment foot tube ø 50mm thread M8 H 164-220mm stainless steel Qty 1 pcs WS 30		

DERBY RUOTE

with bolt hole

stainless steel



1

Part No.	700223 ¹	Ref. No.	RL0978
description	swivel castor with swivel brake ø 125mm bolt hole bolt hole ø 12mm housing SS capacity 100kg bearing ball bearing wheel body polypropylene tread TPE tyres H 159mm wheel width 30mm Qty 1 pcs		

¹with swivel brake

pasta baskets

various



1

Part No.	970750	Ref. No.	DM0833
description	pasta basket H1 195mm W1 90mm L1 110mm H2 200mm		



shelves and shelf rails

chargrill grids



1

Part No.	210043	Ref. No.	D10401 GI0401
description	chargrill grid L 430mm W 365mm H 42mm chargrill		

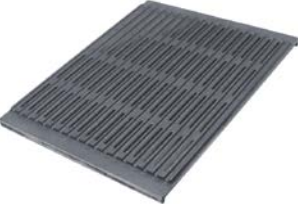

1

Part No.	210031	Ref. No.	PQ8795 1
description	chargrill grid L 470mm W 365mm H 26mm cast iron grill		



grates

universal

without upstand





1

Part No.	970120	Ref. No.	GI0414
description	grate W 325mm D 530mm GN 1/1 chrome-plated steel wire gauge frame 7mm lengthwise wires gauge 4mm crossing wires 1		
accessories for	970120		
	Part No.	690330	Ref. No. —
	rack L 1000mm W 22mm H 4mm aperture 3x8mm hole distance 12.5mm stainless steel		
	Part No.	694700	Ref. No. —
	shelf support L 31/28mm W 22mm H 18mm SS Qty 12 pcs		
	Part No.	694701	Ref. No. —
	shelf support L 31/28mm W 22mm H 17mm SS with hook Qty 12 pcs		





1

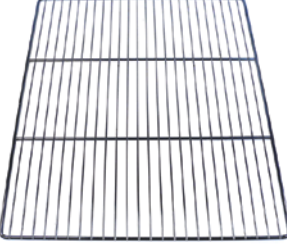

Part No.	970122	Ref. No.	GI0399
description	grate W 325mm D 530mm GN 1/1 H 8mm stainless steel wire gauge frame 7mm lengthwise wires gauge 4mm crossing wires 1		
accessories for	970122		
	Part No.	690330	Ref. No. —
	rack L 1000mm W 22mm H 4mm aperture 3x8mm hole distance 12.5mm stainless steel		
	Part No.	694700	Ref. No. —
	shelf support L 31/28mm W 22mm H 18mm SS Qty 12 pcs		
	Part No.	694701	Ref. No. —
	shelf support L 31/28mm W 22mm H 17mm SS with hook Qty 12 pcs		

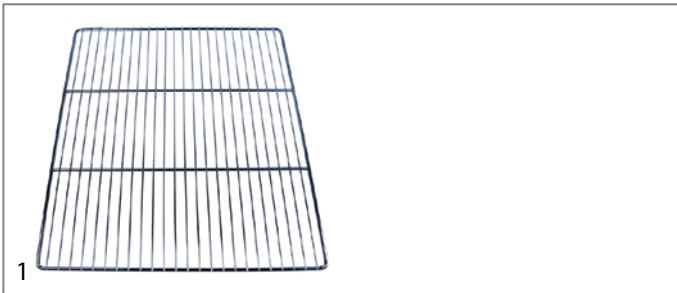

1

Part No.	970121	Ref. No.	GI0408
description	grate W 650mm D 530mm GN 2/1 chrome-plated steel crossing wires 2		
accessories for	970121		
	Part No.	690330	Ref. No. —
	rack L 1000mm W 22mm H 4mm aperture 3x8mm hole distance 12.5mm stainless steel		
	Part No.	694700	Ref. No. —
	shelf support L 31/28mm W 22mm H 18mm SS Qty 12 pcs		
	Part No.	694701	Ref. No. —
	shelf support L 31/28mm W 22mm H 17mm SS with hook Qty 12 pcs		



Part No.	970123	Ref. No.	GI0404
description	grate W 650mm D 530mm GN 2/1 stainless steel wire gauge frame 7.8mm lengthwise wires gauge 3.8mm crossing wires 2 suitable for refrigerator		
accessories for	970123		
	Part No.	690330	Ref. No. —
	rack L 1000mm W 22mm H 4mm aperture 3x8mm hole distance 12.5mm stainless steel		
	Part No.	694700	Ref. No. —
	shelf support L 31/28mm W 22mm H 18mm SS Qty 12 pcs		
	Part No.	694701	Ref. No. —
	shelf support L 31/28mm W 22mm H 17mm SS with hook Qty 12 pcs		

door seals

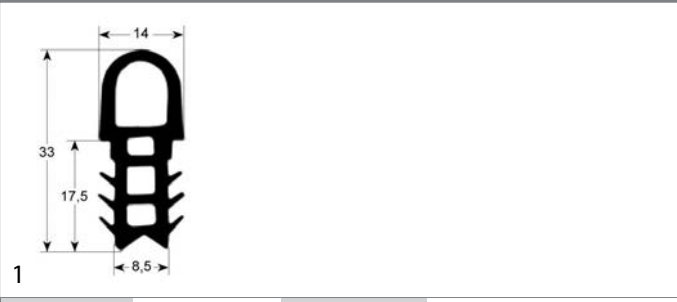

Part No.	901564	Ref. No.	DM1065
description	door seal profile 2060 W 464mm L 620mm external size Qty 1		



Part No.	901565	Ref. No.	DM1066
description	door seal profile 2060 W 624mm L 724mm external size Qty 1		

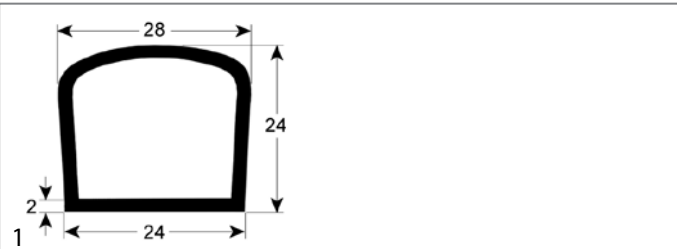

Part No.	901566	Ref. No.	DM0566
description	door seal profile 2200 W 510mm L 650mm external size Qty 1		

O-rings

EPDM

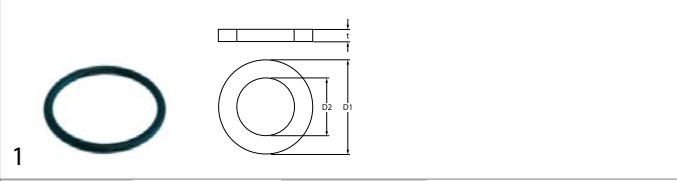

Part No.	510409	Ref. No.	DM0578
description	O-ring EPDM thickness 5.34mm ID ø 56.52mm Qty 1 pcs		

gaskets

refrigeration gaskets

screw-in gaskets

profile 9031

We offer custom-made gaskets for this profile



Part No.	901433	Ref. No.	DM0562
description	gasket profile 9031 W 185mm L 555mm external size suitable for ILLICO		

gaskets for heated units

window seals



Part No.	901563	Ref. No.	DM0549 DM0549 1
description	window gasket profile 1881 L 1400mm suitable for MORICE Qty 1		



sealing washers

silicone gaskets



1

Part No.	359721	Ref. No.	DM0495
description	gasket silicone ED ø 48mm ID ø 39.5mm thickness 5mm Qty 1 pcs		

special gaskets

miscellaneous



1

Part No.	694498	Ref. No.	DV2015 1 DV2015 2
description	gasket for pizza oven L 1600mm W 40mm external height 16mm		

springs

tension springs



1

Part No.	700891	Ref. No.	DM0922
description	tension spring ø 16mm total length 287mm wire gauge ø 2.2mm L1 50mm L2 187mm L3 50mm		

valves and tank inlets

ball valves

universal

ball valves with lever handle



1

Part No.	520282	Ref. No.	RB0938
description	ball valve connection 1" IT - 1" IT DN25 total length 67mm with lever handle		



1

Part No.	520281	Ref. No.	RB0966
description	ball valve connection 3/4" IT - 3/4" IT DN20 total length 56mm with lever handle handle length 87mm		

consumables

fuses

fine fuses



1

Part No.	358608	Ref. No.	DE0839
description	fine fuse size ø5x20mm 10A slow-acting rated 250V Qty 10 pcs		

GASTROPARTS.COM

