



**GASTROPARTS**

# Moretti

**[EN]** Equipment

**[DE]** Geräte

**[ES]** Aparatos

**[FR]** Équipement

**[IT]** Attrezzature

**[PL]** Urządzenia

**[RU]** Оборудование

✉ [gastroparts@gastroparts.com](mailto:gastroparts@gastroparts.com)

☎ tel. +48 56 657 00 66

📘 [fb.com/gastroparts.global](https://fb.com/gastroparts.global)

**GASTROPARTS.COM**





# heating elements

## heating elements for pizza ovens

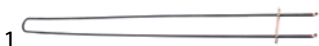

<b>Part No.</b>	418173	<b>Ref. No.</b>	74400540 74420540
<b>description</b>	heating element 1000W 230V L 1236mm W 75mm flange length 110mm flange width 22mm hole distance 94mm connection length 111mm connection male faston 6.3mm tube ø 8.5mm heating circuits 1 rectangular flange hole ø 6mm dry heating element		
<b>For models:</b>	RHC 18B, RHC 18C, RHC 18D, RHC 18PB, RHC 18PC, RHC 18PD, RHC 25B, RHC 25C, RHC 25PB, RHC 25PC, RHC 25PD, RHC-25D, RHK - RHC - RHB		



<b>Part No.</b>	418158	<b>Ref. No.</b>	74401130
<b>description</b>	heating element 1005W 115V L 660mm W 88mm flange length 124mm flange width 30mm hole distance 109mm connection length 108mm connection male faston 6.3mm tube ø 8.5mm heating circuits 1 rectangular flange mounting pos. upper hole ø 5mm dry heating element		
<b>For models:</b>	PIZZY DUO 105.105, PIZZY MONO 105.105		



<b>Part No.</b>	418165	<b>Ref. No.</b>	74420570
<b>description</b>	heating element 1092W 115V L 603mm W 95mm flange length 124mm flange width 22mm hole distance 112mm connection length 122mm connection male faston 6.3mm tube ø 8.5mm heating circuits 1 rectangular flange mounting pos. upper hole ø 6mm dry heating element		
<b>For models:</b>	MHC 18A, MHC 18B, MHC 18C, MHC 30A, MHC 30B, MHC 30C, MHK - MHC - MHB		

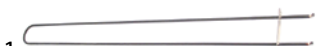

<b>Part No.</b>	418160	<b>Ref. No.</b>	74420600
<b>description</b>	heating element 1275W 115V L 1045mm W 89mm flange length 124mm flange width 30mm hole distance 107mm connection length 94mm tube ø 8.5mm heating circuits 1 rectangular flange mounting pos. upper hole ø 6.3mm dry heating element		
<b>For models:</b>	PIZZY DUO 105.105, PIZZY MONO 105.105		



<b>Part No.</b>	418168	<b>Ref. No.</b>	74420590
<b>description</b>	heating element 1275W 115V L 800mm W 94mm flange length 124mm flange width 30mm hole distance 108mm connection length 122mm connection male faston 6.3mm tube ø 8.5mm heating circuits 1 rectangular flange mounting pos. upper hole ø 6mm dry heating element		
<b>For models:</b>	MHC 18A, MHC 18B, MHC 18C, MHC 30A, MHC 30B, MHC 30C, MHK - MHC - MHB, PC-18C		



<b>Part No.</b>	418174	<b>Ref. No.</b>	74400550 74420550
<b>description</b>	heating element 1300W 230V L 1235mm W 75mm flange length 110mm flange width 22mm hole distance 94mm connection length 110mm connection male faston 6.3mm tube ø 8.5mm heating circuits 1 rectangular flange hole ø 6mm dry heating element		
<b>For models:</b>	RHC 18D, RHC 18PD, RHC 25PD, RHC-25D, RHK - RHC - RHB		



<b>Part No.</b>	418164	<b>Ref. No.</b>	74420350
<b>description</b>	heating element 400W 110V L 595mm W 95mm flange length 104mm flange width 22mm hole distance 112mm connection length 126mm connection male faston 6.3mm tube ø 8.5mm heating circuits 1 rectangular flange mounting pos. lower hole ø 6mm dry heating element		
<b>For models:</b>	MHC 18A, MHC 18PA, MHC 30A, MHC 30PA, MHK - MHC - MHB		



<b>Part No.</b>	418159	<b>Ref. No.</b>	74401140
<b>description</b>	heating element 460W 115V L 657mm W 90mm flange length 124mm flange width 30mm hole distance 108mm connection length 109mm connection male faston 6.3mm tube ø 9.1mm heating circuits 1 rectangular flange mounting pos. lower hole ø 5mm dry heating element		
<b>For models:</b>	PIZZY DUO 65.105, PIZZY MONO 65.105		



<b>Part No.</b>	418167	<b>Ref. No.</b>	74420370
<b>description</b>	heating element 500W 110V L 600mm W 95mm flange length 124mm flange width 22mm hole distance 118mm connection length 122mm connection male faston 6.3mm tube ø 8.5mm heating circuits 1 rectangular flange mounting pos. lower hole ø 6mm dry heating element		
<b>For models:</b>	MHC 18B, MHC 18PB, MHC 30B, MHC 30PB, MHK - MHC - MHB		



<b>Part No.</b>	418170	<b>Ref. No.</b>	74420410
<b>description</b>	heating element 560W 110V L 800mm W 97mm flange length 124mm flange width 30mm hole distance 108mm connection length 123mm connection male faston 6.3mm tube ø 8.5mm heating circuits 1 rectangular flange mounting pos. lower hole ø 6.3mm dry heating element		
<b>For models:</b>	MHC 18C, MHC 18PC, MHC 30C, MHC 30PC, MHK - MHC - MHB		



<b>Part No.</b>	418163	<b>Ref. No.</b>	74420340
<b>description</b>	heating element 600W 110V mounting pos. upper dry heating element		
<b>For models:</b>	MHC 18A, MHC 18PA, MHC 30A, MHC 30PA, MHK - MHC - MHB		

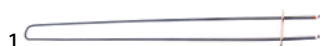

<b>Part No.</b>	418171	<b>Ref. No.</b>	74400830
<b>description</b>	heating element 625W 230V L 1235mm W 74mm flange length 110mm flange width 22mm hole distance 94mm connection length 106mm connection male faston 6.3mm tube ø 8.5mm heating circuits 1 rectangular flange hole ø 6mm dry heating element		
<b>For models:</b>	RHC 18B, RHC 18D, RHC 18PB, RHC 18PD, RHC 25B, RHC 25PB, RHC 25PD, RHC-25D, RHK - RHC - RHB		

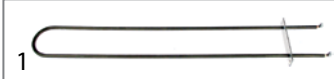
<b>Part No.</b>	416377	<b>Ref. No.</b>	74400720
<b>description</b>	heating element 700W 220V L 610mm W 80mm flange length 124mm flange width 30mm hole distance 108mm connection length 98mm connection male faston 6.3mm tube ø 8.5mm heating circuits 1 rectangular flange hole ø 4mm		



<b>Part No.</b>	418172	<b>Ref. No.</b>	74400760
<b>description</b>	heating element 700W 230V L 1238mm W 74mm flange length 110mm flange width 22mm hole distance 94mm connection length 110mm connection male faston 6.3mm tube ø 8.5mm heating circuits 1 rectangular flange hole ø 6mm dry heating element		
<b>For models:</b>	RHC 18C, RHC 18PC, RHC 25C, RHC 25PC, RHK - RHC - RHB		

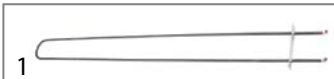

<b>Part No.</b>	418161	<b>Ref. No.</b>	74420610
<b>description</b>	heating element 728W 115V L 1041mm W 89mm flange length 124mm flange width 30mm hole distance 108mm connection length 92mm connection male faston 6.3mm tube ø 8.5mm heating circuits 1 rectangular flange mounting pos. lower hole ø 5.2mm dry heating element		
<b>For models:</b>	PIZZY DUO 105.105, PIZZY MONO 105.105		

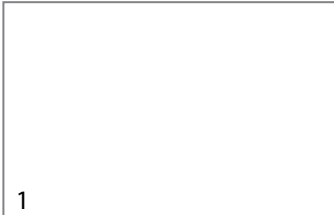

<b>Part No.</b>	418166	<b>Ref. No.</b>	74420360
<b>description</b>	heating element 750W 110V mounting pos. upper dry heating element		
<b>For models:</b>	MHC 18B, MHC 18PB, MHC 30B, MHC 30PB, MHK - MHC - MHB		

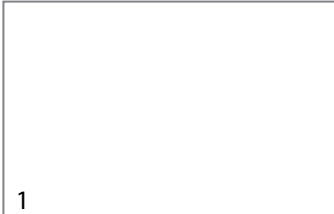

<b>Part No.</b>	418169	<b>Ref. No.</b>	74420400
<b>description</b>	heating element 850W 110V mounting pos. upper dry heating element		
<b>For models:</b>	MHC 18C, MHC 18PC, MHC 30C, MHC 30PC, MHK - MHC - MHB		

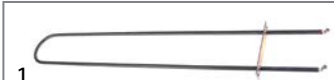

<b>Part No.</b>	418162	<b>Ref. No.</b>	74420560
<b>description</b>	heating element 910W 115V L 603mm W 97mm flange length 124mm flange width 22mm hole distance 102mm connection length 121mm connection male faston 6.3mm tube ø 8.8mm heating circuits 1 rectangular flange mounting pos. upper hole ø 5mm dry heating element		
<b>For models:</b>	MHC 18A, MHC 18B, MHC 18C, MHC 30A, MHC 30B, MHC 30C, MHK - MHC - MHB		



<b>Part No.</b>	418183	<b>Ref. No.</b>	74420850
<b>description</b>	heating element 1250W 230V L 1032mm mounting pos. upper ø 34mm tube ø 16mm thread M20x1.5 connection length 45mm connection M6 flange with thread heating circuits 1 dry heating element pizza oven		
<b>For models:</b>	T97E		



<b>Part No.</b>	418182	<b>Ref. No.</b>	74420750
<b>description</b>	heating element 1400W 230V L 775mm mounting pos. lower ø 34mm tube ø 16mm thread M20x1.5 connection length 63mm connection M6 heating circuits 1 dry heating element pizza oven		
<b>For models:</b>	T75E		



<b>Part No.</b>	418726	<b>Ref. No.</b>	74400260 74400390
<b>description</b>	heating element 1456W 230V heating circuits 1 dry heating element		
<b>For models:</b>	KR 9, KR 99, KRX 9, KRX 99, PIZZY DUO 105.105, PIZZY MONO 105.105		



<b>Part No.</b>	418181	<b>Ref. No.</b>	74420740
<b>description</b>	heating element 1600W 230V L 770mm mounting pos. upper ø 34mm tube ø 16mm thread M20x1.5 connection length 63mm connection M6 heating circuits 1 dry heating element pizza oven		
<b>For models:</b>	T75E		



<b>Part No.</b>	418728	<b>Ref. No.</b>	74400180
<b>description</b>	heating element 1650W 230V L 1070mm W 130mm thread 1/4" mounting distance 121mm connection length 100mm heating circuits 1 dry heating element		
<b>For models:</b>	KR 6, KR 66, KRX 6, KRX 66, PIZZY DUO 65.105, PIZZY MONO 65.105		

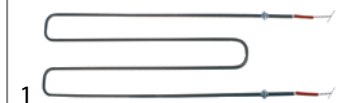

<b>Part No.</b>	418729	<b>Ref. No.</b>	74400250
<b>description</b>	heating element 1750W 230V L 680mm W 260mm thread 1/4" mounting distance 251mm connection length 101mm tube ø 8.5mm heating circuits 1 dry heating element		
<b>For models:</b>	KR 66T, KR 6T, KRX 66T, KRX 6T, PIZZY DUO 105.65, PIZZY MONO 105.65		



<b>Part No.</b>	418184	<b>Ref. No.</b>	74420860
<b>description</b>	heating element 1900W 230V L 1030mm mounting pos. lower ø 34mm tube ø 16mm thread M20x1.5 connection length 45mm connection M6 flange with thread heating circuits 1 dry heating element pizza oven		
<b>For models:</b>	T97E		



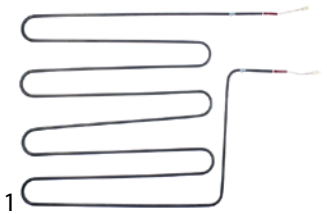

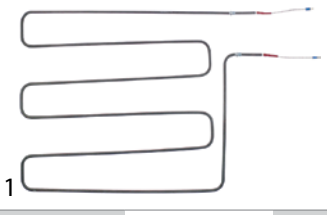
			
<b>Part No.</b>	417588	<b>Ref. No.</b>	74401180
<b>description</b>	heating element 2100W 230V L 675mm W 526mm L1 40mm L2 637mm W1 420mm W2 140mm thread 1/4" tube ø 8.5mm cable length 170mm heating circuits 1 pizza oven screw		

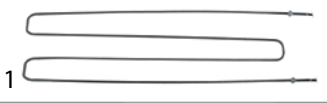
			
<b>Part No.</b>	418157	<b>Ref. No.</b>	74400150 74420690
<b>description</b>	heating element 2100W 230V L 675mm W 550mm L1 35mm L2 640mm W1 415mm W2 135mm thread 1/4" mounting distance 127mm connection length 90mm connection male faston 6.3mm tube ø 8.5mm cable length 140mm heating circuits 1 dry heating element 2 hole fixing pizza oven		
<b>For models:</b>	KR 4, KR 44, KRX 4, KRX 44, PD60.60, PIZZY DUO 60.60, PIZZY DUO 65.105, PIZZY MONO 60.60, PIZZY MONO 65.105		

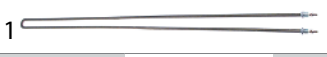
			
<b>Part No.</b>	418730	<b>Ref. No.</b>	74400280
<b>description</b>	heating element 2400W 230V L 1200mm W 290mm heating circuits 1 dry heating element pizza oven		
<b>For models:</b>	KR 9, KR 99, KRX 9, KRX 99, PIZZY DUO 105.105, PIZZY MONO 105.105		

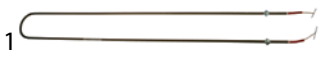
			
<b>Part No.</b>	418187	<b>Ref. No.</b>	74400790
<b>description</b>	heating element 750W 230V dry heating element 2 hole fixing		
<b>For models:</b>	AHL, L105.105, L65.105, MHL, P110L, RHL		

			
<b>Part No.</b>	418727	<b>Ref. No.</b>	74400160
<b>description</b>	heating element 920W 230V L 1040mm W 120mm thread 1/4" mounting distance 111mm connection length 100mm tube ø 9mm heating circuits 1 dry heating element		
<b>For models:</b>	KR 6, KR 66, KRX 6, KRX 66, PIZZY DUO 65.105, PIZZY MONO 65.105		

			
<b>Part No.</b>	418725	<b>Ref. No.</b>	74400210
<b>description</b>	heating element 972W 230V L 645mm W 195mm thread 1/4" mounting distance 186mm connection length 102mm tube ø 8.5mm heating circuits 1 dry heating element		
<b>For models:</b>	KR 66T, KR 6T, KRX 66T, KRX 6T, PIZZY DUO 105.65, PIZZY MONO 105.65		

			
<b>Part No.</b>	419237	<b>Ref. No.</b>	54600290
<b>description</b>	heating cable mounting pos. lower Qty 1 pcs pizza oven suitable for AHC_A/AHK		
<b>For models:</b>	AHC 18A, AHK		

			
<b>Part No.</b>	419239	<b>Ref. No.</b>	54600270
<b>description</b>	heating cable mounting pos. lower Qty 1 pcs pizza oven suitable for AHC_B/AHB		
<b>For models:</b>	AHB, AHC 18B		

			
<b>Part No.</b>	419241	<b>Ref. No.</b>	54600310
<b>description</b>	heating cable mounting pos. lower Qty 1 pcs pizza oven suitable for AHC_C		
<b>For models:</b>	AHC, AHC 18C		

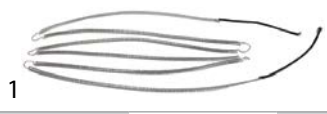
			
<b>Part No.</b>	419236	<b>Ref. No.</b>	54600300
<b>description</b>	heating cable mounting pos. upper Qty 1 pcs pizza oven suitable for AHC_A/AHK		
<b>For models:</b>	AHC 18A, AHK		

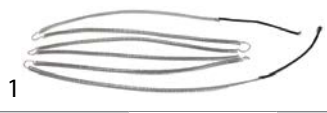
			
<b>Part No.</b>	419238	<b>Ref. No.</b>	54600280
<b>description</b>	heating cable mounting pos. upper Qty 1 pcs pizza oven suitable for AHC_B/AHB		
<b>For models:</b>	AHB, AHC 18B		

			
<b>Part No.</b>	419240	<b>Ref. No.</b>	54600320
<b>description</b>	heating cable mounting pos. upper Qty 1 pcs pizza oven suitable for AHC_C		
<b>For models:</b>	AHC, AHC 18C		

			
<b>Part No.</b>	418176	<b>Ref. No.</b>	66009700
<b>description</b>	heating cable set mounting pos. lower Qty 3 pcs pizza oven suitable for AHC_A/AHK		



			
<b>Part No.</b>	418178	<b>Ref. No.</b>	66009720
<b>description</b>	heating cable set mounting pos. lower Qty 3 pcs pizza oven suitable for AHC_B/AHB		

			
<b>Part No.</b>	418180	<b>Ref. No.</b>	66009740
<b>description</b>	heating cable set mounting pos. lower Qty 3 pcs pizza oven suitable for AHC_C		

			
<b>Part No.</b>	418175	<b>Ref. No.</b>	66009690
<b>description</b>	heating cable set mounting pos. upper Qty 3 pcs pizza oven suitable for AHC_A/AHK		

			
<b>Part No.</b>	418177	<b>Ref. No.</b>	66009710
<b>description</b>	heating cable set mounting pos. upper Qty 3 pcs pizza oven suitable for AHC_B/AHB		

			
<b>Part No.</b>	418179	<b>Ref. No.</b>	66009730
<b>description</b>	heating cable set mounting pos. upper Qty 3 pcs pizza oven suitable for AHC_C		

### heating elements for pizza presses

			
<b>Part No.</b>	418185	<b>Ref. No.</b>	74420770
<b>description</b>	heating element 1500W 230V L 375mm W 268mm connection male faston 6.3mm dry heating element tube ø 8.5mm windings 4		

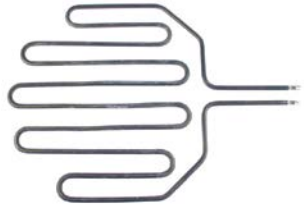
			
<b>Part No.</b>	418186	<b>Ref. No.</b>	74420780
<b>description</b>	heating element 2500W 230V L 478mm W 347mm connection male faston 6.3mm connection length 23mm L1 140mm L2 337mm W1 155mm W2 32mm dry heating element tube ø 8.9mm windings 5		
<b>For models:</b>	PRESSY 33, PRESSY 45		

### coil heating elements

			
<b>Part No.</b>	418183	<b>Ref. No.</b>	74420850
<b>description</b>	heating element 1250W 230V L 1032mm mounting pos. upper ø 34mm tube ø 16mm thread M20x1.5 connection length 45mm connection M6 flange with thread heating circuits 1 dry heating element pizza oven		
<b>For models:</b>	T97E		

			
<b>Part No.</b>	418182	<b>Ref. No.</b>	74420750
<b>description</b>	heating element 1400W 230V L 775mm mounting pos. lower ø 34mm tube ø 16mm thread M20x1.5 connection length 63mm connection M6 heating circuits 1 dry heating element pizza oven		
<b>For models:</b>	T75E		

			
<b>Part No.</b>	418181	<b>Ref. No.</b>	74420740
<b>description</b>	heating element 1600W 230V L 770mm mounting pos. upper ø 34mm tube ø 16mm thread M20x1.5 connection length 63mm connection M6 heating circuits 1 dry heating element pizza oven		
<b>For models:</b>	T75E		

			
<b>Part No.</b>	418184	<b>Ref. No.</b>	74420860
<b>description</b>	heating element 1900W 230V L 1030mm mounting pos. lower ø 34mm tube ø 16mm thread M20x1.5 connection length 45mm connection M6 flange with thread heating circuits 1 dry heating element pizza oven		
<b>For models:</b>	T97E		

			
<b>Part No.</b>	419115	<b>Ref. No.</b>	74400300
<b>description</b>	heating element 2400W 230V L 1020mm ø 33.5mm tube ø 16mm thread M20x1.5 connection length 66mm connection M6 2 hole fixing heating circuits 1 dry heating element oven		
<b>For models:</b>	T97E		



thermostats

control and safety thermostats

EGO

control thermostats

55.10/19\_series



<b>Part No.</b>	375273	<b>Ref. No.</b>	74220840
<b>description</b>	thermostat t.max. 200°C temperature range 60-200°C 1-pole 1NO 16A probe ø 6mm probe L 74mm capillary pipe 1500mm capillary pipe isolated gland nut shaft L 23mm shaft position upper rotation 270°		
<b>For models:</b>	PRESSY 33, PRESSY 45		



<b>Part No.</b>	375253	<b>Ref. No.</b>	74300110
<b>description</b>	thermostat t.max. 455°C temperature range 85-455°C 1-pole 1NO 16A probe ø 3.9mm probe L 228mm capillary pipe 870mm capillary pipe isolated 660mm gland nut shaft ø 6x4.6mm shaft L 23mm shaft position upper rotation 270°		
<b>For models:</b>	KR 4, KR 44, KR 6, KR 66, KR 66T, KR 6T, KR 9, KR 99, KRX 4, KRX 44, KRX 6, KRX 66, KRX 66T, KRX 6T, KRX 9, KRX 99, PIZZY DUO 105.105, PIZZY DUO 105.65, PIZZY DUO 60.60, PIZZY DUO 65.105, PIZZY MONO 105.105, PIZZY MONO 105.65, PIZZY MONO 60.60, PIZZY MONO 65.105		



<b>Part No.</b>	375661	<b>Ref. No.</b>	74310830
<b>description</b>	thermostat t.max. 500°C temperature range 75-500°C 1-pole 1NO 16A probe ø 3.9mm probe L 228mm capillary pipe 1470mm capillary pipe isolated 960mm gland nut shaft ø 6x4.6mm shaft L 23mm shaft position upper rotation 270°		
<b>For models:</b>	PIZZY DUO 105.105, PIZZY DUO 105.65, PIZZY DUO 60.60, PIZZY DUO 65.105, PIZZY MONO 105.105, PIZZY MONO 105.65, PIZZY MONO 60.60, PIZZY MONO 65.105		

55.34\_series



<b>Part No.</b>	375498	<b>Ref. No.</b>	74200140
<b>description</b>	thermostat t.max. 512°C temperature range 60-512°C 3-pole 3NO 16A probe ø 3.8mm probe L 225mm capillary pipe 1150mm capillary pipe isolated 1110mm gland nut shaft ø 6x4.6mm shaft L 32mm shaft position upper rotation 270°		

safety thermostats

55.10/19\_series



<b>Part No.</b>	375663	<b>Ref. No.</b>	74220860
<b>description</b>	safety thermostat capillary pipe 1500mm probe ø 4mm 1-pole probe L 228mm 16A capillary pipe isolated 900mm gland nut switch-off temp. 410°C probe SS		
<b>For models:</b>	T75E, T97E		

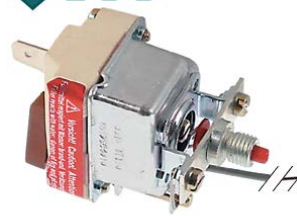

<b>Part No.</b>	375662	<b>Ref. No.</b>	74200370
<b>description</b>	safety thermostat switch-off temp. 512°C 1-pole 16A probe ø 3.9mm probe L 228mm capillary pipe 1470mm capillary pipe isolated 960mm gland nut probe SS screw connection M8x1		
<b>For models:</b>	AHB, AHC, AHK, MHK - MHC - MHB, P110 GAS, P110 GAS A, P110 GAS B, RHK - RHC - RHB		
<b>accessories for</b>	375662		
		<b>Part No.</b>	102067
		<b>Ref. No.</b>	—
	nut thread M8x1 H 3mm brass Qty 1 pcs type SEF 1		



## JUMO

## safety thermostats



<b>Part No.</b>	390169	<b>Ref. No.</b>	74200260
<b>description</b>	safety thermostat switch-off temp. 20-500°C temperature range°C 1-pole 1NC 16A probe ø 6mm probe L 275mm capillary pipe 1000mm capillary pipe isolatedmm gland nut shaft ømm probe material copper 230V		
<b>For models:</b>	AHC 18A, AHC 18B, AHC 18C, MHC 18A, MHC 18B, MHC 18C, MHC 18PA, MHC 18PB, MHC 18PC, MHC 30A, MHC 30B, MHC 30C, MHC 30PA, MHC 30PB, MHC 30PC, PC/GAS, RHC 18B, RHC 18C, RHC 18D, RHC 18PB, RHC 18PC, RHC 18PD, RHC 25B, RHC 25C, RHC 25PB, RHC 25PC, RHC 25PD, RHC-25D		

## switches and momentary switches

## rocker/momentary rocker switches

## 30x22mm



<b>Part No.</b>	301003	<b>Ref. No.</b>	74500120
<b>description</b>	rocker switch mounting measurements 30x22mm green 2NO 250V 16A illuminated 0-I connection male faston 6.3mm ambient temperature max. 125/55°C protection IP65		
<b>For models:</b>	AHB, AHC, AHC 18A, AHC 18B, AHC 18C, AHK, BAKY 5TE, BAKY 5TM, F80E, KR 6, KR 66, KR 66T, KR 6T, KR 9, KR 99, L105.105, L105.65, L60.60, L65.105, MHC 18A, MHC 18B, MHC 18C, MHC 18PA, MHC 18PB, MHC 18PC, MHC 30A, MHC 30B, MHC 30C, MHC 30PA, MHC 30PB, MHC 30PC, MHK - MHC - MHB, MHL, P110 GAS, P110 GAS A, P110 GAS B, PC/GAS, PIZZY DUO 105.105, PIZZY DUO 105.65, PIZZY DUO 65.105, PIZZY MONO 105.105, PIZZY MONO 105.65, PIZZY MONO 65.105, R08G GAS, RHC 18B, RHC 18C, RHC 18D, RHC 18PB, RHC 18PC, RHC 18PD...(Other models you can see in the webshop)		
<b>accessories for</b>	301003		
	<b>Part No.</b>	301036	<b>Ref. No.</b> —
	protective cover internal size 30x22mm for rocker switch mounting measurementsmm		



<b>Part No.</b>	301017	<b>Ref. No.</b>	74500130
<b>description</b>	rocker switch mounting measurements 30x22mm green 2CO 250V 16A illuminated connection male faston 6.3mm ambient temperature max. 125/55°C protection IP40		
<b>For models:</b>	KR 4, KR 44, PIZZY DUO 60.60, PIZZY MONO 60.60		
<b>accessories for</b>	301017		
	<b>Part No.</b>	301036	<b>Ref. No.</b> —
	protective cover internal size 30x22mm for rocker switch mounting measurementsmm		



<b>Part No.</b>	346377	<b>Ref. No.</b>	74550520
<b>description</b>	rocker switch mounting measurements 30x22mm black 2CO 230V 16A 0-I connection male faston 6.3mm ambient temperature max. 125/55°C protection IP40		
<b>For models:</b>	PIZZY DUO 60.60, PIZZY MONO 60.60		
<b>accessories for</b>	346377		
	<b>Part No.</b>	301036	<b>Ref. No.</b> —
	protective cover internal size 30x22mm for rocker switch mounting measurementsmm		



<b>Part No.</b>	301255	<b>Ref. No.</b>	74500010
<b>description</b>	rocker switch mounting measurements 30x22mm blue 2NO 250V 16A illuminated 0-I connection male faston 6.3mm ambient temperature max. 85°C protection IP40		
<b>For models:</b>	KRX 6, KRX 66, KRX 66T, KRX 6T, KRX 9, KRX 99		
<b>accessories for</b>	301255		
	<b>Part No.</b>	301036	<b>Ref. No.</b> —
	protective cover internal size 30x22mm for rocker switch mounting measurementsmm		



<b>Part No.</b>	347505	<b>Ref. No.</b>	74500040
<b>description</b>	rocker switch mounting measurements 30x22mm blue 2NO 250V 16A illuminated 0-lighting connection male faston 6.3mm ambient temperature max. 85°C protection IP40		
<b>For models:</b>	KRX 4, KRX 44, KRX 6, KRX 66, KRX 66T, KRX 6T, KRX 9, KRX 99		



<b>Part No.</b>	346378	<b>Ref. No.</b>	74500220 74500400 74500720
<b>description</b>	rocker switch mounting measurements 30x22mm green 2NO 250V 16A illuminated lighting connection male faston 6.3mm ambient temperature max. 100/55°C protection IP40		
<b>For models:</b>	AHL, BAKY 5TM, KR 4, KR 44, KR 6, KR 66, KR 66T, KR 6T, KR 9, KR 99, L105.105, L105.65, L60.60, L65.105, MHL, P110L, PIZZY DUO 105.105, PIZZY DUO 105.65, PIZZY DUO 60.60, PIZZY DUO 65.105, PIZZY MONO 105.105, PIZZY MONO 105.65, PIZZY MONO 60.60, PIZZY MONO 65.105, RHL		



microswitches

lever actuated



1			
<b>Part No.</b>	345125	<b>Ref. No.</b>	74550740
<b>description</b>	microswitch with lever 250V 16A 1CO connection male faston 6.3mm ambient temperature max. 85°C mounting distance 25mm type C99ZP3 actuating force: 25g lever length 63.5mm		
<b>For models:</b>	PRESSY 33, PRESSY 45		

roller actuated

roller 0°



1			
<b>Part No.</b>	345639	<b>Ref. No.</b>	74550730
<b>description</b>	microswitch with roller plunger 230V 16A 1CO connection solder/screw connection L1 49mm ambient temperature max. 125°C thread L 14mm thread M10 mounting distance 25mm actuating force: 300g type M515-1		
<b>For models:</b>	PRESSY 33, PRESSY 45		

rotary switches

BRETER

rotary switches



1			
<b>Part No.</b>	346381	<b>Ref. No.</b>	74500440
<b>description</b>	rotary switch		
<b>For models:</b>	PRESSY 33, PRESSY 45, T75E, T97E		



1			
<b>Part No.</b>	346379 <sup>1</sup>	<b>Ref. No.</b>	74500480
<b>description</b>	rotary switch 2 0-1 sets of contacts 3 type 3LD2203-0TK53 600V 32A shaft ø 5x5mm shaft L 20mm shaft square with knob connection screw		
<b>For models:</b>	T75E		

<sup>1</sup>incl. knob and dial plate



1			
<b>Part No.</b>	346380	<b>Ref. No.</b>	74500490
<b>description</b>	rotary switch 2 0-1 sets of contacts 3 type 3LD2504-0TK53 600V 63A shaft ø 8x9mm shaft L 20mm shaft star-shaped with switch connection screw		
<b>For models:</b>	T75E, T97E		

miscellaneous



1			
<b>Part No.</b>	346383	<b>Ref. No.</b>	74500530
<b>description</b>	rotary switch sets of contacts 4 2 0-1 type 3LD2003-0TK53 690V 16A shaft ø 6x6mm shaft L 24.5mm shaft square L1-L2-L3-N connection screw clamp		
<b>For models:</b>	PRESSY 33, PRESSY 45, T75G, T97G		

control equipment

ALLEN BRADLEY

push buttons



1			
<b>Part No.</b>	346382	<b>Ref. No.</b>	74550140
<b>description</b>	push button mounting measurements ø22mm illuminated green		



1			
<b>Part No.</b>	346396	<b>Ref. No.</b>	74550270
<b>description</b>	contact block 800E-3X10 1NO/1NC max 400V 8A		





## SIEMENS

3SB series ø22mm new

push buttons



1

<b>Part No.</b>	346618	<b>Ref. No.</b>	74550140
<b>description</b>	push button mounting measurements ø22mm non-illuminated green		
<b>For models:</b>	ITP/40, PRESSY 33, PRESSY 45, RFP/15		
<b>accessories for</b>	346618		
	<b>Part No.</b>	346632	<b>Ref. No.</b> —
contact block SIEMENS 3SB3400-0D 1NC/1NO max 400V 10A black			

## screw-on/push-on fit

light bulbs

for ovens



1

<b>Part No.</b>	359612	<b>Ref. No.</b>	74420260
<b>description</b>	light bulb t.max. 300°C socket E14 25W 230V ø 25mm L 56mm lens L 30mm for oven lamp type Philips		
<b>For models:</b>	AHB, AHC, AHC 18A, AHC 18B, AHC 18C, AHK, AHL, BAKY 5TE, BAKY 5TM, F80E, F80L, KR 4, KR 44, KR 6, KR 66, KR 66T, KR 6T, KR 9, KR 99, KRX 4, KRX 44, KRX 6, KRX 66, KRX 66T, KRX 6T, KRX 9, KRX 99, L105.105, L105.65, L60.60, L65.105, MHC 18A, MHC 18B, MHC 18C, MHC 18PA, MHC 18PB, MHC 18PC, MHC 30A, MHC 30B, MHC 30C, MHC 30PA, MHC 30PB, MHC 30PC, MHK - MHC - MHB, MHL, P110 GAS, P110 GAS A, P110 GAS B, P110L, PC/GAS...(Other models you can see in the webshop)		

## lamps

indicator lights

indicator lights (complete)

ø10mm

with plug-in socket



1

<b>Part No.</b>	359263	<b>Ref. No.</b>	74420790
<b>description</b>	indicator light ø 10mm		
<b>For models:</b>	PRESSY 33, PRESSY 45		

ø13mm

with plug-in socket



1

<b>Part No.</b>	359143	<b>Ref. No.</b>	74420520
<b>description</b>	indicator light ø 13mm yellow 230V connection male faston 6.3mm temp.-resist. 120°C Qty 1 pcs		
<b>For models:</b>	AHL, BAKY 5TM, F80L, KR 4, KR 44, KR 6, KR 66, KR 66T, KR 6T, KR 9, KR 99, KRX 4, KRX 44, KRX 6, KRX 66, KRX 66T, KRX 6T, KRX 9, KRX 99, L105.105, L105.65, L60.60, L65.105, MHL, P110L, PIZZY DUO 105.105, PIZZY DUO 105.65, PIZZY DUO 60.60, PIZZY DUO 65.105, PIZZY MONO 105.105, PIZZY MONO 105.65, PIZZY MONO 60.60, PIZZY MONO 65.105, RHL, TVHL		

halogen lamp

for socket G4 / G6.35 / G9



1

<b>Part No.</b>	359946	<b>Ref. No.</b>	74401460
<b>description</b>	halogen lamp socket G9 230V 40W temp.-resist. 300°C		

oven lamps

universal oven lamps

mounting diameter 47.8mm





1

<b>Part No.</b>	359499	<b>Ref. No.</b>	74700070
<b>description</b>	lamp socket socket E14 mounting ø 47.8mm connection male faston 6.3mm		
<b>For models:</b>	AHB, AHC, AHC 18A, AHC 18B, AHC 18C, AHK, AHL, F80L, KR 4, KR 44, KR 6, KR 66, KR 66T, KR 6T, KR 9, KR 99, KRX 4, KRX 44, KRX 6, KRX 66, KRX 66T, KRX 6T, KRX 9, KRX 99, L105.105, L105.65, L60.60, L65.105, MHC 18A, MHC 18B, MHC 18C, MHC 18PA, MHC 18PB, MHC 18PC, MHC 30A, MHC 30B, MHC 30C, MHC 30PA, MHC 30PB, MHC 30PC, MHK - MHC - MHB, MHL, P110 GAS, P110 GAS A, P110 GAS B, P110L, PC/GAS, PIZZY DUO 105.105, PIZZY DUO 105.65, PIZZY DUO 60.60...(Other models you can see in the webshop)		
<b>accessories for</b>	359499		
	<b>Part No.</b>	359725	<b>Ref. No.</b> —
oven lamp glass thread ø 44mm H 43mm ø 54mm hard glas temp.-resist. 350°C			



			
1			
<b>Part No.</b>	360541	<b>Ref. No.</b>	74700200
<b>description</b>	lamp socket socket G9 250V mounting ø 47.8mm connection male faston 6.3mm		
<b>accessories for</b>	360541		
	<b>Part No.</b>	359725	<b>Ref. No.</b> —
	oven lamp glass thread ø 44mm H 43mm ø 54mm hard glas temp.-resist. 350°C		
	<b>Part No.</b>	359946	<b>Ref. No.</b> 74401460
	halogen lamp socket G9 230V 40W temp.-resist. 300°C		

mounting diameter 65.5mm			
			
1			
<b>Part No.</b>	359724	<b>Ref. No.</b>	73700690
<b>description</b>	oven lamp glass thread ø 62mm H 46mm ø 74mm hard glas temp.-resist. 350°C		
<b>For models:</b>	AHB, AHC, AHC 18A, AHC 18B, AHC 18C, AHK, KR 4, KR 44, KR 6, KR 66, KR 66T, KR 6T, KR 9, KR 99, KRX 4, KRX 44, KRX 6, KRX 66, KRX 66T, KRX 6T, KRX 9, KRX 99, MHC 18A, MHC 18B, MHC 18C, MHC 18PA, MHC 18PB, MHC 18PC, MHC 30A, MHC 30B, MHC 30C, MHC 30PA, MHC 30PB, MHC 30PC, MHK - MHC - MHB, P110 GAS, P110 GAS A, P110 GAS B, PC/GAS, PIZZY DUO 105.105, PIZZY DUO 105.65, PIZZY DUO 60.60, PIZZY DUO 65.105, PIZZY MONO 105.105, PIZZY MONO 105.65, PIZZY MONO 60.60, PIZZY MONO 65.105, RHC 18B, RHC 18C, RHC 18D...(Other models you can see in the webshop)		

50x75.5mm			
			
1			
<b>Part No.</b>	359303	<b>Ref. No.</b>	73700790
<b>description</b>	oven lamp glass L 88mm W 54mmVW socket connection for oven lamp		

lamps			
light bulbs			
			
1			
<b>Part No.</b>	359612	<b>Ref. No.</b>	74420260
<b>description</b>	light bulb t.max. 300°C socket E14 25W 230V ø 25mm L 56mm lens L 30mm for oven lamp type Philips		
<b>For models:</b>	AHB, AHC, AHC 18A, AHC 18B, AHC 18C, AHK, AHL, BAKY 5TE, BAKY 5TM, F80E, F80L, KR 4, KR 44, KR 6, KR 66, KR 66T, KR 6T, KR 9, KR 99, KRX 4, KRX 44, KRX 6, KRX 66, KRX 66T, KRX 6T, KRX 9, KRX 99, L105.105, L105.65, L60.60, L65.105, MHC 18A, MHC 18B, MHC 18C, MHC 18PA, MHC 18PB, MHC 18PC, MHC 30A, MHC 30B, MHC 30C, MHC 30PA, MHC 30PB, MHC 30PC, MHK - MHC - MHB, MHL, P110 GAS, P110 GAS A, P110 GAS B, P110L, PC/GAS...(Other models you can see in the webshop)		

halogen lamps			
for socket G4 / G6.35 / G9			
			
1			
<b>Part No.</b>	359946	<b>Ref. No.</b>	74401460
<b>description</b>	halogen lamp socket G9 230V 40W temp.-resist. 300°C		

contactors			
SIEMENS			
power contactors			
			
1			
<b>Part No.</b>	380389	<b>Ref. No.</b>	74550230
<b>description</b>	power contactor resistive load 22A 230VAC (AC3/400V) 9A/4kW main contacts 3NO auxiliary contacts 1NO connection screw connection type 3RT10-16-1AP01		
<b>For models:</b>	AHB, AHC, AHC 18A, AHC 18B, AHC 18C, AHK, BAKY 5TE, BAKY 5TM, F40E, F80E, KR 6, KR 66, KR 66T, KR 6T, KR 9, KR 99, KRX 6, KRX 66, KRX 66T, KRX 6T, KRX 9, KRX 99, MHC 18A, MHC 18B, MHC 18C, MHC 18PA, MHC 18PB, MHC 18PC, MHC 30A, MHC 30B, MHC 30C, MHC 30PA, MHC 30PB, MHC 30PC, MHK - MHC - MHB, PIZZY DUO 105.105, PIZZY DUO 105.65, PIZZY MONO 105.105, PIZZY MONO 105.65, PIZZY MONO 60.60, PIZZY MONO 65.105, RHC 18B, RHC 18C, RHC 18D, RHC 18PB, RHC 18PC, RHC 18PD, RHC 25B, RHC 25C, RHC 25PB...(Other models you can see in the webshop)		

1

<b>Part No.</b>	380390	<b>Ref. No.</b>	74550500
<b>description</b>	power contactor resistive load 40A 230VAC (AC3/400V) 12A/5.5kW main contacts 3NO auxiliary contacts connection screw connection type 3RT10-24-1AL20 50/60Hz		
<b>For models:</b>	AHB, AHC, AHC 18A, AHC 18B, AHC 18C, AHK, KR 9, KR 99, KRX 9, KRX 99, MHC 18A, MHC 18B, MHC 18C, MHC 18PA, MHC 18PB, MHC 18PC, MHC 30A, MHC 30B, MHC 30C, MHC 30PA, MHC 30PB, MHC 30PC, MHK - MHC - MHB, PIZZY DUO 105.105, PIZZY MONO 105.105, RHC 18B, RHC 18C, RHC 18D, RHC 18PB, RHC 18PC, RHC 18PD, RHC 25B, RHC 25C, RHC 25PB, RHC 25PC, RHC 25PD, RHC-25D, RHK - RHC - RHB, T75E, TIVOLI EL HI-TECH, TREVI ELETTRICO		

## transformers

### open transformers

#### with clamp terminal



1

<b>Part No.</b>	401289	<b>Ref. No.</b>	74110290
<b>description</b>	transformer primary 230/400V secondary 12V 100VA		
<b>For models:</b>	F40E, F80E, R14G GAS, T75E, T75G, T97E, T97G		

### encapsulated transformers

#### multiple connections



1

<b>Part No.</b>	401285	<b>Ref. No.</b>	74110200
<b>description</b>	transformer primary 230VAC secondary 12VAC 10VA		
<b>For models:</b>	AHB, AHC, AHC 18A, AHC 18B, AHC 18C, AHK, MHC 18A, MHC 18B, MHC 18C, MHC 18PA, MHC 18PB, MHC 18PC, MHC 30A, MHC 30B, MHC 30C, MHC 30PA, MHC 30PB, MHC 30PC, MHK - MHC - MHB, P110 GAS, P110 GAS A, P110 GAS B, R08G GAS, R14G GAS, RHC 18B, RHC 18C, RHC 18D, RHC 18PB, RHC 18PC, RHC 18PD, RHC 25B, RHC 25C, RHC 25PB, RHC 25PC, RHC 25PD, RHC-25D, RHK - RHC - RHB		

## probes

### producer-specific probes

#### probes

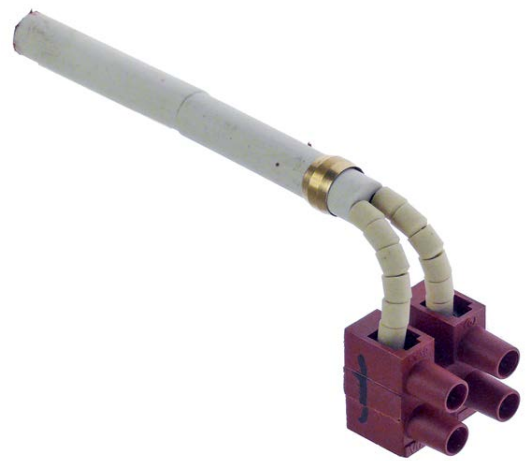

1

<b>Part No.</b>	379975	<b>Ref. No.</b>	66081910
<b>description</b>	temperature probe cable ceramic probe -50 up to +750°C cable -100 up to +1300°C connection grip connection thread probe ø10x100mm cable lengthm		
<b>For models:</b>	BAKY 5TE, F40E, F80E, R08G GAS, R14G GAS, T75E, T75G, T97E, T97G, TEVERE HI-TECH, TIVOLI EL HI-TECH, TIVOLI GAS HI-TECH, TREVI ELETTRICO, TREVI GAS		



1

<b>Part No.</b>	379972	<b>Ref. No.</b>	66081040
<b>description</b>	temperature probe cable ceramic probe -50 up to +750°C cable -100 up to +1300°C connection grip connection thread probe ø10x255mm cable lengthm		
<b>For models:</b>	P110 GAS, P110 GAS A, P110 GAS B, PC/GAS		



electronics

PCBs



1

<b>Part No.</b>	379973	<b>Ref. No.</b>	66080820
<b>description</b>	temperature probe thermocouple cable ceramic probe -50 up to +750°C cable -100 up to +1300°C connection grip connection thread probe ø10x100mm cable lengthm		
<b>For models:</b>	MHC 18A, MHC 18B, MHC 18C, MHC 18PA, MHC 18PB, MHC 18PC, MHC 30A, MHC 30B, MHC 30C, MHC 30PA, MHC 30PB, MHC 30PC, MHK - MHC - MHB, RHC 18B, RHC 18C, RHC 18D, RHC 18PB, RHC 18PC, RHC 18PD, RHC 25B, RHC 25C, RHC 25PB, RHC 25PC, RHC 25PD, RHC-25D, RHK - RHC - RHB		



1

<b>Part No.</b>	379974	<b>Ref. No.</b>	66080980
<b>description</b>	temperature probe thermocouple cable ceramic probe -50 up to +750°C cable -100 up to +1300°C connection grip connection thread probe ø10x150mm cable lengthm		
<b>For models:</b>	AHC 18A, AHC 18B, AHC 18C		



1

<b>Part No.</b>	378330	<b>Ref. No.</b>	66000830
<b>description</b>	temperature probe thermocouple cable ceramic probe -50 up to +750°C cable -100 up to +1300°C connection grip connection thread probe ø10x190mm cable lengthm		
<b>For models:</b>	AHB, AHC, AHK		



1

<b>Part No.</b>	401271	<b>Ref. No.</b>	768000B0
<b>description</b>	keypad PCB		
<b>For models:</b>	AHB, AHC, AHC 18A, AHC 18B, AHC 18C, AHK, MHC 18A, MHC 18B, MHC 18C, MHC 30A, MHC 30B, MHC 30C, MHK - MHC - MHB		



1

<b>Part No.</b>	401272	<b>Ref. No.</b>	768001C0
<b>description</b>	keypad PCB		
<b>For models:</b>	MHC 18PA, MHC 18PB, MHC 18PC, MHC 30PA, MHC 30PB, MHC 30PC, MHK - MHC - MHB, RHC 18PB, RHC 18PC, RHC 18PD, RHC 25PB, RHC 25PC, RHC 25PD, RHK - RHC - RHB		



1

<b>Part No.</b>	401287	<b>Ref. No.</b>	74311240
<b>description</b>	keypad PCB		
<b>For models:</b>	T75E		



1

<b>Part No.</b>	401291	<b>Ref. No.</b>	74311400
<b>description</b>	keypad PCB		
<b>For models:</b>	T97E		



1

<b>Part No.</b>	401854	<b>Ref. No.</b>	768001R0
<b>description</b>	keypad PCB L 144mm W 144mm		
<b>For models:</b>	MHK - MHC - MHB		



1

<b>Part No.</b>	401853	<b>Ref. No.</b>	768000C0 768000G0 768000R0
<b>description</b>	keypad PCB		
<b>For models:</b>	AHB, AHC, AHC 18A, AHC 18B, AHC 18C, AHK, MHC 18A, MHC 18B, MHC 18C, MHC 30A, MHC 30B, MHC 30C, MHK - MHC - MHB, RHC 18B, RHC 18C, RHC 18D, RHC 25B, RHC 25C, RHC-25D, RHK - RHC - RHB		



1

<b>Part No.</b>	401283	<b>Ref. No.</b>	768002R0
<b>description</b>	keypad PCB pizza oven gas		



1

<b>Part No.</b>	401435	<b>Ref. No.</b>	768000R0
<b>description</b>	keypad PCB electric pizza oven L 140mm W 140mm buttons 4		



1

<b>Part No.</b>	403060	<b>Ref. No.</b>	768000R0
<b>description</b>	keypad PCB electric pizza oven MHC L 140mm W 140mm buttons 6		
<b>For models:</b>	AHB, AHC, AHC 18A, AHC 18B, AHC 18C, AHK, MHC 18A, MHC 18B, MHC 18C, MHC 30A, MHC 30B, MHC 30C, MHK - MHC - MHB		



1

<b>Part No.</b>	403059	<b>Ref. No.</b>	768002R0
<b>description</b>	keypad PCB pizza oven gas P110 L 140mm W 140mm		
<b>For models:</b>	P110 GAS, P110 GAS A, P110 GAS B, PC/GAS		

**spare parts for** 403059

<b>Part No.</b>	403141	<b>Ref. No.</b>	767002R0
<b>description</b>	keypad foil L 140mm W 140mm		

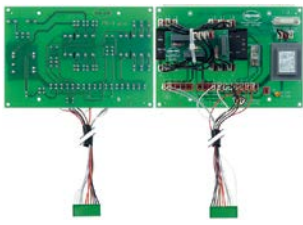

Image not available



1

<b>Part No.</b>	401288	<b>Ref. No.</b>	74311220
<b>description</b>	main PCB		
<b>For models:</b>	T75E, T97E		

1

<b>Part No.</b>	400731	<b>Ref. No.</b>	74670820
<b>description</b>	main PCB pizza press Pressy 33/45		
<b>For models:</b>	PRESSY 33, PRESSY 45		



1

<b>Part No.</b>	401290	<b>Ref. No.</b>	74220850
<b>description</b>	PCB time control		
<b>For models:</b>	PRESSY 33, PRESSY 45		

## keypads

### front foils



1

<b>Part No.</b>	401269	<b>Ref. No.</b>	73523970
<b>description</b>	front foil		
<b>For models:</b>	PIZZY MONO 60.60		



1

<b>Part No.</b>	401270	<b>Ref. No.</b>	73523980
<b>description</b>	front foil		
<b>For models:</b>	PIZZY DUO 60.60		



1

<b>Part No.</b>	402352	<b>Ref. No.</b>	73500510
<b>description</b>	front foil pizza oven PIZZY DUO model DUO L 550mm W 111mm		
<b>For models:</b>	PIZZY DUO 105.105, PIZZY DUO 105.65, PIZZY DUO 60.60, PIZZY DUO 65.105		



1

<b>Part No.</b>	401284	<b>Ref. No.</b>	767002R0
<b>description</b>	keypad foil		



1

<b>Part No.</b>	401275	<b>Ref. No.</b>	767000C0
<b>description</b>	keypad foil beige		
<b>For models:</b>	AHB, AHC, AHC 18A, AHC 18B, AHC 18C, AHK, MHC 18A, MHC 18B, MHC 18C, MHC 30A, MHC 30B, MHC 30C, MHK - MHC - MHB, RHC 18B, RHC 18C, RHC 18D, RHC 25B, RHC 25C, RHC-25D, RHK - RHC - RHB		



1

<b>Part No.</b>	401280	<b>Ref. No.</b>	767001C0
<b>description</b>	keypad foil beige		
<b>For models:</b>	MHC 18PA, MHC 18PB, MHC 18PC, MHC 30PA, MHC 30PB, MHC 30PC, MHK - MHC - MHB, RHC 18PB, RHC 18PC, RHC 18PD, RHC 25PB, RHC 25PC, RHC 25PD, RHK - RHC - RHB		



1

<b>Part No.</b>	401274	<b>Ref. No.</b>	767000B0
<b>description</b>	keypad foil blue		
<b>For models:</b>	AHB, AHC, AHC 18A, AHC 18B, AHC 18C, AHK, MHC 18A, MHC 18B, MHC 18C, MHC 30A, MHC 30B, MHC 30C, MHK - MHC - MHB		



1

<b>Part No.</b>	401279	<b>Ref. No.</b>	767001B0
<b>description</b>	keypad foil blue		
<b>For models:</b>	MHC 18PA, MHC 18PB, MHC 18PC, MHC 30PA, MHC 30PB, MHC 30PC, MHK - MHC - MHB		



1

<b>Part No.</b>	401277	<b>Ref. No.</b>	767000R0 767003R0
<b>description</b>	keypad foil brown		
<b>For models:</b>	AHB, AHC, AHC 18A, AHC 18B, AHC 18C, AHK, MHC 18A, MHC 18B, MHC 18C, MHC 30A, MHC 30B, MHC 30C, MHK - MHC - MHB		



1

<b>Part No.</b>	401282	<b>Ref. No.</b>	767001R0
<b>description</b>	keypad foil brown		
<b>For models:</b>	MHC 18PA, MHC 18PB, MHC 18PC, MHC 30PA, MHC 30PB, MHC 30PC, MHK - MHC - MHB		

1

<b>Part No.</b>	403141	<b>Ref. No.</b>	767002R0
<b>description</b>	keypad foil L 140mm W 140mm		
<b>For models:</b>	P110 GAS, P110 GAS A, P110 GAS B, PC/GAS		

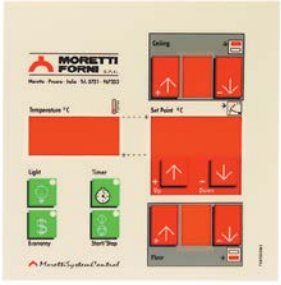
1

<b>Part No.</b>	401273	<b>Ref. No.</b>	767000W0
<b>description</b>	keypad foil white		
<b>For models:</b>	AHB, AHC, AHC 18A, AHC 18B, AHC 18C, AHK, MHC 18A, MHC 18B, MHC 18C, MHC 30A, MHC 30B, MHC 30C, MHK - MHC - MHB		



1

<b>Part No.</b>	401278	<b>Ref. No.</b>	767001W0
<b>description</b>	keypad foil white		
<b>For models:</b>	MHC 18PA, MHC 18PB, MHC 18PC, MHC 30PA, MHC 30PB, MHC 30PC, MHK - MHC - MHB		



1

<b>Part No.</b>	401276	<b>Ref. No.</b>	767000G0
<b>description</b>	keypad foil yellow		
<b>For models:</b>	AHB, AHC, AHC 18A, AHC 18B, AHC 18C, AHK, MHC 18A, MHC 18B, MHC 18C, MHC 30A, MHC 30B, MHC 30C, MHK - MHC - MHB		



1

<b>Part No.</b>	401281	<b>Ref. No.</b>	767001G0
<b>description</b>	keypad foil yellow		
<b>For models:</b>	MHC 18PA, MHC 18PB, MHC 18PC, MHC 30PA, MHC 30PB, MHC 30PC, MHK - MHC - MHB		

membrane keypads



1

<b>Part No.</b>	401286	<b>Ref. No.</b>	74311230
<b>description</b>	membrane keypad		
<b>For models:</b>	T75E, T75G, T97E, T97G		

fans  
hot air motors

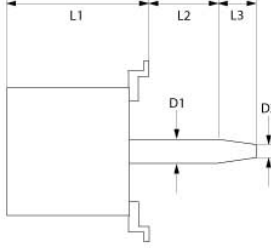
1

<b>Part No.</b>	601240	<b>Ref. No.</b>	74015370
<b>description</b>	fan motor 230/400V 3 phase 50Hz 0.55kW 1400rpm speeds 1 L1 150mm L2 45mm L3 47mm D1 ø 24mm D2 ø 20mm M8L IT 3/1.73A Cos(fi) 0.75 at 50Hz 1400rpm type 1022		
<b>For models:</b>	T75E, T97E		



1

<b>Part No.</b>	601242	<b>Ref. No.</b>	72807520
<b>description</b>	fan wheel D1 ø 300mm H1 100mm blades 12 D2 ø 19.5mm D3 ø 23mm H2 46mm		
<b>For models:</b>	T97E		





1

<b>Part No.</b>	601241	<b>Ref. No.</b>	72806860
<b>description</b>	fan wheel D1 ø 300mm H1 100mm blades 20 D2 ø 19.5mm D3 ø 23mm H2 46mm		
<b>For models:</b>	T75E, T75G		



1

<b>Part No.</b>	601239	<b>Ref. No.</b>	72806990
<b>description</b>	fan wheel for motor cooling		
<b>For models:</b>	T75E, T75G, T97E, T97G		

## motors

### gear motors

#### for ovens

#### for conveyor belt



1

<b>Part No.</b>	500820	<b>Ref. No.</b>	74015590
<b>description</b>	gear motor TRANSTECNO type WM26/P522CD 24V 4.3rpm shaft ø 12mm L 210mm W 95mm H 160mm for conveyor belt		
<b>For models:</b>	T97E, T97G		



1

<b>Part No.</b>	500819	<b>Ref. No.</b>	74015580
<b>description</b>	gear motor TRANSTECNO type WMP26/522 CD-T 75E 70W 24V shaft ø 12mm L 215mm W 150mm H 100mm for conveyor belt		
<b>For models:</b>	T75E, T75G		

#### for flues



1

<b>Part No.</b>	601467	<b>Ref. No.</b>	74310970	
<b>description</b>	gear motor CROUZET type 823440 3W 230V 50Hz 6rpm shaft ø 4mm L 65mm W 51mm H 34mm			
<b>For models:</b>	BAKY 5TE, BAKY 5TM			
<b>accessories for</b>	601467			
	<b>Part No.</b>	691422	<b>Ref. No.</b>	—
	gear wheel for gear motor suitable for TURBOCHEF C3			

## motors

### universal

1

<b>Part No.</b>	500822	<b>Ref. No.</b>	74015350
<b>description</b>	motor		
<b>For models:</b>	PRESSY 33, PRESSY 45		



1

<b>Part No.</b>	500821	<b>Ref. No.</b>	74015340
<b>description</b>	motor 370W 230V 50Hz 1 phase shaft ø 14mm flange ø 160mm 1400rpm ø 140mm H 180mm L 220mm ICME 0.37kW		
<b>For models:</b>	PRESSY 33		

1

<b>Part No.</b>	500822	<b>Ref. No.</b>	74015350
<b>description</b>	motor		
<b>For models:</b>	PRESSY 33, PRESSY 45		



## electric accessories

### terminals

#### connection terminals with screw/faston connections



<b>Part No.</b>	550411	<b>Ref. No.</b>	74610340
<b>description</b>	power terminal block 6-pole max. 40A max 450V connection $\phi 6\text{mm}^2$ / F6.3 temp.-resist. 150°C cross section 6mm <sup>2</sup>		
<b>For models:</b>	AHB, AHC, AHK, BAKY 5TE, BAKY 5TM, KR 6, KR 66, KR 66T, KR 6T, KR 9, KR 99, KRX 6, KRX 66, KRX 66T, KRX 6T, KRX 9, KRX 99, MHK - MHC - MHB, PIZZY DUO 105.105, PIZZY DUO 105.65, PIZZY DUO 65.105, PIZZY MONO 105.105, PIZZY MONO 105.65, PIZZY MONO 65.105, R08G GAS, R14G GAS, RHK - RHC - RHB, TEVERE HI-TECH, TREVI ELETTRICO		

#### terminal boards



<b>Part No.</b>	550985	<b>Ref. No.</b>	74670620
<b>description</b>	terminal board 3-pole thread M6 L 83mm W 53mm		
<b>For models:</b>	KR 4, KR 44, KRX 4, KRX 44, PIZZY DUO 60.60, PIZZY MONO 60.60		

#### rail-mounted terminals

##### WIELAND

##### rail-mounted terminals type 9700A



<b>Part No.</b>	550376	<b>Ref. No.</b>	74610020
<b>description</b>	rail-mounted terminal WIELAND type 9700A/16 S35 2.5-35mm <sup>2</sup> top-hat rail 35mm grey W 16mm L 59mm		
<b>For models:</b>	AHB, AHC, AHK, KR 66, KR 66T, KR 99, KRX 66, KRX 66T, KRX 99, MHK - MHC - MHB, PIZZY DUO 105.105, PIZZY DUO 105.65, PIZZY DUO 65.105, RHK - RHC - RHB		



<b>Part No.</b>	550381	<b>Ref. No.</b>	74610070
<b>description</b>	rail-mounted terminal WIELAND type 9700A/8 S35 1.0-10mm <sup>2</sup> top-hat rail 35mm grey W 8mm L 46.6mm		
<b>For models:</b>	KRX 99, PIZZY DUO 105.105, PIZZY DUO 105.65		



<b>Part No.</b>	550416	<b>Ref. No.</b>	74610190
<b>description</b>	rail-mounted terminal WIELAND type 9700A/8 SL2 S35 1.0-10mm <sup>2</sup> top-hat rail 35mm yellow/green W 8mm L 53mm		
<b>For models:</b>	AHB, AHC, AHK, KR 66, KR 66T, KR 99, KRX 66, KRX 66T, KRX 99, MHK - MHC - MHB, PIZZY DUO 105.105, PIZZY DUO 105.65, PIZZY DUO 65.105, RHK - RHC - RHB		

#### accessories universal

##### terminal block end brackets



<b>Part No.</b>	550984	<b>Ref. No.</b>	74610080
<b>description</b>	terminal block end bracket for DIN-rail		
<b>For models:</b>	KR 66, KR 66T, KR 99, KRX 66, KRX 66T, KRX 99, PIZZY DUO 105.105, PIZZY DUO 105.65, PIZZY DUO 65.105		

## gas valves and ignition boxes

### gas control valves





#### HONEYWELL



<b>Part No.</b>	106011	<b>Ref. No.</b>	74311120
<b>description</b>	gas valve HONEYWELL		
<b>For models:</b>	P110 GAS, P110 GAS A, P110 GAS B, R08G GAS		



<b>accessories for</b>	106011			
	<b>Part No.</b>	101305	<b>Ref. No.</b>	—
	gas connection straight 1/2" flange 45x45mm ELETTRISIT/V4400/4600/4605 suitable for SIT/HONEYWELL hole distance 36x36mm			
	<b>Part No.</b>	101306	<b>Ref. No.</b>	—
	gas connection angled flange 45x45mm hole distance 36x36mm 1/2" ELETTRISIT/V4400/4600/4605 screw with O-ring suitable for SIT/HONEYWELL			
	<b>Part No.</b>	101307	<b>Ref. No.</b>	—
	gas connection straight flange 45x45mm hole distance 36x36mm 3/4" ELETTRISIT/V4400/4600/4605 screw with O-ring suitable for SIT/HONEYWELL			
	<b>Part No.</b>	101308	<b>Ref. No.</b>	—
	gas connection angled flange 45x45mm hole distance 36x36mm 3/4" ELETTRISIT/V4400/4600/4605 screw with O-ring suitable for SIT/HONEYWELL			



			
1			
<b>Part No.</b>	106010	<b>Ref. No.</b>	74310690
<b>description</b>	gas valve type VR4605A 230V 50Hz gas inlet flange 45x45mm gas outlet 1/2" thermocouple connection pilot connection pressure range 3-37mbar operator type 220/240V (V404A 1071 4) pressure controller type V5306E 1143 1 suitable for HONEYWELL		
<b>For models:</b>	PC/GAS, R14G GAS, TEVERE HI-TECH, TIVOLI GAS HI-TECH, TREVI GAS		
<b>accessories for</b>	106010		
	<b>Part No.</b>	101305	<b>Ref. No.</b> —
	gas connection straight 1/2" flange 45x45mm ELETTROSIT/V4400/4600/4605 suitable for SIT/HONEYWELL hole distance 36x36mm		
	<b>Part No.</b>	101306	<b>Ref. No.</b> —
	gas connection angled flange 45x45mm hole distance 36x36mm 1/2" ELETTROSIT/V4400/4600/4605 screw with O-ring suitable for SIT/HONEYWELL		
	<b>Part No.</b>	101307	<b>Ref. No.</b> —
	gas connection straight flange 45x45mm hole distance 36x36mm 3/4" ELETTROSIT/V4400/4600/4605 screw with O-ring suitable for SIT/HONEYWELL		
	<b>Part No.</b>	101308	<b>Ref. No.</b> —
	gas connection angled flange 45x45mm hole distance 36x36mm 3/4" ELETTROSIT/V4400/4600/4605 screw with O-ring suitable for SIT/HONEYWELL		

ignition boxes

HONEYWELL

			
1			
<b>Part No.</b>	102358	<b>Ref. No.</b>	74670690
<b>description</b>	ignition box HONEYWELL type S4570AS 1012 electrodes 1 waiting time 3s safety time 5s 220-240V 10VA 50Hz		
<b>For models:</b>	PC/GAS, R14G GAS, TEVERE HI-TECH, TIVOLI GAS HI-TECH, TREVI GAS		
<b>accessories for</b>	102358		
	<b>Part No.</b>	550800	<b>Ref. No.</b> —
	PCB terminal block 2-pole raster size 5mm		
	<b>Part No.</b>	550801	<b>Ref. No.</b> —
	PCB terminal block 3-pole raster size 5mm		

ignition parts

electrodes

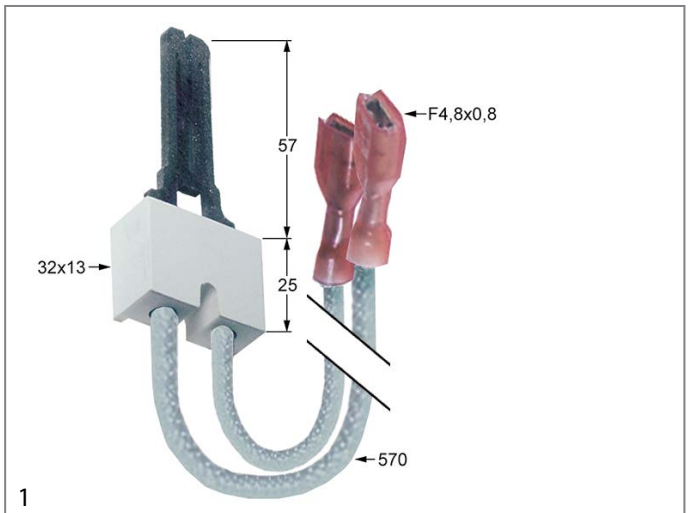

1			
<b>Part No.</b>	102354	<b>Ref. No.</b>	74110050 Q3271N1005B
<b>description</b>	ignition electrode D1 ø 32x13mm L1 57mm BL1 25mm connection F 4.8x0.8mm cable length 570mm		
<b>For models:</b>	PC/GAS, R14G GAS, TEVERE HI-TECH, TIVOLI GAS HI-TECH, TREVI GAS		

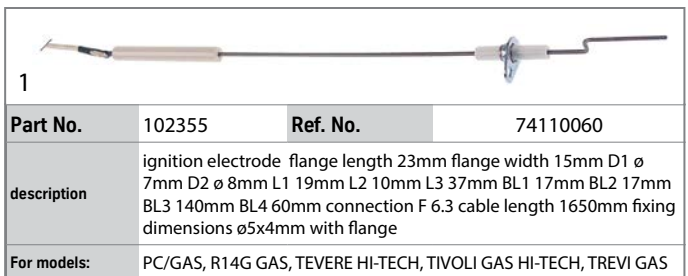

1			
<b>Part No.</b>	102355	<b>Ref. No.</b>	74110060
<b>description</b>	ignition electrode flange length 23mm flange width 15mm D1 ø 7mm D2 ø 8mm L1 19mm L2 10mm L3 37mm BL1 17mm BL2 17mm BL3 140mm BL4 60mm connection F 6.3 cable length 1650mm fixing dimensions ø5x4mm with flange		
<b>For models:</b>	PC/GAS, R14G GAS, TEVERE HI-TECH, TIVOLI GAS HI-TECH, TREVI GAS		

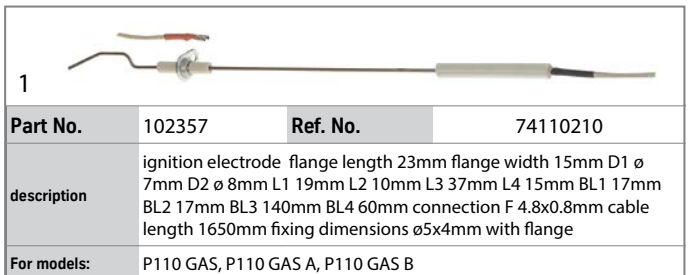

1			
<b>Part No.</b>	102357	<b>Ref. No.</b>	74110210
<b>description</b>	ignition electrode flange length 23mm flange width 15mm D1 ø 7mm D2 ø 8mm L1 19mm L2 10mm L3 37mm L4 15mm BL1 17mm BL2 17mm BL3 140mm BL4 60mm connection F 4.8x0.8mm cable length 1650mm fixing dimensions ø5x4mm with flange		
<b>For models:</b>	P110 GAS, P110 GAS A, P110 GAS B		

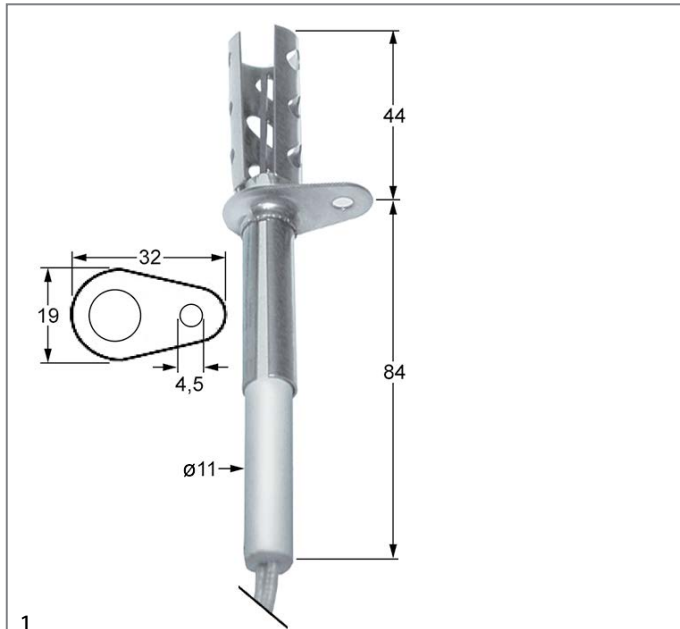

<b>Part No.</b>	102356	<b>Ref. No.</b>	74100260
<b>description</b>	ignition electrode flange length 32mm flange width 19mm D1 ø 11mm L1 44mm L2 32mm BL1 8mm BL2 84mm cable length 870mm fixing dimensions ø4.5mm with flange		
<b>For models:</b>	P110 GAS, P110 GAS A, P110 GAS B, R08G GAS		

## gas nozzles

### main nozzles

#### gas nozzles M13x1



<b>Part No.</b>	102471	<b>Ref. No.</b>	72093460
<b>description</b>	gas injector thread M13x1 bore ø 2.3mm WS 13		
<b>For models:</b>	R14G GAS		

## equipment-specific units

### for dough mixers

#### dough hooks

#### with mounting groove

<b>Part No.</b>	697113	<b>Ref. No.</b>	71336030C 72701100
<b>description</b>	dough hook SP20		
<b>For models:</b>	SP20		

### for dough roller

#### rollers



<b>Part No.</b>	693909	<b>Ref. No.</b>	72601110
<b>description</b>	roller L 422mm ø 48mm mounting pos. bottom in the front		
<b>For models:</b>	FLATTY 40, FLATTY 40 P		

#### holders



<b>Part No.</b>	692301	<b>Ref. No.</b>	72003620 72004100 72500990 73601110
<b>description</b>	lever complete hole ø 9.8mm H 21mm hole distance 32mm		
<b>spare parts for</b>	692301		
<b>Part No.</b>	697346	<b>Ref. No.</b>	—
<b>description</b>	ball handle thread M4 ø 20mm black		
<b>accessories for</b>	692301		
<b>Part No.</b>	691637	<b>Ref. No.</b>	72500920
<b>description</b>	roll pin ø 3mm L 20mm		

### for pizza press

#### gearboxes

<b>Part No.</b>	693424	<b>Ref. No.</b>	74015330
<b>description</b>	gearbox		
<b>For models:</b>	PRESSY 33, PRESSY 45		

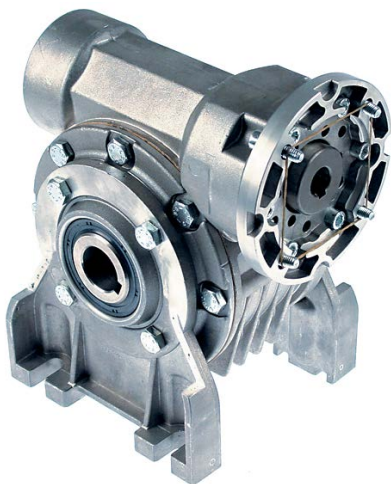

1

<b>Part No.</b>	601182	<b>Ref. No.</b>	74015320
<b>description</b>	gearbox motor shaft $\varnothing$ 14mm flange $\varnothing$ 105mm transmission 1/80 drive shaft $\varnothing$ 25mm fixing dimensions 86-110mm type MV 63A		



1

<b>Part No.</b>	693423	<b>Ref. No.</b>	74015320
<b>description</b>	gearbox motor shaft $\varnothing$ 14mm flange $\varnothing$ 105mm transmission 1/80 drive shaft $\varnothing$ 25mm fixing dimensions 86-110mm type MV 63A		
<b>For models:</b>	PRESSY 33		

## for conveyor oven

## miscellaneous



1

<b>Part No.</b>	693419	<b>Ref. No.</b>	72091850
<b>description</b>	coupling mounting pos. engine side		
<b>For models:</b>	T75E, T75G, T97E, T97G		

## for pizza ovens

## spare parts and accessories



1

<b>Part No.</b>	693420	<b>Ref. No.</b>	72601390
<b>description</b>	coupling centre for pizza oven		
<b>For models:</b>	T75E, T75G, T97E, T97G		



1

<b>Part No.</b>	693421	<b>Ref. No.</b>	72094440
<b>description</b>	coupling lateral for pizza oven		
<b>For models:</b>	T75E, T75G, T97E, T97G		

## glass panels



1

<b>Part No.</b>	693412	<b>Ref. No.</b>	73700680 73700850
<b>description</b>	glass panel L 385mm W 135mm thickness 5mm rectangular with gasket		
<b>For models:</b>	KR 4, KR 44, KR 6, KR 66, KRX 4, KRX 44, KRX 6, KRX 66, MHC 18A, MHC 18B, MHC 18PA, MHC 18PB, MHK - MHC - MHB, PC/GAS, PIZZY DUO 60.60, PIZZY DUO 65.105, PIZZY MONO 60.60, PIZZY MONO 65.105, RHC 18B, RHC 18C, RHC 18D, RHC 18PB, RHC 18PC, RHC 18PD, RHK - RHC - RHB, T75E, T75G, T97E, T97G		



1

<b>Part No.</b>	693413	<b>Ref. No.</b>	73700870
<b>description</b>	glass panel L 385mm W 163mm thickness 5mm rectangular		
<b>For models:</b>	AHC 18A, AHC 18B, AHC 18C, AHK, MHC 30A, MHC 30B, MHC 30PA, MHC 30PB, MHK - MHC - MHB, RHC 25B, RHC 25C, RHC 25PB, RHC 25PC, RHC 25PD, RHC-25D, RHK - RHC - RHB		



1

<b>Part No.</b>	693414	<b>Ref. No.</b>	73700840
<b>description</b>	glass panel L 697mm W 135mm thickness 5mm rectangular		
<b>For models:</b>	KR 66T, KR 6T, KR 9, KR 99, KRX 66T, KRX 6T, KRX 9, KRX 99, MHC 18C, MHC 18PC, MHK - MHC - MHB, P110 GAS, P110 GAS A, P110 GAS B, PC/GAS, PIZZY DUO 105.105, PIZZY DUO 105.65, PIZZY MONO 105.105, PIZZY MONO 105.65		



1

<b>Part No.</b>	693415	<b>Ref. No.</b>	73700860
<b>description</b>	glass panel L 697mm W 163mm thickness 5mm rectangular		
<b>For models:</b>	AHB, AHC, AHC 18A, AHC 18B, AHC 18C, MHC 30C, MHC 30PC, MHK - MHC - MHB		

**firebricks**



1

<b>Part No.</b>	850108	<b>Ref. No.</b>	49100030 76000090
<b>description</b>	firebrick L 1056mm W 526mm H 14mm delivery freight forwarding company only		
<b>For models:</b>	KR 9, KR 99, KRX 9, KRX 99, PIZZY DUO 105.105, PIZZY MONO 105.105		



1

<b>Part No.</b>	850070	<b>Ref. No.</b>	76001230 76002780
<b>description</b>	firebrick L 1100mm W 369mm H 20mm mounting pos. upper delivery freight forwarding company only		
<b>For models:</b>	P110 GAS, P110 GAS A, P110 GAS B		



1

<b>Part No.</b>	850073	<b>Ref. No.</b>	76000130 76002210
<b>description</b>	firebrick L 1100mm W 528mm H 13mm delivery freight forwarding company only		
<b>For models:</b>	PIZZY DUO 105.105, PIZZY MONO 105.105		



1

<b>Part No.</b>	850076	<b>Ref. No.</b>	76000240 76002240
<b>description</b>	firebrick L 1300mm W 415mm H 15mm delivery freight forwarding company only		
<b>For models:</b>	RHC 18B, RHC 18C, RHC 18D, RHC 18PB, RHC 18PC, RHC 18PD, RHC 25B, RHC 25C, RHC 25PB, RHC 25PC, RHC 25PD, RHC-25D, RHK - RHC - RHB		



1

<b>Part No.</b>	850067	<b>Ref. No.</b>	76001650 76001660
<b>description</b>	firebrick L 600mm W 425mm H 15mm delivery freight forwarding company only		
<b>For models:</b>	PC/GAS		



1

<b>Part No.</b>	850066	<b>Ref. No.</b>	76002690
<b>description</b>	firebrick L 600mm W 425mm H 20mm delivery freight forwarding company only		
<b>For models:</b>	PC/GAS		



1 

<b>Part No.</b>	850077	<b>Ref. No.</b>	76000190 76001730
<b>description</b>	firebrick L 605mm W 415mm H 15mm delivery freight forwarding company only		
<b>For models:</b>	MHC 18A, MHC 18B, MHC 18PA, MHC 18PB, MHC 30A, MHC 30B, MHC 30PA, MHC 30PB, MHK - MHC - MHB		

1 

<b>Part No.</b>	850071	<b>Ref. No.</b>	76000500 76002160 76003260
<b>description</b>	firebrick L 615mm W 330mm H 15mm delivery freight forwarding company only		
<b>For models:</b>	PIZZY DUO 60.60, PIZZY MONO 60.60		

1 

<b>Part No.</b>	850074	<b>Ref. No.</b>	76000180 76001740
<b>description</b>	firebrick L 650mm W 415mm H 15mm delivery freight forwarding company only		
<b>For models:</b>	RHC 18B, RHC 18C, RHC 18D, RHC 18PB, RHC 18PC, RHC 18PD, RHC 25B, RHC 25C, RHC 25PB, RHC 25PC, RHC 25PD, RHC-25D, RHK - RHC - RHB		

1 

<b>Part No.</b>	850106	<b>Ref. No.</b>	49100050 76000120
<b>description</b>	firebrick L 660mm W 307mm H 14mm delivery freight forwarding company only		
<b>For models:</b>	KR 4, KR 44, KRX 4, KRX 44, PIZZY DUO 60.60, PIZZY MONO 60.60		

1 

<b>Part No.</b>	850107	<b>Ref. No.</b>	49100040 76000110
<b>description</b>	firebrick L 660mm W 526mm H 14mm delivery freight forwarding company only		
<b>For models:</b>	KR 6, KR 66, KR 66T, KR 6T, KRX 6, KRX 66, KRX 66T, KRX 6T, PIZZY DUO 105.65, PIZZY DUO 65.105, PIZZY MONO 105.65, PIZZY MONO 65.105		

1 

<b>Part No.</b>	850072	<b>Ref. No.</b>	76002140 76003270
<b>description</b>	firebrick L 665mm W 336mm H 15mm delivery freight forwarding company only		
<b>For models:</b>	PIZZY DUO 65.105, PIZZY MONO 65.105		

1 

<b>Part No.</b>	850111	<b>Ref. No.</b>	76000060
<b>description</b>	firebrick L 700mm W 528mm H 14mm delivery freight forwarding company only		
<b>For models:</b>	PIZZY DUO 105.65, PIZZY MONO 105.65		

1 

<b>Part No.</b>	850069	<b>Ref. No.</b>	76001670 76001680
<b>description</b>	firebrick L 800mm W 425mm H 15mm delivery freight forwarding company only		
<b>For models:</b>	PC/GAS		

			
1			
<b>Part No.</b>	850068	<b>Ref. No.</b>	76002710
<b>description</b>	firebrick L 800mm W 425mm H 20mm delivery freight forwarding company only		
<b>For models:</b>	PC/GAS		

			
1			
<b>Part No.</b>	850078	<b>Ref. No.</b>	76000200 76001720
<b>description</b>	firebrick L 805mm W 415mm H 15mm delivery freight forwarding company only		
<b>For models:</b>	MHC 18C, MHC 18PC, MHC 30C, MHC 30PC, MHK - MHC - MHB		

			
1			
<b>Part No.</b>	850075	<b>Ref. No.</b>	76000210 76001750
<b>description</b>	firebrick L 850mm W 415mm H 15mm delivery freight forwarding company only		
<b>For models:</b>	RHC 18B, RHC 18C, RHC 18D, RHC 18PB, RHC 18PC, RHC 18PD, RHC 25B, RHC 25C, RHC 25PB, RHC 25PC, RHC 25PD, RHC-25D, RHK - RHC - RHB		

miscellaneous			
			
1			
<b>Part No.</b>	690992	<b>Ref. No.</b>	46003060 71000310
<b>description</b>	door hinge		
<b>For models:</b>	AHB, AHC, AHK, KRX 4, KRX 44, MHK - MHC - MHB, P110 GAS A, P110 GAS B, PIZZY DUO 105.65, PIZZY DUO 60.60, PIZZY MONO 105.65, PIZZY MONO 60.60, RHK - RHC - RHB		

			
1			
<b>Part No.</b>	514420	<b>Ref. No.</b>	46003070 71000300
<b>description</b>	door hinge L 76mm W 30mm mounting pos. left thickness 30mm for pizza oven		
<b>For models:</b>	AHB, AHC, AHK, MHK - MHC - MHB, P110 GAS A, P110 GAS B, PIZZY DUO 105.105, PIZZY DUO 105.65, PIZZY DUO 65.105, PIZZY MONO 105.105, PIZZY MONO 105.65, PIZZY MONO 65.105, RHK - RHC - RHB		

gear wheels			
			
1			
<b>Part No.</b>	693418	<b>Ref. No.</b>	71901030
<b>description</b>	gear wheel teeth 11 shaft intake ø 20mm ø 50mm hub ømm stainless steel		
<b>For models:</b>	T75E, T75G, T97E, T97G		

knobs			
producer-specific knobs			
MORETTI			
			
1			
<b>Part No.</b>	112944	<b>Ref. No.</b>	73600140
<b>description</b>	knob 1-10 t.max.°C ø 50mm shaft ø 6x4.6mm shaft flat lower silver		
<b>For models:</b>	KR 66T, KR 6T, KR 9, KR 99, KRX 4, KRX 44, KRX 6, KRX 66, KRX 66T, KRX 6T, KRX 9, KRX 99		

			
1			
<b>Part No.</b>	111769	<b>Ref. No.</b>	72800360
<b>description</b>	knob thermostat 1-10 ø 54mm shaft ø 6x4.6mm shaft flat lower		
<b>For models:</b>	PIZZY DUO 105.105, PIZZY DUO 105.65, PIZZY DUO 60.60, PIZZY DUO 65.105, PIZZY MONO 105.105, PIZZY MONO 105.65, PIZZY MONO 60.60, PIZZY MONO 65.105, PRESSY 33, PRESSY 45, PRESSY 50		



1

<b>Part No.</b>	112940	<b>Ref. No.</b>	73600130
<b>description</b>	knob thermostat 1-10 t.max.°C ø 50mm shaft ø 6x4.6mm shaft flat lower black		
<b>For models:</b>	KR 4, KR 44, KR 6, KR 66, KR 66T, KR 6T, KR 9, KR 99		



1

<b>Part No.</b>	111467	<b>Ref. No.</b>	72808120
<b>description</b>	knob thermostat 1-10 t.max.°C ø 54mm shaft ø 6x4.6mm shaft flat lower		



1

<b>Part No.</b>	112941	<b>Ref. No.</b>	73601100
<b>description</b>	knob thermostat t.max. 500°C ø 50mm shaft ø 6x4.6mm shaft flat lower black temperature range 50-500°C rotation 270°		
<b>For models:</b>	KR 4, KR 44, KR 6, KR 66		

## handles and hand wheels

### cylindrical handles

#### fixed



1

<b>Part No.</b>	112943	<b>Ref. No.</b>	73600750
<b>description</b>	cylindrical handle thread M10 ø 27mm L 91mm		
<b>For models:</b>	KR 4, KR 44, PIZZY DUO 105.105, PIZZY DUO 105.65, PIZZY DUO 60.60, PIZZY DUO 65.105, PIZZY MONO 105.105, PIZZY MONO 105.65, PIZZY MONO 60.60, PIZZY MONO 65.105, TIVOLI EL HI-TECH, TIVOLI GAS HI-TECH		



1

<b>Part No.</b>	110803	<b>Ref. No.</b>	73601180
<b>description</b>	cylindrical handle thread M12 ø 29mm L 87mm		

### cone handles



1

<b>Part No.</b>	112942	<b>Ref. No.</b>	73600470
<b>description</b>	cone handle thread M10 ø 29mm L 67mm plastic black		
<b>For models:</b>	KR 4, KR 44, KR 6, KR 66, KR 66T, KR 6T, KR 9, KR 99		



1

<b>Part No.</b>	693935	<b>Ref. No.</b>	769002B0
<b>description</b>	door handle thread M14 blue complete		

### levers

#### without handle



1

<b>Part No.</b>	691477	<b>Ref. No.</b>	72000860
<b>description</b>	handle rod thread M10		
<b>For models:</b>	KR 4, KR 44, KR 6, KR 66, KR 66T, KR 6T, KR 9, KR 99		
<b>accessories for</b>	691477		
	<b>Part No.</b>	<b>Ref. No.</b>	<b>73600470</b>
	112942		
	cone handle thread M10 ø 29mm L 67mm plastic black		
	<b>Part No.</b>	<b>Ref. No.</b>	<b>73600750</b>
	112943		
	cylindrical handle thread M10 ø 27mm L 91mm		

### accessories

#### miscellaneous



1

<b>Part No.</b>	524876	<b>Ref. No.</b>	72087030
<b>description</b>	thread bolt for handle ø 15mm T1: M10x1.5 T2: M14x2 total length 100mm		
<b>For models:</b>	PIZZY DUO 105.105, PIZZY DUO 105.65, PIZZY DUO 60.60, PIZZY DUO 65.105, PIZZY MONO 105.105, PIZZY MONO 105.65, PIZZY MONO 60.60, PIZZY MONO 65.105, TIVOLI EL HI-TECH, TIVOLI GAS HI-TECH		



locks

espagnolette locks

universal



<b>Part No.</b>	690041	<b>Ref. No.</b>	0751.02.0943 73600540
<b>description</b>	cam L 148mm mounting distance 32mm		

producer-specific

MORETTI



<b>Part No.</b>	690041	<b>Ref. No.</b>	0751.02.0943 73600540
<b>description</b>	cam L 148mm mounting distance 32mm		

<b>Part No.</b>	692206	<b>Ref. No.</b>	68000350
<b>description</b>	espagnolette lock complete		
<b>For models:</b>	TREVI ELETTRICO, TREVI GAS		

<b>Part No.</b>	692205	<b>Ref. No.</b>	0751.02.0942 73600530
<b>description</b>	latch gear shaft intake ø 8x8mm L 170mm W 40mm H 30mm		

hinges

door bearing



<b>Part No.</b>	700495	<b>Ref. No.</b>	72083970
<b>description</b>	bolt mounting pos. left for door hinge		
<b>For models:</b>	AHB, AHC, AHC 18A, AHC 18B, AHC 18C, AHK, MHC 18A, MHC 18B, MHC 18C, MHC 18PA, MHC 18PB, MHC 18PC, MHC 30A, MHC 30B, MHC 30C, MHC 30PA, MHC 30PB, MHC 30PC, MHK - MHC - MHB, P110 GAS, P110 GAS A, P110 GAS B, PC/GAS, RHC 18B, RHC 18C, RHC 18D, RHC 18PB, RHC 18PC, RHC 18PD, RHC 25B, RHC 25C, RHC 25PB, RHC 25PC, RHC 25PD, RHC-25D, RHK - RHC - RHB		

<b>Part No.</b>	700494	<b>Ref. No.</b>	72005090
<b>description</b>	bush L 69mm mounting pos. left ø 14.5mm ID ø 10mm for door hinge Qty 1 pcs		
<b>For models:</b>	AHB, AHC, AHC 18A, AHC 18B, AHC 18C, AHK, MHC 18A, MHC 18B, MHC 18C, MHC 18PA, MHC 18PB, MHC 18PC, MHC 30A, MHC 30B, MHC 30C, MHC 30PA, MHC 30PB, MHC 30PC, MHK - MHC - MHB, P110 GAS, P110 GAS A, P110 GAS B, PC/GAS, RHC 18B, RHC 18C, RHC 18D, RHC 18PB, RHC 18PC, RHC 18PD, RHC 25B, RHC 25C, RHC 25PB, RHC 25PC, RHC 25PD, RHC-25D, RHK - RHC - RHB		

<b>Part No.</b>	700496	<b>Ref. No.</b>	72005100
<b>description</b>	bush mounting pos. right for door hinge		
<b>For models:</b>	AHB, AHC, AHC 18A, AHC 18B, AHC 18C, AHK, MHC 18A, MHC 18B, MHC 18C, MHC 18PA, MHC 18PB, MHC 18PC, MHC 30A, MHC 30B, MHC 30C, MHC 30PA, MHC 30PB, MHC 30PC, MHK - MHC - MHB, P110 GAS, P110 GAS A, P110 GAS B, PC/GAS, PIZZY DUO 105.105, PIZZY DUO 105.65, PIZZY DUO 65.105, PIZZY MONO 105.105, PIZZY MONO 105.65, PIZZY MONO 65.105		

<b>Part No.</b>	690992	<b>Ref. No.</b>	46003060 71000310
<b>description</b>	door hinge		
<b>For models:</b>	AHB, AHC, AHK, KRX 4, KRX 44, MHK - MHC - MHB, P110 GAS A, P110 GAS B, PIZZY DUO 105.65, PIZZY DUO 60.60, PIZZY MONO 105.65, PIZZY MONO 60.60, RHK - RHC - RHB		

<b>Part No.</b>	514420	<b>Ref. No.</b>	46003070 71000300
<b>description</b>	door hinge L 76mm W 30mm mounting pos. left thickness 30mm for pizza oven		
<b>For models:</b>	AHB, AHC, AHK, MHK - MHC - MHB, P110 GAS A, P110 GAS B, PIZZY DUO 105.105, PIZZY DUO 105.65, PIZZY DUO 65.105, PIZZY MONO 105.105, PIZZY MONO 105.65, PIZZY MONO 65.105, RHK - RHC - RHB		



## gaskets

## sealing cords

## square



<b>Part No.</b>	693416	<b>Ref. No.</b>	56400120
<b>description</b>	sealing cord rectangular size 4x4mm L 0.09m Qty 6 motor gasket		
<b>For models:</b>	T75E, T75G, T97E, T97G		

## transmission technology and ball bearings

## ball bearings

## flange bearings



<b>Part No.</b>	693417	<b>Ref. No.</b>	73801540
<b>description</b>	flange bearing shaft $\varnothing$ 12mm W 38mm 2 hole flange hole distance 48mm H 20mm		
<b>For models:</b>	T75E, T75G, T97E, T97G		

## springs

## torsion springs



<b>Part No.</b>	694238	<b>Ref. No.</b>	72500440
<b>description</b>	spring $\varnothing$ mm L2 80mm mounting pos. front wire gauge $\varnothing$ 2mm FI32-FI42-FIP42 L1mm Qty 1 pcs		



<b>Part No.</b>	694239	<b>Ref. No.</b>	72500320
<b>description</b>	spring $\varnothing$ mm L2 80mm mounting pos. rear wire gauge $\varnothing$ 2mm FI32-FI42-FIP42 L1mm Qty 1 pcs		

## compression springs



<b>Part No.</b>	693422	<b>Ref. No.</b>	72501190
<b>description</b>	compression spring $\varnothing$ 14.8mm L 52mm wire gauge $\varnothing$ 2.8mm		
<b>For models:</b>	T75E, T75G, T97E, T97G		



<b>Part No.</b>	514417	<b>Ref. No.</b>	72500870
<b>description</b>	compression spring $\varnothing$ 15mm L 40mm wire gauge $\varnothing$ 1.4mm		



<b>Part No.</b>	514216	<b>Ref. No.</b>	72500860
<b>description</b>	compression spring $\varnothing$ 15mm L 60mm wire gauge $\varnothing$ 1.5mm		

## tension springs



<b>Part No.</b>	700492	<b>Ref. No.</b>	72500670
<b>description</b>	tension spring $\varnothing$ 20mm total length 230mm wire gauge $\varnothing$ 2.8mm L1 125mm L2 55mm L3 50mm pizza oven		
<b>For models:</b>	AHC 18A, AHC 18B, AHC 18C, AHK, MHC 18A, MHC 18B, MHC 18PA, MHC 18PB, MHK - MHC - MHB, PC/GAS, PIZZY DUO 105.105, PIZZY DUO 105.65, PIZZY DUO 65.105, PIZZY MONO 105.105, PIZZY MONO 105.65, PIZZY MONO 65.105, RHC 18B, RHC 18C, RHC 18D, RHC 18PB, RHC 18PC, RHC 18PD, RHC 25B, RHC 25C, RHC 25PB, RHC 25PC, RHC 25PD, RHC-25D, RHK - RHC - RHB		



<b>Part No.</b>	700493	<b>Ref. No.</b>	72500660
<b>description</b>	tension spring with thread $\varnothing$ 29.8mm total length 230 extendable max. 275mm wire gauge $\varnothing$ 4mm		
<b>For models:</b>	AHC, AHC, AHC 18A, AHC 18B, AHC 18C, MHC 18C, MHC 18PC, MHC 30A, MHC 30B, MHC 30C, MHC 30PA, MHC 30PB, MHC 30PC, MHK - MHC - MHB, P110 GAS, P110 GAS A, P110 GAS B, PC/GAS		

## measuring equipment

## thermometers

## built-in thermometers

 $\varnothing$ 60mm

<b>Part No.</b>	541879	<b>Ref. No.</b>	74220250
<b>description</b>	thermometer mounting $\varnothing$ 60mm 0 up to +500°C probe $\varnothing$ 8mm probe L 155mm capillary pipe 1000mm		
<b>For models:</b>	KR 4, KR 44, KR 6, KR 66, KR 66T, KR 6T, KR 9, KR 99, PIZZY DUO 105.105, PIZZY DUO 105.65, PIZZY DUO 60.60, PIZZY DUO 65.105, PIZZY MONO 105.105, PIZZY MONO 105.65, PIZZY MONO 60.60, PIZZY MONO 65.105		



## fastening material

fasteners

roll pins



1

<b>Part No.</b>	691637	<b>Ref. No.</b>	72500920
<b>description</b>	roll pin ø 3mm L 20mm		

**GASTRO**PARTS.COM

