



**GASTROPARTS**

# Mondial

- [EN]** Equipment
- [DE]** Geräte
- [ES]** Aparatos
- [FR]** Équipement
- [IT]** Attrezzature
- [PL]** Urządzenia
- [RU]** Оборудование

✉ [gastroparts@gastroparts.com](mailto:gastroparts@gastroparts.com)

☎ tel. +48 56 657 00 66

📘 [fb.com/gastroparts.global](https://fb.com/gastroparts.global)

**GASTROPARTS.COM**





## heating elements

### heating elements for refrigeration

#### heating elements for defrosting



<b>Part No.</b>	419137	<b>Ref. No.</b>	4003116147000
<b>description</b>	heating element 1100W 230V L 1000mm W 70mm cable length 1800mm tube ø 8.5mm defrosting		



<b>Part No.</b>	417587	<b>Ref. No.</b>	TDE072220
<b>description</b>	heating element 350W 230V L 380mm Wmm Hmm cable length 3.3m tube ø 8.7mm		

#### heating cartridges



<b>Part No.</b>	417577	<b>Ref. No.</b>	1192081 (alternativ)
<b>description</b>	heating cartridge 190W 230V ø 12mm L 180mm thread 3/8" cable length 300mm suitable for MONDIAL		



<b>Part No.</b>	417571	<b>Ref. No.</b>	1192081
<b>description</b>	heating cartridge 230W 230V ø 12mm L 180mm thread 3/8" cable length 1000mm universal		

## thermostats

### refrigeration thermostats

#### RANCO

##### K50 series

RANCO



<b>Part No.</b>	390988	<b>Ref. No.</b>	1101031
<b>description</b>	thermostat RANCO type K50B-S3508 probe ø 2mm capillary pipe 1500mm		

RANCO



<b>Part No.</b>	390780	<b>Ref. No.</b>	1001086
<b>description</b>	thermostat RANCO type K50-L3085 probe ømm probe Lmm capillary pipe 1800mm		

RANCO



<b>Part No.</b>	390528	<b>Ref. No.</b>	1101043
<b>description</b>	thermostat RANCO type K50L3417 probe ø 10mm probe L 100mm capillary pipe 1400mm probe ø9.5x112mm		

RANCO



<b>Part No.</b>	390803	<b>Ref. No.</b>	1101005
<b>description</b>	thermostat RANCO type K50-P1569/001 probe L 50mm capillary pipe 900mm		

#### K54 series

RANCO



<b>Part No.</b>	390782	<b>Ref. No.</b>	1001118 1101001G
<b>description</b>	thermostat RANCO type K54L2097 probe ø 2mm capillary pipe 900mm		



ATEA



<b>Part No.</b>	390794	<b>Ref. No.</b>	1101028
<b>description</b>	thermostat ATEA type A01 0806 probe ø 10mm probe L 52mm capillary pipe 1150mm		



<b>Part No.</b>	390781	<b>Ref. No.</b>	1101029
<b>description</b>	thermostat T war -15°C T cold -32°C probe ø 2mm capillary pipe 2500mm type A01 0791		



<b>Part No.</b>	346377	<b>Ref. No.</b>	1014073
<b>description</b>	rocker switch mounting measurements 30x22mm black 2CO 230V 16A 0-I connection male faston 6.3mm ambient temperature max. 125/55°C protection IP40		

<b>accessories for</b>	346377			
	<b>Part No.</b>	301036	<b>Ref. No.</b>	—
	protective cover internal size 30x22mm for rocker switch mounting measurementsmm			

1

<b>Part No.</b>	301287	<b>Ref. No.</b>	1114001G 1114018
<b>description</b>	rocker switch mounting measurements 30x22mm orange 2NO 250V 16A illuminated 0-I connection male faston 6.3mm ambient temperature max. 100/55°C protection IP40		

switches and momentary switches

rocker/momentary rocker switches

30x22mm



<b>Part No.</b>	301002	<b>Ref. No.</b>	1014056
<b>description</b>	rocker switch mounting measurements 30x22mm orange 2NO 250V 16A illuminated 0-I connection male faston 6.3mm ambient temperature max. 85/125°C protection IP65		

<b>accessories for</b>	301002			
	<b>Part No.</b>	301036	<b>Ref. No.</b>	—
	protective cover internal size 30x22mm for rocker switch mounting measurementsmm			



<b>Part No.</b>	301009	<b>Ref. No.</b>	1114014
<b>description</b>	rocker switch mounting measurements 30x22mm white 2NO 250V 16A illuminated 0-I connection male faston 6.3mm ambient temperature max. 125/55°C protection IP65		

<b>accessories for</b>	301009			
	<b>Part No.</b>	301036	<b>Ref. No.</b>	—
	protective cover internal size 30x22mm for rocker switch mounting measurementsmm			

push/momentary push switches

ø16mm



<b>Part No.</b>	301295	<b>Ref. No.</b>	1114013
<b>description</b>	push switch mounting ø 16mm black 1NO 250V 16A connection male faston 6.3mm protection IP40 ambient temperature max. 150°C		

microswitches

with push button

switches with snap-fit



<b>Part No.</b>	348148	<b>Ref. No.</b>	1195012
<b>description</b>	microswitch with push button 250V 0.25A 1NO connection male faston 6.3mm L 26x12mm ambient temperature max. 85°C actuating force: 500g		
<b>For models:</b>	EBA01W540		



roller actuated

roller 90°



1

<b>Part No.</b>	347640	<b>Ref. No.</b>	1095001
<b>description</b>	microswitch with roller plunger 250V 16A connection male faston 6.3mm ambient temperature max. 85°C thread M12		

**lamps**

indicator lights

indicator lights (complete)

30x22mm



1

<b>Part No.</b>	359157	<b>Ref. No.</b>	1111002G
<b>description</b>	indicator light mounting measurements 30x22mm 230V green connection male faston 6.3mm temp.-resist. 125/55°C type RL2		
<b>accessories for</b>	359157		
	<b>Part No.</b>	301036	<b>Ref. No.</b>
			—
<b>description</b>	protective cover internal size 30x22mm for rocker switch mounting measurementsmm		



1

<b>Part No.</b>	347641	<b>Ref. No.</b>	10110141 1111001G
<b>description</b>	indicator light mounting measurements 30x22mm 230V red connection male faston 6.3mm		

fluorescent lamps

fluorescent lamps

G13



1

<b>Part No.</b>	359371	<b>Ref. No.</b>	1112007
<b>description</b>	fluorescent lamp socket G13 L 590mm 18W 230V Qty 1 pcs		

**timers**

defrost timers

CDC



1

<b>Part No.</b>	360193	<b>Ref. No.</b>	1186003
<b>description</b>	defrost timer CDC type 13102 defrosting interval 1-12x in 24h defrosting time 2-50min fan delay 0-10min 230V 50Hz defr. funct. 1-12x per 24h with delay of fan 0-10min		

miscellaneous



1

<b>Part No.</b>	360187	<b>Ref. No.</b>	1186010
<b>description</b>	defrost timer type RZ-2001-21 defrosting interval 4H defrosting time 15min fan delay 5min 230V 50Hz defr. funct. 4x per 24h		

**relays**

power relays

with bracket mounting



1

<b>Part No.</b>	380815	<b>Ref. No.</b>	1142005
<b>description</b>	power relays 230VAC 16A 2NO connection male faston 6.3mm flange dimensions 36x38x68mm		



1

<b>Part No.</b>	380185	<b>Ref. No.</b>	1042007
<b>description</b>	power relays Italiana Relè 230VAC 30A 1NO connection F6.3 bracket mounting dimensions 36.5x32.2x51.8mm manuf. no. A10-230AC-FA		

## electronic controllers

### DIXELL

#### refrigeration controllers

##### built-in version



1

<b>Part No.</b>	378307	<b>Ref. No.</b>	1188054
<b>description</b>	electronic controller DIXELL XR40C-5N1C1 mounting measurements 71x29mm 230V voltage AC NTC/PTC relay outputs 2 NO-20A(8) CO-8A(3) NTC/PTC DI protection IP54 0-60°C display 3½ digits		

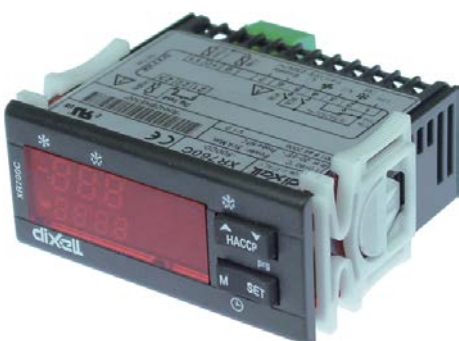

1

<b>Part No.</b>	378020	<b>Ref. No.</b>	N/A
<b>description</b>	electronic controller DIXELL XR760C-500C0 mounting measurements 71x29mm defr. funct. no		

## TECNOLOGIC

#### universal controllers

##### built-in version



1



<b>Part No.</b>	379796	<b>Ref. No.</b>	1188053
<b>description</b>	electronic controller TECNOLOGIC type TLZ11FR-21 mounting measurements 71x29mm 12V voltage AC/DC NTC/PTC relay outputs 1 CO-8A(3) NTC/PTC DI built-in depth 64mm defr. funct. no -50 up to +150°C display 4 digits		

#### refrigeration controllers

##### built-in version



1

<b>Part No.</b>	379206	<b>Ref. No.</b>	1088016
<b>description</b>	electronic controller TECNOLOGIC type TDF11F mounting measurements 71x29mm 12V voltage AC/DC NTC/PTC/Pt100/Pt1000/TC(J,K) -50 up to +150°C display 2½ digit		
<b>accessories for</b>	379206		
	<b>Part No.</b>	<b>Ref. No.</b>	—
	temperature probe PTC 1kOhm cable silicone probe -50 up to +150°C cable -50 up to +180°C probe ø6x40mm cable length 1.5m without screw connection 2-wire		
	<b>Part No.</b>	<b>Ref. No.</b>	—
	temperature probe PTC 1kOhm cable PVC probe -50 up to +150°C cable -10 up to 100°C probe ø6x30mm cable length 3m without screw connection 2-wire		
	<b>Part No.</b>	<b>Ref. No.</b>	—
	transformer primary 230VAC secondary 12VAC 3VA secondary 0.25A H 40mm L 45mm W 50mm connection screw 50/60Hz type 153/M		



1

<b>Part No.</b>	379796	<b>Ref. No.</b>	1188053
<b>description</b>	electronic controller TECNOLOGIC type TLZ11FR-21 mounting measurements 71x29mm 12V voltage AC/DC NTC/PTC relay outputs 1 CO-8A(3) NTC/PTC DI built-in depth 64mm defr. funct. no -50 up to +150°C display 4 digits		



			
1			
<b>Part No.</b>	378519	<b>Ref. No.</b>	1188179
<b>description</b>	electronic controller TECNOLOGIC type Y39SE mounting measurements 71x29mm 100-240V voltage AC NTC/PTC relay outputs 3 NO-16A CO-10A NO-5A NTC/PTC NTC/PTC DI front measurements 78x35mm built-in depth 64mm protection IP65 yes yes defr. funct. yes -50 up to +150°C display 3 digits		

			
1			
<b>Part No.</b>	378458 <sup>1</sup>	<b>Ref. No.</b>	N/A
<b>description</b>	electronic controller TECNOLOGIC type Y39S-HRRRB--A-E---- mounting measurements 74x32mm 100-240V voltage AC NTC/PTC relay outputs 3 NO-16A(9) CO-8A(3) NO-5A(2) NTC/PTC NTC/PTC DI built-in depth 64mm yes defr. funct. yes -99 up to +150°C display 3½ digits		
<b>accessories for</b>	378458		
	<b>Part No.</b>	378261	<b>Ref. No.</b> —
	temperature probe NTC 10kOhm cable thermoplastic probe -40 up to +110°C cable -40 up to +110°C probe ø6x35mm cable length 3m without screw connection 2-wire		
	<b>Part No.</b>	379052	<b>Ref. No.</b> —
	temperature probe PTC 1kOhm cable silicone probe -50 up to +150°C cable -50 up to +180°C probe ø6x40mm cable length 1.5m without screw connection 2-wire		
	<b>Part No.</b>	379053	<b>Ref. No.</b> —
	temperature probe PTC 1kOhm cable PVC probe -50 up to +150°C cable -10 up to 100°C probe ø6x30mm cable length 3m without screw connection 2-wire		
	<b>Part No.</b>	379064	<b>Ref. No.</b> —
	temperature probe PTC 1kOhm cable silicone probe -50 up to +150°C cable -50 up to +180°C probe ø6x40mm cable length 3m without screw connection 2-wire		
	<b>Part No.</b>	379142	<b>Ref. No.</b> —
	temperature probe PTC 1kOhm cable PVC probe -50 up to +150°C cable -10 up to 100°C probe ø6x30mm cable length 1.5m without screw connection 2-wire		
	<b>Part No.</b>	379160	<b>Ref. No.</b> —
	temperature probe NTC 10kOhm cable thermoplastic probe -40 up to +110°C cable -40 up to +110°C probe ø6x14mm cable length 1.5m without screw connection 2-wire		
	<b>Part No.</b>	379161	<b>Ref. No.</b> —
	temperature probe NTC 10kOhm cable thermoplastic probe -40 up to +110°C cable -40 up to +110°C probe ø6x14mm cable length 3m without screw connection 2-wire		
	<b>Part No.</b>	379342	<b>Ref. No.</b> —
	temperature probe NTC 10kOhm cable PVC probe -20 up to +80°C cable -10 up to 100°C probe ø6x25mm cable length 1.5m 2-wire protection IP67		
	<b>Part No.</b>	379343	<b>Ref. No.</b> —
	temperature probe NTC 10kOhm cable silicone probe -40 up to +110°C cable -50 up to +180°C probe ø6x40mm cable length 3m 2-wire		
	<b>Part No.</b>	379458	<b>Ref. No.</b> —
	temperature probe NTC 10kOhm cable silicone probe -40 up to +110°C cable -50 up to +180°C probe ø6x40mm cable length 1.5m without screw connection 2-wire		

<sup>1</sup>application by touchscreen

<b>accessories for</b>	378458		
	<b>Part No.</b>	379637	<b>Ref. No.</b> —
	temperature probe PTC 1kOhm cable PVC probe -50 up to +150°C cable -10 up to 100°C probe ø6x35mm cable length 2m without screw connection 2-wire		
	<b>Part No.</b>	379781	<b>Ref. No.</b> —
	temperature probe PTC 1kOhm cable thermoplastic probe -50 up to +150°C cable -40 up to +110°C probe ø6x14mm cable length 1.5m without screw connection 2-wire		
	<b>Part No.</b>	379782	<b>Ref. No.</b> —
	temperature probe PTC 1kOhm cable thermoplastic probe -50 up to +150°C cable -40 up to +110°C probe ø6x14mm cable length 3m 2-wire resistor 1kOhm		
	<b>Part No.</b>	379804	<b>Ref. No.</b> —
	protector for electronic controller 71x29 L 93mm W 65mm plexiglas		
	<b>Part No.</b>	379860	<b>Ref. No.</b> —
	temperature probe NTC 10kOhm cable PVC probe -20 up to +80°C cable -10 up to 100°C probe ø6x40mm cable length 1.5m without screw connection 2-wire		

## compressors

### ACC/ZEL

#### R134A

#### LBP monophase

Lower evaporation temperature below -20°C

			
1			
<b>Part No.</b>	605062	<b>Ref. No.</b>	4106006+1147033
<b>description</b>	compressor coolant R134a type GL80AA 220-240V 50Hz LBP fully hermetic 9kg 1/5HP cylinder capacity 7.39cm <sup>3</sup> RSIR H 175mm 102W 144W 196W 256W 326W test method ASHRAE ambient temperature max. 43°C		



R404a/R507

HMBP monophase

High/Medium evaporation temperature above -20/-15 °C



1

<b>Part No.</b>	605014	<b>Ref. No.</b>	4106053 4106053+1147263
<b>description</b>	compressor coolant R404a/R507 type ML80TB 220-240V 50Hz HMBP fully hermetic 11.4kg 3/8HP cylinder capacity 7.57cm <sup>3</sup> CSIR H 175.5mmW 261W 346W 446W 561W 691W 835W 993W 1167W test method ASHRAE ambient temperature max. 43°C		



1

<b>Part No.</b>	605028	<b>Ref. No.</b>	4106054 4106054+1147282
<b>description</b>	compressor coolant R404a/R507 type ML90TB 220-240V 50Hz HMBP fully hermetic 11.6kg 3/8HP cylinder capacity 8.85cm <sup>3</sup> CSIR H 175.5mmW 323W 418W 532W 666W 819W 990W 1181W 1391W test method ASHRAE ambient temperature max. 43°C		

CUBIGEL

R134A

LBP monophase

Lower evaporation temperature below -20°C



1

<b>Part No.</b>	605197	<b>Ref. No.</b>	4106004 4106004+1147031
<b>description</b>	compressor coolant R134a type GL60AA 220-240V 50Hz LBP 9.1kg 1/6HP power input 126W cylinder capacity 5.99cm <sup>3</sup> RSIR H 175mm 98W 135W 178W 227W 283W test method ASHRAE ambient temperature max. 43°C		



1

<b>Part No.</b>	605185	<b>Ref. No.</b>	4106017+1147210
<b>description</b>	compressor coolant R134a type GL90AA 220-240V 50Hz LBP 9.4kg 1/4HP power input 184W cylinder capacity 8.1cm <sup>3</sup> RSIR H 185.6mm 148W 200W 261W 330W 407W test method ASHRAE ambient temperature max. 43°C		



R404a/R507

LBP monophase

Lower evaporation temperature below -20°C



1

<b>Part No.</b>	605207	<b>Ref. No.</b>	4106033+1147260 4106051
<b>description</b>	compressor coolant R404a/R507 type ML80FB 220-240V 50Hz LBP 10.9kg 1/4HP cylinder capacity 8.1cm <sup>3</sup> CSIR H 185mm 276W 314W 356W 401W 450WWWWWW test method ASHRAE ambient temperature max. 43°C		

EMBRACO / ASPERA

R134A

LBP monophase

Lower evaporation temperature below -20°C



1

<b>Part No.</b>	605265	<b>Ref. No.</b>	4108050+1147500
<b>description</b>	compressor coolant R134a type NE2134Z 220-240V 50Hz LBP 11.65kg 1/2HP cylinder capacity 14.28cm <sup>3</sup> CSIR 261W 350W 458W 588W 741WWWWWW test method ASHRAE		



1

<b>Part No.</b>	605176	<b>Ref. No.</b>	4106034
<b>description</b>	compressor coolant R404a/R507 type ML90FB 220-240V 50Hz LBP 11kg 1/3HP cylinder capacity 8.85cm <sup>3</sup> CSIR H 198mm 305W 394W 495W 606W 729WWWWWW test method ASHRAE		

R404a/R507

LBP monophase

Lower evaporation temperature below -20°C



1

<b>Part No.</b>	605260	<b>Ref. No.</b>	4106112+1147424
<b>description</b>	compressor coolant R404A type NT2192GK 220/240V 50Hz LBP 17.5kg 1.1HP cylinder capacity 22.37cm <sup>3</sup> CSCR 815W 1066W 1361W 1701W 2085WWWWWW		

HMBP monophase

High/Medium evaporation temperature above -20/-15 °C



1

<b>Part No.</b>	605029	<b>Ref. No.</b>	4106070 4106113 4106113+1147428
<b>description</b>	compressor coolant R404a/R507 type MP12RB 220-240V 50Hz HMBP fully hermetic 13.5kg 1/2HP cylinder capacity 12cm <sup>3</sup> CSR H 203.6mmW 561W 734W 933W 1157W 1407W 1681W 1982WW test method ASHRAE ambient temperature max. 43°C		

HMBP monophase

High/Medium evaporation temperature above -20/-15 °C



1

<b>Part No.</b>	605125	<b>Ref. No.</b>	4108043
<b>description</b>	compressor coolant R404a/R507 type NEK6213GK 220-240V 50Hz HMBP 11.6kg 1/2HP cylinder capacity 12.12cm <sup>3</sup> CSIR H 206mmW 695W 884W 1093W 1333W 1600W 1894W 2215W test method ASHRAE		





			
1			
<b>Part No.</b>	605178	<b>Ref. No.</b>	4108045
<b>description</b>	compressor coolant R404a/R507 type NEK6217GK 220-240V 50Hz HMBP 11.6kg 5/8HP cylinder capacity 14.3cm <sup>3</sup> CSR H 206mmW 777W 954W 955W 1171W 1386W 1651W 1916W		

			
1			
<b>Part No.</b>	605132	<b>Ref. No.</b>	4108069
<b>description</b>	compressor coolant R404a/R507 type NT6222GK 200-240V 50Hz HMBP fully hermetic 17kg 1HP cylinder capacity 17.39cm <sup>3</sup> CSR H 252mmW 810W 1032W 1040W 1174W 1307W 1583W 2247W test method ASHRAE		
<b>accessories for</b>	605132		
	<b>Part No.</b>	365142	<b>Ref. No.</b> —
	operating capacitor capacity 15µF 450V with metal case tolerance 5% 50/60Hz ø 40mm L 110mm M8x1.25		
	<b>Part No.</b>	365153	<b>Ref. No.</b> —
	starting capacitor 52µF 330V 50/60Hz duty cycle 3s 41280A133 2252347 ø 36mm L 83mm M8 plastic connection cable 350mm		
	<b>Part No.</b>	390981	<b>Ref. No.</b> —
	klixon suitable for NT6222GK		

## SECOP DANFOSS

R404a/R507

LBP monophase

Lower evaporation temperature below -20°C

			
1			
<b>Part No.</b>	605057	<b>Ref. No.</b>	4109024 4109024+1147206
<b>description</b>	compressor coolant R404a/R507 type SC12CL 220-240V 50Hz LBP fully hermetic 12.5kg 3/8HP cylinder capacity 12.87cm <sup>3</sup> CSIR H 209mm 410W 568W 754W 971W 1220W 1505W test method ASHRAE		
<b>spare parts for</b>	605057		
	<b>Part No.</b>	380078	<b>Ref. No.</b> —
	start relay DANFOSS 117U6005 HST		

			
1			
<b>Part No.</b>	605058	<b>Ref. No.</b>	4109054 4109054+1147324
<b>description</b>	compressor coolant R404a/R507 type SC15CL 220-240V 50Hz LBP fully hermetic 13.8kg 1/2HP cylinder capacity 15.28cm <sup>3</sup> CSIR H 219mm 486W 637W 813W 1017W 1251W 1699W test method ASHRAE 175W 358W		
<b>spare parts for</b>	605058		
	<b>Part No.</b>	380058	<b>Ref. No.</b> —
	start relay DANFOSS 117U6019/F278 HST		



<b>Part No.</b>	605056	<b>Ref. No.</b>	4109026+1147323
<b>description</b>	compressor coolant R404a/R507 type SC18CLX.2 220-240V 50Hz LBP fully hermetic 13.7kg 5/8HP cylinder capacity 17.69cm <sup>3</sup> CSR H 219mm 562W 691W 881W 1095W 1332W 1593W test method ASHRAE		
<b>spare parts for</b>	605056		
	<b>Part No.</b>	381548	<b>Ref. No.</b> —
	start relay DANFOSS		

fans

axial fans

import



<b>Part No.</b>	601510 <sup>1</sup>	<b>Ref. No.</b>	4021019
<b>description</b>	axial fan L 119mm W 119mm H 38mm 230VAC 50/60Hz 22/21W bearing ball bearing connection male faston 6.3mm SUNON temp.-resist. 70°C		

<sup>1</sup>with ball bearings

evaporation and condensing trays

condensing trays heated

universal

heating cartridges



<b>Part No.</b>	417577	<b>Ref. No.</b>	1192081 (alternativ)
<b>description</b>	heating cartridge 190W 230V ø 12mm L 180mm thread 3/8" cable length 300mm suitable for MONDIAL		





<b>Part No.</b>	417571	<b>Ref. No.</b>	1192081
<b>description</b>	heating cartridge 230W 230V ø 12mm L 180mm thread 3/8" cable length 1000mm universal		

refrigeration fans

cold air circulating fans

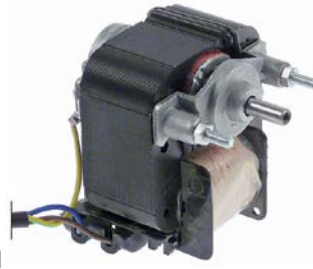
cold air circulating fans



<b>Part No.</b>	750398	<b>Ref. No.</b>	4121093
<b>description</b>	fan motor 230/240V 50/60Hz 35W shaft ø 6mm shaft L 14mm W 62mm H 73mm		
<b>accessories for</b>	750398		
	<b>Part No.</b>	601413	<b>Ref. No.</b> —
	fixing plate suitable for fanwheel ED ø 32mm shaft ø 7 mounting distance 26mm		
	<b>Part No.</b>	602184	<b>Ref. No.</b> —
	fixing plate suitable for fanwheel ED ø 33mm shaft ø 6 mounting distance 17mm		



cross flow fans

EMMEVI - FERGAS

with standard coil



1			
<b>Part No.</b>	602070	<b>Ref. No.</b>	4022150
<b>description</b>	cross flow fan 116299 roller ø 60mm roller length 180mm laminated core thickness 20mm 220/240V - 50/60Hz 28W bearing rubber connection male faston 6.3mm		

with moulded coils



1			
<b>Part No.</b>	601110	<b>Ref. No.</b>	4022142 4022149
<b>description</b>	cross flow fan TGO 60/1-180/20 roller ø 60mm roller length 180mm laminated core thickness 20mm motor position left 230V/50Hz 28W refrigeration bearing rubber connection male faston 6.3mm -30 up to +100°C 230V cable length 1800mm		
<b>For models:</b>	EBA01W540		

COPREL

with standard coil



1			
<b>Part No.</b>	602044	<b>Ref. No.</b>	4022141 4022148
<b>description</b>	cross flow fan COPREL TFR 180/20-14CSN roller ø 60mm roller length 180mm laminated core thickness 20mm motor position right 230V/50Hz 27W refrigeration bearing rubber connection male faston 6.3mm t.max. 60°C airflow 144m³/h -30 bis +60°C		
<b>For models:</b>	EBA01W540		

equipment-specific units

for fridges

miscellaneous



1			
<b>Part No.</b>	694849	<b>Ref. No.</b>	1721625
<b>description</b>	cover with sump for evaporator L 390mm W 355mm H 140mm plastic		

handles and hand wheels

bracket handles



1			
<b>Part No.</b>	502270	<b>Ref. No.</b>	1721369
<b>description</b>	pull handle L 300mm H 50mm mounting distance 218mm hole ø 5mm grey		

<b>accessories for</b>	502270		
<b>Part No.</b>	692567	<b>Ref. No.</b>	1721370
<b>description</b>	cover L 295mm H 26mm ABS plastic		



1			
<b>Part No.</b>	502268	<b>Ref. No.</b>	1721349
<b>description</b>	pull handle L 300mm H 50mm mounting distance 218mm hole ø 5mm white		



1			
<b>Part No.</b>	502269	<b>Ref. No.</b>	1721343
<b>description</b>	pull handle L 300mm H 50mm mounting distance 218mm hole ø 5mm white		

1

<b>Part No.</b>	690451	<b>Ref. No.</b>	2121009
<b>description</b>	pull handle L 426mm H 40mm mounting distance 376mm black		



1

<b>Part No.</b>	692571	<b>Ref. No.</b>	1721373
<b>description</b>	recessed handle L 250mm W 40mm H 20mm ABS plastic		

**covers**



1

<b>Part No.</b>	692566	<b>Ref. No.</b>	1721345
<b>description</b>	cover L 295mm H 26mm ABS plastic		



1

<b>Part No.</b>	692567	<b>Ref. No.</b>	1721370	
<b>description</b>	cover L 295mm H 26mm ABS plastic			
<b>accessories for</b>	692567			
	<b>Part No.</b>	502270	<b>Ref. No.</b>	1721369
	pull handle L 300mm H 50mm mounting distance 218mm hole ø 5mm grey			

**recessed handles**



1

<b>Part No.</b>	692568	<b>Ref. No.</b>	17210674
<b>description</b>	recessed handle L 120mm W 40mm H 22mm mounting distance 80mm ABS plastic		



1

<b>Part No.</b>	692569	<b>Ref. No.</b>	1721039
<b>description</b>	recessed handle L 140mm W 30mm H 25mm mounting distance 80mm ABS plastic		

**locks**

**locking devices**

**producer-specific**

**MONDIAL**



1

<b>Part No.</b>	692209	<b>Ref. No.</b>	5601058
<b>description</b>	key cylinder with slide latch ø 17mm thread M4 cam length 76mm cam width 13mm thread L 5.5mm		

**shelves and shelf rails**

**grates**

**universal**

**without upstand**



1

<b>Part No.</b>	970126	<b>Ref. No.</b>	0621117	
<b>description</b>	grate W 530mm D 650mm GN 2/1 plastic-coated steel wire gauge frame 8mm lengthwise wires gauge 5mm crossing wires 2 white suitable for refrigerator			
<b>accessories for</b>	970126			
	<b>Part No.</b>	690330	<b>Ref. No.</b>	—
	rack L 1000mm W 22mm H 4mm aperture 3x8mm hole distance 12.5mm stainless steel			
	<b>Part No.</b>	694700	<b>Ref. No.</b>	—
	shelf support L 31/28mm W 22mm H 18mm SS Qty 12 pcs			
	<b>Part No.</b>	694701	<b>Ref. No.</b>	—
	shelf support L 31/28mm W 22mm H 17mm SS with hook Qty 12 pcs			

producer-specific



<b>Part No.</b>	970549	<b>Ref. No.</b>	0621130
<b>description</b>	grate W 448mm D 453mm steel with layer RILSAN white suitable for refrigerator with hinge camp		



<b>Part No.</b>	970491	<b>Ref. No.</b>	0621140
<b>description</b>	grate W 518mm D 408mm plastic-coated steel		

**gaskets**

refrigeration gaskets

plug-in gaskets

profile 9431

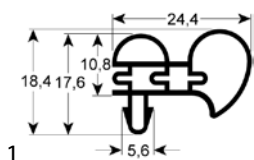

<b>Part No.</b>	902407	<b>Ref. No.</b>	N/A
<b>description</b>	refrigeration gasket profile 9431 Wmm L 2500mm		

profile 9050

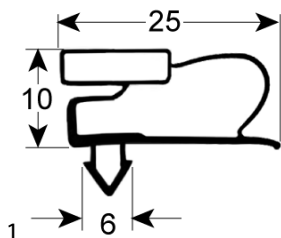

<b>Part No.</b>	901441	<b>Ref. No.</b>	4612003
<b>description</b>	refrigeration gasket profile 9050 W 518mm L 1627mm plug size L1 1640mm W1 531mm external size		

profile 9773

We offer custom-made gaskets for this profile

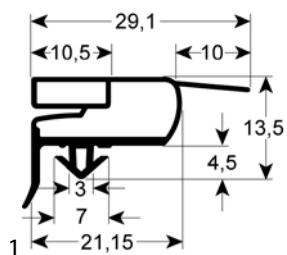

<b>Part No.</b>	901782	<b>Ref. No.</b>	4612040
<b>description</b>	refrigeration gasket profile 9773 W 520mm L 1640mm external size W1 507mm L1 1627mm plug size		

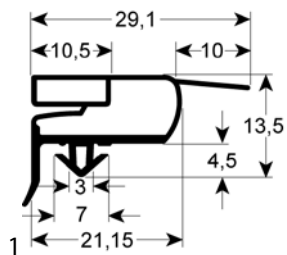

<b>Part No.</b>	901334	<b>Ref. No.</b>	4612135
<b>description</b>	refrigeration gasket profile 9773 W 558mm L 732mm plug size		

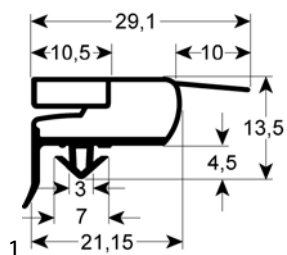

<b>Part No.</b>	901090	<b>Ref. No.</b>	4612084
<b>description</b>	refrigeration gasket profile 9773 W 566mm L 1455mm external size W1 553mm L1 1442mm plug size		

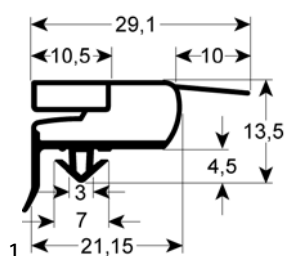

<b>Part No.</b>	901088	<b>Ref. No.</b>	4612082
<b>description</b>	refrigeration gasket profile 9773 W 566mm L 1705mm external size W1 553mm L1 1692mm plug size		



<b>Part No.</b>	901487	<b>Ref. No.</b>	4612091
<b>description</b>	refrigeration gasket profile 9773 W 635mm L 1530mm external size W1 622mm L1 1517mm plug size grey		

<b>Part No.</b>	901977	<b>Ref. No.</b>	4612039
<b>description</b>	refrigeration gasket profile 9773 W 736mm L 1540mm plug size suitable for MONDIAL		

<b>Part No.</b>	901781	<b>Ref. No.</b>	4612120
<b>description</b>	refrigeration gasket profile 9773 W 635mm L 1530mm external size W1 622mm L1 1517mm plug size white		

<b>Part No.</b>	901087	<b>Ref. No.</b>	4612083
<b>description</b>	refrigeration gasket profile 9773 W 740mm L 1700mm external size W1 727mm L1 1687mm plug size		

<b>Part No.</b>	901089	<b>Ref. No.</b>	4612038
<b>description</b>	refrigeration gasket profile 9773 W 640mm L 1540mm external size W1 627mm L1 1527mm plug size		

<b>Part No.</b>	902305	<b>Ref. No.</b>	N/A
<b>description</b>	refrigeration gasket profile 9773 Wmm L 2500mm		

<b>Part No.</b>	901783	<b>Ref. No.</b>	4612041
<b>description</b>	refrigeration gasket profile 9773 W 705mm L 1640mm external size W1 692mm L1 1627mm plug size		

**profile 9151**

*We offer custom-made gaskets for this profile*

<b>Part No.</b>	901098	<b>Ref. No.</b>	4612069
<b>description</b>	refrigeration gasket profile 9151 W 565mm L 1690mm plug size		

<b>Part No.</b>	901174	<b>Ref. No.</b>	4612138
<b>description</b>	refrigeration gasket profile 9151 W 572mm L 1709mm external size L1 1699mm W1 562mm plug size		

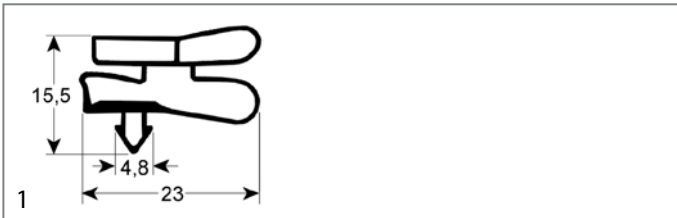

<b>Part No.</b>	902127	<b>Ref. No.</b>	4612156
<b>description</b>	refrigeration gasket profile 9151 W 632mm L 1525mm plug size grey		

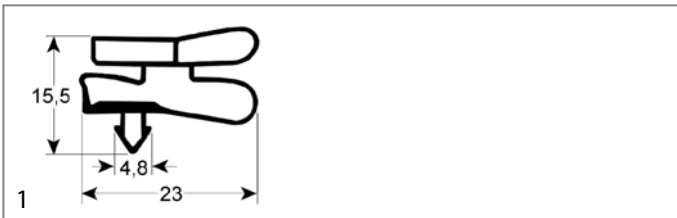

<b>Part No.</b>	902114	<b>Ref. No.</b>	4612155
<b>description</b>	refrigeration gasket profile 9151 W 632mm L 1525mm white		

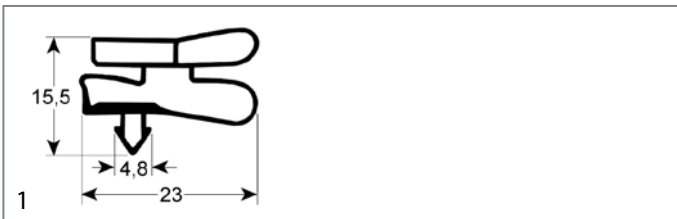

<b>Part No.</b>	901093	<b>Ref. No.</b>	4612005
<b>description</b>	refrigeration gasket profile 9151 W 720mm L 1655mm plug size L1 1645mm W1 710mm external size		

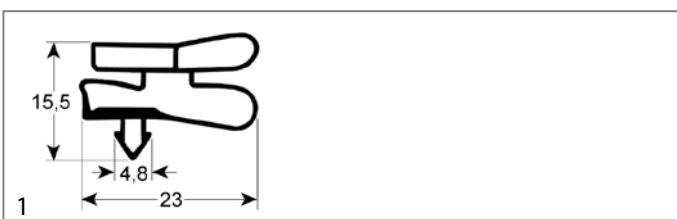

<b>Part No.</b>	901168	<b>Ref. No.</b>	4612139
<b>description</b>	refrigeration gasket profile 9151 W 737mm L 1699mm plug size		

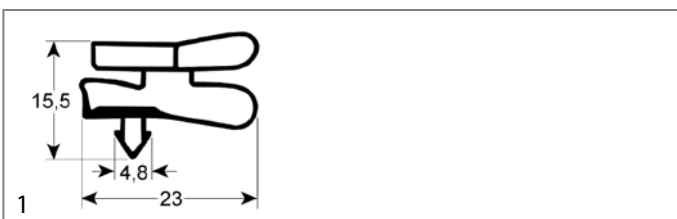

<b>Part No.</b>	901092	<b>Ref. No.</b>	4612068
<b>description</b>	refrigeration gasket profile 9151 W 755mm L 1705mm plug size L1 1695mm W1 745mm external size		

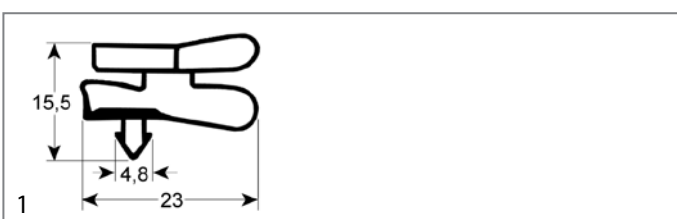

<b>Part No.</b>	902265	<b>Ref. No.</b>	N/A
<b>description</b>	refrigeration gasket profile 9151 Wmm L 2500mm		

profile 9010

We offer custom-made gaskets for this profile

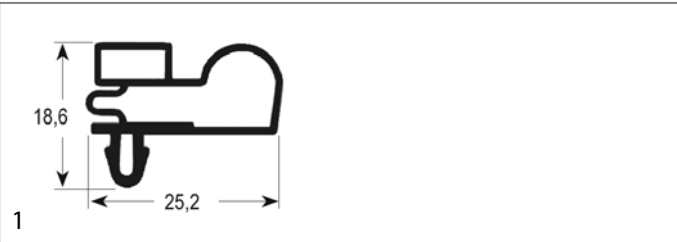

<b>Part No.</b>	900617	<b>Ref. No.</b>	TDE072290
<b>description</b>	refrigeration gasket profile 9010 W 515mm L 620mm plug size		

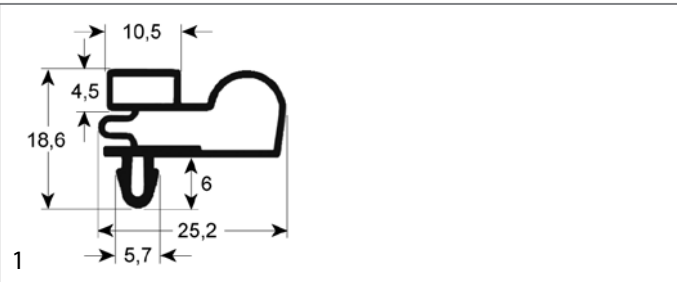

<b>Part No.</b>	902115	<b>Ref. No.</b>	4612154
<b>description</b>	refrigeration gasket profile 9010 W 643mm L 1407mm plug size		

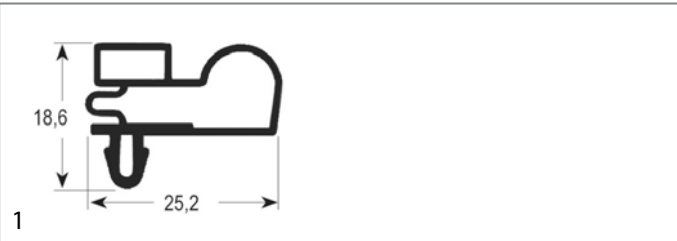

<b>Part No.</b>	901091	<b>Ref. No.</b>	4512017
<b>description</b>	refrigeration gasket profile 9010 W 650mm L 1545mm plug size		

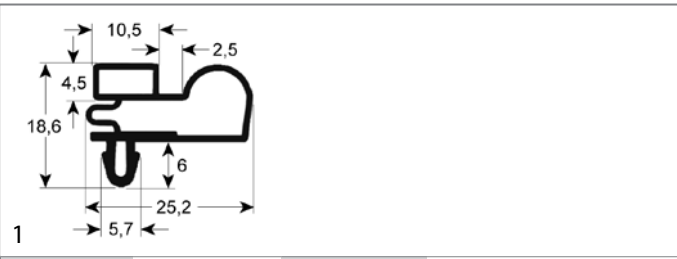

<b>Part No.</b>	902251	<b>Ref. No.</b>	N/A
<b>description</b>	refrigeration gasket profile 9010 Wmm L 2500mm		

profile 9373

We offer custom-made gaskets for this profile

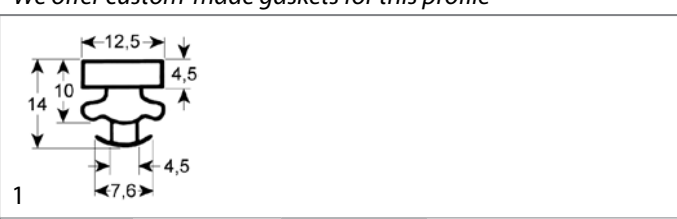

<b>Part No.</b>	902163	<b>Ref. No.</b>	N/A
<b>description</b>	refrigeration gasket profile 9373 Wmm L 2500mm		



## refrigeration cycle components

### filter driers

#### miscellaneous



1

<b>Part No.</b>	750244	<b>Ref. No.</b>	3141035
<b>description</b>	dryer size 15g ø 19mm L 117mm connection 3,2/6,2mm		
<b>For models:</b>	EBA01W540		



1

<b>Part No.</b>	750619	<b>Ref. No.</b>	3141033
<b>description</b>	dryer size 30g ø 24mm L 140mm connection 2,6/6,5mm Qty 1 pcs		

## evaporators

### for fridges

#### producer-specific



1

<b>Part No.</b>	750354	<b>Ref. No.</b>	4133007
<b>description</b>	evaporator L 1000mm W 470mm Hmm suitable for BEV/KIC		

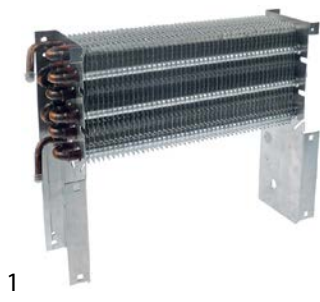

1

<b>Part No.</b>	750627	<b>Ref. No.</b>	4132069
<b>description</b>	evaporator L 335mm W 95mm H 275mm total length 355mm for fridge		



1

<b>Part No.</b>	750181	<b>Ref. No.</b>	TDE072247
<b>description</b>	evaporator L 360mm W 95mm H 350mm for Desmon refrigerated counter (PTR,LUX,TLM2A)		

## measuring equipment

### thermometers

#### built-in thermometers



1

<b>Part No.</b>	541081	<b>Ref. No.</b>	2531018
<b>description</b>	thermometer mounting measurements 58x25.5mm -40 up to +40°C capillary pipe 1500mm probe ø 8mm probe L 22mm		

#### battery powered



1

<b>Part No.</b>	379798	<b>Ref. No.</b>	1188017
<b>description</b>	thermometer mounting measurements 47x27mm battery comp. rear -40 up to +70°C cable length 2000mm white		

#### accessories for

<b>Part No.</b>	379798	<b>Ref. No.</b>	—
	frame for thermometer internal size 47x27mm W 53mm H 33mm D 17mm lug length 11mm hole distance 64.2mm		



**GASTRO**PARTS.COM

