



GASTROPARTS

Metro-Professional

- [EN]** Equipment
- [DE]** Geräte
- [ES]** Aparatos
- [FR]** Équipement
- [IT]** Attrezzature
- [PL]** Urządzenia
- [RU]** Оборудование

✉ gastroparts@gastroparts.com

☎ tel. +48 56 657 00 66

📘 fb.com/gastroparts.global

GASTROPARTS.COM





induction

induction coils



1

Part No.	404010	Ref. No.	AD100087
description	induction coils ø 220mm H 10mm		
For models:	GIC3035		

heating elements

heating elements for ovens

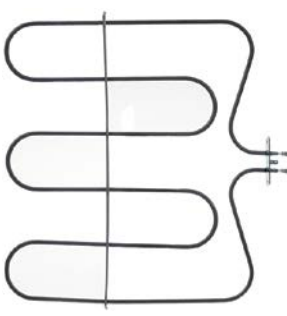

1

Part No.	416969	Ref. No.	01203250
description	heating element 1400W 230V heating circuits 1 L 370mm W 400mm L1 45mm L2 325mm W1 184mm W2 30mm flange length 70mm flange width 22mm hole distance 46mm bridge length 420mm hole ø 5mm tube ø 6.3mm connection male faston 6.3mm windings 3 rectangular flange dry heating element		
For models:	GCO2001		
accessories for	416969		
	Part No.	510368	Ref. No. —
	gasket L 70mm W 23.5mm hole ø 5mm hole distance 56mm FIBER thickness 2mm for heating element		

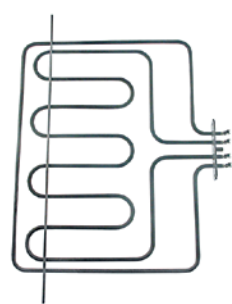

1

Part No.	416970	Ref. No.	01203240
description	heating element 2800W 230V heating circuits 2 L 323mm W 393mm L1 30mm L2 293mm W1 166mm W2 61mm flange length 100mm flange width 22mm hole distance 76mm bridge length 485mm hole ø 5mm tube ø 6.3mm connection male faston 6.3mm rectangular flange dry heating element		
For models:	GCO2001		
accessories for	416970		
	Part No.	528090	Ref. No. 01000160
	gasket L 100mm W 22mm thickness 1mm		

heating elements for fryers

2 hole fixing

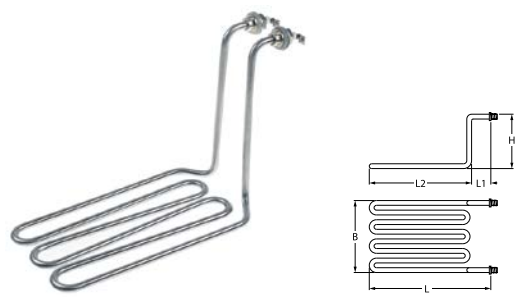

1

Part No.	417598	Ref. No.	1.07.HDF4140403
description	heating element 2500W 230V heating circuits 1 L 290mm W 130mm H 200mm L1 40mm L2 230mm tube ø 8mm		
For models:	GDF3004, GDF3024		

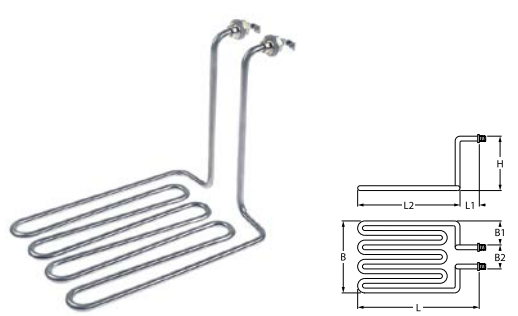

1

Part No.	417599	Ref. No.	1.07.HDF8141903
description	heating element 3250W 230V heating circuits 1 thread M12x1.25 L 280mm W 190mm H 210mm L1 35mm L2 245mm W1 120mm W2 70mm tube ø 8mm connection M4		
For models:	GDF3008, GDF3028, GDF5008, GDF5028		

heating elements for griddles



1

Part No.	419177	Ref. No.	D02169
description	heating element 1750W 230V heating circuits 1 L 255mm W 240mm H 60mm tube ø 6.3mm cable length 600mm bain marie connection distance 234mm dry heating element		
For models:	GEG2001		



heating elements for hot dog machines

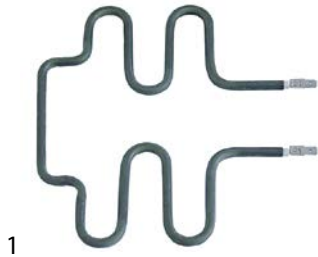

1

Part No.	416718	Ref. No.	D02002
description	heating element 300W 230V L 170mm W 198mm tube ϕ 6.3mm L1 50mm L2 120mm W1 68mm W2 62mm connection male faston 6.3mm connection distance 56mm dry heating element heating circuits 1 hot dog machine		
For models:	GHM1001		

heating cables

miscellaneous



1

Part No.	417745	Ref. No.	W0310067
description	heating cable 600V L 1100mm silicone connection plug GFR2700		
For models:	GFR2700		

quartz heating elements



1

Part No.	420089	Ref. No.	D04034	
description	quartz heating element 600W 115V L 365mm ϕ 11mm connection male faston 6.3mm			
For models:	GTO1001, GTO2001			
accessories for	420089			
	Part No.	551108	Ref. No.	B07025
	spring clip stainless steel for quartz heating element L 39mm W 25mm H 13.5mm bore ϕ 10mm			



1

Part No.	551108	Ref. No.	B07025
description	spring clip stainless steel for quartz heating element L 39mm W 25mm H 13.5mm bore ϕ 10mm		
For models:	GTO1001, GTO2001		





immersion heating elements

3 hole flange ϕ 38.5mm

1

Part No.	416267	Ref. No.	905560	
description	heating element 4500W 230V mounting ϕ 38.5mm heating circuits 3 L 358mm W 32mm H 58mm L1 36mm L2 72mm L3 250mm H1 28mm H2 30mm hole distance 57mm hole ϕ 10mm tube ϕ 6.3mm connection male faston 6.3mm immersion heater 3 hole flange			
For models:	GDW2001			
spare parts for	416267			
	Part No.	521120	Ref. No.	907981
	O-ring EPDM thickness 5.34mm ID ϕ 37.47mm Qty 1 pcs			
accessories for	416267			
	Part No.	532577	Ref. No.	—
	O-ring EPDM thickness 5.34mm ID ϕ 40.65mm Qty 1 pcs			

1

Part No.	416260	Ref. No.	905745	
description	heating element 2500W 230V heating circuits 1 L 357mm W 34mm H 39mm H1 4mm H2 35mm thread M10x1 mounting distance 28mm tube ϕ 6.3mm connection male faston 6.3mm 2 hole fixing immersion heater connection length 25mm			
For models:	GDW2001			
accessories for	416260			
	Part No.	510416	Ref. No.	—
	flat gasket fibre ED ϕ 19mm ID ϕ 10.5mm thickness 1.5mm for thread M10 Qty 1 pcs			
	Part No.	510893	Ref. No.	—
	O-ring EPDM thickness 2.62mm ID ϕ 9.92mm Qty 1 pcs			
	Part No.	520231	Ref. No.	—
	nut thread M10x1 H 6mm WS 14 zinc-coated steel Qty 1 pcs			
	Part No.	521129	Ref. No.	—
	nut thread M10 H 6mm SS WS 17 Qty 1 pcs DIN/ISO DIN 439			



heating elements for convection



1

Part No.	418044	Ref. No.	01203260
description	heating element 2500W 230V heating circuits 1 ID ø 180mm ED ø 192mm L 245mm H 28mm L1 45mm W1 30mm H1 3mm H2 25mm flange length 70mm flange width 22mm hole distance 56mm connection male faston 6.3mm tube ø 6.3mm convection heating element hole ø 5mm rectangular flange		
For models:	GCO2001		
accessories for	418044		
	Part No.	Ref. No.	01000140
	gasket L 71mm W 21mm hole ø 5mm hole distance 57mm fibre thickness 1mm for heating element		



1

Part No.	419243	Ref. No.	RES30033
description	heating element 2700W 230V heating circuits 1 ID ø 180mm ED ø 193mm L 208mm H 30mm L1 8mm W1 30mm H1 7mm H2 23mm flange length 70 no to be sold in Francemm flange width 22mm hole distance 56mm connection male faston 6.3mm tube ø 6.3mm convection heating element hole ø 5mm rectangular flange 70 x 22mm with screws		
For models:	GCO500		
spare parts for	419243		
	Part No.	Ref. No.	—
	sheet metal screws ø 3.9mm L 9.5mm SS Qty 20 pcs DIN 7981/ISO 7049 head ø 7.5mm oval head		

foil heating elements



1

Part No.	419256	Ref. No.	W0310080
description	foil heating element L 520mm W 220mm 61W 220V cable length 400mm connection plug GFR2700		
For models:	GFR2700		

accessories

various



1

Part No.	551108	Ref. No.	B07025
description	spring clip stainless steel for quartz heating element L 39mm W 25mm H 13.5mm bore ø 10mm		
For models:	GTO1001, GTO2001		

sealing washers

O-rings

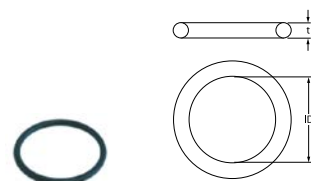

1

Part No.	521120	Ref. No.	907981
description	O-ring EPDM thickness 5.34mm ID ø 37.47mm Qty 1 pcs		
For models:	GDW2001		

flange gaskets



1

Part No.	528090	Ref. No.	01000160
description	gasket L 100mm W 22mm thickness 1mm		
For models:	GCO2001		



1

Part No.	550937	Ref. No.	01000140
description	gasket L 71mm W 21mm hole ø 5mm hole distance 57mm fibre thickness 1mm for heating element		
For models:	GCO2001		

thermostats

bi-metal thermostats

safety bi-metal thermostats





1

Part No.	390717	Ref. No.	907297
description	bi-metal safety thermostat hole distance 23.8mm switch-off temp. 110°C 1NC 1-pole 16A 250V connection F6.3 2 hole fixing mounting ø 18.3mm		
For models:	GDW2001		



bi-metal thermostats

			
1			
Part No.	390869	Ref. No.	253099000143
description	bi-metal thermostat hole distance 23.5mm switch-off temp. 140°C 1NC 1-pole 10A 250V connection F4.8 Qty 1 pcs		
For models:	GMW1025		

			
1			
Part No.	390634	Ref. No.	TER30002
description	bi-metal thermostat hole distance 23.5mm switch-off temp. 145°C 1NC 1-pole 16A 250V connection F6.3 2 hole fixing		
For models:	GCO500		

			
1			
Part No.	390867	Ref. No.	253099000224
description	bi-metal thermostat hole distance 23.5mm switch-off temp. 180°C 1NC 1-pole 10A 250V connection F4.8 Qty 1 pcs		
For models:	GMW1025		

			
1			
Part No.	390763	Ref. No.	907244
description	bi-metal thermostat hole distance 23.8mm switch-off temp. 55°C 1NC 1-pole 16A 250V connection F6.3 2 hole fixing for tank		
For models:	GDW2001		

THERMOSTATS METRO-PROFESSIONAL

control and safety thermostats

EGO

control thermostats

55.17_ series

			
			
1			
Part No.	371320	Ref. No.	A06032
description	thermostat t.max. 280°C temperature range 30-280°C 1-pole 1NO 16A probe ø 3mm probe L 170mm capillary pipe 860mm capillary pipe isolatedmm gland nut shaft L 14mm shaft position upper rotation 270°		
For models:	GEG2001		

			
			
1			
Part No.	391048	Ref. No.	TER30016
description	thermostat t.max. 292°C 1-pole 1NO probe ø 3mm probe L 182mm shaft ø 6x4.6mm shaft L 23mm shaft position upper° rotation 270° probe material SS with mounting accessories		
For models:	GCO500		

safety thermostats

55.32_ series

			
			
1			
Part No.	390999	Ref. No.	01202690
description	safety thermostat switch-off temp. 350°C temperature range°C 2-pole NC 20A probe ø 3mm probe L 187mm capillary pipe 690mm capillary pipe isolated 680mm gland nut shaft ømm probe SS		
For models:	GCO2001		



IMIT / TEMPOMATIC / ARTHERMO

control thermostats



Part No.	390683	Ref. No.	TR0440
description	thermostat t.max. 86°C temperature range 0-86°C 1-pole 1CO 16A probe ø 6.5mm probe L 98mm capillary pipe 1000mm capillary pipe isolated 960mm gland nut shaft ø 6x4.6mm shaft L 20mm shaft position +135° rotation 270° probe material copper		
For models:	GDW2001		
accessories for	390683		
		Part No.	110100
		Ref. No.	903982
	knob thermostat t.max. 90°C 0-90°C ø 42mm shaft ø 6x4.6mm shaft flat -135° black		

TECASA

control thermostats

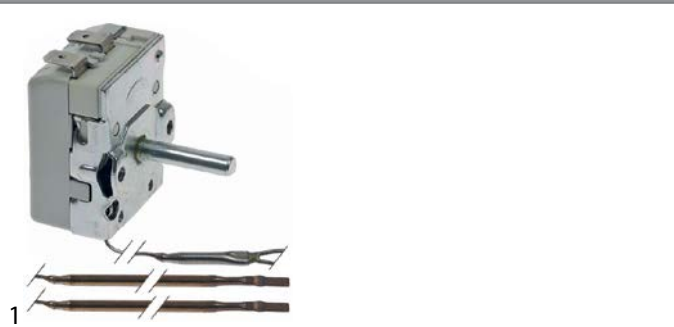

Part No.	376091	Ref. No.	01201220
description	thermostat t.max. 328°C temperature range 57-328°C 1-pole 1NO 16A probe ø 3mm probe L 98mm capillary pipe 1540mm capillary pipe isolated 1500mm gland nut shaft ø 6x4.6mm shaft L 21mm rotation 270° outer switch probe thread disc ømm		
For models:	GCO2001		

various

control thermostats



Part No.	390871	Ref. No.	1.1.A.A06.02
description	thermostat t.max. 95°C temperature range 0-95°C 1-pole 1NO 6A probe ø 6mm probe L 95mm capillary pipe 550mm capillary pipe isolated 490mm gland nut shaft ø 6x4mm shaft L 23mm shaft position 45° rotation 270° probe material zinc-coated steel 250V contacts male faston 4.8mm Qty 1 pcs		
For models:	GGC1078, GGC1078B		



Part No.	390968	Ref. No.	1.06.1851713
description	thermostatcontroller t.max. 185°C temperature range°C 2-pole 1NO 16A probe ø 6mm probe L 77mm capillary pipe 1500mm capillary pipe isolated 1500mm gland nut shaft ø 6x4.6mm shaft L 25mm shaft position upper rotation 270° probe material SS		
For models:	GDF3004, GDF3008, GDF3024, GDF3028, GDF5008, GDF5028		

safety thermostats



Part No.	390970	Ref. No.	1.06.230171301
description	safety thermostat switch-off temp. 230°C 2-pole 1NC 16A probe ø 5mm probe L 48mm capillary pipe 440mm capillary pipe isolated 150mm gland nut probe 250V model WQS-230		
For models:	GDF3004, GDF3008, GDF3024, GDF3028, GDF5008, GDF5028		

refrigeration thermostats

universal with housing



Part No.	698867	Ref. No.	GPC1046-09
description	thermostat probe capillary pipe 650mm 1NO threaded type WPF17C-L2		
For models:	GPC1046		



switches and momentary switches

rocker/momentary rocker switches

30x22mm



1

Part No.	347791	Ref. No.	1.1.A.A07.10 205426 A07034 E2301GR00001 S900.01 W0308019
description	rocker switch mounting measurements 30x22mm green 2NO 230V 20A illuminated 0-I connection male faston 6.3mm ambient temperature max. 125/55°C protection IP65 with rubber collar		
For models:	GCV1600, GDS2600, GFR2700, GHM1001, GHS1600, GHS2600, GJU1001, GPS2600, GRE2700, GSA2600, GSD2600, GSF2600		

ø20mm



1

Part No.	347803	Ref. No.	DQKA0000
description	rocker switch mounting measurements 20mm red 1NO 250V 15A 0-I connection male faston 4.8mm ambient temperature max. 85°C protection IP40		
For models:	GSC1100G, GSC2336		

push/momentary push switches

30x22mm



1

Part No.	345712	Ref. No.	00000700296
description	push switch mounting measurements 30x22mm red/green 2CO 250V 16A Stop / I connection male faston 6.3mm ambient temperature max. 85°C protection IP40 with indicator		
For models:	GFS1022, GFS1025, GFS1030, GFS2019, GFS2022, GFS2025, GFS2030		
accessories for	345712		
	Part No.	301127	Ref. No.
			00000000285
	protective cover internal size 30x55mm transparent		

ø22mm



1

Part No.	301127	Ref. No.	00000000285
description	protective cover internal size 30x55mm transparent		
For models:	GFS1022, GFS1025, GFS1030, GFS2019, GFS2025, GFS2030		

accessories

push buttons



1

Part No.	348239	Ref. No.	905346
description	push button for dishwasher shaft 3.7x3.7mm blue ED ø 21mm ID ø 19mm		
For models:	GDW2001		

element holders



1

Part No.	348240	Ref. No.	905341
description	element holder ø 23.5mm ID ø 21.5mm silver		
For models:	GDW2001		

microswitches

pin-plunger actuated



1

Part No.	347799	Ref. No.	253039000003
description	microswitch with plunger 250V 15A 1CO connection male faston 4.8mm ambient temperature max. 105°C mounting distance 22mm type W-15-102C actuating force: 180g white		
For models:	GMW1025		

miscellaneous



1

Part No.	347560	Ref. No.	00000000304
description	microswitch with plunger mounting distance 22mm thread M10 thread L 14mm 250V 12A 1NO connection male faston 6.3mm stroke 3.5mm ambient temperature max. 125°C type VRSR03AA1 actuating force: 135g		
For models:	GFS1025		



with push button

switches with snap-fit



1			
Part No.	348227	Ref. No.	W0308012
description	microswitch 250V 0.5A connection male faston 2.8mm for fridge GFR2700/GRE2700		
For models:	GFR2700, GRE2700		



1			
Part No.	348192	Ref. No.	I0202070
description	microswitch with push button 250VA 1NO connection male faston 6.3mm L 26x12mm ambient temperature max. 85°C actuating force: 500g		
For models:	GRE3600, GRE3600S		

position switches

METRO



1			
Part No.	348088	Ref. No.	1.05.035011HDFMS116
description	microswitch 1NO 250V 16A L 41mm W 12mm H 44mm actuating force: 250g		
For models:	GDF3004, GDF3008, GDF3024, GDF3028, GDF5008, GDF5028		

system switches (ROLD)



1			
Part No.	301104	Ref. No.	905312
description	momentary switch unit 1NO 250V 16A connection male faston 6.3mm		
For models:	GDW2001		



1			
Part No.	348239	Ref. No.	905346
description	push button for dishwasher shaft 3.7x3.7mm blue ED ø 21mm ID ø 19mm		
For models:	GDW2001		



1			
Part No.	345651	Ref. No.	905314
description	switch 2CO 250V 16A connection male faston 6.3mm		
For models:	GDW2001		



1			
Part No.	348238	Ref. No.	905447
description	switch 2NO 250V 16A connection male faston 6.3mm type SA		
For models:	GDW2001		

cam switches

4-position

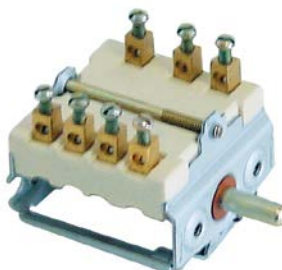

1			
Part No.	300094	Ref. No.	A01001
description	cam switch 4 operating positions 1NO/2CO sequence 0-1-2-3 16A shaft ø 6x4.6mm shaft L 15mm connection screw 4-position ceramic		
For models:	GEG2001		



4 operating positions



Part No.	347101	Ref. No.	A01017
description	cam switch 4 operating positions 1NO/1CO sequence 0-1-2-3 13A shaft \varnothing 6x4.6mm shaft L 23mm connection male faston 6.3mm plastic		
For models:	GTO1001, GTO2001		

10 operating positions



Part No.	301205	Ref. No.	01200040
description	cam switch 10 operating positions 5NO/1CO sequence 0-1-2-3-4-5-6-7-8-9 16A shaft \varnothing 6x4.6mm shaft L 23mm connection male faston 6.3mm ceramic		
For models:	GCO2001		

magnetic switches

37x16mm

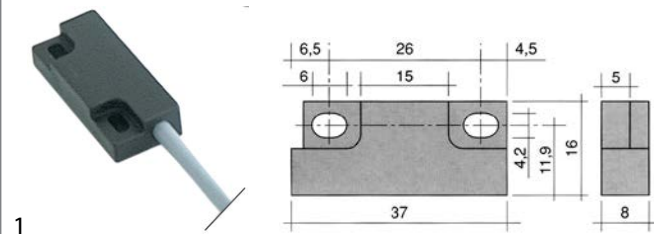

Part No.	345341	Ref. No.	909290
description	magnetic switch L 37mm W 16mm 1NO 250V 0.04A P max. 10W connection cable length 1960mm		
For models:	GDW2001		

accessories

magnets

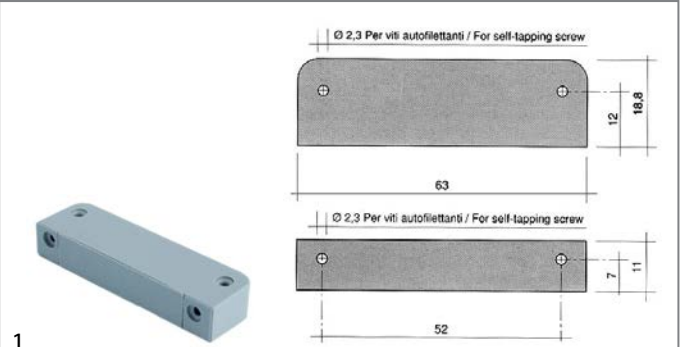

Part No.	519049	Ref. No.	903651	
description	magnet \varnothing 8mm L 63mm H 10.7mm W 18.8mm hole distance 52mm M2 hole \varnothing 2mm			
For models:	GDW2001			
accessories for	519049			
	Part No.	560095	Ref. No.	—
	sheet metal screws \varnothing 2.9mm L 9.5mm SS Qty 20 pcs DIN 7981/ISO 7049 head \varnothing 5.6mm oval head			

lamps

indicator lights

indicator lights 2-piece (lens and indicator lamp)

indicator light lenses

\varnothing 8mm (type RL-2)

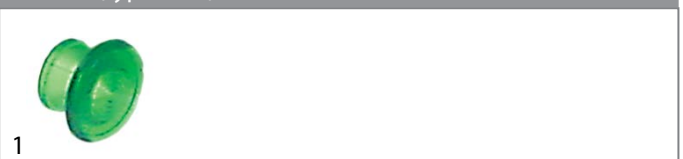





Part No.	359819	Ref. No.	00002360
description	indicator light lens green Qty 1 pcs \varnothing 8mm		
For models:	GCO2001		





Part No.	359820	Ref. No.	00002350
description	indicator light lens yellow Qty 1 pcs \varnothing 8mm		
For models:	GCO2001		



indicator lamps for socket type RL

			
1			
Part No.	359818	Ref. No.	01200330 IND30009
description	indicator light 230V clear connection male faston 6.3mm		
For models:	GCO2001, GCO500		
accessories for	359818		
	Part No.	359820	Ref. No. 00002350
	indicator light lens yellow Qty 1 pcs ø 8mm		
	Part No.	359833	Ref. No. —
	indicator light lens red Qty 1 pcs ø 8mm		
	Part No.	359948	Ref. No. —
	indicator light lens clear Qty 1 pcs ø 8mm		

			
1			
Part No.	359817	Ref. No.	01200340
description	indicator light 230V green connection male faston 6.3mm		
For models:	GCO2001		
accessories for	359817		
	Part No.	359819	Ref. No. 00002360
	indicator light lens green Qty 1 pcs ø 8mm		

indicator lights (complete)

ø 6mm

			
1			
Part No.	359005	Ref. No.	903644
description	indicator light ø 6mm 230V yellow cable length 400mm		
For models:	GDW2001		

ø 9mm

			
1			
Part No.	360766	Ref. No.	903688
description	indicator light ø 8.5mm green 250V connection male faston 6.3mm cable length 270mm temp.-resist. 120°C		
For models:	GDW2001		

			
1			
Part No.	360765	Ref. No.	903686
description	indicator light ø 8.5mm yellow 250V connection male faston 6.3mm cable length 260/400mm temp.-resist. 90°C		
For models:	GDW2001		

			
1			
Part No.	360767	Ref. No.	903685
description	indicator light ø 8.5mm yellow 250V connection male faston 6.3mm cable length 260mm temp.-resist. 120°C		
For models:	GDW2001		

ø12mm

with plug-in socket

			
1			
Part No.	359041	Ref. No.	A08009
description	indicator light ø 12mm green 230V connection male faston 6.3mm temp.-resist. 120°C Qty 1 pcs		
For models:	GEG2001		

			
1			
Part No.	359042	Ref. No.	A08003
description	indicator light ø 12mm yellow 230V connection male faston 6.3mm temp.-resist. 120°C Qty 1 pcs		
For models:	GEG2001, GTO1001, GTO2001		

ø14mm

with screw socket

			
1			
Part No.	360622	Ref. No.	1.03.00020013
description	indicator light ø 14mm green 220V connection male faston 4.8mm plastic		
For models:	GDF3004, GDF3008, GDF3024, GDF3028, GDF5008, GDF5028		

			
1			
Part No.	360621	Ref. No.	1.03.00020017
description	indicator light ø 14mm yellow 220V connection male faston 4.8mm plastic		
For models:	GDF3004, GDF3008, GDF3024, GDF3028, GDF5008, GDF5028		



LED

LED bars

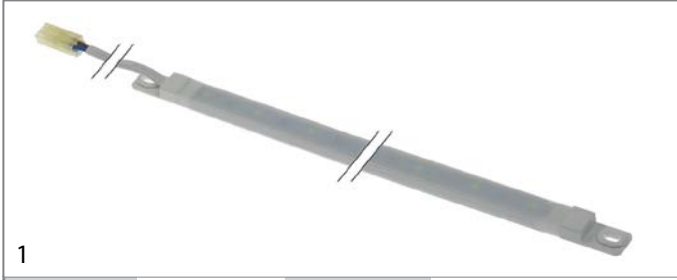

1			
Part No.	357257	Ref. No.	DQLED007
description	LED bar L 1100mm W 14.4mm H 7.5mm 24VDC white number of lamps 36 cable length 120mm		
For models:	GSC2336		

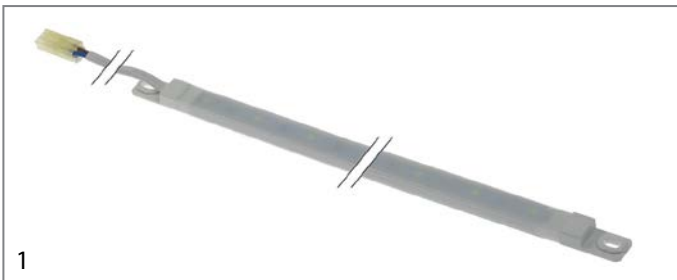

1			
Part No.	357256	Ref. No.	DQLED008
description	LED bar L 1200mm W 14.4mm H 7.5mm 24VDC white number of lamps 42 cable length 120mm		
For models:	GSC1100G		



1				
Part No.	357260	Ref. No.	W0304086 W0304511	
description	LED bar L 130mm W 14mm H 8mm cable length 300mm GFR2700/GRE2700			
For models:	GFR2700, GRE2700			
accessories for	357260			
	Part No.	692879	Ref. No.	W0409863
	cover for lamp L 185mm W 55mm H 40mm for GFR2700/GRE2700			

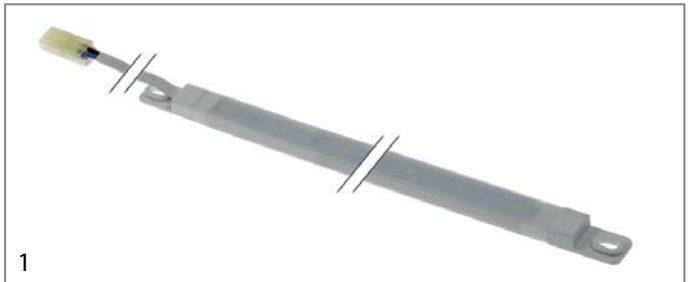

1			
Part No.	357255	Ref. No.	DQLED011
description	LED bar L 370mm W 14.4mm H 7.5mm 24VDC white number of lamps 18 cable length 380mm		
For models:	GSC2336		

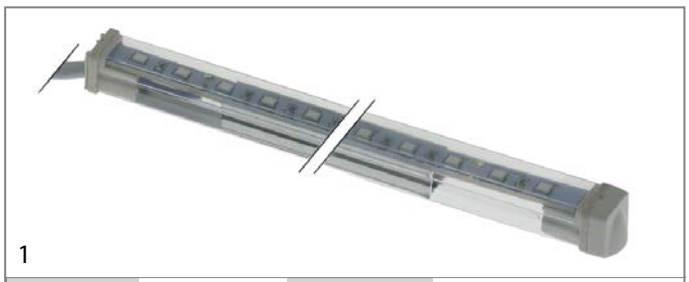

1			
Part No.	357251	Ref. No.	DQLED066
description	LED bar L 400mm W 12mm H 12mm 24V blue number of lamps 30 cable length 280mm		
For models:	GBC1102		

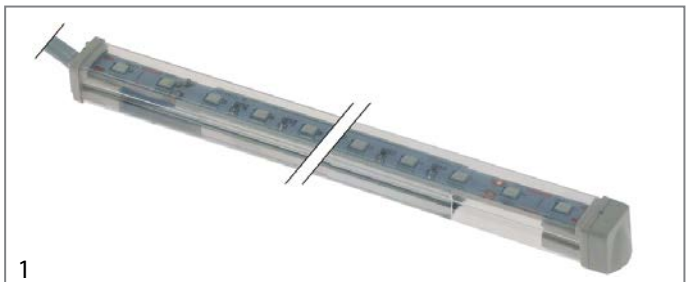

1			
Part No.	357241	Ref. No.	DQLED067
description	LED bar L 600mm W 11.5mm H 12.5mm 24V number of lamps 42 cable length 285mm voltage DC		
For models:	GBC1103		

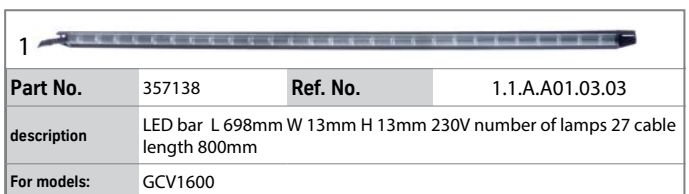

1			
Part No.	357138	Ref. No.	1.1.A.A01.03.03
description	LED bar L 698mm W 13mm H 13mm 230V number of lamps 27 cable length 800mm		
For models:	GCV1600		

accessories



1			
Part No.	357152	Ref. No.	1.1.B.B25.20
description	power supply for LEDs RT-130-2-24cm Qty 1 pcs		
For models:	GCV1600		



fluorescent lamps

fluorescent lamps

G5



Part No.	357156	Ref. No.	DQDA0009
description	fluorescent lamp socket G5 L 285mm 8W ø 16mm 230VT5/865 Qty 1 pcs		
For models:	GBC1001, GBC1001S, GBC1001SS		



Part No.	357148	Ref. No.	DQDA0010
description	fluorescent lamp socket G5 L 547mm 14W ø 16mm 230V T5/865 Qty 1 pcs		
For models:	GBC1002, GBC1002S, GBC1002SS, GBC1003, GBC1003S, GBC1003SS		

accessories

sockets



Part No.	381169	Ref. No.	SLJY2010
description	lamp holder socket G13 L 26.5mm W 24.5mm Qty 1 pcs for fluorescent lamps		



Part No.	381447	Ref. No.	SLZA3000
description	lamp socket socket G13 L 33mm W 10mm H 28mm		
For models:	GBC1001, GBC1001S, GBC1001SS, GBC1002, GBC1002S, GBC1002SS, GBC1003, GBC1003S, GBC1003SS		

starter holders



Part No.	381170	Ref. No.	SLZA1000
description	starter holder L 32mm W 24mm housing ø 23mm Qty 1 pcs		
For models:	GBC1001, GBC1001S, GBC1001SS, GBC1002, GBC1002S, GBC1002SS, GBC1003, GBC1003S, GBC1003SS		

starter



Part No.	380464	Ref. No.	DQDF0000
description	starter 4-65W		
For models:	GBC1001, GBC1001S, GBC1001SS, GBC1002, GBC1002S, GBC1002SS, GBC1003, GBC1003S, GBC1003SS		



Part No.	357150	Ref. No.	1.1.A.A01.02.01
description	starter for fluorescent lamps L 69mm W 38.5mm 11W type HG-YZ11E Qty 1 pcs		
For models:	GGC1078, GGC1078B, GGC2270, GGC2270B		

ballasts



Part No.	403192	Ref. No.	DQZB0005
description	electrical ballast 15W 220-240V connection screw clamp for fluorescent lamps type JF-1595M Qty 1 pcs		
For models:	GBC1002, GBC1002S, GBC1002SS, GBC1003, GBC1003S, GBC1003SS		



Part No.	403190	Ref. No.	DQZA0027
description	electrical ballast 30W 220-240V connection screw clamp for fluorescent lamps type JF-3095W Qty 1 pcs		



Part No.	403191	Ref. No.	DQZB0029
description	electrical ballast 9W 220V connection screw clamp for fluorescent lamps type JF-995M Qty 1 pcs		
For models:	GBC1001, GBC1001S, GBC1001SS		

covers







Part No.	699314	Ref. No.	SLZV0017
description	cover L 510mm W 30mm H 30mm		
For models:	GBC1001, GBC1001S, GBC1001SS		



			
1			
Part No.	694873	Ref. No.	SLSE2008
description	cover L 590mm W 280mm H 1mm		
For models:	GSC2336		

			
1			
Part No.	699312	Ref. No.	SLZV0018
description	cover L 810mm W 30mm H 30mm transparent		
For models:	GBC1002, GBC1002S, GBC1002SS, GBC1102		

			
1			
Part No.	694874	Ref. No.	SLZQ0037
description	cover set mounting pos. right and left W 82mm H 280mm D 34		
For models:	GSC1100G, GSC2336		
spare parts for	694874		
	Part No.	692393	Ref. No. —
	bezel for cover mounting pos. right W 82mm H 280mm D 34mm plastic Qty 1 pcs		
	Part No.	692394	Ref. No. —
	bezel for cover mounting pos. left W 82mm H 280mm D 34mm plastic Qty 1 pcs		

			
1			
Part No.	694872	Ref. No.	SLJV2040
description	cover support L 610mm W 20mm H 55mm mounting pos. lower		
For models:	GSC2336		

			
1			
Part No.	694871	Ref. No.	SLJV2041
description	cover support L 610mm W 20mm H 55mm mounting pos. upper		
For models:	GSC2336		

microwave lamps



light bulbs

			
1			
Part No.	357175	Ref. No.	253079000039
description	light bulb socket E14 230V 20W ø 25mm L 63mm Qty 1 pcs lens L 37mm		
For models:	GMW1025		

oven lamps

universal oven lamps



mounting diameter 35.5mm

			
1			
Part No.	359718	Ref. No.	00002330
description	oven lamp mounting ø 35.5mm 230V 15W socket E14 temp.-resist. 300°C connection male faston 6.3mm hard glas		
For models:	GCO2001		
spare parts for	359718		
	Part No.	359701	Ref. No. —
	lamp socket socket E14 220-230V mounting ø 35.5mm connection male faston 6.3mm 15W		
	Part No.	359740	Ref. No. —
	light bulb t.max. 300°C socket E14 15W 230V ø 22mm L 48mm lens L 20mm for oven lamp IMPORT		

			
1			
Part No.	357176	Ref. No.	LAM30006
description	oven lamp mounting ø 35.5mm 230V 40W socket G9 temp.-resist. 300°C connection cable 100mm hard glas		
For models:	GCO500		

lamp accessories

fascias

			
1			
Part No.	692879	Ref. No.	W0409863
description	cover for lamp L 185mm W 55mm H 40mm for GFR2700/GRE2700		
For models:	GFR2700, GRE2700		
accessories for	692879		
	Part No.	357260	Ref. No. W0304086 W0304511
	LED bar L 130mm W 14mm H 8mm cable length 300mm GFR2700/GRE2700		



timers

mechanical timers



1

Part No.	350130	Ref. No.	PRG30001
description	timer M11 with bell 1-pole operation time 120min impulse mechanical 1NO at 250V 16A permanent position yes shaft ø 6x4.6mm shaft L 23mm mounting distance 28mm mounting thread M4 connection male faston 6.3mm 4 hole fixing shaft flat upper		
For models:	GCO500		



1

Part No.	350186	Ref. No.	01202980
description	timer M2 2-pole operation time 120min impulse mechanical 2CO at 250V 16A permanent position yes shaft ø 6x4.6mm shaft L 23mm mounting distance 28mm		
For models:	GCO2001		
accessories for	350186		
	Part No.	112627	Ref. No. —
	knob time 120min ø 58mm shaft ø 6x4.6mm shaft flat lower		



1

Part No.	360164	Ref. No.	A02008
description	timer MT49 2-pole operation time 15min impulse mechanical 2NO at 250V 16A permanent position yes shaft 6x4.6mm shaft L 16mm mounting distance 28mm connection lateral		
For models:	GTO1001, GTO2001		

defrost timers

miscellaneous



1

Part No.	360553	Ref. No.	1.1.A.A05.06
description	defrost timer SONXIE type DBZF-625-2G2B defrosting interval 6h defrosting time 2minmin fan delaymin 200-240V Qty 1 pcs		
For models:	GGC1078, GGC1078B		

alarm devices

buzzer boards



1

Part No.	401062	Ref. No.	01201250
description	buzzer board 230VAC L 48mm W 45mm connection Faston 6.3mm		
For models:	GCO2001		

contactors

LOVATO

power contactors



1

Part No.	380705	Ref. No.	907190
description	power contactor resistive load 20A 230VAC (AC3/400V) 9A/4kW main contacts 3NO auxiliary contacts 1NO connection screw connection type 11BG0910A230		
For models:	GDW2001		
accessories for	380705		
	Part No.	380057	Ref. No. —
	auxiliary contact contacts 1NO/1NC AC1 10A for contactors BG series connection screw type BGX1011		

solid state relays

accessories

diodes

high voltage diodes



1

Part No.	403261	Ref. No.	253089000101
description	hv diode type RG501 connection F6.3mm / lug M4 cable lengthmm for microwave Qty 1 pcs		
For models:	GMW1025		

relays

power relays

with bracket mounting



1

Part No.	380867	Ref. No.	DQWBZJ02
description	relay SHANGFANG 12VDC 30A 1NO connection male faston 6.3mm screw mounting at 250V 30A manuf. no. 855AW-1A-C1		
For models:	GSC1100G, GSC2336		

magnetrons



1

Part No.	403173	Ref. No.	253017000051
description	Magnetron type 2M248J(JT)		
For models:	GMW1025		

transformers

power supplies



1

Part No.	403903	Ref. No.	W0399114
description	power supply primary 100-240VAC secondary 24VDC H 30mm L 85mm W 45mm 50/60Hz type JKY36-SP2400600		
For models:	GFR2700		



1

Part No.	403902	Ref. No.	W0399115
description	power supply primary 100-240VAC secondary 24VDC H 34mm L 114mm W 45mm 50/60Hz type JKY36-SP2401500 GRE2700		
For models:	GRE2700		

HV transformers



1

Part No.	403257	Ref. No.	253029000256
description	HV transformer primary 230-240V 50Hz type GAL-1000E-1G for microwave		
For models:	GMW1025		

miscellaneous



1

Part No.	403660	Ref. No.	DQLED069
description	transformer primary 100-240V secondary 24VDC 20VA secondary 0.84A		
For models:	GBC1001, GBC1001S, GBC1002, GBC1002S, GBC1003, GBC1003S, GBC1102, GBC1103		



1

Part No.	403867	Ref. No.	DQLED055
description	transformer primary 100-240V secondary 24VDC secondary 0.42A H 25mm L 95mm W 40mm		
For models:	GSC1100G, GSC2336		



electronic controllers

DIXELL

refrigeration controllers

built-in version



1

Part No.	378256	Ref. No.	S900.02
description	electronic controller DIXELL XR02CX-5N0C0 mounting measurements 71x29mm built-in depth 56mm 230V voltage AC NTC relay outputs 1 CO-8A(4) NTC protection IP54 defrosting function/time control -40 up to +110°C display 2½ digit		
For models:	GHS1600, GHS2600		
spare parts for	378256		
	Part No.	379161	Ref. No. —
	temperature probe NTC 10kOhm cable thermoplastic probe -40 up to +110°C cable -40 up to +110°C probe ø6x14mm cable length 3m without screw connection 2-wire		
accessories for	378256		
	Part No.	378194	Ref. No. —
	temperature probe NTC 10kOhm cable PVC probe -20 up to +80°C cable -10 up to 100°C probe ø7x24.5mm cable length 1.5m without screw connection 2-wire		
	Part No.	379057	Ref. No. —
	temperature probe NTC 10kOhm cable PVC probe -20 up to +80°C cable -10 up to 100°C probe ø6x25mm cable length 3m 2-wire		
	Part No.	379160	Ref. No. E21010150001
	temperature probe NTC 10kOhm cable thermoplastic probe -40 up to +110°C cable -40 up to +110°C probe ø6x14mm cable length 1.5m without screw connection 2-wire		
	Part No.	379161	Ref. No. —
	temperature probe NTC 10kOhm cable thermoplastic probe -40 up to +110°C cable -40 up to +110°C probe ø6x14mm cable length 3m without screw connection 2-wire		
	Part No.	379343	Ref. No. —
	temperature probe NTC 10kOhm cable silicone probe -40 up to +110°C cable -50 up to +180°C probe ø6x40mm cable length 3m 2-wire		
	Part No.	379458	Ref. No. —
	temperature probe NTC 10kOhm cable silicone probe -40 up to +110°C cable -50 up to +180°C probe ø6x40mm cable length 1.5m without screw connection 2-wire		



1

Part No.	378267	Ref. No.	E20A111C4D00
description	electronic controller DIXELL XR02CX-5N0C1 mounting measurements 71x29mm built-in depth 56mm 230V voltage AC NTC relay outputs 1 NO-20A(8) NTC DI protection IP54 defrosting function/time control -40 up to +110°C display 2½ digit		
For models:	GDS2600, GPS2600, GSA2600, GSD2600, GSF2600		
accessories for	378267		
	Part No.	379161	Ref. No. —
	temperature probe NTC 10kOhm cable thermoplastic probe -40 up to +110°C cable -40 up to +110°C probe ø6x14mm cable length 3m without screw connection 2-wire		
	Part No.	381249	Ref. No. —
	temperature probe NTC 10kOhm cable PVC probe -40 up to +110°C cable -10 up to 100°C connection 2-wire thread probe ø6x14mm cable length 3m		



1

Part No.	378665	Ref. No.	W0302160
description	electronic controller DIXELL XR03CX-5R0C1 mounting measurements 71x29mm built-in depth 50mm 230V voltage AC NTC relay outputs 2 NO-20A(8) CO-8A(3) NTC DI protection IP65 defrosting function/time control -55 up to +99°C display 2 digit		
For models:	GRE2700		



1

Part No.	378363	Ref. No.	W0302159
description	electronic controller DIXELL XR06CX-5R0C1 mounting measurements 71x29mm 230V voltage AC NTC relay outputs 3 NO-20A(8) CO-8A(3) NO-5A(2) NTC NTC DI protection IP54 -40 up to +110°C display 3½ digits		
For models:	GFR2700		
accessories for	378363		
	Part No.	381249	Ref. No. —
	temperature probe NTC 10kOhm cable PVC probe -40 up to +110°C cable -10 up to 100°C connection 2-wire thread probe ø6x14mm cable length 3m		



1

Part No.	379843 ¹	Ref. No.	1.1.A.A06.03.31
description	electronic controller kit DIXELL XR30CX-5N2C1 mounting measurements 71x29mm 230V voltage AC NTC/PTC relay outputs 2 1x NTC probe inclusive -50 up to +150°C display 3½ digits 2 RoomTempLN NTC/PTC DEF Probe DigilN1 DigilN2 DEF Relay fan relay Temp4/Dig1 NTC/PTC/DIGI evaporator probe defr. funct. compressor relay NO-20A(8) light relay alarm relay CO-8A(3) auxiliary relay		
For models:	GCV1600		
spare parts for	379843		
	Part No.	Ref. No.	E21010150001
	temperature probe NTC 10kOhm cable thermoplastic probe -40 up to +110°C cable -40 up to +110°C probe ø6x14mm cable length 1.5m without screw connection 2-wire		

¹incl. 1x NTC probe







SHANGFANG

refrigeration controllers



built-in version



1

Part No.	379799 ¹	Ref. No.	DQWBZX02
description	electronic controller SHANGFANG type SF-104S-2 mounting measurements 71x29mm 12V voltage AC NTC relay outputs 2 12VDC 12VDC NTC front measurements 77x35mm built-in depth 40mm protection IP54 accuracy 1% built-in version alarm without accessories defr. funct. yes -45 up to +45°C display 3 digits		
For models:	GSC1100G, GSC2336		
spare parts for	379799		
	Part No.	Ref. No.	—
	transformer primary 230VAC secondary 12VAC 3VA secondary 0.25A H 40mm L 45mm W 50mm connection screw 50/60Hz type 153/M		
	Part No.	Ref. No.	DQWBZJ02
	relay SHANGFANG 12VDC 30A 1NO connection male faston 6.3mm screw mounting at 250V 30A manuf. no. 855AW-1A-C1		
	Part No.	Ref. No.	—
	temperature probe NTC cable silicone cable colours white cable length 3m probe -40 up to +110°C cable -50 up to +180°C probe ø7x25mm coded plug		
	Part No.	Ref. No.	—
	temperature probe NTC cable silicone cable colours black cable length 3m evaporator probe -40 up to +110°C cable -50 up to +180°C probe ø7x25mm coded plug		
accessories for	379799		
	Part No.	Ref. No.	—
	transformer primary 230VAC secondary 12VAC 3VA secondary 0.25A H 40mm L 45mm W 50mm connection screw 50/60Hz type 153/M		
	Part No.	Ref. No.	DQWBZJ02
	relay SHANGFANG 12VDC 30A 1NO connection male faston 6.3mm screw mounting at 250V 30A manuf. no. 855AW-1A-C1		

¹without relay, cable harness, probe and transformer

accessories for	379799		
	Part No.	Ref. No.	—
	temperature probe NTC cable silicone cable colours white cable length 3m probe -40 up to +110°C cable -50 up to +180°C probe ø7x25mm coded plug		
	Part No.	Ref. No.	—
	temperature probe NTC cable silicone cable colours black cable length 3m evaporator probe -40 up to +110°C cable -50 up to +180°C probe ø7x25mm coded plug		

built-in version 2-piece



1

Part No.	379849 ¹	Ref. No.	DQWB005
description	electronic controller SHANGFANG type SF-101S mounting measurements 71x29mm 230V voltage AC NTC relay outputs 1 NO-30A NTC Comp front measurements 77x35mm built-in depth 40mm protection IP54 accuracy 1% built-in version alarm incl. relay, cable harness, probe and transformer defr. funct. yes -45 up to +45°C display 3 digits		
For models:	GBC1001, GBC1001S, GBC1001SS, GBC1002, GBC1002S, GBC1002SS, GBC1003, GBC1003S, GBC1003SS		
spare parts for	379849		
	Part No.	Ref. No.	—
	transformer primary 230VAC secondary 12VAC 3VA secondary 0.25A H 40mm L 45mm W 50mm connection screw 50/60Hz type 153/M		
	Part No.	Ref. No.	DQWBZJ02
	relay SHANGFANG 12VDC 30A 1NO connection male faston 6.3mm screw mounting at 250V 30A manuf. no. 855AW-1A-C1		
	Part No.	Ref. No.	—
	temperature probe NTC cable silicone cable colours white cable length 3m probe -40 up to +110°C cable -50 up to +180°C probe ø7x25mm coded plug		
	Part No.	Ref. No.	—
	temperature probe NTC cable silicone cable colours black cable length 3m evaporator probe -40 up to +110°C cable -50 up to +180°C probe ø7x25mm coded plug		
accessories for	379849		
	Part No.	Ref. No.	—
	transformer primary 230VAC secondary 12VAC 3VA secondary 0.25A H 40mm L 45mm W 50mm connection screw 50/60Hz type 153/M		
	Part No.	Ref. No.	DQWBZJ02
	relay SHANGFANG 12VDC 30A 1NO connection male faston 6.3mm screw mounting at 250V 30A manuf. no. 855AW-1A-C1		
	Part No.	Ref. No.	—
	temperature probe NTC cable silicone cable colours white cable length 3m probe -40 up to +110°C cable -50 up to +180°C probe ø7x25mm coded plug		
	Part No.	Ref. No.	—
	temperature probe NTC cable silicone cable colours black cable length 3m evaporator probe -40 up to +110°C cable -50 up to +180°C probe ø7x25mm coded plug		

¹incl. relay, cable harness, probe and transformer



<p>71 x 29mm</p>			
1			
Part No.	403074 ¹	Ref. No.	DQWB0002
description	electronic controller SHANGFANG type SF-104S-2 mounting measurements 71x29mm 230V voltage AC NTC relay outputs 2 NO-30A NO-30A NTC NTC front measurements 77x35mm built-in depth 38mm protection IP54 accuracy 1% built-in version alarm incl. relay, cable harness, probe and transformer defr. funct. yes -45 up to +45°C display 2½ digit		
For models:	GBC1001, GBC1001S, GBC1002, GBC1002S, GBC1003, GBC1003S, GBC1102, GBC1103, GSC1100G, GSC2336		
spare parts for	403074		
	Part No.	379054	Ref. No. —
	transformer primary 230VAC secondary 12VAC 3VA secondary 0.25A H 40mm L 45mm W 50mm connection screw 50/60Hz type 153/M		
	Part No.	380867	Ref. No. DQWBZJ02
	relay SHANGFANG 12VDC 30A 1NO connection male faston 6.3mm screw mounting at 250V 30A manuf. no. 855AW-1A-C1		
	Part No.	381318	Ref. No. —
	temperature probe NTC cable silicone cable colours white cable length 3m probe -40 up to +110°C cable -50 up to +180°C probe ø7x25mm coded plug		
	Part No.	381319	Ref. No. —
	temperature probe NTC cable silicone cable colours black cable length 3m evaporator probe -40 up to +110°C cable -50 up to +180°C probe ø7x25mm coded plug		
accessories for	403074		
	Part No.	379054	Ref. No. —
	transformer primary 230VAC secondary 12VAC 3VA secondary 0.25A H 40mm L 45mm W 50mm connection screw 50/60Hz type 153/M		
	Part No.	380867	Ref. No. DQWBZJ02
	relay SHANGFANG 12VDC 30A 1NO connection male faston 6.3mm screw mounting at 250V 30A manuf. no. 855AW-1A-C1		
	Part No.	381318	Ref. No. —
	temperature probe NTC cable silicone cable colours white cable length 3m probe -40 up to +110°C cable -50 up to +180°C probe ø7x25mm coded plug		
	Part No.	381319	Ref. No. —
	temperature probe NTC cable silicone cable colours black cable length 3m evaporator probe -40 up to +110°C cable -50 up to +180°C probe ø7x25mm coded plug		

¹incl. relay, cable harness, probe and transformer

accessories

1			
Part No.	380867	Ref. No.	DQWBZJ02
description	relay SHANGFANG 12VDC 30A 1NO connection male faston 6.3mm screw mounting at 250V 30A manuf. no. 855AW-1A-C1		
For models:	GSC1100G, GSC2336		

accessories universal for electronic con-

miscellaneous

1			
Part No.	692369	Ref. No.	1.1.C.C63.71
description	bracket for thermometer W 81mm H 41mm plastic Qty 1 pcs		
For models:	GCV1600		

probes

universal probes

temperature probes

1			
Part No.	379160	Ref. No.	E21010150001
description	temperature probe NTC 10kOhm cable thermoplastic probe -40 up to +110°C cable -40 up to +110°C probe ø6x14mm cable length 1.5m without screw connection 2-wire		
For models:	GDS2600, GPS2600, GSA2600, GSD2600, GSF2600		

producer-specific probes

probes

1			
Part No.	403899	Ref. No.	W0302305
description	probe NTC 10kOhm cable PVC probe -40 up to +110°C cable -40 up to +110°C connection coded plug thread probe ø6x14mm cable length 600m GFR2700/GRE2700		
For models:	GFR2700		

1			
Part No.	403901	Ref. No.	W0302304
description	probe NTC 10kOhm cable PVC probe -40 up to +110°C cable -40 up to +110°C connection coded plug thread probe ø6x14mm cable length 800m GFR2700/GRE2700		
For models:	GFR2700, GRE2700		



1 

Part No.	403910	Ref. No.	I0205805
description	temperature probe NTC 10kOhm cable PVC probe -40 up to +110°C connection 2-wire probe 5x20 cable length 1.475m		
For models:	GFR3600S, GRE3600, GRE3600S		

sensors

1 

Part No.	403155	Ref. No.	AD400009
description	sensor for induction device ø 25mm H 17mm cable length 130mm		
For models:	GIC3035		

electronics

PCBs

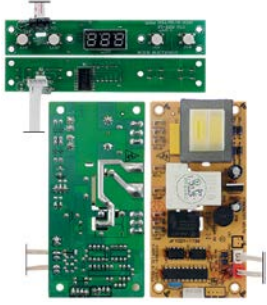
1 

Part No.	361873	Ref. No.	1.1.A.A17.01.01 1.1.A.A17.04.06
description	control PCB refrigerated show case GGC 1270/2270 cable length 225mm 2-piece type KB3150		
For models:	GGC2270, GGC2270B		

1 

Part No.	403954	Ref. No.	I9R00462
description	control PCB refrigeration IARP L 222mm W 40mm		
For models:	GFR3600S		



1 

Part No.	403736	Ref. No.	43845000
description	control PCB refrigeration IARP L 222mm W 40mm for fridge		
For models:	GRE3600, GRE3600S		

1 

Part No.	403529	Ref. No.	263019008956
description	display PCB microwave GMW1025 L 160mm W 85mm cable length 200mm for microwave		
For models:	GMW1025		

1 

Part No.	403154	Ref. No.	DQA020110R
description	keypad PCB induction device GIC3035 L 247mm W 53mm keypad connection 4 contact pins edition since 2012 buttons 8		
For models:	GIC3035		
accessories for	403154		
	Part No.	403156	Ref. No. LAC5000003
	control panel induction device GIC3535 W 300mm H 58mm		
	Part No.	403160	Ref. No. —
	control panel induction device GIC3535 W 300mm mounting pos. right H 58mm		

1 

Part No.	403188	Ref. No.	263029001088
description	line filter microwave for GMW1025 250V 50/60Hz conductor 2 PCB connection male faston 4.8mm L 80mm H 20mm W 40mm PCB Qty 1 pcs cable length 120mm type DNV-0818A-5		
For models:	GMW1025		

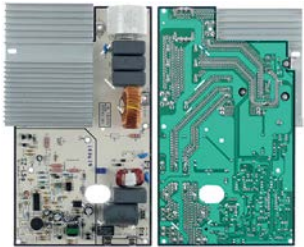
1 

Part No.	403153	Ref. No.	DQA010095R
description	main PCB induction device GIC3035 L 267mm W 160mm connection male faston 6.3mm vertical keypad connection 4 contact pins SZ-L5		
For models:	GIC3035		
accessories for	403153		
	Part No.	403154	Ref. No. DQA020110R
	keypad PCB induction device GIC3035 L 247mm W 53mm keypad connection 4 contact pins edition since 2012 buttons 8		

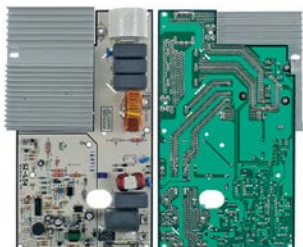



1

Part No.	403680	Ref. No.	DQA010198R
description	main PCB induction device GIC3035 L 267mm W 160mm connection screw keypad connection 4 contact pins SZ-L5a		
For models:	GIC3035		



1

Part No.	403165	Ref. No.	2852
description	PCB GSM1000 speed control		
For models:	GSM1000		
spare parts for	403165		
	Part No.	696506	Ref. No.
			2858
	knob for PCB ø 26mm black Qty 1 pcs		

central units



1

Part No.	400788	Ref. No.	0000000297
description	control box for slicer 230V		
For models:	GFS1022, GFS1025, GFS1030, GFS2022, GFS2025		



1

Part No.	403682	Ref. No.	00000001752
description	control box for slicer 230V 50Hz edition since 04/2016		
For models:	GFS2019, GFS2030		



1

Part No.	401855	Ref. No.	00000009240
description	control box with pressure switch double for slicer 230V		
For models:	GFS1030		

keypads

front foils



1

Part No.	403156	Ref. No.	LAC5000003
description	control panel induction device GIC3535 W 300mm H 58mm		
For models:	GIC3035		
accessories for	403156		
	Part No.	403154	Ref. No.
			DQA020110R
	keypad PCB induction device GIC3035 L 247mm W 53mm keypad connection 4 contact pins edition since 2012 buttons 8		



1

Part No.	403764	Ref. No.	49357000
description	front foil blast freezer L 165mm W 45mm		
For models:	GFR3600S, GRE3600, GRE3600S		

membrane keypads



1

Part No.	403187	Ref. No.	253069002692
description	membrane keypad microwave GMW1025 2-piece buttons 15 Qty 1 pcs L 164mm W 70mm		
For models:	GMW1025		

control panel



1

Part No.	506281	Ref. No.	909763
description	control panel for dishwasher L 250mm W 40mm black suitable for Silanos		
For models:	GDW2001		





















solenoid valves

solenoid valves (water)

TP



Part No.	370017	Ref. No.	902390
description	solenoid valve single straight 230VAC inlet 3/4" outlet 11.5mm DN10 TP p max 10bar		
For models:	GDW2001		
spare parts for	370017		
	Part No.	371013	Ref. No. —
	solenoid coil TP 230VAC 50/60Hz		
accessories for	370017		
	Part No.	371220	Ref. No. —
	reducer TP flow rate 3l/min red tolerance ±15%		
	Part No.	371221	Ref. No. —
	reducer TP flow rate 5.5l/min yellow tolerance ±15%		
	Part No.	371222	Ref. No. —
	reducer TP flow rate 6l/min grey tolerance ±15%		
	Part No.	371223	Ref. No. —
	reducer TP flow rate 10l/min white tolerance ±15%		
	Part No.	371224	Ref. No. —
	reducer TP flow rate 12l/min bronze tolerance ±15%		
	Part No.	371225	Ref. No. —
	reducer TP flow rate 16l/min light brown tolerance ±15%		
	Part No.	371226	Ref. No. —
	reducer TP flow rate 20l/min red tolerance ±15%		
	Part No.	371230	Ref. No. —
	reducer TP flow rate 0.25l/min red tolerance ±25%		
	Part No.	371231	Ref. No. —
	reducer TP flow rate 0.35l/min violet tolerance ±25%		
	Part No.	371232	Ref. No. —
	reducer TP flow rate 0.5l/min orange tolerance ±25%		
	Part No.	371233	Ref. No. —
	reducer TP flow rate 0.8l/min white tolerance ±25%		
	Part No.	371234	Ref. No. —
	reducer TP flow rate 1l/min light blue tolerance ±25%		
	Part No.	371235	Ref. No. —
	reducer TP flow rate 1.2l/min brown tolerance ±25%		

accessories for	370017		
	Part No.	371236	Ref. No. —
	reducer TP flow rate 1.5l/min light brown tolerance ±25%		
	Part No.	371237	Ref. No. —
	reducer TP flow rate 2.5l/min yellow tolerance ±25%		
	Part No.	371238	Ref. No. —
	reducer TP flow rate 3.4l/min dark green tolerance ±25%		
	Part No.	371239	Ref. No. —
	reducer TP flow rate 5l/min black tolerance ±25%		
	Part No.	371240	Ref. No. —
	reducer TP flow rate 8l/min blue tolerance ±20%		

solenoid valves (refrigeration)

SANHUA

valves



Part No.	374110	Ref. No.	W0205011
description	solenoid valve type FDF2AT connection 6mm soldering connection L 143mm pipe connection ø 6mm 220-240V		
For models:	GFR2700		
accessories for	374110		
	Part No.	696787	Ref. No. W0208009
	T-piece copper ID ø 4.5mm ED ø 6mm refrigeration for GFR2700		

pressure switches

for warewashing

ø 58mm with male faston 6.3mm

with connection horizontal



Part No.	541001	Ref. No.	905264
description	pressure control pressure range 35/17mbar connection 6mm ø 58mm pressure connection horizontal warewashing		
For models:	GDW2001		



compressors

ACC/ZEL

R600A

LBP monophase

Lower evaporation temperature below -20°C



1

Part No.	605141	Ref. No.	DQYD0015 E27B6F1Z0001
description	compressor coolant R600a type HPY12AAa 220-240V 50Hz LBP 8.8kg 1/5HP cylinder capacity 12cm ³ RSIR H 200mmWWWWWWWWWW		
For models:	GBC1002, GBC1002S, GBC1002SS, GBC1003, GBC1003S, GBC1003SS, GBC1102, GDS2600, GPS2600, GSA2600, GSC2336, GSD2600, GSF2600		



1

Part No.	605150	Ref. No.	1.1.A.A02.01
description	compressor coolant R600a type HVM10AA 220-240V 50Hz LBP 8.7kg 1/6HP cylinder capacity 10cm ³ RSIR H 180mmWWWWWWWWWW		
For models:	GCV1600		



1

Part No.	650150	Ref. No.	VRX1560.01
description	compressor coolant R600a type HVM67AA 220-240V 50Hz LBP 7.5kg 1/8HP cylinder capacity 7cm ³ RSIR H 180mmWWWW		
For models:	GHS1600, GHS2600		



1

Part No.	605142	Ref. No.	1.1.A.A02.04 DQYD0014
description	compressor coolant R600a type HVM86AA 220-240V 50Hz LBP fully hermetic 7.83kg 1/7HP cylinder capacity 8.6cm ³ RSIR H 174mmWWWW		
For models:	GBC1001, GBC1001S, GBC1001SS, GGC1078, GGC1078B		

EMBRACO / ASPERA

R290A

LBP monophase

Lower evaporation temperature below -20°C



1

Part No.	605258	Ref. No.	I0210981 W0201133
description	compressor coolant R290 type EMTE2134U 220-240V 50Hz LBP 9kg 3/8HP cylinder capacity 9.5cm ³ CSIR H 187mm 250W 278W 305W 330W 366WWWWWW		
For models:	GFR2700, GFR3600S		



R600A

LBP monophase

Lower evaporation temperature below -20°C



Part No.	605281	Ref. No.	W0201151
description	compressor coolant R600a type EMB40CLC 220-240V 50Hz LBP 8kg 1HP cylinder capacity 7.24cm ³ H 160mmWWWWW		
For models:	GRE2700		



Part No.	605257	Ref. No.	45004031
description	compressor coolant R600a type EMD46CLT 220-240V 50Hz LBP 7.5kgHP cylinder capacity 7.96cm ³ RSCR H 210mm 88W 118W 154W 196W 246WWWWW		
For models:	GRE3600, GRE3600S		

miscellaneous

R134A



Part No.	605140	Ref. No.	DQYA0087
description	compressor KONOR type GQR90AA coolant R134a 220-240V 50Hz 10.1kg 1/4HP cylinder capacity 9.1cm ³ RSIR H 186mmWWWWW		

R600A



Part No.	605143	Ref. No.	1.1.A.A02.25
description	compressor DONPER type QD167YU coolant R600a 220-240V 50Hz fully hermetic 11.9kg 3/8HP cylinder capacity 16.7cm ³ RSCR H 220mm 169W 199W 236W 280W 334W 391WWWWW test method ASHRAE capacitor 6µF		
For models:	GGC2270, GGC2270B		

accessories

miscellaneous



Part No.	699425	Ref. No.	1.1.C.C41.01
description	vibration damper ø 25mm H 10mm		
For models:	GGC1078, GGC1078B		

fans

axial fans

import



Part No.	601131 ¹	Ref. No.	I0221151
description	axial fan L 119mm W 119mm H 25mm 230VAC 50/60Hz 19/18W bearing ball bearing connection male faston 2.8mm metal ADDA fan wheel ø 110mm temp.-resist. 70°C		
For models:	GFR3600S, GRE3600, GRE3600S		
accessories for	601131		
Part No.	550898	Ref. No.	I0221181
description	connecting cable cable length 2000mm connection F 2.8 connection distance 7.9mm for axial flow fan		

¹with ball bearings



1

Part No.	601909 ¹	Ref. No.	45003031
description	axial fan L 119mm W 119mm H 38mm 220-240 50/60Hz 31/29W bearing ball bearing connection male faston 2.8mm		
For models:	GFR3600S, GRE3600, GRE3600S		

¹with ball bearings



1

Part No.	601834 ¹	Ref. No.	1.1.A.A03.01.31
description	axial fan L 119mm W 119mm H 38mm 230VAC 50/60Hz 16/15W bearing ball bearing manuf. no. RAM1238B1 connection cable length 900mm XINRUILIAN fan wheel ø 110mm temp.-resist. -10 up to +70°C input current 0.16A		
For models:	GCV1600		

¹with ball bearings



1

Part No.	601604 ¹	Ref. No.	E17A1A010100 S900.34
description	axial fan L 119mm W 119mm H 38mm 230VAC 50/60Hz 17/15W bearing slide bearing manuf. no. AA1282HS-AT connection cable 300mm fan wheel ø 110mm temp.-resist. 70°C input current 0.1A airflow 130m ³ /h 2600rpm		
For models:	GDS2600, GHS1600, GHS2600, GPS2600, GSA2600, GSD2600, GSF2600		

¹with slide bearings



1

Part No.	601787 ¹	Ref. No.	DQFA1000 DQFD1000 DQFD1001
description	axial fan L 119mm W 119mm H 38mm 230VAC 50/60Hz 22/38.4W bearing slide bearing manuf. no. HT-A12038S220 connection plug cable length 300mm HUI TONG fan wheel ø 110mm input current 0.1/0.16A housing aluminium		
For models:	GBC1001, GBC1001S, GBC1001SS, GSC1100G, GSC2336		

¹with slide bearings



1

Part No.	602136	Ref. No.	DQFD2003
description	axial fan L 119mm W 119mm H 38mm 230VAC 50/60Hz 22/38.4W bearing slide bearing manuf. no. HT-A12038S220 connection with cable 500mm cable length 300mm HUI TONG fan wheel ø 110mm input current 0.1/0.16A housing aluminium		
For models:	GBC1001, GBC1001S, GBC1001SS, GBC1002, GBC1002S, GBC1002SS, GBC1003, GBC1003S, GBC1003SS, GBC1102, GBC1103		

accessories

fan guards





1

Part No.	691104	Ref. No.	I0427017 WJFZ0007
description	guard ø 115mm mounting distance 105mm for axial fan 119mm		
For models:	GBC1001, GBC1001S, GBC1001SS, GBC1002, GBC1002S, GBC1002SS, GBC1003, GBC1003S, GBC1003SS, GBC1102, GBC1103, GRE3600, GRE3600S, GSC2336		

**connecting cables**

1			
Part No.	550898	Ref. No.	I0221181
description	connecting cable cable length 2000mm connection F 2.8 connection distance 7.9mm for axial flow fan		
For models:	GRE3600, GRE3600S		

refrigeration fans**refrigeration motors universal****ebm-papst****miscellaneous**

1			
Part No.	601783	Ref. No.	E17A1A050500
description	fan motor 10W 230V 50/60Hz L3 87mm W 67mm cable length 400mm 1300rpm ebm-papst M4Q045-CA03-51/C18 3 mounting options bearing slide bearing for refrigerated counters		
For models:	GDS2600, GPS2600, GSA2600, GSD2600, GSF2600		
spare parts for	601783		
	Part No.	601413	Ref. No. —
	fixing plate suitable for fanwheel ED ø 32mm shaft ø 7 mounting distance 26mm		
accessories for	601783		
	Part No.	601385	Ref. No. E181A1723401
	fan wheel sucking ø 172mm fan wheel mounting 25.4mm blade angle 34° W 42mm aluminium		

IMPORT**multi fit fan motors WEIGUANG**

1			
Part No.	601020	Ref. No.	W0301906 W0301911
description	fan motor 5W 230V 50-60Hz L1 44mm L2 48mm L3 79mm W 84mm cable length 500mm 1300rpm YZF5-13-18/26 5 mounting options bearing slide bearing		
For models:	GFR2700, GRE2700		

miscellaneous

1			
Part No.	601789	Ref. No.	1.1.A.A03.01.10
description	fan motor 10W 220-240V 50/60Hz L1 83mm L2 92mm W 84mm cable length 1000mm 1300/1550rpm WEIGUANG YZF10-20		
For models:	GGC2270, GGC2270B		
spare parts for	601789		
	Part No.	601413	Ref. No. —
	fixing plate suitable for fanwheel ED ø 32mm shaft ø 7 mounting distance 26mm		

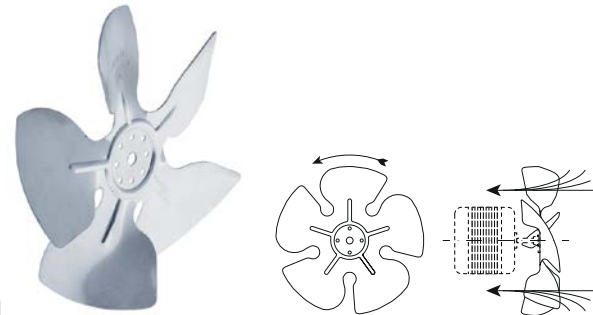
accessories**fan wheels****aluminium**

1			
Part No.	601553	Ref. No.	W0301078
description	fan wheel sucking ø 172mm fan wheel mounting 25.4mm blade angle 28° W 35mm aluminium		
For models:	GFR2700, GRE2700		

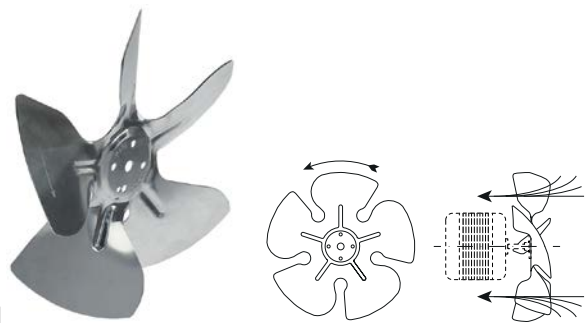

1			
Part No.	601385	Ref. No.	E181A1723401
description	fan wheel sucking ø 172mm fan wheel mounting 25.4mm blade angle 34° W 42mm aluminium		
For models:	GDS2600, GPS2600, GSA2600, GSD2600, GSF2600		



1

Part No.	601070	Ref. No.	1.1.A.A03.03.05 W0301060
description	fan wheel sucking ø 200mm fan wheel mounting 25.4mm blade angle 28° W 38mm aluminium		
For models:	GFR2700, GGC2270, GGC2270B, GRE2700		

fan guards

1

Part No.	602101	Ref. No.	E192A1200300 E192A1723800
description	guard ø 210mm H 35mm mounting distance 1 230mm mounting distance 2 100mm		
For models:	GDS2600, GPS2600, GSA2600, GSD2600, GSF2600		

1

Part No.	699432	Ref. No.	1.1.B.B10.36
description	guard ø 215mm mounting distance 230mm		
For models:	GGC2270, GGC2270B		

cooling motors (complete)

1

Part No.	602174	Ref. No.	W0301913
description	fan 220-240V 7W 50/60Hz fan wheel ø 170mm connection cable 350mm 1300rpm GFR2700/GRE2700		
For models:	GFR2700, GRE2700		
accessories for	602174		
	Part No.	Ref. No.	80021501
	bracket for fan for evaporator L 130mm W 80mm hole distance 63mm for GFR2700/GRE2700		

1

Part No.	601836	Ref. No.	DQJB2004
description	fan 220V 25/3W 50/60Hz fan wheel ø 172mm L 82mm W 82mm connection spate terminal M4 cable length 1000mm		
For models:	GBC1002, GBC1002S, GBC1002SS, GBC1003, GBC1003S, GBC1003SS, GBC1102, GBC1103		

1

Part No.	601835	Ref. No.	DQJB2013
description	fan 220V 35/5W 50/60Hz L 82mm W 82mm connection spate terminal M4 cable length 1100mm		
spare parts for	601835		
	Part No.	Ref. No.	—
	fixing plate suitable for fanwheel ED ø 33mm shaft ø 6 mounting distance 17mm		



1

Part No.	601791	Ref. No.	1.1.A.A03.02.04
description	fan motor pair 220-240V 10W 50Hz fan wheel ø 110mm mounting distance 137mm cable length 800mm		
For models:	GGC2270, GGC2270B		

cold air circulating fans

cold air circulating fans

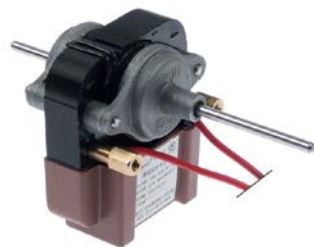

1

Part No.	601845	Ref. No.	1.1.A.A03.01.08
description	fan motor 220-240V 50Hz IN 22W / OUT 5W shaft ø 4mm shaft L 20/48mm L 65mm W 66mm H 73mm Qty 1 pcs		
For models:	GGC1078, GGC1078B		
accessories for	601845		
	Part No.	601846	Ref. No. 1.1.C.C17.04
	fan wheel blowing ø 150mm shaft intake ø 4mm W 33mm plastic Qty 1 pcs		

accessories

fan wheels for cold air circulating fans



1

Part No.	601846	Ref. No.	1.1.C.C17.04
description	fan wheel blowing ø 150mm shaft intake ø 4mm W 33mm plastic Qty 1 pcs		
For models:	GGC1078, GGC1078B		

cross flow fans

EMMEVI - FERGAS

with standard coil



1

Part No.	601018	Ref. No.	01202330
description	cross flow fan TG 180 roller ø 60mm roller length 180mm motor position right 230V/50Hz 25W universal bearing silicone connection male faston 6.3mm -10 up to +60°C 230V connections 1-2 1950U/min connections 1-4 1500U/min		
For models:	GCO2001		

accessories for cross flow fans

air ducts



1

Part No.	701630	Ref. No.	00012330
description	air duct for cross flow fan for combi-steamer plastic grey		
For models:	GCO2001		





hot air fans

miscellaneous

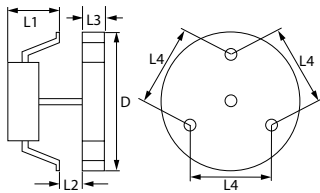

1



Part No.	500902	Ref. No.	MOT30029
description	fan motor 220V 55W 50/60Hz L1 68mm FIME type L25R without fan wheel		
For models:	GCO500		
accessories for	500902		
	Part No.	550879	Ref. No. —
	insulation ø 130mm thickness 3mm hole ø 18mm for hot air fan		



1

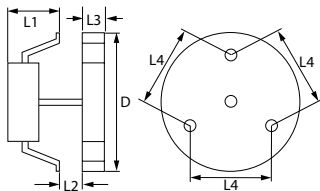

Part No.	602100	Ref. No.	01203230
description	hot air fan 240V 59W 50/60Hz L1 80mm L2 16mm fan wheel ø 150mm IMS type 138251		
For models:	GCO2001		



1

Part No.	601838	Ref. No.	278009000033
description	fan motor 220-240V 18W 2500rpm L1 33mm L2 12mm L3 15mm L4mm fan wheel ø 120mm shaft 2x2.5mm GALANZ type GAL6309E(30)-ZD Qty 1 pcs		
For models:	GMW1025		



1

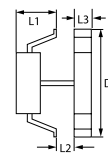

Part No.	601827	Ref. No.	DQB000019R
description	hot air fan 18V 2750rpm L1 6mm L2mm L3 16mm L4mm fan wheel ø 85mm type YHWF-85		
For models:	GIC3035		

accessories

fan wheels for hot air fans



1

Part No.	601839	Ref. No.	223149000014
description	fan wheel ø 120mm W 32mm shaft intake ø 2x2.5mm plastic blades 4 Qty 1 pcs		
For models:	GMW1025		



1

Part No.	601261	Ref. No.	VEN30013
description	fan wheel ø 154mm W 25mm shaft intake ø 6x5mm chrome-plated blades 7		
For models:	GCO500		



miscellaneous



1			
Part No.	601840	Ref. No.	22313900011
description	bracket \varnothing 130mm L 135mm W 130mm for hot air fan Qty 1 pcs		
For models:	GMW1025		

motors

for slicers

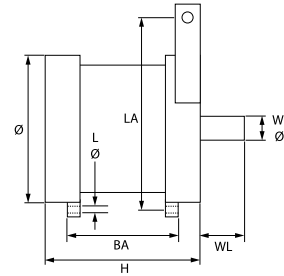

1			
Part No.	501530	Ref. No.	0000001753
description	motor 230V 1 phase 50Hz 1380rpm shaft \varnothing 15mm shaft length 25mm 195-220 edition since 04/2016		
For models:	GFS2019		

speed controllers

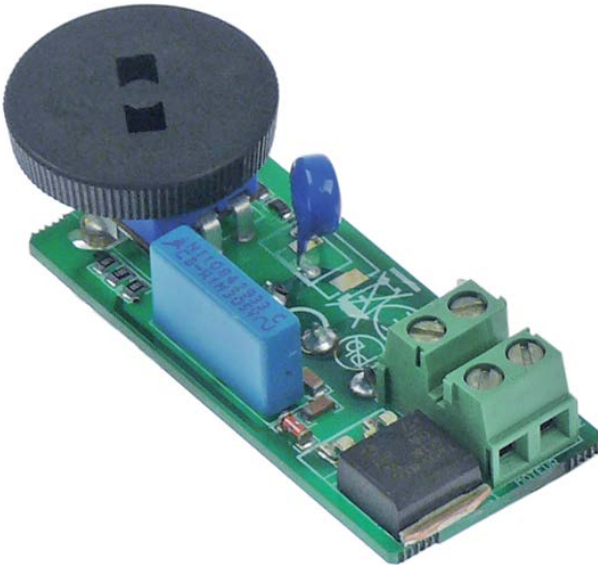

1			
Part No.	403165	Ref. No.	2852
description	PCB GSM1000 speed control		
For models:	GSM1000		
spare parts for	403165		
	Part No.	Ref. No.	2858
	knob for PCB \varnothing 26mm black Qty 1 pcs		

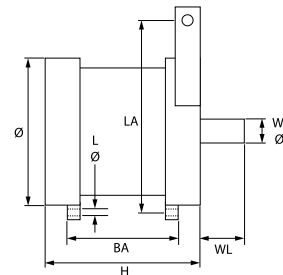

1			
Part No.	501427	Ref. No.	00000700283
description	motor 230V 1 phase 50Hz 1380rpm shaft \varnothing 15mm shaft length 25mm \varnothing 115mm H 86mm mounting distance 44mm hole distance 145mm hole \varnothing 6mm type H35-700283		
For models:	GFS1022, GFS2022		

motors

gear motors

for microwaves



1			
Part No.	601867	Ref. No.	27801900017
description	gear motor GALANZ type GAL-33-30-TD(B) 4W 30V voltage AC 50/60Hz 33/40rpm shaft \varnothing 6x3.5mm for microwave Qty 1 pcs		
For models:	GMW1025		

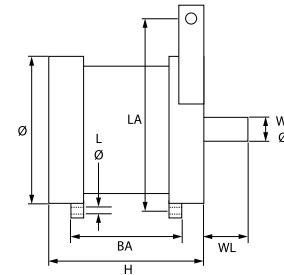

1			
Part No.	501434	Ref. No.	00000000423
description	motor 230V 1 phase 50Hz 1380rpm shaft \varnothing 15mm shaft length 33mm \varnothing 113mm H 91mm mounting distance 49mm hole distance 150mm hole \varnothing 6mm type H40-423 ELETTRMECANICA capacitor 8 μ F		
For models:	GFS1025, GFS2025		



1

Part No.	501433	Ref. No.	0000000681
description	motor 230V 1 phase 50Hz 1380rpm shaft ø 15mm shaft length 35mm ø 113mm H 121mm mounting distance 79mm hole distance 150mm hole ø 6mm type H70-681 ELETTROMECHANICA capacitor 10µF		
For models:	GFS1030		

for hand blenders

motors

1

Part No.	698378	Ref. No.	2847
description	motor for hand blender 230V 100W shaft ø 6.4mm GSM1000		
For models:	GSM1000		

for citrus juicers

1

Part No.	501426	Ref. No.	900956
description	motor for citrus juicers 180W 230-240V 50Hz shaft ø 8mm shaft length 40mm type RCJ298252 0.18kW		
For models:	GJU1001		

pumps

wash and rinse pumps

LGB

1

Part No.	500984	Ref. No.	902263
description	pump inlet ø 45mm outlet ø 39mm type ZF270VSX 230V 50Hz 1 phase 0.4kW L 209mm rotation direction right capacitor 10µF LGB		
For models:	GDW2001		

drain pumps

HANNING

1

Part No.	501596	Ref. No.	902332
description	drain pump 40W 220-240V inlet ø 30mm outlet ø 24mm 50Hz type DPS35-061 HANNING		
For models:	GDW2001		

booster pumps II

accessories

1

Part No.	365015	Ref. No.	0000000633
description	operating capacitor capacity 10µF 400V tolerance 5%Hz ambient temperature max. -25 to +85°C ø 35.5mm L 59mm M8 plastic connection male faston 6.3mm protection		
For models:	GFS1030, GFS2030		



1

Part No.	365012	Ref. No.	00000000149
description	operating capacitor capacity 6.3µF 450V tolerance 5% 50Hz ambient temperature max. -25 to +85°C ø 30mm L 61mm M8 plastic connection male faston 6.3mm protection		
For models:	GFS1022		

condensators & interference suppression filters

operating capacitors

plastic



1

Part No.	365015	Ref. No.	00000000633
description	operating capacitor capacity 10µF 400V tolerance 5%Hz ambient temperature max. -25 to +85°C ø 35.5mm L 59mm M8 plastic connection male faston 6.3mm protection		
For models:	GFS1030, GFS2030		



1

Part No.	365012	Ref. No.	00000000149
description	operating capacitor capacity 6.3µF 450V tolerance 5% 50Hz ambient temperature max. -25 to +85°C ø 30mm L 61mm M8 plastic connection male faston 6.3mm protection		
For models:	GFS1022		



1

Part No.	365013	Ref. No.	00000000182
description	operating capacitor capacity 8µF 400V tolerance 5%Hz ambient temperature max. -25 to +85°C ø 31.5mm L 55mm M8 plastic connection male faston 6.3mm protection		
For models:	GFS1025, GFS2019, GFS2022, GFS2025		

filters

interference suppression filters



1

Part No.	365168	Ref. No.	902107
description	interference suppression filter type FCP045000 250V 50/60Hz conductor 4 with E connection male faston 6.3mm L 56mm ø 38mm Hmm Wmm M8 plastic Qty 1 pcs		
For models:	GDW2001		

line filters

without housing



1

Part No.	403188	Ref. No.	263029001088
description	line filter microwave for GMW1025 250V 50/60Hz conductor 2 PCB connection male faston 4.8mm L 80mm H 20mm W 40mm PCB Qty 1 pcs cable length 120mm type DNV-0818A-5		
For models:	GMW1025		

HV capacitors



1

Part No.	365159	Ref. No.	253059000142
description	HV capacitor for microwave 1.15µF type CH85-21115 2100V 50/60Hz double connection male faston 4.8mm L 105mm H 33mm W 52mm dependent on equipment aluminium Qty 1 pcs		
For models:	GMW1025		

fuses

fine fuses



1

Part No.	358186	Ref. No.	DZJ020003
description	fuse size ø6.3x32 15A slow-acting rated 250V Qty 1 pcs		
For models:	GIC3035		



electric accessories

cables

power supply cables



1

Part No.	551085	Ref. No.	0000009171 C03013
description	cable CEE7/7 type E+F 3-pole contacts P+N+E 1.5mm ² max. 16A max 230V 2m with plug H05VV-F 3G1.5		
For models:	GFS1022, GFS1025, GFS1030, GFS2019, GFS2022, GFS2025, GFS2030, GTO1001, GTO2001		



1

Part No.	698880	Ref. No.	E25EUB315300
description	connecting cable 3-pole contacts P+N+E 1.5mm ² max. 16A max 250V 2.9m		
For models:	GDS2600, GPS2600, GSA2600, GSD2600, GSF2600		



1

Part No.	699317	Ref. No.	S900.47
description	connecting cable CEE7/7 type E+F 3-pole contacts P+N+E 1.5mm ² max. 16A max 250V 2.95m H05VV-F black		
For models:	GHS1600, GHS2600		



1

Part No.	551203	Ref. No.	C03007 CAV30014
description	connecting cable CEE7/7 type E+F 3-pole contacts P+N+E 2.5mm ² max. 16A max 230V 2m H07 RN-F with plug		
For models:	GCO500, GEG2001		



1

Part No.	551232	Ref. No.	253159002607
description	power lead CEE7/7 1mm ² max 500V 1.5m Qty 1 pcs connection male faston 6.3mm black		
For models:	GMW1025		



1

Part No.	551217	Ref. No.	DQXA6002
description	power lead CEE7/7 type E+F 3-pole contacts P+N+E 0.75mm ² max. 16A 2.2m with strain relief 16A Qty 1 pcs white		
For models:	GBC1001, GBC1001S, GBC1001SS, GBC1002, GBC1002S, GBC1002SS, GBC1003, GBC1003S, GBC1003SS, GBC1102, GBC1103, GSC1100G, GSC2336		



1

Part No.	551218	Ref. No.	1.1.A.A08.02.02 1.1.A.A08.02.79 1.1.A.A08.02.87
description	power lead CEE7/7 type E+F 3-pole contacts P+N+E 0.75mm ² max. 16A max 230V 2m Qty 1 pcs grey		
For models:	GCV1600, GGC1078, GGC1078B, GGC2270, GGC2270B		



1

Part No.	551193	Ref. No.	900864
description	power lead CEE7/7 type E+F 3-pole contacts P+N+E 1.5mm ² max. 16A max 230V 1.37m H07RN-F 3G1.50mm ² countries A/B/D/F/I		



1

Part No.	552002	Ref. No.	I3306470
description	power lead CEE7/7 type E+F contacts P+N+E 1mm ² max. 16A max 230V 2.5m		
For models:	GRE3600, GRE3600S		



1

Part No.	551325	Ref. No.	XC0000071R
description	power lead P+N+E 1mm ² max 500V 1.5m Qty 1m connection screw		
For models:	GIC3035		



accessories

cable glands

threaded cable glands

screw connections



1

Part No.	551379	Ref. No.	PPC30004
description	cable gland thread PG13.5 cable ø 12mm mounting ø 20mm WS 24 plastic Qty 1 pcs with nut		
For models:	GCO500		



1

Part No.	551288 ¹	Ref. No.	A10032
description	cable gland thread PG16 cable ø 14mm mounting ø 22.5mm WS 27 plastic Qty 1 pcs		
For models:	GEG2001		

¹incl. fastening nut

strain reliefs



1

Part No.	506235	Ref. No.	1.1.C.C24.03
description	strain relief L 28mm W 12mm H 8mm hole ø 3.5mm hole distance 16mm plastic Qty 1 pcs		
For models:	GGC1078, GGC1078B		

cable harnesses



1

Part No.	694615	Ref. No.	253169000472
description	cable harness for microwave L 800mm Qty 1 pcs		
For models:	GMW1025		

connection cables

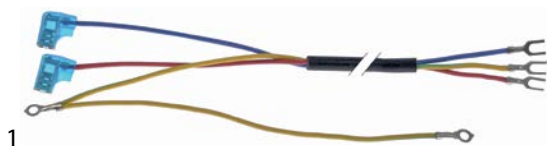

1

Part No.	699304	Ref. No.	DQXB9019
description	connection cable L 360mm 3-pole		
For models:	GBC1001, GBC1001S, GBC1001SS, GBC1002, GBC1002S, GBC1002SS, GBC1003, GBC1003S, GBC1003SS, GBC1102, GBC1103		

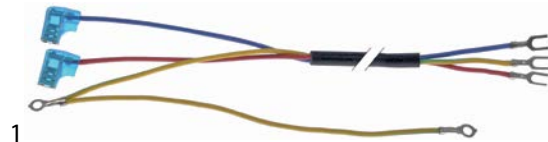

1

Part No.	699305	Ref. No.	DQXB2003
description	connection cable L 650mm 3-pole		
For models:	GSC2336		

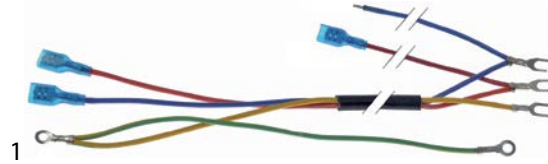

1

Part No.	699306	Ref. No.	DQXB4003
description	connection cable L 665mm 3-pole		
For models:	GSC1100G		

terminals

connection terminals with screw/faston connections



1

Part No.	551444	Ref. No.	01200720
description	power terminal block 3-pole max. 25A max 450V connection male faston 6.3mm temp.-resist. 150°C		
For models:	GCO2001		



1

Part No.	550516	Ref. No.	MOR30005
description	power terminal block 3-pole max. 40A max 400V connection M6/ male faston 6.3mm temp.-resist. 150°C cross section 6mm ² mounting distance 66.5mm		
For models:	GCO500		



1

Part No.	550411	Ref. No.	904150 A16014
description	power terminal block 6-pole max. 40A max 450V connection ø6mm ² / F6.3 temp.-resist. 150°C cross section 6mm ²		
For models:	GDW2001, GEG2001		



connection terminals with faston connections



1

Part No.	519372	Ref. No.	904167
description	distribution terminal block 4-pole max. 17.5A max 450V connection F6.3 temp.-resist. 110°C 450V		
For models:	GDW2001		

connection boxes



1

Part No.	550300	Ref. No.	A10007
description	power terminal block 3-pole contacts P+N+E		
For models:	GTO1001, GTO2001		

terminal boxes



1

Part No.	551214	Ref. No.	S900.48
description	terminal box 4-pole L 90mm W 52mm H 28mm with strain relief Qty 1 pcs		
For models:	GHS1600, GHS2600		



1

Part No.	551216	Ref. No.	SLZB3001
description	terminal box 4-pole L 90mm W 52mm H 33mm with strain relief 250V 1mm ² Qty 1 pcs		
For models:	GBC1001, GBC1001S, GBC1001SS, GBC1002, GBC1002S, GBC1002SS, GBC1003, GBC1003S, GBC1003SS, GBC1102, GBC1103, GSC2336		

equipmentspecific units

for slicers

covers



1

Part No.	696528	Ref. No.	00000000489
description	blade covering ø 180mm for knife ø 220mm mounting thread M6 fixing dimensions 12x12mm cast aluminium edition since year of construction 2010		
For models:	GFS1022, GFS2022		

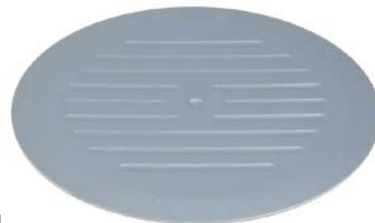

1

Part No.	697749	Ref. No.	00000000463 00000000490
description	blade covering ø 209mm for knife ø 250mm mounting thread M6 fixing dimensions 12x12mm aluminium		
For models:	GFS1025, GFS2025		



1

Part No.	697744	Ref. No.	00000000403
description	blade covering ø 248mm for knife ø 300mm mounting thread M6 fixing dimensions 12x12mm aluminium		
For models:	GFS1030, GFS2030		

locking screws



1

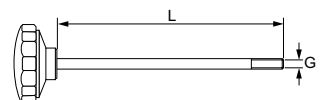

Part No.	698376	Ref. No.	00000001302 00000701302
description	locking screw thread M6 L 134mm black		
For models:	GFS1022, GFS2022		



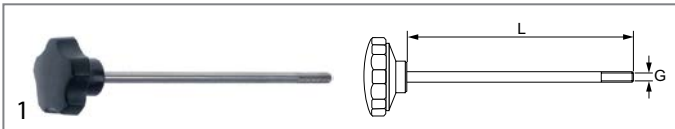

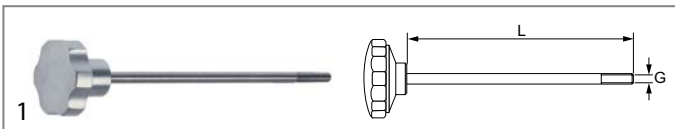
	
Part No.	697439
Ref. No.	0000000777
description	locking screw thread M6 L 155mm handle ø 40mm
For models:	GFS2025

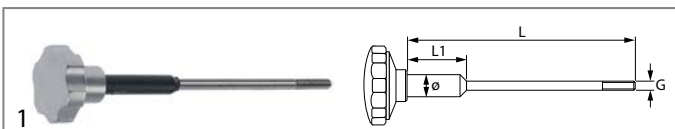
	
Part No.	696602
Ref. No.	0000009958
description	locking screw thread M6 L 188mm handle ø 39mm for model 300/S-G,Dolly Verticale VS300
For models:	GFS1030

	
Part No.	698629
Ref. No.	0000070956
description	locking screw thread M6 L 155mm ø 10mm L1 55mm handle ø 29mm
For models:	GFS1025

adjustment knobs

	
Part No.	697419
Ref. No.	0000000130 00000700130
description	adjusting knob 0-15 ø 55mm shaft ø 12mm shaft L 28mm handle ø 42mm 250
For models:	GFS1022, GFS2019, GFS2022, GFS2025, GFS2030

	
Part No.	696522
Ref. No.	0000009503
description	adjusting knob 0-22 ø 68mm shaft ø 18mm shaft L 50mm handle ø 68mm turn direction left
For models:	GFS1030

eccentric disc for slice thickness

	
Part No.	697470
Ref. No.	0000000830
description	eccentrics for cutting thickness hole ø 12mm groove width 6mm ED ø 52mm thickness 21.5mm
For models:	GFS2025

	
Part No.	697471
Ref. No.	0000000379
description	eccentrics for cutting thickness hole ø 12mm groove width 6mm ED ø 58mm thickness 21mm
For models:	GFS1022, GFS1025, GFS2019, GFS2022, GFS2030

spring washers

	
Part No.	697478
Ref. No.	0000000671
description	spring washer ID ø 19mm ED ø 26mm Qty 1 pcs
For models:	GFS1030

guiding pieces

for sliding plates

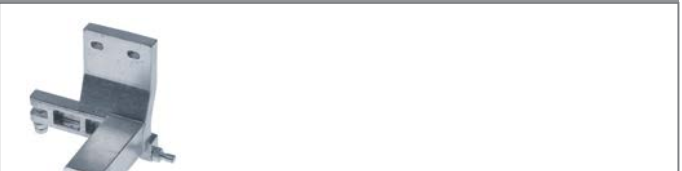
	
Part No.	697483
Ref. No.	0000000117
description	guide 195
For models:	GFS1022, GFS2019, GFS2022

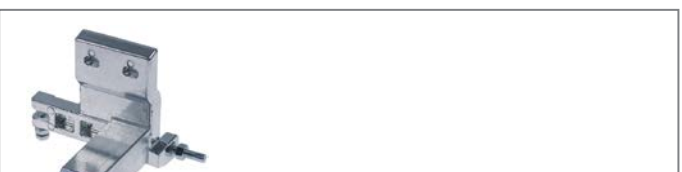
	
Part No.	697448
Ref. No.	0000009177
description	guide 220-250
For models:	GFS2025, GFS2030



<p>1</p>			
Part No.	696524	Ref. No.	00000000602 00000009691
description	guide L 117mm W 92mm H 51mm hole ø 18mm shaft intake ø 16mm aluminium		
For models:	GFS1030		

<p>1</p>			
Part No.	697477	Ref. No.	00000000126
description	connection plate L 75mm W 15mm		
For models:	GFS2019, GFS2022, GFS2025, GFS2030		

<p>for carriage</p> <p>1</p>			
Part No.	696510	Ref. No.	00000009466
description	guide 220		
For models:	GFS1022, GFS2019, GFS2022		

<p>bushes</p> <p>1</p>			
Part No.	698626	Ref. No.	00000000119
description	bush ED ø 18mm ID ø 16mm H 15mm		
For models:	GFS1030, GFS2025, GFS2030		

<p>1</p>			
Part No.	698627	Ref. No.	00000000611
description	bush ED ø 8mm ID ø 5mm H 10mm		
For models:	GFS1030		

<p>spindles</p> <p>1</p>			
Part No.	697782	Ref. No.	00000000501
description	spindle for carriage ø 16mm L 390mm thread M8		
For models:	GFS1025		

<p> housings</p> <p>bottom parts</p> <p>1</p>			
Part No.	696512	Ref. No.	00000000504
description	bottom plate 220		
For models:	GFS1022, GFS2019, GFS2022		

<p>1</p>			
Part No.	696345	Ref. No.	00000000516
description	bottom plate L 390mm W 190mm plastic 300		
For models:	GFS1025		

<p>1</p>			
Part No.	698393	Ref. No.	00000000701
description	bottom plate L 409mm W 174mm plastic		
For models:	GFS2025, GFS2030		

<p>1</p>			
Part No.	698389	Ref. No.	00000000768
description	cover L 447mm W 180mm plastic		
For models:	GFS1030		

<p>hand guard</p> <p>1</p>			
Part No.	697754	Ref. No.	00000000784
description	hand protection for knife ø 300mm H 125mm W 60mm thickness 1.2mm hole ø 6.5mm mounting distance 84mm stainless steel		
For models:	GFS1030		



			
1			
Part No.	696511	Ref. No.	00000000197
description	wiper for knife ø 220/250mm stainless steel		
For models:	GFS1025, GFS2025		

			
1			
Part No.	697755	Ref. No.	00000000162
description	hand protection for carriage 300 H 180mm W 152mm thickness 5mm hole ø 10mm mounting distance 110mm plastic		
For models:	GFS1030		

			
1			
Part No.	697826	Ref. No.	00000000924
description	hand protection for slicer		
For models:	GFS1025, GFS2025		

			
1			
Part No.	698964	Ref. No.	00000000482
description	hand protection for slicer 195-220		
For models:	GFS2019, GFS2022		

accessories



			
1			
Part No.	697482	Ref. No.	00000000446
description	screw thread M5 ø 8mm L 15mm		
For models:	GFS1025, GFS1030, GFS2019, GFS2022, GFS2025		

			
1			
Part No.	697481	Ref. No.	00000000623
description	Thumb screw thread M6 thread L 8mm ø 14mm H 6mm SS		
For models:	GFS1030, GFS2019, GFS2022, GFS2025		

			
1			
Part No.	698640	Ref. No.	00000009924
description	blade pulley complete with shaft shaft ø 14 shaft length 95mm mounting thread M5 3 hole fixing		
For models:	GFS1022, GFS2022		

			
1			
Part No.	697747	Ref. No.	00000009920
description	blade pulley with spindle D1 ø 40mm D2 ø 64.3mm D3 ø 67.5mm shaft ø 14 L 33mm shaft length 152mm mounting thread M5 mounting ø 3-hole		
For models:	GFS1025		

			
1			
Part No.	697746	Ref. No.	00000009469
description	blade pulley with spindle D1 ø 40mm D2 ø 76mm shaft ø 16 L 40mm shaft length 157mm mounting thread M5 mounting ø 3-hole		
For models:	GFS1030		

spare parts for 697746			
	Part No.	514030	Ref. No. —
	retaining ring shaft ø 20mm thickness 1.3mm steel DIN 471		
	Part No.	523512	Ref. No. 00000000632
	deep-groove ball bearing type 6204-2RS shaft ø 20mm ED ø 47mm W 14mm with sealing discs deep-groove ball bearing DIN 625-1		
	Part No.	692029	Ref. No. —
	retaining ring bore ø 47mm thickness 1.8mm steel DIN 472		



food holders

handles

1

Part No.	698642	Ref. No.	00000001130
description	handle thread M10 ø 59mm L 100mm aluminium		
For models:	GFS1030		

1

Part No.	696515	Ref. No.	00000001242	
description	handle thread M10x1.5 ø 34mm L 88mm food holder			
For models:	GFS1025			
accessories for	696515			
	Part No.	696517	Ref. No.	00000800678
	thread bolt for handle ø 12mm L 64mm thread M6/M10 stainless steel			

1

Part No.	697429	Ref. No.	00000000298
description	handle thread M6 ø 25mm L 126mm with hand guard D1 ø 70mm		
For models:	GFS2019, GFS2022, GFS2025, GFS2030		

food holders

1

Part No.	698644	Ref. No.	00000000608	
description	food holder 300-350 L 290mm hole ø 12mm handle M10 CE			
For models:	GFS1030			
accessories for	698644			
	Part No.	110703	Ref. No.	—
	cylindrical handle thread M10 ø 28mm L 87mm			

1

Part No.	698418	Ref. No.	00000009878
description	food holder L 240mm hole ø 12mm handle M6 with handle		
For models:	GFS1025, GFS2025, GFS2030		

accessories

1

Part No.	698630	Ref. No.	00000000827
description	spike food holder ø 3mm L 11.5mm		
For models:	GFS1025, GFS1030, GFS2019, GFS2022, GFS2025, GFS2030		

1

Part No.	697480	Ref. No.	00000000151
description	stop bolt food holder ø 7.5mm L 8mm plastic		
For models:	GFS1025, GFS1030, GFS2019, GFS2022, GFS2025, GFS2030		

1

Part No.	696517	Ref. No.	00000800678	
description	thread bolt for handle ø 12mm L 64mm thread M6/M10 stainless steel			
For models:	GFS1025			
accessories for	696515			
	Part No.	696515	Ref. No.	00000001242
	handle thread M10x1.5 ø 34mm L 88mm food holder			

blades

standard

1

Part No.	697546	Ref. No.	00000000254
description	slicing machine blade ED ø 195mm seat ø 30mm 3-hole ID ø 155mm H 12.8mm C45 standard		
For models:	GFS2019		

1

Part No.	697436	Ref. No.	00000000855
description	slicing machine blade ED ø 220mm seat ø 40mm 3-hole ID ø 180mm H 15.5mm C45		
For models:	GFS1022, GFS2022		





			
1			
Part No.	697365	Ref. No.	00000000142
description	slicing machine blade ED ø 250mm seat ø 40mm 3-hole ID ø 210mm H 17.5mm C45 standard		
For models:	GFS1025, GFS2025		

			
1			
Part No.	697385	Ref. No.	00000000636
description	slicing machine blade ED ø 300mm seat ø 40mm 3-hole ID ø 250mm H 20mm C45 standard		
For models:	GFS1030, GFS2030		

sharpeners units

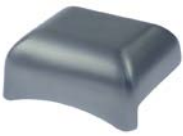
lids

			
1			
Part No.	696514	Ref. No.	00000000863
description	lid for sharpener units L 116mm W 100mm mounting distance 26mm		
For models:	GFS1025, GFS2022, GFS2025		

			
1			
Part No.	698643	Ref. No.	00000000596
description	lid for sharpener units L 150mm W 120mm		
For models:	GFS1030, GFS2030		

holders

			
1			
Part No.	696493	Ref. No.	00000000771
description	bracket for sharpener units L 60mm W 31mm H 78mm hole ø 12mm mounting thread M6 with fastening angle		
For models:	GFS1030		

knobs

			
1			
Part No.	697441	Ref. No.	00000000854
description	locking screw thread M5 handle ø 25mm black L 30mm		
For models:	GFS2022, GFS2025		

			
1			
Part No.	696518	Ref. No.	00000000954
description	locking screw thread M5 L 47mm handle ø 25mm silver		
For models:	GFS1025		

			
1			
Part No.	697428	Ref. No.	00000000138
description	locking screw thread M6 handle ø 25mm black L 15mm		
For models:	GFS2019		

			
1			
Part No.	697384	Ref. No.	00000000734
description	locking screw thread M6 handle ø 25mm black L 54mm		
For models:	GFS2030		

			
1			
Part No.	696523	Ref. No.	000000009510
description	locking screw thread M6 L 53mm handle ø 34mm silver		
For models:	GFS1030		

			
1			
Part No.	697445	Ref. No.	00000000677
description	mushroom cap handle thread M6 handle ø 33mm L 26mm plastic black		
For models:	GFS2030		



sharpener units





1

Part No.	697397	Ref. No.	00000009864
description	blade sharpener 220/250/275		
For models:	GFS1022, GFS1025, GFS2022, GFS2025		





1

Part No.	697355	Ref. No.	00000009693	
description	blade sharpener 350			
For models:	GFS1030			
spare parts for	697355			
	Part No.	697377	Ref. No.	00000000720
	grindstone ø 51mm thickness 12mm bore ø 8mm grained coarse without bevel			
	Part No.	697378	Ref. No.	00000000721
	grindstone ø 51mm thickness 7mm bore ø 8mm grained fine with bevel, without hub			



1

Part No.	697420	Ref. No.	00000009168	
description	blade sharpener PARKER			
For models:	GFS2019			
spare parts for	697420			
	Part No.	697423	Ref. No.	00000000816
	grindstone ø 40mm thickness 8mm bore ø 6mm grained fine with bevel, with hub			
	Part No.	697424	Ref. No.	00000000871
	grindstone ø 40mm thickness 8mm bore ø 6mm grained coarse with bevel, with hub			
	Part No.	697428	Ref. No.	00000000138
	locking screw thread M6 handle ø 25mm black L 15mm			

spindles



1

Part No.	698633	Ref. No.	00000000778
description	spindle for sharpener units ø 12mm L 95mm thread M5		
For models:	GFS1030		

grindstones



1

Part No.	697378	Ref. No.	00000000721
description	grindstone ø 51mm thickness 7mm bore ø 8mm grained fine with bevel, without hub		
For models:	GFS1030, GFS2030		

grindstones with hub



1

Part No.	697424	Ref. No.	00000000871
description	grindstone ø 40mm thickness 8mm bore ø 6mm grained coarse with bevel, with hub		
For models:	GFS2019		



1

Part No.	697423	Ref. No.	00000000816
description	grindstone ø 40mm thickness 8mm bore ø 6mm grained fine with bevel, with hub		
For models:	GFS2019		



1

Part No.	697421	Ref. No.	00000000641
description	grindstone ø 45mm thickness 8mm bore ø 6mm grained coarse with bevel, with hub		
For models:	GFS1025, GFS2022, GFS2025		



1

Part No.	697422	Ref. No.	00000000642
description	grindstone ø 45mm thickness 8mm bore ø 6mm grained fine with bevel, with hub		
For models:	GFS1025, GFS2022, GFS2025		



grindstones cup form



1

Part No.	697377	Ref. No.	00000000720
description	grindstone ø 51mm thickness 12mm bore ø 8mm grained coarse without bevel		
For models:	GFS1030, GFS2030		

carriages

handles



1

Part No.	697440	Ref. No.	00000000432
description	handle thread M10 handle ø 66mm H 51mm black		
For models:	GFS1022		

accessories



1

Part No.	696516	Ref. No.	00000000186
description	bracket for carriage L 56mm aluminium		
For models:	GFS2019, GFS2022		



1

Part No.	698631	Ref. No.	00000000895
description	spindle for carriage thread M6 L 170mm ø 12mm		
For models:	GFS2025		



1

Part No.	697827	Ref. No.	00000000678
description	spindle for slicer thread M10 L 95mm thread L 12/15mm total length 122mm ø 16mm stainless steel		
For models:	GFS1030		

miscellaneous



1

Part No.	697356	Ref. No.	00000000300
description	bracket thread M10x0.75 ø 30mm for microswitch ID ø 14.5mm thickness 13mm mounting thread M5		
For models:	GFS1025		



1

Part No.	697476	Ref. No.	00000000509
description	bush ø 14mm L 88mm ID ø 12mm		
For models:	GFS1025, GFS2019, GFS2022, GFS2025, GFS2030		



1

Part No.	698388	Ref. No.	00000000765
description	mounting flange ø 18mm L 128mm W 28mm		
For models:	GFS1030		



1

Part No.	698392	Ref. No.	00000000828
description	thread bolt thread M6 ø 6mm L 35mm for slicer		
For models:	GFS1025, GFS1030, GFS2019, GFS2022, GFS2025, GFS2030		



1

Part No.	698628	Ref. No.	00000000774
description	threaded shaft thread M6 L 37mm for slicer		
For models:	GFS1030		

for hand blenders

housings



1

Part No.	699708	Ref. No.	2840M
description	cover for handle blue GSM1000 L 80mm W 42mm		
For models:	GSM1000		



1

Part No.	696503	Ref. No.	2851
description	handle for hand blender plastic grey		
For models:	GSM1000		

1

Part No.	698386	Ref. No.	2848M
description	sticker for hand blender silver L 125mm W 25mm thickness 1mm ON-OFF		
For models:	GSM1000		

1

Part No.	699134	Ref. No.	2849M
description	housing left blue GSM1000		
For models:	GSM1000		
accessories for	699134		
	Part No.	Ref. No.	
	699133	2843M	housing right blue GSM1000

1

Part No.	698387	Ref. No.	2853M
description	sticker for lid silver L 50mm W 27mm		
For models:	GSM1000		

1

Part No.	699133	Ref. No.	2843M
description	housing right blue GSM1000		
For models:	GSM1000		
accessories for	699133		
	Part No.	Ref. No.	
	699134	2849M	housing left blue GSM1000

couplings

1

Part No.	696504	Ref. No.	2846
description	coupling for hand blender D1 ø 19mm int. ø 1 6.3mm L 29.5mm teeth 8 GSM1000		
For models:	GSM1000		

1

Part No.	696505	Ref. No.	2860
description	coupling with roll pin for hand blender D1 ø 19mm int. ø 1 8mm teeth 8 GSM1000		
For models:	GSM1000		

blender sticks

blades

blades with adaptor (complete)

1

Part No.	698262	Ref. No.	0551
description	knife ø 39mm hole ø 4mm H 12mm		
For models:	GSM1000		



			
1			
Part No.	698261	Ref. No.	0550
description	knife ø 39mm hole ø 4mm H 18mm		
For models:	GSM1000		



			
1			
Part No.	698381	Ref. No.	0552
description	mixer disc ø 36mm hole ø 4mm H 0.8mm GSM1000		
For models:	GSM1000		

			
1			
Part No.	698382	Ref. No.	0553
description	mixer disc ø 36mm hole ø 4mm H 3.4mm GSM1000		
For models:	GSM1000		

blender sticks

			
1			
Part No.	698379	Ref. No.	2845M
description	blender stick GSM1000 L 234mm flange ø 66mm		
For models:	GSM1000		

spindles

			
1			
Part No.	698380	Ref. No.	2844M
description	drive shaft for hand blender with coupling D1 ø 4mm D2 ø 8mm L 214mm SS		
For models:	GSM1000		
spare parts for	698380		
	Part No.	696505	Ref. No.
			2860
	coupling with roll pin for hand blender D1 ø 19mm int. ø 1 8mm teeth 8 GSM1000		

miscellaneous

			
1			
Part No.	698385	Ref. No.	2841
description	bracket for grab handle L 40mm W 37mm thickness 1.5mm		
For models:	GSM1000		

			
1			
Part No.	696507	Ref. No.	2854
description	bracket for motor plastic black		
For models:	GSM1000		

			
1			
Part No.	696506	Ref. No.	2858
description	knob for PCB ø 26mm black Qty 1 pcs		
For models:	GSM1000		

			
1			
Part No.	532648	Ref. No.	2859
description	O-ring EPDM thickness 1.5mm ID ø 5mm Qty 1 pcs		
For models:	GSM1000		

			
1			
Part No.	698384	Ref. No.	45710
description	protection cap for grab handle plastic black		
For models:	GSM1000		

			
1			
Part No.	698383	Ref. No.	0632
description	shaft sealing ID ø 4mm ED ø 12mm for hand blender H 6.3mm		
For models:	GSM1000		



for citrus juicers

spillage trays



1

Part No.	696502	Ref. No.	900963
description	drain tray for citrus juicers ø 175mm hole ø 42mm H 110mm SS		
For models:	GJU1001		

gaskets



1

Part No.	532647	Ref. No.	900970
description	O-ring EPDM thickness 1.8mm ID ø 11.8mm Qty 1 pcs		
For models:	GJU1001		



1

Part No.	511953	Ref. No.	900871
description	seal kit for citrus juicers		
For models:	GJU1001		

motors



1

Part No.	501426	Ref. No.	900956
description	motor for citrus juicers 180W 230-240V 50Hz shaft ø 8mm shaft length 40mm type RCJ298252 0.18kW		
For models:	GJU1001		

juicer insert



1

Part No.	650168	Ref. No.	900901
description	filter for citrus juicers ø 155mm H 23mm plastic		
For models:	GJU1001		



1

Part No.	650167	Ref. No.	221266
description	juicer insert set for citrus juicers ø 57/62/79mm H 45/50/55mm plastic		
For models:	GJU1001		

spindles



1

Part No.	650170	Ref. No.	900895
description	spindle L 48mm square thread M8x1.25 for citrus juicers WS 12		
For models:	GJU1001		

miscellaneous



1

Part No.	650171	Ref. No.	900925
description	cover for spindle ø 44mm H 18mm aluminium		
For models:	GJU1001		



1

Part No.	650169	Ref. No.	221242
description	drip tray for citrus juicers ø 79mm H 20mm plastic black		
For models:	GJU1001		

for fridges

drain systems

drain valves





1

Part No.	699499	Ref. No.	W0409858
description	drain fitting connection A L 47mm hose ø 15mm for GFR2700/GRE2700 plastic		
For models:	GFR2700, GRE2700		

accessories for	699499			
	Part No.	699567	Ref. No.	W0409859
				drain fitting connection B L 20mm for GFR2700/GRE2700 plastic



			
1			
Part No.	699567	Ref. No.	W0409859
description	drain fitting connection B L 20mm for GFR2700/GRE2700 plastic		
For models:	GFR2700, GRE2700		
accessories for	699567		
	Part No.	699499	Ref. No. W0409858
	drain fitting connection A L 47mm hose ø 15mm for GFR2700/GRE2700 plastic		

drain pans

			
1			
Part No.	530916	Ref. No.	80012001
description	drain pan L 520mm W 233mm H 30mm for GFR2700/GRE2700 hole ø 24mm		
For models:	GFR2700, GRE2700		

control parts

			
1			
Part No.	698848	Ref. No.	GPC1088-03
description	lamp with thermostat ø 140mm H 35mm		
For models:	GPC1088		

spare parts and accessories

			
1			
Part No.	699568	Ref. No.	W0604038
description	base plate for door hinge mounting pos. lower L 35mm W 25mm for GFR2700/GRE2700		
For models:	GFR2700, GRE2700		

			
1			
Part No.	699569	Ref. No.	W0604030
description	base plate for door hinge mounting pos. right L 74mm W 42mm for GFR2700/GRE2700		
For models:	GFR2700, GRE2700		



			
1			
Part No.	694967	Ref. No.	SLCX0002
description	cover L 51mm W 44mm H 12mm plastic mounting distance 30mm		
For models:	GSC2336		

			
1			
Part No.	692867	Ref. No.	W04102051
description	cover ø 20mm L 400mm W 43mm plastic Qty 1 pcs for GFR2700/GRE2700		
For models:	GFR2700, GRE2700		
accessories for	692867		
	Part No.	692870	Ref. No. W0413062
	rubber pad L 40mm W 17mm H 30mm for GFR2700/GRE2700		
	Part No.	696789	Ref. No. W0210413
	copper pipe with insulation pipe ø 6 for fridge GFR2700/GRE2700		



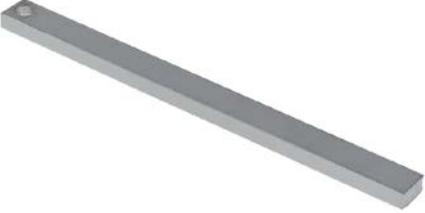



 <p>1</p>			
Part No.	698849	Ref. No.	GPC1046-03 GPC1088-04
description	cover cap L 96mm W 44mm H 13mm plastic		
For models:	GPC1046, GPC1088		



 <p>1</p>			
Part No.	698878	Ref. No.	WJQZ9001
description	guide counterweight for sliding door L 248mm W 20mm H 10mm		
For models:	GBC1102, GBC1103		

 <p>1</p>			
Part No.	692870	Ref. No.	W0413062
description	rubber pad L 40mm W 17mm H 30mm for GFR2700/GRE2700		
For models:	GFR2700, GRE2700		
accessories for	692870		
	Part No.	692867	Ref. No. W04102051
	cover ø 20mm L 400mm W 43mm plastic Qty 1 pcs for GFR2700/GRE2700		
	Part No.	696789	Ref. No. W0210413
	copper pipe with insulation pipe ø 6 for fridge GFR2700/GRE2700		



 <p>1</p>			
Part No.	699232	Ref. No.	I0535012
description	strain relief L 56mm W 14.5mm H 20mm		
For models:	GFR3600S		

housing and bezels			
covers			
 <p>1</p>			
Part No.	699586	Ref. No.	80010941 80011041
description	bracket for air baffle L 800mm W 38mm H 20mm for GFR2700/GRE2700 3 holes		
For models:	GFR2700, GRE2700		
accessories for	699586		
	Part No.	699573	Ref. No. 80010942 80011042
	deflector rear L 1030mm W 363mm H 20mm for GFR2700/GRE2700		

 <p>1</p>			
Part No.	699576	Ref. No.	81131203
description	cover for drain pan L 598mm W 218mm H 42mm for GFR2700/GRE2700		
For models:	GFR2700, GRE2700		
accessories for	699576		
	Part No.	696783	Ref. No. W0803011
	insulation Styropor for drain pan L 515mm W 213mm H 18mm Qty pcs for GFR2700/GRE2700		

 <p>1</p>			
Part No.	692879	Ref. No.	W0409863
description	cover for lamp L 185mm W 55mm H 40mm for GFR2700/GRE2700		
For models:	GFR2700, GRE2700		
accessories for	692879		
	Part No.	357260	Ref. No. W0304086 W0304511
	LED bar L 130mm W 14mm H 8mm cable length 300mm GFR2700/GRE2700		

 <p>1</p>			
Part No.	998252	Ref. No.	44037000
description	cover for ventilation L 72mm W 62mm H 10mm Qty 1 pcs		
For models:	GFR3600S, GRE3600, GRE3600S		



			
1			
Part No.	699574	Ref. No.	81131204
description	cover front for evaporator L 598mm W 295mm H 65mm for GFR2700/GRE2700		
For models:	GFR2700, GRE2700		
accessories for	699574		
	Part No.	699577	Ref. No. 80021203
	cover left for evaporator L 255mm W 155mm H 15mm for GFR2700/GRE2700		
	Part No.	699578	Ref. No. 80021204
	cover right for evaporator L 255mm W 155mm H 15mm for GFR2700/GRE2700		



control panel			
			
1			
Part No.	699234	Ref. No.	44027000
description	bezel L 780mm W 67mm H 62mm mounting pos. upper		
For models:	GRE3600		



lids			
			
1			
Part No.	698864	Ref. No.	GPC1046-05 GPC1088-06
description	cover black L 50mm W 42mm H 7mm		
For models:	GPC1046, GPC1088		

 housings			
			
1			
Part No.	699575	Ref. No.	81131401 81131403
description	front panel front-upper for fridge L 730mm W 300mm H 62mm for GFR2700/GRE2700		
For models:	GFR2700, GRE2700		

			
1			
Part No.	699233	Ref. No.	I9500323
description	terminal box L 98mm W 74mm H 35mm kit		
For models:	GFR3600S, GRE3600, GRE3600S		

			
1			
Part No.	699577	Ref. No.	80021203
description	cover left for evaporator L 255mm W 155mm H 15mm for GFR2700/GRE2700		
For models:	GFR2700, GRE2700		
accessories for	699577		
	Part No.	699574	Ref. No. 81131204
	cover front for evaporator L 598mm W 295mm H 65mm for GFR2700/GRE2700		
	Part No.	699578	Ref. No. 80021204
	cover right for evaporator L 255mm W 155mm H 15mm for GFR2700/GRE2700		

			
1			
Part No.	699578	Ref. No.	80021204
description	cover right for evaporator L 255mm W 155mm H 15mm for GFR2700/GRE2700		
For models:	GFR2700, GRE2700		
accessories for	699578		
	Part No.	699574	Ref. No. 81131204
	cover front for evaporator L 598mm W 295mm H 65mm for GFR2700/GRE2700		
	Part No.	699577	Ref. No. 80021203
	cover left for evaporator L 255mm W 155mm H 15mm for GFR2700/GRE2700		

			
1			
Part No.	699573	Ref. No.	80010942 80011042
description	deflector rear L 1030mm W 363mm H 20mm for GFR2700/GRE2700		
For models:	GFR2700, GRE2700		
accessories for	699573		
	Part No.	699586	Ref. No. 80010941 80011041
	bracket for air baffle L 800mm W 38mm H 20mm for GFR2700/GRE2700 3 holes		



equipment feet



1

Part No.	698865	Ref. No.	GPC1088-12
description	equipment foot M8 thread L 15mm ø 29mm		
For models:	GPC1088		

handles



1

Part No.	692390	Ref. No.	LCCG0005
description	handle rod for door L 380mm W 40mm aluminium Qty 1 pcs		
For models:	GSC1100G		

caps



1

Part No.	692372	Ref. No.	S900.03
description	cap grey ø 16.5mm mounting ø 12.5mm H 7mm Qty 1 pcs		
For models:	GHS1600, GHS2600		

frame



1

Part No.	699583	Ref. No.	W04102045
description	frame rail for door mounting pos. left/right L 1530mm W 19mm H 7.5mm plastic for GFR2700/GRE2700		
For models:	GFR2700, GRE2700		
accessories for	699583		
	Part No.	Ref. No.	W04102044
	699584		
	frame rail for door mounting pos. upper/lower L 650mm W 19mm H 7.5mm plastic for GFR2700/GRE2700		

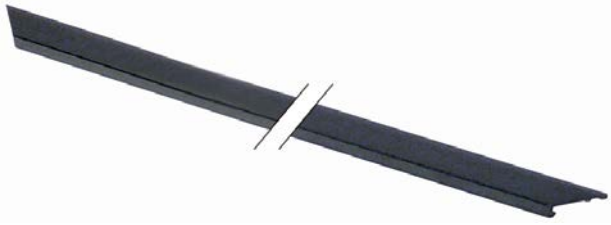

1

Part No.	699584	Ref. No.	W04102044
description	frame rail for door mounting pos. upper/lower L 650mm W 19mm H 7.5mm plastic for GFR2700/GRE2700		
For models:	GFR2700, GRE2700		
accessories for	699584		
	Part No.	Ref. No.	W04102045
	699583		
	frame rail for door mounting pos. left/right L 1530mm W 19mm H 7.5mm plastic for GFR2700/GRE2700		

miscellaneous



1

Part No.	692392	Ref. No.	SLSE4005
description	cover for lighting W 1170mm H 280mm thickness 1mm plastic Qty 1 pcs		
For models:	GSC1100G		



1

Part No.	692391	Ref. No.	SLZE0027
description	housing for bulb socket L 150mm W 40mm H 20mm plastic Qty 1 pcs		
For models:	GSC1100G, GSC2336		

doors



1

Part No.	699571	Ref. No.	81130201
description	door right suitable for GFR2700/GRE2700 W 730mm H 1610mm thickness 45mm stainless steel		
For models:	GFR2700, GRE2700		
spare parts for	699571		
	Part No.	Ref. No.	W0604030
	699569		
	base plate for door hinge mounting pos. right L 74mm W 42mm for GFR2700/GRE2700		
	Part No.	Ref. No.	W0409842
	701641		
	bush upper for door hinge ID ø 11mm ED ø 13mm L 29.5mm for GFR2700/GRE2700		
	Part No.	Ref. No.	W0409843
	701642		
	bush lower for door hinge ID ø 11mm ED ø 13mm L 26mm for GFR2700/GRE2700		

Table continues overleaf



spare parts for 699571			
	Part No.	902514	Ref. No. W0404514
refrigeration gasket profile 9750 W 660mm L 1537mm plug size			



1	Part No.	699381	Ref. No.	BLGM4010
description glass door left W 600mm H 1330mm D 40mm				
For models: GSC1100G				

spare parts for 699381			
	Part No.	901662	Ref. No. SLJP4007
door seal profile 9156 W 569mm L 1295mm plug size Qty 1 pcs			



1	Part No.	699382	Ref. No.	BLGM4011
description glass door right W 600mm H 1330mm D 40mm				
For models: GSC1100G				

spare parts for 699382			
	Part No.	901662	Ref. No. SLJP4007
door seal profile 9156 W 569mm L 1295mm plug size Qty 1 pcs			

miscellaneous



1	Part No.	692869	Ref. No.	81131801 W0409081
description cover for drain pipe L 145mm W 49mm H 44mm plastic for GFR2700				
For models: GFR2700, GRE2700				



1	Part No.	698888	Ref. No.	SLZV0019
description cover transparent for lamp L 810mm W 40mm H 30mm Qty 1 pcs				
For models: GBC1003, GBC1003S, GBC1003SS, GBC1103				



1	Part No.	692426	Ref. No.	LCCJ2029
description guide for fridge L 1145mm W 26mm H 4.5mm Qty 1 pcs				
For models: GSC1100G, GSC2336				



1	Part No.	696783	Ref. No.	W0803011
description insulation Styropor for drain pan L 515mm W 213mm H 18mm Qty pcs for GFR2700/GRE2700				
For models: GFR2700, GRE2700				
accessories for 696783				
	Part No.	699576	Ref. No.	81131203
cover for drain pan L 598mm W 218mm H 42mm for GFR2700/GRE2700				

1

Part No.	698877	Ref. No.	LCCCK0001
description	shelf support L 26.5mm W 8.5mm H 40mm aluminium		
For models:	GSC1100G, GSC2336		

for display coolers

control parts



1

Part No.	692700	Ref. No.	1.1.C.C12.07
description	door handle L 100mm W 32mm hole distance 68mm black Qty 1 pcs		
For models:	GGC2270B		



1

Part No.	692409	Ref. No.	1.1.C.C12.06
description	door handle L 100mm W 32mm hole distance 68mm white		
For models:	GGC2270		



1

Part No.	692402	Ref. No.	1.1.C.C12.14
description	handle grey for vitrine H 9.5mm L 85mm W 25mm mounting distance 70mm Qty 1 pcs		
For models:	GGC1078		



1

Part No.	692401	Ref. No.	1.1.C.C23.01
description	knob ø 27mm grey zero mark shaft ø 6x4.6mm shaft flat left for thermostat to clip Qty 1		
For models:	GGC1078, GGC1078B		

spare parts and accessories



1

Part No.	699422	Ref. No.	1.1.C.C63.61
description	clip for dryer L 90mm W 20mm H 52mm plastic Qty 1 pcs		
For models:	GCV1600		

housing and bezels

fascias



1

Part No.	692411	Ref. No.	1.1.C.C40.02
description	base plate for evaporator L 305mm W 241mm thickness 1.5mm plastic Qty 1 pcs		
For models:	GGC2270, GGC2270B		



1

Part No.	692405	Ref. No.	1.1.C.C22.08
description	control panel for vitrine temperature MIN/MAX W 130mm D 23mm H 145mm plastic Qty 1 pcs		
For models:	GGC1078, GGC1078B		



1

Part No.	699410	Ref. No.	1.1.C.C15.03.35
description	front panel mounting pos. front W 518mm D 35mm H 440mm black		
For models:	GGC2270B		



1

Part No.	699409	Ref. No.	1.1.C.C15.03.03
description	front panel mounting pos. front W 518mm D 35mm H 440mm white		
For models:	GGC2270		



1

Part No.	699401	Ref. No.	S24AC21A0001
description	front panel mounting pos. front W 865mm D 15mm H 248mm		
For models:	GDS2600, GPS2600, GSA2600, GSD2600, GSF2600		



1

Part No.	698854	Ref. No.	1.1.C.C15.01.02
description	front panel mounting pos. in the front/at the back black W 427mm D 33mm H 190mm plastic Qty 1 pcs for vitrine		
For models:	GGC1078B		



1

Part No.	692417	Ref. No.	1.1.C.C21.01
description	housing for control W 130mm D 75mm H 145mm plastic Qty 1 pcs		
For models:	GGC1078, GGC1078B		



1

Part No.	699415	Ref. No.	1.1.C.C02.02
description	lamp cover W 310mm D 5mm H 172mm black		
For models:	GGC1078, GGC1078B, GGC2270B		



1

Part No.	699414	Ref. No.	1.1.C.C02.01
description	lamp cover W 310mm D 5mm H 172mm white		
For models:	GGC2270		



1

Part No.	699407	Ref. No.	S24AC20A0005
description	sheet mounting pos. upper for door W 890mm D 115mm H 10mm		
For models:	GDS2600, GPS2600, GSA2600, GSD2600, GSF2600		

lids



1

Part No.	699403	Ref. No.	S24AC50A0003
description	top for display refrigerator W 910mm D 705mm H 125mm		
For models:	GSD2600		

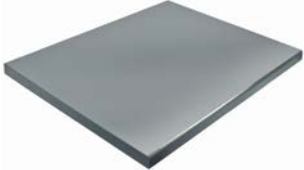

1

Part No.	699404	Ref. No.	S24AC30A0003
description	top for display refrigerator W 910mm D 705mm H 55mm		
For models:	GDS2600, GSF2600		

housings



1

Part No.	698851	Ref. No.	1.1.C.C15.01.06
description	back panel for vitrine W 515mm D 45mm H 410mm black		
For models:	GGC2270B		



1

Part No.	692269	Ref. No.	1.1.C.C15.01.05
description	back panel for vitrine W 515mm D 45mm H 410mm white		
For models:	GGC2270		

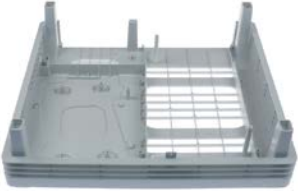
1

Part No.	692416	Ref. No.	1.1.C.C25.15
description	bottom for vitrine W 378mm H 115mm L 425mm Qty 1 pcs		
For models:	GGC1078		



1

Part No.	692419	Ref. No.	1.1.C.C01.15
description	casing cover for display refrigerator W 425mm L 380mm plastic Qty 1 pcs white		
For models:	GGC1078		
accessories for	692419		
	Part No.	Ref. No.	—
	692414		
	lid L 313mm W 163mm for lighting Qty 1 pcs		



1

Part No.	692437	Ref. No.	1.1.C.C22.07
description	casing cover W 130mm D 70mm H 6mm plastic Qty 1 pcs		
For models:	GGC2270, GGC2270B		



1

Part No.	692420	Ref. No.	1.1.B.B05.02
description	cover for condenser W 365mm D 220mm H 130mm plate Qty 1 pcs		
For models:	GGC1078, GGC1078B		



1

Part No.	692422	Ref. No.	1.1.C.C16.02
description	cover for evaporator W 280mm D 345mm H 35mm plastic Qty 1 pcs		
For models:	GGC1078, GGC1078B		



1

Part No.	692403	Ref. No.	1.1.C.C15.01.01
description	front panel mounting pos. front for vitrine W 427mm D 33mm H 190mm plastic Qty 1 pcs white		
For models:	GGC1078		



1

Part No.	698860	Ref. No.	1.1.C.C56.84
description	guide mounting pos. front for side part W 23mm D 30mm H 635mm Qty 1 pcs		
For models:	GGC1078B		



1

Part No.	698861	Ref. No.	1.1.C.C56.85
description	guide mounting pos. rear for side part W 30mm D 30mm H 635mm Qty 1 pcs		
For models:	GGC1078B		



1

Part No.	699175	Ref. No.	P04AC21A0003
description	housing for control part W 200mm D 115mm H 95mm		
For models:	GDS2600, GPS2600, GSA2600, GSD2600, GSF2600		



1

Part No.	692415	Ref. No.	1.1.C.C18.04
description	housing for evaporator W 370mm H 175mm L 420mm Qty 1 pcs		
For models:	GGC1078, GGC1078B		



1

Part No.	699323	Ref. No.	VRX1560.2
description	housing for switch W 114mm D 68mm H 100mm		
For models:	GHS1600, GHS2600		



1

Part No.	692436	Ref. No.	1.1.C.C21.03
description	housing W 128mm D 65mm H 38mm plastic Qty 1 pcs		
For models:	GGC2270, GGC2270B		



1

Part No.	692270	Ref. No.	1.1.C.C15.03.08 1.1.C.C15.03.09
description	side panel W 418mm H 410mm plastic white		
For models:	GGC2270		

ventilation grilles



1

Part No.	698855	Ref. No.	1.1.C.C14.02
description	cover for fan W 425mm D 380mm H 36mm plastic Qty 1 pcs black		
For models:	GGC1078B		



1

Part No.	699411	Ref. No.	1.1.C.C14.01
description	cover for fan W 425mm D 380mm H 36mm plastic Qty 1 pcs white		
For models:	GGC1078		



1

Part No.	698853	Ref. No.	1.1.C.C26.02
description	grid mounting pos. lower for ventilation W 350mm D 12mm H 57mm plastic Qty 1 pcs black		
For models:	GGC1078B		



1

Part No.	699417	Ref. No.	1.1.C.C26.01
description	grid mounting pos. lower for ventilation W 350mm D 12mm H 57mm plastic Qty 1 pcs white		
For models:	GGC1078		



1

Part No.	701253	Ref. No.	1.1.C.C49.09
description	ventilation grille for air fan plastic black H 50mm L 620mm Qty 1 pcs		
For models:	GCV1600		



1

Part No.	701254	Ref. No.	1.1.C.C49.10
description	ventilation grille for aspiration plastic black H 50mm L 260mm Qty 1 pcs		
For models:	GCV1600		

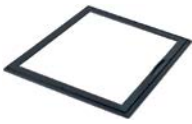

frame			
			
1			
Part No.	699412	Ref. No.	1.1.C.C63.14
description	door frame inner W 378mm D 10mm H 385mm		
For models:	GCV1600		

			
1			
Part No.	699413	Ref. No.	1.1.C.C63.13
description	door frame outer W 375mm D 10mm H 375mm		
For models:	GCV1600		

side parts			
			
1			
Part No.	698862	Ref. No.	1.1.C.C38.19
description	side panel for door L 590mm thickness 17mm		
For models:	GGC1078B		

			
1			
Part No.	698852	Ref. No.	1.1.C.C15.02.02
description	side panel mounting pos. left/right black W 316mm D 13.5mm H 190mm plastic Qty 1 pcs for vitrine		
For models:	GGC1078B		

			
1			
Part No.	692404	Ref. No.	1.1.C.C15.02.01
description	side panel mounting pos. left/right white W 316mm D 13.5mm H 190mm plastic Qty 1 pcs for vitrine		
For models:	GGC1078		

			
1			
Part No.	699444	Ref. No.	1.1.C.C56.06
description	side panel mounting pos. vertical W 40mm D 40mm H 1370mm black		
For models:	GGC2270B		

			
1			
Part No.	699443	Ref. No.	1.1.C.C56.03
description	side panel mounting pos. vertical W 40mm D 40mm H 1370mm white		
For models:	GGC2270		

			
1			
Part No.	699324	Ref. No.	VRX38.12
description	side panel W 390mm D 40mm H 222mm		
For models:	GHS1600, GHS2600		

			
1			
Part No.	698850	Ref. No.	1.1.C.C15.03.10
description	side panel W 418mm H 410mm plastic black		
For models:	GGC2270B		

miscellaneous			
			
1			
Part No.	699427	Ref. No.	1.1.C.C03.01
description	blank H 5mm ø 12mm		
For models:	GGC1078, GGC2270		

			
1			
Part No.	699428	Ref. No.	1.1.C.C03.02
description	blank H 5mm ø 12mm		
For models:	GGC1078B, GGC2270B		

			
1			
Part No.	692369	Ref. No.	1.1.C.C63.71
description	bracket for thermometer W 81mm H 41mm plastic Qty 1 pcs		
For models:	GCV1600		



Part No.	692410	Ref. No.	1.1.C.C09.01
description	cover for lighting mounting pos. inner L 230mm W 84mm H 2.5mm plastic Qty 1 pcs		
For models:	GGC1078, GGC1078B, GGC2270, GGC2270B		



Part No.	699315	Ref. No.	SLZE0042
description	fixing plate for evaporator L 55mm W 27mm H 6mm		
For models:	GBC1001, GBC1001S, GBC1001SS, GBC1002, GBC1002S, GBC1002SS, GBC1003, GBC1003S, GBC1003SS, GBC1102, GBC1103		



Part No.	692370	Ref. No.	1.1.C.C63.70
description	rail for gasket L 740mm W 42mm H 19mm plastic Qty 1 pcs		
For models:	GCV1600		

glass panels

glass panels

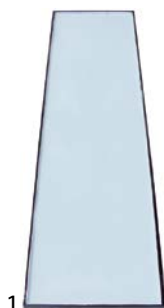

Part No.	692293	Ref. No.	1.1.E.E2.02.44
description	glass panel L 1392mm W 376mm thickness 10mm flat mounting pos. lateral for display refrigerator		
For models:	GGC2270, GGC2270B		

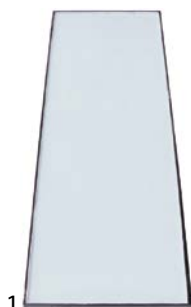

Part No.	699328	Ref. No.	1.1.E.E2.02.45
description	glass panel L 1395mm W 464mm thickness 17.5mm mounting pos. rear refrigerated show case GGC2270		
For models:	GGC2270, GGC2270B		



Part No.	699330	Ref. No.	1.1.E.E2.02.76
description	glass panel L 360mm W 357mm thickness 10.5mm for door GCV1600		
For models:	GCV1600		

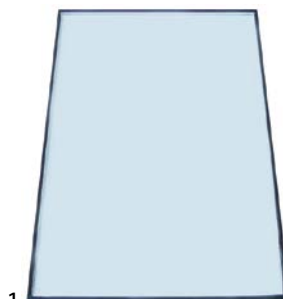

Part No.	692291	Ref. No.	1.1.E.E2.02.64
description	glass panel L 635mm W 390mm thickness 10mm flat mounting pos. door for display refrigerator		
For models:	GGC1078, GGC1078B		



Part No.	699326	Ref. No.	1.1.E.E2.02.74
description	glass panel L 645mm W 595mm H 16mm thickness 8mm mounting pos. left for display refrigerator GCV1600		
For models:	GCV1600		



Part No.	699327	Ref. No.	1.1.E.E2.02.75
description	glass panel L 645mm W 595mm H 16mm thickness 8mm mounting pos. right for display refrigerator GCV1600		
For models:	GCV1600		



1

Part No.	692292	Ref. No.	1.1.E.E2.02.12
description	glass panel L 655mm W 390mm thickness 10mm flat mounting pos. rear for display refrigerator		
For models:	GGC1078, GGC1078B		

1

Part No.	692290	Ref. No.	1.1.E.E2.02.11
description	glass panel L 660mm W 332mm thickness 10mm flat mounting pos. lateral for fridge		
For models:	GGC1078, GGC1078B		

1

Part No.	699329	Ref. No.	1.1.E.E2.04.15.A0
description	glass panel L 773mm W 710mm thickness 12mm mounting pos. front-side for display refrigerator GCV1600		
For models:	GCV1600		

1

Part No.	692289	Ref. No.	1.1.E.E2.02.65
description	glass panel W 460mm H 1360mm thickness 17mm curved for fridge		
For models:	GGC2270, GGC2270B		

accessories

1

Part No.	699431	Ref. No.	1.1.B.B14.05
description	rail L 775mm		
For models:	GCV1600		

doors

1

Part No.	699176	Ref. No.	S24AC22A0001-LEFT
description	door L 515mm W 425mm H 55mm mounting pos. left		
For models:	GPS2600, GSA2600, GSD2600, GSF2600		

1

Part No.	699177	Ref. No.	S24AC22A0001-RIGHT
description	door L 515mm W 425mm H 55mm mounting pos. right		
For models:	GPS2600, GSA2600, GSD2600, GSF2600		

1

Part No.	698859	Ref. No.	1.1.C.C11.02
description	door frame L 425mm W 15mm H 28mm mounting pos. upper/lower		
For models:	GGC1078B		



1

Part No.	699378	Ref. No.	BLGM9H02
description	glass door W 440mm H 770mm with catch mounting pos. right D 25mm		



1

Part No.	699379	Ref. No.	BLGM9H01
description	glass door W 440mm H 770mm with rollers D 25mm d 8mm delivery freight forwarding company only		



1

Part No.	699380	Ref. No.	BLGM9H00 GBC1001-44
description	glass door W 600mm H 800mm D 30mm		



1

Part No.	699405	Ref. No.	S24AC50A0004
description	shelf L 255mm W 890mm H 30mm stainless steel		
For models:	GSD2600		

door mechanics

bolts



1

Part No.	699424	Ref. No.	1.1.B.B09.03
description	door bolt H 7mm W 7mm L 20.5mm mounting pos. upper		
For models:	GGC1078, GGC1078B		

bushes



1

Part No.	699430	Ref. No.	1.1.C.C13.02
description	bush H 15mm ø 10mm		
For models:	GGC1078B, GGC2270, GGC2270B		

miscellaneous



1

Part No.	694928	Ref. No.	WJCX0000
description	door magnet L 46mm W 16mm H 14.5mm		
For models:	GBC1102, GBC1103		



1

Part No.	694929	Ref. No.	WJCXG000
description	plate for magnet L 45mm W 12mm H 1.5mm mounting distance 32mm		
For models:	GBC1102, GBC1103		



for pyroceram ranges

ceramic hobs

ceramic glass plates

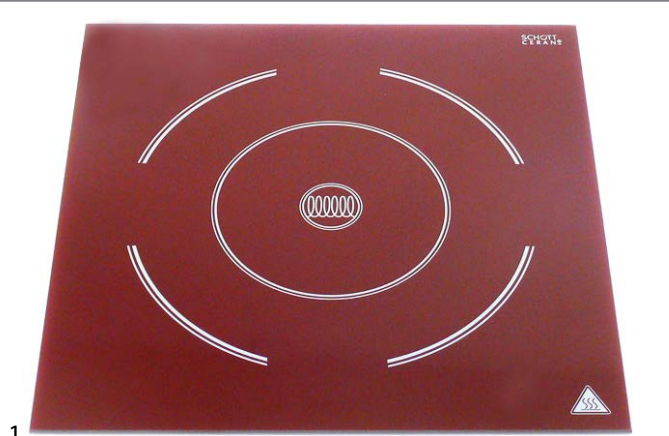

Part No.	694579	Ref. No.	MBF000032R
description	ceramic plate L 300mm W 300mm thickness 4mm		
For models:	GIC3035		

for deep fryers

fasteners



Part No.	692544	Ref. No.	2.02HDF4260701
description	mounting strap L 63mm W 25mm H 15mm		
For models:	GDF3024, GDF3028, GDF5028		

lids



Part No.	698544	Ref. No.	3.CP0603070100
description	mushroom cap handle handle ø 50mm ø 70mm L 36mm plastic black		
For models:	GDF3004, GDF3008, GDF3024, GDF3028, GDF5008, GDF5028		

miscellaneous



Part No.	694737	Ref. No.	2.02HDF8A130001
description	bezel plate L 63mm H 15mm ID ø 26mm		
For models:	GDF5008, GDF5028		



Part No.	699212	Ref. No.	2.HDF8A460201
description	pipe stainless steel L 30mm W 13mm thread M5		
For models:	GDF5008, GDF5028		

for convection ovens/combi-steamers



Part No.	692843	Ref. No.	00004380
description	spacer bush ID ø 7mm H 7.5mm ED ø 17.5mm for glass plate white Spacer		
For models:	GCO2001		

spare parts and accessories



Part No.	693043	Ref. No.	F02005
description	guard		
For models:	GTO1001, GTO2001		



glass panels



Part No.	694950	Ref. No.	VET30017
description	door glass for combi-steamer L 485mm mounting pos. inner W 415mm thickness 4mm		
For models:	GCO500		



Part No.	694951	Ref. No.	VET05021
description	door glass for combi-steamer L 555mm mounting pos. outer W 425mm thickness 4mm		
For models:	GCO500		

			
1			
Part No.	692841	Ref. No.	21100870
description	glass panel L 447mm mounting pos. inner W 585mm		
For models:	GCO2001		
accessories for	692841		
	Part No.	692842	Ref. No. 21100880
	glass panel L 450mm mounting pos. outer W 590mm		
	Part No.	692843	Ref. No. 00004380
	spacer bush ID ø 7mm H 7.5mm ED ø 17.5mm for glass plate white Spacer		

for hot dog machines

lids

			
1			
Part No.	694450	Ref. No.	F05051
description	lid for hot dog machine ø 205mm		
For models:	GHM1001		

glass cylinders

			
1			
Part No.	693002	Ref. No.	F05009
description	glass cylinder ø 200mm Pyrex glass H 240mm		
For models:	GHM1001		

skewers

			
1			
Part No.	693018	Ref. No.	F05010
description	bun spikes for hot dog machine		
For models:	GHM1001		

water containers

			
1			
Part No.	693005	Ref. No.	F05022
description	water container for hot dog machine PTFE/aluminium		
For models:	GHM1001		

for induction devices

			
1			
Part No.	970790	Ref. No.	AB600022
description	grease filter W 323mm H 144mm thickness 8mm SS layers 2 outer grids 1 inner grids 1 for induction device		
For models:	GIC3035		

			
1			
Part No.	692842	Ref. No.	21100880
description	glass panel L 450mm mounting pos. outer W 590mm		
For models:	GCO2001		
accessories for	692842		
	Part No.	692841	Ref. No. 21100870
	glass panel L 447mm mounting pos. inner W 585mm		
	Part No.	692843	Ref. No. 00004380
	spacer bush ID ø 7mm H 7.5mm ED ø 17.5mm for glass plate white Spacer		
	Part No.	694993	Ref. No. 00011680
	door handle ø 18mm L 350mm stainless steel M5 black matt		

Fans - accessories

			
1			
Part No.	701630	Ref. No.	00012330
description	air duct for cross flow fan for combi-steamer plastic grey		
For models:	GCO2001		



for tilting bratt pans

miscellaneous



1

Part No.	523510	Ref. No.	00000000860
description	deep-groove ball bearing type 6202-2RS shaft ø 15mm ED ø 35mm W 11mm with sealing discs deep-groove ball bearing DIN 625-1		
For models:	GFS1025, GFS2019, GFS2022, GFS2025, GFS2030		

for microwaves

electric

line filters

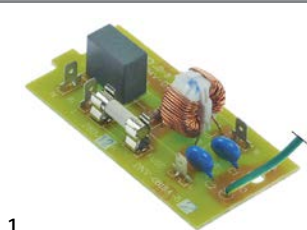

1

Part No.	403188	Ref. No.	263029001088
description	line filter microwave for GMW1025 250V 50/60Hz conductor 2 PCB connection male faston 4.8mm L 80mm H 20mm W 40mm PCB Qty 1 pcs cable length 120mm type DNV-0818A-5		
For models:	GMW1025		

ceramic plates

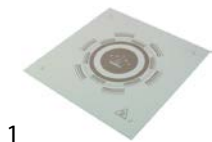

1

Part No.	692350	Ref. No.	243999000108	
description	ceramic plate L 330mm W 335mm for microwave thickness 3.5mm GMW1025 Qty 1 pcs			
For models:	GMW1025			
accessories for	692350			
	Part No.	901698	Ref. No.	593219000016
	gasket L 330mm W 325mm silicone for ceramic plate Qty 1 pcs			

miscellaneous



1

Part No.	601869	Ref. No.	213149000023
description	bracket L 78mm W 20mm H 50mm for condenser Qty 1 pcs		
For models:	GMW1025		

doors

films



1

Part No.	692451	Ref. No.	515059000119
description	film L 287mm W 159mm for door inside thickness 0.1mm transparent suitable for GALANZ plastic Qty 1 pcs		
For models:	GMW1025		

for ovens

housing and bezels



1

Part No.	692763	Ref. No.	DEF30123
description	cover for hot air oven L 320mm W 325mm H 62mm		
For models:	GCO500		

for saladettes

housing and bezels



1

Part No.	692692	Ref. No.	KITSR4AC2A00
description	bridge L 168/330/534mm 6 pieces		
For models:	GSA2600		



			
1			
Part No.	692691	Ref. No.	KITSR4AC4A00
description	bridge set 2-piece for saladette W 25mm D 184mm H 11mm		
For models:	GPS2600, GSD2600		

			
1			
Part No.	993263	Ref. No.	P04AC20A0006
description	cutting board L 950mm W 130mm H 20mm		
For models:	GSA2600		

			
1			
Part No.	692257	Ref. No.	VRX.01 VRX.02 VRX.04 VRX.05 VRX.06 VRX33-38
description	mounting set for glass plate for saladette 53-piece Qty 1 pcs 6x mounting clip 7x angle 12x flat-headed bolt 14x bush 14x screw connection		
For models:	GHS1600, GHS2600		

doors			
			
1			
Part No.	701546	Ref. No.	S24AC22A0006
description	door bolt L 28mm mounting pos. upper thread L 8mmmm		
For models:	GPS2600, GSA2600, GSD2600, GSF2600		

for salamander grills

			
1			
Part No.	692240	Ref. No.	30045
description	drain tray for salamander grill L 350mm W 245mm		
For models:	GTO1001, GTO2001		

for dishwashers

boilers

boilers for dishwashers

			
1			
Part No.	508429	Ref. No.	900384
description	boiler 3500W 230V ø 127mm L 400mm		
For models:	GDW2001		

air traps

air traps

			
1			
Part No.	519643	Ref. No.	905262
description	air trap L 91mm W 54mm H 41mm hose ø 4x7mm plastic		
For models:	GDW2001		

air trap accessories

			
1			
Part No.	519162	Ref. No.	904131
description	spring		
For models:	GDW2001		



backflow preventers

backflow preventers



1

Part No.	516101	Ref. No.	TR2433
description	backflow preventer dishwasher hose ø 12mm		
For models:	GDW2001		
spare parts for	516101		
	Part No.	Ref. No.	—
	506367		
	flat gasket rubber ED ø 40mm ID ø 28mm thickness 1.8mm Qty 1 pcs		

door mechanics

linkage



1

Part No.	519261	Ref. No.	902740
description	door pin tie bar		
For models:	GDW2001		

threaded shafts



1

Part No.	519228	Ref. No.	905424
description	threaded part end stop		
For models:	GDW2001		

sliding plates



1

Part No.	519208	Ref. No.	904952
description	sliding plate sliding plate		
For models:	GDW2001		

hinges



1

Part No.	519035	Ref. No.	901245
description	door hinge bores 3 hinge		
For models:	GDW2001		

hinge pins



1

Part No.	519204	Ref. No.	904795
description	hinge pin hinge pin		
For models:	GDW2001		

locks



1

Part No.	519247	Ref. No.	906121
description	door catch door locking catch		
For models:	GDW2001		
accessories for	519247		
	Part No.	Ref. No.	—
	519050		
	nut thread M12x1.75 H 4mm WS 16 SS Qty 1 pcs for snap lock		

screw connections



1

Part No.	519645	Ref. No.	902111
description	nut thread 3/8" H 14mm WS 24 plastic Qty 1 pcs		
For models:	GDW2001		

washing and rinsing systems



1

Part No.	501351	Ref. No.	908154
description	flange mounting pos. upper ø 91mm H 11mm ID ø 45mm hole ø 5.5mm		
For models:	GDW2001		



1

Part No.	519444	Ref. No.	905449
description	opposite support mounting pos. upper/lower for wash arm support suitable for Silanos		
For models:	GDW2001		
accessories for	519444		
	Part No.	Ref. No.	908141
	519445		
	gasket D1 ø 80mm D2 ø 50mm thickness 3mm with 4 screw holes		



			
1			
Part No.	519238	Ref. No.	906002
description	plain washer ID ø 15mm ED ø 33mm thickness 0.8mm SS Qty 1 pcs		
For models:	GDW2001		

			
1			
Part No.	501349	Ref. No.	908456
description	reducer for rinse arm shaft		
For models:	GDW2001		

			
1			
Part No.	517355	Ref. No.	908702
description	spacer piece for wash arm support ID ø 44mm ED ø 80mm thickness 18mm L 55mm plastic		
For models:	GDW2001		

			
1			
Part No.	519085	Ref. No.	902880
description	Thumb screw ø 34mm thread M6		
For models:	GDW2001		

			
1			
Part No.	519537	Ref. No.	908701
description	wash pipe ø 37mm L 720mm plastic suitable for Silanos		
For models:	GDW2001		

for toasters

spare parts and accessories

			
1			
Part No.	693043	Ref. No.	F02005
description	guard		
For models:	GTO1001, GTO2001		

miscellaneous

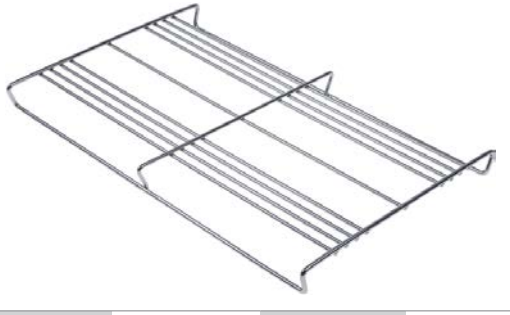
			
1			
Part No.	694449	Ref. No.	F01069
description	guard L 315mm W 200mm for toaster H 24mm		
For models:	GTO1001, GTO2001		

knobs

universal knobs

			
1			
Part No.	112733	Ref. No.	3ZCK165BT19010101MGB
description	knob zero mark t.max.°C ø 55mm shaft ø 6x4.6mm shaft flat upper black		
For models:	GDF3004, GDF3008, GDF3024, GDF3028, GDF5008, GDF5028		

miscellaneous

			
1			
Part No.	696506	Ref. No.	2858
description	knob for PCB ø 26mm black Qty 1 pcs		
For models:	GSM1000		

accessories

rosettes

			
1			
Part No.	111806	Ref. No.	3.ZCK165BT20010101-1
description	rosette knob ø 16mm ø 55mm		
For models:	GDF3004, GDF3008, GDF3024, GDF3028, GDF5008, GDF5028		



handles and hand wheels

mushroom cap handles



1

Part No.	697445	Ref. No.	0000000677
description	mushroom cap handle thread M6 handle ø 33mm L 26mm plastic black		
For models:	GFS2030		



1

Part No.	698641	Ref. No.	0000001111
description	mushroom cap handle thread M6 handle ø 34mm L 25mm aluminium		
For models:	GFS1030		

handle bars

producer-specific handle rails

TECNOEKA



1

Part No.	694993	Ref. No.	00011680
description	door handle ø 18mm L 350mm stainless steel M5 black matt		
For models:	GCO2001		

handle rails

handle rails



1

Part No.	699449	Ref. No.	SLZB0020
description	handle rail for fridge L 220mm W 36mm H 23mm grey hole distance 120mm		
For models:	GSC2336		

miscellaneous



1

Part No.	692409	Ref. No.	1.1.C.C12.06
description	door handle L 100mm W 32mm hole distance 68mm white		
For models:	GGC2270		



1

Part No.	698858	Ref. No.	1.1.C.C12.15
description	handle black for vitrine H 9.5mm L 85mm W 25mm mounting distance 70mm Qty 1 pcs		
For models:	GGC1078B		



1

Part No.	692402	Ref. No.	1.1.C.C12.14
description	handle grey for vitrine H 9.5mm L 85mm W 25mm mounting distance 70mm Qty 1 pcs		
For models:	GGC1078		



1

Part No.	691960	Ref. No.	A15015
description	handle L 100mm W 32mm hole distance 70mm for lid		
For models:	GTO1001, GTO2001		



1

Part No.	110921	Ref. No.	A15016
description	handle L 130mm W 39mm hole distance 91mm Qty 1 pcs		
For models:	GHM1001		



			
1			
Part No.	692545	Ref. No.	3.HDF409010101
description	handle L 96mm W 64mm hole distance 73mm mounting pos. side panel black		
For models:	GDF3004, GDF3024		

locks

locking devices

producer-specific

WEIBO

			
1			
Part No.	692878	Ref. No.	W0604007
description	key cylinder rotation 90° cam length 45mm cam width 14mm for GFR2700/GRE2700 with 2 keys		
For models:	GFR2700, GRE2700		

snap locks



producer-specific



METRO

			
1			
Part No.	692397	Ref. No.	WJLD1001
description	roller L 50mm mounting distance 32mm plastic Qty 1 pcs		

hinges

oven hinges

				
1				
Part No.	701631	Ref. No.	00014600	
description	opposite support mounting distance 119mm L 135mm W 12mm			
For models:	GCO2001			
accessories for	701631			
	Part No.	701573	Ref. No.	00014610
	oven hinge mounting distance 142mm mounting distance 2mm lug mountingmm lever lengthmm groove distance 12mm spring thickness 3.3mm mounting ear position spring length 116mm L 170mm mounting pos. left/right W 22mm			

				
1				
Part No.	701573	Ref. No.	00014610	
description	oven hinge mounting distance 142mm mounting distance 2mm lug mountingmm lever lengthmm groove distance 12mm spring thickness 3.3mm mounting ear position spring length 116mm L 170mm mounting pos. left/right W 22mm			
For models:	GCO2001			
accessories for	701573			
	Part No.	701631	Ref. No.	00014600
	opposite support mounting distance 119mm L 135mm W 12mm			

			
1			
Part No.	701592	Ref. No.	CER30021 STA00028
description	oven hinge set mounting distance 140mm lever length 42mm groove distance 15mm spring thickness 2.9mm L 170mm mounting pos. left/right with opposite support Qty 2 pcs		
For models:	GCO500		





door bearing

 <p>1</p>			
Part No.	692406	Ref. No.	1.1.B.B10.17
description	bolt H 16.5mm ø 10/14mm ID ø 7mm brass for door hinge Qty 1 pcs		
For models:	GGC2270, GGC2270B		

 <p>1</p>			
Part No.	701562	Ref. No.	44447000
description	bolt L 36mm W 22mm thread M6 bolt 12mm bolt ø 12mm		
For models:	GFR3600S, GRE3600, GRE3600S		

 <p>1</p>			
Part No.	692421	Ref. No.	1.1.C.C13.01
description	bush H 15mm ø 10/13mm ID ø 7mm plastic for door hinge Qty 1 pcs		
For models:	GGC1078, GGC2270, GGC2270B		

 <p>1</p>			
Part No.	701567	Ref. No.	41649000
description	bush L 11mm ø 11/15mm thickness 2mm		
For models:	GFR3600S, GRE3600, GRE3600S		

 <p>1</p>			
Part No.	701572	Ref. No.	10534002
description	bush ø 18.5mm ID ø 12mm		
For models:	GFR3600S		

 <p>1</p>			
Part No.	701280	Ref. No.	WJMA4002
description	door hinge L 42mm W 33mm H 82mm mounting pos. bottom right/left set Qty 1 pcs		
For models:	GSC1100G		

 <p>1</p>			
Part No.	701281	Ref. No.	WJMA4005
description	door hinge L 43mm W 82mm H 71mm mounting pos. upper right/left set Qty 1 pcs		
For models:	GSC1100G		



 <p>1</p>			
Part No.	698866	Ref. No.	GPC1046-12 GPC1088-13
description	door hinge L 90mm W 40mm H 19mm mounting pos. lower bolt 13mm bolt ø 10.5mm		
For models:	GPC1046, GPC1088		



 <p>1</p>			
Part No.	698863	Ref. No.	GPC1046-04 GPC1088-05
description	door hinge L 90mm W 40mm H 19mm mounting pos. upper bolt 13mm bolt ø 10.5mm		
For models:	GPC1046, GPC1088		

 <p>1</p>			
Part No.	701564	Ref. No.	46996000
description	hinge L 130mm W 85mm H 38mm mounting distance 48mm mounting distance 2 33mm thread M6 ø 8mm bolt 13mm bolt ø 8mm		
For models:	GRE3600		

 <p>1</p>			
Part No.	692690	Ref. No.	S24AC22A0003
description	hinge L 40mm W 70mm H 22mm mounting distance 2 20mm		
For models:	GPS2600, GSA2600, GSD2600, GSF2600		





			
1			
Part No.	699587	Ref. No.	W0604033
description	hinge L 87mm W 46mm mounting pos. upper right thickness 3.6mm bolt 46mm bolt ø 10.5mm for GFR2700/GRE2700		
For models:	GFR2700, GRE2700		
accessories for	699587		
	Part No.	699588	Ref. No. W0604037
	hinge L 88mm W 50mm mounting pos. bottom right thickness 3.6mm bolt 29mm bolt ø 11mm for GFR2700/GRE2700		

			
1			
Part No.	699588	Ref. No.	W0604037
description	hinge L 88mm W 50mm mounting pos. bottom right thickness 3.6mm bolt 29mm bolt ø 11mm for GFR2700/GRE2700		
For models:	GFR2700, GRE2700		
spare parts for	699588		
	Part No.	699568	Ref. No. W0604038
	base plate for door hinge mounting pos. lower L 35mm W 25mm for GFR2700/GRE2700		
accessories for	699588		
	Part No.	699587	Ref. No. W0604033
	hinge L 87mm W 46mm mounting pos. upper right thickness 3.6mm bolt 46mm bolt ø 10.5mm for GFR2700/GRE2700		

			
1			
Part No.	701563	Ref. No.	43870000
description	hinge L 98mm W 48mm H 38mm mounting distance 40mm mounting distance 2 20mm thread M6		
For models:	GFR3600S, GRE3600, GRE3600S		

			
1			
Part No.	694866	Ref. No.	WJMA2003
description	hinge mounting pos. lower L 82mm W 53mm H 43mm mounting distance 30mm mounting distance 2 56mm thickness 4mm bolt 20mm bolt ø 7mm		
For models:	GSC2336		

			
1			
Part No.	694865	Ref. No.	WJMA0004
description	hinge mounting pos. upper L 50mm W 33mm H 42mm mounting distance 27mm thickness 3mm bolt 32.5mm bolt ø 9mm Qty 1kg		
For models:	GSC2336		

			
1			
Part No.	699419	Ref. No.	1.1.B.B09.01
description	hinge bearing L 55mm W 15mm H 14mm mounting distance 26mm mounting pos. upper		
For models:	GGC1078, GGC1078B		

			
1			
Part No.	701565	Ref. No.	48205000
description	hinge bearing L 72mm W 39mm H 30mm mounting distance 25mm mounting distance 2 25mm mounting pos. left		
For models:	GRE3600		

			
1			
Part No.	701566	Ref. No.	46997000
description	hinge bearing L 72mm W 39mm H 30mm mounting distance 25mm mounting distance 2 25mm mounting pos. right		
For models:	GRE3600		

			
1			
Part No.	699423	Ref. No.	1.1.B.B09.17
description	hinge bearing L 85mm W 17mm H 17mm mounting distance 48mm mounting pos. upper		
For models:	GGC2270, GGC2270B		



accessories

bushes



1

Part No.	701642	Ref. No.	W0409843
description	bush lower for door hinge ID ø 11mm ED ø 13mm L 26mm for GFR2700/GRE2700		
For models:	GFR2700, GRE2700		



1

Part No.	701641	Ref. No.	W0409842
description	bush upper for door hinge ID ø 11mm ED ø 13mm L 29.5mm for GFR2700/GRE2700		
For models:	GFR2700, GRE2700		

base plate



1

Part No.	699568	Ref. No.	W0604038
description	base plate for door hinge mounting pos. lower L 35mm W 25mm for GFR2700/GRE2700		
For models:	GFR2700, GRE2700		



1

Part No.	699569	Ref. No.	W0604030
description	base plate for door hinge mounting pos. right L 74mm W 42mm for GFR2700/GRE2700		
For models:	GFR2700, GRE2700		

filters

accessories

fastening material



1

Part No.	694581	Ref. No.	WJB000079R
description	frame L 317mm W 170mm H 9mm for filter		
For models:	GIC3035		

equipment feet and end caps

equipment feet

with screw mounting



1

Part No.	701640	Ref. No.	W0409018
description	equipment foot tube ø 51mm plate size 70x70mm hole distance 50mm H 11,7-18mm Qty 1 pcs for GFR2700/GRE2700 adjustable		
For models:	GFR2700, GRE2700		

with fixing plate



1

Part No.	701640	Ref. No.	W0409018
description	equipment foot tube ø 51mm plate size 70x70mm hole distance 50mm H 11,7-18mm Qty 1 pcs for GFR2700/GRE2700 adjustable		
For models:	GFR2700, GRE2700		

screw-in feet



1

Part No.	701230	Ref. No.	900888
description	equipment feet kit thread M5 thread L 10mm ø 22mm H 12mm rubber WS Qty 4 pcs bore ø 5/10mm		
For models:	GJU1001		





1

Part No.	700972	Ref. No.	S900.13
description	equipment foot thread M10 thread L 16mm ø 29mm H 11.5mm Qty 1 pcs for fridge		
For models:	GHS1600, GHS2600		





			
1			
Part No.	701593	Ref. No.	PIE30010
description	equipment foot thread M10 thread L 18.5mm ø 49mm H 35mm plastic Qty 4 pcs		
For models:	GCO500		

			
1			
Part No.	701219	Ref. No.	AB300035
description	equipment foot thread M5 thread L 9mm ø 33mm H 34mm Qty 1 pcs		
For models:	GIC3035		

			
1			
Part No.	692235	Ref. No.	A13012
description	equipment foot thread M10 thread L 20mm ø 26mm H 6mm Qty 1 pcs		
For models:	GEG2001		

			
1			
Part No.	701220	Ref. No.	AB300055
description	equipment foot thread M6 thread L 20mm ø 33mm H 20mm WS 12 Qty 1 pcs		
For models:	GIC3035		

			
1			
Part No.	802156	Ref. No.	00002790
description	equipment foot thread M10 thread L 20mm ø 60mm H 50mm Qty 1 pcs		
For models:	GCO2001		

			
1			
Part No.	701279	Ref. No.	WJLB0008
description	equipment foot thread M8 thread L 22mm ø 35mm H 38mm Qty 1 pcs		

			
1			
Part No.	701112	Ref. No.	I0403014
description	equipment foot thread M10 thread L 43mm ø 29mm H 52mm plastic WS 35 Qty 1 pcs		
For models:	GRE3600, GRE3600S		

			
1			
Part No.	698495	Ref. No.	00000001251
description	equipment foot thread M8 thread L 9mm ø 48mm H 43mm conical aluminium WS Qty 1 pcs		
For models:	GFS1030		

bolting feet

			
1			
Part No.	701451	Ref. No.	00000001240
description	equipment foot thread M5 thread L 13mm ø 37.5mm H 25mm conical aluminium WS Qty 1 pcs bore ø 6mm		
For models:	GFS1025		

			
1			
Part No.	691814	Ref. No.	A13003
description	equipment foot ø 22mm H 20mm bore ø 4mm Qty 1 pcs		
For models:	GHM1001, GTO1001, GTO2001		



			
1			
Part No.	698546	Ref. No.	3.0000161
description	equipment foot ø 29mm H 16mm rubber bore ø 6mm Qty 1 pcs		
For models:	GDF3004, GDF3008, GDF3024, GDF3028, GDF5008, GDF5028		

			
1			
Part No.	697433	Ref. No.	00000000140 00000700140
description	equipment foot ø 35mm H 26mm bore ø 5mm Qty 1 pcs		
For models:	GFS1022, GFS2019, GFS2022, GFS2025, GFS2030		

equipment feet with stem

			
1			
Part No.	701251	Ref. No.	22318900015
description	equipment foot ø 20mm H 12mm mounting ø 8mm mounting measurements 19mm overall height 19mm plastic Qty 1 pcs		
For models:	GMW1025		

miscellaneous

with fixing plate

ø30mm

			
1			
Part No.	701277 ¹	Ref. No.	WJLA1001 WJLA1009
description	swivel castor 2 with & 2 without brake ø 30mm plate fixing housing zinc-plated sheet steel plate size 61x51mm hole distance mm capacity 60kg bearing slide bearing wheel body PVC tread PVC H 44mm wheel width 23.5mm		
For models:	GBC1001, GBC1001S, GBC1001SS, GBC1002, GBC1002S, GBC1002SS, GBC1003, GBC1003S, GBC1003SS, GBC1102, GBC1103, GSC2336		

¹with swivel brake

<p>ø75mm</p> 			
1			
Part No.	701282	Ref. No.	WJLA1002
description	swivel castor set 2 with & 2 without brake ø 75mm plates fixing 102x83mm housing zinc-plated sheet steel hole distance 55/75mm bearing slide bearing H 112mm wheel width 31mm Qty 4 pcs		
For models:	GSC1100G		

<p>with spigot</p>			
<p>ø40mm</p> 			
1			
Part No.	701120	Ref. No.	1.1.B.B10.95 1.1.B.B10.96
description	castor set 2 with & 2 without brake ø 40mm with thread bolt housing chrome-plated steel thread L 24mm thread ø M10x1.5mm capacity 60kg bearing ball bearing wheel body nylon tread nylon H 68mm wheel width 20mm Qty 4 pcs		
For models:	GGC2270, GGC2270B		

baskets

crumb screens

			
1			
Part No.	970869	Ref. No.	2.HDF405069510
description	crumb screen L 220mm W 160mm H 35mm 4 litre		
For models:	GDF3004, GDF3024		

			
1			
Part No.	970870	Ref. No.	2.HDF812020609510
description	crumb screen L 245mm W 200mm H 35mm 8 litre		
For models:	GDF3008, GDF3028, GDF5008, GDF5028		



wire baskets for hot dog machines



1

Part No.	693004	Ref. No.	F04012
description	grid basket for hot dog grill ø 180mm H 210mm		
For models:	GHM1001		



1

Part No.	970747	Ref. No.	F01070
description	grate W 350mm D 240mm H 7mm SS for toaster wire gauge frame 4mm lengthwise wires gauge 3mm crossing wires ROLLER GRILL		
For models:	GTO1001, GTO2001		

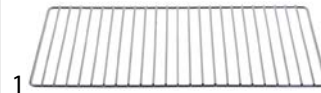

1

Part No.	970905	Ref. No.	GPC1046-13 GPC1088-14-half size
description	grate W 365mm D 165mm H 7mm wire gauge frame 4mm lengthwise wires gauge 3mm		
For models:	GPC1046, GPC1088		



1

Part No.	970906	Ref. No.	WJGA9005
description	grate W 400mm D 345mm chrome-plated steel wire gauge frame 6mm crossing wires 4		
For models:	GBC1002, GBC1002S, GBC1002SS, GBC1003, GBC1003S, GBC1102		

shelves and shelf rails

grates

universal

without upstand



1

Part No.	970801	Ref. No.	WJGA9008
description	grate W 345mm D 400mm chrome-plated steel wire gauge frame 6mm lengthwise wires gauge 2.5mm crossing wires 4 Qty 1 pcs		
For models:	GBC1003, GBC1003S, GBC1003SS, GBC1103		



1

Part No.	970800	Ref. No.	WJGA9002
description	grate W 345mm D 500mm chrome-plated steel wire gauge frame 6mm lengthwise wires gauge 2.5mm crossing wires 4 Qty 1 pcs		
For models:	GBC1001, GBC1001S, GBC1001SS		

with upstand



1

Part No.	970925	Ref. No.	S14AC29A0001
description	grate W 325mm D 570mm GN 1/1 H 55mm plastic-coated steel wire gauge frame 7.5mm lengthwise wires gauge 4mm crossing wires 3 grey		
For models:	GPS2600, GSA2600, GSD2600, GSF2600		



1



Part No.	970904	Ref. No.	GPC1088-14-full size
description	grate W 350mm D 295mm H 30mm chrome-plated steel wire gauge frame 4mm lengthwise wires gauge 2mm crossing wires 1 Qty 2 pcs		
For models:	GPC1088		





			
1			
Part No.	970795	Ref. No.	1.1.B.B25.15
description	grate W 735mm D 235mm H 37mm chrome-plated steel wire gauge frame 8mm lengthwise wires gauge 3mm crossing wires 1		
For models:	GCV1600		

			
1			
Part No.	970794	Ref. No.	1.1.B.B25.16
description	grate W 735mm D 365mm H 35mm chrome-plated steel wire gauge frame 8mm lengthwise wires gauge 3mm crossing wires 1		
For models:	GCV1600		

producer-specific

			
1			
Part No.	698856	Ref. No.	1.1.B.B02.01.03
description	grate W 360mm D 305mm plastic-coated steel		
For models:	GGC1078B		
accessories for	698856		
	Part No.	692400	Ref. No. 1.1.C.C10.07
	shelf support L 28.5mm W 14mm H 17.5mm plastic Qty 1 pcs		
	Part No.	698857	Ref. No. 1.1.C.C10.08
	shelf support L 28.5mm W 14mm H 17.5mm plastic Qty 1 pcs		

			
1			
Part No.	970876	Ref. No.	1.1.B.B02.01.01
description	grate W 360mm D 305mm plastic-coated steel		
For models:	GGC1078		

			
1			
Part No.	692696	Ref. No.	1.1.B.B02.04.02
description	grate W 430mm D 390mm H 8mm plastic-coated steel refrigeration wire gauge frame 8mm lengthwise wires gauge 3.6mm crossing wires 5 black		
For models:	GGC2270B		

			
1			
Part No.	692339	Ref. No.	1.1.B.B02.04.01
description	grate W 430mm D 390mm H 8mm plastic-coated steel refrigeration wire gauge frame 8mm lengthwise wires gauge 3.6mm crossing wires 5 white		
For models:	GGC2270		

			
1			
Part No.	970910	Ref. No.	WJGA2023
description	grate W 530mm D 380mm H 40mm plastic-coated steel wire gauge frame 6mm lengthwise wires gauge 3mm crossing wires 23		

			
1			
Part No.	970981	Ref. No.	W0402369
description	grate W 530mm D 650mm plastic-coated steel crossing wires 2 suitable for GFR2700		
For models:	GFR2700		

			
1			
Part No.	970799	Ref. No.	WJGA4078
description	grate W 540mm D 505mm H 41mm plastic-coated steel wire gauge frame 6mm lengthwise wires gauge 3mm crossing wires 3 white Qty 1 pcs		
For models:	GSC1100G		

			
1			
Part No.	970982	Ref. No.	W0402040
description	grate W 620mm D 530mm plastic-coated steel with hinge camp crossing wires 2 suitable for GRE2700		
For models:	GRE2700		

			
1			
Part No.	970980	Ref. No.	W0402366
description	grate W 630mm D 602mm plastic-coated steel crossing wires 2 suitable for GFR2700/GRE2700		
For models:	GFR2700, GRE2700		



1

Part No.	970930	Ref. No.	44714000
description	grate W 650mm D 330mm H 9mm wire gauge frame 7mm lengthwise wires gauge 3mm crossing wires 1		
For models:	GRE3600, GRE3600S		

1

Part No.	970929	Ref. No.	44379000
description	grate W 665mm D 560mm H 30mm wire gauge frame 7mm lengthwise wires gauge 3mm crossing wires 2		
For models:	GFR3600S, GRE3600, GRE3600S		

accessories

1

Part No.	691917	Ref. No.	F03006
description	grid handle L 204mm W 80mm		
For models:	GTO1001, GTO2001		

grid attachments

1

Part No.	692368	Ref. No.	1.1.B.B25.27
description	rack support L 220mm H 83mm mounting pos. bottom right SS Qty 1 pcs		
For models:	GCV1600		

1

Part No.	692365	Ref. No.	1.1.B.B25.28
description	rack support L 220mm H 83mm mounting pos. upper left SS Qty 1 pcs		
For models:	GCV1600		

1

Part No.	692366	Ref. No.	1.1.B.B25.29
description	rack support L 220mm H 83mm mounting pos. upper right SS Qty 1 pcs		
For models:	GCV1600		

1

Part No.	692367	Ref. No.	1.1.B.B25.26
description	rack support L 320mm H 83mm mounting pos. bottom left SS Qty 1 pcs		
For models:	GCV1600		

1

Part No.	701252	Ref. No.	1.1.B.B25.35
description	rail for grid attachment L 405mm H mm mounting pos. left/right W 19mm SS Qty 1 pcs		
For models:	GCV1600		

shelf rails and supports

producer-specific

1

Part No.	698870	Ref. No.	LCCJ2001
description	guide L 390mm W 25mm mounting pos. left/right inner height 4mm		
For models:	GBC1001, GBC1001S, GBC1001SS, GBC1002, GBC1002S, GBC1002SS, GBC1003, GBC1003S, GBC1003SS, GBC1102, GBC1103		

1

Part No.	701643	Ref. No.	80037407	
description	guide U-shape L 620mm W 15mm H 20mm mounting pos. left for GFR2700/GRE2700			
For models:	GFR2700, GRE2700			
accessories for	701643			
	Part No.	701644	Ref. No.	80037408
	guide U-shape L 620mm W 15mm H 20mm mounting pos. right for GFR2700/GRE2700			



1 

Part No.	701644	Ref. No.	80037408
description	guide U-shape L 620mm W 15mm H 20mm mounting pos. right for GFR2700/GRE2700		
For models:	GFR2700, GRE2700		
accessories for	701644		
	Part No.	Ref. No.	
	701643	80037407	
	guide U-shape L 620mm W 15mm H 20mm mounting pos. left for GFR2700/GRE2700		

1 

Part No.	699231	Ref. No.	I0402137
description	guide white L 1350mm W 20mm H 5mm Qty 1		
For models:	GRE3600, GRE3600S		

1 

Part No.	696443	Ref. No.	KITGD4AC2A00
description	pair of setting bar U-shape L 548mm W 20mm inner height 13mm mounting pos. left/right		
For models:	GPS2600, GSA2600, GSD2600, GSF2600		

1 

Part No.	701550	Ref. No.	S24AC29A0002
description	rack L 244mm W 50mm H 8mm mounting pos. front		
For models:	GPS2600, GSA2600, GSD2600, GSF2600		



1 

Part No.	701548	Ref. No.	S24AC29A0004
description	rack L 245mm W 40mm H 30mm mounting pos. left		
For models:	GPS2600, GSA2600, GSD2600, GSF2600		

1 

Part No.	701549	Ref. No.	S24AC29A0005
description	rack L 245mm W 40mm H 30mm mounting pos. right		
For models:	GPS2600, GSA2600, GSD2600, GSF2600		

1 

Part No.	699585	Ref. No.	80037402
description	rack L 985mm W 57mm H 38mm mounting pos. left/right aperture 15x15mm hole distance 55mm 18 holes for GFR2700/GRE2700		
For models:	GFR2700, GRE2700		
accessories for	699585		
	Part No.	Ref. No.	
	701643	80037407	
	guide U-shape L 620mm W 15mm H 20mm mounting pos. left for GFR2700/GRE2700		
	Part No.	Ref. No.	
	701644	80037408	
	guide U-shape L 620mm W 15mm H 20mm mounting pos. right for GFR2700/GRE2700		

1 

Part No.	692398	Ref. No.	LCCK0002
description	shelf support L 24mm W 9mm H 29mm aluminium for fridge Qty 1 pcs		
For models:	GBC1001, GBC1001S, GBC1001SS, GBC1002, GBC1002S, GBC1002SS, GBC1003, GBC1003S, GBC1003SS, GBC1102, GBC1103		

1 

Part No.	692400	Ref. No.	1.1.C.C10.07
description	shelf support L 28.5mm W 14mm H 17.5mm plastic Qty 1 pcs		
For models:	GGC1078		

Part No.	698857	Ref. No.	1.1.C.C10.08
description	shelf support L 28.5mm W 14mm H 17.5mm plastic Qty 1 pcs		
For models:	GGC1078B		



Part No.	692408	Ref. No.	1.1.C.C10.09
description	shelf support L 38.5mm W 14mm H 18mm plastic Qty 1 pcs		
For models:	GGC2270		



Part No.	699416	Ref. No.	1.1.C.C10.10
description	shelf support L 38.5mm W 14mm H 18mm plastic Qty 1 pcs		
For models:	GGC2270B		

gaskets

refrigeration gaskets

plug-in gaskets

profile 9149

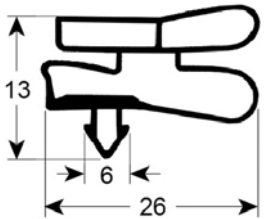

Part No.	902216	Ref. No.	R04AC22A0002
description	refrigeration gasket profile 9149 W 385mm L 480mm plug size		
For models:	GPS2600, GSA2600, GSD2600, GSF2600		

profile 9058

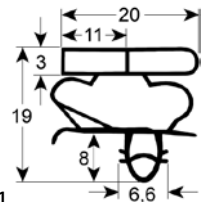

Part No.	902395	Ref. No.	44404000
description	refrigeration gasket profile 9058 W 770mm L 1810mm plug size Qty 1		
For models:	GFR3600S, GRE3600, GRE3600S		

profile 9750

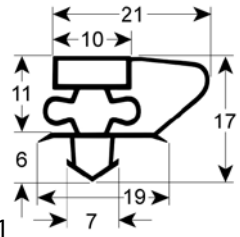

Part No.	902514	Ref. No.	W0404514
description	refrigeration gasket profile 9750 W 660mm L 1537mm plug size		
For models:	GFR2700, GRE2700		

profile 9156

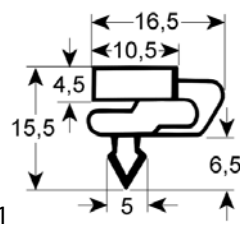

Part No.	901662	Ref. No.	SLJP4007
description	door seal profile 9156 W 569mm L 1295mm plug size Qty 1 pcs		
For models:	GSC1100G		

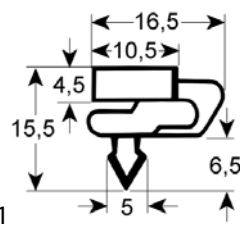

Part No.	901674	Ref. No.	SLJP9002
description	refrigeration gasket profile 9156 W 415mm L 775mm plug size Qty 1 pcs		

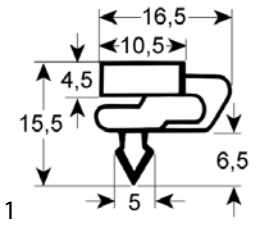
Part No.	901648	Ref. No.	SLJP2010
description	refrigeration gasket profile 9156 W 595mm L 1340mm plug size Qty 1 pcs		
For models:	GSC2336		

profile 9161

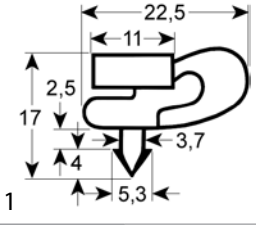

Part No.	902208	Ref. No.	SLJP2025
description	refrigeration gasket profile 9161 W 590mm L 1540mm plug size		

profile 9930

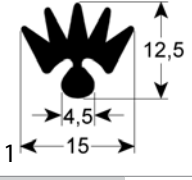

Part No.	901645	Ref. No.	1.1.C.63.69
description	refrigeration gasket profile 9930 Wmm L 746mm plug size		
For models:	GCV1600		

screw-in gaskets

profile 9968

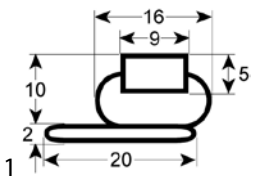

Part No.	901649	Ref. No.	1.1.E.E1.35
description	refrigeration gasket profile 9968 W 418mm L 658mm external size with metal reinforcement Qty 1 pcs		
For models:	GGC1078B		

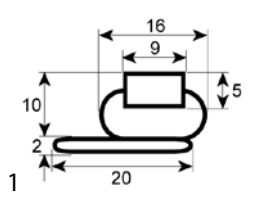

Part No.	901650	Ref. No.	1.1.E.E1.25
description	refrigeration gasket profile 9968 W 515mm L 1390mm external size with metal reinforcement Qty 1 pcs		
For models:	GGC2270		

profile 9910

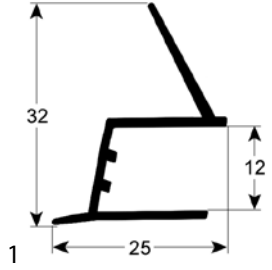

Part No.	901651	Ref. No.	1.1.C.C63.67
description	refrigeration gasket profile 9910 Wmm L 735mm external size Qty 1 mounting pos. left		
For models:	GCV1600		

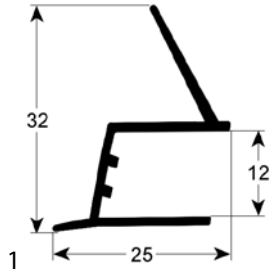

Part No.	901646	Ref. No.	1.1.C.C63.76
description	refrigeration gasket profile 9910 Wmm L 735mm external size Qty 1 mounting pos. right		
For models:	GCV1600		

gaskets for heated units

door seals

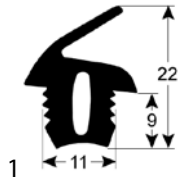

Part No.	902446	Ref. No.	GUA30015
description	door seal profile 2718 L 5500mm		
For models:	GCO500		

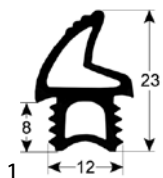

Part No.	902497	Ref. No.	01000770
description	door seal profile 2764 L 1020mm suitable for TECNOEKA		
For models:	GCO2001		

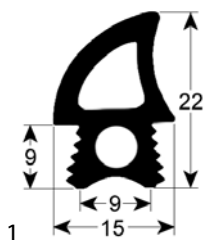

Part No.	902419	Ref. No.	01000810
description	door seal profile 2767 L 1780mm suitable for TECNOEKA		
For models:	GCO2001		

O-rings

EPDM

ø1.50mm

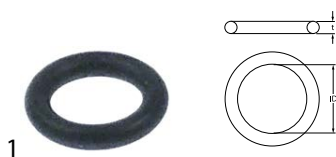

Part No.	532648	Ref. No.	2859
description	O-ring EPDM thickness 1.5mm ID ø 5mm Qty 1 pcs		
For models:	GSM1000		

ø3.00mm



Part No.	510955	Ref. No.	00002001
description	O-ring EPDM thickness 3mm ID ø 6mm Qty 1 pcs		
For models:	GCO2001		

ø5.34mm

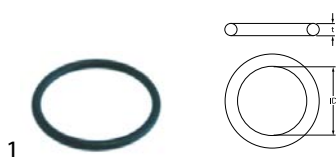

Part No.	521120	Ref. No.	907981
description	O-ring EPDM thickness 5.34mm ID ø 37.47mm Qty 1 pcs		
For models:	GDW2001		

miscellaneous



Part No.	532647	Ref. No.	900970
description	O-ring EPDM thickness 1.8mm ID ø 11.8mm Qty 1 pcs		
For models:	GJU1001		

sealing washers

rubber gaskets



Part No.	519114	Ref. No.	903260
description	flat gasket rubber ED ø 25mm ID ø 16.5mm thickness 2mm Qty 1 pcs		
For models:	GDW2001		

shaft gaskets

shaft gaskets



Part No.	697475	Ref. No.	00000012671
description	shaft seal ID ø 20mm ED ø 30mm thickness 5mm		
For models:	GFS1025		



Part No.	698383	Ref. No.	0632
description	shaft sealing ID ø 4mm ED ø 12mm for hand blender H 6.3mm		
For models:	GSM1000		

miscellaneous



Part No.	511953	Ref. No.	900871
description	seal kit for citrus juicers		
For models:	GJU1001		



special gaskets

for microwaves



1

Part No.	901698	Ref. No.	593219000016
description	gasket L 330mm W 325mm silicone for ceramic plate Qty 1 pcs		
For models:	GMW1025		

miscellaneous



1

Part No.	698545	Ref. No.	3.0000404
description	gasket ED ø 31mm ID ø 21mm		
For models:	GDF3008, GDF3028, GDF5008, GDF5028		



1

Part No.	698543	Ref. No.	3.0000403
description	gasket external height 4mm ED ø 25mm ID ø 16mm		
For models:	GDF3008, GDF3028, GDF5008, GDF5028		

gaskets for wash arm support



1

Part No.	519445	Ref. No.	908141
description	gasket D1 ø 80mm D2 ø 50mm thickness 3mm with 4 screw holes		
For models:	GDW2001		

refrigeration cycle components

valves

Schrader valves

Schrader valves (complete)



1

Part No.	750636	Ref. No.	S900.42
description	Schrader valve complete connection 1/4"SAE ø 6mm L 120mm		
For models:	GHS1600, GHS2600		

filter driers

accessories

holders



1

Part No.	699297	Ref. No.	SLJAC008
description	bracket L 40mm W 30mm H 31mm ID ø 18mm ED ø 22mm for dryer		
For models:	GBC1001, GBC1001S, GBC1001SS, GBC1002, GBC1002S, GBC1002SS, GBC1003, GBC1003S, GBC1003SS, GBC1102, GBC1103, GSC1100G, GSC2336		

miscellaneous



1

Part No.	750381	Ref. No.	TCGV0002
description	dryer ø 18.5mm L 115.5mm connection 2,4/5,2mm Qty 1 pcs		
For models:	GBC1001, GBC1001S, GBC1001SS, GBC1002, GBC1002S, GBC1002SS, GBC1003, GBC1003S, GBC1003SS, GBC1102, GBC1103, GSC2336		



1

Part No.	750693	Ref. No.	1.1.A.A04.01
description	dryer ø 19mm L 120.5mm connection 2/5mm Qty 1 pcs		
For models:	GCV1600, GGC1078, GGC1078B		



			
1			
Part No.	750378	Ref. No.	C01AE66A0001 C04AC26A0001
description	dryer ø 19mm L 145mm connection 4,5/8mm type XH9 Qty 1 pcs		
For models:	GDS2600, GPS2600, GSA2600, GSD2600, GSF2600		

			
1			
Part No.	750748	Ref. No.	W0204101
description	dryer ø 19mm L 166mm connection 2,7/5,2 for GFR2700/GRE2700		
For models:	GFR2700, GRE2700		

			
1			
Part No.	750694	Ref. No.	1.1.A.A04.06
description	dryer ø 25mm L 144mm connection 6/8mm Qty 1 pcs		
For models:	GGC2270, GGC2270B		

			
1			
Part No.	750324	Ref. No.	S900.44
description	dryer size 20g ø 23mm L 117mm connection 4,8/8,3mm		
For models:	GHS1600, GHS2600		

			
1			
Part No.	750382	Ref. No.	TCGV0009
description	dryer ø 18.5mm L 120mm connection 4/7mm Qty 1 pcs		
For models:	GSC1100G		
accessories for	750382		
	Part No.	694868	Ref. No. —
bracket for dryer L 40mm W 30mm H 31mm Qty 1 pcs			

refrigeration pipes

copper pipes uninsulated

			
1			
Part No.	694931	Ref. No.	VRX.15
description	capillary pipe ID ø 0.8mm L 2340m ED ø 2mm		
For models:	GHS1600, GHS2600		

			
1			
Part No.	692407	Ref. No.	1.1.B.B06.21
description	copper pipe copper ID ø 3.8mm L 0.1m ED ø 4.8mm Qty 1 pcs		
For models:	GGC2270, GGC2270B		

			
1			
Part No.	692730	Ref. No.	TCGO3004
description	copper pipe ID ø 4mm L 0.095m ED ø 6mm		
For models:	GBC1002, GBC1002S, GBC1003, GBC1003S, GBC1102, GBC1103		

			
1			
Part No.	692418	Ref. No.	1.1.B.B06.26
description	refrigeration pipe copper ID ø 5mm L 1m ED ø 6mm Qty 1		
For models:	GCV1600, GGC1078, GGC1078B, GGC2270, GGC2270B		

			
1			
Part No.	692872	Ref. No.	W0210284
description	refrigeration pipe ID ø 2/3mm L 0.4m refrigeration ED ø 5mm GFR2700		
For models:	GFR2700		

			
1			
Part No.	692871	Ref. No.	W0210452
description	refrigeration pipe ID ø 3/7mm L 0.38m refrigeration ED ø 6/8mm GFR2700		
For models:	GFR2700		



1

Part No.	692874	Ref. No.	W0210412
description	refrigeration pipe ID ø 5.5mm L 0.3m refrigeration ED ø 6.5mm GFR2700		
For models:	GFR2700		

1

Part No.	692876	Ref. No.	W0210411
description	refrigeration pipe ID ø 5mm L 0.28m refrigeration ED ø 6.5mm GFR2700		
For models:	GFR2700		

1

Part No.	692875	Ref. No.	W0210416
description	refrigeration pipe ID ø 6,5/7,5mm L 0.38m refrigeration ED ø 7,5/8,5mm GRE2700		
For models:	GRE2700		

1



Part No.	692873	Ref. No.	W0210282	
description	refrigeration pipe ID ø 6.5mm L 0.36m refrigeration ED ø 8mm GFR2700			
For models:	GFR2700			
accessories for	692873			
	Part No.	696787	Ref. No.	W0208009
	T-piece copper ID ø 4.5mm ED ø 6mm refrigeration for GFR2700			

1

Part No.	692877	Ref. No.	W0210417
description	refrigeration pipe ID ø 6/7mm L 0.41m refrigeration ED ø 7/8mm GRE2700		
For models:	GRE2700		

copper pipes insulated

1

Part No.	696789	Ref. No.	W0210413	
description	copper pipe with insulation pipe ø 6 for fridge GFR2700/GRE2700			
For models:	GFR2700, GRE2700			
accessories for	696789			
	Part No.	692867	Ref. No.	W04102051
	cover ø 20mm L 400mm W 43mm plastic Qty 1 pcs for GFR2700/GRE2700			
	Part No.	692870	Ref. No.	W0413062
	rubber pad L 40mm W 17mm H 30mm for GFR2700/GRE2700			

1

Part No.	699570	Ref. No.	W0210414
description	refrigeration pipe pipe ø 8 L 1700mm GFR2700		
For models:	GFR2700		



Part No.	699572	Ref. No.	W0210418
description	refrigeration pipe pipe ø 8 L 1700mm GRE2700		
For models:	GRE2700		

connections



Part No.	696787	Ref. No.	W0208009
description	T-piece copper ID ø 4.5mm ED ø 6mm refrigeration for GFR2700		
For models:	GFR2700		

accessories for 696787

	Part No.	374110	Ref. No.	W0205011
	description	solenoid valve type FDF2AT connection 6mm soldering connection L 143mm pipe connection ø 6mm 220-240V		

	Part No.	692873	Ref. No.	W0210282
	description	refrigeration pipe ID ø 6.5mm L 0.36m refrigeration ED ø 8mm GFR2700		

heating tubes



Part No.	701583	Ref. No.	C04AC26A0002
description	heater ED ø 6mm ID ø 3mm L 260mm copper		
For models:	GPS2600, GSA2600, GSD2600, GSF2600		

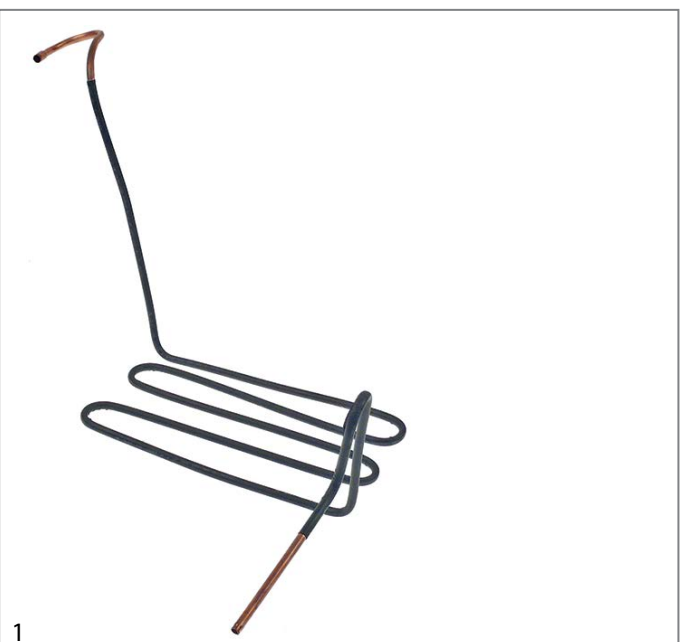

Part No.	701495	Ref. No.	TCGD4010
description	heater ED ø 6mm ID ø 5mm Qty 1m for evaporator connection ø 6mm		
For models:	GSC1100G		

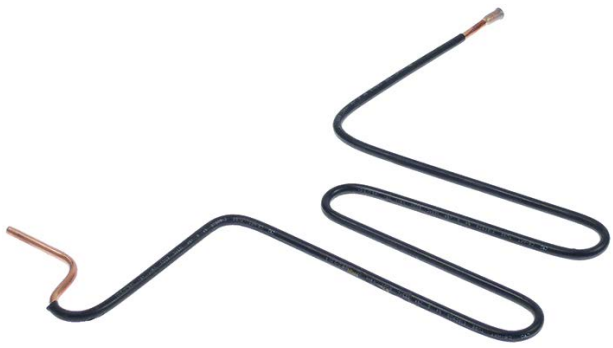
1

Part No.	701582	Ref. No.	TCGD2001
description	heater pipe ED ø 5mm ID ø 3mm L 355mm H 250mm		
For models:	GBC1001, GBC1001S, GBC1001SS		

evaporators for fridges

producer-specific



1

Part No.	750387	Ref. No.	TLZA9000
description	evaporator for fridge GBC1001 L 430mm W 500mm		
For models:	GBC1001, GBC1001S, GBC1001SS		



1

Part No.	750376	Ref. No.	TLZD9001
description	evaporator for fridge GBC1002 L 760mm W 500mm		
For models:	GBC1002, GBC1002S, GBC1002SS, GBC1102		



1

Part No.	750456	Ref. No.	TLZD2008
description	evaporator for fridge HSC360 L 780mm W 495mm		



1

Part No.	750377	Ref. No.	TLZD9002
description	evaporator for fridge L 1000mm W 500mm		
For models:	GBC1003, GBC1003S, GBC1003SS, GBC1103		



1

Part No.	750352	Ref. No.	1.1.A.A10.27
description	evaporator L 250mm W 50mm H 117mm		
For models:	GGC1078, GGC1078B		



1

Part No.	750629	Ref. No.	GPC1088-02
description	evaporator L 320mm W 320mm H 5mm		
For models:	GPC1088		

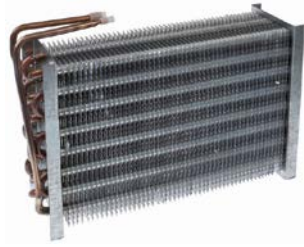

1

Part No.	750350	Ref. No.	1.1.A.A10.40
description	evaporator L 345mm W 100mm H 215mm total length 345mm overall width 100mm overall height 240mm for fridge		
For models:	GGC2270, GGC2270B		





1

Part No.	750744	Ref. No.	W0202112	
description	evaporator L 404mm W 175mm H 142mm GFR2700			
For models:	GFR2700			
accessories for	750744			
	Part No.	699574	Ref. No.	81131204
	Part No.	699577	Ref. No.	80021203
	Part No.	699578	Ref. No.	80021204



			
1			
Part No.	750371	Ref. No.	1.1.A.A10.23
description	evaporator L 545mm W 50mm H 110mm total length 600mm overall width 50mm overall height 123mm		
For models:	GCV1600		

			
1			
Part No.	750660	Ref. No.	TLZA4003
description	evaporator L 620mm W 225mm H 160mm		

			
1			
Part No.	750375	Ref. No.	TLZA4004
description	evaporator L 760mm W 140mm H 225mm		

			
1			
Part No.	750743	Ref. No.	W0202117
description	evaporator W 150mm H 135mm L 300mm GRE2700		
For models:	GRE2700		
accessories for	750743		
	Part No.	699574	Ref. No. 81131204
	cover front for evaporator L 598mm W 295mm H 65mm for GFR2700/ GRE2700		
	Part No.	699577	Ref. No. 80021203
	cover left for evaporator L 255mm W 155mm H 15mm for GFR2700/ GRE2700		
	Part No.	699578	Ref. No. 80021204
	cover right for evaporator L 255mm W 155mm H 15mm for GFR2700/ GRE2700		

accessories

miscellaneous

			
1			
Part No.	692868	Ref. No.	W0409079
description	cover for evaporator plastic GFR2700/GRE2700		
For models:	GFR2700, GRE2700		

condensors

filters

			
1			
Part No.	699402	Ref. No.	P04AC28A0002
description	filter for condenser L 218mm W 230mm thickness 6mm Qty 1 pcs		
For models:	GDS2600, GPS2600, GSA2600, GSD2600, GSF2600		

condensors

			
1			
Part No.	750746	Ref. No.	W0203051
description	condenser Capacitor W 250mm H 100mm L 260mm for GRE2700		
For models:	GRE2700		

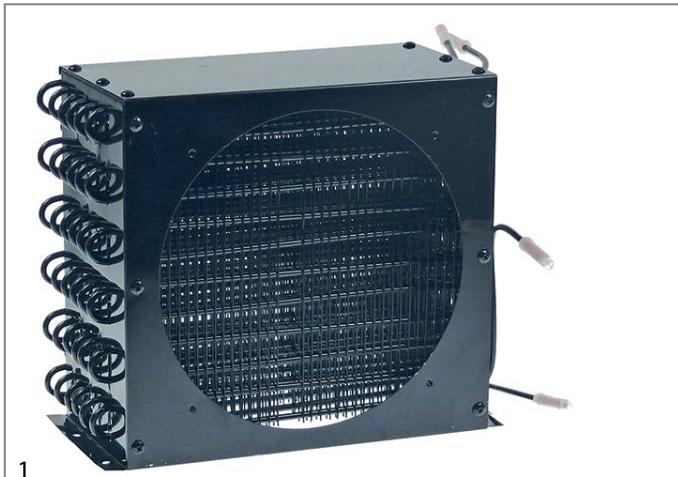

1

Part No.	750742	Ref. No.	W0203052
description	condenser Capacitor W 250mm H 140mm L 260mm GFR2700		
For models:	GFR2700		



1

Part No.	750372	Ref. No.	DTLA9000
description	condenser W 195mm D 80mm H 205mm Qty 1 pcs		
For models:	GBC1001, GBC1001S, GBC1001SS		



1

Part No.	750319	Ref. No.	VRX.11
description	condenser for pizza table W 228mm D 77mm H 179mm		
For models:	GHS1600, GHS2600		



1

Part No.	750347	Ref. No.	C04AC28A0001
description	condenser W 220mm D 100mm H 230mm L 270mm		
For models:	GDS2600, GPS2600, GSA2600, GSD2600, GSF2600		

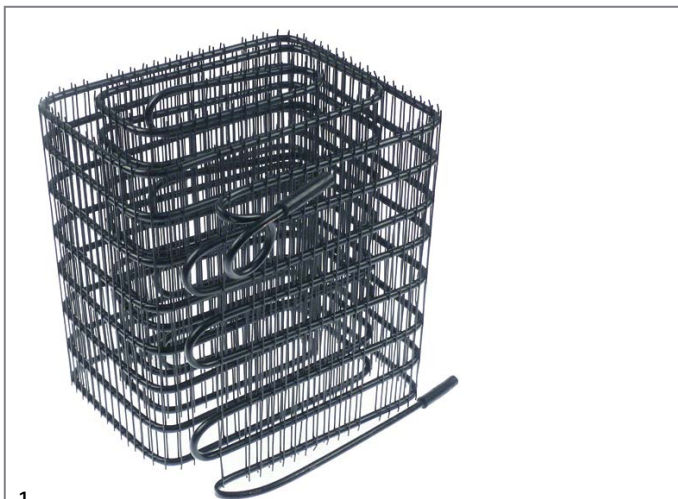

1

Part No.	750373	Ref. No.	DTLA9002
description	condenser W 190mm D 160mm H 205mm Qty 1 pcs		
For models:	GBC1003, GBC1003S, GBC1003SS, GBC1103		



1

Part No.	750384	Ref. No.	1.1.A.A09.01
description	condenser W 220mm D 60mm H 280mm Qty 1 pcs		
For models:	GGC1078, GGC1078B		



Part No.	750351	Ref. No.	1.1.A.A09.09
description	condenser W 255mm D 130mm H 235mm		
For models:	GGC2270, GGC2270B		



Part No.	750370	Ref. No.	1.1.A.A09.21
description	condenser W 265mm D 93mm H 140mm Qty 1 pcs		
For models:	GCV1600		



Part No.	750374	Ref. No.	DTLA4008
description	condenser W 555mm D 100mm H 275mm Qty 1 pcs		



Part No.	750703	Ref. No.	44918000
description	condenser W 790mm D 10mm H 1360mm		
For models:	GFR3600S		

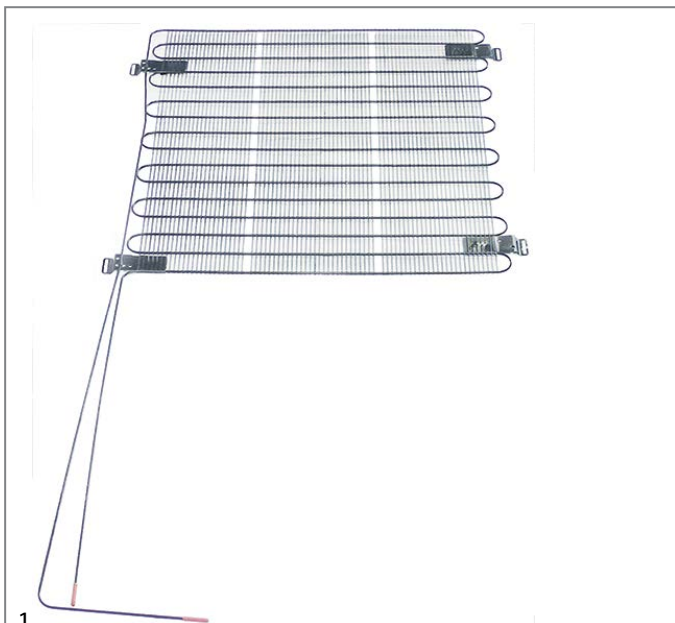



Part No.	750699	Ref. No.	45034000
description	condenser W 790mm D 10mm H 750mm Qty 1 pcs		
For models:	GRE3600, GRE3600S		





evaporation and condensing trays

evaporation trays

			
1			
Part No.	699302	Ref. No.	SLZJ0021
description	evaporation tray L 185mm W 130mm H 75mm		
For models:	GBC1001, GBC1001S, GBC1001SS		

			
1			
Part No.	699299	Ref. No.	SLZJ0014
description	evaporation tray L 210mm W 105mm H 80mm		
For models:	GSC2336		

			
1			
Part No.	699211	Ref. No.	I0425088
description	evaporation tray L 230mm W 144mm H 45mm		
For models:	GRE3600, GRE3600S		

			
1			
Part No.	750745	Ref. No.	W0409071
description	evaporation tray rear L 527mm W 238mm for fridge for GFR2700/ GRE2700		
For models:	GFR2700, GRE2700		
accessories for	750745		
	Part No.	750747	Ref. No. W0409078
	overflow plastic for GFR2700/GRE2700		

unheated condensing trays



			
1			
Part No.	750630	Ref. No.	GPC1088-08
description	condensing tray L 200mm W 135mm H 30mm plastic		
For models:	GPC1088		

			
1			
Part No.	750632	Ref. No.	SLZJ0022
description	drip tray L 187mm W 128mm H 70mm plastic		
For models:	GBC1002, GBC1002S, GBC1002SS, GBC1003, GBC1003S, GBC1003SS, GBC1102, GBC1103		

			
1			
Part No.	750631	Ref. No.	SLZJ0015
description	drip tray L 302mm W 204mm H 85mm plastic		
For models:	GSC1100G		

			
1			
Part No.	699418	Ref. No.	1.1.C.C29.02
description	drip tray L 400mm W 144mm H 50mm plastic		
For models:	GGC2270, GGC2270B		

miscellaneous

			
1			
Part No.	750747	Ref. No.	W0409078
description	overflow plastic for GFR2700/GRE2700		
For models:	GFR2700, GRE2700		
accessories for	750747		
	Part No.	750745	Ref. No. W0409071
	evaporation tray rear L 527mm W 238mm for fridge for GFR2700/ GRE2700		



transmission technology and ball bearings

ball bearings

deep-groove ball bearings 2RS



1

Part No.	523501	Ref. No.	00000000637
description	deep-groove ball bearing type 608-2RS shaft \varnothing 8mm ED \varnothing 22mm W 7mm with sealing discs deep-groove ball bearing DIN 625-1		
For models:	GFS1030		



1

Part No.	523510	Ref. No.	00000000860
description	deep-groove ball bearing type 6202-2RS shaft \varnothing 15mm ED \varnothing 35mm W 11mm with sealing discs deep-groove ball bearing DIN 625-1		
For models:	GFS1025, GFS2019, GFS2022, GFS2025, GFS2030		



1

Part No.	523512	Ref. No.	00000000632
description	deep-groove ball bearing type 6204-2RS shaft \varnothing 20mm ED \varnothing 47mm W 14mm with sealing discs deep-groove ball bearing DIN 625-1		
For models:	GFS1030		



1

Part No.	523504	Ref. No.	00000000862
description	deep-groove ball bearing type 626-2RS shaft \varnothing 6mm ED \varnothing 19mm W 6mm with sealing discs deep-groove ball bearing DIN 625-1		
For models:	GFS1025, GFS2019, GFS2022, GFS2025, GFS2030		

drive belts

poly-v belts

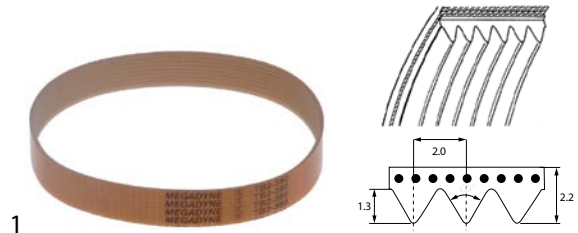

1

Part No.	698215	Ref. No.	00000000635
description	poly-v belt grooves 10 W 20mm L 400mm profile TB2		
For models:	GFS1030		

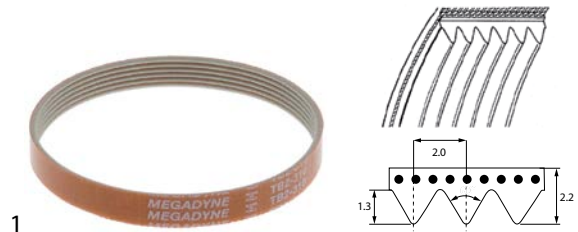

1

Part No.	698963	Ref. No.	00000000492
description	poly-v belt grooves 5 W 10mm L 310mm profile TB2		
For models:	GFS2019, GFS2022		

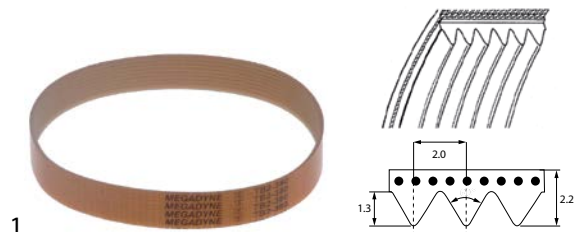

1

Part No.	698217	Ref. No.	00000000861
description	poly-v belt grooves 7 W 14mm L 330mm profile TB2		
For models:	GFS1025, GFS2025		

springs

compression springs



1

Part No.	519162	Ref. No.	904131
description	spring		
For models:	GDW2001		



1

Part No.	692701	Ref. No.	1.1.B.B10.06
description	spring L 4mm wire gauge ø 1mm windings 5 D1 ø 9.5mm		
For models:	GGC1078, GGC1078B		

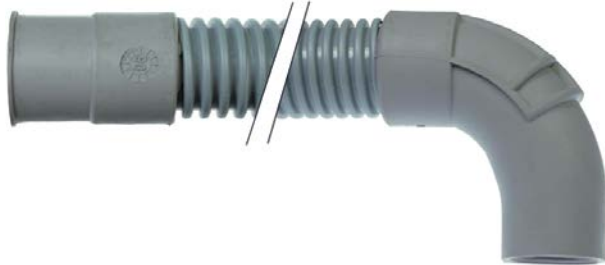

1

Part No.	519456	Ref. No.	907439
description	drain hose L 1500mm D1 ø 21mm D2 ø 21mm		
For models:	GDW2001		

dosing pumps

membrane dosing pumps

self-priming

SEKO



1

Part No.	362031	Ref. No.	902201
description	dosing pump type DIB E rinse aid pump rate 0-5cm ³ per stroke pressure connection ø 4x6mm suction connection ø 4x6mm suction connection SEKO supporting pressure closed		
For models:	GDW2001		

accessories

miscellaneous



1

Part No.	513329	Ref. No.	906375
description	bracket for dosing pump L 70mm H 25mm W 40mm spring steel		
For models:	GDW2001		

hoses

drain hoses



1

Part No.	530921	Ref. No.	907446
description	drain hose 3/4" L 1500mm A int. ø 29mm A ext. ø 34mm B int. ø 21mm B ext. ø 26mm outer hose ø 24mm		
For models:	GDW2001		

industrial hoses

PVC hoses

PVC hoses without fabric



1

Part No.	570027	Ref. No.	902046
description	PVC hose ID ø 4mm ED ø 7mm L 100m thickness 1.5mm t.max. 60°C transparent		
For models:	GDW2001		

silicone hoses

without fabric



1

Part No.	530410	Ref. No.	907279
description	silicone hose ID ø 4mm ED ø 7mm L 2m thickness 1.5mm t.max. 200°C transparent		
For models:	GDW2001		

formed hoses

straight



1

Part No.	519392	Ref. No.	903756
description	formed hose L 61mm dishwasher straight hose ext. ø 50mm hose int. ø 38mm		
For models:	GDW2001		

form L



1

Part No.	503190	Ref. No.	903694
description	formed hose L 120mm supply EPDM warewashing 45 ED ø 56mm		
For models:	GDW2001		



1

Part No.	506280	Ref. No.	909371
description	formed hose L 190mm EPDM warewashing black		
For models:	GDW2001		



1

Part No.	505410	Ref. No.	903672
description	formed hose L 70mm warewashing ID ø 27mm ED ø 37mm		
For models:	GDW2001		

miscellaneous



1

Part No.	699420	Ref. No.	1.1.C.C41.13
description	formed hose ID ø 19mm ED ø 24mm L 150mm		
For models:	GGC1078, GGC1078B		

for dishwashers

miscellaneous



1

Part No.	503190	Ref. No.	903694
description	formed hose L 120mm supply EPDM warewashing 45 ED ø 56mm		
For models:	GDW2001		



1

Part No.	506280	Ref. No.	909371
description	formed hose L 190mm EPDM warewashing black		
For models:	GDW2001		

fittings, hose and pipe connectors
 hose connectors

without screw connection



1

Part No.	519644	Ref. No.	905434
description	T-piece plastic connection ø12mm - ø5mm - ø12mm		
For models:	GDW2001		



1

Part No.	519216	Ref. No.	905382
description	T-piece plastic hose ø 12-12-12mm 3-way		
For models:	GDW2001		

ancillary products

clamps

double wire clamps



1

Part No.	513268	Ref. No.	902425
description	hose clamp ø 8-10mm wire gauge ø 1mm Qty 1 pcs		
For models:	GDW2001		



fastening material

screws

side bolts



1

Part No.	560551	Ref. No.	00000000615
description	side bolts thread M10 L 15mm SS Qty 1 pcs intake slotted head ø 24.5mm		
For models:	GFS1030		

knurled screws



1

Part No.	697481	Ref. No.	00000000623
description	Thumb screw thread M6 thread L 8mm ø 14mm H 6mm SS		
For models:	GFS1030, GFS2019, GFS2022, GFS2025		

nuts

hexagonal nuts

DIN 985



1

Part No.	560142	Ref. No.	902040
description	hexagonal nut thread M6 H 6mm SS WS 10 Qty 20 pcs DIN/ISO DIN 985 self-locking		
For models:	GDW2001		

miscellaneous



1

Part No.	551380	Ref. No.	DAD30010
description	cage nut thread M10 Qty 4 pcs		
For models:	GCO500		

washers

spring washers



1

Part No.	697478	Ref. No.	00000000671
description	spring washer ID ø 19mm ED ø 26mm Qty 1 pcs		
For models:	GFS1030		

washers

miscellaneous



1

Part No.	519238	Ref. No.	906002
description	plain washer ID ø 15mm ED ø 33mm thickness 0.8mm SS Qty 1 pcs		
For models:	GDW2001		

fasteners

mounting clips



1

Part No.	692865	Ref. No.	00007750
description	mounting clip for bulb socket L 16mm H 19mm		
For models:	GCO2001		

clamps

double wire clamps



1

Part No.	513268	Ref. No.	902425
description	hose clamp ø 8-10mm wire gauge ø 1mm Qty 1 pcs		
For models:	GDW2001		



roll pins



1

Part No.	691637	Ref. No.	0744
description	roll pin ø 3mm L 20mm		
For models:	GSM1000		

GASTROPARTS.COM

