



GASTROPARTS

MKN

- [EN]** Equipment
- [DE]** Geräte
- [ES]** Aparatos
- [FR]** Équipement
- [IT]** Attrezzature
- [PL]** Urządzenia
- [RU]** Оборудование

✉ gastroparts@gastroparts.com

☎ tel. +48 56 657 00 66

📘 fb.com/gastroparts.global

GASTROPARTS.COM







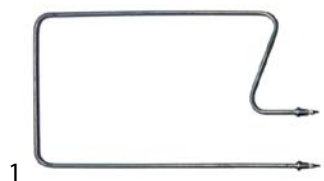

heating elements

heating elements for ovens



1

Part No.	415783	Ref. No.	574066
description	heating element 1200W 380V heating circuits 1 L 510mm W 295mm L1 37mm L2 467mm W1 180mm W2 115mm mounting distance 106mm thread M14x1.5 tube ø 8.5mm connection M4 mounting pos. lower-outer dry heating element 2 hole fixing		
accessories for	415783		
	Part No.	510417	Ref. No. —
	flat gasket fibre ED ø 20mm ID ø 14mm thickness 2mm Qty 1 pcs		
	Part No.	520228	Ref. No. —
	tooth lock washer ID ø 15.3mm ED ø 24mm steel Qty 1 pcs for thread M14		
	Part No.	520230	Ref. No. —
	nut thread M14x1.5 H 5mm WS 19 zinc-coated steel Qty 1 pcs		
	Part No.	521101	Ref. No. 113000
	nut thread M14x1.5 H 5mm WS 19 SS Qty 1 pcs		
	Part No.	550262	Ref. No. —
	flat gasket copper ED ø 20mm ID ø 14mm thickness 2mm		

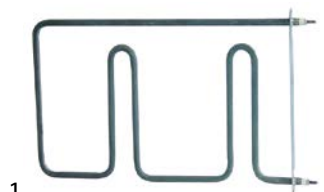



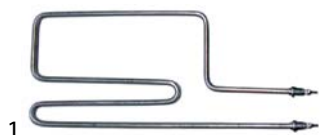

1

Part No.	416448	Ref. No.	574089
description	heating element 1275W 230V L 325mm W 202mm flange length 225mm flange width 20mm hole distance 219mm tube ø 8.5mm heating circuits 1 hole ø 5.5mm connection M4 mounting pos. lower rectangular flange dry heating element oven		
For models:	0522101-01, 0522101-02, 0522101-03, 0522101-04, 1323208-00, 1323208-01, 1323208-02, 1323208-03, 1323208-04, 1323210-00, 1323210-01, 1323210-02, 1323210-03, 1323210-04, 1323403-00, 1323403K00, 1323506-00, 1323506-01, 1323506A00, 1323506A01, 1323517-00, 1323517A00, 1363403-00, 1363403-01, 1363403-02, 1363403-03, 1363403-04, 1363403-05, 1363415-05, 1422102-01, 1422102-02, 1422102-03, 1422102-04, 1422102-05, 1422104-05, 2123203-01, 2123203-02, 2123203-03, 2123203-04, 2123203-05, 2123203-06, 2123203-07, 2123203-08, 2123203A01, 2123203A02, 2123203A03, 2123203A04, 2123204-01, 2123204-02, 2123204-03... (Other models you can see in the webshop)		



1

Part No.	415784	Ref. No.	574067
description	heating element 1300W 380V heating circuits 1 L 442mm W 190mm L1 110mm L2 332mm W1 117mm W2 73mm mounting distance 65mm thread M14x1.5 tube ø 8.5mm connection M4 mounting pos. lower-inner dry heating element 2 hole fixing		
accessories for	415784		
	Part No.	510417	Ref. No. —
	flat gasket fibre ED ø 20mm ID ø 14mm thickness 2mm Qty 1 pcs		
	Part No.	520228	Ref. No. —
	tooth lock washer ID ø 15.3mm ED ø 24mm steel Qty 1 pcs for thread M14		
	Part No.	521101	Ref. No. 113000
	nut thread M14x1.5 H 5mm WS 19 SS Qty 1 pcs		
	Part No.	550262	Ref. No. —
	flat gasket copper ED ø 20mm ID ø 14mm thickness 2mm		

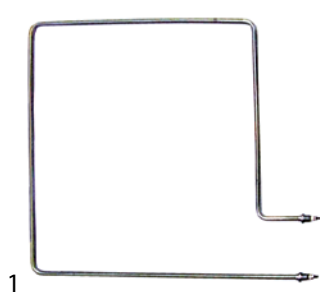

1

Part No.	415787	Ref. No.	574081
description	heating element 1450W 400V heating circuits 1 L 502mm W 455mm L1 75mm L2 427mm W1 357mm W2 98mm mounting distance 90mm thread M14x1.5 tube ø 8.5mm connection M4 mounting pos. lower-outer 2 hole fixing		
For models:	0522101-00, 1422102-00, 2123203-00, 2123203A00, 2123204-00, 2123204A00, 2163403-00, 2163403-01, 2163406-00, 2163406-01, 2163417-00, 2163420-00		

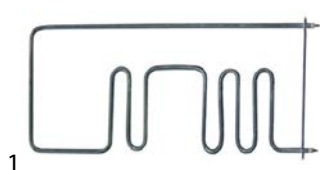









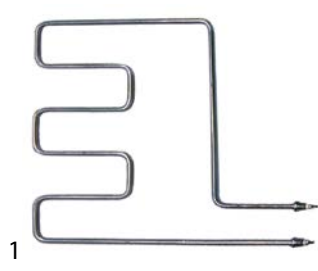

1

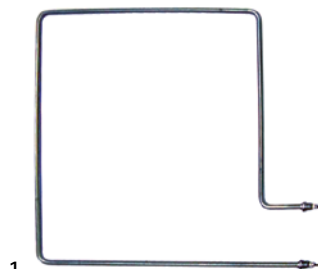

Part No.	415570	Ref. No.	574087
description	heating element 1500W 230V L 470mm W 200mm flange length 225mm flange width 20mm hole distance 214mm tube ø 8.3mm heating circuits 1 hole ø 6mm connection M4 mounting pos. lower rectangular flange dry heating element oven		
For models:	0522102-01, 0522102-02, 0522102-03, 0522102-04, 0722101-06, 1422101-01, 1422101-02, 1422101-03, 1422101-04, 1422101-05, 1422101-06, 1422106-05, 1422106-06, 1422301-01, 2023114-00, 2023118-00, 2023119-00, 2023203-01, 2023203-02, 2023203-03, 2023203-04, 2023203-05, 2023203-06, 2023203-07, 2023203A01, 2023203A02, 2023203A03, 2023205-01, 2023205-02, 2023205-03, 2023205-04, 2023205-05, 2023205-06, 2023205-07, 2023205A01, 2023205A02, 2023205A03, 2023207-00, 2023207-01, 2023207-02, 2023207-03, 2023207-04, 2023207-05, 2023406-00, 2023503-02, 2023503-03, 2023503-04, 2023503-05, 2023503-06, 2023503-07... (Other models you can see in the webshop)		

1 electric components







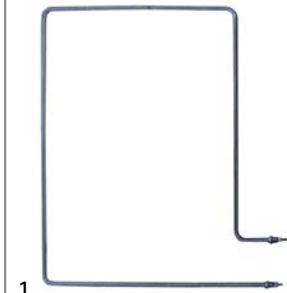

			
1			
Part No.	415786	Ref. No.	574082
description	heating element 1500W 380V heating circuits 1 L 432mm W 392mm L1 135mm L2 302mm W1 322mm W2 70mm mounting distance 61mm thread M14x1.5 tube ø 8.6mm connection M4 mounting pos. upper inner dry heating element oven 2 hole fixing		
For models:	0522101-00, 1422102-00, 2123203-00, 2123203A00, 2123204-00, 2123204A00, 2163403-00, 2163403-01, 2163406-00, 2163406-01, 2163417-00, 2163420-00		
accessories for	415786		
	Part No.	510417	Ref. No. —
	flat gasket fibre ED ø 20mm ID ø 14mm thickness 2mm Qty 1 pcs		
	Part No.	520228	Ref. No. —
	tooth lock washer ID ø 15.3mm ED ø 24mm steel Qty 1 pcs for thread M14		
	Part No.	520230	Ref. No. —
	nut thread M14x1.5 H 5mm WS 19 zinc-coated steel Qty 1 pcs		
	Part No.	521101	Ref. No. 113000
	nut thread M14x1.5 H 5mm WS 19 SS Qty 1 pcs		
	Part No.	550262	Ref. No. —
	flat gasket copper ED ø 20mm ID ø 14mm thickness 2mm		

			
1			
Part No.	415785	Ref. No.	574083
description	heating element 1500W 380V heating circuits 1 L 505mm W 463mm L1 75mm L2 430mm W1 357mm W2 98mm mounting distance 90mm thread M14x1.5 tube ø 8.5mm connection M4 mounting pos. upper outer dry heating element 2 hole fixing		
For models:	0522101-00, 1422102-00, 2123203-00, 2123203A00, 2123204-00, 2123204A00, 2163403-00, 2163403-01, 2163406-00, 2163406-01, 2163417-00, 2163420-00		
spare parts for	415785		
	Part No.	510417	Ref. No. —
	flat gasket fibre ED ø 20mm ID ø 14mm thickness 2mm Qty 1 pcs		
accessories for	415785		
	Part No.	520228	Ref. No. —
	tooth lock washer ID ø 15.3mm ED ø 24mm steel Qty 1 pcs for thread M14		
	Part No.	520230	Ref. No. —
	nut thread M14x1.5 H 5mm WS 19 zinc-coated steel Qty 1 pcs		

accessories for	415785		
	Part No.	521101	Ref. No. 113000
	nut thread M14x1.5 H 5mm WS 19 SS Qty 1 pcs		
	Part No.	550262	Ref. No. —
	flat gasket copper ED ø 20mm ID ø 14mm thickness 2mm		

			
1			
Part No.	415810	Ref. No.	574068
description	heating element 1500W 400V heating circuits 1 L 495mm W 635mm L1 75mm L2 420mm W1 515mm W2 120mm mounting distance 100mm thread M14x1.5 tube ø 8.5mm connection M4 mounting pos. upper outer 2 hole fixing		
For models:	0522102-00, 1422101-00, 2023203-00, 2023203A00, 2023205-00, 2023205A00, 2023503-00, 2023503-01, 2023503A00, 2023503A01, 2063403-00, 2063403-01, 2063406-00, 2063406-01, 2063415-00, 2063415-01, 2063418-00, 2063418-01, 2063502-00, 2063502-01, 2063507-00, 2063507-01, 2063509-00, 2063509-01, 2083202A00, 2083502B00, 2083502B01, 2083502C00, 2083502C01		



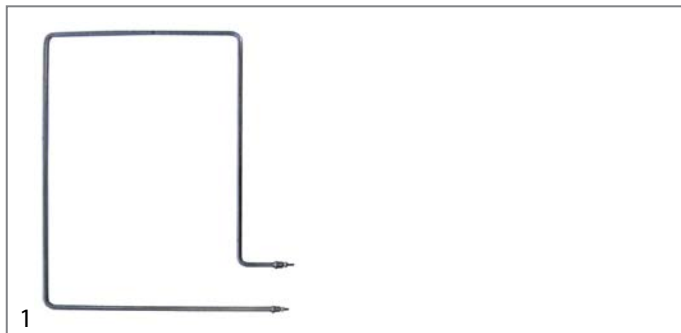

			
1			
Part No.	415788	Ref. No.	574080
description	heating element 1700W 380V heating circuits 1 L 475mm W 386mm L1 140mm L2 295mm L3 40mm W1 320mm W2 66mm mounting distance 58mm thread M14x1.5 tube ø 8.5mm connection M4 mounting pos. lower-inner dry heating element 2 hole fixing		
For models:	0522101-00, 1422102-00, 2123203-00, 2123203A00, 2123204-00, 2123204A00, 2163403-00, 2163403-01, 2163406-00, 2163406-01, 2163417-00, 2163420-00		
accessories for	415788		
	Part No.	510417	Ref. No. —
	flat gasket fibre ED ø 20mm ID ø 14mm thickness 2mm Qty 1 pcs		
	Part No.	520228	Ref. No. —
	tooth lock washer ID ø 15.3mm ED ø 24mm steel Qty 1 pcs for thread M14		
	Part No.	520230	Ref. No. —
	nut thread M14x1.5 H 5mm WS 19 zinc-coated steel Qty 1 pcs		
	Part No.	521101	Ref. No. 113000
	nut thread M14x1.5 H 5mm WS 19 SS Qty 1 pcs		
	Part No.	550262	Ref. No. —
	flat gasket copper ED ø 20mm ID ø 14mm thickness 2mm		

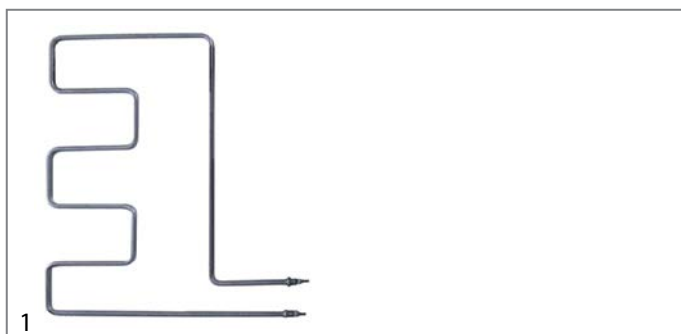



Part No.	415812	Ref. No.	574070 574076
description	heating element 1700W 400V heating circuits 1 L 495mm W 635mm L1 75mm L2 420mm W1 515mm W2 120mm mounting distance 110mm thread M14x1.5 tube ø 8.5mm connection M4 mounting pos. lower-outer dry heating element 2 hole fixing		
For models:	0522102-00, 1422101-00, 2023203-00, 2023203A00, 2023205-00, 2023205A00, 2023503-00, 2023503-01, 2023503A00, 2023503A01, 2063403-00, 2063403-01, 2063406-00, 2063406-01, 2063415-00, 2063415-01, 2063418-00, 2063418-01, 2063502-00, 2063502-01, 2063507-00, 2063507-01, 2063509-00, 2063509-01, 2083202A00, 2083502B00, 2083502B01, 2083502C00, 2083502C01		
accessories for	415812		
	Part No.	510417	Ref. No. —
	flat gasket fibre ED ø 20mm ID ø 14mm thickness 2mm Qty 1 pcs		
	Part No.	520228	Ref. No. —
	tooth lock washer ID ø 15.3mm ED ø 24mm steel Qty 1 pcs for thread M14		
	Part No.	520230	Ref. No. —
	nut thread M14x1.5 H 5mm WS 19 zinc-coated steel Qty 1 pcs		
	Part No.	521101	Ref. No. 113000
	nut thread M14x1.5 H 5mm WS 19 SS Qty 1 pcs		
	Part No.	550262	Ref. No. —
	flat gasket copper ED ø 20mm ID ø 14mm thickness 2mm		





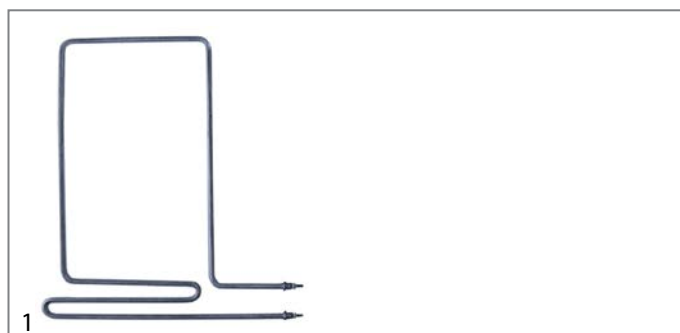

Part No.	415811	Ref. No.	574069
description	heating element 1700W 400V L 447mm W 540mm L1 137mm L2 310mm W1 474mm W2 66mm mounting distance 58mm thread M14x1.5 tube ø 8.5mm connection M4 mounting pos. upper inner 2 hole fixing		
For models:	0522102-00, 1422101-00, 2023203-00, 2023203A00, 2023205-00, 2023205A00, 2023503-00, 2023503-01, 2023503A00, 2023503A01, 2063403-00, 2063403-01, 2063406-00, 2063406-01, 2063415-00, 2063415-01, 2063418-00, 2063418-01, 2063502-00, 2063502-01, 2063507-00, 2063507-01, 2063509-00, 2063509-01, 2083202A00, 2083502B00, 2083502B01, 2083502C00, 2083502C01		
accessories for	415811		
	Part No.	510417	Ref. No. —
	flat gasket fibre ED ø 20mm ID ø 14mm thickness 2mm Qty 1 pcs		



accessories for	415811		
	Part No.	520228	Ref. No. —
	tooth lock washer ID ø 15.3mm ED ø 24mm steel Qty 1 pcs for thread M14		
	Part No.	520230	Ref. No. —
	nut thread M14x1.5 H 5mm WS 19 zinc-coated steel Qty 1 pcs		
	Part No.	521101	Ref. No. 113000
	nut thread M14x1.5 H 5mm WS 19 SS Qty 1 pcs		
	Part No.	550262	Ref. No. —
	flat gasket copper ED ø 20mm ID ø 14mm thickness 2mm		

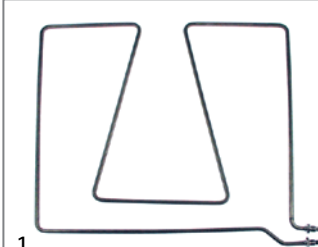





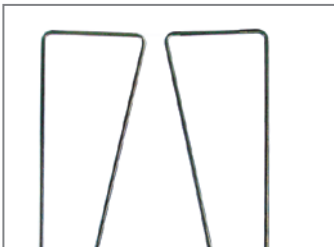



Part No.	415813	Ref. No.	574071
description	heating element 1950W 400V heating circuits 1 L 467mm W 520mm L1 140mm L2 290mm L3 37mm W1 465mm W2 55mm mounting distance 45mm thread M14x1.5 tube ø 8.5mm connection M4 mounting pos. lower-inner dry heating element 2 hole fixing		
For models:	0522102-00, 1422101-00, 2023203-00, 2023203A00, 2023205-00, 2023205A00, 2023503-00, 2023503-01, 2023503A00, 2023503A01, 2063403-00, 2063403-01, 2063406-00, 2063406-01, 2063415-00, 2063415-01, 2063418-00, 2063418-01, 2063502-00, 2063502-01, 2063507-00, 2063507-01, 2063509-00, 2063509-01, 2083202A00, 2083502B00, 2083502B01, 2083502C00, 2083502C01		
accessories for	415813		
	Part No.	510417	Ref. No. —
	flat gasket fibre ED ø 20mm ID ø 14mm thickness 2mm Qty 1 pcs		
	Part No.	520228	Ref. No. —
	tooth lock washer ID ø 15.3mm ED ø 24mm steel Qty 1 pcs for thread M14		
	Part No.	521101	Ref. No. 113000
	nut thread M14x1.5 H 5mm WS 19 SS Qty 1 pcs		
	Part No.	550262	Ref. No. —
	flat gasket copper ED ø 20mm ID ø 14mm thickness 2mm		



			
Part No.	418296	Ref. No.	574138
description	heating element 2000W 230V heating circuits 1 L 554mm W 508mm L1 55mm L2 494mm W1 460mm W2 48mm mounting distance 44mm thread M14x1.5 tube ø 8.5mm connection M4 mounting pos. upper oven heating element 2 hole fixing		
For models:	0522101-04, 1323208-04, 1323210-03, 1323210-04, 1323403-00, 1323403K00, 1323506-00, 1323506-01, 1323506A00, 1323506A01, 1323517-00, 1323517A00, 1363403-03, 1363403-04, 1363403-05, 1363415-05, 1422102-04, 1422102-05, 2123203-08, 2123204-08, 2123208A02, 2123208A03, 2123403-00, 2123403K00, 2123503-06, 2123503-07, 2123503A06, 2123503A07, 2123506-00, 2123506-01, 2123506A00, 2123506A01, 2163403-07, 2163403-08, 2163403-09, 2163406-07, 2163406-08, 2163406-09		
accessories for	418296		
	Part No.	510417	Ref. No. —
	flat gasket fibre ED ø 20mm ID ø 14mm thickness 2mm Qty 1 pcs		
	Part No.	520228	Ref. No. —
	tooth lock washer ID ø 15.3mm ED ø 24mm steel Qty 1 pcs for thread M14		
	Part No.	520230	Ref. No. —
	nut thread M14x1.5 H 5mm WS 19 zinc-coated steel Qty 1 pcs		
	Part No.	521101	Ref. No. 113000
	nut thread M14x1.5 H 5mm WS 19 SS Qty 1 pcs		
	Part No.	550262	Ref. No. —
	flat gasket copper ED ø 20mm ID ø 14mm thickness 2mm		

			
Part No.	418325	Ref. No.	574139
description	heating element 2400W 230V heating circuits 1 L 530mm W 665mm L1 30mm L2 500mm W1 605mm W2 60mm mounting distance 52mm thread M14x1.5 tube ø 8.5mm connection M4 mounting pos. upper dry heating element 2 hole fixing		
For models:	0522102-04, 0722101-06, 1422101-04, 1422101-05, 1422101-06, 1422301-01, 2023114-00, 2023118-00, 2023119-00, 2023203-07, 2023205-07, 2023207-03, 2023207-04, 2023207-05, 2023406-00, 2023503-10, 2023503-11, 2023503-12, 2023503-13, 2023503A10, 2023503A11, 2023503A12, 2023503A13, 2063403-08, 2063403-09, 2063403-10, 2063406-08, 2063406-09, 2063406-10, 2063415-05, 2063418-05, 2063502-08, 2063502-09, 2063502-10, 2063507-08, 2063507-09, 3023205-00, 3023406-00		
accessories for	418325		
	Part No.	510417	Ref. No. —
	flat gasket fibre ED ø 20mm ID ø 14mm thickness 2mm Qty 1 pcs		

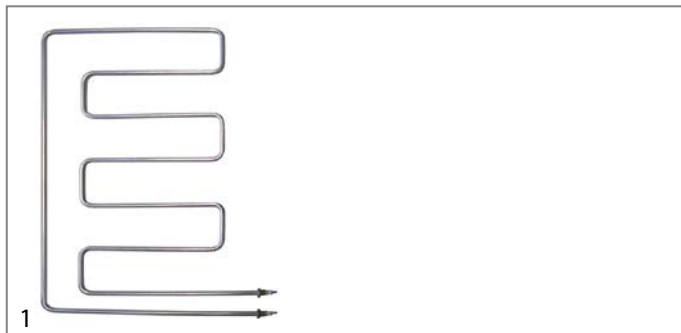

accessories for	418325		
	Part No.	520228	Ref. No. —
	tooth lock washer ID ø 15.3mm ED ø 24mm steel Qty 1 pcs for thread M14		
	Part No.	520230	Ref. No. —
	nut thread M14x1.5 H 5mm WS 19 zinc-coated steel Qty 1 pcs		
	Part No.	521101	Ref. No. 113000
	nut thread M14x1.5 H 5mm WS 19 SS Qty 1 pcs		
	Part No.	550262	Ref. No. —
	flat gasket copper ED ø 20mm ID ø 14mm thickness 2mm		

			
Part No.	416447	Ref. No.	574088
description	heating element 2450W 230V heating circuits 1 L 495mm W 510mm L1 65mm L2 430mm W1 440mm W2 70mm mounting distance 62mm thread M14x1.5 tube ø 8.5mm connection M4 mounting pos. upper dry heating element 2 hole fixing		
For models:	0522101-01, 0522101-02, 0522101-03, 1323208-00, 1323208-01, 1323208-02, 1323208-03, 1323210-00, 1323210-01, 1323210-02, 1363403-00, 1363403-01, 1363403-02, 1422102-01, 1422102-02, 1422102-03, 2123203-01, 2123203-02, 2123203-03, 2123203-04, 2123203-05, 2123203-06, 2123203-07, 2123203A01, 2123203A02, 2123203A03, 2123203A04, 2123204-01, 2123204-02, 2123204-03, 2123204-04, 2123204-05, 2123204-06, 2123204-07, 2123204A01, 2123204A02, 2123204A03, 2123204A04, 2123208-00, 2123208-01, 2123208A00, 2123208A01, 2123503-00, 2123503-01, 2123503-02, 2123503-03, 2123503-04, 2123503-05, 2123503A00, 2123503A01... (Other models you can see in the webshop)		
accessories for	416447		
	Part No.	510417	Ref. No. —
	flat gasket fibre ED ø 20mm ID ø 14mm thickness 2mm Qty 1 pcs		
	Part No.	520228	Ref. No. —
	tooth lock washer ID ø 15.3mm ED ø 24mm steel Qty 1 pcs for thread M14		
	Part No.	521101	Ref. No. 113000
	nut thread M14x1.5 H 5mm WS 19 SS Qty 1 pcs		
	Part No.	550262	Ref. No. —
	flat gasket copper ED ø 20mm ID ø 14mm thickness 2mm		





Part No.	415904	Ref. No.	574086
description	heating element 2900W 230V heating circuits 1 L 490mm W 680mm L1 70mm L2 420mm W1 630mm W2 50mm mounting distance 42mm thread M14x1.5 tube ø 8.5mm connection M4 mounting pos. upper 2 hole fixing		
For models:	0522102-01, 0522102-02, 0522102-03, 1422101-01, 1422101-02, 1422101-03, 2023203-01, 2023203-02, 2023203-03, 2023203-04, 2023203-05, 2023203-06, 2023203A01, 2023203A02, 2023203A03, 2023205-01, 2023205-02, 2023205-03, 2023205-04, 2023205-05, 2023205-06, 2023205A01, 2023205A02, 2023205A03, 2023207-00, 2023207-01, 2023207-02, 2023503-02, 2023503-03, 2023503-04, 2023503-05, 2023503-06, 2023503-07, 2023503-08, 2023503-09, 2023503A02, 2023503A03, 2023503A04, 2023503A05, 2023503A06, 2023503A07, 2023503A08, 2023503A09, 2063403-02, 2063403-03, 2063403-04, 2063403-05, 2063403-06, 2063403-07, 2063406-02... (Other models you can see in the webshop)		
accessories for	415904		
	Part No.	510417	Ref. No. —
	flat gasket fibre ED ø 20mm ID ø 14mm thickness 2mm Qty 1 pcs		
	Part No.	520228	Ref. No. —
	tooth lock washer ID ø 15.3mm ED ø 24mm steel Qty 1 pcs for thread M14		
	Part No.	521101	Ref. No. 113000
	nut thread M14x1.5 H 5mm WS 19 SS Qty 1 pcs		
	Part No.	550262	Ref. No. —
	flat gasket copper ED ø 20mm ID ø 14mm thickness 2mm		

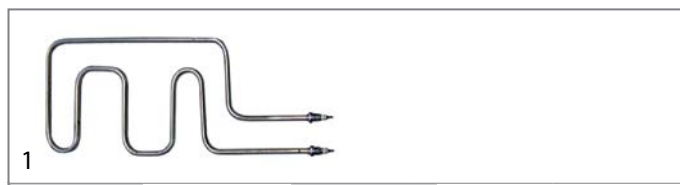

Part No.	415781	Ref. No.	574064
description	heating element 900W 380V heating circuits 1 L 497mm W 313mm L1 80mm L2 417mm W1 180mm W2 133mm mounting distance 126mm thread M14x1.5 tube ø 8.5mm connection M4 mounting pos. upper outer dry heating element 2 hole fixing		
accessories for	415781		
	Part No.	510417	Ref. No. —
	flat gasket fibre ED ø 20mm ID ø 14mm thickness 2mm Qty 1 pcs		
	Part No.	520228	Ref. No. —
	tooth lock washer ID ø 15.3mm ED ø 24mm steel Qty 1 pcs for thread M14		
	Part No.	520230	Ref. No. —
	nut thread M14x1.5 H 5mm WS 19 zinc-coated steel Qty 1 pcs		
	Part No.	521101	Ref. No. 113000
	nut thread M14x1.5 H 5mm WS 19 SS Qty 1 pcs		

accessories for	415781		
	Part No.	550262	Ref. No. —
	flat gasket copper ED ø 20mm ID ø 14mm thickness 2mm		



Part No.	415782	Ref. No.	574065
description	heating element 950W 380V L 452mm W 185mm L1 135mm L2 317mm W1 122mm W2 63mm mounting distance 56mm thread M14x1.5 tube ø 8.5mm connection M4 mounting pos. upper inner dry heating element oven 2 hole fixing		
accessories for	415782		
	Part No.	510417	Ref. No. —
	flat gasket fibre ED ø 20mm ID ø 14mm thickness 2mm Qty 1 pcs		
	Part No.	520228	Ref. No. —
	tooth lock washer ID ø 15.3mm ED ø 24mm steel Qty 1 pcs for thread M14		
	Part No.	520230	Ref. No. —
	nut thread M14x1.5 H 5mm WS 19 zinc-coated steel Qty 1 pcs		
	Part No.	521101	Ref. No. 113000
	nut thread M14x1.5 H 5mm WS 19 SS Qty 1 pcs		
	Part No.	550262	Ref. No. —
	flat gasket copper ED ø 20mm ID ø 14mm thickness 2mm		





heating elements for bain maries



Part No.	415449	Ref. No.	573007
description	heating element 1000W 220V heating circuits 1 L 290mm W 177mm connection M4 tube ø 8.5mm 2 hole fixing thread M14x1.5 immersion heater H 18mm mounting distance 162mm		
For models:	1820501-00, 18208011-0		
accessories for	415449		
	Part No.	510417	Ref. No. —
	flat gasket fibre ED ø 20mm ID ø 14mm thickness 2mm Qty 1 pcs		
	Part No.	520228	Ref. No. —
	tooth lock washer ID ø 15.3mm ED ø 24mm steel Qty 1 pcs for thread M14		
	Part No.	520230	Ref. No. —
	nut thread M14x1.5 H 5mm WS 19 zinc-coated steel Qty 1 pcs		
	Part No.	521101	Ref. No. 113000
	nut thread M14x1.5 H 5mm WS 19 SS Qty 1 pcs		
	Part No.	521103	Ref. No. —
	nut thread M4 H 3mm WS 7 brass Qty 20 pcs		

Table continues overleaf









accessories for 415449			
	Part No. 521104	Ref. No.	—
washer ID ø 4.3mm ED ø 8mm thickness 0.5mm brass Qty 20 pcs for thread M4			
	Part No. 550262	Ref. No.	—
flat gasket copper ED ø 20mm ID ø 14mm thickness 2mm			
	Part No. 560111	Ref. No. 120017	
plain washer ID ø 4.3mm ED ø 9mm thickness 0.8mm SS Qty 20 pcs DIN 125A for thread M4			
	Part No. 560131	Ref. No.	—
hexagonal nut thread M4 H 3.2mm WS 7 SS DIN/ISO DIN 934 / ISO 4032/8673 Qty 20 pcs			

			
Part No.	418302	Ref. No.	573015
description	heating element 1000W 230V heating circuits 1 L 412mm W 100mm flange length 122mm flange width 20mm hole distance 112mm connection length 82mm connection male faston 6.3mm tube ø 8.5mm rectangular flange hole ø 5.4mm dry heating element bain marie		
For models:	1220501-01, 1220802-00, 1220802-01, 1320501-00, 1320501A00, 1320802-00, 1320802A00, 1420501-02, 1420504-02, 1420801-01, 1420803-01, 2020505-02, 2020505-03, 2120501-03, 2120501-04, 2120510-00, 3020505-02		





			
Part No.	415816	Ref. No.	573002
description	heating element 1000W 230V heating circuits 1 L 445mm W 135mm connection M4 tube ø 8.5mm 2 hole fixing thread M14x1.5 immersion heater mounting distance 126mm		
spare parts for	415816		
	Part No. 510417	Ref. No.	—
flat gasket fibre ED ø 20mm ID ø 14mm thickness 2mm Qty 1 pcs			
accessories for	415816		
	Part No. 520228	Ref. No.	—
tooth lock washer ID ø 15.3mm ED ø 24mm steel Qty 1 pcs for thread M14			
	Part No. 520230	Ref. No.	—
nut thread M14x1.5 H 5mm WS 19 zinc-coated steel Qty 1 pcs			
	Part No. 521101	Ref. No. 113000	
nut thread M14x1.5 H 5mm WS 19 SS Qty 1 pcs			
	Part No. 521103	Ref. No.	—
nut thread M4 H 3mm WS 7 brass Qty 20 pcs			
	Part No. 521104	Ref. No.	—
washer ID ø 4.3mm ED ø 8mm thickness 0.5mm brass Qty 20 pcs for thread M4			
	Part No. 550262	Ref. No.	—
flat gasket copper ED ø 20mm ID ø 14mm thickness 2mm			
	Part No. 560111	Ref. No. 120017	
plain washer ID ø 4.3mm ED ø 9mm thickness 0.8mm SS Qty 20 pcs DIN 125A for thread M4			
	Part No. 560131	Ref. No.	—
hexagonal nut thread M4 H 3.2mm WS 7 SS DIN/ISO DIN 934 / ISO 4032/8673 Qty 20 pcs			



			
Part No.	420420	Ref. No.	574145
description	heating element 1200W 230V heating circuits 1 L 545mm W 40mm connection F6.3 tube ø 8.5mm		
For models:	0021130A00, 0021130A01, 1022512-00, 1022603-00, 1220402-00, 1220402-01, 1222603-00, 1320402-00, 1320402-01, 1322603-00, 1322604-00, 1420402-00, 1420402-01, 1420403-01, 1420403-02, 1420403B02, 1420405-00, 1422701-00, 1422702-00, 1520402-00, 1520402-01, 1520403-00, 1520403-01, 1522603-00, 1522603-01, 2020402-00, 2020402-01, 2020403-00, 2020403-01, 2021409-00, 2021409-01, 2021409-02, 2021409B00, 2021409B01, 2021409B02, 2021419-00, 2021419B00, 2021440-00, 2021440-03, 2021440-04, 2021440-05, 2021440A02, 2021440A03, 2021440A04, 2021440A05, 2021440B03, 2021440B04, 2021440B05, 2021440C02, 2021440C03... (Other models you can see in the webshop)		

			
Part No.	418303	Ref. No.	574107
description	heating element 1200W 230V L 510mm W 45mm H connection male faston 6.3mm dry heating element heating circuits 1 tube ø 8.5mm connection distance 35mm		
For models:	0021135A00, 1220504-01, 1222601-00, 1320504-01, 1320504-02, 1322601-00, 1420509-01, 1422601-00, 1422602-00, 2020506-01, 2021401-04, 2021401-05, 2021401-06, 2021401-07, 2021401-08, 2021401-09, 2021401A03, 2021401A04, 2021401A06, 2021401A07, 2021401A08, 2021401A09, 2021401B03, 2021401B04, 2021401B06, 2021401B07, 2021401B08, 2021401B09, 2021401C03, 2021401C04, 2021401C06, 2021401C07, 2021401C08, 2021401C09, 2021402-04, 2021402-05, 2021402-06, 2021402-07, 2021402-08, 2021402A03, 2021402A04, 2021402A06, 2021402A07, 2021402A08, 2021402B03, 2021402B04, 2021402B06, 2021402B07, 2021402B08, 2021402C03... (Other models you can see in the webshop)		





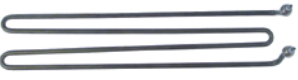



			
Part No.	415420	Ref. No.	573000
description	heating element 1500W 220V heating circuits 1 L 443mm W 114mm connection M4 tube ø 8.5mm 2 hole fixing thread M14x1.5 H 22mm mounting distance 105mm		
accessories for	415420		
	Part No. 510417	Ref. No.	—
flat gasket fibre ED ø 20mm ID ø 14mm thickness 2mm Qty 1 pcs			
	Part No. 520228	Ref. No.	—
tooth lock washer ID ø 15.3mm ED ø 24mm steel Qty 1 pcs for thread M14			
	Part No. 520230	Ref. No.	—
nut thread M14x1.5 H 5mm WS 19 zinc-coated steel Qty 1 pcs			
	Part No. 521101	Ref. No. 113000	
nut thread M14x1.5 H 5mm WS 19 SS Qty 1 pcs			
	Part No. 550262	Ref. No.	—
flat gasket copper ED ø 20mm ID ø 14mm thickness 2mm			

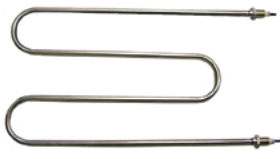

 <p>1</p>			
Part No.	415421	Ref. No.	573004
description	heating element 1500W 220V heating circuits 1 L 445mm W 135mm connection M4 tube ø 8.5mm 2 hole fixing thread M14x1.5 immersion heater L1 20mm L2 50mm L3 380mm W1 20mm W2 117mm mounting distance 129mm		
For models:	0220501-00, 0220502-00, 0220503-00, 1420501-00, 1420502-00, 1420504-00, 1420505-00, 2020501-00, 2020501-01, 20205011-0, 2020502-00, 2020505-00, 2120501-00, 2120501-01, 2120502-00, 2120502-01, 3020501-00, 3020502-00, 3020505-00		
spare parts for	415421		
	Part No.	510407	Ref. No. —
		flat gasket fibre ED ø 78mm ID ø 60mm thickness 2mm for heating element for thread 2" Qty 1 pcs	
accessories for	415421		
	Part No.	510417	Ref. No. —
		flat gasket fibre ED ø 20mm ID ø 14mm thickness 2mm Qty 1 pcs	
	Part No.	520228	Ref. No. —
		tooth lock washer ID ø 15.3mm ED ø 24mm steel Qty 1 pcs for thread M14	
	Part No.	520230	Ref. No. —
		nut thread M14x1.5 H 5mm WS 19 zinc-coated steel Qty 1 pcs	
	Part No.	521101	Ref. No. 113000
		nut thread M14x1.5 H 5mm WS 19 SS Qty 1 pcs	
	Part No.	521103	Ref. No. —
		nut thread M4 H 3mm WS 7 brass Qty 20 pcs	
	Part No.	521104	Ref. No. —
		washer ID ø 4.3mm ED ø 8mm thickness 0.5mm brass Qty 20 pcs for thread M4	
	Part No.	550262	Ref. No. —
		flat gasket copper ED ø 20mm ID ø 14mm thickness 2mm	
	Part No.	560111	Ref. No. 120017
		plain washer ID ø 4.3mm ED ø 9mm thickness 0.8mm SS Qty 20 pcs DIN 125A for thread M4	
	Part No.	560131	Ref. No. —
		hexagonal nut thread M4 H 3.2mm WS 7 SS DIN/ISO DIN 934 / ISO 4032/8673 Qty 20 pcs	

 <p>1</p>			
Part No.	419055	Ref. No.	573020
description	heating element 1750W 400V heating circuits 1 L 490mm W 88.5mm connection M4 tube ø 8.5mm dry heating element W1 10mm W2 75mm 2 hole fixing thread M14x1.5 H 72mm mounting distance 55mm		
For models:	1221501-00, 1221501-01, 1221501-02, 1321501-00, 1321501-01, 1321501-02, 1321501-03, 1421501-01, 1421501-02, 1421503-01, 1421503-02, 1521501-00, 2121501-01, 2121501-02		
accessories for	419055		
	Part No.	520230	Ref. No. —
		nut thread M14x1.5 H 5mm WS 19 zinc-coated steel Qty 1 pcs	
	Part No.	521103	Ref. No. —
		nut thread M4 H 3mm WS 7 brass Qty 20 pcs	

accessories for	419055		
	Part No.	529480	Ref. No. —
		flat gasket copper ED ø 18mm ID ø 14mm thickness 1.5mm	

 <p>1</p>			
Part No.	415419	Ref. No.	573006
description	heating element 2000W 230V heating circuits 1 L 405mm W 218.5mm connection M4 tube ø 8.5mm 2 hole fixing thread M14x1.5 immersion heater mounting distance 210mm		
For models:	20205033-0, 2020504-00		
spare parts for	415419		
	Part No.	510417	Ref. No. —
		flat gasket fibre ED ø 20mm ID ø 14mm thickness 2mm Qty 1 pcs	
accessories for	415419		
	Part No.	520228	Ref. No. —
		tooth lock washer ID ø 15.3mm ED ø 24mm steel Qty 1 pcs for thread M14	
	Part No.	521101	Ref. No. 113000
		nut thread M14x1.5 H 5mm WS 19 SS Qty 1 pcs	
	Part No.	521103	Ref. No. —
		nut thread M4 H 3mm WS 7 brass Qty 20 pcs	
	Part No.	521104	Ref. No. —
		washer ID ø 4.3mm ED ø 8mm thickness 0.5mm brass Qty 20 pcs for thread M4	
	Part No.	550262	Ref. No. —
		flat gasket copper ED ø 20mm ID ø 14mm thickness 2mm	
	Part No.	560111	Ref. No. 120017
		plain washer ID ø 4.3mm ED ø 9mm thickness 0.8mm SS Qty 20 pcs DIN 125A for thread M4	
	Part No.	560131	Ref. No. —
		hexagonal nut thread M4 H 3.2mm WS 7 SS DIN/ISO DIN 934 / ISO 4032/8673 Qty 20 pcs	











 <p>1</p>			
Part No.	415821	Ref. No.	573012
description	heating element 3000W 230V heating circuits 1 L 420mm W 125mm connection M4 tube ø 8.5mm 2 hole fixing thread M14x1.5 immersion heater H 20mm mounting distance 117mm		
spare parts for	415821		
	Part No.	510417	Ref. No. —
		flat gasket fibre ED ø 20mm ID ø 14mm thickness 2mm Qty 1 pcs	
accessories for	415821		
	Part No.	520228	Ref. No. —
		tooth lock washer ID ø 15.3mm ED ø 24mm steel Qty 1 pcs for thread M14	

Table continues overleaf







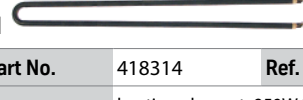

accessories for	415821		
	Part No.	520230	Ref. No. —
	nut thread M14x1.5 H 5mm WS 19 zinc-coated steel Qty 1 pcs		
	Part No.	521101	Ref. No. 113000
	nut thread M14x1.5 H 5mm WS 19 SS Qty 1 pcs		
	Part No.	521103	Ref. No. —
	nut thread M4 H 3mm WS 7 brass Qty 20 pcs		
	Part No.	521104	Ref. No. —
	washer ID ø 4.3mm ED ø 8mm thickness 0.5mm brass Qty 20 pcs for thread M4		
	Part No.	550262	Ref. No. —
	flat gasket copper ED ø 20mm ID ø 14mm thickness 2mm		
	Part No.	560111	Ref. No. 120017
	plain washer ID ø 4.3mm ED ø 9mm thickness 0.8mm SS Qty 20 pcs DIN 125A for thread M4		
	Part No.	560131	Ref. No. —
	hexagonal nut thread M4 H 3.2mm WS 7 SS DIN/ISO DIN 934 / ISO 4032/8673 Qty 20 pcs		

	1		
Part No.	415780	Ref. No.	573096
description	heating element 3000W 230V heating circuits 1 L 465mm W 140mm connection M4 tube ø 8.5mm 2 hole fixing thread M14x1.5 immersion heater L1 25mm L2 40mm L3 400mm W1 25mm W2 105mm mounting distance 125mm		
For models:	0220802-00, 1420801-00, 1420803-00		
spare parts for	415780		
	Part No.	510417	Ref. No. —
	flat gasket fibre ED ø 20mm ID ø 14mm thickness 2mm Qty 1 pcs		
accessories for	415780		
	Part No.	520228	Ref. No. —
	tooth lock washer ID ø 15.3mm ED ø 24mm steel Qty 1 pcs for thread M14		
	Part No.	520230	Ref. No. —
	nut thread M14x1.5 H 5mm WS 19 zinc-coated steel Qty 1 pcs		
	Part No.	521101	Ref. No. 113000
	nut thread M14x1.5 H 5mm WS 19 SS Qty 1 pcs		
	Part No.	550262	Ref. No. —
	flat gasket copper ED ø 20mm ID ø 14mm thickness 2mm		





	1		
Part No.	418314	Ref. No.	573011
description	heating element 950W 230V heating circuits 1 L 390mm W 36mm connection male faston 6.3mm tube ø 8.5mm dry heating element		
For models:	1220504-01, 1222601-00, 1320504-01, 1320504-02, 1322601-00, 1420509-01, 1422601-00, 1422602-00, 2020506-01, 2022601-00, 2022601-01, 2120504-01, 2122601-00, 2122601-01, 2122602-00		

heating elements for frying pans



	1		
Part No.	418279	Ref. No.	574113
description	heating element 1200W 230V L 502mm W 50mm connection male faston 6.3mm tube ø 8.5mm dry heating element H 58mm		
For models:	0221107-00, 0221107A00, 0221108-00, 0221109-00, 0221109A00, 0221110-00, 1121117-00, 1121117-01, 1121117A00, 1121118-00, 1121118-01, 1121119-00, 1121119A00, 1121120-00, 1121121-00, 1121121A00, 1121135A01, 1221103-00, 1221103-01, 1221103-02, 1221103-04, 1221103A00, 1221103A01, 1221103A02, 1221103B00, 1221103B01, 1221103B02, 1221103B04, 1221103J00, 1221103J01, 1221104-00, 1221104-01, 1221104A00, 1221104A01, 1221104B00, 1221104B01, 1221104J00, 1221104J01, 1221105-00, 1221105-01, 1221105-02, 1221105A00, 1221105A01, 1221105A02, 1221105B00, 1221105B01, 1221105B02, 1221106-00, 1221106-01, 1221106A00... (Other models you can see in the webshop)		

	1		
Part No.	415767	Ref. No.	573054 573054/113000/121216
description	heating element 1500W 230V heating circuits 1 L 425mm W 250mm H 58mm W1 50mm W2 150mm L1 60mm L2 365mm thread M14x1.5 mounting distance 142mm windings 3 tube ø 8.5mm connection M4 dry heating element 2 hole fixing for stockpot		
accessories for	415767		
	Part No.	510417	Ref. No. —
	flat gasket fibre ED ø 20mm ID ø 14mm thickness 2mm Qty 1 pcs		
	Part No.	520228	Ref. No. —
	tooth lock washer ID ø 15.3mm ED ø 24mm steel Qty 1 pcs for thread M14		
	Part No.	520230	Ref. No. —
	nut thread M14x1.5 H 5mm WS 19 zinc-coated steel Qty 1 pcs		
	Part No.	521101	Ref. No. 113000
	nut thread M14x1.5 H 5mm WS 19 SS Qty 1 pcs		
	Part No.	521103	Ref. No. —
	nut thread M4 H 3mm WS 7 brass Qty 20 pcs		
	Part No.	521104	Ref. No. —
	washer ID ø 4.3mm ED ø 8mm thickness 0.5mm brass Qty 20 pcs for thread M4		
	Part No.	550262	Ref. No. —
	flat gasket copper ED ø 20mm ID ø 14mm thickness 2mm		
	Part No.	560111	Ref. No. 120017
	plain washer ID ø 4.3mm ED ø 9mm thickness 0.8mm SS Qty 20 pcs DIN 125A for thread M4		
	Part No.	560131	Ref. No. —
	hexagonal nut thread M4 H 3.2mm WS 7 SS DIN/ISO DIN 934 / ISO 4032/8673 Qty 20 pcs		

Part No.	415768	Ref. No.	573055
description	heating element 2500W 230V L 425mm W 220mm connection M4 tube ø 8.5mm 2 hole fixing thread M14x1.5 dry heating element for stockpot L1 65mm L2 360mm W1 43mm W2 134mm H 60mm windings 4 mounting distance 126mm		
For models:	0221202-00, 1421201-00, 1421203-00		
accessories for	415768		
	Part No.	510417	Ref. No. —
	flat gasket fibre ED ø 20mm ID ø 14mm thickness 2mm Qty 1 pcs		
	Part No.	520228	Ref. No. —
	tooth lock washer ID ø 15.3mm ED ø 24mm steel Qty 1 pcs for thread M14		
	Part No.	520230	Ref. No. —
	nut thread M14x1.5 H 5mm WS 19 zinc-coated steel Qty 1 pcs		
	Part No.	521101	Ref. No. 113000
	nut thread M14x1.5 H 5mm WS 19 SS Qty 1 pcs		
	Part No.	550262	Ref. No. —
	flat gasket copper ED ø 20mm ID ø 14mm thickness 2mm		



Part No.	418316	Ref. No.	574104
description	heating element 1500W 230V heating circuits 1 L 455mm W 212mm connection M4 tube ø 8.5mm 2 hole fixing thread M14x1.5 dry heating element chip scuttle L1 40mm L2 35mm L3 380mm W1 32mm W2 147mm mounting distance 138mm		
For models:	0221001H00		
accessories for	418316		
	Part No.	510417	Ref. No. —
	flat gasket fibre ED ø 20mm ID ø 14mm thickness 2mm Qty 1 pcs		
	Part No.	520228	Ref. No. —
	tooth lock washer ID ø 15.3mm ED ø 24mm steel Qty 1 pcs for thread M14		
	Part No.	520230	Ref. No. —
	nut thread M14x1.5 H 5mm WS 19 zinc-coated steel Qty 1 pcs		
	Part No.	521101	Ref. No. 113000
	nut thread M14x1.5 H 5mm WS 19 SS Qty 1 pcs		
	Part No.	550262	Ref. No. —
	flat gasket copper ED ø 20mm ID ø 14mm thickness 2mm		

heating elements for chip scuttles



Part No.	418315	Ref. No.	574054
description	heating element 1000W 230V heating circuits 1 L 385mm W 68mm connection M4 tube ø 8.5mm 2 hole fixing thread M14x1.5 immersion heater chip scuttle mounting distance 60mm		
accessories for	418315		
	Part No.	510417	Ref. No. —
	flat gasket fibre ED ø 20mm ID ø 14mm thickness 2mm Qty 1 pcs		
	Part No.	520228	Ref. No. —
	tooth lock washer ID ø 15.3mm ED ø 24mm steel Qty 1 pcs for thread M14		
	Part No.	520230	Ref. No. —
	nut thread M14x1.5 H 5mm WS 19 zinc-coated steel Qty 1 pcs		
	Part No.	521101	Ref. No. 113000
	nut thread M14x1.5 H 5mm WS 19 SS Qty 1 pcs		
	Part No.	550262	Ref. No. —
	flat gasket copper ED ø 20mm ID ø 14mm thickness 2mm		

heating elements for fryers

2 hole fixing

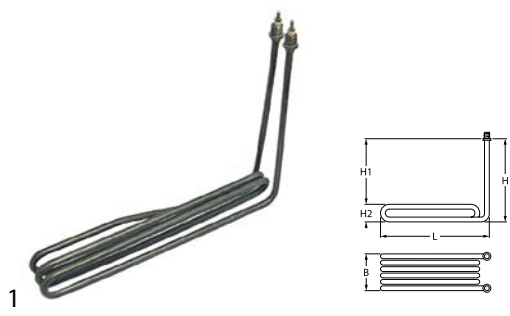



Part No.	415423	Ref. No.	572118
description	heating element 2000W 230V heating circuits 1 L 320mm W 40mm H 215mm H1 175mm H2 40mm thread M14x1.5 tube ø 8.5mm mounting distance 30mm windings 3 2 hole fixing connection M4 connection length 20mm immersion heater SS		
For models:	0220301-00, 0220301D00, 0220302-00, 0220302A00, 0220302A01, 0220302A02, 0220302A03, 0220302D00, 0220302F00, 0220304-00, 0220305-00, 0720325-03, 0720325-04, 0720332P00, 0720332R00, 1220301-00, 1220301-01, 1220301-02, 1220301-03, 1220301-04, 1220301D00, 1220301D01, 1220301J00, 1220301J01, 1220301J02, 1220301J03, 1220302-00, 1220302-01, 1220302D00, 1220303-00, 1220303-01, 1220303-02, 1220303-03, 1220303-04, 1220303-05, 1220303A00, 1220303A01, 1220303A02, 1220303A03, 1220303D00, 1220303D01, 1220303D02, 1220303F01, 1220303F02, 1220303F03, 1220303I00, 1220303I01, 1220303I02, 1220303J01, 1220303J02... (Other models you can see in the webshop)		
spare parts for	415423		
	Part No.	510417	Ref. No. —
	flat gasket fibre ED ø 20mm ID ø 14mm thickness 2mm Qty 1 pcs		





Table continues overleaf

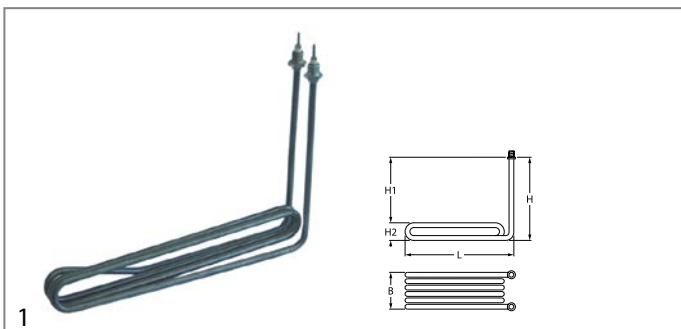







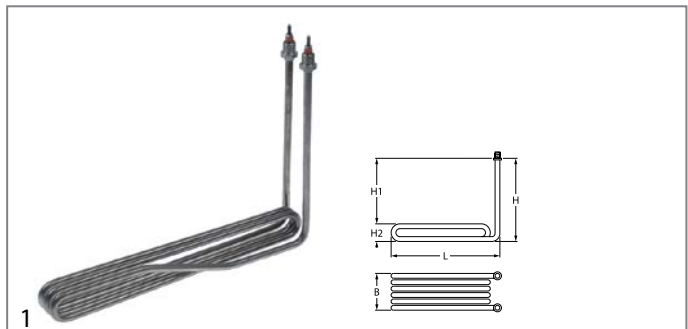

accessories for		415423		
Part No.		520228	Ref. No.	—
	tooth lock washer ID ø 15.3mm ED ø 24mm steel Qty 1 pcs for thread M14			
	nut thread M14x1.5 H 5mm WS 19 zinc-coated steel Qty 1 pcs	520230	Ref. No.	—
	nut thread M14x1.5 H 5mm WS 19 SS Qty 1 pcs	521101	Ref. No.	113000
	nut thread M4 H 3mm WS 7 brass Qty 20 pcs	521103	Ref. No.	—
	washer ID ø 4.3mm ED ø 8mm thickness 0.5mm brass Qty 20 pcs for thread M4	521104	Ref. No.	—
	flat gasket copper ED ø 20mm ID ø 14mm thickness 2mm	550262	Ref. No.	—
	plain washer ID ø 4.3mm ED ø 9mm thickness 0.8mm SS Qty 20 pcs DIN 125A for thread M4	560111	Ref. No.	120017
	hexagonal nut thread M4 H 3.2mm WS 7 SS DIN/ISO DIN 934 / ISO 4032/8673 Qty 20 pcs	560131	Ref. No.	—



Part No.	415728	Ref. No.	572124 572124 (old version)	
description	heating element 3300W 230V heating circuits 1 L 315mm W 33mm H 216mm H1 170mm H2 46mm thread M14x1.5 tube ø 8.5mm mounting distance 30mm windings 3 2 hole fixing connection M4 connection length 22mm immersion heater			
For models:	0220301B00, 0220301B01, 0220301B02, 0220302A00, 0220302B00, 0220302B01, 0220302B02, 0220302C00, 0220302C01, 0220302C02, 0220302C03, 0220302E00, 0220302E01, 0220302H00, 0220302H01, 0220304-00, 0220305-00, 0720325B03, 0720325B04, 1220301B00, 1220301B01, 1220301B02, 1220301B03, 1220301B04, 1220301E00, 1220301E01, 1220302B00, 1220302B01, 1220302E00, 1220303B00, 1220303B01, 1220303B02, 1220303B03, 1220303B04, 1220303B05, 1220303C00, 1220303C01, 1220303C02, 1220303C03, 1220303E00, 1220303E01, 1220303E02, 1220303H00, 1220303H01, 1220303H02, 1220303H03, 1220303K00, 1220303K01, 1220304B00, 1220304B01... (Other models you can see in the webshop)			
accessories for	415728			
	Part No.	520228	Ref. No.	—
	tooth lock washer ID ø 15.3mm ED ø 24mm steel Qty 1 pcs for thread M14			
	Part No.	520230	Ref. No.	—
	nut thread M14x1.5 H 5mm WS 19 zinc-coated steel Qty 1 pcs			
	Part No.	521101	Ref. No.	113000
	nut thread M14x1.5 H 5mm WS 19 SS Qty 1 pcs			
	Part No.	521103	Ref. No.	—
	nut thread M4 H 3mm WS 7 brass Qty 20 pcs			

accessories for		415728		
Part No.		521104	Ref. No.	—
	washer ID ø 4.3mm ED ø 8mm thickness 0.5mm brass Qty 20 pcs for thread M4			
	flat gasket copper ED ø 20mm ID ø 14mm thickness 2mm	550262	Ref. No.	—
	plain washer ID ø 4.3mm ED ø 9mm thickness 0.8mm SS Qty 20 pcs DIN 125A for thread M4	560111	Ref. No.	120017
	hexagonal nut thread M4 H 3.2mm WS 7 SS DIN/ISO DIN 934 / ISO 4032/8673 Qty 20 pcs	560131	Ref. No.	—







Part No.	417729	Ref. No.	572124 (new version)	
description	heating element 3300W 230V heating circuits 1 L 315mm W 33mm H 216mm H1 170mm H2 46mm thread M14x1.5 tube ø 8.5mm mounting distance 30mm windings 3 2 hole fixing connection M4 connection length 22mm immersion heater			
accessories for	417729			
	Part No.	520228	Ref. No.	—
	tooth lock washer ID ø 15.3mm ED ø 24mm steel Qty 1 pcs for thread M14			
	Part No.	520230	Ref. No.	—
	nut thread M14x1.5 H 5mm WS 19 zinc-coated steel Qty 1 pcs			
	Part No.	521101	Ref. No.	113000
	nut thread M14x1.5 H 5mm WS 19 SS Qty 1 pcs			
	Part No.	521103	Ref. No.	—
	nut thread M4 H 3mm WS 7 brass Qty 20 pcs			
	Part No.	521104	Ref. No.	—
	washer ID ø 4.3mm ED ø 8mm thickness 0.5mm brass Qty 20 pcs for thread M4			
	Part No.	550262	Ref. No.	—
	flat gasket copper ED ø 20mm ID ø 14mm thickness 2mm			
	Part No.	560111	Ref. No.	120017
	plain washer ID ø 4.3mm ED ø 9mm thickness 0.8mm SS Qty 20 pcs DIN 125A for thread M4			
	Part No.	560131	Ref. No.	—
	hexagonal nut thread M4 H 3.2mm WS 7 SS DIN/ISO DIN 934 / ISO 4032/8673 Qty 20 pcs			











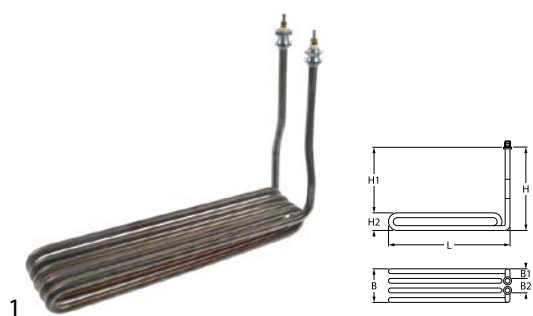

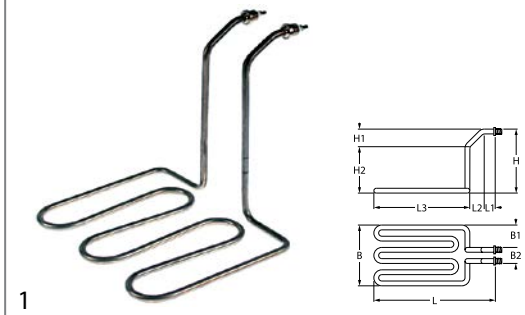

Part No.	415769	Ref. No.	572121 572121+2x113000+2x121216
description	heating element 3300W 230V heating circuits 1 L 320mm W 80mm H 214mm H1 176mm H2 38mm thread M14x1.5 tube ø 8.5mm mounting distance 70mm windings 5 2 hole fixing connection M4 immersion heater		
For models:	0220303-00, 0220303-01, 0220303A00, 0220303A01, 0220303A02, 0220303A03, 0220303D00, 0220303D01, 0220303H00, 0220303H01, 0220306-00, 1220305-00, 1220305-01, 1220305-02, 1220305-03, 1220305-04, 1220305-05, 1220305-06, 1220305-07, 1220305A00, 1220305A01, 1220305A02, 1220305A03, 1220305A04, 1220305A05, 1220305D00, 1220305D01, 1220305D02, 1220305D03, 1220305D04, 1220305F01, 1220305F02, 1220305F03, 1220305F04, 1220305F05, 1220305J01, 1220305J02, 1220306-00, 1220306-01, 1220306A01, 1220306A02, 1220306A03, 1220306A04, 1220306D00, 1220306F00, 1220306F01, 1220306F02, 1220306F03, 1220329-00, 1220329-01... (Other models you can see in the webshop)		
spare parts for	415769		
	Part No.	510417	Ref. No. —
	flat gasket fibre ED ø 20mm ID ø 14mm thickness 2mm Qty 1 pcs		
accessories for	415769		
	Part No.	521103	Ref. No. —
	nut thread M4 H 3mm WS 7 brass Qty 20 pcs		
	Part No.	521104	Ref. No. —
	washer ID ø 4.3mm ED ø 8mm thickness 0.5mm brass Qty 20 pcs for thread M4		
	Part No.	560111	Ref. No. 120017
	plain washer ID ø 4.3mm ED ø 9mm thickness 0.8mm SS Qty 20 pcs DIN 125A for thread M4		
	Part No.	560131	Ref. No. —
	hexagonal nut thread M4 H 3.2mm WS 7 SS DIN/ISO DIN 934 / ISO 4032/8673 Qty 20 pcs		

Part No.	415779	Ref. No.	572128 572128+2x113000+2x121216
description	heating element 3300W 230V heating circuits 1 L 323mm W 70mm H 222mm H1 180mm H2 42mm thread M14x1.5 tube ø 10mm mounting distance 50mm windings 4 2 hole fixing connection M4 immersion heater		
For models:	0220303B00, 0220303B01, 0220303C00, 0220303C01, 0220303C02, 0220303E00, 0220303E01, 0220306-00, 1220305B00, 1220305B01, 1220305B02, 1220305B03, 1220305C00, 1220305C01, 1220305C02, 1220305C03, 1220305C04, 1220305E00, 1220305E01, 1220305E02, 1220305E03, 1220305H00, 1220305H01, 1220305H02, 1220305H03, 1220305H04, 1220306C02, 1220306H01, 1320305B00, 1320305B01, 1320305B02, 1320305B03, 1320305C00, 1320305C01, 1320305C02, 1320305C03, 1320305E00, 1320305E01, 1320305E02, 1320305E03, 1320305E04, 1320305H00, 1320305H01, 1320305H02, 1320305H03, 1320305H04, 1320306C02, 1320306H02, 1420303B00, 1420303B02... (Other models you can see in the webshop)		
accessories for	415779		
	Part No.	521101	Ref. No. 113000
	nut thread M14x1.5 H 5mm WS 19 SS Qty 1 pcs		
	Part No.	521103	Ref. No. —
	nut thread M4 H 3mm WS 7 brass Qty 20 pcs		
	Part No.	521104	Ref. No. —
	washer ID ø 4.3mm ED ø 8mm thickness 0.5mm brass Qty 20 pcs for thread M4		
	Part No.	560111	Ref. No. 120017
	plain washer ID ø 4.3mm ED ø 9mm thickness 0.8mm SS Qty 20 pcs DIN 125A for thread M4		
	Part No.	560131	Ref. No. —
	hexagonal nut thread M4 H 3.2mm WS 7 SS DIN/ISO DIN 934 / ISO 4032/8673 Qty 20 pcs		



			
Part No.	415815	Ref. No.	572135
description	heating element 3560W 230V heating circuits 1 L 490mm W 35mm H 260mm H1 220mm H2 40mm thread M14x1.5 tube ø 8.5mm mounting distance 25mm windings 3 2 hole fixing connection M5 connection length 20mm immersion heater fryer		
For models:	2020303-00, 2020303-01, 2020303-02, 2020303-03, 2020303-04, 2020303A00, 2020310-00, 2020310-01, 2020310-02, 2020310-03, 2020310A00, 2020310A01, 2020310A02, 2020310A03, 2020311-00, 2020311-01, 2020311-02, 2020311-03, 2020311A00, 2020311A01, 2020311A02, 2020311A03, 2020312A00, 2020312A01, 2020312A02, 2020314-01, 2020314-02, 2020314-03, 2020314A01, 2020314A02, 2020314A03, 2020315-01, 2020315-02, 2020315-03, 2020315A01, 2020315A02, 2020315A03, 2020339A00, 2020339A01, 2020340A00, 2020340A01, 2020341-00, 2020341A00, 2020342-00, 2020342A00, 3020310-00, 3020310-01, 3020310A00, 3020310A01, 3020311-00... (Other models you can see in the webshop)		
accessories for	415815		
	Part No.	528401	Ref. No. —
	flat gasket fibre ED ø 22mm ID ø 16mm thickness 2mm Qty 1 pcs		
	Part No.	560112	Ref. No. 120022
	plain washer ID ø 5.3mm ED ø 10mm thickness 1mm SS Qty 20 pcs DIN 125A for thread M5		
	Part No.	560132	Ref. No. —
	hexagonal nut thread M5 H 4mm WS 8 SS DIN/ISO DIN 934 / ISO 4032/8673 Qty 20 pcs		

			
Part No.	417533	Ref. No.	572121(old)
description	heating element 3300W 230V heating circuits 1 L 320mm W 80mm H 220mm W1 20mm W2 47mm H1 175mm H2 42mm thread M14x1.25 tube ø 10mm 2 hole fixing immersion heater		
accessories for	417533		
	Part No.	521103	Ref. No. —
	nut thread M4 H 3mm WS 7 brass Qty 20 pcs		
	Part No.	521104	Ref. No. —
	washer ID ø 4.3mm ED ø 8mm thickness 0.5mm brass Qty 20 pcs for thread M4		
	Part No.	560111	Ref. No. 120017
	plain washer ID ø 4.3mm ED ø 9mm thickness 0.8mm SS Qty 20 pcs DIN 125A for thread M4		
	Part No.	560131	Ref. No. —
	hexagonal nut thread M4 H 3.2mm WS 7 SS DIN/ISO DIN 934 / ISO 4032/8673 Qty 20 pcs		

			
Part No.	418366	Ref. No.	572098
description	heating element 2000W 230V heating circuits 1 mounting pos. centre L 260mm W 260mm H 223mm 2 hole fixing connection M4 fryer L1 20mm L2 40mm L3 200mm W1 88mm W2 84mm H1 33mm H2 190mm tube ø 8.5mm thread M14x1.5 mounting distance 75mm connection length 13mm windings 3		
For models:	0520302A00, 0520302A01		
accessories for	418366		
	Part No.	361182	Ref. No. —
	nut thread 1/4" H 5mm nickel-plated brass WS 17 Qty 1 pcs		
	Part No.	510417	Ref. No. —
	flat gasket fibre ED ø 20mm ID ø 14mm thickness 2mm Qty 1 pcs		
	Part No.	520228	Ref. No. —
	tooth lock washer ID ø 15.3mm ED ø 24mm steel Qty 1 pcs for thread M14		
	Part No.	521103	Ref. No. —
	nut thread M4 H 3mm WS 7 brass Qty 20 pcs		
	Part No.	521104	Ref. No. —
	washer ID ø 4.3mm ED ø 8mm thickness 0.5mm brass Qty 20 pcs for thread M4		
	Part No.	550262	Ref. No. —
	flat gasket copper ED ø 20mm ID ø 14mm thickness 2mm		
	Part No.	560111	Ref. No. 120017
	plain washer ID ø 4.3mm ED ø 9mm thickness 0.8mm SS Qty 20 pcs DIN 125A for thread M4		
	Part No.	560131	Ref. No. —
	hexagonal nut thread M4 H 3.2mm WS 7 SS DIN/ISO DIN 934 / ISO 4032/8673 Qty 20 pcs		

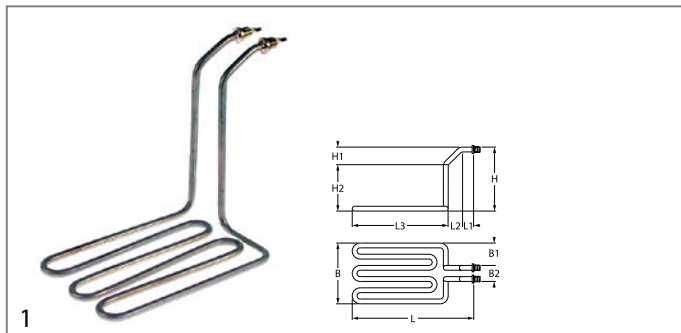

Part No.	418368	Ref. No.	572099
description	heating element 2000W 230V heating circuits 1 mounting pos. left L 285mm W 160mm H 210mm 2 hole fixing connection M4 immersion heater L1 15mm L2 45mm L3 225mm W1 95mm W2 65mm H1 35mm H2 175mm tube ø 8.5mm thread M14x1.5 mounting distance 51mm connection length 30mm windings 3		
For models:	0520302A00, 0520302A01		
accessories for	418368		
	Part No.	510417	Ref. No. —
	flat gasket fibre ED ø 20mm ID ø 14mm thickness 2mm Qty 1 pcs		
	Part No.	520228	Ref. No. —
	tooth lock washer ID ø 15.3mm ED ø 24mm steel Qty 1 pcs for thread M14		
	Part No.	520230	Ref. No. —
	nut thread M14x1.5 H 5mm WS 19 zinc-coated steel Qty 1 pcs		
	Part No.	521101	Ref. No. 113000
	nut thread M14x1.5 H 5mm WS 19 SS Qty 1 pcs		
	Part No.	521103	Ref. No. —
	nut thread M4 H 3mm WS 7 brass Qty 20 pcs		
	Part No.	521104	Ref. No. —
	washer ID ø 4.3mm ED ø 8mm thickness 0.5mm brass Qty 20 pcs for thread M4		
	Part No.	550262	Ref. No. —
	flat gasket copper ED ø 20mm ID ø 14mm thickness 2mm		
	Part No.	560111	Ref. No. 120017
	plain washer ID ø 4.3mm ED ø 9mm thickness 0.8mm SS Qty 20 pcs DIN 125A for thread M4		
	Part No.	560131	Ref. No. —
	hexagonal nut thread M4 H 3.2mm WS 7 SS DIN/ISO DIN 934 / ISO 4032/8673 Qty 20 pcs		

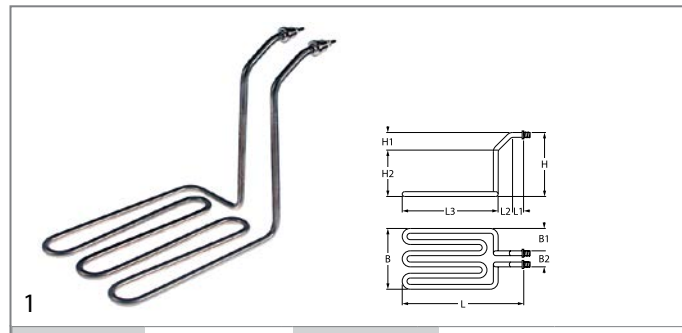

Part No.	418367	Ref. No.	572097
description	heating element 2000W 230V heating circuits 1 mounting pos. right L 285mm W 160mm H 210mm 2 hole fixing connection M4 fryer heaters L1 15mm L2 45mm L3 225mm W1 95mm W2 65mm H1 35mm H2 175mm tube ø 8.5mm thread M14x1.5 mounting distance 51mm connection length 30mm windings 3		
For models:	0520302A00, 0520302A01		
accessories for	418367		
	Part No.	510417	Ref. No. —
	flat gasket fibre ED ø 20mm ID ø 14mm thickness 2mm Qty 1 pcs		
	Part No.	520228	Ref. No. —
	tooth lock washer ID ø 15.3mm ED ø 24mm steel Qty 1 pcs for thread M14		
	Part No.	520230	Ref. No. —
	nut thread M14x1.5 H 5mm WS 19 zinc-coated steel Qty 1 pcs		
	Part No.	521101	Ref. No. 113000
	nut thread M14x1.5 H 5mm WS 19 SS Qty 1 pcs		
	Part No.	521103	Ref. No. —
	nut thread M4 H 3mm WS 7 brass Qty 20 pcs		
	Part No.	521104	Ref. No. —
	washer ID ø 4.3mm ED ø 8mm thickness 0.5mm brass Qty 20 pcs for thread M4		
	Part No.	550262	Ref. No. —
	flat gasket copper ED ø 20mm ID ø 14mm thickness 2mm		
	Part No.	560111	Ref. No. 120017
	plain washer ID ø 4.3mm ED ø 9mm thickness 0.8mm SS Qty 20 pcs DIN 125A for thread M4		
	Part No.	560131	Ref. No. —
	hexagonal nut thread M4 H 3.2mm WS 7 SS DIN/ISO DIN 934 / ISO 4032/8673 Qty 20 pcs		



Part No.	415422	Ref. No.	572062 572064
description	heating element 2000W 230V heating circuits 1 L 300mm W 40mm H 240mm L1 20mm L2 280mm H1 195mm H2 45mm thread M14x1.5 mounting distance 25mm tube ø 8.5mm 2 hole fixing connection M4 connection length 20mm immersion heater windings 3 SS		
accessories for	415422		
	Part No.	510417	Ref. No. —
	flat gasket fibre ED ø 20mm ID ø 14mm thickness 2mm Qty 1 pcs		
	Part No.	520228	Ref. No. —
	tooth lock washer ID ø 15.3mm ED ø 24mm steel Qty 1 pcs for thread M14		
	Part No.	520230	Ref. No. —
	nut thread M14x1.5 H 5mm WS 19 zinc-coated steel Qty 1 pcs		
	Part No.	521101	Ref. No. 113000
	nut thread M14x1.5 H 5mm WS 19 SS Qty 1 pcs		
	Part No.	521103	Ref. No. —
	nut thread M4 H 3mm WS 7 brass Qty 20 pcs		
	Part No.	521104	Ref. No. —
	washer ID ø 4.3mm ED ø 8mm thickness 0.5mm brass Qty 20 pcs for thread M4		
	Part No.	550262	Ref. No. —
	flat gasket copper ED ø 20mm ID ø 14mm thickness 2mm		
	Part No.	560111	Ref. No. 120017
	plain washer ID ø 4.3mm ED ø 9mm thickness 0.8mm SS Qty 20 pcs DIN 125A for thread M4		
	Part No.	560131	Ref. No. —
	hexagonal nut thread M4 H 3.2mm WS 7 SS DIN/ISO DIN 934 / ISO 4032/8673 Qty 20 pcs		



Part No.	415746	Ref. No.	N/A
description	heating element 3300W 230V heating circuits 1 L 320mm W 40mm H 250mm L1 20mm L2 300mm H1 210mm H2 40mm thread M14x1.5 tube ø 8.5mm 2 hole fixing connection M4 fryer heaters windings 3		
accessories for	415746		
	Part No.	510417	Ref. No. —
	flat gasket fibre ED ø 20mm ID ø 14mm thickness 2mm Qty 1 pcs		

accessories for	415746		
	Part No.	520228	Ref. No. —
	tooth lock washer ID ø 15.3mm ED ø 24mm steel Qty 1 pcs for thread M14		
	Part No.	520230	Ref. No. —
	nut thread M14x1.5 H 5mm WS 19 zinc-coated steel Qty 1 pcs		
	Part No.	521101	Ref. No. 113000
	nut thread M14x1.5 H 5mm WS 19 SS Qty 1 pcs		
	Part No.	521103	Ref. No. —
	nut thread M4 H 3mm WS 7 brass Qty 20 pcs		
	Part No.	521104	Ref. No. —
	washer ID ø 4.3mm ED ø 8mm thickness 0.5mm brass Qty 20 pcs for thread M4		
	Part No.	550262	Ref. No. —
	flat gasket copper ED ø 20mm ID ø 14mm thickness 2mm		
	Part No.	560111	Ref. No. 120017
	plain washer ID ø 4.3mm ED ø 9mm thickness 0.8mm SS Qty 20 pcs DIN 125A for thread M4		
	Part No.	560131	Ref. No. —
	hexagonal nut thread M4 H 3.2mm WS 7 SS DIN/ISO DIN 934 / ISO 4032/8673 Qty 20 pcs		

Part No.	415819	Ref. No.	572049
description	heating element 3300W 230V heating circuits 1 L 339mm W 68mm H 235mm L1 17mm L2 322mm H1 200mm H2 35mm thread M14x1.5 mounting distance 60mm tube ø 8.5mm 2 hole fixing connection M4 immersion heater windings 5		
spare parts for	415819		
	Part No.	510417	Ref. No. —
	flat gasket fibre ED ø 20mm ID ø 14mm thickness 2mm Qty 1 pcs		
accessories for	415819		
	Part No.	520228	Ref. No. —
	tooth lock washer ID ø 15.3mm ED ø 24mm steel Qty 1 pcs for thread M14		
	Part No.	520230	Ref. No. —
	nut thread M14x1.5 H 5mm WS 19 zinc-coated steel Qty 1 pcs		
	Part No.	521101	Ref. No. 113000
	nut thread M14x1.5 H 5mm WS 19 SS Qty 1 pcs		
	Part No.	521103	Ref. No. —
	nut thread M4 H 3mm WS 7 brass Qty 20 pcs		
	Part No.	521104	Ref. No. —
	washer ID ø 4.3mm ED ø 8mm thickness 0.5mm brass Qty 20 pcs for thread M4		

Table continues overleaf



accessories for		415819	
	Part No.	550262	Ref. No. —
	flat gasket copper ED \varnothing 20mm ID \varnothing 14mm thickness 2mm		
	Part No.	560111	Ref. No. 120017
	plain washer ID \varnothing 4.3mm ED \varnothing 9mm thickness 0.8mm SS Qty 20 pcs DIN 125A for thread M4		
	Part No.	560131	Ref. No. —
	hexagonal nut thread M4 H 3.2mm WS 7 SS DIN/ISO DIN 934 / ISO 4032/8673 Qty 20 pcs		

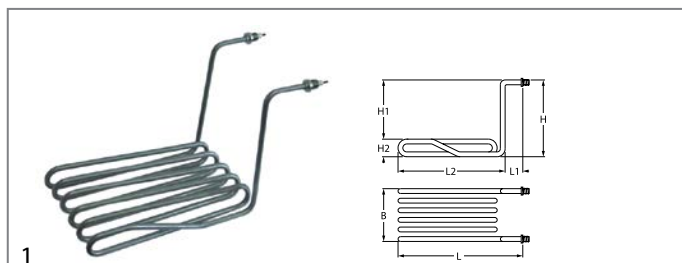

Part No.	415764	Ref. No.	572168 572168+ 2 x 113000+ 2 x 121216
description	heating element 3300W 230V heating circuits 1 L 320mm W 138mm H 182mm L1 56mm L2 264mm H1 145mm H2 37mm thread M14x1.5 mounting distance 124mm tube \varnothing 8.5mm 2 hole fixing connection M4 immersion heater windings 6		
For models:	1820301-00, 1820301-01, 1820301-02		

accessories for		415764	
	Part No.	510417	Ref. No. —
	flat gasket fibre ED \varnothing 20mm ID \varnothing 14mm thickness 2mm Qty 1 pcs		
	Part No.	520228	Ref. No. —
	tooth lock washer ID \varnothing 15.3mm ED \varnothing 24mm steel Qty 1 pcs for thread M14		
	Part No.	520230	Ref. No. —
	nut thread M14x1.5 H 5mm WS 19 zinc-coated steel Qty 1 pcs		
	Part No.	521101	Ref. No. 113000
	nut thread M14x1.5 H 5mm WS 19 SS Qty 1 pcs		
	Part No.	521103	Ref. No. —
	nut thread M4 H 3mm WS 7 brass Qty 20 pcs		
	Part No.	521104	Ref. No. —
	washer ID \varnothing 4.3mm ED \varnothing 8mm thickness 0.5mm brass Qty 20 pcs for thread M4		
	Part No.	550262	Ref. No. —
	flat gasket copper ED \varnothing 20mm ID \varnothing 14mm thickness 2mm		
	Part No.	560111	Ref. No. 120017
	plain washer ID \varnothing 4.3mm ED \varnothing 9mm thickness 0.8mm SS Qty 20 pcs DIN 125A for thread M4		
	Part No.	560131	Ref. No. —
	hexagonal nut thread M4 H 3.2mm WS 7 SS DIN/ISO DIN 934 / ISO 4032/8673 Qty 20 pcs		

Part No.	418857	Ref. No.	572088
description	heating element 2500W 230V heating circuits 1 L 290mm W 155mm H 198mm L1 44mm L2 246mm W1 50mm W2 55mm H1 162mm H2 36mm tube \varnothing 8.5mm connection M4 thread M14x1.5 2 hole fixing windings 5 mounting distance 46mm immersion heater connection length 30mm		

Part No.	415713	Ref. No.	572069
description	heating element 2000W 220V heating circuits 1 L 465mm W 40mm H 205mm 2 hole fixing connection M4 fryer heaters L1 60mm L2 55mm L3 350mm H1 35mm H2 129mm H3 41mm tube \varnothing 8.5mm thread M14x1.5 mounting distance 25mm connection length 20mm		
spare parts for	415713		
	Part No.	510417	Ref. No. —
	flat gasket fibre ED \varnothing 20mm ID \varnothing 14mm thickness 2mm Qty 1 pcs		

accessories for		415713	
	Part No.	520228	Ref. No. —
	tooth lock washer ID \varnothing 15.3mm ED \varnothing 24mm steel Qty 1 pcs for thread M14		
	Part No.	520230	Ref. No. —
	nut thread M14x1.5 H 5mm WS 19 zinc-coated steel Qty 1 pcs		
	Part No.	521101	Ref. No. 113000
	nut thread M14x1.5 H 5mm WS 19 SS Qty 1 pcs		
	Part No.	521103	Ref. No. —
	nut thread M4 H 3mm WS 7 brass Qty 20 pcs		
	Part No.	521104	Ref. No. —
	washer ID \varnothing 4.3mm ED \varnothing 8mm thickness 0.5mm brass Qty 20 pcs for thread M4		
	Part No.	550262	Ref. No. —
	flat gasket copper ED \varnothing 20mm ID \varnothing 14mm thickness 2mm		
	Part No.	560111	Ref. No. 120017
	plain washer ID \varnothing 4.3mm ED \varnothing 9mm thickness 0.8mm SS Qty 20 pcs DIN 125A for thread M4		
	Part No.	560131	Ref. No. —
	hexagonal nut thread M4 H 3.2mm WS 7 SS DIN/ISO DIN 934 / ISO 4032/8673 Qty 20 pcs		



Part No.	415710	Ref. No.	572076
description	heating element 2000W 230V heating circuits 1 L 370mm W 30mm H 235mm L1 25mm L2 355mm H2 195mm H3 40mm thread M14x1.5 mounting distance 35mm tube \varnothing 8.5mm 2 hole fixing connection male faston 6.3mm immersion heater windings 3		
spare parts for	415710		
	Part No.	510417	Ref. No. —
	flat gasket fibre ED \varnothing 20mm ID \varnothing 14mm thickness 2mm Qty 1 pcs		
accessories for	415710		
	Part No.	520228	Ref. No. —
	tooth lock washer ID \varnothing 15.3mm ED \varnothing 24mm steel Qty 1 pcs for thread M14		
	Part No.	520230	Ref. No. —
	nut thread M14x1.5 H 5mm WS 19 zinc-coated steel Qty 1 pcs		
	Part No.	521101	Ref. No. 113000
	nut thread M14x1.5 H 5mm WS 19 SS Qty 1 pcs		
	Part No.	550262	Ref. No. —
	flat gasket copper ED \varnothing 20mm ID \varnothing 14mm thickness 2mm		

Part No.	418311	Ref. No.	572026
description	heating element 3300W 230V heating circuits 1 mounting pos. centre L 490mm W 300mm H 190mm 2 hole fixing connection M4 fryer heaters L1 60mm L2 430mm W1 113mm W2 75mm tube \varnothing 8.5mm thread M14x1.5 mounting distance 68mm windings 4		
accessories for	418311		
	Part No.	510417	Ref. No. —
	flat gasket fibre ED \varnothing 20mm ID \varnothing 14mm thickness 2mm Qty 1 pcs		
	Part No.	520228	Ref. No. —
	tooth lock washer ID \varnothing 15.3mm ED \varnothing 24mm steel Qty 1 pcs for thread M14		
	Part No.	520230	Ref. No. —
	nut thread M14x1.5 H 5mm WS 19 zinc-coated steel Qty 1 pcs		
	Part No.	521101	Ref. No. 113000
	nut thread M14x1.5 H 5mm WS 19 SS Qty 1 pcs		
	Part No.	521103	Ref. No. —
	nut thread M4 H 3mm WS 7 brass Qty 20 pcs		

accessories for	418311		
	Part No.	521104	Ref. No. —
	washer ID \varnothing 4.3mm ED \varnothing 8mm thickness 0.5mm brass Qty 20 pcs for thread M4		
	Part No.	550262	Ref. No. —
	flat gasket copper ED \varnothing 20mm ID \varnothing 14mm thickness 2mm		
	Part No.	560111	Ref. No. 120017
	plain washer ID \varnothing 4.3mm ED \varnothing 9mm thickness 0.8mm SS Qty 20 pcs DIN 125A for thread M4		
	Part No.	560131	Ref. No. —
	hexagonal nut thread M4 H 3.2mm WS 7 SS DIN/ISO DIN 934 / ISO 4032/8673 Qty 20 pcs		

Part No.	418313	Ref. No.	572027
description	heating element 3300W 230V heating circuits 1 mounting pos. left L 500mm W 335mm H 170mm 2 hole fixing connection M4 fryer heaters L1 100mm L2 410mm W1 135mm W2 200mm tube \varnothing 8.5mm thread M14x1.5 mounting distance 50mm connection length 46mm windings 3		
accessories for	418313		
	Part No.	510417	Ref. No. —
	flat gasket fibre ED \varnothing 20mm ID \varnothing 14mm thickness 2mm Qty 1 pcs		
	Part No.	520228	Ref. No. —
	tooth lock washer ID \varnothing 15.3mm ED \varnothing 24mm steel Qty 1 pcs for thread M14		
	Part No.	520230	Ref. No. —
	nut thread M14x1.5 H 5mm WS 19 zinc-coated steel Qty 1 pcs		
	Part No.	521101	Ref. No. 113000
	nut thread M14x1.5 H 5mm WS 19 SS Qty 1 pcs		
	Part No.	521103	Ref. No. —
	nut thread M4 H 3mm WS 7 brass Qty 20 pcs		
	Part No.	521104	Ref. No. —
	washer ID \varnothing 4.3mm ED \varnothing 8mm thickness 0.5mm brass Qty 20 pcs for thread M4		
	Part No.	550262	Ref. No. —
	flat gasket copper ED \varnothing 20mm ID \varnothing 14mm thickness 2mm		
	Part No.	560111	Ref. No. 120017
	plain washer ID \varnothing 4.3mm ED \varnothing 9mm thickness 0.8mm SS Qty 20 pcs DIN 125A for thread M4		
	Part No.	560131	Ref. No. —
	hexagonal nut thread M4 H 3.2mm WS 7 SS DIN/ISO DIN 934 / ISO 4032/8673 Qty 20 pcs		

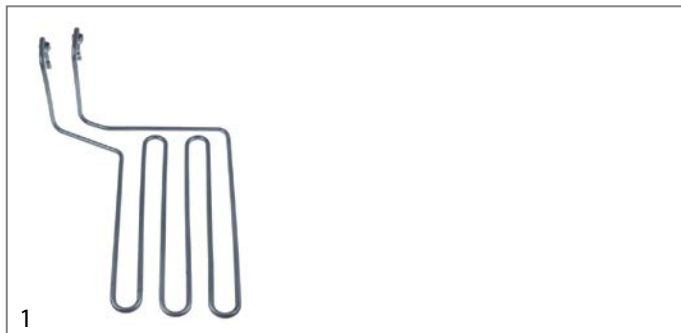

Part No.	418312	Ref. No.	572025
description	heating element 3300W 230V mounting pos. right L 500mm W 335mm H 170mm 2 hole fixing connection M4 fryer heaters L1 100mm L2 410mm W1 135mm W2 200mm tube ø 8.5mm thread M14x1.5 mounting distance 50mm connection length 46mm windings 3		
accessories for	418312		
	Part No.	510417	Ref. No. —
	flat gasket fibre ED ø 20mm ID ø 14mm thickness 2mm Qty 1 pcs		
	Part No.	520228	Ref. No. —
	tooth lock washer ID ø 15.3mm ED ø 24mm steel Qty 1 pcs for thread M14		
	Part No.	520230	Ref. No. —
	nut thread M14x1.5 H 5mm WS 19 zinc-coated steel Qty 1 pcs		
	Part No.	521101	Ref. No. 113000
	nut thread M14x1.5 H 5mm WS 19 SS Qty 1 pcs		
	Part No.	521103	Ref. No. —
	nut thread M4 H 3mm WS 7 brass Qty 20 pcs		
	Part No.	521104	Ref. No. —
	washer ID ø 4.3mm ED ø 8mm thickness 0.5mm brass Qty 20 pcs for thread M4		
	Part No.	550262	Ref. No. —
	flat gasket copper ED ø 20mm ID ø 14mm thickness 2mm		
	Part No.	560111	Ref. No. 120017
	plain washer ID ø 4.3mm ED ø 9mm thickness 0.8mm SS Qty 20 pcs DIN 125A for thread M4		
	Part No.	560131	Ref. No. —
	hexagonal nut thread M4 H 3.2mm WS 7 SS DIN/ISO DIN 934 / ISO 4032/8673 Qty 20 pcs		

	Part No.	415446	Ref. No.	203550
description	heating element 1250W 230V heating circuits 1 L 450mm W 65mm H 60mm tube ø 6.5mm W1 43mm W2 25mm connection male faston 6.3mm connection length 24mm connection distance 19mm dry heating element			

	Part No.	415425	Ref. No.	574099
description	heating element 1250W 230V heating circuits 1 L 470mm W 64mm H 60mm tube ø 6.5mm L1 230mm connection male faston 6.3mm connection length 25mm connection distance 15mm dry heating element			
For models:	0221101-00, 0221101-01, 0221101A00, 0221101A01, 0221102-00, 0221102-01, 0221103-00, 0221103-01, 0221104-00, 0221104-01, 0221104A00, 0221104A01, 0221105-00, 0221105-01, 0221106-00, 0221106-01, 1221101-00, 1221101A00, 1221101B00, 1221102-00, 1221102A00, 1221102B00, 1421101-00, 1421101A00, 1421102-00, 1421103-00, 1421104-00, 1421104A00, 1421105-00, 1421106-00, 1421107-00, 1421107A00, 1421108-00, 1421109-00, 1421110-00, 1421110A00, 1421111-00, 1421112-00, 2021101-00, 20211011-0, 2021101A00, 2021102-00, 20211022-0, 2021103-00, 20211033-0, 2021104-00, 20211044-0, 2021104A00, 2021105-00, 20211055-0... (Other models you can see in the webshop)			

	Part No.	420543	Ref. No.	574162
description	heating element 2000W 400V heating circuits 1 L 320mm W 120mm H 144mm tube ø 6.5mm			
For models:	1423502-02, 1423502A02, 1423525A00, 1423527A00, 1523502A00, 2023502-07, 2023502A07, 2023503-13, 2023503A13, 2023525A00, 2223502-00, 2223502A00, 3023502-06, 3023502A06			

	Part No.	418295	Ref. No.	574109
description	heating element 300W 230V heating circuits 1 L 481mm W 108mm H 50mm tube ø 8.5mm connection M4 connection distance 100mm dry heating element			
For models:	2123202A00, 2123202A01, 2123203A00, 2123203A01, 2123203A02, 2123203A03, 2123203A04, 2123204A00, 2123204A01, 2123204A02, 2123204A03, 2123204A04			

heating elements for griddles

	Part No.	419246	Ref. No.	574156
description	heating element 1200W 230V heating circuits 1 L 534mm W 36mm H 65mm tube ø 8.5mm connection 6.3x0.8			
For models:	0721134-01, 0721134A01, 0721172A01, 0721173A01, 0721174A01, 0721175A01, 1021130A00, 1021135A00, 1221130J00, 1221141-00, 1221141A00, 1221156A00, 1222507-00, 1222509-00, 1321130-00, 1321130A00, 1321131-00, 1321131A00, 1321141-00, 1321141A00, 1322507-00, 1322509-00, 1421126B00, 1421127B00, 1421130B00, 1421131-00, 1421131A00, 1421131B00, 1421134-00, 1421134-01, 1421134A00, 1421134A01, 1421139-00, 1421139A00, 1421139B00, 1421141-00, 1421141A00, 1421141B00, 1421143B01, 1421144B01, 1421145B01, 1421149B00, 1421149B01, 1421150B00, 1421150B01, 1421151B00, 1421151B01, 1421155B02, 1421156B02, 1421157B02... (Other models you can see in the webshop)			



heating elements for large hobs



Part No.	420361	Ref. No.	574151
description	heating element 4300W 400V heating circuits 1 L 450mm W 280mm H 100mm connection cable tube ø 13x6mm cable length 430mm dry heating element		
For models:	2021115-00, 2021115-01, 2021115-02, 2021115-03, 2021115-04, 2221115-00, 2221115-01		



Part No.	418255	Ref. No.	574114
description	heating element 600W 80V heating circuits 1 L 332mm W 54mm H 54mm tube ø 8.5mm mounting pos. connection male faston 6.3mm connection distance 45mm windings 1 dry heating element suitable for MKN series 700		
For models:	2020406A01, 2120406A00, 2120406A01, 2123502-00, 2123502-01, 2123502-02, 2123502A00, 2123502A01, 2123502A02, 2123503-00, 2123503-01, 2123503-02, 2123503-03, 2123503-04, 2123503-05, 2123503-06, 2123503A00, 2123503A01, 2123503A03, 2123503A04, 2123503A05, 2123503A06, 4228801-00, 4228801-01		

heating elements for tilting bratt pan



Part No.	418303	Ref. No.	574107
description	heating element 1200W 230V L 510mm W 45mm Hmm connection male faston 6.3mm dry heating element heating circuits 1 tube ø 8.5mm connection distance 35mm		
For models:	0021135A00, 1220504-01, 1222601-00, 1320504-01, 1320504-02, 1322601-00, 1420509-01, 1422601-00, 1422602-00, 2020506-01, 2021401-04, 2021401-05, 2021401-06, 2021401-07, 2021401-08, 2021401-09, 2021401A03, 2021401A04, 2021401A06, 2021401A07, 2021401A08, 2021401A09, 2021401B03, 2021401B04, 2021401B06, 2021401B07, 2021401B08, 2021401B09, 2021401C03, 2021401C04, 2021401C06, 2021401C07, 2021401C08, 2021401C09, 2021402-04, 2021402-05, 2021402-06, 2021402-07, 2021402-08, 2021402A03, 2021402A04, 2021402A06, 2021402A07, 2021402A08, 2021402B03, 2021402B04, 2021402B06, 2021402B07, 2021402B08, 2021402C03... (Other models you can see in the webshop)		



Part No.	415475	Ref. No.	574084
description	heating element 1670W 230V L 110mm W 430mm H 45mm connection M4 dry heating element heating circuits 1 tube ø 8.5mm W1 200mm W2 30mm mounting pos. inner connection distance 22mm		



Part No.	415476	Ref. No.	574085
description	heating element 1670W 230V L 650mm W 470mm H 35mm connection M4 dry heating element heating circuits 1 tube ø 8.5mm W2 45mm mounting pos. outer connection distance 37mm		



Part No.	415477	Ref. No.	574102
description	heating element 1670W 230V L 95mm W 465mm H 45mm connection M4 dry heating element heating circuits 1 tube ø 8.5mm W1 220mm W2 25mm connection distance 16mm		
For models:	2021401-00, 2021401-01, 2021401-02, 2021401-03, 2021401A00, 2021401A01, 2021401A02, 2021401B00, 2021401B01, 2021401B02, 2021401C00, 2021401C01, 2021401C02, 2021402-00, 2021402-01, 2021402-02, 2021402-03, 2021402A00, 2021402A01, 2021402A02, 2021402B00, 2021402B01, 2021402B02, 2021402C00, 2021402C01, 2021402C02, 2021403-00, 2021403-01, 2021403-02, 20214033-0, 2021403A00, 2021403A01, 2021403B00, 2021403B01, 2021403C01, 2021404-00, 2021404-01, 2021404-02, 20214044-0, 2021404A00, 2021404A01, 2021404B00, 2021404B01, 2021404C00, 2021404C01, 2021405-00, 20214055-0, 2021405B00, 2021406-00, 20214066-0... (Other models you can see in the webshop)		

heating elements for pasta cookers

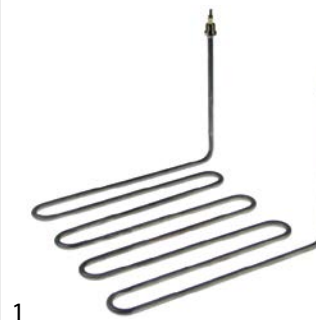





Part No.	418326	Ref. No.	327649 572170
description	heating element 3300W 400V heating circuits 1 L 315mm W 310mm H 215mm 2 hole fixing connection M4 thread M14x1.5 tube ø 8.5mm stainless steel mounting distance 302mm connection length 21mm pasta cooker immersion heater		
For models:	1320401-00, 1320401-01, 1420401-00, 1420401-01, 2020401-00, 2020401-01, 2120401-00, 2120401-01		
spare parts for	418326		
		Part No.	510417
		Ref. No.	—
	flat gasket fibre ED ø 20mm ID ø 14mm thickness 2mm Qty 1 pcs		

Table continues overleaf







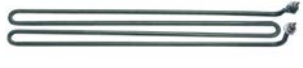

accessories for		418326	
	Part No.	520228	Ref. No. —
tooth lock washer ID ø 15.3mm ED ø 24mm steel Qty 1 pcs for thread M14			
	Part No.	520230	Ref. No. —
nut thread M14x1.5 H 5mm WS 19 zinc-coated steel Qty 1 pcs			
	Part No.	521101	Ref. No. 113000
nut thread M14x1.5 H 5mm WS 19 SS Qty 1 pcs			
	Part No.	550262	Ref. No. —
flat gasket copper ED ø 20mm ID ø 14mm thickness 2mm			

heating elements for rechauds

1			
Part No.	415767	Ref. No.	573054 573054/113000/121216
description heating element 1500W 230V heating circuits 1 L 425mm W 250mm H 58mm W1 50mm W2 150mm L1 60mm L2 365mm thread M14x1.5 mounting distance 142mm windings 3 tube ø 8.5mm connection M4 dry heating element 2 hole fixing for stockpot			
accessories for		415767	
	Part No.	510417	Ref. No. —
flat gasket fibre ED ø 20mm ID ø 14mm thickness 2mm Qty 1 pcs			
	Part No.	520228	Ref. No. —
tooth lock washer ID ø 15.3mm ED ø 24mm steel Qty 1 pcs for thread M14			
	Part No.	520230	Ref. No. —
nut thread M14x1.5 H 5mm WS 19 zinc-coated steel Qty 1 pcs			
	Part No.	521101	Ref. No. 113000
nut thread M14x1.5 H 5mm WS 19 SS Qty 1 pcs			
	Part No.	521103	Ref. No. —
nut thread M4 H 3mm WS 7 brass Qty 20 pcs			
	Part No.	521104	Ref. No. —
washer ID ø 4.3mm ED ø 8mm thickness 0.5mm brass Qty 20 pcs for thread M4			
	Part No.	550262	Ref. No. —
flat gasket copper ED ø 20mm ID ø 14mm thickness 2mm			
	Part No.	560111	Ref. No. 120017
plain washer ID ø 4.3mm ED ø 9mm thickness 0.8mm SS Qty 20 pcs DIN 125A for thread M4			
	Part No.	560131	Ref. No. —
hexagonal nut thread M4 H 3.2mm WS 7 SS DIN/ISO DIN 934 / ISO 4032/8673 Qty 20 pcs			

heating elements for chargrills

1			
Part No.	415522	Ref. No.	574091
description heating element 800W 380V L 480mm W 68mm H 74mm thread M14x1.5 mounting distance 37mm tube ø 8.5mm connection M4 heating circuits 1 2 hole fixing dry heating element W1 10mm W2 48mm			
accessories for		415522	
	Part No.	510417	Ref. No. —
flat gasket fibre ED ø 20mm ID ø 14mm thickness 2mm Qty 1 pcs			
	Part No.	520228	Ref. No. —
tooth lock washer ID ø 15.3mm ED ø 24mm steel Qty 1 pcs for thread M14			
	Part No.	520230	Ref. No. —
nut thread M14x1.5 H 5mm WS 19 zinc-coated steel Qty 1 pcs			
	Part No.	521101	Ref. No. 113000
nut thread M14x1.5 H 5mm WS 19 SS Qty 1 pcs			
	Part No.	550262	Ref. No. —
flat gasket copper ED ø 20mm ID ø 14mm thickness 2mm			

1			
Part No.	415427	Ref. No.	574027
description heating element 820W 95V L 504mm W 33mm H 105mm 2 hole fixing mounting distance 27mm connection M4 L1 27mm L2 477mm heating circuits 1 tube ø 8.5mm dry heating element thread M14x1.5			
accessories for		415427	
	Part No.	510417	Ref. No. —
flat gasket fibre ED ø 20mm ID ø 14mm thickness 2mm Qty 1 pcs			
	Part No.	520228	Ref. No. —
tooth lock washer ID ø 15.3mm ED ø 24mm steel Qty 1 pcs for thread M14			
	Part No.	520230	Ref. No. —
nut thread M14x1.5 H 5mm WS 19 zinc-coated steel Qty 1 pcs			
	Part No.	521101	Ref. No. 113000
nut thread M14x1.5 H 5mm WS 19 SS Qty 1 pcs			
	Part No.	550262	Ref. No. —
flat gasket copper ED ø 20mm ID ø 14mm thickness 2mm			









			
Part No.	415426	Ref. No.	574097
description	heating element 870W 95V L 495mm W 35mm H 73mm thread M14x1.5 mounting distance 35mm tube ø 8.5mm connection M4 heating circuits 1 connection length 20mm 2 hole fixing dry heating element		
For models:	0221501-00, 0221502-00, 1421501-00, 1421502-00, 1421503-00, 1421504-00, 2121501-00, 2121502-00		
accessories for	415426		
	Part No.	510417	Ref. No. —
	Part No.	520228	Ref. No. —
	Part No.	520230	Ref. No. —
	Part No.	521101	Ref. No. 113000
	Part No.	550262	Ref. No. —

heating elements for salamanders/toast-

			
Part No.	415730	Ref. No.	N/A
description	heating element 1100W 230V L 275mm W 143mm 2 hole fixing thread M14x1.5 mounting distance 137mm connection M4 dry heating element tube ø 8.5mm heating circuits 1		
accessories for	415730		
	Part No.	510417	Ref. No. —
	Part No.	520228	Ref. No. —
	Part No.	520230	Ref. No. —
	Part No.	521101	Ref. No. 113000
	Part No.	521103	Ref. No. —
	Part No.	521104	Ref. No. —
	Part No.	550262	Ref. No. —
	Part No.	560111	Ref. No. 120017

accessories for	415730		
	Part No.	560131	Ref. No. —

			
Part No.	415418	Ref. No.	203556 574095
description	heating element 1650W 230V L 260mm W 250mm 2 hole fixing thread M14x1.5 mounting distance 243mm connection male faston 6.3mm dry heating element tube ø 6.5mm heating circuits 1 connection length 20mm H 6.5mm		
For models:	00217022-0, 0521702-00, 0521702-01, 0521702-02, 0521702-03, 0521702-04, 0521702C04		
accessories for	415418		
	Part No.	510417	Ref. No. —
	Part No.	520228	Ref. No. —
	Part No.	520230	Ref. No. —
	Part No.	521101	Ref. No. 113000
	Part No.	550262	Ref. No. —







			
Part No.	415514	Ref. No.	574116 720003
description	heating element 1650W 230V L 315mm W 200mm 2 hole fixing thread M14x1.5 mounting distance 193mm connection M4 dry heating element tube ø 6.3mm heating circuits 1 H 6.3mm		
For models:	0521704-04, 0521704-05, 0521704-06, 0521704-07		
spare parts for	415514		
	Part No.	510417	Ref. No. —
accessories for	415514		
	Part No.	520228	Ref. No. —
	Part No.	520230	Ref. No. —

Table continues overleaf

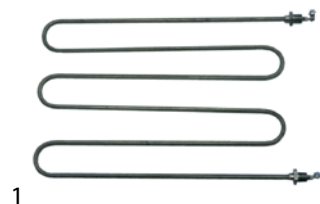

accessories for 415514			
	Part No. 521101	Ref. No.	113000
	nut thread M14x1.5 H 5mm WS 19 SS Qty 1 pcs		
	Part No. 521103	Ref. No.	—
	nut thread M4 H 3mm WS 7 brass Qty 20 pcs		
	Part No. 521104	Ref. No.	—
	washer ID ø 4.3mm ED ø 8mm thickness 0.5mm brass Qty 20 pcs for thread M4		
	Part No. 550262	Ref. No.	—
	flat gasket copper ED ø 20mm ID ø 14mm thickness 2mm		
	Part No. 560111	Ref. No.	120017
	plain washer ID ø 4.3mm ED ø 9mm thickness 0.8mm SS Qty 20 pcs DIN 125A for thread M4		
	Part No. 560131	Ref. No.	—
	hexagonal nut thread M4 H 3.2mm WS 7 SS DIN/ISO DIN 934 / ISO 4032/8673 Qty 20 pcs		

 <p>1</p>			
Part No.	415519	Ref. No.	574035
description	heating element 2000W 230V L 615mm W 100mm 2 hole fixing thread M14x1.5 mounting distance 87mm connection M4 dry heating element tube ø 8.5mm heating circuits 1 connection length 58mm		
accessories for 415519			
	Part No. 510417	Ref. No.	—
	flat gasket fibre ED ø 20mm ID ø 14mm thickness 2mm Qty 1 pcs		
	Part No. 520228	Ref. No.	—
	tooth lock washer ID ø 15.3mm ED ø 24mm steel Qty 1 pcs for thread M14		
	Part No. 520230	Ref. No.	—
	nut thread M14x1.5 H 5mm WS 19 zinc-coated steel Qty 1 pcs		
	Part No. 521101	Ref. No.	113000
	nut thread M14x1.5 H 5mm WS 19 SS Qty 1 pcs		
	Part No. 521103	Ref. No.	—
	nut thread M4 H 3mm WS 7 brass Qty 20 pcs		
	Part No. 521104	Ref. No.	—
	washer ID ø 4.3mm ED ø 8mm thickness 0.5mm brass Qty 20 pcs for thread M4		
	Part No. 550262	Ref. No.	—
	flat gasket copper ED ø 20mm ID ø 14mm thickness 2mm		
	Part No. 560111	Ref. No.	120017
	plain washer ID ø 4.3mm ED ø 9mm thickness 0.8mm SS Qty 20 pcs DIN 125A for thread M4		
	Part No. 560131	Ref. No.	—
	hexagonal nut thread M4 H 3.2mm WS 7 SS DIN/ISO DIN 934 / ISO 4032/8673 Qty 20 pcs		

 <p>1</p>			
Part No.	415417	Ref. No.	203553 574094
description	heating element 2500W 230V L 425mm W 260mm 2 hole fixing thread M14x1.5 mounting distance 247mm connection male faston 6.3mm dry heating element tube ø 6.5mm heating circuits 1 H 6.5mm		
For models:	0521701-00, 0521701-01		
spare parts for 415417			
	Part No. 510417	Ref. No.	—
	flat gasket fibre ED ø 20mm ID ø 14mm thickness 2mm Qty 1 pcs		
accessories for 415417			
	Part No. 520228	Ref. No.	—
	tooth lock washer ID ø 15.3mm ED ø 24mm steel Qty 1 pcs for thread M14		
	Part No. 520230	Ref. No.	—
	nut thread M14x1.5 H 5mm WS 19 zinc-coated steel Qty 1 pcs		
	Part No. 521101	Ref. No.	113000
	nut thread M14x1.5 H 5mm WS 19 SS Qty 1 pcs		
	Part No. 550262	Ref. No.	—
	flat gasket copper ED ø 20mm ID ø 14mm thickness 2mm		













 <p>1</p>			
Part No.	415817	Ref. No.	574032 574032+2x113000+2x121216
description	heating element 3300W 230V L 490mm W 260mm 2 hole fixing thread M14x1.5 mounting distance 252mm connection M4 dry heating element tube ø 8.5mm heating circuits 1 connection length 20mm H 8.5mm		
spare parts for 415817			
	Part No. 510417	Ref. No.	—
	flat gasket fibre ED ø 20mm ID ø 14mm thickness 2mm Qty 1 pcs		
accessories for 415817			
	Part No. 520228	Ref. No.	—
	tooth lock washer ID ø 15.3mm ED ø 24mm steel Qty 1 pcs for thread M14		
	Part No. 520230	Ref. No.	—
	nut thread M14x1.5 H 5mm WS 19 zinc-coated steel Qty 1 pcs		
	Part No. 521101	Ref. No.	113000
	nut thread M14x1.5 H 5mm WS 19 SS Qty 1 pcs		





Table continues overleaf











accessories for		415817		
	Part No.	521103	Ref. No.	—
nut thread M4 H 3mm WS 7 brass Qty 20 pcs				
	Part No.	521104	Ref. No.	—
washer ID ø 4.3mm ED ø 8mm thickness 0.5mm brass Qty 20 pcs for thread M4				
	Part No.	550262	Ref. No.	—
flat gasket copper ED ø 20mm ID ø 14mm thickness 2mm				
	Part No.	560111	Ref. No.	120017
plain washer ID ø 4.3mm ED ø 9mm thickness 0.8mm SS Qty 20 pcs DIN 125A for thread M4				
	Part No.	560131	Ref. No.	—
hexagonal nut thread M4 H 3.2mm WS 7 SS DIN/ISO DIN 934 / ISO 4032/8673 Qty 20 pcs				



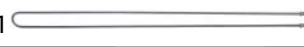



heating elements for heating bridges

Part No.		416444		
	Ref. No.	574059		
description heating element 1000W 230V heating circuits 1 L 627mm W 70mm connection length 20mm connection M4 tube ø 8.5mm 2 hole fixing thread M14x1.5 dry heating element heated bridge mounting distance 62mm				
For models: 0524302-00, 0524302-01				
accessories for		416444		
	Part No.	510417	Ref. No.	—
flat gasket fibre ED ø 20mm ID ø 14mm thickness 2mm Qty 1 pcs				
	Part No.	520228	Ref. No.	—
tooth lock washer ID ø 15.3mm ED ø 24mm steel Qty 1 pcs for thread M14				
	Part No.	520230	Ref. No.	—
nut thread M14x1.5 H 5mm WS 19 zinc-coated steel Qty 1 pcs				
	Part No.	521101	Ref. No.	113000
nut thread M14x1.5 H 5mm WS 19 SS Qty 1 pcs				
	Part No.	550262	Ref. No.	—
flat gasket copper ED ø 20mm ID ø 14mm thickness 2mm				

Part No.		416445		
	Ref. No.	574060		
description heating element 1400W 230V heating circuits 1 L 875mm W 70mm connection length 20mm connection M4 tube ø 8.5mm 2 hole fixing thread M14x1.5 dry heating element heated bridge mounting distance 62mm				
For models: 0524303-00, 0524303-01				
accessories for		416445		
	Part No.	510417	Ref. No.	—
flat gasket fibre ED ø 20mm ID ø 14mm thickness 2mm Qty 1 pcs				
	Part No.	520228	Ref. No.	—
tooth lock washer ID ø 15.3mm ED ø 24mm steel Qty 1 pcs for thread M14				
	Part No.	520230	Ref. No.	—
nut thread M14x1.5 H 5mm WS 19 zinc-coated steel Qty 1 pcs				

accessories for		416445		
	Part No.	521101	Ref. No.	113000
nut thread M14x1.5 H 5mm WS 19 SS Qty 1 pcs				
	Part No.	550262	Ref. No.	—
flat gasket copper ED ø 20mm ID ø 14mm thickness 2mm				

Part No.		416446		
	Ref. No.	574061		
description heating element 1800W 230V heating circuits 1 L 1125mm W 70mm connection length 19mm connection M4 tube ø 8.5mm 2 hole fixing thread M14x1.5 dry heating element heated bridge mounting distance 61mm				
For models: 0524304-00, 0524304-01				
accessories for		416446		
	Part No.	510417	Ref. No.	—
flat gasket fibre ED ø 20mm ID ø 14mm thickness 2mm Qty 1 pcs				
	Part No.	520228	Ref. No.	—
tooth lock washer ID ø 15.3mm ED ø 24mm steel Qty 1 pcs for thread M14				
	Part No.	520230	Ref. No.	—
nut thread M14x1.5 H 5mm WS 19 zinc-coated steel Qty 1 pcs				
	Part No.	521101	Ref. No.	113000
nut thread M14x1.5 H 5mm WS 19 SS Qty 1 pcs				
	Part No.	550262	Ref. No.	—
flat gasket copper ED ø 20mm ID ø 14mm thickness 2mm				



Part No.		416443		
	Ref. No.	574058		
description heating element 600W 230V heating circuits 1 L 375mm W 67mm connection M4 tube ø 8.5mm 2 hole fixing thread M14x1.5 dry heating element heated bridge mounting distance 59mm				
For models: 0524301-00, 0524301-01				
accessories for		416443		
	Part No.	510417	Ref. No.	—
flat gasket fibre ED ø 20mm ID ø 14mm thickness 2mm Qty 1 pcs				
	Part No.	520228	Ref. No.	—
tooth lock washer ID ø 15.3mm ED ø 24mm steel Qty 1 pcs for thread M14				
	Part No.	520230	Ref. No.	—
nut thread M14x1.5 H 5mm WS 19 zinc-coated steel Qty 1 pcs				
	Part No.	521101	Ref. No.	113000
nut thread M14x1.5 H 5mm WS 19 SS Qty 1 pcs				
	Part No.	550262	Ref. No.	—
flat gasket copper ED ø 20mm ID ø 14mm thickness 2mm				



ceramic heaters

245x60mm



1			
Part No.	415104	Ref. No.	203055
description	ceramic emitter 1000W 230V cable beaded cord L 245mm W 60mm H 35mm		
For models:	0220601-00, 1220601-00, 1320601-00, 1320601-01, 1420601-00, 1420701-00, 1420702-00, 1520601-00, 2020601-00, 2020601-01, 2120601-00, 2120601-01		
spare parts for	415104		
	Part No.	415109	Ref. No. —
	spring clip		
accessories for	415104		
	Part No.	415110	Ref. No. —
	reflector L 245mm W 95mm H 31mm thickness 0.75mm hole ø 15x40mm		

immersion heating elements



with expansion flange 70 x 18mm









1			
Part No.	415569	Ref. No.	573108 720012
description	heating element 5000W 230V heating circuits 2 L 272mm W 65mm H 29mm tube ø 8.5mm connection male faston 6.3mm immersion heater expansion flange flange 70x18mm		
For models:	2022801-02, 2022801-03, 2022801A02, 2022801A03, 2022801B02, 2022801B03, 2022801C02, 2022801C03, 2022802-02, 2022802-03, 2022802A02, 2022802A03, 2022802B02, 2022802B03, 2022802C02, 2022802C03, 2022803-02, 2022803-03, 2022803A02, 2022803A03, 2022803B02, 2022803B03, 2022803C02, 2022803C03, 2022804-02, 2022804-03, 2022804A02, 2022804A03, 2022804B02, 2022804B03, 2022804C02, 2022804C03, 2022805-02, 2022805-03, 2022805A02, 2022805A03, 2022805B02, 2022805B03, 2022805C02, 2022805C03, 2122801-02, 2122801-03, 2122801A02, 2122801A03, 2122801B02, 2122801B03, 2122801C02, 2122801C03, 2122802-02, 2122802-03... (Other models you can see in the webshop)		



1			
Part No.	419053	Ref. No.	573107
description	heating element 5000W 400V heating circuits 2 L 272mm W 65mm tube ø 8.5mm connection male faston 6.3mm connection length 38mm immersion heater expansion flange flange 70x18mm		
For models:	1422802B04, 1422802B05, 1422802B06, 1422802B07, 1422802B08, 1422804B04, 1422804B05, 1422804B06, 1422804B07, 1422804B08, 1422805B04, 1422805B05, 1422805B06, 1422805B07, 1422805B08, 1422807B00, 1422807B01, 1422807B02, 1422807B03, 1422807B04, 1422831-00, 1422832-00, 1422833-00, 1422834-00, 1422902-00, 1422902-01, 1422902-02, 1422902-03, 1422902-04, 1422908-00, 1422910-00, 1423901-00, 1423901-01, 1423901-02, 1423902-00, 1423902-01, 1423902-02, 1423903-00, 1423903-01, 1423903-02, 2022802B04, 2022802B05, 2022802B06, 2022802B07, 2022802B08, 2022802B09, 2022802B10, 2022802C07, 2022802C08, 2022802C09... (Other models you can see in the webshop)		



1			
			
Part No.	415568	Ref. No.	573106 720011
description	heating element 800W 230V heating circuits 1 L 220mm W 66mm tube ø 8.5mm connection male faston 6.3mm connection length 27mm immersion heater expansion flange TD ø 8mm flange 70x18mm		
For models:	1422802B04, 1422802B05, 1422802B06, 1422802B07, 1422802B08, 1422804B04, 1422804B05, 1422804B06, 1422804B07, 1422804B08, 1422805B04, 1422805B05, 1422805B06, 1422805B07, 1422805B08, 1422807B00, 1422807B01, 1422807B02, 1422807B03, 1422807B04, 1422831-00, 1422832-00, 1422833-00, 1422834-00, 1422902-00, 1422902-01, 1422902-02, 1422902-03, 1422902-04, 1422908-00, 1422910-00, 1423901-00, 1423901-01, 1423901-02, 1423902-00, 1423902-01, 1423902-02, 1423903-00, 1423903-01, 1423903-02, 2022801-02, 2022801-03, 2022801A02, 2022801A03, 2022801B02, 2022801B03, 2022801C02, 2022801C03, 2022802-02, 2022802-03... (Other models you can see in the webshop)		
accessories for	415568		
	Part No.	375044	Ref. No. 203185
	safety thermostat switch-off temp. 178°C 1-pole 16A probe ø 4mm probe L 91mm capillary pipe 1730mm capillary pipe isolated 1600mm gland nut probe with sealing sleeve screw connection M8x1 sealing sleeve 8.6x32mm		



1 1/2"			
			
1			
Part No.	415402	Ref. No.	537081 573075
description	heating element 6000W 400/230V heating circuits 3 thread 1 1/2" L 425mm W 35mm H 35mm thermostat sleeves ø 7mm length thermostat sleeves 330mm thermostat sleeve centre not clinging tube ø 8.5mm connection M4 immersion heater flange with thread WS 60 no original spare part number of thermostat sleeves 1		
For models:	14228011-0, 14228022-0, 14228033-0, 14228044-0, 14228055-0, 2022801-00, 2022801-01, 20228011-0, 20228011-1, 2022801A00, 2022801A01, 2022801B00, 2022801B01, 2022801C00, 2022801C01, 2022802-00, 2022802-01, 20228022-0, 20228022-1, 2022802A00, 2022802A01, 2022802B00, 2022802B01, 2022802C00, 2022802C01, 2022803-00, 2022803-01, 20228033-0, 20228033-1, 2022803A00, 2022803A01, 2022803B00, 2022803B01, 2022803C00, 2022803C01, 2022804-00, 2022804-01, 20228044-0, 20228044-1, 2022804A00, 2022804A01, 2022804B00, 2022804B01, 2022804C00, 2022804C01, 2022805-00, 2022805-01, 20228055-0, 20228055-1, 2022805A00... (Other models you can see in the webshop)		
spare parts for	415402		
	Part No.	510406	Ref. No. —
	flat gasket fibre ED ø 60mm ID ø 48mm thickness 3mm for thread 1 1/2" Qty 1 pcs		
accessories for	415402		
	Part No.	510424	Ref. No. —
	gasket copper ED ø 55mm ID ø 48mm thickness 2.2mm Centellen for thread 1 1/2"		
	Part No.	520211	Ref. No. —
	reducer thread 2" ET - 1 1/2" IT brass		
	Part No.	520212	Ref. No. —
	hexagonal nut thread 1 1/2" brass WS 60 H 8mm		
	Part No.	550361	Ref. No. —
	blind flange ø 58mm thread 1 1/2"		





heating elements for convection



			
1			
Part No.	419248	Ref. No.	574183
description	heating element 15300W 440V heating circuits 6 ID ø 450mm ED ø 530mm L 540mm H 113mm W1 96mm H1 23mm H2 90mm flange length 130mm flange width 70mm connection length 100mm tube ø 6.5mm cable length 1200mm dry heating element with fixing flange		

			
1			
Part No.	418750	Ref. No.	574177
description	heating element 15400W 400V heating circuits 6 ID ø 450mm ED ø 530mm L 540mm H 113mm W1 96mm H1 23mm H2 90mm flange length 130mm flange width 70mm connection length 100mm tube ø 6.5mm cable length 1200mm dry heating element with fixing flange		
For models:	CGE11-L, CGE11-R, CGE12-L, CGE12-R, CGE21-L, CGE21-R, CGE61-L, CGE61-R, CSE11-L, CSE11-R, CSE11-R-DG, CSE21-L, CSE21-R, CSE21-R-DG, CSE61-L, CSE61-R, CSE61-R-DG, CSE62-L, CSE62-R, CSE62-R-DG		
accessories for	418750		
	Part No.	550639	Ref. No. 211083
gasket L 130mm W 70mm thickness 1mm for heating element			

			
1			
Part No.	418748	Ref. No.	574181
description	heating element 20400W 400V heating circuits 6 ID ø 450mm ED ø 525mm L 107mm H 113mm W1 97mm H1 28mm H2 85mm flange length 130mm flange width 70mm hole distance 119mm connection length 100mm tube ø 6.5mm cable length 1200mm dry heating element hole ø 6mm with fixing flange		
For models:	CGE12-L, CGE12-R, CGE62-L, CGE62-R, CSE62-L, CSE62-R		
accessories for	418748		
	Part No.	550639	Ref. No. 211083
gasket L 130mm W 70mm thickness 1mm for heating element			

			
1			
Part No.	418751	Ref. No.	574189
description	heating element 30000W 400V heating circuits 6 ID ø 380mm ED ø 450mm L 535mm H 120mm W1 99mm H1 20mm H2 100mm flange length 130mm flange width 70mm connection length 100mm tube ø 8mm cable length 1200mm dry heating element with fixing flange		
For models:	CGE11-L, CGE11-R, CGE12-L, CGE12-R, CGE22-L, CGE22-R, CGE62-L, CGE62-R, CSE12-L, CSE12-R, CSE12-R-DG, CSE22-L, CSE22-R, CSE22-R-DG		

			
1			
Part No.	420336	Ref. No.	574160
description	heating element 9900W 230V heating circuits 3 ID ø 450mm ED ø 465mm L 500mm H 104mm L1 30mm W1 96mm H1 13mm H2 91mm flange length 130mm flange width 70mm hole distance 55/50mm connection M4 tube ø 6.3mm convection heating element hole ø 7mm flange connection		
For models:	CGE61-L, CGE61-R, CGE62-L, CGE62-R, CSE61-L, CSE61-R, CSE62-L, CSE62-R		

			
1			
Part No.	418749	Ref. No.	574176
description	heating element 9900W 400V heating circuits 3 ID ø 450mm ED ø 465mm L 500mm H 115mm L1 35mm W1 96mm H1 26mm H2 89mm flange length 130mm flange width 70mm connection length 100mm tube ø 6.5mm cable length 1200mm dry heating element with fixing flange		
For models:	CGE11-L, CGE11-R, CGE61-L, CGE61-R, CSE61-L, CSE61-R, CSE61-R-DG, CSE62-L, CSE62-R, CSE62-R-DG		
accessories for	418749		
	Part No.	550639	Ref. No. 211083
gasket L 130mm W 70mm thickness 1mm for heating element			



radiation heaters

square

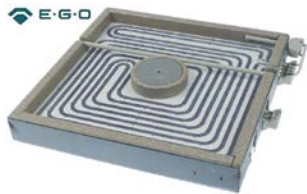

1

Part No.	490009 ¹	Ref. No.	203037
description	radiation heater L 300mm W 300mm 4000W 400V connections 3+2 square with pan detection EGO		
For models:	0723405-01, 0723405-02, 0723409-01, 0723409-02, 0723413-02, 0723414-02, 1023410-00, 1423404-00, 1423404-01, 1423405-00, 1423405-01, 1423405-02, 1423409-00, 1423409-01, 1423409-02, 1423413-02, 1423414-02, 1424819-00, 1424826-00, 1523405-00, 1523405-01, 1523409-00, 1523409-01, 1523410-00, 2023206-00, 2023206-01, 2023206-02, 2023207-00, 2023207-01, 2023207-02, 2023207-03, 2023207-04, 2023207-05, 2023405-00, 2023405D00, 2023406-00, 2023407-00, 2023407-01, 2023409-00, 3023206-00, 3023206-01, 3023206-02, 3023405-00, 3023406-00, 3023409-00		
spare parts for	490009		
	Part No.	499157	Ref. No. —
	protection pipe for temperature probe ceramic L 297mm ED ø 7mm ID ø 5mm		

¹with pan detection

1-circuit



1

Part No.	490093	Ref. No.	203047
description	radiation heater ø 230mm 2100W 230V		
For models:	1223202-00, 2123207-00, 2123208-00, 2123208-01		



1

Part No.	490043	Ref. No.	202799
description	radiation heater ø 230mm 2300W 230V heating circuits 1 H 32mm energy regulation with temperature signalization with ribbon heater connections 2+2 connection type male faston 6.3mm horizontal EGO		
For models:	1023401K00, 1223401K00, 1223401L00, 1223402K00, 1323401K00, 1323402K00, 1323403K00, 1423402K01, 1523401K00, 1523402-00, 1523402K00, 2123401K00, 2123402K00, 2123403K00		

hot plates

square & rectangular

with radiused edge



1

Part No.	490065	Ref. No.	203068
description	hot plate dimensions 220x220mm 2000W 230V with spill ring connection 4 screw clamps protector no square		



1

Part No.	490067	Ref. No.	203051 203076
description	hot plate dimensions 220x220mm 2000W 400V with spill ring connection 4 screw clamps protector no square		
For models:	0223202-00, 1223201-00, 1223207-00, 1323201-00, 1323207-00, 1323208-00, 1323208-01, 1323208-02, 1424802-00, 1424808-00, 1424808-01, 1424811-00, 1424811-01, 2123201-00, 2123201-01, 2123202-00, 2123202-01, 2123202A00, 2123202A01, 2123203-00, 2123203-01, 2123203-02, 2123203-03, 2123203-04, 2123203A00, 2123203A01, 2123203A02, 2123203A03, 2123203A04, 2123204-00, 2123204-01, 2123204-02, 2123204-03, 2123204-04, 2123204A00, 2123204A01, 2123204A02, 2123204A03, 2123204A04, 2123209-00		
accessories for	490067		
	Part No.	693464	Ref. No. 211047
	sealing cord ø 10mm Qty supplied by meter		



1

Part No.	490068 ¹	Ref. No.	203071
description	hot plate dimensions 220x220mm 2600W 400V with spill ring connection 4 screw clamps protector yes square		
For models:	1223201-01, 1223207-01, 1323201-01, 1323201-02, 1323207-02, 1323208-03, 1323208-04, 1424802-01, 1424802-02, 1424808-02, 1424808-03, 1424811-02, 1424811-03, 2123201-02, 2123201-03, 2123201-04, 2123202-02, 2123202-03, 2123203-05, 2123203-06, 2123203-07, 2123203-08, 2123204-05, 2123204-06, 2123204-07, 2123204-08, 2123209-01, 2123209-02		

¹incl. protector



1

Part No.	490128 ¹	Ref. No.	203053 203065
description	hot plate dimensions 300x300mm 2500W 400V with spill ring connection 4 screw clamps protector yes square		
For models:	1424809-00, 1424809-01, 1424809-02, 14248099-0, 1424812-00, 1424812-01, 1424812-02, 1424813-00, 1424813-01, 1424813-02, 2023201-00, 2023201-01, 2023201-02, 2023201-03, 20232011-0, 20232011-1, 2023202-00, 2023202-01, 2023202-02, 20232022-0, 20232022-1, 2023203-00, 2023203-01, 2023203-02, 2023203-03, 2023203-04, 2023203-05, 2023203-06, 2023203-07, 20232033-0, 20232033-1, 2023204-00, 2023204-01, 2023204-02, 20232044-0, 20232044-1, 2023205-00, 2023205-01, 2023205-02, 2023205-03, 2023205-04, 2023205-05, 2023205-06, 2023205-07, 20232055-0, 20232055-1, 3023201-00, 3023201-01, 3023201-02, 3023202-00... (Other models you can see in the webshop)		

¹incl. protector



1

Part No.	490071 ¹	Ref. No.	203776
description	hot plate dimensions 300x300mm 4000W 230V with spill ring connection 4 screw clamps protector yes square		

¹incl. protector



1

Part No.	490074 ¹	Ref. No.	203054
description	hot plate dimensions 300x300mm 4000W 400V with spill ring connection 4 screw clamps protector yes square		
For models:	1424809-00, 1424809-01, 1424809-02, 14248099-0, 1424812-00, 1424812-01, 1424812-02, 1424813-00, 1424813-01, 1424813-02, 2023201-00, 2023201-01, 2023201-02, 2023201-03, 20232011-0, 20232011-1, 2023201A00, 2023201A01, 2023202-00, 2023202-01, 2023202-02, 20232022-0, 20232022-1, 2023202A00, 2023202A01, 2023203-00, 2023203-01, 2023203-02, 2023203-03, 2023203-04, 2023203-05, 2023203-06, 2023203-07, 20232033-0, 20232033-1, 2023203A00, 2023203A01, 2023203A02, 2023203A03, 2023204-00, 2023204-01, 2023204-02, 20232044-0, 20232044-1, 2023204A00, 2023204A01, 2023205-00, 2023205-01, 2023205-02, 2023205-03... (Other models you can see in the webshop)		

¹incl. protector

tiltable



1

Part No.	490088	Ref. No.	203075
description	hot plate dimensions 300x300mm 2500W 400V with cast edge tilt boiling plate connection 4 screw clamps H 43mm square		
For models:	2023302-00, 2023303-00, 2023304-00, 2023305-00		

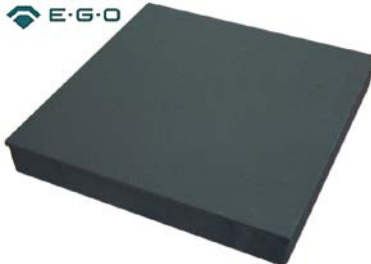

1

Part No.	490090	Ref. No.	203108
description	hot plate dimensions 300x300mm 4000W 400V with cast edge tilt boiling plate connection 4 screw clamps H 43mm square		
For models:	2023302-00, 2023303-00, 2023304-00, 2023305-00		

round

with radiused edge

for domestic and commercial kitchens



1

Part No.	490011	Ref. No.	203073
description	hot plate ø 145mm 1000W 400V connection 4 screw clamps with 8mm spill ring		
For models:	0520901-00		



1

Part No.	490014	Ref. No.	203064
description	hot plate ø 180mm 1500W 230V connection 4 screw clamps with 8mm spill ring		



			
1			
Part No.	490015	Ref. No.	203058
description	hot plate ø 180mm 1500W 400V connection 4 screw clamps with 8mm spill ring		

			
1			
Part No.	490017	Ref. No.	203062
description	hot plate ø 180mm 2000W 400V connection 4 screw clamps with 8mm spill ring		

			
1			
Part No.	490018	Ref. No.	203066
description	hot plate ø 220mm 2000W 230V connection 4 screw clamps with 8mm spill ring		
For models:	1424816-00		

			
1			
Part No.	490019	Ref. No.	203059
description	hot plate ø 220mm 2000W 400V connection 4 screw clamps with 8mm spill ring		

energy regulators

EGO

1-circuit

			
1			
Part No.	380015	Ref. No.	203160
description	energy regulator 230V 13A single-circuit turn direction right shaft ø 6x4.6mm shaft L 23mm mounting thread M4 power release 6-100% no. 50.57021.010		
For models:	00217022-0, 0221001H00, 0221202-00, 0221501-00, 0221502-00, 0521701-00, 0521701-01, 0521702-00, 0521702-01, 0521702-02, 0521702-03, 0521702-04, 0521702B03, 0521702B04, 0521702C04, 0521704-04, 0521704-05, 0521704-06, 0521704-07, 0521705-00, 0521705-01, 1022603-00, 1023401-00, 1023401K00, 1220402-00, 1220402-01, 1221501-00, 1221501-01, 1221501-02, 1222603-00, 1223202A00, 1223202A01, 1223202J00, 1223202J01, 1223209-00, 1223209-01, 1223401-00, 1223401J00, 1223401K00, 1223401L00, 1223402-00, 1223402K00, 1320402-00, 1320402-01, 1321501-00, 1321501-01, 1321501-02, 1321501-03, 1322603-00, 1323202A00... (Other models you can see in the webshop)		

			
1			
Part No.	380013	Ref. No.	203161
description	energy regulator 400V 7A single-circuit turn direction right shaft ø 6x4.6mm mounting thread M4 no. 50.57031.010		
For models:	0521702A02, 0521702A03, 0521702A04, 0723412K01, 1423412K01		

thermostats

bi-metal thermostats

safety bi-metal thermostats

			
1			
Part No.	378659	Ref. No.	202806
description	bi-metal safety thermostat hole distance 24mm switch-off temp. 320°C NC 1-pole 16A 400V connection with cable cable length 120mm with fixing sheet		
For models:	CGE11-L, CGE11-R, CGE12-L, CGE12-R, CGE21-L, CGE21-R, CGE22-L, CGE22-R, CGG11-L, CGG11-R, CGG12-L, CGG12-R, CGG21-L, CGG21-R, CGG22-L, CGG22-R, CSE11-L, CSE11-R, CSE11-R-DG, CSE12-L, CSE12-R, CSE12-R-DG, CSE21-L, CSE21-R, CSE21-R-DG, CSE22-L, CSE22-R, CSE22-R-DG, CSE61-L, CSE61-R, CSE61-R-DG, CSG11-L, CSG11-R, CSG11-R-DG, CSG12-L, CSG12-R, CSG12-R-DG, CSG21-L, CSG21-R, CSG21-R-DG, CSG22-L, CSG22-R, CSG22-R-DG		

bi-metal thermostats

			
1			
Part No.	390160	Ref. No.	203255
description	bi-metal thermostat hole distance 30mm switch-off temp. 90°C 1NO 1-pole 10A connection F6.3		
For models:	1422802B04, 1422802B05, 1422802B06, 1422802B07, 1422802B08, 1422804B04, 1422804B05, 1422804B06, 1422804B07, 1422804B08, 1422805B04, 1422805B05, 1422805B06, 1422805B07, 1422805B08, 1422807B00, 1422807B01, 1422807B02, 1422807B03, 1422807B04, 1422831-00, 1422832-00, 1422833-00, 1422834-00, 1422902-00, 1422902-01, 1422902-02, 1422902-03, 1422902-04, 1422908-00, 1422910-00, 1462802B00, 1462802B01, 1462802B02, 1462802B03, 1462802B04, 1462802B05, 1462804B00, 1462804B01, 1462804B02, 1462804B03, 1462804B04, 1462804B05, 1462831-00, 1462832-00, 1462833-00, 1462834-00, 1462835-00, 1462836-00, 1462837-00... (Other models you can see in the webshop)		



			
1			
Part No.	390767	Ref. No.	203523
description	bi-metal thermostat switch-off temp. 60°C 1NC 1-pole connection F6.3		
For models:	0723104B03, 0723105B03, 0723405-01, 0723405-02, 0723409-02, 0723412K01, 0723413-02, 0723414-02, 1412833-00, 1412833-01, 1412834-00, 1412834-01, 1412910-00, 1412910-01, 1422701-01, 1422701-02, 1422701-03, 1422702-01, 1422702-02, 1422702-03, 1422703-00, 1422703-01, 1422703-02, 1422704-00, 1422704-01, 1422704-02, 1422705-00, 1422705-01, 1422705-02, 1422706-00, 1422706-01, 1422706-02, 1422707-00, 1422707-01, 1422707-02, 1422708-00, 1422708-01, 1422708-02, 1423104B03, 1423105B03, 1423402-00, 1423402K01, 1423405-00, 1423405-01, 1423405-02, 1423409-02, 1423412K01, 1423413-02, 1423414-02, 1423502-00... (Other models you can see in the webshop)		

control and safety thermostats

EGO

control thermostats

55.10/19_ series

			
1			
Part No.	375001	Ref. No.	203498
description	thermostat t.max. 112°C temperature range 30-110°C 1-pole 1NO 16A probe ø 6mm probe L 130mm capillary pipe 900mm capillary pipe isolated gland nut M9x1 shaft L 23mm shaft position upper rotation 270°		
For models:	1224002-00, 1224002-01, 1224003-00, 1224003-01, 1224004-00, 1224004-01, 1224005-00, 1224005-01, 1224006-00, 1224006-01, 1224007-00, 1224007-01, 1224008-00, 1224008-01, 1224009-00, 1224009-01		

55.13_ series

			
1			
Part No.	390161	Ref. No.	203167
description	thermostat t.max. 114°C temperature range 36-114°C 1-pole 1NO 16A probe ø 31/36mm probe Lmm capillary pipe 870mm capillary pipe isolated 800mm gland nut shaft ø 6x4.6mm shaft L 23mm shaft position upper rotation 270° with knob probe (boiling plate)		
For models:	1422802B04, 1422802B05, 1422802B06, 1422802B07, 1422802B08, 1422804B04, 1422804B05, 1422804B06, 1422804B07, 1422804B08, 1422805B04, 1422805B05, 1422805B06, 1422805B07, 1422805B08, 1422807B00, 1422807B01, 1422807B02, 1422807B03, 1422807B04, 1422831-00, 1422832-00, 1422902-00, 1422902-01, 1422902-02, 1422902-03, 1422902-04, 1422908-00, 1462802B00, 1462802B01, 1462802B02, 1462802B03, 1462802B04, 1462802B05, 1462804B00, 1462804B01, 1462804B02, 1462804B03, 1462804B04, 1462804B05, 1462831-00, 1462832-00, 1462835-00, 1462836-00, 1462837-00, 1462908-00, 2022801-01, 2022801-02, 2022801-03, 2022801A01... (Other models you can see in the webshop)		

			
1			
Part No.	375760	Ref. No.	203490
description	thermostat t.max. 116°C temperature range 36-116°C 1-pole 1NO 16A probe ø 6mm probe L 113mm capillary pipe 870mm capillary pipe isolated 350mm gland nut M9x1 shaft ø 6x4.6mm shaft L 23mm shaft position upper rotation 270°		
For models:	0720504-04, 1020510-00, 1120510-00, 1120510-01, 1220501-00, 1220501-01, 1220501-02, 1220502-00, 1220502-01, 1220503-00, 1220504-01, 1220802-00, 1220802-01, 1222601-00, 1320501-00, 1320501A00, 1320501A01, 1320502-00, 1320502A00, 1320502A01, 1320504-01, 1320504-02, 1320802-00, 1320802A00, 1322601-00, 1420501-00, 1420501-01, 1420501-02, 1420501-03, 1420502-00, 1420502-01, 1420502-02, 1420504-00, 1420504-01, 1420504-02, 1420504-03, 1420504-04, 1420505-00, 1420505-01, 1420505-02, 1420509-01, 1420801-01, 1420803-01, 1422601-00, 1422602-00, 1520501-00, 1820501-00, 1820801-0, 2020501-01, 2020501-02... (Other models you can see in the webshop)		



Part No.	375952	Ref. No.	203760
description	thermostat t.max. 150°C temperature range 30-150°C 1-pole 1NO 16A probe ø 6mm probe L 84mm capillary pipe 850mm capillary pipe isolatedmm gland nut shaft ø 6x4.6mm shaft L 23mm shaft position upper rotation 270° 380V		
For models:	1022603-00, 1220402-00, 1220402-01, 1222603-00, 1320402-00, 1320402-01, 1322603-00, 1420402-00, 1420402-01, 1420405-00, 1520402-00, 1520402-01, 1520403-00, 1520403-01, 1522603-00, 1522603-01, 2020402-00, 2020402-01, 2022603-00, 2120402-00, 2120402-01, 2420403-00, 2420403-01, 3020402-00, 3020402-01		



Part No.	375193	Ref. No.	203248
description	thermostat t.max. 300°C temperature range 50-300°C 1-pole 1NO 16A probe ø 4mm probe L 91mm capillary pipe 1130mm capillary pipe isolated 1100mm gland nut shaft L 23mm shaft position upper rotation 270°		
For models:	0021130A00, 0021130A01, 0021135A00, 0522101-02, 0522102-02, 0721134-01, 0721134A01, 0721172A01, 0721173A01, 0721174A01, 0721175A01, 1121117-00, 1121117-01, 1121117A00, 1121118-00, 1121118-01, 1121119-00, 1121119A00, 1121120-00, 1121121-00, 1121121A00, 1121135A01, 1221103-04, 1221103B04, 1221105-00, 1221105-01, 1221105-02, 1221105A00, 1221105A01, 1221105A02, 1221105B00, 1221105B01, 1221105B02, 1221106-00, 1221106-01, 1221106A00, 1221106A01, 1221106B00, 1221106B01, 1221107-00, 1221107-01, 1221107-02, 1221108-00, 1221108-01, 1221108-02, 1221109-00, 1221109-01, 1221110-00, 1221110-01, 1221111-00... (Other models you can see in the webshop)		



Part No.	375401	Ref. No.	203662
description	thermostat t.max. 185°C temperature range 97-185°C 1-pole 1NO 16A probe ø 6mm probe L 87mm capillary pipe 1430mm capillary pipe isolated 1100mm gland nut M9x1 shaft ø 6x4.6mm shaft L 23mm shaft position upper rotation 270°		



Part No.	375505	Ref. No.	203177 203500
description	thermostat t.max. 320°C temperature range 50-320°C 1-pole 1NO 16A probe ø 3mm probe L 160mm capillary pipe 870mm capillary pipe isolatedmm gland nut shaft ø 6x4.6mm shaft L 23mm shaft position upper rotation 270°		
For models:	1424816-00, 1821101-00		



Part No.	375747	Ref. No.	203067 203662
description	thermostat t.max. 190°C temperature range 97-190°C 1-pole 1NO 16A probe ø 6mm probe L 87mm capillary pipe 1430mm capillary pipe isolated 1100mm gland nut M9x1 shaft ø 6x4.6mm shaft L 23mm shaft position upper rotation 270°		
For models:	0520303-02, 0720325-03, 0720325-04, 0720325B03, 0720325B04, 1220301-00, 1220301-01, 1220301-02, 1220301-03, 1220301-04, 1220301B00, 1220301B01, 1220301B02, 1220301B03, 1220301B04, 1220301D00, 1220301D01, 1220301E00, 1220301E01, 1220301J00, 1220301J01, 1220301J02, 1220301J03, 1220303-00, 1220303-01, 1220303-02, 1220303-03, 1220303-04, 1220303-05, 1220303A00, 1220303A01, 1220303A02, 1220303A03, 1220303B00, 1220303B01, 1220303B02, 1220303B03, 1220303B04, 1220303B05, 1220303C00, 1220303C01, 1220303C02, 1220303C03, 1220303D00, 1220303D01, 1220303D02, 1220303E00, 1220303E01, 1220303E02, 1220303F01... (Other models you can see in the webshop)		



E-G-O



Part No.	375717	Ref. No.	203176
description	thermostat t.max. 82°C temperature range fixed 40°C 1NO 16A probe ø 3mm probe L 156mm capillary pipe 600mm capillary pipe isolated 600mm gland nut shaft ø 6x4.6mm shaft L 8.5mm shaft position right° rotation 180° outer switch eccentric 1/2"-3/4"		
For models:	1223209-00, 1223209-01, 1223402-00, 1223402K00, 1323209-00, 1323209-01, 1323209-02, 1323209-03, 1323210-00, 1323210-01, 1323210-02, 1323210-03, 1323210-04, 1323402-00, 1323402K00, 1323403-00, 1323403K00, 2023206-00, 2023206-01, 2023207-00, 2023207-01, 2023207-02, 2023207-03, 2023207-04, 2023503-04, 2023503-05, 2023503-06, 2023503-07, 2023503-08, 2023503-09, 2023503-10, 2023503A04, 2023503A05, 2023503A06, 2023503A07, 2023503A08, 2023503A09, 2023503A10, 2123207A00, 2123208A00, 2123208A01, 2123208A02, 2123503-01, 2123503-02, 2123503-03, 2123503-04, 2123503-05, 2123503-06, 2123503A01, 2123503A03... (Other models you can see in the webshop)		

E-G-O

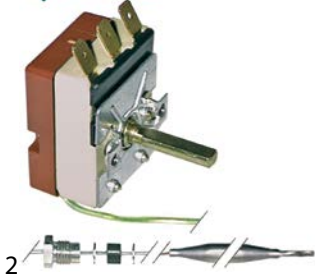

Part No.	375400	Ref. No.	203173
description	thermostat t.max. 90°C temperature range 30-90°C 1-pole 1CO 16A probe ø 6mm probe L 98mm capillary pipe 2380mm capillary pipe isolated 1700mm gland nut M9x1 shaft ø 6x4.6mm shaft L 18mm shaft position upper rotation 270°		

E-G-O



Part No.	390036	Ref. No.	203173
description	thermostat t.max. 90°C temperature range 30-90°C 1-pole capillary pipe isolated gland nut		
For models:	20628022-0, 20628022-1, 20628033-0, 20628044-0, 20629011-0, 20629022-0		

55.34_series

E-G-O



Part No.	375021	Ref. No.	203486
description	thermostat t.max. 110°C temperature range 32-110°C 3-pole 3CO 16A probe ø 6mm probe L 138mm capillary pipe 2980mm capillary pipe isolated 2200mm gland nut M9x1 shaft ø 6x4.6mm shaft L 23mm shaft position upper rotation 270°		
For models:	14228011-0, 14228022-0, 14228033-0, 14228044-0, 14228055-0, 2022801-00, 20228011-0, 20228011-1, 2022801A00, 2022801B00, 2022801C00, 2022802-00, 20228022-0, 20228022-1, 2022802A00, 2022802C00, 2022803-00, 20228033-0, 20228033-1, 2022803A00, 2022803B00, 2022803C00, 2022804-00, 20228044-0, 20228044-1, 2022804A00, 2022804B00, 2022804C00, 2022805-00, 20228055-0, 20228055-1, 2022805A00, 2022805B00, 2022805C00, 2022806-00, 20228066-0, 20228066-1, 2022806A00, 2022806B00, 2022806C00, 2022807-00, 20228077-0, 20228077-1, 2022807A00, 2022807B00, 2022807C00, 2022901-00, 20229011-0, 20229011-1, 2022901A00... (Other models you can see in the webshop)		

E-G-O

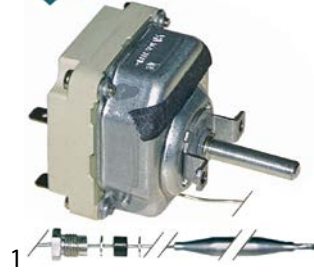

Part No.	375143	Ref. No.	203491
description	thermostat t.max. 110°C temperature range 32-110°C 3-pole 3NO 16A probe ø 6mm probe L 138mm capillary pipe 1480mm capillary pipe isolated 1100mm gland nut M9x1 shaft ø 6x4.6mm shaft L 23mm shaft position upper rotation 270°		
For models:	0220501-00, 0220502-00, 0220503-00, 0220802-00, 0520901-00, 1420801-00, 1420803-00, 2020501-00, 20205011-0, 2020502-00, 20205033-0, 2020504-00, 2120501-00, 2120502-00, 3020502-00		



Part No.	375735	Ref. No.	203661
description	thermostat t.max. 180°C temperature range 100-180°C 3-pole 3NO 16A probe ø 6mm probe L 133mm capillary pipe 2300mm capillary pipe isolated 450mm gland nut M9x1 shaft ø 6x4.6mm shaft L 23mm shaft position upper rotation 270°		
For models:	0520303-02, 0720332R00, 0720332V00, 1420332P01, 1420332P02, 1420332P03, 1420332R00, 1420332R01, 1420332R02, 1420332R03, 1420332T01, 1420332T02, 1420332T03, 1420332V01, 1420332V02, 1420332V03, 1420333P01, 1420333P02, 1420333R00, 1420333R01, 1420333R02, 1420333T01, 1420333T02, 1420333V01, 1420333V02, 1420334P00, 1420334P01, 1420334P02, 1420334P03, 1420334P04, 1420334R02, 1420334R03, 1420334R04, 1420334T02, 1420334T03, 1420334T04, 1420334V01, 1420334V02, 1420334V03, 1420334V04, 1420334W02, 1420334W03, 1420334W04, 1420334Y02, 1420334Y03, 1420334Y04, 1420344R00, 1420344R01, 1420344R02, 1520332P00... (Other models you can see in the webshop)		

Part No.	375097	Ref. No.	203497
description	thermostat t.max. 195°C temperature range 95-195°C 3-pole 3NO 16A probe ø 6mm probe L 117mm capillary pipe 1780mm capillary pipe isolated 1400mm gland nut M9x1 shaft ø 6x4.6mm shaft L 23mm shaft position upper rotation 270°		

Part No.	375504	Ref. No.	203499
description	thermostat t.max. 220°C temperature range 95-220°C 3-pole 3NO 16A probe ø 6mm probe L 117mm capillary pipe 1480mm capillary pipe isolated 1100mm gland nut shaft ø 6x4.6mm shaft L 23mm shaft position upper rotation 270°		

Part No.	375022	Ref. No.	200496
description	thermostat t.max. 180°C temperature range 95-180°C 3-pole 3NO 16A probe ø 6mm probe L 133mm capillary pipe 1780mm capillary pipe isolated 1400mm gland nut M9x1 shaft ø 6x4.6mm shaft L 23mm rotation 270°		

Part No.	375025	Ref. No.	203488
description	thermostat t.max. 300°C temperature range 50-300°C 3-pole 3CO 16A probe ø 6mm probe L 77mm capillary pipe 2980mm capillary pipe isolated 2260mm gland nut shaft ø 6x4.6mm shaft L 23mm shaft position upper rotation 270°		

Part No.	375512	Ref. No.	203487 203496
description	thermostat t.max. 185°C temperature range 95-185°C 3-pole 3NO 16A probe ø 6mm probe L 133mm capillary pipe 2430mm capillary pipe isolated 1100mm gland nut M9x1 shaft ø 6x4.6mm shaft L 23mm shaft position upper rotation 270°		
For models:	0120101-00, 0120101C00, 0120105-00, 0120105C00, 0220301-00, 0220301B00, 0220301B01, 0220301B02, 0220301D00, 0220302-00, 0220302A00, 0220302A01, 0220302A02, 0220302A03, 0220302B00, 0220302B01, 0220302B02, 0220302C00, 0220302C01, 0220302C02, 0220302C03, 0220302D00, 0220302E00, 0220302E01, 0220302F00, 0220302H00, 0220302H01, 0220303-00, 0220303-01, 0220303A00, 0220303A01, 0220303A02, 0220303A03, 0220303B00, 0220303B01, 0220303C00, 0220303C01, 0220303C02, 0220303D00, 0220303D01, 0220303E00, 0220303E01, 0220303H00, 0220303H01, 0220304-00, 0220305-00, 0220306-00, 0520302-00, 0520303-00, 0520303-01... (Other models you can see in the webshop)		

For models:	2021401-00, 2021401-01, 2021401-02, 2021401-03, 2021401-04, 2021401-05, 2021401-06, 2021401-07, 2021401-08, 2021401-09, 2021401A00, 2021401A01, 2021401A02, 2021401A03, 2021401A04, 2021401A06, 2021401A07, 2021401A08, 2021401A09, 2021401B00, 2021401B01, 2021401B02, 2021401B03, 2021401B04, 2021401B06, 2021401B07, 2021401B08, 2021401B09, 2021401C00, 2021401C01, 2021401C02, 2021401C03, 2021401C04, 2021401C06, 2021401C07, 2021401C08, 2021401C09, 2021402-00, 2021402-01, 2021402-02, 2021402-03, 2021402-04, 2021402-05, 2021402-06, 2021402-07, 2021402-08, 2021402A00, 2021402A01, 2021402A02, 2021402A03... (Other models you can see in the webshop)		
--------------------	---------------------------------------------------------------------------------------------------------------------------------------------------------------------------------------------------------------------------------------------------------------------------------------------------------------------------------------------------------------------------------------------------------------------------------------------------------------------------------------------------------------------------------------------------------------------------------------------------------------------------------------------------------------------	--	--



E-G-O

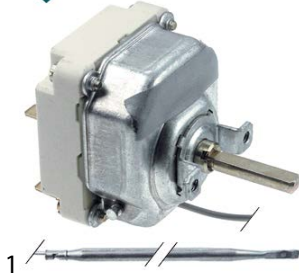

Part No.	375390	Ref. No.	203565
description	thermostat t.max. 300°C temperature range 50-300°C 3-pole 3NO 16A probe ø 4mm probe L 292mm capillary pipe 880mm capillary pipe isolated 800mm gland nut shaft ø 6x4.6mm shaft L 23mm shaft position upper		
For models:	0522101-04, 0522102-04, 0722101-06, 1323208-04, 1323210-03, 1323210-04, 1323403-00, 1323403K00, 1323506-00, 1323506-01, 1323506A00, 1323506A01, 1323517-00, 1323517A00, 1363403-03, 1363403-04, 1363403-05, 1363415-05, 1422101-04, 1422101-05, 1422101-06, 1422102-04, 1422102-05, 1422104-05, 1422105-05, 1422106-05, 1422106-06, 1422107-05, 1422107-06, 1422301-01, 2023114-00, 2023118-00, 2023119-00, 2023203-07, 2023205-07, 2023207-03, 2023207-04, 2023207-05, 2023406-00, 2023503-10, 2023503-11, 2023503-12, 2023503-13, 2023503A10, 2023503A11, 2023503A12, 2023503A13, 2023512A00, 2063403-08, 2063403-09... (Other models you can see in the webshop)		

E-G-O

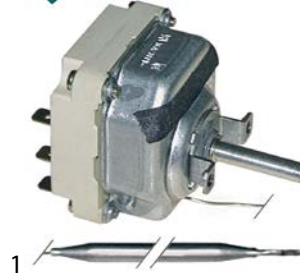

Part No.	375026	Ref. No.	203406
description	thermostat t.max. 350°C temperature range 100-350°C 3-pole 3NO 16A probe ø 6mm probe L 77mm capillary pipe 2430mm capillary pipe isolated 1100mm gland nut shaft ø 6x4.6mm shaft L 23mm shaft position upper rotation 270°		
For models:	2023501-00, 2023501A00, 2023502-00, 2023502A00, 2023503-00, 2023503A00, 2083501B00, 2083501C00, 2083502B00, 2083502C00		

55.40_ series

E-G-O

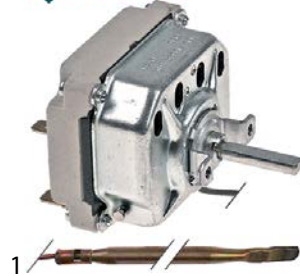

Part No.	375096	Ref. No.	203407
description	thermostat t.max. 450°C temperature range 100-450°C 4-pole 4NO 16A probe ø 3.9mm probe L 163mm capillary pipe 1180mm capillary pipe isolated 850mm gland nut shaft ø 6x4.6mm shaft L 23mm shaft position upper rotation 270°		
For models:	1223215-00, 1223215A00, 1223216-00, 1223216A00, 1223504A00, 1223504A01, 1223505-00, 1223505-01, 1223505A00, 1223505A01, 1323504-00, 1323504-01, 1323504A00, 1323504A01, 1323505-00, 1323505-01, 1323505A00, 1323505A01, 1323506-00, 1323506-01, 1323506A00, 1323506A01, 1323515-00, 1323515A00, 1323516-00, 1323516A00, 1323517-00, 1323517A00, 1423501-00, 1423501-01, 1423501A00, 1423501A01, 1423502-00, 1423502-01, 1423502-02, 1423502A00, 1423502A01, 1423502A02, 1423504-00, 1423504-01, 1423504A00, 1423504A01, 1423505-00, 1423505-01, 1423505A00, 1423505A01, 1423507A00, 1423508A00, 1423524A00, 1423525A00... (Other models you can see in the webshop)		

E-G-O

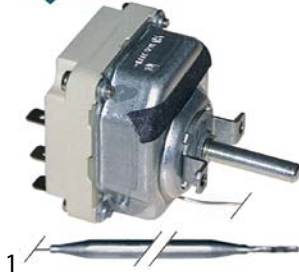

Part No.	375038	Ref. No.	203494
description	thermostat t.max. 300°C temperature range 50-300°C 3-pole 3NO 16A probe ø 6mm probe L 79mm capillary pipe 1740mm capillary pipe isolated 800mm gland nut shaft ø 6x4.6mm shaft L 23mm shaft position upper rotation 270°		
For models:	0221101-00, 0221101-01, 0221101A00, 0221101A01, 0221102-00, 0221102-01, 0221103-00, 0221103-01, 0221104-00, 0221104-01, 0221104A00, 0221104A01, 0221105-00, 0221105-01, 0221106-00, 0221106-01, 0221107-00, 0221107A00, 0221108-00, 0221109-00, 0221109A00, 0221110-00, 0522101-00, 0522101-01, 0522101-03, 0522102-00, 0522102-01, 0522102-03, 1221101-00, 1221101A00, 1221101B00, 1221102-00, 1221102A00, 1221102B00, 1221103-00, 1221103-01, 1221103-02, 1221103A00, 1221103A01, 1221103A02, 1221103B00, 1221103B01, 1221103B02, 1221103J00, 1221103J01, 1221104-00, 1221104-01, 1221104A00, 1221104A01, 1221104B00... (Other models you can see in the webshop)		

accessories for 375038



Part No.	110123	Ref. No.	—
knob thermostat t.max. 300°C ø 50mm shaft ø 6x4.6mm shaft flat upper black temperature range 50-300°C rotation 270°			



safety thermostats

51._series





Part No.	375518	Ref. No.	203479
description	safety thermostat switch-off temp. 213°C 1-pole 0.5A probe ø 6mm probe L 119mm capillary pipe 890mm capillary pipe isolatedmm gland nut probe SS		
For models:	0260301-00, 0260301-01, 0260302-00, 0260302-01, 1260301-00, 1260301-01, 1260302-00, 1260302-01, 1460302-00, 1460302-01, 1460302-02, 2060301-00, 2060301-01, 2060301-02, 20628022-2, 20628033-1, 20628033-2, 20628044-1, 20628044-2, 20629011-1, 20629011-2, 20629022-1, 20629022-2		

55.13._series



Part No.	375519	Ref. No.	203480
description	safety thermostat switch-off temp. 130°C 1-pole 1NO 16A probe ø 6mm probe L 129mm capillary pipe 830mm capillary pipe isolatedmm gland nut mounting thread M8x1 probe SS		
For models:	1462802B00, 1462802B01, 1462802B02, 1462802B03, 1462802B04, 1462802B05, 1462804B00, 1462804B01, 1462804B02, 1462804B03, 1462804B04, 1462804B05, 1462831-00, 1462832-00, 1462833-00, 1462834-00, 1462835-00, 1462836-00, 1462837-00, 1462838-00, 1462839-00, 1462840-00, 1462908-00, 1462910-00, 2062801-00, 2062801-01, 2062801-02, 2062801-03, 2062801-04, 2062801-05, 2062801-06, 2062801A00, 2062801A01, 2062801A02, 2062801A03, 2062801A04, 2062801A05, 2062801A06, 2062801B00, 2062801B01, 2062801B02, 2062801B03, 2062801B04, 2062801B05, 2062801B06, 2062801C00, 2062801C01, 2062801C02, 2062801C03, 2062801C04... (Other models you can see in the webshop)		
accessories for	375519		
	Part No.	102067	Ref. No. 201524
	nut thread M8x1 H 3mm brass Qty 1 pcs type SEF 1		



Part No.	375044	Ref. No.	203185
description	safety thermostat switch-off temp. 178°C 1-pole 16A probe ø 4mm probe L 91mm capillary pipe 1730mm capillary pipe isolated 1600mm gland nut probe with sealing sleeve screw connection M8x1 sealing sleeve 8.6x32mm		
For models:	1422802B04, 1422802B05, 1422802B06, 1422802B07, 1422802B08, 1422804B04, 1422804B05, 1422804B06, 1422804B07, 1422804B08, 1422805B04, 1422805B05, 1422805B06, 1422805B07, 1422805B08, 1422807B00, 1422807B01, 1422807B02, 1422807B03, 1422807B04, 1422831-00, 1422832-00, 1422833-00, 1422834-00, 1422902-00, 1422902-01, 1422902-02, 1422902-03, 1422902-04, 1422908-00, 1422910-00, 1423901-00, 1423901-01, 1423901-02, 1423902-00, 1423902-01, 1423902-02, 1423903-00, 1423903-01, 1423903-02, 2022801-02, 2022801-03, 2022801A02, 2022801A03, 2022801B02, 2022801B03, 2022801C02, 2022801C03, 2022802-02, 2022802-03... (Other models you can see in the webshop)		
accessories for	375044		
	Part No.	102067	Ref. No. 201524
	nut thread M8x1 H 3mm brass Qty 1 pcs type SEF 1		
	Part No.	551083	Ref. No. —
	cap for safety thermostat thread M8x1		

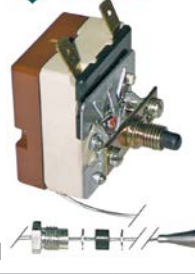

Part No.	390124	Ref. No.	203165 203492
description	safety thermostat switch-off temp. 246°C 1-pole 1NO 16A probe ø 6mm probe L 77mm capillary pipe 830mm capillary pipe isolatedmm gland nut M9x1 probe		
For models:	1220501-01, 1220802-00, 1220802-01, 1320501-00, 1320501A00, 1320802-00, 1320802A00, 1420801-01, 1420803-01, 1820301-00, 1820301-01, 1820301-02, 2120510-00, 2120510-01		



55.31_series

E-G-O

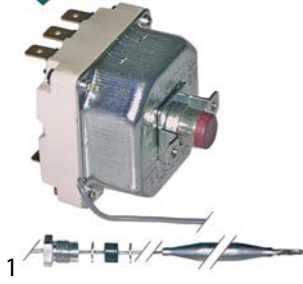

Part No.	375524	Ref. No.	203493
description	safety thermostat switch-off temp. 135°C 3-pole 20A probe ø 6mm probe L 173mm capillary pipe 1430mm capillary pipe isolated 800mm gland nut M9x1 probe SS		
For models:	1320401-00, 1320401-01, 1420401-00, 1420401-01, 2020401-00, 2020401-01, 2120401-00, 2120401-01		

E-G-O

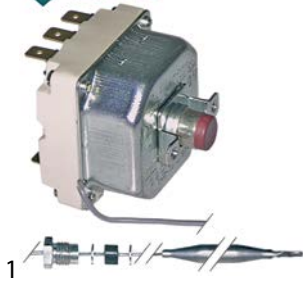

Part No.	375521	Ref. No.	203482 203483
description	safety thermostat switch-off temp. 240°C 3-pole 20A probe ø 6mm probe L 177mm capillary pipe 2380mm capillary pipe isolated 1100mm gland nut M9x1 probe SS		
For models:	0120101-00, 0120101C00, 0120105-00, 0120105C00, 0220301-00, 0220301B00, 0220301B01, 0220301B02, 0220301D00, 0220302-00, 0220302A00, 0220302A01, 0220302A02, 0220302A03, 0220302B00, 0220302B01, 0220302B02, 0220302C00, 0220302C01, 0220302C02, 0220302C03, 0220302D00, 0220302E00, 0220302E01, 0220302F00, 0220303-00, 0220303-01, 0220303A00, 0220303A01, 0220303A02, 0220303A03, 0220303B00, 0220303B01, 0220303C00, 0220303C01, 0220303C02, 0220303D00, 0220303D01, 0220303E00, 0220303E01, 0220304-00, 0220305-00, 0220306-00, 0520302-00, 0520303-00, 0520303-01, 0522101-01, 0522102-01, 1420301-00, 1420301B00... (Other models you can see in the webshop)		

55.32_series

E-G-O

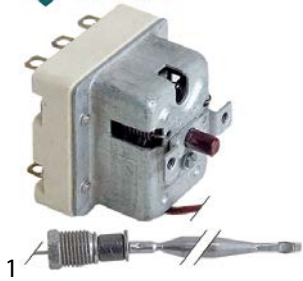

Part No.	375375	Ref. No.	900081
description	safety thermostat switch-off temp. 230°C 3-pole 20A probe ø 6mm probe L 94mm capillary pipe 900mm capillary pipe isolated 670mm gland nut M10x1 probe SS		

E-G-O

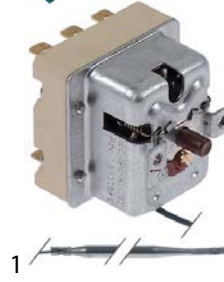

Part No.	375392	Ref. No.	203484
description	safety thermostat switch-off temp. 360°C 3-pole 1CO/2NC 20A probe ø 4mm probe L 120mm capillary pipe 1490mm capillary pipe isolated 1450mm gland nut probe SS		
For models:	0021130A00, 0021130A01, 0021135A00, 0221101-01, 0221101A01, 0221102-01, 0221103-01, 0221104-01, 0221104A01, 0221105-01, 0221106-01, 0221107-00, 0221107A00, 0221108-00, 0221109-00, 0221109A00, 0221110-00, 0522101-00, 0522102-00, 0721134-01, 0721134A01, 0721172A01, 0721173A01, 0721174A01, 0721175A01, 1022603-00, 1121117-00, 1121117-01, 1121117A00, 1121118-00, 1121118-01, 1121119-00, 1121119A00, 1121120-00, 1121121-00, 1121121A00, 1121135A01, 1220402-00, 1220402-01, 1221101-00, 1221101A00, 1221101B00, 1221102-00, 1221102A00, 1221102B00, 1221103-00, 1221103-01, 1221103-02, 1221103-04, 1221103A00... (Other models you can see in the webshop)		

55.33_series

E-G-O

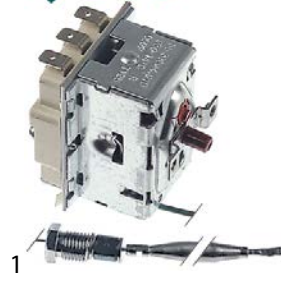

Part No.	375746	Ref. No.	203489
description	safety thermostat switch-off temp. 230°C 3-pole 20A probe ø 6mm probe L 117mm capillary pipe 1470mm capillary pipe isolated 1100mm gland nut M9x1 probe SS		
For models:	0120101-01, 0120101-02, 0120101-03, 0120101-04, 0120101D00, 0120101D01, 0120101D02, 0120101D04, 0120105-01, 0120105-02, 0120105-03, 0120105-04, 0120105D00, 0120105D01, 0120105D02, 0120105D04, 0220302H00, 0220302H01, 0220303H00, 0220303H01, 0520302-01, 0520302-02, 0520302A00, 0520302A01, 0520303-02, 0720325-03, 0720325-04, 0720325B03, 0720325B04, 1220301-00, 1220301-01, 1220301-02, 1220301-03, 1220301-04, 1220301B00, 1220301B01, 1220301B02, 1220301B03, 1220301B04, 1220301D00, 1220301D01, 1220301E00, 1220301E01, 1220301J00, 1220301J01, 1220301J02, 1220301J03, 1220302-00, 1220302-01, 1220302B00... (Other models you can see in the webshop)		



Part No.	375516	Ref. No.	203183
description	safety thermostat switch-off temp. 250°C 3-pole 20A probe ø 6mm probe L 107mm capillary pipe 1470mm capillary pipe isolated 1100mm gland nut M9x1 probe SS		
For models:	0522101-02, 0522101-03, 0522101-04, 0522102-02, 0522102-03, 0522102-04, 0722101-06, 1220504-01, 1221107-00, 1221108-00, 1320504-01, 1320504-02, 1321107-00, 1323208-00, 1323208-01, 1323208-02, 1323208-03, 1323208-04, 1323210-00, 1323210-01, 1323210-02, 1323210-03, 1323210-04, 1323403-00, 1323403K00, 1323506-00, 1323506-01, 1323506A00, 1323506A01, 1323517-00, 1323517A00, 1363403-00, 1363403-01, 1363403-02, 1363403-03, 1363403-04, 1363403-05, 1363415-05, 1420509-01, 1421122-00, 1422101-02, 1422101-03, 1422101-04, 1422101-05, 1422101-06, 1422102-02, 1422102-03, 1422102-04, 1422102-05, 1422104-05... (Other models you can see in the webshop)		

55.34_series



Part No.	375246	Ref. No.	203408
description	thermostat t.max. 645°C temperature range 100-615/645°C 2-pole 2NO 16A probe ø 4mm probe L 230mm capillary pipe 1100mm capillary pipe isolated 600mm gland nut shaft ø 6x4.6mm shaft L 25mm shaft position lower rotation 270° outer switch 2NO probe material copper		
For models:	0723405-01, 0723405-02, 0723409-01, 0723409-02, 0723413-02, 0723414-02, 1023410-00, 1423404-00, 1423404-01, 1423405-00, 1423405-01, 1423405-02, 1423409-00, 1423409-01, 1423409-02, 1423413-02, 1423414-02, 1423510A00, 1423511A00, 1423526A00, 1423527A00, 1424819-00, 1424826-00, 1523405-00, 1523405-01, 1523409-00, 1523409-01, 1523410-00, 2023206-00, 2023206-01, 2023206-02, 2023207-00, 2023207-01, 2023207-02, 2023207-03, 2023207-04, 2023207-05, 2023405-00, 2023405D00, 2023406-00, 2023409-00, 2023511A00, 2023512A00, 2061409B00, 2061409B01, 2061411B00, 2061411B01, 3023206-00, 3023206-01, 3023206-02... (Other models you can see in the webshop)		

control thermostats with operation switch

55.13_series

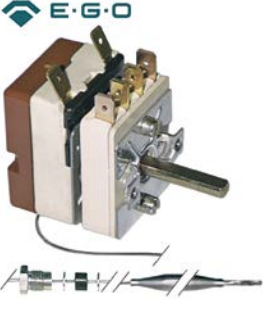

Part No.	375052	Ref. No.	203481
description	thermostat t.max. 195°C temperature range 140-195°C 1-pole 1NO 16A probe ø 6mm probe L 77mm capillary pipe 830mm capillary pipe isolated 500mm gland nut M9x1 shaft ø 6x4.6mm shaft L 23mm shaft position upper rotation 270° outer switch 2NO		
For models:	0120101-01, 0120101-02, 0120101-03, 0120101-04, 0120101D00, 0120101D01, 0120101D02, 0120101D04, 0120105-01, 0120105-02, 0120105-03, 0120105-04, 0120105D00, 0120105D01, 0120105D02, 0120105D04, 0520302-01, 0520302-02, 0520302A00, 0520302A01, 1820301-00, 1820301-01, 1820301-02, 2160501-00		

accessories

probe clips

clamps



for thermostat



Part No.	550878	Ref. No.	208057 575077
description	probe clip for pipe ømm for probe ø 6mm Qty 1 pcs		
For models:	0120101-00, 0120101-01, 0120101-02, 0120101-03, 0120101-04, 0120101C00, 0120101D00, 0120101D01, 0120101D02, 0120101D04, 0120105-00, 0120105-01, 0120105-02, 0120105-03, 0120105-04, 0120105C00, 0120105D00, 0120105D01, 0120105D02, 0120105D04, 0120202-00, 0120203-00, 0220301-00, 0220301B00, 0220301B01, 0220301B02, 0220301D00, 0220302-00, 0220302B00, 0220302B01, 0220302B02, 0220302D00, 0220302E00, 0220302E01, 0220302F00, 0220302H00, 0220302H01, 0220303-00, 0220303-01, 0220303B00, 0220303B01, 0220303D00, 0220303D01, 0220303E00, 0220303E01, 0220303H00, 0220303H01, 0220501-00, 0220502-00, 0220503-00... (Other models you can see in the webshop)		





			
1			
Part No.	550877	Ref. No.	208058 575076
description	probe clip for pipe ømm for probe ø 8mm Qty 1 pcs		
For models:	0120101-00, 0120101-01, 0120101-02, 0120101-03, 0120101-04, 0120101C00, 0120101D00, 0120101D01, 0120101D02, 0120101D04, 0120105-00, 0120105-01, 0120105-02, 0120105-03, 0120105-04, 0120105C00, 0120105D00, 0120105D01, 0120105D02, 0120105D04, 0120202-00, 0120202-01, 0120203-00, 0120203-01, 0220301-00, 0220301B00, 0220301B01, 0220301B02, 0220301D00, 0220302-00, 0220302B00, 0220302B01, 0220302B02, 0220302D00, 0220302E00, 0220302E01, 0220302F00, 0220302H00, 0220302H01, 0220303-00, 0220303-01, 0220303B00, 0220303B01, 0220303D00, 0220303D01, 0220303E00, 0220303E01, 0220303H00, 0220303H01, 0220501-00... (Other models you can see in the webshop)		

			
1			
Part No.	550556	Ref. No.	208062
description	probe clip for pipe ø 2x8.5mm for probe ømm for heating elements spacing 25mm Qty 1 pcs L 37mm W 10mm		
For models:	0120101-00, 0120101-01, 0120101-02, 0120101-03, 0120101-04, 0120101C00, 0120101D00, 0120101D01, 0120101D02, 0120101D04, 0120105-00, 0120105-01, 0120105-02, 0120105-03, 0120105-04, 0120105C00, 0120105D00, 0120105D01, 0120105D02, 0120105D04, 0120202-00, 0120203-00, 0520302A00, 0520302A01, 0720504-04, 1020510-00, 1120510-00, 1120510-01, 1220303A00, 1220303A01, 1220303A02, 1220303A03, 1220303C00, 1220303C01, 1220303C02, 1220303C03, 1220303F01, 1220303F02, 1220303F03, 1220303H00, 1220303H01, 1220303H02, 1220303H03, 1220304A00, 1220304A01, 1220304A02, 1220304C00, 1220304C01, 1220304C02, 1220304F00... (Other models you can see in the webshop)		
accessories for	550556		
	Part No.	550557	Ref. No. 208063
spacer piece			

			
1			
Part No.	550135	Ref. No.	208059 575022 945071
description	probe clip for pipe ø 8.5mm for probe ø 6mm L 25mm Qty 10 pcs		
For models:	0021130A00, 0021130A01, 0021135A00, 0120101-00, 0120101-01, 0120101-02, 0120101C00, 0120101D00, 0120101D01, 0120105-01, 0120105-02, 0120105D00, 0120105D01, 0120201-00, 0120201-01, 0220301-00, 0220301B00, 0220301B01, 0220301B02, 0220301D00, 0220302-00, 0220302B00, 0220302B01, 0220302B02, 0220302D00, 0220302E00, 0220302E01, 0220302F00, 0220302H00, 0220302H01, 0220303-00, 0220303-01, 0220303B00, 0220303B01, 0220303D00, 0220303D01, 0220303E00, 0220303E01, 0220303H00, 0220303H01, 0221101-01, 0221101A01, 0221102-01, 0221103-01, 0221104-01, 0221104A01, 0221105-01, 0221106-01, 0221107-00, 0221107A00... (Other models you can see in the webshop)		

protective pipes for capillary pipes			
1			
Part No.		Ref. No.	935211
description	protective pipe for capillaries		
For models:	0220501-00, 0220502-00, 0220503-00, 0220802-00, 0522101-00, 0522101-01, 0522101-02, 0522101-03, 0522102-00, 0522102-01, 0522102-02, 0522102-03, 1323208-00, 1323208-01, 1323208-02, 1323208-03, 1323210-00, 1323210-01, 1323210-02, 1363403-00, 1363403-01, 1363403-02, 1420501-00, 1420502-00, 1420504-00, 1420505-00, 1420801-00, 1420803-00, 1422101-00, 1422101-01, 1422101-02, 1422101-03, 1422102-00, 1422102-01, 1422102-02, 1422102-03, 14621011-0, 2020501-00, 2020501-01, 20205011-0, 2020502-00, 2020503-0, 2020504-00, 2020505-00, 2023203-00, 2023203-01, 2023203-02, 2023203-03, 2023203-04, 2023203-05... (Other models you can see in the webshop)		

			
1			
Part No.	550385	Ref. No.	541673
description	protective pipe for capillaries thread M10x1 H1 120mm L1 50mm L2 125mm		
For models:	0120101-00, 0120101-01, 0120101-02, 0120101-03, 0120101-04, 0120101C00, 0120101D00, 0120101D01, 0120101D02, 0120101D04		

			
1			
Part No.	550386	Ref. No.	541674
description	protective pipe for capillaries thread M10x1 H1 148mm L1 46mm L2 100mm		
For models:	0120105-00, 0120105-01, 0120105-02, 0120105-03, 0120105-04, 0120105C00, 0120105D00, 0120105D01, 0120105D02, 0120105D04		

			
1			
Part No.	551107	Ref. No.	935206 935526
description	protective pipe for capillaries thread M10x1 H1 200mm H2 12mm L1 190mm L2 95mm		
For models:	0220301-00, 0220301B00, 0220301B01, 0220301B02, 0220301D00, 0220302-00, 0220302A00, 0220302A01, 0220302A02, 0220302A03, 0220302B00, 0220302B01, 0220302B02, 0220302C00, 0220302C01, 0220302C02, 0220302C03, 0220302D00, 0220302E00, 0220302E01, 0220302F00, 0220302H00, 0220302H01, 0220303-00, 0220303-01, 0220303A00, 0220303A01, 0220303A02, 0220303A03, 0220303B00, 0220303B01, 0220303C00, 0220303C01, 0220303C02, 0220303D00, 0220303D01, 0220303E00, 0220303E01, 0220303H00, 0220303H01, 0220304-00, 0220305-00, 0220306-00, 0720325-03, 0720325-04, 0720325B03, 0720325B04, 0720332P00, 0720332R00, 0720332T00... (Other models you can see in the webshop)		



			
1			
Part No.	550380	Ref. No.	541219
description	protective pipe for capillaries thread M10x1 H1 215mm H2 190mm L1 67mm L2 30mm		
For models:	0520302-00, 0520302-01, 0520302-02		

plunger sockets			
			
1			
Part No.	550285	Ref. No.	541221 935211
description	protection pipe thread M12x0.75 IT M9x1 ET M12x0.75 L 66mm SS single ø 10mm		

switches and momentary switches

rocker/momentary rocker switches

30x22mm			
			
1			
Part No.	301060	Ref. No.	203235 301060
description	rocker switch mounting measurements 30x22mm red 2NO 250V 16A illuminated connection male faston 6.3mm ambient temperature max. 125/55°C protection IP40		
For models:	0521705-01, 0521706-00, 1224002-00, 1224002-01, 1224003-00, 1224003-01, 1224004-00, 1224004-01, 1224005-00, 1224005-01, 1224006-00, 1224006-01, 1224007-00, 1224007-01, 1224008-00, 1224008-01, 1224009-00, 1224009-01, 2020339A00, 2020339A01, 2062801-00, 2062801A00, 2062801B00, 2062801C00, 2062802-00, 2062802-2, 2062802A00, 2062802B00, 2062802C00, 2062803-00, 2062803-1, 2062803-2, 2062803A00, 2062803B00, 2062803C00, 2062804-00, 2062804-1, 2062804-2, 2062804A00, 2062804B00, 2062804C00, 2062806-00, 2062806A00, 2062806B00, 2062806B01, 2062806B02, 2062806B03, 2062806C00, 2062806C01, 2062806C02... (Other models you can see in the webshop)		

push/momentary push switches

30x22mm			
			
1			
Part No.	301048 ¹	Ref. No.	203320
description	push switch mounting measurements 30x22mm yellow 2NO 250V 16A illuminated connection male faston 6.3mm ambient temperature max. 85°C protection IP40 latching		
For models:	20628022-0, 20628022-1, 20628033-0, 20628044-0, 20629011-0, 20629022-0		

¹illuminated

accessories

push buttons

			
1			
Part No.	348214	Ref. No.	207186
description	button for display PCB transparent suitable for MKN ED ø 16mm H 4.8mm for combi-steamer		
For models:	CSE11-L, CSE11-R, CSE11-R-DG, CSE12-L, CSE12-R, CSE12-R-DG, CSE21-L, CSE21-R, CSE21-R-DG, CSE22-L, CSE22-R, CSE22-R-DG, CSE61-L, CSE61-R, CSE61-R-DG, CSE62-L, CSE62-R, CSE62-R-DG, CSG11-L, CSG11-R, CSG11-R-DG, CSG12-L, CSG12-R, CSG12-R-DG, CSG21-L, CSG21-R, CSG21-R-DG, CSG22-L, CSG22-R, CSG22-R-DG, CSG61-L, CSG61-R, CSG61-R-DG, CSG62-L, CSG62-R, CSG62-R-DG		

microswitches

lever actuated

			
1			
Part No.	346456	Ref. No.	203340
description	microswitch with lever 250V 0.1A 1CO connection male faston 6.3mm L 36mm ambient temperature max. 85°C mounting distance 22mm type CHERRY D41Y actuating force: 25g lever length 26mm		
For models:	0521706-00, 1220304A00, 1220304A01, 1220304A02, 1220304C00, 1220304C01, 1220304C02, 1220304F00, 1220304F01, 1220304H00, 1220304H01, 1220306A00, 1220306A01, 1220306A02, 1220306A03, 1220306A04, 1220306C00, 1220306C01, 1220306C02, 1220306C03, 1220306C04, 1220306F00, 1220306F01, 1220306F02, 1220306F03, 1220306H00, 1220306H01, 1220306H02, 1220306H03, 1320304A00, 1320304A01, 1320304A02, 1320304C00, 1320304C01, 1320304C02, 1320304F00, 1320304F01, 1320304F02, 1320304F03, 1320304F04, 1320304H00, 1320304H01, 1320304H02, 1320304H03, 1320304H04, 1320306A01, 1320306A02, 1320306A03, 1320306C01, 1320306C02... (Other models you can see in the webshop)		

			
1			
Part No.	345255	Ref. No.	203334
description	microswitch with lever 250V 16A 1CO connection male faston 6.3mm L 35mm L1 28mm ambient temperature max. 125°C mounting distance 22mm actuating force: 136g lever length 27mm		
For models:	0220301-00, 0220301B00, 0220301B01, 0220301B02, 0220301D00, 0220302-00, 0220302A00, 0220302A01, 0220302A02, 0220302A03, 0220302B00, 0220302B01, 0220302B02, 0220302C00, 0220302C01, 0220302C02, 0220302C03, 0220302D00, 0220302E00, 0220302E01, 0220302F00, 0220302H00, 0220302H01, 0220303-00, 0220303-01, 0220303A00, 0220303A01, 0220303A02, 0220303A03, 0220303B00, 0220303B01, 0220303C00, 0220303C01, 0220303C02, 0220303D00, 0220303D01, 0220303E00, 0220303E01, 0220303H00, 0220303H01, 1420301-00, 1420301B00, 1420302-00, 1420302A00, 1420302B00, 1420302C00, 1420303-00, 1420303A00, 1420303B00, 1420303C00... (Other models you can see in the webshop)		



1

Part No.	345702	Ref. No.	203339
description	microswitch with lever 250V 6A 1CO connection male faston 6.3mm L 35mm ambient temperature max. 85°C mounting distance 22mm actuating force: 60g		
For models:	0720325-03, 0720325-04, 0720325B03, 0720325B04, 0720332P00, 0720332R00, 0720332T00, 0720332V00, 1220301-00, 1220301-01, 1220301-02, 1220301-03, 1220301-04, 1220301B00, 1220301B01, 1220301B02, 1220301B03, 1220301B04, 1220301D00, 1220301D01, 1220301E00, 1220301E01, 1220301J00, 1220301J01, 1220301J02, 1220301J03, 1220302-00, 1220302-01, 1220302B00, 1220302B01, 1220302D00, 1220302E00, 1220303-00, 1220303-01, 1220303-02, 1220303-03, 1220303-04, 1220303-05, 1220303A00, 1220303A01, 1220303A02, 1220303A03, 1220303B00, 1220303B01, 1220303B02, 1220303B03, 1220303B04, 1220303B05, 1220303C00, 1220303C01... (Other models you can see in the webshop)		

pin-plunger actuated

miscellaneous



1

Part No.	347023	Ref. No.	203232
description	microswitch 250V 16A connection screw connection ambient temperature max. 125°C mounting distance 96mm		
For models:	2020307A00		

float switches



1

Part No.	401464	Ref. No.	203210
description	float switch thread M46x2 1NO ø 44mm L 140mm mounting ø 46mm 250V 5A cable cable length 2000mm		
For models:	14228011-0, 14228022-0, 14228033-0, 14228044-0, 14228055-0, 2022801-00, 2022801-01, 2022801A00, 2022801A01, 2022801B00, 2022801B01, 2022801C00, 2022801C01, 2022802-00, 2022802-01, 2022802A00, 2022802A01, 2022802B00, 2022802B01, 2022802C00, 2022802C01, 2022803-00, 2022803-01, 2022803A00, 2022803A01, 2022803B00, 2022803B01, 2022803C00, 2022803C01, 2022804-00, 2022804-01, 2022804A00, 2022804A01, 2022804B00, 2022804B01, 2022804C00, 2022804C01, 2022805-00, 2022805-01, 2022805A00, 2022805A01, 2022805B00, 2022805B01, 2022805C00, 2022805C01, 2022806-00, 2022806A00, 2022806B00, 2022806B01, 2022806B02... (Other models you can see in the webshop)		

cam switches

on/off



1

Part No.	347953	Ref. No.	203958
description	cam switch 4 operating positions 2NO sequence 0-1-0-1 16A shaft ø 6x4.6mm shaft L 23mm connection male faston 6.3mm ON-OFF plastic		
For models:	0524301-01, 0524302-01, 0524303-01, 0524304-01, 0721134-01, 0721134A01, 0721172A01, 0721173A01, 0721174A01, 0721175A01, 1221103-04, 1221103B04, 1221130J00, 1221135A04, 1221135J00, 1221136A04, 1221141-00, 1221141A00, 1221156A00, 1222507-00, 1222509-00, 1321130-00, 1321130A00, 1321131-00, 1321131A00, 1321135A03, 1321136A03, 1321141-00, 1321141A00, 1322507-00, 1322509-00, 1421117-03, 1421118-03, 1421126B00, 1421127B00, 1421130B00, 1421131-00, 1421131A00, 1421131B00, 1421139-00, 1421139A00, 1421139B00, 1421141-00, 1421141A00, 1421141B00, 1421143B01, 1421144B01, 1421145B01, 1421149B00, 1421149B01... (Other models you can see in the webshop)		



1

Part No.	300021	Ref. No.	203563
description	cam switch 4 operating positions 4NO sequence 0-1-0-1 16A shaft ø 6x4.6mm shaft L 23mm connection screw ceramic		
For models:	0120101-00, 0120101C00, 0120105-00, 0120105C00, 0220301-00, 0220301B00, 0220301B01, 0220301B02, 0220301D00, 0220302-00, 0220302A00, 0220302A01, 0220302A02, 0220302A03, 0220302C00, 0220302C01, 0220302C02, 0220302C03, 0220302D00, 0220302F00, 0220302H00, 0220302H01, 0220303B00, 0220303B01, 0220303C00, 0220303C01, 0220303C02, 0220303E00, 0220303E01, 0220303H00, 0220303H01, 0220304-00, 0220305-00, 0220306-00, 0220501-00, 0220502-00, 0220503-00, 0220601-00, 0220802-00, 0221001H00, 0221202-00, 0221501-00, 0221502-00, 0520302-00, 0520303-00, 0520303-01, 0520303-02, 0520901-00, 0522101-01, 0522101-02... (Other models you can see in the webshop)		



1

Part No.	300102	Ref. No.	203564
description	cam switch 4 operating positions 4NO sequence 0-1-0-1 32A shaft ø 6x4.6mm shaft L 23mm connection screw ceramic		
For models:	0021130A00, 0021130A01, 0021135A00, 0220302B00, 0220302B01, 0220302B02, 0220302E00, 0220302E01, 0220303-00, 0220303-01, 0220303A00, 0220303A01, 0220303A02, 0220303A03, 0220303D00, 0220303D01, 0220306-00, 0221101-00, 0221101-01, 0221101A00, 0221101A01, 0221102-00, 0221102-01, 0221103-00, 0221103-01, 0221104-00, 0221104-01, 0221104A00, 0221104A01, 0221105-00, 0221105-01, 0221106-00, 0221106-01, 0221107-00, 0221107A00, 0221108-00, 0221109-00, 0221109A00, 0221110-00, 0522101-00, 0522102-00, 0723104-03, 0723104A03, 0723104B03, 0723405-01, 0723405-02, 0723409-01, 0723409-02, 0723412K01, 0723413-02... (Other models you can see in the webshop)		

4-position

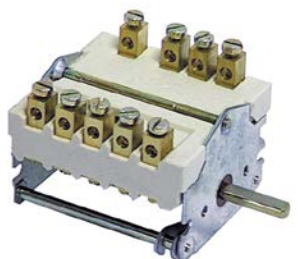

1

Part No.	300104	Ref. No.	203074
description	cam switch 4 operating positions 3NO/1CO sequence 0-1-2-3 32A shaft ø 6x4.6mm shaft L 23mm connection screw ceramic		

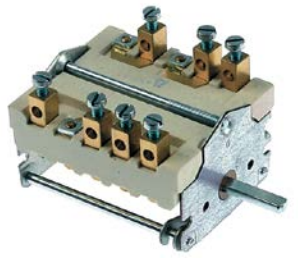

1

Part No.	300194	Ref. No.	203223 203228
description	cam switch 4 operating positions 4NO sequence 0-1-2-3 16A shaft ø 6x4.6mm shaft L 23mm connection screw 4-position ceramic		
For models:	0522101-03, 0522101-04, 0522102-03, 0522102-04, 0722101-06, 1323208-02, 1323208-03, 1323208-04, 1323210-00, 1323210-01, 1323210-02, 1323210-03, 1323210-04, 1323403-00, 1323403K00, 1323506-00, 1323506-01, 1323506A00, 1323506A01, 1323517-00, 1323517A00, 1363403-02, 1363403-03, 1363403-04, 1363403-05, 1363415-05, 1422101-03, 1422101-04, 1422101-05, 1422101-06, 1422102-03, 1422102-04, 1422102-05, 1422104-05, 1422104A05, 1422105-05, 1422105A05, 1422106-05, 1422106-06, 1422106A05, 1422106A06, 1422107-05, 1422107-06, 1422107A05, 1422107A06, 1422301-01, 2023114-00, 2023118-00, 2023119-00, 2023203-05... (Other models you can see in the webshop)		

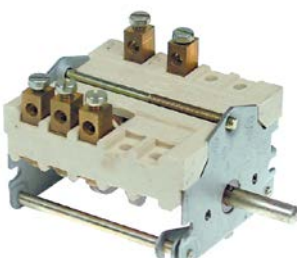

1

Part No.	300192	Ref. No.	203216
description	cam switch 4-position sequence 0-3-2-1 32A shaft ø 6x4.6mm connection screw clamp 2-pole		
For models:	2023302-00, 2023303-00, 2023304-00, 2023305-00		



7-position



1

Part No.	300025	Ref. No.	203224
description	cam switch 7 operating positions 1NO/2CO sequence 0-1-2-3-4-5-6 16A shaft ø 6x4.6mm shaft L 23mm connection screw 7-position ceramic		
For models:	0223202-00, 1223201-00, 1223201-01, 1223202-00, 1223207-00, 1223207-01, 1323201-00, 1323201-01, 1323201-02, 1323207-00, 1323207-02, 1323208-00, 1323208-01, 1323208-02, 1323208-03, 1323208-04, 1424802-00, 1424802-01, 1424802-02, 1424808-00, 1424808-01, 1424808-02, 1424808-03, 1424809-00, 1424809-01, 1424809-02, 1424809-03, 1424811-00, 1424811-01, 1424811-02, 1424811-03, 1424812-00, 1424812-01, 1424812-02, 1424813-00, 1424813-01, 1424813-02, 1424816-00, 18232011-0, 2023201-00, 2023201-01, 2023201-02, 2023201-03, 20232011-0, 20232011-1, 2023201A00, 2023201A01, 2023202-00, 2023202-01, 2023202-02... (Other models you can see in the webshop)		

accessories for 300025

	Part No.	112172	Ref. No.	—
knob universal ø 70mm black without adaptor/dial plate				
	Part No.	112213	Ref. No.	—
knob dial plate silver switch 7-position t.max.°C ED ø 63mm ID ø 45.5mm				
	Part No.	112311	Ref. No.	—
knob adapter shaft ø 6x4.6mm L 0mm with spring				



1

Part No.	300106	Ref. No.	203560
description	cam switch 7 operating positions 1NO/2CO sequence 0-1-2-3-4-5-6 32A shaft ø 6x4.6mm shaft L 23mm connection screw 7-position shaft flat upper		
For models:	1320401-00, 1320401-01, 1420401-00, 1420401-01, 2020401-00, 2020401-01, 2120401-00, 2120401-01		



4 operating positions

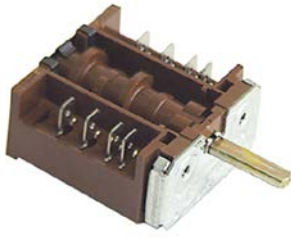

Part No.	300170	Ref. No.	203414
description	cam switch 4 operating positions 3NO sequence 0-1-2-3 16A shaft ø 6x4.6mm shaft L 23mm connection male faston 6.3mm		
For models:	1220504-01, 1222601-00, 1320504-01, 1320504-02, 1322601-00, 1420509-01, 1422601-00, 1422602-00, 1422802B04, 1422802B05, 1422802B06, 1422802B07, 1422802B08, 1422804B04, 1422804B05, 1422804B06, 1422804B07, 1422804B08, 1422805B04, 1422805B05, 1422805B06, 1422805B07, 1422805B08, 1422807B00, 1422807B01, 1422807B02, 1422807B03, 1422807B04, 1422831-00, 1422832-00, 1422902-00, 1422902-01, 1422902-02, 1422902-03, 1422902-04, 1422908-00, 1462802B00, 1462802B01, 1462802B02, 1462802B03, 1462802B04, 1462802B05, 1462804B00, 1462804B01, 1462804B02, 1462804B03, 1462804B04, 1462804B05, 2020506-01, 2022601-00... (Other models you can see in the webshop)		



Part No.	300195	Ref. No.	203156
description	cam switch 4 operating positions 6NO sequence 0-1-2-3 16A shaft ø 6x4.6mm shaft L 23mm connection male faston 6.3mm		
For models:	1220304-00, 1220304-01, 1220304A00, 1220304A01, 1220304A02, 1220304B00, 1220304B01, 1220304C00, 1220304C01, 1220304C02, 1220304D00, 1220304E00, 1220304F00, 1220304F01, 1220304H00, 1220304H01, 1320304-00, 1320304-01, 1320304A00, 1320304A01, 1320304A02, 1320304B00, 1320304B01, 1320304C00, 1320304C01, 1320304C02, 1320304D00, 1320304D01, 1320304E00, 1320304E01, 1320304F00, 1320304F01, 1320304F02, 1320304F03, 1320304F04, 1320304H00, 1320304H01, 1320304H02, 1320304H03, 1320304H04, 2022801-02, 2022801-03, 2022801A02, 2022801A03, 2022801B02, 2022801B03, 2022801C02, 2022801C03, 2022802-02, 2022802-03... (Other models you can see in the webshop)		

with potentiometer



Part No.	347952	Ref. No.	203894
description	cam switch 16 operating positions 3NO sequence 0-16 16A shaft ø 6x4.6mm shaft L 23mm connection male faston 2.8mm incl code pcb cable lengthmm codedOhm plastic		
For models:	0723104-03, 0723104A03, 0723104B03, 0723105-03, 0723105A03, 0723105B03, 1023101-00, 1023101-01, 1023106-00, 1023106-01, 1023111-00, 1023111-01, 1223101-00, 1223101-01, 1223101-02, 1223103-00, 1223103-01, 1223103-02, 1223106-00, 1223106-01, 1223106-02, 1223111-00, 1223203-03, 1223211-01, 1323101-00, 1323101-01, 1323101-02, 1323103-00, 1323103-01, 1323103-02, 1323106-00, 1323203-02, 1323211-02, 1423101-00, 1423101-01, 1423101-02, 1423101A00, 1423101A01, 1423103-00, 1423103-01, 1423103-02, 1423103A00, 1423103A01, 1423104-00, 1423104-01, 1423104-02, 1423104-03, 1423104A00, 1423104A01, 1423104A03... (Other models you can see in the webshop)		

rotary switches

MOELLER/EATON



Part No.	347954	Ref. No.	203969
description	rotary switch 3 0-1-2 sets of contacts 4 type T0-2-15512 400V 16A shaft ø 5.8x6.9mm shaft L 27mm shaft square connection screw		

miscellaneous



Part No.	346440	Ref. No.	203227
description	rotary switch sets of contacts 3 2 0-1 type B15R A-XF-X-XX 380V 10A shaft ø 5x5mm shaft L 21mm shaft square connection screw		

magnetic switches

28.5x19mm

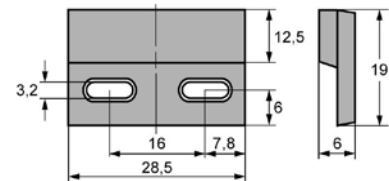

Part No.	345219	Ref. No.	203028
description	magnetic switch L 28.5mm W 19mm 1NO 230V 0.5A P max. 10W connection cable cable length 800mm		
For models:	0120101-01, 0120101-02, 0120101-03, 0120101-04, 0120101D00, 0120101D01, 0120101D02, 0120101D04, 0120105-01, 0120105-02, 0120105-03, 0120105-04, 0120105D00, 0120105D01, 0120105D02, 0120105D04, 0520302-01, 0520302-02, 0520302A00, 0520302A01, 0520303-01, 0520303-02, 1423901-00, 1423901-01, 1423901-02, 1423902-00, 1423902-01, 1423902-02, 1423903-00, 1423903-01, 1423903-02, 1424101-00, 1424101-01, 1424102-00, 1424102-01, 1424103-00, 1424104-00, 1820301-01, 1820301-02, 2012827-01, 2012827-02, 2012828-00, 2012828-01, 2012828-02, 2012828-03, 2012828-04, 2012828-05, 2012829-00, 2012829-01, 2012829-02... (Other models you can see in the webshop)		



29x19mm



1

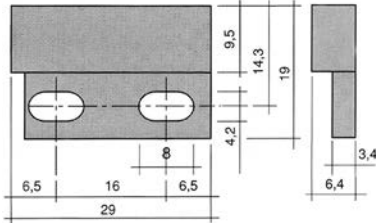

Part No.	345808	Ref. No.	202722
description	magnetic switch L 29mm W 19mm 1CO 150V 0.5A P max. 10W connection cable length 1000mm		
For models:	CCE60, CCE63, CGE11-L, CGE11-R, CGE12-L, CGE12-R, CGE21-L, CGE21-R, CGE22-L, CGE22-R, CGE61-L, CGE61-R, CGE62-L, CGE62-R, CGG11-L, CGG11-R, CGG12-L, CGG12-R, CGG21-L, CGG21-R, CGG22-L, CGG22-R, CGG61-L, CGG61-R, CGG62-L, CGG62-R, CPE60, CPE63, CSE11-L, CSE11-R, CSE11-R-DG, CSE12-L, CSE12-R, CSE12-R-DG, CSE21-L, CSE21-R, CSE21-R-DG, CSE22-L, CSE22-R, CSE22-R-DG, CSE61-L, CSE61-R, CSE61-R-DG, CSE62-L, CSE62-R, CSE62-R-DG, CSG11-L, CSG11-R, CSG11-R-DG, CSG12-L...(Other models you can see in the webshop)		



1

Part No.	348213	Ref. No.	10013771
description	magnetic switch L 29mm W 19mm 1NO 0.5A P max. 10W connection plug cable length 500mm 200VDC		

accessories

magnets



1

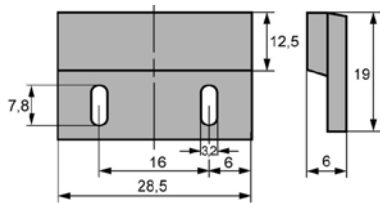

Part No.	345700	Ref. No.	203031
description	magnet ømm L 29mm H 6.5mm W 19mm hole distance 16mm M3 hole ø 3.5mm		

control equipment

MOELLER/EATON

signal element



1

Part No.	347524	Ref. No.	203110
description	signal element mounting measurements ø22mm with socket element blue with light bulb 130V		
For models:	0220302A00, 0220302A01, 0220302A02, 0220302A03, 0220302C00, 0220302C01, 0220302C02, 0220302C03, 0220302H00, 0220302H01, 0220303A00, 0220303A01, 0220303A02, 0220303A03, 0220303C00, 0220303C01, 0220303C02, 0220303H00, 0220303H01, 0220304-00, 0220305-00, 0220306-00		

button plates with symbol



1

Part No.	346464	Ref. No.	203303
description	button plate black automatic/manual		

switches (complete)

rotary switches



1

Part No.	346463	Ref. No.	203350
description	rotary selector mounting measurements ø22mm black 3NO sequence 1-0-2		
For models:	2013004B01, 2013004B02, 2013004B03, 2013004B04, 2013004B05, 2013008B01, 2013008B02, 2013008B03, 2013008B04, 2013008B05, 2013010B01, 2013010B02, 2013010B03, 2013010B04, 2013010B05, 2013018B00, 2013018B01, 2013018B02, 2013018B03, 2013018B04, 2020303-00, 2020303-01, 2020303-02, 2020303-03, 2020303-04, 2020303A00, 2020310-00, 2020310-01, 2020310-02, 2020310-03, 2020310A00, 2020310A01, 2020310A02, 2020310A03, 2020311-00, 2020311-01, 2020311-02, 2020311-03, 2020311A00, 2020311A01, 2020311A02, 2020311A03, 2020312A00, 2020312A01, 2020312A02, 2020314-01, 2020314-02, 2020314-03, 2020314A01, 2020314A02...(Other models you can see in the webshop)		

spare parts for	346463			
	Part No.	346292	Ref. No.	—
	Part No.	346293	Ref. No.	—
	Part No.	346462	Ref. No.	—
	momentary selector switch mounting measurements ø22mm black/white 330°-0°-30° momentary/momentary sequence 1-0-2			



1			
Part No.	Ref. No.	203365	
description	rotary selector mounting measurements ø22mm black sequence 1-0-2		
For models:	2021404-00, 2021404-01, 2021404-02, 2021404-03, 2021404-04, 2021404A00, 2021404A01, 2021404A02, 2021404B00, 2021404B01, 2021404B02, 2021404C00, 2021404C01, 2021404C02, 2021406-00, 2021406-01, 2021406-02, 2021406B00, 2021406B01, 2023002-00, 2023002-01, 2023002-02, 2023002A00, 2023002B00, 2023002C00, 2023004-00, 2023004-01, 2023004-02, 2023004A00, 2023004B00, 2023004B01, 2023004B02, 2023004B03, 2023004B04, 2023004B05, 2023004B06, 2023004B07, 2023004C00, 2023006-00, 2023006-01, 2023006-02, 2023006A00, 2023006B00, 2023006C00, 2023008-00, 2023008-01, 2023008-02, 2023008A00, 2023008B00, 2023008C00, 2023008B01... (Other models you can see in the webshop)		

1			
Part No.	Ref. No.	203367	
description	rotary switch mounting measurements ø22mm black latching 1NC/1NO sequence 0-1		
For models:	2020303-00, 2020303-01, 2020303-02, 2020303-03, 2020303-04, 2020303A00, 2020310-00, 2020310-01, 2020310-02, 2020310-03, 2020310A00, 2020310A01, 2020310A02, 2020310A03, 2020311-00, 2020311-01, 2020311-02, 2020311-03, 2020311A00, 2020311A01, 2020311A02, 2020311A03, 2020312A00, 2020312A01, 2020312A02, 2020314-01, 2020314-02, 2020314-03, 2020314A01, 2020314A02, 2020314A03, 2020315-01, 2020315-02, 2020315-03, 2020315A01, 2020315A02, 2020315A03, 2020339A00, 2020339A01, 2020340A00, 2020340A01, 2020341-00, 2020341A00, 2020342-00, 2020342A00, 3020310-00, 3020310-01, 3020310A00, 3020310A01, 3020311-00... (Other models you can see in the webshop)		

push/momentary push switches

1			
Part No.	Ref. No.	203304	
description	momentary push switch mounting measurements ø22mm black 1NC/1NO lifting countersink momentary		

*lift/decline

1			
Part No.	Ref. No.	203313	
description	momentary push switch mounting measurements ø22mm yellow illuminated, 80-264V 1NC/1NO momentary		
For models:	1424824-00, 1424824-01, 1462802B00, 1462802B01, 1462802B02, 1462802B03, 1462802B04, 1462802B05, 1462804B00, 1462804B01, 1462804B02, 1462804B03, 1462804B04, 1462804B05, 1462831-00, 1462832-00, 1462833-00, 1462834-00, 1462835-00, 1462836-00, 1462837-00, 1462838-00, 1462839-00, 1462840-00, 1462908-00, 1462910-00, 2061401-05, 2061401-06, 2061401-07, 2061401-08, 2061401A05, 2061401A06, 2061401A07, 2061401A08, 2061401B05, 2061401B06, 2061401B07, 2061401B08, 2061401C05, 2061401C06, 2061401C07, 2061401C08, 2061402-05, 2061402-06, 2061402-07, 2061402A05, 2061402A06, 2061402A07, 2061402B05, 2061402B06... (Other models you can see in the webshop)		

lamps

1			
Part No.	Ref. No.	203120	
description	neon light bulb socket Ba9s 220V 2W clear ø 10mm L 28mm		
For models:	1424824-00, 1462802B00, 1462804B00, 2061401-05, 2061401A05, 2061401B05, 2061401C05, 2061402-05, 2061402A05, 2061402B05, 2061402C05, 2061403-00, 2061403-01, 2061403-02, 2061403-03, 2061403-04, 2061403A00, 2061403A02, 2061403A03, 2061403B00, 2061403B02, 2061403B03, 2061403C00, 2061403C02, 2061403C03, 2061404-00, 2061404-01, 2061404-02, 2061404-03, 2061404-04, 2061404A00, 2061404A02, 2061404A03, 2061404B00, 2061404B02, 2061404B03, 2061404C00, 2061404C02, 2061404C03, 2061405-00, 2061405-01, 2061405-02, 2061405B00, 2061405B01, 2061405B02, 2061406-00, 2061406-01, 2061406-02, 2061406B00, 2061406B01... (Other models you can see in the webshop)		
accessories for	359606		
Part No.	Ref. No.	—	
description	lamp socket mounting measurements ø16.2mm socket Ba9s connection male faston 6.3mm		
Part No.	Ref. No.	—	
description	lamp socket mounting measurements ø18.2mm socket Ba9s connection male faston 6.3mm		

encoders and potentiometers

1			
Part No.	Ref. No.	203894	
description	cam switch 16 operating positions 3NO sequence 0-16 16A shaft ø 6x4.6mm shaft L 23mm connection male faston 2.8mm incl code pcb cable lengthmm codedOhm plastic		
For models:	0723104-03, 0723104A03, 0723104B03, 0723105-03, 0723105A03, 0723105B03, 1023101-00, 1023101-01, 1023106-00, 1023106-01, 1023111-00, 1023111-01, 1223101-00, 1223101-01, 1223101-02, 1223103-00, 1223103-01, 1223103-02, 1223106-00, 1223106-01, 1223106-02, 1223111-00, 1223203-03, 1223211-01, 1323101-00, 1323101-01, 1323101-02, 1323103-00, 1323103-01, 1323103-02, 1323106-00, 1423101-00, 1423101-01, 1423101-02, 1423101A00, 1423101A01, 1423103-00, 1423103-01, 1423103-02, 1423103A00, 1423103A01, 1423104-00, 1423104-01, 1423104-02, 1423104-03, 1423104A00, 1423104A01, 1423104A03... (Other models you can see in the webshop)		

1			
Part No.	Ref. No.	203733	
description	potentiometer with momentary function		
For models:	CCE60, CCE63, CGE11-L, CGE11-R, CGE12-L, CGE12-R, CGE21-L, CGE21-R, CGE22-L, CGE22-R, CGE61-L, CGE61-R, CGE62-L, CGE62-R, CGG11-L, CGG11-R, CGG12-L, CGG12-R, CGG21-L, CGG21-R, CGG22-L, CGG22-R, CGG61-L, CGG61-R, CGG62-L, CGG62-R, CPE60, CPE63, CSE11-L, CSE11-R, CSE12-L, CSE12-R, CSE21-L, CSE21-R, CSE22-L, CSE22-R, CSE61-L, CSE61-R, CSE62-L, CSE62-R, CSG11-L, CSG11-R, CSG12-L, CSG12-R, CSG61-L, CSG61-R, CSG62-L, CSG62-R		



lamps

indicator lights

indicator lights 2-piece (lens and indicator lamp)

indicator light lenses

ø10mm (type SRZ-4)

			
1			
Part No.	359121	Ref. No.	203107
description	indicator light housings mounting measurements ø10mm yellow arrow Qty 1 pcs		

indicator lamps for socket type SRZ / SDK / SDY / SFK



			
1			
Part No.	359132	Ref. No.	203107
description	indicator lamp green 250V connection male faston 6.3mm protection IP54 ambient temperature max. 85°C		

indicator lights 3-piece (housing, lens and bulb)

lamps

neon light bulbs

			
1			
Part No.	359606	Ref. No.	203120
description	neon light bulb socket Ba9s 220V 2W clear ø 10mm L 28mm		
For models:	1424824-00, 1462802B00, 1462804B00, 2061401-05, 2061401A05, 2061401B05, 2061401C05, 2061402-05, 2061402A05, 2061402B05, 2061402C05, 2061403-00, 2061403-01, 2061403-02, 2061403-03, 20614033-0, 2061403A00, 2061403A02, 2061403A03, 2061403B00, 2061403B02, 2061403B03, 2061403C00, 2061403C02, 2061403C03, 2061404-00, 2061404-01, 2061404-02, 2061404-03, 20614044-0, 2061404A00, 2061404A02, 2061404A03, 2061404B00, 2061404B02, 2061404B03, 2061404C00, 2061404C02, 2061404C03, 2061405-00, 2061405-01, 2061405-02, 2061405B00, 2061405B01, 2061405B02, 2061406-00, 2061406-01, 2061406-02, 2061406B00, 2061406B01... (Other models you can see in the webshop)		

accessories for	359606		
	Part No.	359832	Ref. No.
			—
	lamp socket mounting measurements ø16.2mm socket Ba9s connection male faston 6.3mm		
	Part No.	359853	Ref. No.
			—
	lamp socket mounting measurements ø18.2mm socket Ba9s connection male faston 6.3mm		

			
1			
Part No.	359603	Ref. No.	203106 359106
description	neon light bulb socket E14 380V clear ø 14mm L 30mm		
For models:	0522101-00		

indicator lights (complete)

ø10mm

with plug-in socket

			
1			
Part No.	359864	Ref. No.	203107
description	indicator light ø 10mm 230V red		

ø16mm

with plug-in socket

			
1			
Part No.	359094	Ref. No.	203711
description	indicator light ø 16mm 400V yellow cable length 200mm cable material silicone wire		
For models:	00217022-0, 0520302-00, 0520901-00, 0521701-00, 0521701-01, 0521702-00, 0521702-01, 0521702-02, 0521702-03, 0521702-04, 0521702A02, 0521702A03, 0521702A04, 0521702B03, 0521702B04, 0521702C04		

			
1			
Part No.	359093	Ref. No.	203429
description	indicator light ø 16mm 400V white cable length 200mm cable material silicone wire		
For models:	0120101-00, 0120101-01, 0120101-02, 0120101-03, 0120101-04, 0120101C00, 0120101D00, 0120101D01, 0120101D02, 0120101D04, 0120105-00, 0120105-01, 0120105-02, 0120105-03, 0120105-04, 0120105C00, 0120105D00, 0120105D01, 0120105D02, 0120105D04, 0520302-00, 0520302-01, 0520302-02, 0520302A00, 0520302A01		

ø22mm

			
1			
Part No.	357020	Ref. No.	203103
description	indicator light ø 22mm white 230-440V connection screw temp.-resist. 125°C LED		
For models:	0021130A00, 0021130A01, 0021135A00, 0120201-00, 0120201-01, 0120202-00, 0120202-01, 0120203-00, 0120203-01, 0220301-00, 0220301B00, 0220301B01, 0220301B02, 0220301D00, 0220302-00, 0220302A00, 0220302A01, 0220302A02, 0220302A03, 0220302B00, 0220302B01, 0220302B02, 0220302C00, 0220302C01, 0220302C02, 0220302C03, 0220302D00, 0220302E00, 0220302E01, 0220302F00, 0220302H00, 0220302H01, 0220303-00, 0220303-01, 0220303A00, 0220303A01, 0220303A02, 0220303A03, 0220303B00, 0220303B01, 0220303C00, 0220303C01, 0220303C02, 0220303D00, 0220303D01, 0220303E00, 0220303E01, 0220303H00, 0220303H01, 0220304-00... (Other models you can see in the webshop)		



			
1			
Part No.	357263	Ref. No.	203893
description	indicator light ø 22mm white 24V connection male faston 2.8mm plastic		
For models:	0723104-03, 0723104A03, 0723104B03, 0723105-03, 0723105A03, 0723105B03, 1023101-00, 1023101-01, 1023106-00, 1023106-01, 1023111-00, 1023111-01, 1223101-00, 1223101-01, 1223101-02, 1223103-00, 1223103-01, 1223103-02, 1223106-00, 1223106-01, 1223106-02, 1223111-00, 1223203-03, 1223211-01, 1323101-00, 1323101-01, 1323101-02, 1323103-00, 1323103-01, 1323103-02, 1323106-00, 1323203-02, 1323211-02, 1423101-00, 1423101-01, 1423101-02, 1423101A00, 1423101A01, 1423103-00, 1423103-01, 1423103-02, 1423103A00, 1423103A01, 1423104-00, 1423104-01, 1423104-02, 1423104-03, 1423104A00, 1423104A01, 1423104A03... (Other models you can see in the webshop)		

			
1			
Part No.	357021	Ref. No.	203101
description	indicator light ø 22mm yellow 230-440V connection screw temp.-resist. 125°C LED		
For models:	0220302F00, 0520303-00, 0520303-01, 0520303-02, 1220303I00, 1220303I01, 1220303I02, 14228011-0, 14228022-0, 1422802B04, 1422802B05, 1422802B06, 1422802B07, 1422802B08, 14228033-0, 14228044-0, 1422804B04, 1422804B05, 1422804B06, 1422804B07, 1422804B08, 14228055-0, 1422805B04, 1422805B05, 1422805B06, 1422805B07, 1422805B08, 1422807B00, 1422807B01, 1422807B02, 1422807B03, 1422807B04, 1422831-00, 1422832-00, 1422833-00, 1422834-00, 1422902-00, 1422902-01, 1422902-02, 1422902-03, 1422902-04, 1422908-00, 1422910-00, 2012813-00, 2012907-00, 2012907-01, 2022801-00, 2022801-01, 2022801-02, 2022801-03... (Other models you can see in the webshop)		

screw-on/push-on fit

neon light bulbs

			
1			
Part No.	359606	Ref. No.	203120
description	neon light bulb socket Ba9s 220V 2W clear ø 10mm L 28mm		
For models:	1424824-00, 1462802B00, 1462804B00, 2061401-05, 2061401A05, 2061401B05, 2061401C05, 2061402-05, 2061402A05, 2061402B05, 2061402C05, 2061403-00, 2061403-01, 2061403-02, 2061403-03, 20614033-0, 2061403A00, 2061403A02, 2061403A03, 2061403B00, 2061403B02, 2061403B03, 2061403C00, 2061403C02, 2061403C03, 2061404-00, 2061404-01, 2061404-02, 2061404-03, 20614044-0, 2061404A00, 2061404A02, 2061404A03, 2061404B00, 2061404B02, 2061404B03, 2061404C00, 2061404C02, 2061404C03, 2061405-00, 2061405-01, 2061405-02, 2061405B00, 2061405B01, 2061405B02, 2061406-00, 2061406-01, 2061406-02, 2061406B00, 2061406B01... (Other models you can see in the webshop)		
accessories for	359606		
	Part No.	359832	Ref. No. —
	lamp socket mounting measurements ø16.2mm socket Ba9s connection male faston 6.3mm		
	Part No.	359853	Ref. No. —
	lamp socket mounting measurements ø18.2mm socket Ba9s connection male faston 6.3mm		

			
1			
Part No.	359603	Ref. No.	203106 359106
description	neon light bulb socket E14 380V clear ø 14mm L 30mm		
For models:	0522101-00		

halogen lamp

for socket G4 / G6.35 / G9

			
1			
Part No.	357191	Ref. No.	202620
description	halogen lamp socket G4 12V 10W temp.-resist. 300°C OSRAM HALOSTAR OVEN		
For models:	CCE60, CCE63, CGE11-L, CGE11-R, CGE12-L, CGE12-R, CGE21-L, CGE21-R, CGE22-L, CGE22-R, CGE61-L, CGE61-R, CGE62-L, CGE62-R, CGG11-L, CGG11-R, CGG12-L, CGG12-R, CGG21-L, CGG21-R, CGG22-L, CGG22-R, CGG61-L, CGG61-R, CGG62-L, CGG62-R, CPE60, CPE63, CSE11-L, CSE11-R, CSE11-R-DG, CSE12-L, CSE12-R, CSE12-R-DG, CSE21-L, CSE21-R, CSE21-R-DG, CSE22-L, CSE22-R, CSE22-R-DG, CSE61-L, CSE61-R, CSE61-R-DG, CSE62-L, CSE62-R, CSE62-R-DG, CSG11-L, CSG11-R, CSG11-R-DG, CSG12-L... (Other models you can see in the webshop)		

			
1			
Part No.	359599	Ref. No.	203679
description	halogen lamp socket G4 12V 20W temp.-resist. 500°C		
For models:	CCE60, CCE63, CGE11-L, CGE11-R, CGE12-L, CGE12-R, CGE21-L, CGE21-R, CGE22-L, CGE22-R, CGE61-L, CGE61-R, CGE62-L, CGE62-R, CGG11-L, CGG11-R, CGG12-L, CGG12-R, CGG21-L, CGG21-R, CGG22-L, CGG22-R, CGG61-L, CGG61-R, CGG62-L, CGG62-R, CPE60, CPE63, CSE11-L, CSE11-R, CSE11-R-DG, CSE12-L, CSE12-R, CSE12-R-DG, CSE21-L, CSE21-R, CSE21-R-DG, CSE22-L, CSE22-R, CSE22-R-DG, CSE61-L, CSE61-R, CSE61-R-DG, CSE62-L, CSE62-R, CSE62-R-DG, CSG11-L, CSG11-R, CSG11-R-DG, CSG12-L... (Other models you can see in the webshop)		



oven lamps

producer-specific oven lamps

MKN



1

Part No.	693050	Ref. No.	211128
description	gasket graphite D1 ø 71mm D2 ø 94mm thickness 1mm suitable for MKN Qty 1 pcs		
For models:	CGE11-L, CGE11-R, CGE12-L, CGE12-R, CGE21-L, CGE21-R, CGE22-L, CGE22-R, CGE61-L, CGE61-R, CGE62-L, CGE62-R, CGG11-L, CGG11-R, CGG12-L, CGG12-R, CGG21-L, CGG21-R, CGG22-L, CGG22-R, CGG61-L, CGG61-R, CGG62-L, CGG62-R, CSE11-L, CSE11-R, CSE11-R-DG, CSE12-L, CSE12-R, CSE12-R-DG, CSE21-L, CSE21-R, CSE21-R-DG, CSE22-L, CSE22-R, CSE22-R-DG, CSE61-L, CSE61-R, CSE61-R-DG, CSE62-L, CSE62-R, CSE62-R-DG, CSG11-L, CSG11-R, CSG11-R-DG, CSG12-L, CSG12-R, CSG12-R-DG, CSG21-L, CSG21-R...(Other models you can see in the webshop)		
accessories for	693050		
	Part No.	694294	Ref. No.
			216115
	glass panel ø 90mm thickness 8mm		



1

Part No.	699482	Ref. No.	211146
description	gasket suitable for MKN combi-steamer mounting pos. for lens ED ø 105mm ID ø 71mm graphite thickness 1mm		
For models:	CGE21-L, CGE21-R, CGE22-L, CGE22-R, CGG21-L, CGG21-R, CGG22-L, CGG22-R, CSE11-L, CSE11-R, CSE11-R-DG, CSE12-L, CSE12-R, CSE12-R-DG, CSE21-L, CSE21-R, CSE21-R-DG, CSE22-L, CSE22-R, CSE22-R-DG, CSE61-L, CSE61-R, CSE61-R-DG, CSE62-L, CSE62-R, CSE62-R-DG, CSG11-L, CSG11-R, CSG11-R-DG, CSG12-L, CSG12-R, CSG12-R-DG, CSG21-L, CSG21-R, CSG21-R-DG, CSG22-L, CSG22-R, CSG22-R-DG, CSG61-L, CSG61-R, CSG61-R-DG, CSG62-L, CSG62-R, CSG62-R-DG		
accessories for	699482		
	Part No.	694294	Ref. No.
			216115
	glass panel ø 90mm thickness 8mm		



1

Part No.	694294	Ref. No.	216115
description	glass panel ø 90mm thickness 8mm		
For models:	CGE11-L, CGE11-R, CGE12-L, CGE12-R, CGE21-L, CGE21-R, CGE22-L, CGE22-R, CGE61-L, CGE61-R, CGE62-L, CGE62-R, CGG11-L, CGG11-R, CGG12-L, CGG12-R, CGG21-L, CGG21-R, CGG22-L, CGG22-R, CGG61-L, CGG61-R, CGG62-L, CGG62-R, CSE11-L, CSE11-R, CSE11-R-DG, CSE12-L, CSE12-R, CSE12-R-DG, CSE21-L, CSE21-R, CSE21-R-DG, CSE22-L, CSE22-R, CSE22-R-DG, CSE61-L, CSE61-R, CSE61-R-DG, CSE62-L, CSE62-R, CSE62-R-DG, CSG11-L, CSG11-R, CSG11-R-DG, CSG12-L, CSG12-R, CSG12-R-DG, CSG21-L, CSG21-R...(Other models you can see in the webshop)		
accessories for	694294		
	Part No.	693050	Ref. No.
			211128
	gasket graphite D1 ø 71mm D2 ø 94mm thickness 1mm suitable for MKN Qty 1 pcs		

accessories for	694294		
	Part No.	699482	Ref. No.
			211146
	gasket suitable for MKN combi-steamer mounting pos. for lens ED ø 105mm ID ø 71mm graphite thickness 1mm		



1

Part No.	357184	Ref. No.	203678
description	lamp socket socket G4 cable length 130mm connection male faston 6.3mm ø 17mm H 9mm mounting distance 12mm mounting thread M3 Qty 1 pcs		
For models:	CCE60, CCE63, CGE11-L, CGE11-R, CGE12-L, CGE12-R, CGE21-L, CGE21-R, CGE22-L, CGE22-R, CGE61-L, CGE61-R, CGE62-L, CGE62-R, CGG11-L, CGG11-R, CGG12-L, CGG12-R, CGG21-L, CGG21-R, CGG22-L, CGG22-R, CGG61-L, CGG61-R, CGG62-L, CGG62-R, CPE60, CPE63, CSE11-L, CSE11-R, CSE11-R-DG, CSE12-L, CSE12-R, CSE12-R-DG, CSE21-L, CSE21-R, CSE21-R-DG, CSE22-L, CSE22-R, CSE22-R-DG, CSE61-L, CSE61-R, CSE61-R-DG, CSE62-L, CSE62-R, CSE62-R-DG, CSG11-L, CSG11-R, CSG11-R-DG, CSG12-L...(Other models you can see in the webshop)		

lamps

halogen lamps

for socket G4 / G6.35 / G9



1

Part No.	357191	Ref. No.	202620
description	halogen lamp socket G4 12V 10W temp.-resist. 300°C OSRAM HALOSTAR OVEN		
For models:	CCE60, CCE63, CGE11-L, CGE11-R, CGE12-L, CGE12-R, CGE21-L, CGE21-R, CGE22-L, CGE22-R, CGE61-L, CGE61-R, CGE62-L, CGE62-R, CGG11-L, CGG11-R, CGG12-L, CGG12-R, CGG21-L, CGG21-R, CGG22-L, CGG22-R, CGG61-L, CGG61-R, CGG62-L, CGG62-R, CPE60, CPE63, CSE11-L, CSE11-R, CSE11-R-DG, CSE12-L, CSE12-R, CSE12-R-DG, CSE21-L, CSE21-R, CSE21-R-DG, CSE22-L, CSE22-R, CSE22-R-DG, CSE61-L, CSE61-R, CSE61-R-DG, CSE62-L, CSE62-R, CSE62-R-DG, CSG11-L, CSG11-R, CSG11-R-DG, CSG12-L...(Other models you can see in the webshop)		



1

Part No.	359599	Ref. No.	203679
description	halogen lamp socket G4 12V 20W temp.-resist. 500°C		
For models:	CCE60, CCE63, CGE11-L, CGE11-R, CGE12-L, CGE12-R, CGE21-L, CGE21-R, CGE22-L, CGE22-R, CGE61-L, CGE61-R, CGE62-L, CGE62-R, CGG11-L, CGG11-R, CGG12-L, CGG12-R, CGG21-L, CGG21-R, CGG22-L, CGG22-R, CGG61-L, CGG61-R, CGG62-L, CGG62-R, CPE60, CPE63, CSE11-L, CSE11-R, CSE11-R-DG, CSE12-L, CSE12-R, CSE12-R-DG, CSE21-L, CSE21-R, CSE21-R-DG, CSE22-L, CSE22-R, CSE22-R-DG, CSE61-L, CSE61-R, CSE61-R-DG, CSE62-L, CSE62-R, CSE62-R-DG, CSG11-L, CSG11-R, CSG11-R-DG, CSG12-L...(Other models you can see in the webshop)		



timers

digital timers



1

Part No.	381461	Ref. No.	203383
description	digital switch clock STÖRK-TRONIK ST64-31.07HF time range 0-999h 230 16A 1NO mounting measurements 60mm display 3 digits built-in depth 62mm		
For models:	2021115-00, 2021115-01, 2021115-02, 2021115-03, 2021115-04, 2221115-00, 2221115-01		



1

Part No.	360347	Ref. No.	203237 845436
description	timer electronic 15min		
For models:	0220302A03, 0220302C03, 0220302H01, 0220303A03, 0220303C02, 0220303H01		



1

Part No.	360348	Ref. No.	203324
description	timer electronic 15min		
For models:	0220302A03, 0220302C03, 0220302H01, 0220303A03, 0220303C02, 0220303H01, 1220303A00, 1220303A01, 1220303A02, 1220303A03, 1220303C00, 1220303C01, 1220303C02, 1220303C03, 1220303F01, 1220303F02, 1220303F03, 1220303H00, 1220303H01, 1220303H02, 1220303H03, 1220305A00, 1220305A01, 1220305A02, 1220305A03, 1220305A04, 1220305A05, 1220305C00, 1220305C01, 1220305C02, 1220305C03, 1220305C04, 1220305C05, 1220305F01, 1220305F02, 1220305F03, 1220305F04, 1220305F05, 1220305H00, 1220305H01, 1220305H02, 1220305H03, 1220305H04, 1220305H05, 1320303A00, 1320303A01, 1320303A02, 1320303C00, 1320303C01, 1320303C02... (Other models you can see in the webshop)		

alarm devices

buzzers



1

Part No.	350050	Ref. No.	203325
description	buzzer 230VAC connection male faston 6.3mm screw mounting thread M4 60dB		
For models:	0220302A00, 0220302A01, 0220302C00, 0220302C01, 0220303A00, 0220303A01, 0220303C00, 0220304-00, 0220305-00, 0220306-00, 0720332P00, 0720332R00, 0720332T00, 0720332V00, 1420332P01, 1420332P02, 1420332P03, 1420332R00, 1420332R01, 1420332R02, 1420332R03, 1420332T01, 1420332T02, 1420332T03, 1420332V01, 1420332V02, 1420332V03, 1420333P01, 1420333P02, 1420333R00, 1420333R01, 1420333R02, 1420333T01, 1420333T02, 1420333V01, 1420333V02, 1420334P00, 1420334P01, 1420334P02, 1420334P03, 1420334P04, 1420334R02, 1420334R03, 1420334R04, 1420334T02, 1420334T03, 1420334T04, 1420334V01, 1420334V02, 1420334V03... (Other models you can see in the webshop)		



1

Part No.	350221	Ref. No.	202775
description	buzzer 5-28VDC connection F6.3 mounting ø 40mm		
For models:	CSE61-L, CSE61-R, CSE61-R-DG, CSE62-L, CSE62-R, CSE62-R-DG		

contactors

MOELLER/EATON

power contactors



1

Part No.	380492	Ref. No.	203203
description	contactor resistive load 35A 230VAC main contacts 3NO		
For models:	0220302H00, 0220302H01, 0220303B01, 0220303C01, 0220303C02, 0220303E01, 0220303H00, 0220303H01, 0723105-03, 0723105A03, 0723105B03, 1220305B02, 1220305B03, 1220305B04, 1220305C00, 1220305C01, 1220305C02, 1220305C03, 1220305C04, 1220305E00, 1220305E01, 1220305E02, 1220305E03, 1220305E04, 1220305E05, 1220305H01, 1220305H02, 1220305H03, 1220305H04, 1220305H05, 1220305K00, 1220330B00, 1220330B01, 1320305B02, 1320305B03, 1320305C00, 1320305C01, 1320305C02, 1320305C03, 1320305E00, 1320305E01, 1320305E02, 1320305E03, 1320305E04, 1320305E05, 1320305H00, 1320305H01, 1320305H02, 1320305H03... (Other models you can see in the webshop)		

1

Part No.	380493	Ref. No.	203206
description	contactor resistive load 55A 230VAC main contacts 3NO		
For models:	0220303B00, 0220303B01, 0220303C00, 0220303C01, 0220303C02, 0220303E00, 0220303E01, 0220306-00, 14228044-0, 14228055-0, 2020314-01, 2020314A01, 2020315-01, 2020315A01, 2022804-00, 2022804-01, 20228044-0, 20228044-1, 2022804A00, 2022804A01, 2022804B00, 2022804B01, 2022804C00, 2022804C01, 2022805-00, 2022805-01, 20228055-0, 20228055-1, 2022805A00, 2022805A01, 2022805B00, 2022805B01, 2022805C00, 2022805C01, 2022807-00, 20228077-0, 20228077-1, 2022807A00, 2022807B00, 2022807B01, 2022807B02, 2022807C00, 2022807C01, 2022807C02, 2023007-00, 20230077-0, 20230077-1, 2023007A00, 2023007B00, 2023007C00... (Other models you can see in the webshop)		



1

Part No.	380167	Ref. No.	203209
description	power contactor resistive load 66A 230VAC (AC3/400V) 50A/22kW main contacts 3NO auxiliary contacts 1NO connection screw connection type DILM 50		
For models:	2022901-00, 20229011-0, 20229011-1, 2022901A00, 2022901B00, 2022901B01, 2022901B02, 2022901C00, 2022901C01, 2022901C02, 2023009-00, 20230099-0, 20230099-1, 2023009A00, 2023009B00, 2023009C00, 2023010-00, 20230100-0, 20230100-1, 2023010A00, 2023010B00, 2023010C00, 2022901B01, 3022901C00, 3022901C01, 3023009-00, 3023009A00, 3023009B00, 3023009C00, 3023010-00, 3023010A00, 3023010B00, 3023010C00		



1

Part No.	380497	Ref. No.	203026
description	power contactor resistive load 20A 230VAC (AC3/400V) 9A/4kW main contacts 4NO auxiliary contacts connection screw connection type DILEM 4		
For models:	0120101-01, 0120101-02, 0120101-03, 0120101-04, 0120101D00, 0120101D01, 0120101D02, 0120101D04, 0120105-01, 0120105-02, 0120105-03, 0120105-04, 0120105D00, 0120105D01, 0120105D02, 0120105D04, 0220301B02, 0220302B02, 0220302C02, 0220302C03, 0220302E01, 0220303-01, 0220303A02, 0220303A03, 0220303D01, 0520302-01, 0520302-02, 0520302A00, 0520302A01, 0520303-01, 0520303-02, 1220301-00, 1220301-01, 1220301-02, 1220301-03, 1220301-04, 1220301B00, 1220301B01, 1220301B02, 1220301B03, 1220301B04, 1220301D00, 1220301D01, 1220301E00, 1220301E01, 1220301J00, 1220301J01, 1220301J02, 1220301J03, 1220303-00... (Other models you can see in the webshop)		

auxiliary contacts



1

Part No.	381113	Ref. No.	203213
description	auxiliary contact contacts 2NO AC15 4A for contactors DILM(C)7-32 connection screw type DILA-XHI20		
For models:	1422804B04, 1422804B05, 1422804B06, 1422804B07, 1422804B08, 1422805B04, 1422805B05, 1422805B06, 1422805B07, 1422805B08, 1422807B00, 1422807B01, 1422807B02, 1422807B03, 1422807B04, 1422902-00, 1422902-01, 1422902-02, 1422902-03, 1422902-04, 2022804B04, 2022804B05, 2022804B06, 2022804B07, 2022804B08, 2022804B09, 2022804B10, 2022804C07, 2022804C08, 2022804C09, 2022804C10, 2022804D00, 2022804D01, 2022804D02, 2022805B04, 2022805B05, 2022805B06, 2022805B07, 2022805B08, 2022805B09, 2022805B10, 2022805C07, 2022805C08, 2022805C09, 2022805C10, 2022805D00, 2022805D01, 2022807B03, 2022807B04, 2022807B05... (Other models you can see in the webshop)		



1

Part No.	381197	Ref. No.	203432
description	power contactor resistive load 20A 400VAC (AC3/400V) 9A/4kW main contacts 4NO auxiliary contacts connection screw connection type DILEM 4		
For models:	0721172A01, 0721173A01, 0721174A01, 0721175A01, 0723105-03, 0723105A03, 0723105B03, 1221156A00, 1421143B01, 1421144B01, 1421145B01, 1421149B00, 1421149B01, 1421150B00, 1421150B01, 1421151B00, 1421151B01, 1421155B02, 1421156B02, 1421157B02, 1421158A00, 1421158B00, 1421158B01, 1421158B02, 1421159A00, 1421159B00, 1421159B01, 1421159B02, 1421160A00, 1421160B00, 1421160B01, 1421160B02, 1421164B01, 1421165B01, 1421166B01, 1421167B02, 1421168B02, 1421169B02, 1421176B00, 1421177B00, 1421178B00, 1422513B00, 1422513B01, 1422515B01, 1422515B02, 1423103-02, 1423103A01, 1423105-02, 1423105-03, 1423105A01... (Other models you can see in the webshop)		

TELEMECANIQUE (Schneider Electric)

power contactors





1

Part No.	381484	Ref. No.	203986
description	power contactor resistive load 125A 230 (AC3/400V) 37kW main contacts 3NO auxiliary contacts 1NO/1NC connection screw type LC1D80116		
For models:	CGE11-L, CGE11-R, CGE22-L, CGE22-R, CGE61-L, CGE61-R, CSE11-L, CSE11-R, CSE22-L, CSE22-R, CSE22-R-DG, CSE61-L, CSE61-R		



			
1			
Part No.	381486	Ref. No.	203971
description	power contactor resistive load 20A (AC3/400V) 4kW main contacts 2x3NO auxiliary contacts 2x1NO connection screw type LC2K0910P7		
For models:	CGE11-L, CGE11-R, CGE21-L, CGE21-R, CGE61-L, CGE61-R, CPE63, CSE11-L, CSE11-R, CSE11-R-DG, CSE12-L, CSE12-R, CSE12-R-DG, CSE21-L, CSE21-R, CSE21-R-DG, CSE22-L, CSE22-R, CSE22-R-DG, CSE61-L, CSE61-R, CSE61-R-DG, CSE62-L, CSE62-R, CSE62-R-DG		

			
1			
Part No.	380965	Ref. No.	203744
description	power contactor resistive load 20A 230VAC (AC3/400V) 6A/2.2kW main contacts 3NO auxiliary contacts 1NO connection screw connection type LC1K0610P7+		
For models:	0720325-03, 0720325-04, 0720325B03, 0720325B04, 0721134-01, 0721134A01, 1022603-00, 1220327-00, 1220327-01, 1220327B01, 1220329-00, 1220329-01, 1220402-00, 1220402-01, 1221103-04, 1221103B04, 1221130J00, 1221135A04, 1221135J00, 1221136A04, 1221141-00, 1221141A00, 1222507-00, 1222509-00, 1222603-00, 1320323-00, 1320323B00, 1320327-00, 1320327A00, 1320327A01, 1320327A02, 1320327B00, 1320327C00, 1320327C01, 1320327C02, 1320329-00, 1320329-01, 1320329A00, 1320329A01, 1320329A02, 1320335C00, 1320402-00, 1320402-01, 1321130-00, 1321130A00, 1321131-00, 1321131A00, 1321135A03, 1321136A03, 1321141-00... (Other models you can see in the webshop)		

			
1			
Part No.	380479	Ref. No.	203676
description	power contactor resistive load 25A 230VAC (AC3/400V) 9A/4kW main contacts 3NO auxiliary contacts 1NO/1NC connection screw connection type LC1D09P7		
For models:	CGE11-L, CGE11-R, CGE21-L, CGE21-R, CGE61-L, CGE61-R, CSE11-L, CSE11-R, CSE21-L, CSE21-R, CSE61-L, CSE61-R		

			
1			
Part No.	380976	Ref. No.	203675
description	power contactor resistive load 32A 230VAC (AC3/400V) 18A/7.5kW main contacts 3NO auxiliary contacts 1NO/1NC connection screw connection		
For models:	0720332P00, 0720332R00, 0720332T00, 0720332V00, 1220305B05, 1220305B06, 1220305B07, 1220305K01, 1220305K02, 1220305K03, 1220329B00, 1220329B01, 1320329B00, 1320329B01, 1320329C00, 1320329C01, 1320329C02, 1420329B00, 1420329B01, 1420329C00, 1420329C01, 1420332P01, 1420332P02, 1420332P03, 1420332R00, 1420332R01, 1420332R02, 1420332R03, 1420332T01, 1420332T02, 1420332T03, 1420332V01, 1420332V02, 1420332V03, 1420333P01, 1420333P02, 1420333R00, 1420333R01, 1420333R02, 1420333T01, 1420333T02, 1420333V01, 1420333V02, 1420334P00, 1420334P01, 1420334P02, 1420334P03, 1420334P04, 1420334R02, 1420334R03... (Other models you can see in the webshop)		

			
1			
Part No.	380980	Ref. No.	203985
description	power contactor resistive load 50A 230VAC (AC3/400V) 32A/15kW main contacts 3NO auxiliary contacts 1NO/1NC connection screw connection type LC1D32P7		
For models:	1420334T02, 1420334T03, 1420334T04, 1420334V01, 1420334V02, 1420334V03, 1420334V04, 1420334W02, 1420334W03, 1420334W04, 1420334Y02, 1420334Y03, 1420334Y04, 1520334T03, 1520334T04, 1520334T05, 1520334V02, 1520334V03, 1520334V04, 1520334V05, 1520334W03, 1520334W04, 1520334W05, 1520334Y03, 1520334Y04, 1520334Y05, 2020334T00, 2020334T01, 2020334V00, 2020334V01, 2020346V00, 2020349V00, 2020349V01, 2020349V02, 2020349V03, 2022909-02, 2220334T00, 2220334T01, 2220334T02, 2220334T03, 2220334T04, 2220334V01, 2220334V02, 2220334V03, 2220334V04, 2420334T00, 2420334T01, 2420334T02, 2420334T03, 2420334V00... (Other models you can see in the webshop)		



TRIPUS (Eichhoff)

small relay switches

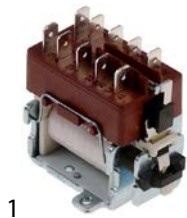

Part No.	380121	Ref. No.	203219
description	small relay switch 230V main contacts 3NO/1NC auxiliary contacts knob ø70mm (227-piece) connection Faston 6.3mm type E3250 resistive load 16A		
For models:	0221501-00, 0221502-00, 1421501-00, 1421502-00, 1421503-00, 1421504-00, 2121501-00, 2121502-00		

miscellaneous

accessories



Part No.	550875	Ref. No.	203225
description	jumper for auxiliary contact		
For models:	0120101-01, 0120101-02, 0120101-03, 0120101-04, 0120101D00, 0120101D01, 0120101D02, 0120101D04, 0120105-01, 0120105-02, 0120105-03, 0120105-04, 0120105D00, 0120105D01, 0120105D02, 0120105D04, 0520302-01, 0520302-02, 0520302A00, 0520302A01, 1320401-01, 1420401-01, 1422804B04, 1422804B05, 1422804B06, 1422804B07, 1422804B08, 1422805B04, 1422805B05, 1422805B06, 1422805B07, 1422805B08, 1422807B00, 1422807B01, 1422807B02, 1422807B03, 1422807B04, 1422902-00, 1422902-01, 1422902-02, 1422902-03, 1422902-04, 2020401-01, 2021115-00, 2021115-01, 2021115-02, 2021115-03, 2021115-04, 2022804B04, 2022804B05... (Other models you can see in the webshop)		

power contactors



Part No.	380165	Ref. No.	203423
description	power contactor		
For models:	1422701-00, 1422702-00, 1422802B04, 1422802B05, 1422802B06, 1422802B07, 1422802B08, 1422804B04, 1422804B05, 1422804B06, 1422804B07, 1422804B08, 1422805B04, 1422805B05, 1422805B06, 1422805B07, 1422805B08, 1422807B00, 1422807B01, 1422807B02, 1422807B03, 1422807B04, 1422831-00, 1422832-00, 1422833-00, 1422834-00, 1422902-00, 1422902-01, 1422902-02, 1422902-03, 1422902-04, 1422908-00, 1422910-00, 1423901-00, 1423901-01, 1423901-02, 1423902-00, 1423902-01, 1423902-02, 1423903-00, 1423903-01, 1423903-02, 2020308-00, 2021123A00, 2021411-00, 2021412C00, 2021413-00, 2021413B00, 2021414C00, 2021417-00... (Other models you can see in the webshop)		

solid state relays

CROUZET



Part No.	403534	Ref. No.	203668
description	solid state relay CROUZET 1 phase 100A 48-660V 4-32VDC L 58mm W 49mm new edition screw type 84137140		
For models:	CCE60, CCE63, CGE11-L, CGE11-R, CGE12-L, CGE12-R, CGE21-L, CGE21-R, CGE22-L, CGE22-R, CGE61-L, CGE61-R, CGE62-L, CGE62-R, CPE60, CPE63, CSE11-L, CSE11-R, CSE11-R-DG, CSE12-L, CSE12-R, CSE12-R-DG, CSE21-L, CSE21-R, CSE21-R-DG, CSE22-L, CSE22-R, CSE22-R-DG, CSE61-L, CSE61-R, CSE61-R-DG, CSE62-L, CSE62-R, CSE62-R-DG		



Part No.	403535	Ref. No.	203669
description	solid state relay CROUZET 1 phase 10A 24-280V 90-280VAC L 58mm W 49mm new edition screw type 84137001		
For models:	CGE11-L, CGE11-R, CGE12-L, CGE12-R, CGE21-L, CGE21-R, CGE22-L, CGE22-R, CGE61-L, CGE61-R, CGE62-L, CGE62-R, CGG11-L, CGG11-R, CGG12-L, CGG12-R, CGG21-L, CGG21-R, CGG22-L, CGG22-R, CGG61-L, CGG61-R, CGG62-L, CGG62-R, CSE11-L, CSE11-R, CSE12-L, CSE12-R, CSE21-L, CSE21-R, CSE22-L, CSE22-R, CSE61-L, CSE61-R, CSE62-L, CSE62-R, CSG11-L, CSG11-R, CSG11-R-DG, CSG12-L, CSG12-R, CSG12-R-DG, CSG21-L, CSG21-R, CSG22-L, CSG22-R, CSG61-L, CSG61-R		

heat-conducting foils



Part No.	401676	Ref. No.	203671
description	heat-conducting foil L 57mm W 45mm		
For models:	CGE11-L, CGE11-R, CGE12-L, CGE12-R, CGE21-L, CGE21-R, CGE22-L, CGE22-R, CGE61-L, CGE61-R, CGE62-L, CGE62-R, CGG11-L, CGG11-R, CGG12-L, CGG12-R, CGG21-L, CGG21-R, CGG22-L, CGG22-R, CGG61-L, CGG61-R, CGG62-L, CGG62-R, CPE63, CSE11-L, CSE11-R, CSE11-R-DG, CSE12-L, CSE12-R, CSE21-L, CSE21-R, CSE22-L, CSE22-R, CSE61-L, CSE61-R, CSE61-R-DG, CSE62-L, CSE62-R, CSG11-L, CSG11-R, CSG12-L, CSG12-R, CSG21-L, CSG21-R, CSG22-L, CSG22-R, CSG61-L, CSG61-R		



relays

flasher relays



1

Part No.	380392	Ref. No.	203308
description	flasher relay 230V		
For models:	0220302A00, 0220302A01, 0220302A02, 0220302A03, 0220302C00, 0220302C01, 0220302C02, 0220302C03, 0220302H00, 0220302H01, 0220303A00, 0220303A01, 0220303A02, 0220303A03, 0220303C00, 0220303C01, 0220303C02, 0220304-00, 0220305-00, 0220306-00, 1220303A00, 1220303A01, 1220303A02, 1220303C00, 1220303C01, 1220303C02, 1220303F01, 1220303F02, 1220303H00, 1220303H01, 1220303H02, 1220305A00, 1220305A01, 1220305A02, 1220305A03, 1220305C00, 1220305C01, 1220305C02, 1220305C03, 1220305F01, 1220305F02, 1220305F03, 1220305H00, 1220305H01, 1220305H02, 1220305H03, 1320303A00, 1320303A01, 1320303A02, 1320303C00... (Other models you can see in the webshop)		

power relays

with special fixing



1

Part No.	380441	Ref. No.	202732
description	power relays SCHRACK 230VAC 16A 2NO connection coded plug manuf. no. 0419 110301 00 2-pole		
For models:	0521702B03, 0521702B04, 0521704-07, 1221134A01		

level relays

GICAR



1

Part No.	400017	Ref. No.	203063
description	level relay 230V voltage AC 50/60Hz 11-pole 50/60A connection plug-in connection round 11-pole type RL30/1E/2C/11		

miscellaneous



1

Part No.	380495	Ref. No.	203419
description	level relay 220-240V type RM4 LA32M		
For models:	1422802B04, 1422802B05, 1422802B06, 1422802B07, 1422802B08, 1422804B04, 1422804B05, 1422804B06, 1422804B07, 1422804B08, 1422805B04, 1422805B05, 1422805B06, 1422805B07, 1422805B08, 1422807B00, 1422807B01, 1422807B02, 1422807B03, 1422807B04, 1422902-00, 1422902-01, 1422902-02, 1422902-03, 1422902-04, 1462802B00, 1462802B01, 1462802B02, 1462802B03, 1462802B04, 1462802B05, 1462804B00, 1462804B01, 1462804B02, 1462804B03, 1462804B04, 1462804B05, 1462831-00, 1462832-00, 1462835-00, 1462836-00, 1462837-00, 1462908-00, 2022802B04, 2022802B05, 2022802B06, 2022802B07, 2022802B08, 2022802B09, 2022802B10... (Other models you can see in the webshop)		



1

Part No.	400068	Ref. No.	203175
description	level relay 230V voltage AC type 75.03000.050		
For models:	2022801-02, 2022801-03, 2022801A02, 2022801A03, 2022801B02, 2022801B03, 2022801C02, 2022801C03, 2022802-02, 2022802-03, 2022802A02, 2022802A03, 2022802B02, 2022802B03, 2022802C02, 2022802C03, 2022803-02, 2022803-03, 2022803A02, 2022803A03, 2022803B02, 2022803B03, 2022803C02, 2022803C03, 2022804-02, 2022804-03, 2022804A02, 2022804A03, 2022804B02, 2022804B03, 2022804C02, 2022804C03, 2022805-02, 2022805-03, 2022805A02, 2022805A03, 2022805B02, 2022805B03, 2022805C02, 2022805C03, 2062801-01, 2062801-02, 2062801-03, 2062801-04, 2062801-05, 2062801-06, 2062801A01, 2062801A02, 2062801A03, 2062801A04... (Other models you can see in the webshop)		



time relays

time relays

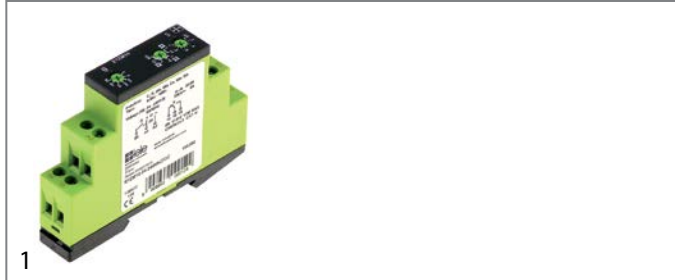

Part No.	381092	Ref. No.	203437
description	time relay 0.05s-100h		
For models:	1462802B01, 1462802B02, 1462802B03, 1462802B04, 1462802B05, 1462804B01, 1462804B02, 1462804B03, 1462804B04, 1462804B05, 2012828-00, 2012828-01, 2012828-02, 2012828-03, 2012828-04, 2012828-05, 2012829-00, 2012829-01, 2012829-02, 2022828-01, 2022828-02, 2022828-03, 2022828-04, 2022828-05, 2022828-06, 2023003B01, 2023003B02, 2023003B03, 2023003B04, 2023003B05, 2023003B06, 2023003B07, 2023004B01, 2023004B02, 2023004B03, 2023004B04, 2023004B05, 2023004B06, 2023004B07, 2023007B01, 2023007B02, 2023007B03, 2023007B04, 2023007B05, 2023007B06, 2023007B07, 2023008B01, 2023008B02, 2023008B03, 2023008B04... (Other models you can see in the webshop)		

miscellaneous

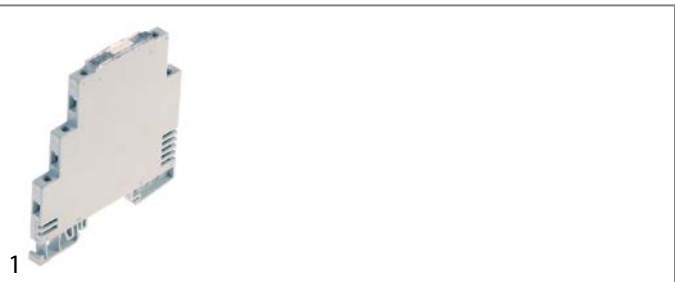

Part No.	381093	Ref. No.	203753
description	power relays 1CO 230V voltage AC/DC 0.0001-6A connection screw clamp DIN rail		
For models:	0720332P00, 0720332R00, 0720332T00, 0720332V00, 1420332P01, 1420332P02, 1420332P03, 1420332R00, 1420332R01, 1420332R02, 1420332R03, 1420332T01, 1420332T02, 1420332T03, 1420332V01, 1420332V02, 1420332V03, 1420333P01, 1420333P02, 1420333R00, 1420333R01, 1420333R02, 1420333T01, 1420333T02, 1420333V01, 1420333V02, 1420334P00, 1420334P01, 1420334P02, 1420334P03, 1420334P04, 1420334R02, 1420334R03, 1420334R04, 1420334T02, 1420334T03, 1420334T04, 1420334V01, 1420334V02, 1420334V03, 1420334V04, 1420334W02, 1420334W03, 1420334W04, 1420334Y02, 1420334Y03, 1420334Y04, 1420344R00, 1420344R01, 1420344R02... (Other models you can see in the webshop)		



Part No.	381465	Ref. No.	203735
description	remote control module 440V capacity 47nF 3x2MOhm DIN rail		
For models:	CCE60, CCE63, CGE11-L, CGE11-R, CGE12-L, CGE12-R, CGE21-L, CGE21-R, CGE22-L, CGE22-R, CGE61-L, CGE61-R, CGE62-L, CGE62-R, CGG11-L, CGG11-R, CGG12-L, CGG12-R, CGG61-L, CGG61-R, CGG62-L, CGG62-R, CPE60, CPE63, CSE11-L, CSE11-R, CSE11-R-DG, CSE12-L, CSE12-R, CSE12-R-DG, CSE21-L, CSE21-R, CSE21-R-DG, CSE22-L, CSE22-R, CSE22-R-DG, CSE61-L, CSE61-R, CSE61-R-DG, CSE62-L, CSE62-R, CSE62-R-DG, CSG11-L, CSG11-R, CSG11-R-DG, CSG12-L, CSG12-R, CSG12-R-DG, CSG21-L, CSG21-R... (Other models you can see in the webshop)		

transformers

open transformers

with clamp terminal



Part No.	403900	Ref. No.	202604
description	control transformer primary 208-600VAC secondary 2x115VAC 460VA secondary 2A H 133mm L 150mm W 112mm 50/60Hz type EI 150N/49/F		
For models:	CSE61-L, CSE61-R, CSE61-R-DG, CSE62-L, CSE62-R, CSE62-R-DG		





Part No.	403875	Ref. No.	10015147
description	transformer 750VA H 143mm L 110mm W 150mm connection grip connection 50-60Hz		





Part No.	403303	Ref. No.	202608 202608+202725
description	transformer primary 110-250VAC secondary 230VAC 100VA connection plug 50/60Hz		
For models:	CGE11-L, CGE11-R, CGE12-L, CGE12-R, CGE21-L, CGE21-R, CGE22-L, CGE22-R, CGE61-L, CGE61-R, CGE62-L, CGE62-R, CGG11-L, CGG11-R, CGG12-L, CGG12-R, CGG21-L, CGG21-R, CGG22-L, CGG22-R, CGG61-L, CGG61-R, CGG62-L, CGG62-R, CSE11-L, CSE11-R, CSE11-R-DG, CSE12-L, CSE12-R, CSE12-R-DG, CSE21-L, CSE21-R, CSE21-R-DG, CSE22-L, CSE22-R, CSE22-R-DG, CSE61-L, CSE61-R, CSE61-R-DG, CSE62-L, CSE62-R, CSE62-R-DG, CSG11-L, CSG11-R, CSG11-R-DG, CSG12-L, CSG12-R, CSG12-R-DG, CSG21-L, CSG21-R... (Other models you can see in the webshop)		



			
1			
Part No.	400791	Ref. No.	203999
description	transformer primary 120/200/220/230V secondary 24V 108VA 50/60Hz		
For models:	CGG11-L, CGG11-R, CGG12-L, CGG12-R, CGG21-L, CGG21-R, CGG22-L, CGG22-R, CGG61-L, CGG61-R, CGG62-L, CGG62-R, CSG11-L, CSG11-R, CSG11-R-DG, CSG12-L, CSG12-R, CSG12-R-DG, CSG21-L, CSG21-R, CSG21-R-DG, CSG22-L, CSG22-R, CSG22-R-DG, CSG61-L, CSG61-R, CSG61-R-DG, CSG62-L, CSG62-R, CSG62-R-DG		

			
1			
Part No.	400792	Ref. No.	203818
description	transformer primary 200/208/220/230/240/250V secondary 4.2/10.7/21V 162VA 50/60Hz		
For models:	815166, CGE11-L, CGE11-R, CGE12-L, CGE12-R, CGE21-L, CGE21-R, CGE22-L, CGE22-R, CGE61-L, CGE61-R, CGE62-L, CGE62-R, CGG11-L, CGG11-R, CGG12-L, CGG12-R, CGG21-L, CGG21-R, CGG22-L, CGG22-R, CGG61-L, CGG61-R, CGG62-L, CGG62-R, CPE63, CSE11-L, CSE11-R, CSE11-R-DG, CSE12-L, CSE12-R, CSE12-R-DG, CSE21-L, CSE21-R, CSE21-R-DG, CSE22-L, CSE22-R, CSE22-R-DG, CSE61-L, CSE61-R, CSE61-R-DG, CSE62-L, CSE62-R, CSE62-R-DG, CSG11-L, CSG11-R, CSG11-R-DG, CSG12-L, CSG12-R, CSG12-R-DG...(Other models you can see in the webshop)		

			
1			
Part No.	403305	Ref. No.	203670
description	transformer primary 200-250VAC secondary 215/230VAC 92VA connection plug 50/60Hz		
For models:	CGE11-L, CGE11-R, CGE12-L, CGE12-R, CGE22-L, CGE22-R, CGE61-L, CGE61-R, CPE63, CSE11-L, CSE11-R, CSE12-L, CSE12-R, CSE22-L, CSE22-R, CSE61-L, CSE61-R		

			
1			
Part No.	403304	Ref. No.	203980 203981
description	transformer primary 440VAC secondary 230VAC 500VA connection screw clamp 50/60Hz		
For models:	CGE11-L, CGE11-R, CGE22-L, CGE22-R, CGE61-L, CGE61-R, CSE11-L, CSE11-R, CSE22-L, CSE22-R, CSE61-L, CSE61-R		

with plug connection

			
1			
Part No.	403845	Ref. No.	10013658
description	transformer primary 110-250VAC secondary 18VAC 100VA H 103mm L 80mm W 100mm connection plug 50/60Hz for combi-steamer		

for lighting

			
1			
Part No.	403306	Ref. No.	203749
description	transformer primary 230VAC secondary 11.5VAC 50VA secondary 4A connection screw L 165mm W 45mm H 37mm 50/60Hz mounting distance 155mm for lighting		
For models:	CGE11-L, CGE11-R, CGE22-L, CGE22-R, CGE61-L, CGE61-R, CPE63, CSE11-L, CSE11-R, CSE22-L, CSE22-R, CSE61-L, CSE61-R		

probes

producer-specific probes

probes

			
1			
Part No.	379997	Ref. No.	203602
description	temperature probe thermocouple J (Fe-CuNi) cable PTFE probe -50 up to +750°C cable -40 up to +250°C connection 2-wire thread M10x1 probe ø6x80/180mm cable length 1.4m		
For models:	1220302-00, 1220302-01, 1220302B00, 1220302B01, 1220302D00, 1220302E00, 1220304-00, 1220304-01, 1220304A00, 1220304A01, 1220304A02, 1220304B00, 1220304B01, 1220304C00, 1220304C01, 1220304C02, 1220304D00, 1220304E00, 1220304F00, 1220304F01, 1220304H00, 1220304H01, 1220306-00, 1220306-01, 1220306A00, 1220306A01, 1220306A02, 1220306A03, 1220306A04, 1220306B00, 1220306B01, 1220306C00, 1220306C01, 1220306C02, 1220306C03, 1220306C04, 1220306D00, 1220306E00, 1220306F00, 1220306F01, 1220306F02, 1220306F03, 1220306H00, 1220306H01, 1220306H02, 1220306H03, 1320302-00, 1320302-01, 1320302B00, 1320302B01... (Other models you can see in the webshop)		





			
Part No.	378120	Ref. No.	203991
description	temperature probe thermocouple K (NiCr-Ni) cable PTFE probe -50 up to 1150°C cable -40 up to +250°C connection 2-wire thread M8x1 probe ø1.5x18mm cable length 1.6m		
For models:	CGE11-L, CGE11-R, CGE12-L, CGE12-R, CGE21-L, CGE21-R, CGE22-L, CGE22-R, CGE61-L, CGE61-R, CGE62-L, CGE62-R, CGG11-L, CGG11-R, CGG12-L, CGG12-R, CGG21-L, CGG21-R, CGG22-L, CGG22-R, CGG61-L, CGG61-R, CGG62-L, CGG62-R, CPE63, CSE11-L, CSE11-R, CSE22-L, CSE22-R, CSE61-L, CSE61-R		

			
Part No.	378121	Ref. No.	203689
description	temperature probe thermocouple K (NiCr-Ni) cable PTFE probe -50 up to 1150°C cable -40 up to +250°C connection 2-wire thread M8x1 probe ø1.5x18mm cable length 3.2m		
For models:	CCE60, CCE63, CGE11-L, CGE11-R, CGE12-L, CGE12-R, CGE21-L, CGE21-R, CGE22-L, CGE22-R, CGE61-L, CGE61-R, CGE62-L, CGE62-R, CGG11-L, CGG11-R, CGG12-L, CGG12-R, CGG21-L, CGG21-R, CGG22-L, CGG22-R, CGG61-L, CGG61-R, CGG62-L, CGG62-R, CPE60, CPE63, CSE11-L, CSE11-R, CSE11-R-DG, CSE12-L, CSE12-R, CSE12-R-DG, CSE21-L, CSE21-R, CSE21-R-DG, CSE22-L, CSE22-R, CSE22-R-DG, CSE61-L, CSE61-R, CSE61-R-DG, CSE62-L, CSE62-R, CSE62-R-DG, CSG11-L, CSG11-R, CSG11-R-DG, CSG12-L... (Other models you can see in the webshop)		

			
Part No.	378658	Ref. No.	10013519
description	temperature probe thermocouple K (NiCr-Ni) cable PTFE probe -50 up to 1150°C cable -40 up to +250°C connection coded plug probe 1.6x45 cable length 1.6m		

			
Part No.	378122	Ref. No.	203693
description	temperature probe thermocouple K (NiCr-Ni) cable silicone probe -50 up to 1150°C cable -50 up to +180°C connection 2-wire thread M10x1 probe ø3.5x13mm cable length 1.5m		
For models:	CCE60, CCE63, CGE11-L, CGE11-R, CGE12-L, CGE12-R, CGE61-L, CGE61-R, CGE62-L, CGE62-R, CGG11-L, CGG11-R, CGG12-L, CGG12-R, CGG61-L, CGG61-R, CGG62-L, CGG62-R, CPE60, CPE63, CSE11-L, CSE11-R, CSE11-R-DG, CSE12-L, CSE12-R, CSE12-R-DG, CSE61-L, CSE61-R, CSE61-R-DG, CSE62-L, CSE62-R, CSE62-R-DG, CSG11-L, CSG11-R, CSG11-R-DG, CSG12-L, CSG12-R, CSG12-R-DG, CSG61-L, CSG61-R, CSG61-R-DG, CSG62-L, CSG62-R, CSG62-R-DG		

			
Part No.	378123	Ref. No.	203990
description	temperature probe thermocouple K (NiCr-Ni) cable silicone probe -50 up to 1150°C cable -50 up to +180°C connection 2-wire thread M10x1 probe ø3.5x13mm cable length 2.3m		
For models:	CGE11-L, CGE11-R, CGE21-L, CGE21-R, CGE22-L, CGE22-R, CGE61-L, CGE61-R, CGG21-L, CGG21-R, CGG22-L, CGG22-R, CSE11-L, CSE11-R, CSE21-L, CSE21-R, CSE21-R-DG, CSE22-L, CSE22-R, CSE22-R-DG, CSE61-L, CSE61-R, CSG21-L, CSG21-R, CSG21-R-DG, CSG22-L, CSG22-R, CSG22-R-DG		

core probes			
			
Part No.	378537	Ref. No.	202738
description	core temperature probe multipoint probe cable PTFE probe -40 up to +250°C cable -40 up to +250°C connection 5-wire probe ø4x100mm thread 1/4" cable length 1.8m handle ø 11mm handle length 75mm		
For models:	CCE60, CCE63, CPE60, CPE63		

			
Part No.	378657	Ref. No.	10013578
description	core temperature probe multipoint probe cable PTFE probe -40 up to +250°C cable -40 up to +250°C connection plug probe ø4x100mm thread 1/4" cable length 0.8m handle ø 11mm handle length 75mm for combi-steamer		

			
Part No.	378650	Ref. No.	10013579
description	core temperature probe multipoint probe cable PTFE probe -40 up to +250°C cable -40 up to +250°C connection plug probe ø4x100mm thread 1/4" cable length 1.2m handle ø 11mm handle length 75mm for combi-steamer		

			
Part No.	378651	Ref. No.	10015666
description	core temperature probe multipoint probe cable PTFE probe -40 up to +250°C cable -40 up to +250°C connection plug probe ø4x100mm thread 1/4" cable length 1.2m handle ø 11mm handle length 75mm for combi-steamer SS-reinforced/strip-wound hose		

			
Part No.	378541	Ref. No.	10013518
description	core temperature probe multipoint probe cable PTFE probe -40 up to +250°C cable -40 up to +250°C connection plug probe ø4x100mm thread cable length 1.1m handle ø 11mm handle length 75mm		



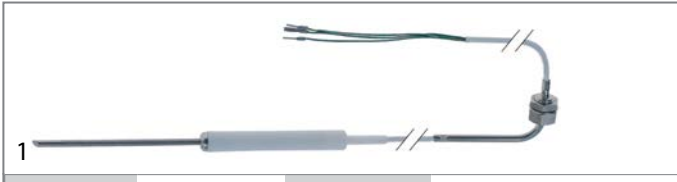

Part No.	378538	Ref. No.	10013516
description	core temperature probe Pt100 cable PTFE probe -40 up to +250°C cable -40 up to +250°C connection plug probe ø4x100mm thread 1/4" cable length 1.8m handle ø 11mm handle length 75mm		

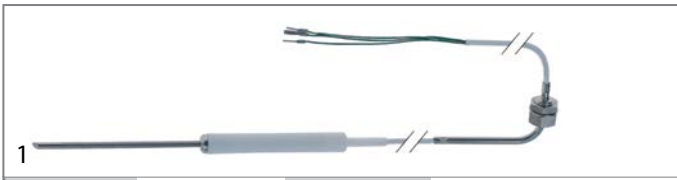

Part No.	378124 ¹	Ref. No.	203697
description	core temperature probe thermocouple K (NiCr-Ni) cable PTFE probe -40 up to +250°C cable -40 up to +250°C connection 5-wire probe ø4x100mm thread 1/4" cable length 1.5m handle ø 12mm handle length 90mm		
For models:	CCE60, CCE63, CGE11-L, CGE11-R, CGE12-L, CGE12-R, CGE61-L, CGE61-R, CGE62-L, CGE62-R, CGG11-L, CGG11-R, CGG12-L, CGG12-R, CGG61-L, CGG61-R, CGG62-L, CGG62-R, CPE60, CPE63, CSE11-L, CSE11-R, CSE11-R-DG, CSE12-L, CSE12-R, CSE12-R-DG, CSE61-L, CSE61-R, CSE61-R-DG, CSE62-L, CSE62-R, CSE62-R-DG, CSG11-L, CSG11-R, CSG11-R-DG, CSG12-L, CSG12-R, CSG12-R-DG, CSG61-L, CSG61-R, CSG61-R-DG, CSG62-L, CSG62-R, CSG62-R-DG		

¹multipoint probe



Part No.	378125 ¹	Ref. No.	203688
description	core temperature probe thermocouple K (NiCr-Ni) cable PTFE probe -40 up to +250°C cable -40 up to +250°C connection 5-wire probe ø4x100mm thread 1/4" cable length 1.9m handle ø 12mm handle length 90mm		
For models:	CCE60, CCE63, CGE21-L, CGE21-R, CGE22-L, CGE22-R, CGG21-L, CGG21-R, CGG22-L, CGG22-R, CPE60, CPE63, CSE21-L, CSE21-R, CSE21-R-DG, CSE22-L, CSE22-R, CSE22-R-DG, CSG21-L, CSG21-R, CSG21-R-DG, CSG22-L, CSG22-R, CSG22-R-DG		

¹multipoint probe

accessories

fasteners



Part No.	551022	Ref. No.	208032
description	probe clip		
For models:	CGE11-L, CGE11-R, CGE12-L, CGE12-R, CGE21-L, CGE21-R, CGE22-L, CGE22-R, CGE61-L, CGE61-R, CGE62-L, CGE62-R, CGG11-L, CGG11-R, CGG12-L, CGG12-R, CGG21-L, CGG21-R, CGG22-L, CGG22-R, CGG61-L, CGG61-R, CGG62-L, CGG62-R, CPE63, CSE11-L, CSE11-R, CSE12-L, CSE12-R, CSE21-L, CSE21-R, CSE21-R-DG, CSE22-L, CSE22-R, CSE22-R-DG, CSE61-L, CSE61-R, CSE62-L, CSE62-R, CSG11-L, CSG11-R, CSG11-R-DG, CSG12-L, CSG12-R, CSG12-R-DG, CSG21-L, CSG21-R, CSG21-R-DG, CSG22-L, CSG22-R...(Other models you can see in the webshop)		

screw connections

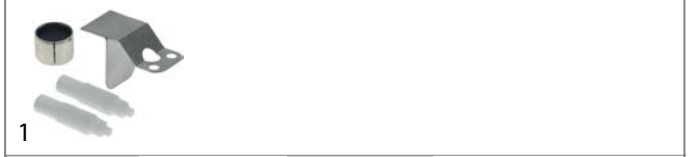

Part No.	381514	Ref. No.	205183
description	screw connection kit for temperature probe		
For models:	CGE11-L, CGE11-R, CGE12-L, CGE12-R, CGE21-L, CGE21-R, CGE22-L, CGE22-R, CGE61-L, CGE61-R, CGE62-L, CGE62-R, CGG11-L, CGG11-R, CGG12-L, CGG12-R, CGG21-L, CGG21-R, CGG22-L, CGG22-R, CGG61-L, CGG61-R, CGG62-L, CGG62-R, CPE63, CSE11-L, CSE11-R, CSE12-L, CSE12-R, CSE21-L, CSE21-R, CSE21-R-DG, CSE22-L, CSE22-R, CSE22-R-DG, CSE61-L, CSE61-R, CSE62-L, CSE62-R, CSG11-L, CSG11-R, CSG11-R-DG, CSG12-L, CSG12-R, CSG12-R-DG, CSG21-L, CSG21-R, CSG21-R-DG, CSG22-L, CSG22-R...(Other models you can see in the webshop)		

miscellaneous



Part No.	381515	Ref. No.	205327
description	protector for temperature probe ø 24.5mm H 28mm SS M12		
For models:	CCE60, CCE63, CGE11-L, CGE11-R, CGE12-L, CGE12-R, CGE21-L, CGE21-R, CGE22-L, CGE22-R, CGE61-L, CGE61-R, CGE62-L, CGE62-R, CGG11-L, CGG11-R, CGG12-L, CGG12-R, CGG21-L, CGG21-R, CGG22-L, CGG22-R, CGG61-L, CGG61-R, CGG62-L, CGG62-R, CPE60, CPE63, CSE11-L, CSE11-R, CSE11-R-DG, CSE12-L, CSE12-R, CSE12-R-DG, CSE61-L, CSE61-R, CSE61-R-DG, CSE62-L, CSE62-R, CSE62-R-DG, CSG11-L, CSG11-R, CSG11-R-DG, CSG12-L, CSG12-R, CSG12-R-DG, CSG21-L, CSG21-R, CSG21-R-DG, CSG22-L...(Other models you can see in the webshop)		

electronics
electronics accessories



Part No.	694973	Ref. No.	207097
description	button for display PCB ø 15mm grey		
For models:	CGE11-L, CGE11-R, CGE12-L, CGE12-R, CGE21-L, CGE21-R, CGE22-L, CGE22-R, CGE61-L, CGE61-R, CGE62-L, CGE62-R, CGG11-L, CGG11-R, CGG12-L, CGG12-R, CGG21-L, CGG21-R, CGG22-L, CGG22-R, CGG61-L, CGG61-R, CGG62-L, CGG62-R, CPE63, CSE11-L, CSE11-R, CSE12-L, CSE12-R, CSE21-L, CSE21-R, CSE22-L, CSE22-R, CSE61-L, CSE61-R, CSE62-L, CSE62-R, CSG11-L, CSG11-R, CSG12-L, CSG12-R, CSG21-L, CSG21-R, CSG21-R-DG, CSG22-L, CSG22-R, CSG61-L, CSG61-R, CSG62-L, CSG62-R		

1

Part No.	348214	Ref. No.	207186
description	button for display PCB transparent suitable for MKN ED ø 16mm H 4.8mm for combi-steamer		
For models:	CSE11-L, CSE11-R, CSE11-R-DG, CSE12-L, CSE12-R, CSE12-R-DG, CSE21-L, CSE21-R, CSE21-R-DG, CSE22-L, CSE22-R, CSE22-R-DG, CSE61-L, CSE61-R, CSE61-R-DG, CSE62-L, CSE62-R, CSE62-R-DG, CSG11-L, CSG11-R, CSG11-R-DG, CSG12-L, CSG12-R, CSG12-R-DG, CSG21-L, CSG21-R, CSG21-R-DG, CSG22-L, CSG22-R, CSG22-R-DG, CSG61-L, CSG61-R, CSG61-R-DG, CSG62-L, CSG62-R, CSG62-R-DG		

rectifiers



1

Part No.	400851	Ref. No.	203442
description	rectifier 420V 10A		
For models:	2013004B01, 2013004B02, 2013004B03, 2013004B04, 2013004B05, 2013008B01, 2013008B02, 2013008B03, 2013008B04, 2013008B05, 2013010B01, 2013010B02, 2013010B03, 2013010B04, 2013010B05, 2013018B00, 2013018B01, 2013018B02, 2013018B03, 2013018B04, 2021442-02, 2021442-03, 2021442A00, 2021442A01, 2021442A02, 2021442A03, 2021442B02, 2021442B03, 2021442C00, 2021442C01, 2021442C02, 2021442C03, 2021443-02, 2021443-03, 2021443-04, 2021443-05, 2021443A02, 2021443A03, 2021443A04, 2021443A05, 2021443B02, 2021443B03, 2021443B04, 2021443B05, 2021443C00, 2021443C01, 2021443C02, 2021443C03, 2021443C04, 2021443C05... (Other models you can see in the webshop)		

frequency converters

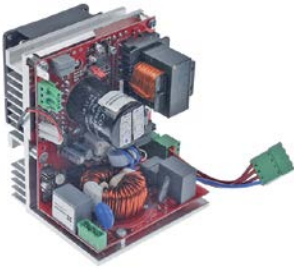

1

Part No.	403214	Ref. No.	10012693 203784
description	frequency converter with fan tray for hot air motors 100-240V L 135mm W 110mm H 135mm output frequency 0-100Hz input frequency 47-63Hz		
For models:	CGE11-L, CGE11-R, CGE12-L, CGE12-R, CGE21-L, CGE21-R, CGE22-L, CGE22-R, CGE61-L, CGE61-R, CGE62-L, CGE62-R, CGG11-L, CGG11-R, CGG12-L, CGG12-R, CGG21-L, CGG21-R, CGG22-L, CGG22-R, CGG61-L, CGG61-R, CGG62-L, CGG62-R, CPE60, CSE11-L, CSE11-R, CSE12-L, CSE12-R, CSE21-L, CSE21-R, CSE22-L, CSE22-R, CSE61-L, CSE61-R, CSE62-L, CSE62-R, CSG11-L, CSG11-R, CSG11-R-DG, CSG12-L, CSG12-R, CSG12-R-DG, CSG21-L, CSG21-R, CSG21-R-DG, CSG22-L, CSG22-R, CSG22-R-DG, CSG61-L... (Other models you can see in the webshop)		

PCBs





1

Part No.	401447	Ref. No.	203128
description	control PCB		
For models:	1220302-00, 1220302-01, 1220302B00, 1220302B01, 1220302D00, 1220302E00, 1220304-00, 1220304-01, 1220304A00, 1220304A01, 1220304A02, 1220304B00, 1220304B01, 1220304C00, 1220304C01, 1220304C02, 1220304D00, 1220304E00, 1220304F00, 1220304F01, 1220304H00, 1220304H01, 1220306-00, 1220306-01, 1220306A00, 1220306A01, 1220306A02, 1220306A03, 1220306A04, 1220306B00, 1220306B01, 1220306C00, 1220306C01, 1220306C02, 1220306C03, 1220306C04, 1220306D00, 1220306E00, 1220306F00, 1220306F01, 1220306F02, 1220306F03, 1220306H00, 1220306H01, 1220306H02, 1220306H03, 1320302-00, 1320302-01, 1320302B00, 1320302B01... (Other models you can see in the webshop)		

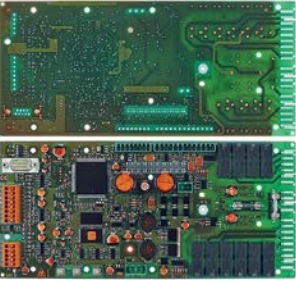

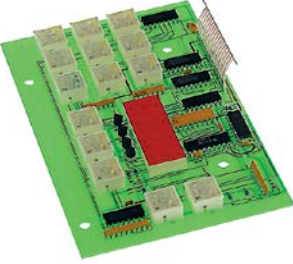

			
1			
Part No.	403807	Ref. No.	202676
description	control PCB combi-steamer Hans Dampf L 250mm W 115mm		
For models:	CCE60, CCE63, CSE11-L, CSE11-R, CSE11-R-DG, CSE12-L, CSE12-R, CSE12-R-DG, CSE21-L, CSE21-R, CSE21-R-DG, CSE22-L, CSE22-R, CSE22-R-DG, CSE61-L, CSE61-R, CSE61-R-DG, CSE62-L, CSE62-R, CSE62-R-DG, CSG11-L, CSG11-R, CSG11-R-DG, CSG12-L, CSG12-R, CSG12-R-DG, CSG21-L, CSG21-R, CSG21-R-DG, CSG22-L, CSG22-R, CSG22-R-DG, CSG61-L, CSG61-R, CSG61-R-DG, CSG62-L, CSG62-R, CSG62-R-DG		

			
2			
Part No.	403808	Ref. No.	202788
description	controller for USB MKN L 64.5mm W 31.5mm		
For models:	CGE11-L, CGE11-R, CGE12-L, CGE12-R, CGE21-L, CGE21-R, CGE22-L, CGE22-R, CGE61-L, CGE61-R, CGE62-L, CGE62-R, CGG11-L, CGG11-R, CGG12-L, CGG12-R, CGG21-L, CGG21-R, CGG22-L, CGG22-R, CGG61-L, CGG61-R, CGG62-L, CGG62-R		

			
1			
Part No.	401445	Ref. No.	203124
description	keypad PCB		
For models:	1220302-00, 1220302-01, 1220302B00, 1220302B01, 1220302D00, 1220302E00, 1220304-00, 1220304-01, 1220304A00, 1220304A01, 1220304A02, 1220304B00, 1220304B01, 1220304C00, 1220304C01, 1220304C02, 1220304D00, 1220304E00, 1220304F00, 1220304F01, 1220304H00, 1220304H01, 1220306-00, 1220306-01, 1220306A00, 1220306A01, 1220306A02, 1220306A03, 1220306A04, 1220306B00, 1220306B01, 1220306C00, 1220306C01, 1220306C02, 1220306C03, 1220306C04, 1220306D00, 1220306E00, 1220306F00, 1220306F01, 1220306F02, 1220306F03, 1220306H00, 1220306H01, 1220306H02, 1220306H03, 1320302-00, 1320302-01, 1320302B00, 1320302B01... (Other models you can see in the webshop)		
accessories for	401445		
	Part No.	401446	Ref. No. 055055
keypad foil L 170mm W 70mm buttons 14			

			
1			
Part No.	403034	Ref. No.	203746
description	keypad PCB		
For models:	CGE11-L, CGE11-R, CGE22-L, CGE22-R, CGE61-L, CGE61-R, CSE11-L, CSE11-R, CSE21-L, CSE21-R, CSE22-L, CSE22-R, CSE61-L, CSE61-R, CSG21-L, CSG21-R, CSG22-L, CSG22-R		

			
1			
Part No.	401697	Ref. No.	202690
description	keypad PCB combi-steamer Hans Dampf		
For models:	CSE11-L, CSE11-R, CSE11-R-DG, CSE12-L, CSE12-R, CSE12-R-DG, CSE21-L, CSE21-R, CSE21-R-DG, CSE22-L, CSE22-R, CSE22-R-DG, CSE61-L, CSE61-R, CSE61-R-DG, CSE62-L, CSE62-R, CSE62-R-DG, CSG11-L, CSG11-R, CSG11-R-DG, CSG12-L, CSG12-R, CSG12-R-DG, CSG21-L, CSG21-R, CSG21-R-DG, CSG22-L, CSG22-R, CSG22-R-DG, CSG61-L, CSG61-R, CSG61-R-DG, CSG62-L, CSG62-R, CSG62-R-DG		

			
1			
Part No.	401698	Ref. No.	203745
description	keypad PCB combi-steamer Hans Dampf		
For models:	CGE11-L, CGE11-R, CGE12-L, CGE12-R, CGE21-L, CGE21-R, CGE22-L, CGE22-R, CGE61-L, CGE61-R, CGE62-L, CGE62-R, CGG11-L, CGG11-R, CGG12-L, CGG12-R, CGG21-L, CGG21-R, CGG22-L, CGG22-R, CGG61-L, CGG61-R, CGG62-L, CGG62-R, CSE11-L, CSE11-R, CSE12-L, CSE12-R, CSE22-L, CSE22-R, CSE61-L, CSE61-R, CSE62-L, CSE62-R, CSG11-L, CSG11-R, CSG12-L, CSG12-R, CSG61-L, CSG61-R, CSG62-L, CSG62-R		



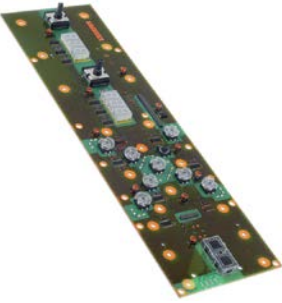

 <p>1</p>			
Part No.	403307	Ref. No.	202128
description	keypad PCB combi-steamer JUNIOR L 410mm W 115mm buttons 10		
For models:	CCE60, CCE63, CPE60, CPE63		

 <p>1</p>			
Part No.	401969	Ref. No.	203766
description	PCB		
For models:	CGE11-L, CGE11-R, CGE12-L, CGE12-R, CGE21-L, CGE21-R, CGE22-L, CGE22-R, CGE61-L, CGE61-R, CGE62-L, CGE62-R, CGG11-L, CGG11-R, CGG12-L, CGG12-R, CGG21-L, CGG21-R, CGG22-L, CGG22-R, CGG61-L, CGG61-R, CGG62-L, CGG62-R, CSE11-L, CSE11-R, CSE61-L, CSE61-R		

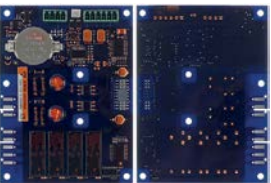
 <p>1</p>			
Part No.	401393	Ref. No.	203306
description	PCB 230V		
For models:	1023401-00, 1223202A00, 1223202A01, 1223202J00, 1223202J01, 1223209-00, 1223209-01, 1223401-00, 1223401J00, 1223402-00, 1323202A00, 1323202A01, 1323202A02, 1323209-00, 1323209-01, 1323209-02, 1323209-03, 1323210-00, 1323210-01, 1323210-02, 1323210-03, 1323210-04, 1323401-00, 1323402-00, 1323403-00, 1423401-00, 1423402-00, 1424818A00, 1424824-00, 1424824-01, 1424825-00, 1523401-00, 1523402-00, 2023212-00, 2023401-00, 2123207A00, 2123207A01, 2123208A00, 2123208A01, 2123208A02, 2123208A03, 2123210-00, 2123401-00, 2123402-00, 2123403-00, 3023401-00		

 <p>1</p>			
Part No.	403806	Ref. No.	202698
description	PCB combi-steamer Hans Dampf L 115mm W 87mm		
For models:	CSG11-L, CSG11-R, CSG11-R-DG, CSG12-L, CSG12-R, CSG12-R-DG, CSG21-L, CSG21-R, CSG21-R-DG, CSG22-L, CSG22-R, CSG22-R-DG, CSG61-L, CSG61-R, CSG61-R-DG, CSG62-L, CSG62-R, CSG62-R-DG		

 <p>1</p>			
Part No.	403809	Ref. No.	202600
description	PCB for combi-steamer Hans Dampf L 28mm W 27mm for ignition electrode		
For models:	CGG11-L, CGG11-R, CGG12-L, CGG12-R, CGG21-L, CGG21-R, CGG22-L, CGG22-R, CGG61-L, CGG61-R, CGG62-L, CGG62-R, CSG11-L, CSG11-R, CSG12-L, CSG12-R, CSG21-L, CSG21-R, CSG22-L, CSG22-R, CSG61-L, CSG61-R, CSG62-L, CSG62-R		

 <p>1</p>			
Part No.	403869	Ref. No.	203773
description	PCB for combi-steamer L 50mm W 50mm		
For models:	CPE63		

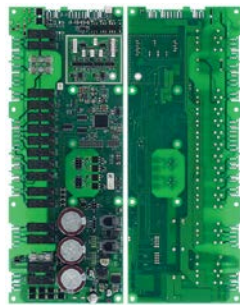
 <p>1</p>			
Part No.	403876	Ref. No.	10013404
description	PCB L 320mm W 125mm		

 <p>1</p>			
Part No.	400074	Ref. No.	203911
description	PCB pyroceram range 2023206-00 400V		
For models:	0723405-01, 0723405-02, 0723409-01, 0723409-02, 0723413-02, 0723414-02, 1023410-00, 1423404-00, 1423404-01, 1423405-00, 1423405-01, 1423405-02, 1423409-00, 1423409-01, 1423409-02, 1423413-02, 1423414-02, 1424819-00, 1424826-00, 1523405-00, 1523405-01, 1523409-00, 1523409-01, 1523410-00, 2023206-00, 2023206-01, 2023206-02, 2023207-00, 2023207-01, 2023207-02, 2023207-03, 2023207-04, 2023207-05, 2023405-00, 2023405D00, 2023406-00, 2023407-00, 2023407-01, 2023409-00, 3023206-00, 3023206-01, 3023206-02, 3023405-00, 3023406-00, 3023409-00		



Part No.	403872	Ref. No.	203747
description	relay PCB for combi-steamer L 320mm W 150mm		
For models:	CCE60, CCE63, CGE11-L, CGE11-R, CGE12-L, CGE12-R, CGE21-L, CGE21-R, CGE22-L, CGE22-R, CGE61-L, CGE61-R, CGE62-L, CGE62-R, CGG11-L, CGG11-R, CGG12-L, CGG12-R, CGG21-L, CGG21-R, CGG22-L, CGG22-R, CGG61-L, CGG61-R, CGG62-L, CGG62-R, CPE60, CPE63, CSE11-L, CSE11-R, CSE12-L, CSE12-R, CSE21-L, CSE21-R, CSE22-L, CSE22-R, CSE61-L, CSE61-R, CSE62-L, CSE62-R, CSG21-L, CSG21-R, CSG22-L, CSG22-R, CSG61-L, CSG61-R, CSG62-L, CSG62-R		



Part No.	403877	Ref. No.	10013402
description	touch panel mounting frame inclusive L 400mm W 208mm		

keypads

front foils



Part No.	401446	Ref. No.	055055
description	keypad foil L 170mm W 70mm buttons 14		
For models:	1220302-00, 1220302-01, 1220302B00, 1220302B01, 1220302D00, 1220302E00, 1220304-00, 1220304-01, 1220304A00, 1220304A01, 1220304A02, 1220304B00, 1220304B01, 1220304C00, 1220304C01, 1220304C02, 1220304D00, 1220304E00, 1220304F00, 1220304F01, 1220304H00, 1220304H01, 1220306-00, 1220306-01, 1220306A00, 1220306A01, 1220306A02, 1220306A03, 1220306A04, 1220306B00, 1220306B01, 1220306C00, 1220306C01, 1220306C02, 1220306C03, 1220306C04, 1220306D00, 1220306E00, 1220306F00, 1220306F01, 1220306F02, 1220306F03, 1220306H00, 1220306H01, 1220306H02, 1220306H03, 1320302-00, 1320302-01, 1320302B00, 1320302B01... (Other models you can see in the webshop)		

solenoid valves

solenoid valves (water)

INTERELEKTRIK

medium temperature: 90°C 90°C 60°C
 ambient temperature: 60°C 25°C 60°C
 duty cycle: 40% 100% 100%

with reducers



Part No.	370747	Ref. No.	201142
description	solenoid valve double straight 220-240VAC inlet 3/4" outlet 10.5mm INTERELEKTRIK plastic output B 3l/min flow regulating valve outlet B red		
For models:	CGE11-L, CGE11-R, CGE12-L, CGE12-R, CGE61-L, CGE61-R, CGE62-L, CGE62-R, CPE63, CSE11-L, CSE11-R, CSE12-L, CSE12-R, CSE61-L, CSE61-R, CSE62-L, CSE62-R		





Part No.	370843	Ref. No.	203663
description	solenoid valve single straight 220-240 inlet 3/4" outlet 1/2" input 2l/min DN8 t.max. 90°C duty cycle 100% INTERELEKTRIK plastic flow regulating valve inlet yellow total length 84.5mm		
For models:	1422807B03, 1422807B04, 1422831-00, 1422832-00, 1422833-00, 1422834-00, 1422902-03, 1422902-04, 1422908-00, 1422910-00, 1423901-00, 1423901-01, 1423901-02, 1423902-00, 1423902-01, 1423902-02, 1423903-00, 1423903-01, 1423903-02, 1424101-00, 1424101-01, 1424102-00, 1424102-01, 1424103-00, 1424104-00, 1462831-00, 1462832-00, 1462833-00, 1462834-00, 1462835-00, 1462836-00, 1462837-00, 1462838-00, 1462839-00, 1462840-00, 1462908-00, 1462910-00, 2013901-00, 2013901-01, 2013901-02, 2013901-03, 2013902-00, 2013902-01, 2013902-02, 2013902-03, 2013903-00, 2013903-01, 2013903-02, 2013903-03, 2022802B08... (Other models you can see in the webshop)		



Part No.	370746	Ref. No.	201140
description	solenoid valve single straight 220-240VAC inlet 3/4" outlet 10.5mm output 3l/min INTERELEKTRIK plastic flow regulating valve outlet red		
For models:	CGE11-L, CGE11-R, CGE12-L, CGE12-R, CGE61-L, CGE61-R, CGE62-L, CGE62-R, CSE11-L, CSE11-R, CSE12-L, CSE12-R, CSE61-L, CSE61-R, CSE62-L, CSE62-R		



			
1			
Part No.	370144	Ref. No.	201160
description	solenoid valve single straight 230VAC outlet 10.5mm t.max. 90°C plastic inlet 3/4"mm		
For models:	CGE11-L, CGE11-R, CGE12-L, CGE12-R, CGE21-L, CGE21-R, CGE22-L, CGE22-R, CGE61-L, CGE61-R, CGE62-L, CGE62-R, CGG11-L, CGG11-R, CGG12-L, CGG12-R, CGG21-L, CGG21-R, CGG22-L, CGG22-R, CGG61-L, CGG61-R, CGG62-L, CGG62-R, CSE11-L, CSE11-R, CSE11-R-DG, CSE12-L, CSE12-R, CSE12-R-DG, CSE21-L, CSE21-R, CSE21-R-DG, CSE22-L, CSE22-R, CSE22-R-DG, CSE61-L, CSE61-R, CSE61-R-DG, CSE62-L, CSE62-R, CSE62-R-DG, CSG11-L, CSG11-R, CSG11-R-DG, CSG12-L, CSG12-R, CSG21-L, CSG21-R, CSG21-R-DG...(Other models you can see in the webshop)		

			
1			
Part No.	370308	Ref. No.	203832
description	valve unit 24VDC		
For models:	CGE11-L, CGE11-R, CGE12-L, CGE12-R, CGE21-L, CGE21-R, CGE22-L, CGE22-R, CGE61-L, CGE61-R, CGE62-L, CGE62-R, CGG11-L, CGG11-R, CGG12-L, CGG12-R, CGG21-L, CGG21-R, CGG22-L, CGG22-R, CGG61-L, CGG61-R, CGG62-L, CGG62-R, CSE11-L, CSE11-R, CSE11-R-DG, CSE12-L, CSE12-R, CSE12-R-DG, CSE21-L, CSE21-R, CSE21-R-DG, CSE22-L, CSE22-R, CSE22-R-DG, CSE61-L, CSE61-R, CSE61-R-DG, CSE62-L, CSE62-R, CSE62-R-DG, CSG11-L, CSG11-R, CSG11-R-DG, CSG12-L, CSG12-R, CSG12-R-DG, CSG21-L, CSG21-R, CSG21-R-DG...(Other models you can see in the webshop)		

MÜLLER

medium temperature: 90°C
duty cycle: 100%

spare parts and accessories

miscellaneous

			
1			
Part No.	371002	Ref. No.	10011599
description	solenoid valve holder MÜLLER flange support		
For models:	CSE11-L, CSE11-R, CSE11-R-DG, CSE12-L, CSE12-R, CSE12-R-DG, CSE21-L, CSE21-R, CSE21-R-DG, CSE22-L, CSE22-R, CSE22-R-DG, CSE61-L, CSE61-R, CSE61-R-DG, CSE62-L, CSE62-R, CSE62-R-DG, CSG11-L, CSG11-R, CSG11-R-DG, CSG12-L, CSG12-R, CSG12-R-DG, CSG21-L, CSG21-R, CSG21-R-DG, CSG22-L, CSG22-R, CSG22-R-DG, CSG61-L, CSG61-R, CSG61-R-DG, CSG62-L, CSG62-R, CSG62-R-DG		

various

			
1			
Part No.	370307	Ref. No.	203831
description	valve unit 24VDC		
For models:	CGE21-L, CGE21-R, CGE22-L, CGE22-R, CGG21-L, CGG21-R, CGG22-L, CGG22-R, CSE11-L, CSE11-R, CSE11-R-DG, CSE12-L, CSE12-R, CSE12-R-DG, CSE21-L, CSE21-R, CSE21-R-DG, CSE22-L, CSE22-R, CSE22-R-DG, CSE61-L, CSE61-R, CSE61-R-DG, CSE62-L, CSE62-R, CSE62-R-DG, CSG11-L, CSG11-R, CSG11-R-DG, CSG12-L, CSG12-R, CSG12-R-DG, CSG21-L, CSG21-R, CSG21-R-DG, CSG22-L, CSG22-R, CSG22-R-DG, CSG61-L, CSG61-R, CSG61-R-DG, CSG62-L, CSG62-R, CSG62-R-DG		

metal

PARKER

solenoid valves (various)

			
1			
Part No.	370749	Ref. No.	201153
description	solenoid valve 2-ways 230VAC inlet 1/8" outlet 1/8" connection 1/8" L 30mm PARKER type series WB4.5 membranes Viton p max 10bar 50/60Hz brass		
For models:	CPE63		

solenoid valves (various)

			
1			
Part No.	370175	Ref. No.	201657
description	solenoid valve 2-ways 230VAC connection 1/4" brass		
For models:	1422802B04, 1422802B05, 1422802B06, 1422804B04, 1422804B05, 1422804B06, 1422805B04, 1422805B05, 1422805B06, 1422807B00, 1422807B01, 1422807B02, 1422902-00, 1422902-01, 1422902-02, 1462802B00, 1462802B01, 1462802B02, 1462802B03, 1462802B04, 1462802B05, 1462804B00, 1462804B01, 1462804B02, 1462804B03, 1462804B04, 1462804B05, 2022801-02, 2022801-03, 2022801A02, 2022801A03, 2022801B02, 2022801B03, 2022801C02, 2022801C03, 2022802-02, 2022802-03, 2022802A02, 2022802A03, 2022802B02, 2022802B03, 2022802B04, 2022802B05, 2022802B06, 2022802B07, 2022802C02, 2022802C03, 2022802C07, 2022803-02, 2022803-03...(Other models you can see in the webshop)		



			
1			
Part No.	370748	Ref. No.	201141
description	solenoid valve 2-ways 230VAC inlet 1/8" outlet 1/8" L 40mm p max 10bar 50Hz brass		
For models:	CGE11-L, CGE11-R, CGE12-L, CGE12-R, CGE21-L, CGE21-R, CGE22-L, CGE22-R, CGE61-L, CGE61-R, CGE62-L, CGE62-R, CGG11-L, CGG11-R, CGG12-L, CGG12-R, CGG21-L, CGG21-R, CGG22-L, CGG22-R, CGG61-L, CGG61-R, CGG62-L, CGG62-R, CPE63, CSE11-L, CSE11-R, CSE12-L, CSE12-R, CSE21-L, CSE21-R, CSE22-L, CSE22-R, CSE61-L, CSE61-R, CSE62-L, CSE62-R, CSG11-L, CSG11-R, CSG12-L, CSG12-R, CSG21-L, CSG21-R, CSG22-L, CSG22-R, CSG61-L, CSG61-R		

solenoid valves (gas)

DUNGS			
			
1			
Part No.	102379 ¹	Ref. No.	201529
description	solenoid valve 230VAC connection 1/2" L 76mm DUNGS p max 0.2bar p min 0bar reg. no. 63AQ0626 gas inlet 1/2" gas outlet 1/2"		
For models:	2061403-00, 2061403-01, 20614033-0, 2061403A00, 2061403B00, 2061403C00, 2061404-00, 2061404-01, 20614044-0, 2061404A00, 2061404B00, 2061404C00, 2061405-00, 2061405B00, 2061406-00, 2061406B00, 20628033-0, 20628044-0, 20629011-0, 20629022-0, 3061403-00, 3061403A00, 3061403B00, 3061403C00, 3061404-00, 3061404A00, 3061404B00, 3061404C00, 3061405-00, 3061405B00, 3061405B01, 3061406-00, 3061406B00		

¹aluminium housing

Solenoid valve - accessories

			
1			
Part No.	371001	Ref. No.	204532
description	solenoid valve holder		
For models:	1422807B03, 1422807B04, 1422831-00, 1422832-00, 1422833-00, 1422834-00, 1422902-03, 1422902-04, 1422908-00, 1422910-00, 1462831-00, 1462832-00, 1462833-00, 1462834-00, 1462835-00, 1462836-00, 1462837-00, 1462838-00, 1462839-00, 1462840-00, 1462908-00, 1462910-00, 2022802B08, 2022802B09, 2022802B10, 2022802C08, 2022802C09, 2022802C10, 2022802D00, 2022802D01, 2022802D02, 2022804B08, 2022804B09, 2022804B10, 2022804C08, 2022804C09, 2022804C10, 2022804D00, 2022804D01, 2022804D02, 2022805B08, 2022805B09, 2022805B10, 2022805C08, 2022805C09, 2022805C10, 2022805D00, 2022805D01, 2022807B06, 2022807B07... (Other models you can see in the webshop)		

			
1			
Part No.	371002	Ref. No.	10011599
description	solenoid valve holder MÜLLER flange support		
For models:	CSE11-L, CSE11-R, CSE11-R-DG, CSE12-L, CSE12-R, CSE12-R-DG, CSE21-L, CSE21-R, CSE21-R-DG, CSE22-L, CSE22-R, CSE22-R-DG, CSE61-L, CSE61-R, CSE61-R-DG, CSE62-L, CSE62-R, CSE62-R-DG, CSG11-L, CSG11-R, CSG11-R-DG, CSG12-L, CSG12-R, CSG12-R-DG, CSG21-L, CSG21-R, CSG21-R-DG, CSG22-L, CSG22-R, CSG22-R-DG, CSG61-L, CSG61-R, CSG61-R-DG, CSG62-L, CSG62-R, CSG62-R-DG		

pressure switches for steam control

			
1			
Part No.	541139	Ref. No.	203399
description	pressure control ø 45mm pressure connection vertical steam control pressure range 0.8/0.65bar connection 1/4" pressure connection 1/4"		
For models:	1422802B04, 1422802B05, 1422802B06, 1422802B07, 1422802B08, 1422804B04, 1422804B05, 1422804B06, 1422804B07, 1422804B08, 1422805B04, 1422805B05, 1422805B06, 1422805B07, 1422805B08, 1422807B00, 1422807B01, 1422807B02, 1422807B03, 1422807B04, 1422831-00, 1422832-00, 1422833-00, 1422834-00, 1422902-00, 1422902-01, 1422902-02, 1422902-03, 1422902-04, 1422908-00, 1422910-00, 1462802B00, 1462802B01, 1462802B02, 1462802B03, 1462802B04, 1462802B05, 1462804B00, 1462804B01, 1462804B02, 1462804B03, 1462804B04, 1462804B05, 1462831-00, 1462832-00, 1462835-00, 1462836-00, 1462837-00, 1462908-00, 2022802B04... (Other models you can see in the webshop)		

			
1			
Part No.	541022	Ref. No.	203439
description	pressure control steam control pressure connection vertical pressure range adjustable 0.25-4.5bar connection 1/4" pressure connection 1/4" IT		
For models:	14228011-0, 14228022-0, 14228033-0, 14228044-0, 14228055-0, 2022801-00, 2022801-01, 2022801-02, 2022801-03, 20228011-0, 20228011-1, 2022801A00, 2022801A01, 2022801A02, 2022801A03, 2022801B00, 2022801B01, 2022801B02, 2022801B03, 2022801C00, 2022801C01, 2022801C02, 2022801C03, 2022802-00, 2022802-01, 2022802-02, 2022802-03, 20228022-0, 20228022-1, 2022802A00, 2022802A01, 2022802A02, 2022802A03, 2022802B00, 2022802B01, 2022802B02, 2022802B03, 2022802C00, 2022802C01, 2022802C02, 2022802C03, 2022803-00, 2022803-01, 2022803-02, 2022803-03, 20228033-0, 20228033-1, 2022803A00, 2022803A01, 2022803A02... (Other models you can see in the webshop)		





for combi-steamers

			
1			
Part No.	543037	Ref. No.	202601
description	pressure control ø 23mm pressure range 15/25mbar connection 9mm 42V 2A		
For models:	CCE60, CCE63, CPE60, CPE63		

			
1			
Part No.	542407	Ref. No.	10011816 10017027
description	pressure control triggering pressure 100bar 48V 0.5A 1/4"		

electrodes

			
1			
Part No.	400122	Ref. No.	230867
description	level electrode 1/4" probe L 102mm insulated probe length 95mm		

			
1			
Part No.	401409	Ref. No.	203858 203859 203867 845591
description	level electrode 1/4" total length 132mm probe L 102mm insulated probe length 95mm connection F6.3 ø 3mm		
spare parts for	401409		
	Part No.	401458	Ref. No. 203601
	 level electrode M10x1 total length 132mm probe L 112mm insulated probe length 105mm connection F6.3 1/8"		

			
1			
Part No.	401458	Ref. No.	203601
description	level electrode M10x1 total length 132mm probe L 112mm insulated probe length 105mm connection F6.3 1/8"		
For models:	1422802B04, 1422802B05, 1422802B06, 1422802B07, 1422802B08, 1422804B04, 1422804B05, 1422804B06, 1422804B07, 1422804B08, 1422805B04, 1422805B05, 1422805B06, 1422805B07, 1422805B08, 1422807B00, 1422807B01, 1422807B02, 1422807B03, 1422807B04, 1422831-00, 1422832-00, 1422833-00, 1422834-00, 1422902-00, 1422902-01, 1422902-02, 1422902-03, 1422902-04, 1422908-00, 1422910-00, 1423901-00, 1423901-01, 1423901-02, 1423902-00, 1423902-01, 1423902-02, 1423903-00, 1423903-01, 1423903-02, 1462802B01, 1462802B02, 1462802B03, 1462802B04, 1462802B05, 1462804B01, 1462804B02, 1462804B03, 1462804B04, 1462804B05... (Other models you can see in the webshop)		

flow meters and flow sensors

flow meters

GICAR

			
1			
Part No.	403873	Ref. No.	203687
description	flow meter thread M10x1 plastic nominal-ø 2mm approval NSF Qmax. 2.3l/min		
For models:	CGE11-L, CGE11-R, CGE12-L, CGE12-R, CGE21-L, CGE21-R, CGE22-L, CGE22-R, CGE61-L, CGE61-R, CGE62-L, CGE62-R, CGG11-L, CGG11-R, CGG12-L, CGG12-R, CGG21-L, CGG21-R, CGG22-L, CGG22-R, CGG61-L, CGG61-R, CGG62-L, CGG62-R, CSE11-L, CSE11-R, CSE12-L, CSE12-R, CSE21-L, CSE21-R, CSE22-L, CSE22-R, CSE61-L, CSE61-R, CSE62-L, CSE62-R, CSG11-L, CSG11-R, CSG12-L, CSG12-R, CSG21-L, CSG21-R, CSG22-L, CSG22-R, CSG61-L, CSG61-R		

→ electric components





fans

axial fans

ebm-papst



1

Part No.	601030 ¹	Ref. No.	203155
description	axial fan L 119mm W 119mm H 38mm 230VAC 50Hz 18W bearing ball bearing manuf. no. 4656Z metal connection male faston 2.8mm ebm-papst fan wheel ø 110mm temp.-resist. 75°C		
For models:	0723104B03, 0723105B03, 1223204-00, 1223204-01, 1223204-02, 1223205-00, 1223205-01, 1223205-02, 1223206-00, 1223206-01, 1223206-02, 1223212-00, 1223214-00, 1423104B03, 1423105B03, 2023114-00, 2023118-00, 2023119-00, 2023206-00, 2023206-01, 2023207-00, 2023207-01, 2023207-02, 2023207-03, 2023207-04, 2023503-04, 2023503-05, 2023503-06, 2023503-07, 2023503-08, 2023503-09, 2023503-10, 2023503A04, 2023503A05, 2023503A06, 2023503A07, 2023503A08, 2023503A09, 2023503A10, 2123207A00, 2123208A00, 2123208A01, 2123208A02, 2123503-01, 2123503-02, 2123503-03, 2123503-04, 2123503-05, 2123503-06, 2123503A01... (Other models you can see in the webshop)		
accessories for	601030		
	Part No.	550898	Ref. No. —
	connecting cable cable length 2000mm connection F 2.8 connection distance 7.9mm for axial flow fan		
	Part No.	692497	Ref. No. —
	guard ø 105mm mounting distance 150mm for axial fan ebm-papst-mm		

¹with ball bearings

1

Part No.	601715 ¹	Ref. No.	203819
description	axial fan L 119mm W 119mm H 38mm 230VAC 50Hz 18W bearing ball bearing manuf. no. 4656ZW metal connection cable 310mm ebm-papst fan wheel ø 110mm temp.-resist. 75°C		
For models:	CCE60, CCE63, CGG21-L, CGG21-R, CGG22-L, CGG22-R, CPE60, CPE63, CSE11-L, CSE11-R, CSE11-R-DG, CSE12-L, CSE12-R, CSE12-R-DG, CSE61-L, CSE61-R, CSE61-R-DG, CSE62-L, CSE62-R, CSE62-R-DG, CSG11-L, CSG11-R, CSG11-R-DG, CSG12-L, CSG12-R, CSG12-R-DG, CSG21-L, CSG21-R, CSG21-R-DG, CSG22-L, CSG22-R, CSG22-R-DG, CSG61-L, CSG61-R, CSG61-R-DG, CSG62-L, CSG62-R, CSG62-R-DG		

¹with ball bearings

import



1

Part No.	601130 ¹	Ref. No.	203152
description	axial fan L 80mm W 80mm H 25mm 230VAC 50/60Hz 13/14W bearing ball bearing connection male faston 2.8mm metal ADDA fan wheel ø 75mm temp.-resist. 70°C airflow 30.6m ³ /h		
accessories for	601130		
	Part No.	550898	Ref. No. —
	connecting cable cable length 2000mm connection F 2.8 connection distance 7.9mm for axial flow fan		

¹with ball bearings

hot air motors



1

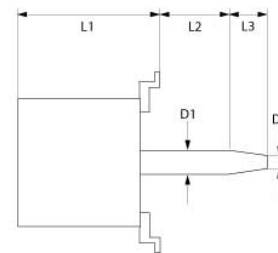

Part No.	601862	Ref. No.	203977
description	fan motor 200-230V 3 phase 50Hz 0.45/0.65kW 700/1400rpm speeds 2 L1 145mm L2 35mm L3 35mm 0.7/2A D1 ø 17mm D2 ø 13.5mm		
For models:	CGE11-L, CGE11-R, CGE12-L, CGE12-R, CGE61-L, CGE61-R, CGE62-L, CGE62-R, CSE11-L, CSE11-R, CSE12-L, CSE12-R, CSE61-L, CSE61-R, CSE62-L, CSE62-R		



1

Part No.	501583	Ref. No.	202745
description	fan motor 200-240V 50/60Hz 3000/3600rpm L1 125mm L2 35mm L3 15mm ø 100mm 0.5/0,7A type L5tw2 - 695 D1 ø 8mm D2 ø 8x7.5mm		
For models:	CCE60, CCE63, CPE60, CPE63		



1

Part No.	602153	Ref. No.	202673
description	fan motor 200-480V 3 phase 50/60Hz 0.6-0.82kW 1380/1650rpm speeds 1 L1 151mm L2 67mm L3 35mm ø 160mm M10 IT 2.8/1.6A at 50Hz 200-415V at 60Hz 200-480V at 50Hz 1380rpm at 60Hz 1650rpm type L9Fw4D-678 no. C6 D1 ø 17mm D2 ø 13.5mm with shaft sealing		
For models:	CSE11-L, CSE11-R, CSE11-R-DG, CSE12-L, CSE12-R, CSE12-R-DG, CSE21-L, CSE21-R, CSE21-R-DG, CSE22-L, CSE22-R, CSE22-R-DG, CSE61-L, CSE61-R, CSE61-R-DG, CSE62-L, CSE62-R, CSE62-R-DG		

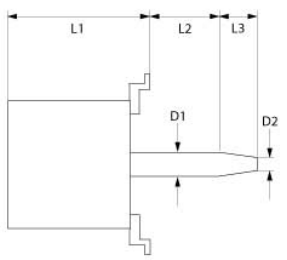
1

Part No.	601485	Ref. No.	203771
description	fan motor 240V 3 phase 60Hz 0.68kW 1730rpm speeds 1 L1 150mm L2 24mm L3 35mm M10R IT 2.9A power input 870W at 60Hz 1730rpm type L9DFw4D-596 no. W6 D1 ø 17mm D2 ø 13mm		
For models:	CGE11-L, CGE11-R, CGE12-L, CGE12-R, CGE21-L, CGE21-R, CGE22-L, CGE22-R, CGE61-L, CGE61-R, CGE62-L, CGE62-R, CGG11-L, CGG11-R, CGG12-L, CGG12-R, CGG21-L, CGG21-R, CGG22-L, CGG22-R, CGG61-L, CGG61-R, CGG62-L, CGG62-R, CSE11-L, CSE11-R, CSE12-L, CSE12-R, CSE21-L, CSE21-R, CSE22-L, CSE22-R, CSE61-L, CSE61-R, CSE62-L, CSE62-R, CSG11-L, CSG11-R, CSG11-R-DG, CSG12-L, CSG12-R, CSG12-R-DG, CSG21-L, CSG21-R, CSG21-R-DG, CSG22-L, CSG22-R, CSG22-R-DG, CSG61-L, CSG61-R...(Other models you can see in the webshop)		



1

Part No.	514511	Ref. No.	062005
description	fan wheel blades 12 D1 ø 280mm D2 ø 13mm D3 ø 16mm H1 110mm H2 31mm H3 4.5mm		
For models:	CGG61-L, CGG61-R, CGG62-L, CGG62-R, CSG61-L, CSG61-R, CSG61-R-DG, CSG62-L, CSG62-R, CSG62-R-DG		



1

Part No.	514512	Ref. No.	062002
description	fan wheel blades 12 D1 ø 350mm D2 ø 13mm D3 ø 16mm H1 115mm H2 32mm H3 4.5mm		
For models:	CGE11-L, CGE11-R, CGE12-L, CGE12-R, CGE21-L, CGE21-R, CGE22-L, CGE22-R, CGE61-L, CGE61-R, CGE62-L, CGE62-R, CGG11-L, CGG11-R, CGG12-L, CGG12-R, CGG21-L, CGG21-R, CGG22-L, CGG22-R, CSE11-L, CSE11-R, CSE11-R-DG, CSE12-L, CSE12-R, CSE12-R-DG, CSE21-L, CSE21-R, CSE21-R-DG, CSE22-L, CSE22-R, CSE22-R-DG, CSE61-L, CSE61-R, CSE61-R-DG, CSE62-L, CSE62-R, CSE62-R-DG, CSG11-L, CSG11-R, CSG11-R-DG, CSG12-L, CSG12-R, CSG12-R-DG, CSG21-L, CSG21-R, CSG21-R-DG, CSG22-L, CSG22-R, CSG22-R-DG		



1

Part No.	514513	Ref. No.	062008
description	fan wheel blades 45 D1 ø 197mm D2 ø 13mm D3 ø 15mm H1 43mm H2 23mm H3 3mm		
For models:	CCE60, CPE60		



1

Part No.	699359	Ref. No.	945446
description	flange ED ø 60mm int. ø 1 22mm SS M4		
For models:	CGE11-L, CGE11-R, CGE12-L, CGE12-R, CGE21-L, CGE21-R, CGE22-L, CGE22-R, CGE61-L, CGE61-R, CGE62-L, CGE62-R, CGG11-L, CGG11-R, CGG12-L, CGG12-R, CGG21-L, CGG21-R, CGG22-L, CGG22-R, CGG61-L, CGG61-R, CGG62-L, CGG62-R, CPE63, CSE11-L, CSE11-R, CSE11-R-DG, CSE12-L, CSE12-R, CSE12-R-DG, CSE21-L, CSE21-R, CSE21-R-DG, CSE22-L, CSE22-R, CSE22-R-DG, CSE61-L, CSE61-R, CSE61-R-DG, CSE62-L, CSE62-R, CSE62-R-DG, CSG11-L, CSG11-R, CSG11-R-DG, CSG12-L, CSG12-R, CSG12-R-DG, CSG21-L...(Other models you can see in the webshop)		



1

Part No.	699364	Ref. No.	204681
description	flange for combi-steamer ED ø 50mm int. ø 1 24mm int. ø 2 19mm thickness 7mm SS		
For models:	CCE60, CGE11-L, CGE11-R, CGE12-L, CGE12-R, CGE21-L, CGE21-R, CGE22-L, CGE22-R, CGE61-L, CGE61-R, CGE62-L, CGE62-R, CGG11-L, CGG11-R, CGG12-L, CGG12-R, CGG21-L, CGG21-R, CGG22-L, CGG22-R, CGG61-L, CGG61-R, CGG62-L, CGG62-R, CPE60, CSE11-L, CSE11-R, CSE11-R-DG, CSE12-L, CSE12-R, CSE12-R-DG, CSE21-L, CSE21-R, CSE21-R-DG, CSE22-L, CSE22-R, CSE22-R-DG, CSE61-L, CSE61-R, CSE61-R-DG, CSE62-L, CSE62-R, CSE62-R-DG, CSG11-L, CSG11-R, CSG11-R-DG, CSG12-L, CSG12-R, CSG12-R-DG, CSG21-L, CSG21-R...(Other models you can see in the webshop)		



1

Part No.	699363	Ref. No.	204423
description	flange for combi-steamer ED ϕ 57mm int. ϕ 1 24mm int. ϕ 2 19mm thickness 7mm SS		
For models:	CGE11-L, CGE11-R, CGE12-L, CGE12-R, CGE21-L, CGE21-R, CGE22-L, CGE22-R, CGE61-L, CGE61-R, CGE62-L, CGE62-R, CGG11-L, CGG11-R, CGG12-L, CGG12-R, CGG21-L, CGG21-R, CGG22-L, CGG22-R, CGG61-L, CGG61-R, CGG62-L, CGG62-R, CSE11-L, CSE11-R, CSE11-R-DG, CSE12-L, CSE12-R, CSE12-R-DG, CSE21-L, CSE21-R, CSE21-R-DG, CSE22-L, CSE22-R, CSE22-R-DG, CSE61-L, CSE61-R, CSE61-R-DG, CSE62-L, CSE62-R, CSE62-R-DG, CSG11-L, CSG11-R, CSG11-R-DG, CSG12-L, CSG12-R, CSG12-R-DG, CSG21-L, CSG21-R...(Other models you can see in the webshop)		



1

Part No.	699360	Ref. No.	945661
description	flange for combi-steamer int. ϕ 1 22mm int. ϕ 2 8.5mm thickness 4mm SS L 53mm W 50mm M4		
For models:	CCE60, CCE63, CGE11-L, CGE11-R, CGE12-L, CGE12-R, CGE21-L, CGE21-R, CGE22-L, CGE22-R, CGE61-L, CGE61-R, CGE62-L, CGE62-R, CGG11-L, CGG11-R, CGG12-L, CGG12-R, CGG21-L, CGG21-R, CGG22-L, CGG22-R, CGG61-L, CGG61-R, CGG62-L, CGG62-R, CPE60, CPE63, CSE11-L, CSE11-R, CSE11-R-DG, CSE12-L, CSE12-R, CSE12-R-DG, CSE21-L, CSE21-R, CSE21-R-DG, CSE22-L, CSE22-R, CSE22-R-DG, CSE61-L, CSE61-R, CSE61-R-DG, CSE62-L, CSE62-R, CSE62-R-DG, CSG11-L, CSG11-R, CSG11-R-DG, CSG12-L...(Other models you can see in the webshop)		

radial fans



1

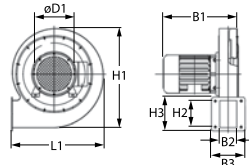

Part No.	601181	Ref. No.	203994
description	radial fan 230V voltage AC 50Hz 100W H1 170mm L1 175mm D1 ϕ 50mm W1 115mm W2 40mm H2 45mm		
For models:	1462831-00, 1462832-00, 1462833-00, 1462834-00, 1462835-00, 1462836-00, 1462837-00, 1462838-00, 1462839-00, 1462840-00, 1462908-00, 1462910-00, 2062831-00, 2062832-00, 2062833-00, 2062834-00, 2062835-00, 2062835-01, 2062836-00, 2062836-01, 2062837-00, 2062837-01, 2062838-00, 2062838-01, 2062839-00, 2062839-01, 2062840-00, 2062840-01, 2062908-00, 2062910-00, 2162835-00, 2162835-01, 2162838-00, 2162838-01, 3062831-00, 3062832-00, 3062833-00, 3062834-00, 3062835-00, 3062836-00, 3062837-00, 3062838-00, 3062839-00, 3062840-00, 3062908-00, 3062910-00, CGG11-L, CGG11-R, CGG12-L, CGG12-R...(Other models you can see in the webshop)		

miscellaneous



1

Part No.	601475	Ref. No.	203926
description	radial fan 230V voltage AC 50/60Hz 20W H1 180mm L1 180mm D1 ϕ 86mm W1 40mm W2 34mm H2 122mm W3 40mm H3 172mm		
For models:	1424833-01, 1424834-01, 1424835-01, 1424836-01, 2023210-01, 2023211-01, CGE11-L, CGE11-R, CGE12-L, CGE12-R, CGE21-L, CGE21-R, CGE22-L, CGE22-R, CGE61-L, CGE61-R, CGE62-L, CGE62-R, CGG11-L, CGG11-R, CGG12-L, CGG12-R, CGG21-L, CGG21-R, CGG22-L, CGG22-R, CGG61-L, CGG61-R, CGG62-L, CGG62-R, CSE11-L, CSE11-R, CSE11-R-DG, CSE12-L, CSE12-R, CSE12-R-DG, CSE21-L, CSE21-R, CSE21-R-DG, CSE22-L, CSE22-R, CSE22-R-DG, CSE61-L, CSE61-R, CSE61-R-DG, CSE62-L, CSE62-R, CSE62-R-DG, CSG11-L, CSG11-R...(Other models you can see in the webshop)		

accessories universal

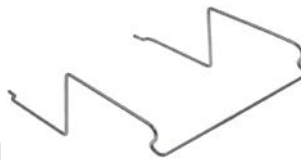

1

Part No.	521183	Ref. No.	204607
description	support bracket L 125mm W 105mm fan for HDECOD61		
For models:	CSE11-L, CSE11-R, CSE11-R-DG, CSE12-L, CSE12-R, CSE12-R-DG, CSE61-L, CSE61-R, CSE61-R-DG, CSE62-L, CSE62-R, CSE62-R-DG, CSG11-L, CSG11-R, CSG11-R-DG, CSG12-L, CSG12-R, CSG12-R-DG, CSG61-L, CSG61-R, CSG61-R-DG, CSG62-L, CSG62-R, CSG62-R-DG		



motors

gear motors

for grills



1			
Part No.	500801	Ref. No.	203039
description	gear motor 230V		
For models:	1220303A00, 1220303A01, 1220303A02, 1220303A03, 1220303C00, 1220303C01, 1220303C02, 1220303C03, 1220303F01, 1220303F02, 1220303F03, 1220303H00, 1220303H01, 1220303H02, 1220303H03, 1220304A00, 1220304A01, 1220304A02, 1220304C00, 1220304C01, 1220304C02, 1220304F00, 1220304F01, 1220304H00, 1220304H01, 1220305A00, 1220305A01, 1220305A02, 1220305A03, 1220305A04, 1220305A05, 1220305C00, 1220305C01, 1220305C02, 1220305C03, 1220305C04, 1220305C05, 1220305F01, 1220305F02, 1220305F03, 1220305F04, 1220305F05, 1220305H00, 1220305H01, 1220305H02, 1220305H03, 1220305H04, 1220305H05, 1220306A00, 1220306A01... (Other models you can see in the webshop)		

spindle motors

miscellaneous

1			
Part No.	500665	Ref. No.	203157
description	spindle motor		
For models:	2020303-00, 2020303-01, 2020303-02		

1			
Part No.	500666	Ref. No.	203388
description	spindle motor		
For models:	2020303-03, 2020303-04		

1			
Part No.	500667	Ref. No.	203144
description	spindle motor		
For models:	2021402-02, 2021402-03, 2021402-04, 2021402-05, 2021402-06, 2021402-07, 2021402-08, 2021402A01, 2021402A02, 2021402A03, 2021402A04, 2021402A06, 2021402A07, 2021402A08, 2021402B01, 2021402B02, 2021402B03, 2021402B04, 2021402B06, 2021402B07, 2021402B08, 2021402C01, 2021402C02, 2021402C03, 2021402C04, 2021402C06, 2021402C07, 2021402C08, 2021404-00, 2021404-01, 2021404-02, 2021404-03, 2021404-04, 2021404-05, 2021404-06, 2021404A-0, 2021404A00, 2021404A01, 2021404A02, 2021404A04, 2021404A05, 2021404A06, 2021404B00, 2021404B01, 2021404B02, 2021404B04, 2021404B05, 2021404B06, 2021404C00, 2021404C01... (Other models you can see in the webshop)		

1			
Part No.	500668	Ref. No.	203147
description	spindle motor		
For models:	2021402-00, 2021402-01, 2021402A00, 2021402B00, 2021402C00, 2061402-00, 2061402-01, 2061402A00, 2061402B00, 2061402C00		

pumps

drain pumps

HANNING



1			
Part No.	499302	Ref. No.	203788
description	drain pump inlet ø 24mm outlet ø 24mm 220-240V 30W 50Hz HANNING type DPS25-303		
For models:	CPE63		



magnetic-drive pumps



1

Part No.	500696	Ref. No.	203825
description	magnetic-drive pump HANNING type DP040-025 30W 230V 50Hz inlet ø 24mm outlet ø 11mm L 130mm		
For models:	CCE60, CCE63, CGE11-L, CGE11-R, CGE12-L, CGE12-R, CGE21-L, CGE21-R, CGE22-L, CGE22-R, CGE61-L, CGE61-R, CGE62-L, CGE62-R, CGG11-L, CGG11-R, CGG12-L, CGG12-R, CGG21-L, CGG21-R, CGG22-L, CGG22-R, CGG61-L, CGG61-R, CGG62-L, CGG62-R, CPE60, CPE63, CSE11-L, CSE11-R, CSE11-R-DG, CSE12-L, CSE12-R, CSE12-R-DG, CSE21-L, CSE21-R, CSE21-R-DG, CSE22-L, CSE22-R, CSE22-R-DG, CSE61-L, CSE61-R, CSE61-R-DG, CSE62-L, CSE62-R, CSE62-R-DG, CSG11-L, CSG11-R, CSG11-R-DG, CSG12-L...(Other models you can see in the webshop)		



1

Part No.	499303	Ref. No.	203826
description	magnetic-drive pump HANNING type DP040-028 65W 208-240V 60Hz inlet ø 24mm outlet ø 11mm L 140mm		
For models:	CCE60, CCE63, CGE11-L, CGE11-R, CGE12-L, CGE12-R, CGE21-L, CGE21-R, CGE22-L, CGE22-R, CGE61-L, CGE61-R, CGE62-L, CGE62-R, CGG11-L, CGG11-R, CGG12-L, CGG12-R, CGG21-L, CGG21-R, CGG22-L, CGG22-R, CGG61-L, CGG61-R, CGG62-L, CGG62-R, CPE60, CPE63, CSE11-L, CSE11-R, CSE11-R-DG, CSE12-L, CSE12-R, CSE12-R-DG, CSE21-L, CSE21-R, CSE21-R-DG, CSE22-L, CSE22-R, CSE22-R-DG, CSE61-L, CSE61-R, CSE61-R-DG, CSE62-L, CSE62-R, CSE62-R-DG, CSG11-L, CSG11-R, CSG11-R-DG, CSG12-L...(Other models you can see in the webshop)		

condensators & interference suppression filters

operating capacitors

plastic



1

Part No.	365031	Ref. No.	202742
description	operating capacitor capacity 4µF 450V tolerance 5% 50/60Hz ambient temperature max. -25 to +85°C ø 31mm L 58mm M8 plastic connection male faston 6.3mm protection		
For models:	CCE60, CCE63, CPE60, CPE63		

filters

RC circuits



1

Part No.	381485	Ref. No.	203743
description	RC circuit type LA4DA2U 110-240V Qty 1 pcs		
For models:	CGE21-L, CGE21-R, CGE22-L, CGE22-R, CSE21-L, CSE21-R, CSE21-R-DG, CSE22-L, CSE22-R, CSE22-R-DG		



1

Part No.	380049	Ref. No.	203683
description	RC circuit type LAD4RCU 110-250V		
For models:	0720332R00, 0720332V00, 1220329B00, 1220329B01, 1320329B00, 1320329B01, 1320329C01, 1320329C02, 1420329B00, 1420329B01, 1420329C00, 1420329C01, 1422701-02, 1422701-03, 1422702-02, 1422702-03, 1422703-01, 1422703-02, 1422704-01, 1422704-02, 1422705-01, 1422705-02, 1422706-01, 1422706-02, 1422707-01, 1422707-02, 1422708-01, 1422708-02, 1423901-00, 1423901-01, 1423901-02, 1423902-00, 1423902-01, 1423902-02, 1423903-00, 1423903-01, 1423903-02, 1424101-01, 1424102-01, 1424103-00, 1424104-00, 2012828-00, 2012828-01, 2012828-02, 2012828-03, 2012828-04, 2012828-05, 2020329B01, 2020329B02, 2020329C01...		

(Other models you can see in the webshop)

fuses

fine fuses



1

Part No.	358598	Ref. No.	202776
description	fine fuse size ø5x20mm 0.63A slow-acting rated 250V Qty 10 pcs		
For models:	0720332R00, 0720332V00		





1

Part No.	358599	Ref. No.	203720
description	fine fuse size ø5x20mm 0.8A slow-acting rated 250V Qty 10 pcs		
For models:	0521702B03, 0521702B04, 2022828-01, 2022828-02, 2022828-03, 2022828-04, 2022828-05, 2022828-06, 3022828-03, 3022828-04, 3022828-05, 3022828-06, 3022828-07, CGE11-L, CGE11-R, CGE12-L, CGE12-R, CGE21-L, CGE21-R, CGE22-L, CGE22-R, CGE61-L, CGE61-R, CGE62-L, CGE62-R, CPE63, CSE11-L, CSE11-R, CSE12-L, CSE12-R, CSE21-L, CSE21-R, CSE22-L, CSE22-R, CSE61-L, CSE61-R, CSE62-L, CSE62-R		



			
1			
Part No.	358601	Ref. No.	203722
description	fine fuse size ø5x20mm 1.25A slow-acting rated 250V Qty 10 pcs		
For models:	CCE60, CCE63, CGE12-L, CGE12-R, CGE62-L, CGE62-R, CGG11-L, CGG11-R, CGG12-L, CGG12-R, CGG21-L, CGG21-R, CGG22-L, CGG22-R, CGG61-L, CGG61-R, CGG62-L, CGG62-R, CPE60, CPE63, CSE12-L, CSE12-R, CSE62-L, CSE62-R, CSG11-L, CSG11-R, CSG11-R-DG, CSG12-L, CSG12-R, CSG12-R-DG, CSG21-L, CSG21-R, CSG21-R-DG, CSG22-L, CSG22-R, CSG22-R-DG, CSG61-L, CSG61-R, CSG61-R-DG, CSG62-L, CSG62-R, CSG62-R-DG		

			
1			
Part No.	358607	Ref. No.	203473
description	fine fuse size ø5x20mm 6.3A slow-acting rated 250V Qty 10 pcs		
For models:	1422701-01, 1422701-02, 1422701-03, 1422702-01, 1422702-02, 1422702-03, 1422802B04, 1422802B05, 1422802B06, 1422802B07, 1422802B08, 1422804B04, 1422804B05, 1422804B06, 1422804B07, 1422804B08, 1422805B04, 1422805B05, 1422805B06, 1422805B07, 1422805B08, 1422807B00, 1422807B01, 1422807B02, 1422807B03, 1422807B04, 1422902-00, 1422902-01, 1422902-02, 1422902-03, 1422902-04, 2013004B01, 2013004B02, 2013004B03, 2013004B04, 2013004B05, 2013008B01, 2013008B02, 2013008B03, 2013008B04, 2013008B05, 2013010B01, 2013010B02, 2013010B03, 2013010B04, 2013010B05, 2013018B00, 2013018B01, 2013018B02, 2013018B03... (Other models you can see in the webshop)		

			
1			
Part No.	358608	Ref. No.	203996
description	fine fuse size ø5x20mm 10A slow-acting rated 250V Qty 10 pcs		
For models:	CGE11-L, CGE11-R, CGE12-L, CGE12-R, CGE21-L, CGE21-R, CGE22-L, CGE22-R, CGE61-L, CGE61-R, CGE62-L, CGE62-R, CGG11-L, CGG11-R, CGG12-L, CGG12-R, CGG21-L, CGG21-R, CGG22-L, CGG22-R, CGG61-L, CGG61-R, CGG62-L, CGG62-R, CPE63, CSE11-L, CSE11-R, CSE11-R-DG, CSE12-L, CSE12-R, CSE12-R-DG, CSE21-L, CSE21-R, CSE21-R-DG, CSE22-L, CSE22-R, CSE22-R-DG, CSE61-L, CSE61-R, CSE61-R-DG, CSE62-L, CSE62-R, CSE62-R-DG, CSG11-L, CSG11-R, CSG11-R-DG, CSG12-L, CSG12-R, CSG12-R-DG, CSG21-L... (Other models you can see in the webshop)		

			
1			
Part No.	358704	Ref. No.	203741
description	fine fuse size ø5x20mm 8A slow-acting rated 250V Qty 10 pcs		

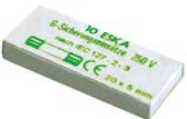
			
1			
Part No.	358603	Ref. No.	203474
description	fine fuse size ø5x20mm 2A slow-acting rated 250V Qty 10 pcs		
For models:	0220302A00, 0220302A01, 0220302A02, 0220302A03, 0220302C00, 0220302C01, 0220302C02, 0220302C03, 0220303A00, 0220303A01, 0220303A02, 0220303A03, 0220303B00, 0220303B01, 0220303C00, 0220303C01, 0220303C02, 0220303E00, 0220303E01, 0220304-00, 0220305-00, 0220306-00, 0221501-00, 0221502-00, 0720332P00, 0720332R00, 0720332T00, 0720332V00, 1220307-00, 1220307-01, 1220308-00, 1220326-00, 1220326-01, 1220326B00, 1220326B01, 1220327-00, 1220327-01, 1220327B01, 1220329-00, 1220329-01, 1220329B00, 1220329B01, 1221112-00, 1320323-00, 1320323B00, 1320327-00, 1320327A00, 1320327A01, 1320327A02, 1320327B00... (Other models you can see in the webshop)		

fine fuse holders

			
1			
Part No.	551378	Ref. No.	203635
description	fuse holder for USIG suitable fuse 5x20/5x25/5x30 1-pole 6.3A rated 400V L 45.4mm W 9.9mm H 32mm connection plug-in connection Phönix Control ST-SI		
For models:	0220302A00, 0220302A01, 0220302A02, 0220302A03, 0220302C00, 0220302C01, 0220302C02, 0220302C03, 0220302H00, 0220302H01, 0220303A00, 0220303A01, 0220303A02, 0220303A03, 0220303C00, 0220303C01, 0220303C02, 0220303H00, 0220303H01, 0220304-00, 0220305-00, 0220306-00, 0221501-00, 0221502-00, 0521702B03, 0521702B04, 0720332P00, 0720332R00, 0720332T00, 0720332V00, 1220307-00, 1220307-01, 1220308-00, 1220326-00, 1220326-01, 1220326B00, 1220326B01, 1220327-00, 1220327-01, 1220327B01, 1220329-00, 1220329-01, 1220329B00, 1220329B01, 1221112-00, 1320323-00, 1320323B00, 1320327-00, 1320327A00, 1320327A01... (Other models you can see in the webshop)		

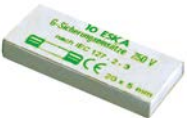
			
1			
Part No.	358605	Ref. No.	203742
description	fine fuse size ø5x20mm 3.15A slow-acting rated 250V Qty 10 pcs		

screw locks

D0-system (NEOZED)

			
1			
Part No.	358045	Ref. No.	203739
description	fuse size D02 35A rated 250/400V E18 ø 15mm L 36mm Qty 10 pcs		
For models:	CGE21-L, CGE21-R, CGG11-L, CGG11-R, CGG12-L, CGG12-R, CGG61-L, CGG61-R, CSE12-L, CSE12-R, CSE12-R-DG, CSE21-L, CSE21-R, CSE21-R-DG, CSG11-L, CSG11-R, CSG11-R-DG		



electric accessories

plugs - couplings - power sockets

CEE plugs with cable



Part No.	551433	Ref. No.	203830
description	connecting cable CEE 5-pole contacts 3P+N+E max. 63A max 415V 16mm ² 4.25m straight protection IP67 for combi-steamer		
For models:	CGE11-L, CGE11-R, CGE12-L, CGE12-R, CGE61-L, CGE61-R, CGE62-L, CGE62-R, CGG11-L, CGG11-R, CGG12-L, CGG12-R, CGG61-L, CGG61-R, CGG62-L, CGG62-R		

cables

accessories

cable glands

cable glands



Part No.	551448	Ref. No.	203452
description	cable gland mounting ø 20.6mm plastic Qty 1 pcs		
For models:	0522101-00, 0522101-01, 0522101-02, 0522101-03, 0522101-04, 0522102-00, 0522102-01, 0522102-02, 0522102-03, 0522102-04, 1303701-01, 1303702-01, 1303703-01, 1303704-00, 1303705-00, 1320301D02, 1320301E02, 1320303D03, 1320303E03, 1320303F03, 1320303F04, 1320303H03, 1320303H04, 1320304F03, 1320304F04, 1320304H03, 1320304H04, 1320305D04, 1320305D05, 1320305E04, 1320305E05, 1320305F04, 1320305F05, 1320305F06, 1320305H04, 1320305H05, 1320305H06, 1320306F04, 1320306F05, 1320306F06, 1320306H04, 1320306H05, 1320306H06, 1320321-00, 1320321-01, 1320321-02, 1320321B00, 1320321B01, 1320321B02, 1320323-00... (Other models you can see in the webshop)		

ribbon cables

group 2



Part No.	551411	Ref. No.	203916
description	connection cable 8-pole L 1000mm plug type RJ45		
For models:	0723104-03, 0723104A03, 0723104B03, 0723105-03, 0723105A03, 0723105B03, 1023101-00, 1023101-01, 1023106-00, 1023106-01, 1223101-00, 1223101-01, 1223101-02, 1223103-00, 1223103-01, 1223103-02, 1223106-00, 1223106-01, 1223106-02, 1223111-00, 1223203-03, 1223211-01, 1323101-01, 1323101-02, 1323103-01, 1323103-02, 1323106-00, 1423101-00, 1423101-01, 1423101-02, 1423101A00, 1423101A01, 1423103-00, 1423103-01, 1423103-02, 1423103A00, 1423103A01, 1423104-00, 1423104-01, 1423104-02, 1423104-03, 1423104A00, 1423104A01, 1423104A03, 1423104B03, 1423105-00, 1423105-01, 1423105-02, 1423105-03, 1423105A00... (Other models you can see in the webshop)		

group 11



Part No.	551353	Ref. No.	033047
description	ribbon cable 40-pole L 60mm		

connection cables

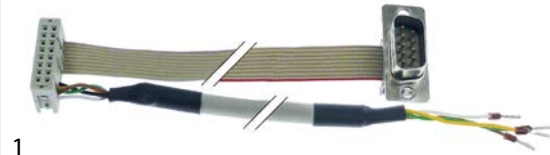

Part No.	579003	Ref. No.	033057
description	connection cable L 1030mm 13-pole for USB		
For models:	CGE21-L, CGE21-R, CGE22-L, CGE22-R, CGE61-L, CGE61-R, CGE62-L, CGE62-R, CGG21-L, CGG21-R, CGG22-L, CGG22-R, CGG61-L, CGG61-R, CGG62-L, CGG62-R		

terminals and connectors

insulated

inline splice connectors





Part No.	550158	Ref. No.	203080
description	butt splice connector 0.5-1.5mm ² Cu gal Sn insulation PVC red t.max. 75°C Qty 100 pcs		
For models:	0220302H00, 0220302H01, 0220303H00, 0220303H01, 0520303-02, 0521704-04, 0521704-05, 0521704-06, 0521704-07, 1423502-00, 1423502-01, 1423502-02, 1423502A00, 1423502A01, 1423502A02, 1423505-00, 1423505-01, 1423505A00, 1423505A01, 1424815-04, 1424815A04, 1424817-00, 1424817A00, 2020314-01, 2020314-02, 2020314-03, 2020314A01, 2020314A02, 2020314A03, 2020315-01, 2020315-02, 2020315-03, 2020315A01, 2020315A02, 2020315A03, 2020341-00, 2020341A00, 2020342-00, 2020342A00, 2020406A01, 2023502-05, 2023502-06, 2023502A05, 2023502A06, 2023503-07, 2023503-11, 2023503-12, 2023503A07, 2023503A11, 2023503A12... (Other models you can see in the webshop)		



not insulated			
female fastons			
iron nickel-plated			
			
1			
Part No.	550001	Ref. No.	203089
description	female faston size 6.3x0.8mm 1.0-2.5mm ² straight Fe gal Ni t.max. 340°C Qty 100 pcs		
For models:	0220302A00, 0220302A01, 0220302A02, 0220302A03, 0220302C00, 0220302C01, 0220302C02, 0220302C03, 0220303A00, 0220303A01, 0220303A02, 0220303A03, 0220303C00, 0220303C01, 0220303C02, 0220304-00, 0220305-00, 0220306-00, 1423901-00, 1423901-01, 1423901-02, 1423902-00, 1423902-01, 1423902-02, 1423903-00, 1423903-01, 1423903-02, 1462802B00, 1462802B01, 1462802B02, 1462802B03, 1462802B04, 1462802B05, 1462804B00, 1462804B01, 1462804B02, 1462804B03, 1462804B04, 1462804B05, 1462831-00, 1462832-00, 1462835-00, 1462836-00, 1462837-00, 1462908-00, 2013901-00, 2013901-01, 2013901-02, 2013901-03, 2013902-00... (Other models you can see in the webshop)		

plug connectors			
			
1			
Part No.	551450	Ref. No.	203732
description	plug connector 4-pole male faston 6.3mm L 52mm		
For models:	CGE11-L, CGE11-R, CGE12-L, CGE12-R, CGE21-L, CGE21-R, CGE22-L, CGE22-R, CGE61-L, CGE61-R, CGE62-L, CGE62-R, CGG11-L, CGG11-R, CGG12-L, CGG12-R, CGG21-L, CGG21-R, CGG22-L, CGG22-R, CGG61-L, CGG61-R, CGG62-L, CGG62-R, CSE11-L, CSE11-R, CSE12-L, CSE12-R, CSE21-L, CSE21-R, CSE21-R-DG, CSE22-L, CSE22-R, CSE22-R-DG, CSG11-L, CSG11-R, CSG11-R-DG, CSG12-L, CSG12-R, CSG12-R-DG, CSG21-L, CSG21-R, CSG21-R-DG, CSG22-L, CSG22-R, CSG22-R-DG, CSG61-L, CSG61-R, CSG61-R-DG, CSG62-L... (Other models you can see in the webshop)		

			
1			
Part No.	551452	Ref. No.	203731
description	plug connector 4-pole male faston 6.3mm L 54mm		
For models:	CCE60, CCE63, CGE11-L, CGE11-R, CGE12-L, CGE12-R, CGE21-L, CGE21-R, CGE22-L, CGE22-R, CGE61-L, CGE61-R, CGE62-L, CGE62-R, CGG11-L, CGG11-R, CGG12-L, CGG12-R, CGG21-L, CGG21-R, CGG22-L, CGG22-R, CGG61-L, CGG61-R, CGG62-L, CGG62-R, CPE60, CPE63, CSE11-L, CSE11-R, CSE11-R-DG, CSE12-L, CSE12-R, CSE12-R-DG, CSE21-L, CSE21-R, CSE21-R-DG, CSE22-L, CSE22-R, CSE22-R-DG, CSE61-L, CSE61-R, CSE61-R-DG, CSE62-L, CSE62-R, CSE62-R-DG, CSG11-L, CSG11-R, CSG11-R-DG, CSG12-L... (Other models you can see in the webshop)		

			
1			
Part No.	551354	Ref. No.	202689
description	plug connector 50-pole raster size 2mm		
For models:	CCE60, CCE63, CPE60, CPE63, CSE11-L, CSE11-R, CSE11-R-DG, CSE12-L, CSE12-R, CSE12-R-DG, CSE21-L, CSE21-R, CSE21-R-DG, CSE22-L, CSE22-R, CSE22-R-DG, CSE61-L, CSE61-R, CSE61-R-DG, CSE62-L, CSE62-R, CSE62-R-DG, CSG11-L, CSG11-R, CSG11-R-DG, CSG12-L, CSG12-R, CSG12-R-DG, CSG21-L, CSG21-R, CSG21-R-DG, CSG22-L, CSG22-R, CSG22-R-DG, CSG61-L, CSG61-R, CSG61-R-DG, CSG62-L, CSG62-R, CSG62-R-DG		

terminals			
connection terminals with screw/faston connections			
			
1			
Part No.	551372	Ref. No.	203287
description	connection terminal 3-pole max. 16A max 400V connection ø2.5mm ² / F6.3 temp.-resist. 150°C		
For models:	0521704-00, 0521704-01, 0521704-02, 0521704-03, 0521704-04, 0521704-05, 0521704-06, 0521704-07, 0521704A00, 0521704A01, 0521705-00, 0521705-01, 0521706-00, 1220501-00, 1220501-01, 1220501-02, 1220502-00, 1220502-01, 1220601-00, 1220802-00, 1220802-01, 1320501-00, 1320502-00, 1320601-00, 1320802-00, 1520501-00, 1520601-00		

			
1			
Part No.	550110	Ref. No.	203264
description	power terminal block 5-pole max. 40A max 250V connection M6/ male faston 6.3mm temp.-resist. 130°C		
For models:	0021130A00, 0021130A01, 0021135A00, 0220301-00, 0220301B00, 0220301B01, 0220301B02, 0220301D00, 0220302-00, 0220302A00, 0220302A01, 0220302A02, 0220302A03, 0220302B00, 0220302B01, 0220302B02, 0220302C00, 0220302C01, 0220302C02, 0220302C03, 0220302D00, 0220302E00, 0220302E01, 0220302F00, 0220302H00, 0220302H01, 0220303-00, 0220303-01, 0220303A00, 0220303A01, 0220303A02, 0220303A03, 0220303D00, 0220303D01, 0220303H00, 0220303H01, 0220304-00, 0220305-00, 0220306-00, 0220501-00, 0220502-00, 0220503-00, 0220601-00, 0220802-00, 0221001H00, 0221101-00, 0221101-01, 0221101A00, 0221101A01, 0221102-00... (Other models you can see in the webshop)		

PCB terminal blocks			
			
1			
Part No.	551355	Ref. No.	203690
description	PCB terminal block 5-pole raster size 3.8mm cross section 1.5mm ²		
For models:	CGE11-L, CGE11-R, CGE12-L, CGE12-R, CGE21-L, CGE21-R, CGE22-L, CGE22-R, CGE61-L, CGE61-R, CGE62-L, CGE62-R, CGG11-L, CGG11-R, CGG12-L, CGG12-R, CGG21-L, CGG21-R, CGG22-L, CGG22-R, CGG61-L, CGG61-R, CGG62-L, CGG62-R, CPE60, CPE63, CSE11-L, CSE11-R, CSE11-R-DG, CSE12-L, CSE12-R, CSE12-R-DG, CSE21-L, CSE21-R, CSE21-R-DG, CSE22-L, CSE22-R, CSE22-R-DG, CSE61-L, CSE61-R, CSE61-R-DG, CSE62-L, CSE62-R, CSE62-R-DG, CSG11-L, CSG11-R, CSG11-R-DG, CSG12-L, CSG12-R, CSG12-R-DG... (Other models you can see in the webshop)		



rail-mounted terminals

WIELAND

accessories



Part No.	550370	Ref. No.	203273
description	terminal block end bracket clampsmm ²		
For models:	0220302H00, 0220302H01, 0220303H00, 0220303H01, 0720332R00, 0720332V00, 1220305B00, 1220305B01, 1220305B02, 1220305B03, 1220305B04, 1220305B05, 1220305B06, 1220305B07, 1220305C00, 1220305C01, 1220305C02, 1220305C03, 1220305C04, 1220305C05, 1220305E02, 1220305E03, 1220305E04, 1220305H00, 1220305H01, 1220305H02, 1220305H03, 1220305H04, 1220305H05, 1220327-01, 1220327B01, 1220329-00, 1220329-01, 1220329B00, 1220329B01, 1223205-00, 1223205-01, 1223205-02, 1223211-00, 1320305B00, 1320305B01, 1320305B02, 1320305B03, 1320305C00, 1320305C01, 1320305C02, 1320305C03, 1320305E02, 1320305E03, 1320305H00... (Other models you can see in the webshop)		

miscellaneous



Part No.	551377	Ref. No.	203634
description	fuse holder Phönix Control type USIG 0.5-16mm ² DIN rail black W 10.2mm L 61mm for fuse holder 10A rated 500V		
For models:	0220302A00, 0220302A01, 0220302A02, 0220302A03, 0220302C00, 0220302C01, 0220302C02, 0220302C03, 0220302H00, 0220302H01, 0220303A00, 0220303A01, 0220303A02, 0220303A03, 0220303C00, 0220303C01, 0220303C02, 0220303H00, 0220303H01, 0220304-00, 0220305-00, 0220306-00, 0221501-00, 0221502-00, 0521702B03, 0521702B04, 0720332P00, 0720332R00, 0720332T00, 0720332V00, 1220307-00, 1220307-01, 1220308-00, 1220326-00, 1220326-01, 1220326B00, 1220326B01, 1220327-00, 1220327-01, 1220327B01, 1220329-00, 1220329-01, 1220329B00, 1220329B01, 1221112-00, 1320323-00, 1320323B00, 1320327-00, 1320327A00, 1320327A01... (Other models you can see in the webshop)		



Part No.	551356	Ref. No.	203271
description	rail-mounted terminal Phönix Control type UK10 6-10mm ² W 8mm L 43mm max. 50A max 500V		
For models:	0220303B00, 0220303B01, 0220303C00, 0220303C01, 0220303C02, 0220303E00, 0220303E01, 0220306-00, 0521702B03, 0521702B04, 0720332P00, 0720332R00, 0720332T00, 0720332V00, 1120510-00, 1120510-01, 1220307-00, 1220307-01, 1220308-00, 1220326-00, 1220326-01, 1220326B00, 1220326B01, 1220503-00, 1221112-00, 1223204-00, 1223204-01, 1223204-02, 1223205-00, 1223205-01, 1223205-02, 1223206-00, 1223206-01, 1223206-02, 1223211-00, 1223212-00, 1223214-00, 1323211-00, 1323211-01, 1420332P01, 1420332P02, 1420332P03, 1420332R00, 1420332R01, 1420332R02, 1420332R03, 1420332T01, 1420332T02, 1420332T03, 1420332V01... (Other models you can see in the webshop)		

1

Part No.		Ref. No.	203620
description	rail-mounted terminal Phönix Control type UK16 0.5-16mm ² top-hat rail 35mm grey W 10.2mm L 42.5mm		
For models:	0221502-00, 0720332P00, 0720332R00, 0720332T00, 0720332V00, 1420332P01, 1420332P02, 1420332P03, 1420332R00, 1420332R01, 1420332R02, 1420332R03, 1420332T01, 1420332T02, 1420332T03, 1420332V01, 1420332V02, 1420332V03, 1420333P01, 1420333P02, 1420333R00, 1420333R01, 1420333R02, 1420333T01, 1420333T02, 1420333V01, 1420333V02, 1420334P00, 1420334P01, 1420334P02, 1420334P03, 1420334P04, 1420334R02, 1420334R03, 1420334R04, 1420334T02, 1420334T03, 1420334T04, 1420334V01, 1420334V02, 1420334V03, 1420334V04, 1420334W02, 1420334W03, 1420334W04, 1420334Y02, 1420334Y03, 1420334Y04, 1420344R00, 1420344R01... (Other models you can see in the webshop)		





Part No.	551375	Ref. No.	203622
description	rail-mounted terminal Phönix Control type UK35 0.75-35mm ² DIN rail grey W 15.1mm L 62mm		
For models:	1422802B04, 1422802B05, 1422802B06, 1422802B07, 1422802B08, 1422804B04, 1422804B05, 1422804B06, 1422804B07, 1422804B08, 1422805B04, 1422805B05, 1422805B06, 1422805B07, 1422805B08, 1422807B00, 1422807B01, 1422807B02, 1422807B03, 1422807B04, 1422902-00, 1422902-01, 1422902-02, 1422902-03, 1422902-04, 2020308-00, 2020314-01, 2020314A01, 2020315-01, 2020315A01, 2021123A00, 2021411-00, 2021412C00, 2021413-00, 2021413B00, 2021415B00, 2021416B00, 2021417-00, 2021417B00, 2021418B00, 2021419-00, 2021419B00, 2022801-02, 2022801-03, 2022801A02, 2022801A03, 2022801B02, 2022801B03, 2022801C02, 2022801C03... (Other models you can see in the webshop)		



Part No.	551371	Ref. No.	203279
description	rail-mounted terminal Phönix Control type USLKG10 0.5-10mm ² yellow/green for DIN rail 35mm H 45mm 1-pole		
For models:	0220303B00, 0220303B01, 0220303C00, 0220303C01, 0220303C02, 0220303E00, 0220303E01, 0220306-00, 0521702B03, 0521702B04, 0720332P00, 0720332R00, 0720332T00, 0720332V00, 1120510-00, 1120510-01, 1220303A00, 1220303A01, 1220303A02, 1220303C00, 1220303C01, 1220303C02, 1220303F01, 1220303F02, 1220303F03, 1220303H00, 1220303H01, 1220303H02, 1220303H03, 1220305A00, 1220305A01, 1220305A02, 1220305A03, 1220305A04, 1220305A05, 1220305B03, 1220305B04, 1220305B05, 1220305B06, 1220305B07, 1220305C04, 1220305C05, 1220305E03, 1220305E04, 1220305F01, 1220305F02, 1220305F03, 1220305F04, 1220305F05, 1220305K00... (Other models you can see in the webshop)		



			
1			
Part No.	551374	Ref. No.	203621
description	rail-mounted terminal Phönix Control type USLKG16 0.5-16mm ² yellow/green W 10.2mm L 42.5mm for DIN rail 35mm H 45mm 1-pole		
For models:	0720332P00, 0720332R00, 0720332T00, 0720332V00, 1420332P01, 1420332P02, 1420332P03, 1420332R00, 1420332R01, 1420332R02, 1420332R03, 1420332T01, 1420332T02, 1420332T03, 1420332V01, 1420332V02, 1420332V03, 1420333P01, 1420333P02, 1420333R00, 1420333R01, 1420333R02, 1420333T01, 1420333T02, 1420333V01, 1420333V02, 1420334P00, 1420334P01, 1420334P02, 1420334P03, 1420334P04, 1420334R02, 1420334R03, 1420334R04, 1420334T02, 1420334T03, 1420334T04, 1420334V01, 1420334V02, 1420334V03, 1420334V04, 1420334W02, 1420334W03, 1420334W04, 1420334Y02, 1420334Y03, 1420334Y04, 1420344R00, 1420344R01, 1420344R02... (Other models you can see in the webshop)		

			
1			
Part No.	551376	Ref. No.	203633
description	rail-mounted terminal Phönix Control type USLKG35 0.75-35mm ² DIN rail yellow/green W 15mm L 50mm for DIN rail 35mm H 62mm 1-pole		
For models:	1422802B04, 1422802B05, 1422802B06, 1422802B07, 1422802B08, 1422804B04, 1422804B05, 1422804B06, 1422804B07, 1422804B08, 1422805B04, 1422805B05, 1422805B06, 1422805B07, 1422805B08, 1422807B00, 1422807B01, 1422807B02, 1422807B03, 1422807B04, 1422902-00, 1422902-01, 1422902-02, 1422902-03, 1422902-04, 2020308-00, 2020314-01, 2020314A01, 2020315-01, 2020315A01, 2021123A00, 2021411-00, 2021412C00, 2021413-00, 2021413B00, 2021415B00, 2021416B00, 2021417-00, 2021417B00, 2021418B00, 2021419-00, 2021419B00, 2022801-02, 2022801-03, 2022801A02, 2022801A03, 2022801B02, 2022801B03, 2022801C02, 2022801C03... (Other models you can see in the webshop)		

electronic magnets

			
1			
Part No.	400793	Ref. No.	203672
description	lifting magnet 205V voltage DC		
For models:	CCE60, CCE63, CGE11-L, CGE11-R, CGE12-L, CGE12-R, CGE21-L, CGE21-R, CGE22-L, CGE22-R, CGE61-L, CGE61-R, CGE62-L, CGE62-R, CGG11-L, CGG11-R, CGG12-L, CGG12-R, CGG21-L, CGG21-R, CGG22-L, CGG22-R, CGG61-L, CGG61-R, CGG62-L, CGG62-R, CPE60, CPE63, CSE11-L, CSE11-R, CSE11-R-DG, CSE12-L, CSE12-R, CSE12-R-DG, CSE21-L, CSE21-R, CSE21-R-DG, CSE22-L, CSE22-R, CSE22-R-DG, CSE61-L, CSE61-R, CSE61-R-DG, CSE62-L, CSE62-R, CSE62-R-DG, CSG11-L, CSG11-R, CSG11-R-DG, CSG12-L... (Other models you can see in the webshop)		

gas taps

PEL

22S/V series























				
1				
Part No.	101457	Ref. No.	201515 Alternativ	
description	gas tap alternatives to JUNKERS type CH110 gas inlet M20x1.5 (tube ø 12mm) bypass nozzle ø 0.35mm gas outlet M20x1.5 (tube ø 12/10mm) thermocouple connection M8x1 pilot connection M10x1 shaft ø 10mm shaft L 25mm shaft flat with pipe outlet			
spare parts for	101457			
	Part No.	100259	Ref. No.	—
	bypass nozzle type PEL22 bore ø 0.35mm thread M6x0.5			
	Part No.	100908	Ref. No.	—
	union screw thread M10x1 for pipe ø 4mm Qty 1 pcs			
	Part No.	101058	Ref. No.	201526
	magnet unit L 39mm D1 ø 15.4mm D2 ø 13.5mm suitable for PEL22/ EGA24197 standard			
	Part No.	101200	Ref. No.	—
	gas tap front part shaft ø 10mm shaft L 25mm shaft flat suitable for 22S/O			
	Part No.	101230	Ref. No.	—
	thermocouple nut T1: M8x1 T2: M18x1 aluminium			
	Part No.	101241	Ref. No.	—
	gas connection thread M20x1.5 tube ø 12/10mm for PEL gas taps vertical			
	Part No.	101246	Ref. No.	—
	olive for pipe ø 4mm Qty 1 pcs			
	Part No.	101460	Ref. No.	—
	O-ring ø 12.37mm D1 ø 2.62mm suitable for PEL22			
	Part No.	101461	Ref. No.	—
	screw kit suitable for PEL22 Qty 4 pcs			
accessories for	101457			
	Part No.	100945	Ref. No.	—
	roll pin ø 3.2mm L 10mm			
	Part No.	101218	Ref. No.	—
	shaft extension JUNKERS			
	Part No.	101219	Ref. No.	—
	shaft extension L 25mm JUNKERS			
	Part No.	101231	Ref. No.	—
	thermocouple nut T1: M9x1 T2: M18x1			
	Part No.	101248	Ref. No.	—
	olive for pipe ø 12mm Qty 1 pcs suitable for PEL			

Table continues overleaf



accessories for		101457	
	Part No.	101249	Ref. No. —
olive for pipe ø 10mm Qty 1 pcs			
	Part No.	101250	Ref. No. —
union nut thread M20x1.5 for pipe ø 10mm			
	Part No.	101251	Ref. No. —
union nut thread M20x1.5 for pipe ø 12mm			
	Part No.	101290	Ref. No. —
thermocouple nut T1: M10x1 T2: M18x1 suitable for PEL20/21			
	Part No.	110064	Ref. No. —
knob			
	Part No.	110066	Ref. No. —
knob screw			
	Part No.	550396	Ref. No. 204109
shaft extension L 25mm JUNKERS			

			
1			
Part No.	101793	Ref. No.	201163
description	gas tap PEL type 225/V gas inlet M20x1.5 (tube ø 12mm) bypass nozzle ø 0.9mm gas outlet M20x1.5 (tube ø 12/10mm) thermocouple connection M8x1 pilot connection M10x1 shaft ø 6x4.6mm shaft L 45/20mm shaft flat upper		
For models:	1261301-02, 1261602-02, 1261602-03, 1261604-03, 1263405-01, 1361301-03, 1361602-01, 1361602-02, 1361604-02, 1363405-01, 1461602-00, 1463501-05, 2061301-01, 2061602-00, 2061602-01, 2061603-02, 2061604-01, 2063501-06, 2063502-10, 2063503-07, 3061602-00, 3063501-04		
spare parts for		101793	
	Part No.	100433	Ref. No. 201164
bypass nozzle type PEL22 bore ø 0.9mm thread M6x0.5			
	Part No.	100908	Ref. No. —
union screw thread M10x1 for pipe ø 4mm Qty 1 pcs			
	Part No.	101058	Ref. No. 201526
magnet unit L 39mm D1 ø 15.4mm D2 ø 13.5mm suitable for PEL22/ EGA24197 standard			
	Part No.		Ref. No. —
gas tap spindle for gas tap suitable for PEL22			
	Part No.	101230	Ref. No. —
thermocouple nut T1: M8x1 T2: M18x1 aluminium			
	Part No.	101241	Ref. No. —
gas connection thread M20x1.5 tube ø 12/10mm for PEL gas taps vertical			
	Part No.	101246	Ref. No. —
olive for pipe ø 4mm Qty 1 pcs			







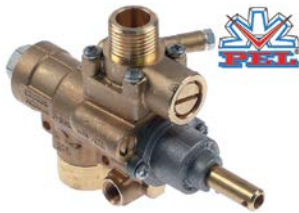





spare parts for		101793	
	Part No.	101460	Ref. No. —
O-ring ø 12.37mm D1 ø 2.62mm suitable for PEL22			
	Part No.	101461	Ref. No. —
screw kit suitable for PEL22 Qty 4 pcs			
accessories for		101793	
	Part No.	100908	Ref. No. —
union screw thread M10x1 for pipe ø 4mm Qty 1 pcs			
	Part No.	100909	Ref. No. —
union screw thread M10x1 for pipe ø 6mm Qty 1 pcs			
	Part No.	101240	Ref. No. —
gas connection thread M20x1.5 tube ø 12/10mm for PEL gas taps with gasket and screws horizontal			
	Part No.	101246	Ref. No. —
olive for pipe ø 4mm Qty 1 pcs			
	Part No.	101248	Ref. No. —
olive for pipe ø 12mm Qty 1 pcs suitable for PEL			
	Part No.	101249	Ref. No. —
olive for pipe ø 10mm Qty 1 pcs			
	Part No.	101250	Ref. No. —
union nut thread M20x1.5 for pipe ø 10mm			
	Part No.	101251	Ref. No. —
union nut thread M20x1.5 for pipe ø 12mm			
	Part No.	101286	Ref. No. 201571
olive ID ø 6mm Qty 1 pcs			



23S/V series



1

Part No.	101630	Ref. No.	201516 201516 Alternativ
description	gas tap PEL type 23S/V gas inlet 1/2" IT bypass nozzle ø 0.35mm gas outlet 1/2" MT (tube ø 14mm) thermocouple connection M10x1 pilot connection M10x1 shaft ø 10mm shaft L 25mm shaft flat		
For models:	1463501-01, 1463501-02, 2061401-00, 2061401-01, 2061401A00, 2061401B00, 2061401C00, 2061402-00, 2061402-01, 2061402A00, 2061402B00, 2061402C00, 2062801-00, 2062801A00, 2062801B00, 2062801C00, 2062802-00, 2062802-0, 20628022-0, 20628022-1, 20628022-2, 2062802A00, 2062802B00, 2062802C00, 2062803-00, 20628033-0, 20628033-1, 20628033-2, 2062803A00, 2062803B00, 2062803C00, 2062804-00, 20628044-0, 20628044-1, 20628044-2, 2062804A00, 2062804B00, 2062804C00, 2062806-00, 2062806A00, 2062806B00, 2062806B01, 2062806B02, 2062806B03, 2062806C00, 2062806C01, 2062806C02, 2062806C03, 20629011-00, 20629011-0, 20629011-1... (Other models you can see in the webshop)		
spare parts for	101630		
	Part No.	100455	Ref. No. —
bypass nozzle type PEL23/24 bore ø 0.35mm thread M8x0.5			
	Part No.	101059	Ref. No. —
magnet unit T1: M10x1 T2: M22x1 L 46mm ø 18mm suitable for PEL23S M10x1			
	Part No.	102767	Ref. No. —
gas tap front part shaft ø 10mm shaft L 26.5mm shaft flat suitable for PEL23S			
accessories for	101630		
	Part No.	100908	Ref. No. —
union screw thread M10x1 for pipe ø 4mm Qty 1 pcs			
	Part No.	100909	Ref. No. —
union screw thread M10x1 for pipe ø 6mm Qty 1 pcs			
	Part No.	100945	Ref. No. —
roll pin ø 3.2mm L 10mm			
	Part No.	101218	Ref. No. —
shaft extension JUNKERS			
	Part No.	101219	Ref. No. —
shaft extension L 25mm JUNKERS			
	Part No.	101246	Ref. No. —
olive for pipe ø 4mm Qty 1 pcs			
	Part No.	101286	Ref. No. 201571
olive ID ø 6mm Qty 1 pcs			
	Part No.	110064	Ref. No. —
knob			
	Part No.	110066	Ref. No. —
knob screw			

accessories for	101630		
	Part No.	550396	Ref. No. 204109
shaft extension L 25mm JUNKERS			

alternatives to EGA

GPEL21 series

with nozzle outlet



1

Part No.	106576	Ref. No.	201137
description	gas tap alternatives to EGA type GPEL21D gas inlet M15x1 (tube ø 10mm) external nozzle ø 1.55mm internal nozzle ø 1.35mm bypass nozzle ø 0.4mm mixing pipe connection thermocouple connection M8x1 pilot connection M10x1 shaft ø 6x4.6mm shaft L 30/23mm shaft flat upper		



1

Part No.	101663	Ref. No.	201148
description	gas tap alternatives to EGA type GPEL21D gas inlet M15x1 (tube ø 10mm) external nozzle ø 2.05mm internal nozzle ø 1.85mm bypass nozzle ø 0.5mm mixing pipe connection thermocouple connection M8x1 pilot connection M10x1 shaft ø 6x4.6mm shaft L 31/23mm shaft flat upper		



















spare parts for	101663		
	Part No.	100060	Ref. No. —
pilot burner JUNKERS type CB505070 2 flames natural gas nozzle no.4 gas connection 4mm with primary air			
	Part No.	100244	Ref. No. 201837
internal nozzle bore ø 1.85mm suitable for EGA 23268,26400,26440			
	Part No.	100303	Ref. No. 201836
gas injector thread M12x1 WS 14 bore ø 2.05mm			
	Part No.	100408	Ref. No. —
bypass nozzle type PEL20/21 bore ø 0.35mm thread M5x0.5			
	Part No.	100908	Ref. No. —
union screw thread M10x1 for pipe ø 4mm Qty 1 pcs			
	Part No.	100926	Ref. No. —
centring piece thread M17x1			
	Part No.	100927	Ref. No. —
torsion spring L 2.8-8.0mm for internal nozzle ø 3mm bore ømm			
	Part No.	100942	Ref. No. —
union nut thread M15x1 for pipe ø 10mm			



Table continues overleaf



















spare parts for		101663	
Part No.	101230	Ref. No.	—
	thermocouple nut T1: M8x1 T2: M18x1 aluminium		
Part No.	101246	Ref. No.	—
	olive for pipe ø 4mm Qty 1 pcs		
Part No.	101278	Ref. No.	—
	olive for pipe ø 10mm Qty 1 pcs		
Part No.	101526	Ref. No.	—
	O-ring Viton thickness 1.78mm ID ø 4.48mm Qty 1 pcs		
Part No.	101593	Ref. No.	—
	adjusting screw for internal nozzle thread M8x0.75		
Part No.	101803	Ref. No.	—
	gas tap front part shaft ø 6x4.6mm shaft L 30/23mm shaft flat upper/lower suitable for PEL21		

accessories for		101663	
Part No.	100909	Ref. No.	—
	union screw thread M10x1 for pipe ø 6mm Qty 1 pcs		
Part No.	100942	Ref. No.	—
	union nut thread M15x1 for pipe ø 10mm		
Part No.	101278	Ref. No.	—
	olive for pipe ø 10mm Qty 1 pcs		
Part No.	101286	Ref. No.	201571
	olive ID ø 6mm Qty 1 pcs		
Part No.	110078	Ref. No.	—
	knob without symbol ø 70mm shaft ø 6x4.6mm shaft flat universal		
Part No.	112206	Ref. No.	—
	knob dial plate silver gas tap PEL21/22/23 t.max.°C ED ø 63mm ID ø 45.5mm		



Part No.	101606	Ref. No.	201742 Alternativ 201743 Alternativ 201830 Alternativ 201835 Alternativ
description	gas tap alternatives to EGA type GPEL21D with nozzle outlet (without nozzle) gas inlet M15x1 (tube ø 10mm) external nozzle ømm internal nozzle ømm bypass nozzle ø 0.35mm mixing pipe connection M17x1 thermocouple connection M8x1 pilot connection M10x1 shaft ø 6x4.6mm shaft L 31/23mm shaft flat upper		
spare parts for		101606	
Part No.	100408	Ref. No.	—
	bypass nozzle type PEL20/21 bore ø 0.35mm thread M5x0.5		
Part No.	100927	Ref. No.	—
	torsion spring L 2.8-8.0mm for internal nozzle ø 3mm bore ømm		







spare parts for		101606	
Part No.	101060	Ref. No.	201527 201531
	magnet unit standard L 39mm D1 ø 15.4mm D2 ø 11mm suitable for PEL20-21/JUNKERS/EGA		
Part No.	101230	Ref. No.	—
	thermocouple nut T1: M8x1 T2: M18x1 aluminium		
Part No.	101526	Ref. No.	—
	O-ring Viton thickness 1.78mm ID ø 4.48mm Qty 1 pcs		
Part No.	101593	Ref. No.	—
	adjusting screw for internal nozzle thread M8x0.75		
Part No.	101803	Ref. No.	—
	gas tap front part shaft ø 6x4.6mm shaft L 30/23mm shaft flat upper/lower suitable for PEL21		





accessories for		101606	
Part No.	100908	Ref. No.	—
	union screw thread M10x1 for pipe ø 4mm Qty 1 pcs		
Part No.	100909	Ref. No.	—
	union screw thread M10x1 for pipe ø 6mm Qty 1 pcs		
Part No.	100926	Ref. No.	—
	centring piece thread M17x1		
Part No.	100927	Ref. No.	—
	torsion spring L 2.8-8.0mm for internal nozzle ø 3mm bore ømm		
Part No.	100942	Ref. No.	—
	union nut thread M15x1 for pipe ø 10mm		
Part No.	100943	Ref. No.	—
	union nut thread M17x1 tube ø 10mm		
Part No.	101246	Ref. No.	—
	olive for pipe ø 4mm Qty 1 pcs		
Part No.	101278	Ref. No.	—
	olive for pipe ø 10mm Qty 1 pcs		
Part No.	101286	Ref. No.	201571
	olive ID ø 6mm Qty 1 pcs		
Part No.	110078	Ref. No.	—
	knob without symbol ø 70mm shaft ø 6x4.6mm shaft flat universal		
Part No.	112206	Ref. No.	—
	knob dial plate silver gas tap PEL21/22/23 t.max.°C ED ø 63mm ID ø 45.5mm		



with pipe outlet

 <p>1</p>			
Part No.	106575	Ref. No.	201136
description	gas tap alternatives to EGA type GPEL21R gas inlet M15x1 (tube ø 10mm) bypass nozzle ø 0.6mm gas outlet M17x1 (tube ø 10mm) thermocouple connection M8x1 pilot connection M10x1 shaft ø 6x4.6mm shaft L 30/23mm shaft flat upper gas outlet M17x1 (tube ø 10mm)mm		

 <p>1</p>			
Part No.	101605	Ref. No.	201737 Alternativ 201755 Alternativ 201760 Alternativ
description	gas tap alternatives to EGA type GPEL21R with pipe outlet gas inlet M15x1 (tube ø 10mm) bypass nozzle ø 0.35mm gas outlet M17x1 (tube ø 10mm) thermocouple connection M8x1 pilot connection M10x1 shaft ø 6x4.6mm shaft L 30/23mm shaft flat upper		
spare parts for	101605		
	Part No.	100408	Ref. No. —
	bypass nozzle type PEL20/21 bore ø 0.35mm thread M5x0.5		
	Part No.	101060	Ref. No. 201527 201531
	magnet unit standard L 39mm D1 ø 15.4mm D2 ø 11mm suitable for PEL20-21/JUNKERS/EGA		
	Part No.	101230	Ref. No. —
	thermocouple nut T1: M8x1 T2: M18x1 aluminium		
	Part No.	101803	Ref. No. —
	gas tap front part shaft ø 6x4.6mm shaft L 30/23mm shaft flat upper/lower suitable for PEL21		
accessories for	101605		
	Part No.	100908	Ref. No. —
	union screw thread M10x1 for pipe ø 4mm Qty 1 pcs		
	Part No.	100909	Ref. No. —
	union screw thread M10x1 for pipe ø 6mm Qty 1 pcs		
	Part No.	100926	Ref. No. —
	centring piece thread M17x1		
	Part No.	100942	Ref. No. —
	union nut thread M15x1 for pipe ø 10mm		
	Part No.	100943	Ref. No. —
	union nut thread M17x1 tube ø 10mm		
	Part No.	101246	Ref. No. —
	olive for pipe ø 4mm Qty 1 pcs		

accessories for	101605		
	Part No.	101278	Ref. No. —
	olive for pipe ø 10mm Qty 1 pcs		
	Part No.	101286	Ref. No. 201571
	olive ID ø 6mm Qty 1 pcs		
	Part No.	110078	Ref. No. —
	knob without symbol ø 70mm shaft ø 6x4.6mm shaft flat universal		
	Part No.	112206	Ref. No. —
	knob dial plate silver gas tap PEL21/22/23 t.max. °C ED ø 63mm ID ø 45.5mm		

GPEL22 series

with nozzle outlet











 <p>1</p>			
Part No.	101622	Ref. No.	201740 Alternativ 201741 Alternativ
description	gas tap alternatives to EGA type PEL22S with nozzle outlet (without nozzle) gas inlet M18x1.5 (tube ø 12mm) external nozzle ømm internal nozzle ømm bypass nozzle ø 0.35mm mixing pipe connection M22x1 thermocouple connection M8x1 pilot connection M10x1 shaft ø 6x4.6mm shaft L 35/21mm shaft flat upper		
spare parts for	101622		
	Part No.	100259	Ref. No. —
	bypass nozzle type PEL22 bore ø 0.35mm thread M6x0.5		
	Part No.	100927	Ref. No. —
	torsion spring L 2.8-8.0mm for internal nozzle ø 3mm bore ømm		
	Part No.	101058	Ref. No. 201526
	magnet unit L 39mm D1 ø 15.4mm D2 ø 13.5mm suitable for PEL22/EGA24197 standard		
	Part No.	101230	Ref. No. —
	thermocouple nut T1: M8x1 T2: M18x1 aluminium		
	Part No.	101460	Ref. No. —
	O-ring ø 12.37mm D1 ø 2.62mm suitable for PEL22		
	Part No.	101527	Ref. No. —
	O-ring Viton thickness 1.78mm ID ø 6.75mm Qty 1 pcs		
	Part No.	101594	Ref. No. —
	adjusting screw for internal nozzle thread M10x0.75		
	Part No.	101823	Ref. No. —
	gas tap front part shaft ø 6x4.6mm shaft L 35/21mm shaft flat upper/lower suitable for PEL22		
accessories for	101622		
	Part No.	100908	Ref. No. —
	union screw thread M10x1 for pipe ø 4mm Qty 1 pcs		

Table continues overleaf



accessories for		101622		
	Part No.	100909	Ref. No.	—
	union screw thread M10x1 for pipe ø 6mm Qty 1 pcs			
	Part No.	100944	Ref. No.	—
	union nut thread M18x1.5 for pipe ø 12mm			
	Part No.	101246	Ref. No.	—
	olive for pipe ø 4mm Qty 1 pcs			
	Part No.	101273	Ref. No.	201594
	olive for pipe ø 12mm L 9.5mm brass Qty 1 pcs suitable for universal			
	Part No.	101286	Ref. No.	201571
	olive ID ø 6mm Qty 1 pcs			
	Part No.	110078	Ref. No.	—
	knob without symbol ø 70mm shaft ø 6x4.6mm shaft flat universal			
	Part No.	112206	Ref. No.	—
	knob dial plate silver gas tap PEL21/22/23 t.max.°C ED ø 63mm ID ø 45.5mm			





with pipe outlet



1

Part No.	106396 ¹	Ref. No.	201786	
description	gas tap type GPEL22R with pipe outlet gas inlet M18x1.5 (tube ø 12mm) bypass nozzle ø 0.35mm gas outlet M18x1.5 (tube ø 12mm) thermocouple connection M8x1 pilot connection M10x1 shaft ø 6x4.6mm shaft L 35/21mm shaft flat upper			
For models:	2063413-02, 2063414-03, 2063415-05, 2063416-02, 2063417-03, 2063418-05, 2063419-02			
spare parts for	106396			
	Part No.	100259	Ref. No.	—
	bypass nozzle type PEL22 bore ø 0.35mm thread M6x0.5			
	Part No.	101058	Ref. No.	201526
	magnet unit L 39mm D1 ø 15.4mm D2 ø 13.5mm suitable for PEL22/ EGA24197 standard			
	Part No.	101230	Ref. No.	—
	thermocouple nut T1: M8x1 T2: M18x1 aluminium			
	Part No.	101823	Ref. No.	—
	gas tap front part shaft ø 6x4.6mm shaft L 35/21mm shaft flat upper/lower suitable for PEL22			
accessories for	106396			
	Part No.	100908	Ref. No.	—
	union screw thread M10x1 for pipe ø 4mm Qty 1 pcs			
	Part No.	100909	Ref. No.	—
	union screw thread M10x1 for pipe ø 6mm Qty 1 pcs			







¹incl. union nuts and olives

accessories for		106396		
	Part No.	100944	Ref. No.	—
	union nut thread M18x1.5 for pipe ø 12mm			
	Part No.	101246	Ref. No.	—
	olive for pipe ø 4mm Qty 1 pcs			
	Part No.	101273	Ref. No.	201594
	olive for pipe ø 12mm L 9.5mm brass Qty 1 pcs suitable for universal			
	Part No.	101286	Ref. No.	201571
	olive ID ø 6mm Qty 1 pcs			

JUNKERS







1

Part No.	nla ¹	Ref. No.	201515	
description	gas tap JUNKERS type CH120 gas inlet M20x1.5 bypass nozzle ø 0.35mm gas outlet M20x1.5 thermocouple connection M8x1 pilot connection M10x1 shaft ø 10mm shaft L 20.7mm shaft flat			
For models:	0260501-00, 0261101-00, 0261101-01, 0261102-00, 0261102-01, 0261103-00, 0261103-01, 0261301-00, 0261601-00, 1261301-00, 1261301-01, 1261601-00, 1261601-01, 1261602-00, 1261602-01, 1263405-00, 1361301-00, 1361301-01, 1361301-02, 1361601-00, 1361601-01, 1361601-02, 1361602-00, 1363405-00, 1461601-00, 1463501-00, 1463501-03, 1463501-04, 20611011-0, 20611022-0, 20611033-0, 2061104-00, 20611044-0, 2061105-00, 20611055-0, 2061106-00, 20611066-0, 2061603-00, 2061603-01, 2063501-00, 2063501-05, 20635011-0, 2063502-00, 2063502-09, 20635022-0, 2063503-00, 2063503-05, 2063503-06, 20635033-0, 2063504-00... (Other models you can see in the webshop)			
spare parts for	106396			
	Part No.	101060	Ref. No.	201527 201531
	magnet unit standard L 39mm D1 ø 15.4mm D2 ø 11mm suitable for PEL20-21/JUNKERS/EGA			
	Part No.	101230	Ref. No.	—
	thermocouple nut T1: M8x1 T2: M18x1 aluminium			
	Part No.	345200	Ref. No.	—
	microswitch with plunger			
accessories for	106396			
	Part No.	100945	Ref. No.	—
	roll pin ø 3.2mm L 10mm			
	Part No.	101219	Ref. No.	—
	shaft extension L 25mm JUNKERS			
	Part No.	101281	Ref. No.	201560
	olive for pipe ø 4mm L 8.7mm Qty 1 pcs suitable for CB 502/503			
	Part No.	101284	Ref. No.	201827
	olive for pipe ø 4mm Qty 1 pcs			

¹no longer available
Table continues overleaf



accessories for				
	Part No.	101285	Ref. No.	—
union screw thread M8x1 for pipe ø 4mm Qty 1 pcs JUNKERS				
	Part No.	110064	Ref. No.	—
knob				
	Part No.	110066	Ref. No.	—
knob screw				
	Part No.	550396	Ref. No.	204109
shaft extension L 25mm JUNKERS				

accessories for				
	Part No.	101218	Ref. No.	—
shaft extension JUNKERS				
	Part No.	101219	Ref. No.	—
shaft extension L 25mm JUNKERS				
	Part No.	101231	Ref. No.	—
thermocouple nut T1: M9x1 T2: M18x1				
	Part No.	101248	Ref. No.	—
olive for pipe ø 12mm Qty 1 pcs suitable for PEL				
	Part No.	101249	Ref. No.	—
olive for pipe ø 10mm Qty 1 pcs				
	Part No.	101250	Ref. No.	—
union nut thread M20x1.5 for pipe ø 10mm				
	Part No.	101251	Ref. No.	—
union nut thread M20x1.5 for pipe ø 12mm				
	Part No.	101290	Ref. No.	—
thermocouple nut T1: M10x1 T2: M18x1 suitable for PEL20/21				
	Part No.	110064	Ref. No.	—
knob				
	Part No.	110066	Ref. No.	—
knob screw				
	Part No.	550396	Ref. No.	204109
shaft extension L 25mm JUNKERS				

alternatives to JUNKERS

 <p>1</p>				
Part No.	101457	Ref. No.	201515 Alternativ	
description	gas tap alternatives to JUNKERS type CH110 gas inlet M20x1.5 (tube ø 12mm) bypass nozzle ø 0.35mm gas outlet M20x1.5 (tube ø 12/10mm) thermocouple connection M8x1 pilot connection M10x1 shaft ø 10mm shaft L 25mm shaft flat with pipe outlet			
spare parts for	101457			
	Part No.	100259	Ref. No.	—
bypass nozzle type PEL22 bore ø 0.35mm thread M6x0.5				
	Part No.	100908	Ref. No.	—
union screw thread M10x1 for pipe ø 4mm Qty 1 pcs				
	Part No.	101058	Ref. No.	201526
magnet unit L 39mm D1 ø 15.4mm D2 ø 13.5mm suitable for PEL22/ EGA24197 standard				
	Part No.	101200	Ref. No.	—
gas tap front part shaft ø 10mm shaft L 25mm shaft flat suitable for 22S/O				
	Part No.	101230	Ref. No.	—
thermocouple nut T1: M8x1 T2: M18x1 aluminium				
	Part No.	101241	Ref. No.	—
gas connection thread M20x1.5 tube ø 12/10mm for PEL gas taps vertical				
	Part No.	101246	Ref. No.	—
olive for pipe ø 4mm Qty 1 pcs				
	Part No.	101460	Ref. No.	—
O-ring ø 12.37mm D1 ø 2.62mm suitable for PEL22				
	Part No.	101461	Ref. No.	—
screw kit suitable for PEL22 Qty 4 pcs				
accessories for	101457			
	Part No.	100945	Ref. No.	—
roll pin ø 3.2mm L 10mm				



 <p>1</p>				
Part No.	101630	Ref. No.	201516 201516 Alternativ	
description	gas tap PEL type 23S/V gas inlet 1/2" IT bypass nozzle ø 0.35mm gas outlet 1/2" MT (tube ø 14mm) thermocouple connection M10x1 pilot connection M10x1 shaft ø 10mm shaft L 25mm shaft flat			
For models:	1463501-01, 1463501-02, 2061401-00, 2061401-01, 2061401A00, 2061401B00, 2061401C00, 2061402-00, 2061402-01, 2061402A00, 2061402B00, 2061402C00, 2062801-00, 2062801A00, 2062801B00, 2062801C00, 2062802-00, 20628022-0, 20628022-1, 20628022-2, 2062802A00, 2062802B00, 2062802C00, 2062803-00, 20628033-0, 20628033-1, 20628033-2, 2062803A00, 2062803B00, 2062803C00, 2062804-00, 20628044-0, 20628044-1, 20628044-2, 2062804A00, 2062804B00, 2062804C00, 2062806-00, 2062806A00, 2062806B00, 2062806B01, 2062806B02, 2062806B03, 2062806C00, 2062806C01, 2062806C02, 2062806C03, 2062901-00, 20629011-0, 20629011-1... (Other models you can see in the webshop)			
spare parts for	101630			
	Part No.	100455	Ref. No.	—
bypass nozzle type PEL23/24 bore ø 0.35mm thread M8x0.5				

Table continues overleaf







spare parts for		101630	
	Part No.	101059	Ref. No. —
	magnet unit T1: M10x1 T2: M22x1 L 46mm ø 18mm suitable for PEL23S M10x1		
	Part No.	102767	Ref. No. —
	gas tap front part shaft ø 10mm shaft L 26.5mm shaft flat suitable for PEL23S		
accessories for		101630	
	Part No.	100908	Ref. No. —
	union screw thread M10x1 for pipe ø 4mm Qty 1 pcs		
	Part No.	100909	Ref. No. —
	union screw thread M10x1 for pipe ø 6mm Qty 1 pcs		
	Part No.	100945	Ref. No. —
	roll pin ø 3.2mm L 10mm		
	Part No.	101218	Ref. No. —
	shaft extension JUNKERS		
	Part No.	101219	Ref. No. —
	shaft extension L 25mm JUNKERS		
	Part No.	101246	Ref. No. —
	olive for pipe ø 4mm Qty 1 pcs		
	Part No.	101286	Ref. No. 201571
	olive ID ø 6mm Qty 1 pcs		
	Part No.	110064	Ref. No. —
	knob		
	Part No.	110066	Ref. No. —
	knob screw		
	Part No.	550396	Ref. No. 204109
	shaft extension L 25mm JUNKERS		

EGA







24197 series







gas taps

1

Part No.	Ref. No.	201740	201741
description		gas tap EGA type 24197 series	
For models:		0263401-00, 0263401-01, 2063413-00, 2063413-01, 2063414-00, 2063414-01, 2063414-02, 2063415-00, 2063415-01, 2063415-02, 2063415-03, 2063415-04, 2063416-00, 2063416-01, 2063417-00, 2063417-01, 2063417-02, 2063418-00, 2063418-01, 2063418-02, 2063418-03, 2063418-04, 2063419-00, 2063419-01, 2163415-00, 2163416-00, 2163416-01, 2163417-00, 2163417-01, 2163417-02, 2163417-03, 2163418-00, 2163418-01, 2163419-00, 2163419-01, 2163420-00, 2163420-01, 2163420-02, 2163420-03, 2163421-00, 2163421-01, 3063413-00, 3063414-00, 3063417-00	
spare parts for			
	Part No.	101058	Ref. No. 201526
	magnet unit L 39mm D1 ø 15.4mm D2 ø 13.5mm suitable for PEL22/ EGA24197 standard		
accessories for			
	Part No.	100944	Ref. No. —
	union nut thread M18x1.5 for pipe ø 12mm		
	Part No.	101273	Ref. No. 201594
	olive for pipe ø 12mm L 9.5mm brass Qty 1 pcs suitable for universal		
	Part No.	101284	Ref. No. 201827
	olive for pipe ø 4mm Qty 1 pcs		
	Part No.	101285	Ref. No. —
	union screw thread M8x1 for pipe ø 4mm Qty 1 pcs JUNKERS		



26440 series			
gas taps			
1			
Part No.		Ref. No.	201742 201743 201830 201835
description	gas tap EGA type 26440 series		
For models:	1464802-01, 1464803-01, 1464803-02, 1464808-01, 1464808-02, 1464809-01, 1464809-02, 1464810-01, 1464811-01, 2063401-00, 2063401-01, 2063401-02, 2063401-03, 2063401-04, 20634011-0, 2063402-00, 2063402-01, 2063402-02, 2063402-03, 2063402-04, 20634022-0, 2063403-00, 2063403-01, 2063403-02, 2063403-03, 2063403-04, 2063403-05, 2063403-06, 2063403-07, 2063403-08, 2063404-00, 2063404-01, 2063404-02, 2063404-03, 2063404-04, 2063404-05, 2063405-00, 2063405-01, 2063405-02, 2063405-03, 2063405-04, 20634055-0, 2063406-00, 2063406-01, 2063406-02, 2063406-03, 2063406-04, 2063406-05, 2063406-06, 2063406-07... (Other models you can see in the webshop)		
spare parts for			
	Part No.	101060	Ref. No. 201527 201531
	magnet unit standard L 39mm D1 ø 15.4mm D2 ø 11mm suitable for PEL20-21/JUNKERS/EGA		
accessories for			
	Part No.	100926	Ref. No. —
	centring piece thread M17x1		
	Part No.	100942	Ref. No. —
	union nut thread M15x1 for pipe ø 10mm		
	Part No.	101278	Ref. No. —
	olive for pipe ø 10mm Qty 1 pcs		
	Part No.	101284	Ref. No. 201827
	olive for pipe ø 4mm Qty 1 pcs		
	Part No.	101285	Ref. No. —
	union screw thread M8x1 for pipe ø 4mm Qty 1 pcs JUNKERS		
	Part No.	101394	Ref. No. —
	nut thread M17x1 H 3mm WS 19 brass Qty 1 pcs		

1			
Part No.		Ref. No.	201760
description	gas tap EGA type 26440 series		
For models:	1263401-00, 1263402-00, 1263404-00, 1363401-00, 1363402-00, 1363402-01, 1363403-00, 1363403-01, 1363403-02, 1363403-03, 1363404-00, 1363404-01, 1464803-02, 1464808-02, 1464809-02, 2063401-03, 2063401-04, 2063402-04, 2063403-07, 2063403-08, 2063404-04, 2063404-05, 2063405-04, 2063406-07, 2063406-08, 2063407-04, 2063407-05, 3063401-02, 3063402-02, 3063405-02		
spare parts for			
	Part No.	101060	Ref. No. 201527 201531
	magnet unit standard L 39mm D1 ø 15.4mm D2 ø 11mm suitable for PEL20-21/JUNKERS/EGA		
accessories for			
	Part No.	100926	Ref. No. —
	centring piece thread M17x1		
	Part No.	100942	Ref. No. —
	union nut thread M15x1 for pipe ø 10mm		
	Part No.	101278	Ref. No. —
	olive for pipe ø 10mm Qty 1 pcs		
	Part No.	101284	Ref. No. 201827
	olive for pipe ø 4mm Qty 1 pcs		
	Part No.	101285	Ref. No. —
	union screw thread M8x1 for pipe ø 4mm Qty 1 pcs JUNKERS		
	Part No.	101394	Ref. No. —
	nut thread M17x1 H 3mm WS 19 brass Qty 1 pcs		









1			
Part No.		Ref. No.	201737 201755
description	gas tap EGA type 26440 series		
For models:	1261101-00, 1261101-01, 1261102-00, 1261102-01, 1361101-00, 1361101-01, 1361101-02, 1361102-00, 1361102-01, 1361102-02, 1461101-01, 1461102-01, 1461104-01, 1461104-02, 1461105-01, 1461105-02, 1461109-01, 1461109A01, 1461109A02, 2061101-01, 2061101-02, 2061102-01, 2061102-02, 2061107-00, 2061107-01, 2061107A00, 2061107A01, 2161101-01, 2161101-02, 2161102-01, 2161102-02, 3061101-00, 3061102-00, 3061107-00, 3061107A00		
spare parts for			
	Part No.	101060	Ref. No. 201527 201531
	magnet unit standard L 39mm D1 ø 15.4mm D2 ø 11mm suitable for PEL20-21/JUNKERS/EGA		
	Part No.	101230	Ref. No. —
	thermocouple nut T1: M8x1 T2: M18x1 aluminium		

Table continues overleaf



accessories for				
	Part No.	100926	Ref. No.	—
centring piece thread M17x1				
	Part No.	100942	Ref. No.	—
union nut thread M15x1 for pipe ø 10mm				
	Part No.	101278	Ref. No.	—
olive for pipe ø 10mm Qty 1 pcs				
	Part No.	101284	Ref. No.	201827
olive for pipe ø 4mm Qty 1 pcs				
	Part No.	101285	Ref. No.	—
union screw thread M8x1 for pipe ø 4mm Qty 1 pcs JUNKERS				
	Part No.	101394	Ref. No.	—
nut thread M17x1 H 3mm WS 19 brass Qty 1 pcs				









gas thermostats

SIT

710 Minisit series



Part No.	106038	Ref. No.	201591	
description	gas thermostat SIT type MINISIT 710 t.max. 100°C 30-100°C pressure controller yes			
For models:	1460503-01, 2060501-00, 2060501-01, 20605011-0, 2160501-00, 2160501-01			
spare parts for	106038			
	Part No.	100908	Ref. No.	—
union screw thread M10x1 for pipe ø 4mm Qty 1 pcs				
	Part No.	101136	Ref. No.	201535
piezoelectric igniter suitable for Minisit with cover cap ømm connection F6.3x0.8				
	Part No.	101284	Ref. No.	201827
olive for pipe ø 4mm Qty 1 pcs				
	Part No.	107564	Ref. No.	—
piezoelectric igniter body plastic blowing connection F6.3x0.8 ø 22mm				
accessories for	106038			
	Part No.	110068	Ref. No.	—
knob suitable for Minisit ø 37mm				

	Part No.	106037 ¹	Ref. No.	201543
description	gas thermostat SIT type MINISIT 710 t.max. 200°C 60-200°C gas inlet 3/8" gas outlet 3/8" thermocouple connection M10x1 pilot connection M10x1 probe ø 5mm probe L 100mm capillary pipe 1150mm probe type type D2 pressure controller yes pressure regulator 3-18mbar gland nut M14x1.5			
For models:	0260301-01, 0260302-01, 1260301-00, 1260301-01, 1260302-00, 1260302-01, 1460302-00, 1460302-01, 1460302-02, 2060301-00, 2060301-01, 2060301-02			
spare parts for	106037			
	Part No.	100809	Ref. No.	—
O-ring EPDM thickness 2mm ID ø 21mm Qty 1 pcs				
	Part No.	101054	Ref. No.	—
magnet unit T1: M10x1 T2: M24x1 L 45mm ø 17mm suitable for Minisit				
	Part No.	101136	Ref. No.	201535
piezoelectric igniter suitable for Minisit with cover cap ømm connection F6.3x0.8				
	Part No.	101505	Ref. No.	—
gas connection thread 3/8" angled without O-ring MINISIT 710				
	Part No.	101516	Ref. No.	—
flat-headed bolt thread M4 thread L 16mm SS DIN 7985/ISO 7045 Qty 1 pcs				
	Part No.	110068	Ref. No.	—
knob suitable for Minisit ø 37mm				
accessories for	106037			
	Part No.	102844	Ref. No.	—
probe 60-200°C probe ø 5mm probe L 98mm capillary pipe 1050mm t.max. 200°C fryer probe type type D2 suitable for MINISIT 710 gland nut M14x1.5				

¹gland box M14x1,5



Part No.	106018	Ref. No.	201564
description	gas thermostat SIT type MINISIT 710 t.max. 340°C 120-340°C gas inlet 1/2" gas outlet 3/8" thermocouple connection M10x1 pilot connection M10x1 probe ø 5mm probe L 68mm capillary pipe 1050mm probe type type B1 pressure controller yes pressure regulator 15-30mbar gland nut		
For models:	1461101-00, 1461102-00, 1461103-00, 1462101-01, 1462101-02, 1462101-03, 1462101-04, 1462102-00, 1462102-01, 1462102-02, 1462102-03, 2061101-00, 2061102-00, 2061103-00, 2061401-02, 2061401-03, 2061401-04, 2061401A01, 2061401A02, 2061401A03, 2061401B01, 2061401B02, 2061401B03, 2061401C01, 2061401C02, 2061401C03, 2061402-02, 2061402-03, 2061402-04, 2061402A01, 2061402A02, 2061402A03, 2061402B01, 2061402B02, 2061402B03, 2061402C01, 2061402C02, 2061402C03, 2063404-01, 2063404-02, 2063404-03, 2063404-04, 2063404-05, 2063404-06, 2063404-07, 2063407-01, 2063407-02, 2063407-03, 2063407-04, 2063407-05... (Other models you can see in the webshop)		
spare parts for	106018		
	Part No.	101054	Ref. No. —
	magnet unit T1: M10x1 T2: M24x1 L 45mm ø 17mm suitable for Minisit		
	Part No.	101136	Ref. No. 201535
	piezoelectric igniter suitable for Minisit with cover cap ømm connection F6.3x0.8		
accessories for	106018		
	Part No.	101273	Ref. No. 201594
	olive for pipe ø 12mm L 9.5mm brass Qty 1 pcs suitable for universal		
	Part No.	101274	Ref. No. —
	olive for pipe ø 16mm Qty 1 pcs		
	Part No.	101275	Ref. No. —
	union screw thread 1/2" for pipe ø 16mm Qty 1 pcs		
	Part No.	101276	Ref. No. —
	union screw thread 3/8" tube ø 12mm Qty 1 pcs		
	Part No.	101278	Ref. No. —
	olive for pipe ø 10mm Qty 1 pcs		
	Part No.	101279	Ref. No. —
	union screw thread 3/8" for pipe ø 10mm Qty 1 pcs		

MERTIK

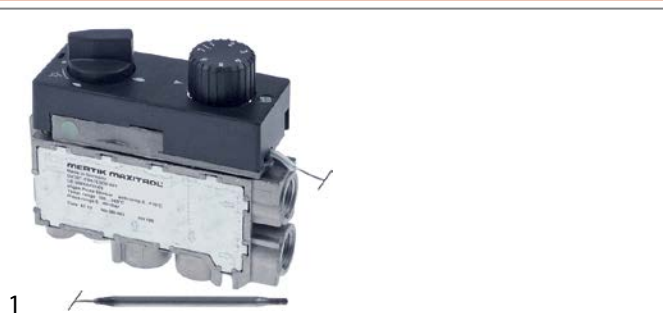

Part No.	107514	Ref. No.	201799
description	gas thermostat MERTIK t.max. 340°C 100-340°C gas inlet bottom 3/8" gas inlet lateral 3/8" gas outlet bottom 3/8" gas outlet lateral 3/8" thermocouple connection M8x1 pilot connection M10x1 capillary pipe 720mm probe ø 4mm probe L 68mm cable lengthmm gland nut		
For models:	1261101-02, 1261102-02, 1361101-03, 1361102-03, 1461101-03, 1461102-03, 1461104-03, 1461105-03, 1461109-02, 1461109A02, 1561110-00, 2061101-03, 2061101-04, 2061101-05, 2061102-03, 2061102-04, 2061102-05, 2061103-04, 2061107-02, 2061107A02, 2161101-03, 2161102-03, 3061107-02, 3061107A02		
spare parts for	107514		
	Part No.	106221	Ref. No. —
	magnet unit L 32mm D1 ø 19mm D2 ø 14mm suitable for MERTIK		

MP_JUNKERS

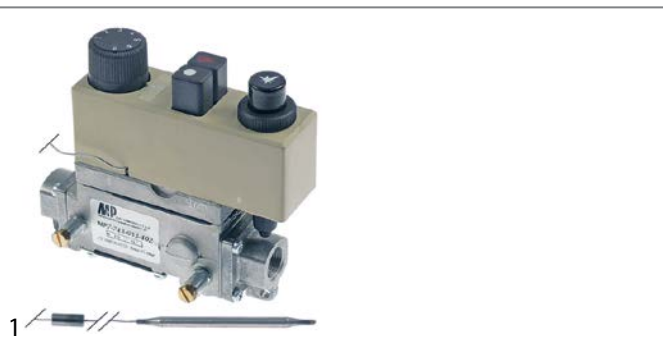





Part No.	106024	Ref. No.	201557
description	gas thermostat type 7743-633-402 t.max. 300°C 170-300°C gas inlet 3/8" straight gas outlet 3/8" straight thermocouple connection M10x1 probe ø 6mm probe L 100mm capillary pipe 820mm pressure regulatormbar MP-Junkers pilot connection M8x1 pressure controller no		
For models:	1462101-00, 14621011-0, 1462102-00_V2, 2063404-00, 2063407-00, 2063503-00, 2063505-00, 2163404-00, 2163407-00		
spare parts for	106024		
	Part No.	100111	Ref. No. —
	piezoelectric igniter body plastic blowing mounting ø 22mm connection F6.3x0.8 cable lengthmm		
	Part No.	100115	Ref. No. —
	union nut ID ø M22x1mm		
	Part No.	101060	Ref. No. 201527 201531
	magnet unit standard L 39mm D1 ø 15.4mm D2 ø 11mm suitable for PEL20-21/JUNKERS/EGA		
accessories for	106024		
	Part No.	101273	Ref. No. 201594
	olive for pipe ø 12mm L 9.5mm brass Qty 1 pcs suitable for universal		

Table continues overleaf





accessories for	106024			
	Part No.	101276	Ref. No.	—
	union screw thread 3/8" tube ø 12mm Qty 1 pcs			

gas valves and ignition boxes

gas control valves



HONEYWELL

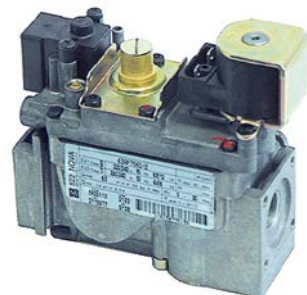

1				
Part No.	106012	Ref. No.	201181	
description	gas valve type VK4115V 220-240V 50/60Hz gas inlet flange 32x32mm gas outlet flange 32x32mm thermocouple connection pilot connection pressure range 15-60mbar max 60mbar operator type HONEYWELL flange 32x32mm			
For models:	CGG11-L, CGG11-R, CGG12-L, CGG12-R, CGG21-L, CGG21-R, CGG22-L, CGG22-R, CGG61-L, CGG61-R, CGG62-L, CGG62-R, CSG11-L, CSG11-R, CSG11-R-DG, CSG12-L, CSG12-R, CSG12-R-DG, CSG21-L, CSG21-R, CSG21-R-DG, CSG22-L, CSG22-R, CSG22-R-DG, CSG61-L, CSG61-R, CSG61-R-DG, CSG62-L, CSG62-R, CSG62-R-DG			
accessories for	106012			
	Part No.	102845	Ref. No.	—
	gas connection angled 1/2" flange 32x32mm hole distance 24x24mm Tandem			
	Part No.	102846	Ref. No.	—
	gas connection straight 1/2" flange 32x32mm hole distance 24x24mm suitable for Tandem			

SIT NOVASIT



1				
Part No.	101540	Ref. No.	201016	
description	gas valve SIT series Novasit 822 230V 50Hz gas inlet 1/2" gas outlet 1/2" thermocouple connection pilot connection closed ignition pressure 3-5mbar pressure range 3-30mbar pressure regulator connection blind equiv. no. 0.822.113			
spare parts for	101540			
	Part No.	101313	Ref. No.	—
	solenoid coil 230V 50Hz			
	Part No.	101542	Ref. No.	—
	solenoid coil 50Hz NOVA 822/826/827 suitable for NOVASIT 230V			

accessories for	101540			
	Part No.	101305	Ref. No.	—
	gas connection straight 1/2" flange 45x45mm ELETTROSIT/V4400/4600/4605 suitable for SIT/HONEYWELL hole distance 36x36mm			
	Part No.	101306	Ref. No.	—
	gas connection angled flange 45x45mm hole distance 36x36mm 1/2" ELETTROSIT/V4400/4600/4605 screw with O-ring suitable for SIT/HONEYWELL			
	Part No.	101307	Ref. No.	—
	gas connection straight flange 45x45mm hole distance 36x36mm 3/4" ELETTROSIT/V4400/4600/4605 screw with O-ring suitable for SIT/HONEYWELL			
	Part No.	101308	Ref. No.	—
	gas connection angled flange 45x45mm hole distance 36x36mm 3/4" ELETTROSIT/V4400/4600/4605 screw with O-ring suitable for SIT/HONEYWELL			
	Part No.	101317	Ref. No.	—
	plug with cable L 1000mm suitable for NOVASIT			
	Part No.	101503	Ref. No.	—
	O-ring EPDM thickness 2mm ID ø 32mm Qty 1 pcs			
	Part No.	101924	Ref. No.	—
	plug with cable L 1090mm suitable for NOVA 822/826/827			

1				
				
Part No.	101914	Ref. No.	201717	
description	gas valve SIT series Novasit 822 230V 50Hz gas inlet 1/2" gas outlet 1/2" thermocouple connection pilot connection closed ignition pressure 3-30mbar pressure regulator connection blind equiv. no. 0.822.144			
For models:	2061401-05, 2061401-06, 2061401-07, 2061401-08, 2061401A05, 2061401A06, 2061401A07, 2061401A08, 2061401B05, 2061401B06, 2061401B07, 2061401B08, 2061401C05, 2061401C06, 2061401C07, 2061401C08, 2061402-05, 2061402-06, 2061402-07, 2061402A05, 2061402A06, 2061402A07, 2061402B05, 2061402B06, 2061402B07, 2061402C05, 2061402C06, 2061402C07, 2062801-06, 2062801A06, 2062801B06, 2062801C06, 2062802-06, 2062802A06, 2062802B06, 2062802C06, 2062803-06, 2062803A06, 2062803B06, 2062803C06, 2062804-06, 2062804A06, 2062804B06, 2062804C06, 2161401-03, 2161401-04, 2161401-05, 2161401-06, 2161401A03, 2161401A04... (Other models you can see in the webshop)			
spare parts for	101914			
	Part No.	101313	Ref. No.	—
	solenoid coil 230V 50Hz			
	Part No.	101542	Ref. No.	—
	solenoid coil 50Hz NOVA 822/826/827 suitable for NOVASIT 230V			
accessories for	101914			
	Part No.	101305	Ref. No.	—
	gas connection straight 1/2" flange 45x45mm ELETTROSIT/V4400/4600/4605 suitable for SIT/HONEYWELL hole distance 36x36mm			

Table continues overleaf



accessories for		101914	
Part No.	101306	Ref. No.	—
	gas connection angled flange 45x45mm hole distance 36x36mm 1/2" ELETROSIT/V4400/4600/4605 screw with O-ring suitable for SIT/ HONEYWELL		
	gas connection straight flange 45x45mm hole distance 36x36mm 3/4" ELETROSIT/V4400/4600/4605 screw with O-ring suitable for SIT/ HONEYWELL		
	gas connection angled flange 45x45mm hole distance 36x36mm 3/4" ELETROSIT/V4400/4600/4605 screw with O-ring suitable for SIT/ HONEYWELL		
	O-ring EPDM thickness 2mm ID ø 32mm Qty 1 pcs		
	plug with cable L 1090mm suitable for NOVA 822/826/827		

accessories for		101984	
Part No.	102847	Ref. No.	—
	O-ring		

ignition boxes

DUNGS



Part No.	102378	Ref. No.	201643 201662 201699 201735
description	ignition box type DGAI.73 model 10.1.0TCL electrodes 2 starting time <10s waiting time >3s safety time <1s 230V 50/60Hz ignition cable male faston 2.8mm DUNGS protection IP20 DGAI.73		
For models:	1462802B00, 1462802B01, 1462802B02, 1462802B03, 1462802B04, 1462802B05, 1462804B00, 1462804B01, 1462804B02, 1462804B03, 1462804B04, 1462804B05, 2061401-05, 2061401-06, 2061401-07, 2061401-08, 2061401A05, 2061401A06, 2061401A07, 2061401A08, 2061401B05, 2061401B06, 2061401B07, 2061401B08, 2061401C05, 2061401C06, 2061401C07, 2061401C08, 2061402-05, 2061402-06, 2061402-07, 2061402A05, 2061402A06, 2061402A07, 2061402B05, 2061402B06, 2061402B07, 2061402C05, 2061402C06, 2061402C07, 2061403-00, 2061403-02, 2061403-03, 2061403-04, 2061403-05, 20614033-0, 2061403A02, 2061403A03, 2061403A04, 2061403A05... (Other models you can see in the webshop)		

TANDEM



Part No.	101984	Ref. No.	201718
description	gas valve 230V 50Hz gas inlet 1/2" gas outlet 1/2" pilot connection level slow ignition ignition times pressure range 2-50mbar power supply for modulator 230VAC rectified Tandem equiv. no. 0.836.010		
For models:	1462802B00, 1462802B01, 1462802B02, 1462802B03, 1462802B04, 1462802B05, 1462804B00, 1462804B01, 1462804B02, 1462804B03, 1462804B04, 1462804B05, 2061403-02, 2061403-03, 2061403-04, 2061403-05, 2061403A02, 2061403A03, 2061403A04, 2061403A05, 2061403B02, 2061403B03, 2061403B04, 2061403B05, 2061403C02, 2061403C03, 2061403C04, 2061403C05, 2061404-02, 2061404-03, 2061404-04, 2061404-05, 2061404A02, 2061404A03, 2061404A04, 2061404A05, 2061404B02, 2061404B03, 2061404B04, 2061404B05, 2061404C02, 2061404C03, 2061404C04, 2061404C05, 2061405-01, 2061405-02, 2061405-03, 2061405-04, 2061405B01, 2061405B02... (Other models you can see in the webshop)		
spare parts for	101984		
	Part No. 101379	Ref. No.	—
solenoid coil 230V 50Hz suitable for Tandem			
accessories for	101984		
	Part No. 101274	Ref. No.	—
olive for pipe ø 16mm Qty 1 pcs			
	Part No. 101275	Ref. No.	—
union screw thread 1/2" for pipe ø 16mm Qty 1 pcs			
	Part No. 101925	Ref. No.	—
plug with O-ring thread M10x1 for pilot burner suitable for NOVASIT			
	Part No. 102845	Ref. No.	—
gas connection angled 1/2" flange 32x32mm hole distance 24x24mm Tandem			
	Part No. 102846	Ref. No.	—
gas connection straight 1/2" flange 32x32mm hole distance 24x24mm suitable for Tandem			

HONEYWELL



Part No.	106607	Ref. No.	201180
description	cover for ignition box		
For models:	CGG11-L, CGG11-R, CGG12-L, CGG12-R, CGG21-L, CGG21-R, CGG22-L, CGG22-R, CGG61-L, CGG61-R, CGG62-L, CGG62-R, CSG11-L, CSG11-R, CSG11-R-DG, CSG12-L, CSG12-R, CSG12-R-DG, CSG21-L, CSG21-R, CSG21-R-DG, CSG22-L, CSG22-R, CSG22-R-DG, CSG61-L, CSG61-R, CSG61-R-DG, CSG62-L, CSG62-R, CSG62-R-DG		



Honeywell



1

Part No.	106606	Ref. No.	201179
description	ignition box HONEYWELL type S4575B 1025 electrodes 3 waiting times safety time 5s 230-240V 4VA 50/60Hz		
For models:	CGG11-L, CGG11-R, CGG12-L, CGG12-R, CGG21-L, CGG21-R, CGG22-L, CGG22-R, CGG61-L, CGG61-R, CGG62-L, CGG62-R, CSG11-L, CSG11-R, CSG11-R-DG, CSG12-L, CSG12-R, CSG12-R-DG, CSG21-L, CSG21-R, CSG21-R-DG, CSG22-L, CSG22-R, CSG22-R-DG, CSG61-L, CSG61-R, CSG61-R-DG, CSG62-L, CSG62-R, CSG62-R-DG		

gas solenoid valves

DUNGS



1

Part No.	102379 ¹	Ref. No.	201529
description	solenoid valve 230VAC connection 1/2" L 76mm DUNGS p max 0.2bar p min 0bar reg. no. 63AQ0626 gas inlet 1/2" gas outlet 1/2"		
For models:	2061403-00, 2061403-01, 20614033-0, 2061403A00, 2061403B00, 2061403C00, 2061404-00, 2061404-01, 20614044-0, 2061404A00, 2061404B00, 2061404C00, 2061405-00, 2061405B00, 2061406-00, 2061406B00, 20628033-0, 20628044-0, 20629011-0, 20629022-0, 3061403-00, 3061403A00, 3061403B00, 3061403C00, 3061404-00, 3061404A00, 3061404B00, 3061404C00, 3061405-00, 3061405B00, 3061405B01, 3061406-00, 3061406B00		

¹aluminium housing

ignition parts

pilot burners

JUNKERS

CB 502 series

pilot burners



1

Part No.	100085	Ref. No.	201598
description	pilot burner JUNKERS type CB502031 natural gas nozzle no.6 gas connection 6mm with primary air		
For models:	0260301-00, 0260301-01, 0260302-00, 0260302-01, 0260501-00, 0261101-00, 0261101-01, 0261102-00, 0261102-01, 0261103-00, 0261103-01, 0261301-00, 0261601-00, 1461101-00, 1461102-00, 1461103-00, 1462101-00, 1462101-01, 1462101-02, 14621011-0, 1462102-00, 1462102-00_V2, 1462102-01, 2060301-00, 2061101-00, 20611011-0, 2061102-00, 20611022-0, 2061103-00, 20611033-0, 2061104-00, 20611044-0, 2061105-00, 20611055-0, 2061106-00, 20611066-0, 2061401-02, 2061401-03, 2061401-04, 2061401A01, 2061401A02, 2061401A03, 2061401B01, 2061401B02, 2061401B03, 2061401C01, 2061401C02, 2061401C03, 2061402-02, 2061402-03... (Other models you can see in the webshop)		
spare parts for	100085		
	Part No.	100227	Ref. No. —
	pilot burner nozzle natural gas gas pressure 25mbar code 6 Qty 1 pcs suitable for JUNKERS CB50203_		
	Part No.	100704	Ref. No. 201570 201572 201578
	ignition electrode D1 ø 9mm connection M4 D2 ø 11mm L1 17mm L2 17mm BL1 13mm BL2 4mm BL3 22mm		
	Part No.	100909	Ref. No. —
	union screw thread M10x1 for pipe ø 6mm Qty 1 pcs		
	Part No.	101287	Ref. No. —
	olive for pipe ø 6mm Qty 1 pcs		
	Part No.	101292	Ref. No. —
	union screw for igniter suitable for CB 502/505 Qty 1 pcs		
	Part No.	101295	Ref. No. —
	clamping collet for thermocouple suitable for CB 502/505 Qty 1 pcs		
accessories for	100085		
	Part No.	100220	Ref. No. 201547
	pilot burner nozzle LPG gas pressure 50mbar code 2 Qty 1 pcs suitable for JUNKERS CB503_		
	Part No.	100221	Ref. No. —
	pilot burner nozzle LPG gas pressure 30mbar code 29 Qty 1 pcs suitable for JUNKERS CB50203_		
	Part No.	100222	Ref. No. 201641
	pilot burner nozzle LPG gas pressure 50mbar code 5 Qty 1 pcs suitable for JUNKERS CB50203_		
	Part No.	100223	Ref. No. —
	pilot burner nozzle natural gas gas pressure 20mbar code 3 Qty 1 pcs suitable for JUNKERS CB503_		





Table continues overleaf

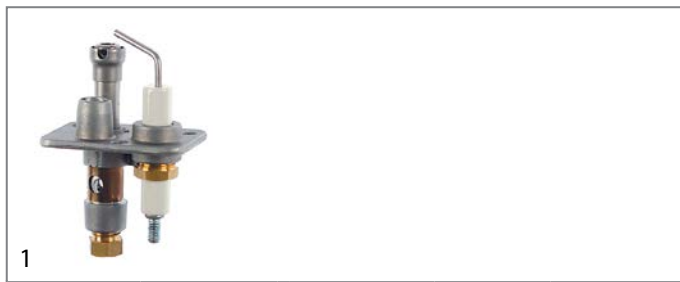











accessories for		100085		
Part No.		100224	Ref. No.	—
	pilot burner nozzle natural gas gas pressure 25mbar code 26 Qty 1 pcs suitable for JUNKERS CB503_			
	pilot burner nozzle LPG gas pressure 30mbar code 39 Qty 1 pcs suitable for JUNKERS CB503_			
	pilot burner nozzle LPG gas pressure 50mbar code 15 suitable for JUNKERS			
	pilot burner nozzle town gas gas pressure 8mbar code 4 Qty 1 pcs suitable for JUNKERS CB50203_			
	olive for pipe ø 4mm L 8.7mm Qty 1 pcs suitable for CB 502/503			201560
	union screw thread M10x1 for pipe ø 4mm Qty 1 pcs			201692



Part No.	102843	Ref. No.	520917 520997
description	pilot burner JUNKERS type CB502031 natural gas nozzle no.6 gas pressure 25mbar gas connection 6mm with primary air		
For models:	0261101-01, 0261102-01, 0261103-01, 2060301-00, 2061104-00, 2061105-00, 2061106-00, 2062801-00, 2062801A00, 2062801B00, 2062801C00, 2062802-00, 2062802-0, 20628022-1, 20628022-2, 2062802A00, 2062802B00, 2062802C00, 2062803-00, 20628033-0, 20628033-2, 2062803A00, 2062803B00, 2062803C00, 2062804-00, 20628044-0, 20628044-2, 2062804A00, 2062804B00, 2062804C00, 2062901-00, 20629011-0, 20629011-2, 2062901A00, 2062901B00, 2062901B01, 2062901B02, 2062901C00, 2062901C01, 2062901C02, 2062902-00, 20629022-0, 20629022-2, 2062902A00, 2062902B00, 2062902B01, 2062902B02, 2062902C00, 2062902C01, 2062902C02		



spare parts for		102843		
Part No.		100227	Ref. No.	—
	pilot burner nozzle natural gas gas pressure 25mbar code 6 Qty 1 pcs suitable for JUNKERS CB50203_			
	ignition electrode D1 ø 9mm connection M4 D2 ø 11mm L1 17mm L2 17mm BL1 13mm BL2 4mm BL3 22mm			201570 201572 201578
	union screw thread M10x1 for pipe ø 6mm Qty 1 pcs			—
	olive for pipe ø 6mm Qty 1 pcs			—
	union screw for igniter suitable for CB 502/505 Qty 1 pcs			—

accessories for		102843		
Part No.		100220	Ref. No.	201547
	pilot burner nozzle LPG gas pressure 50mbar code 2 Qty 1 pcs suitable for JUNKERS CB503_			

accessories for		102843		
Part No.		100221	Ref. No.	—
	pilot burner nozzle LPG gas pressure 30mbar code 29 Qty 1 pcs suitable for JUNKERS CB50203_			
	pilot burner nozzle LPG gas pressure 50mbar code 5 Qty 1 pcs suitable for JUNKERS CB50203_			201641
	pilot burner nozzle natural gas gas pressure 20mbar code 3 Qty 1 pcs suitable for JUNKERS CB503_			—
	pilot burner nozzle natural gas gas pressure 25mbar code 26 Qty 1 pcs suitable for JUNKERS CB503_			—
	pilot burner nozzle LPG gas pressure 30mbar code 39 Qty 1 pcs suitable for JUNKERS CB503_			—
	pilot burner nozzle LPG gas pressure 50mbar code 15 suitable for JUNKERS			—
	pilot burner nozzle town gas gas pressure 8mbar code 4 Qty 1 pcs suitable for JUNKERS CB50203_			—
	olive for pipe ø 4mm L 8.7mm Qty 1 pcs suitable for CB 502/503			201560
	union screw thread M10x1 for pipe ø 4mm Qty 1 pcs			201692

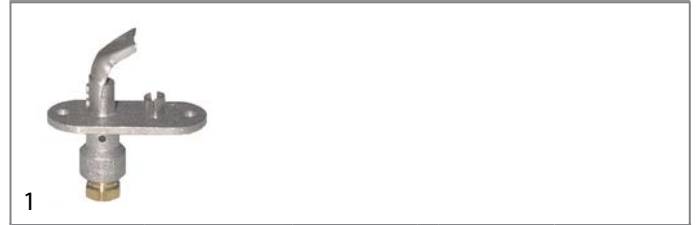
CB 503 series
pilot burners



Part No.	100121	Ref. No.	201544
description	pilot burner JUNKERS type CB503002 natural gas gas pressure 15mbar		
spare parts for	100121		
	pilot burner nozzle natural gas gas pressure 20mbar code 3 Qty 1 pcs suitable for JUNKERS CB503_		—
	olive for pipe ø 4mm L 8.7mm Qty 1 pcs suitable for CB 502/503		201560
	union screw thread M10x1 for pipe ø 4mm Qty 1 pcs		201692

















accessories for		100121		
Part No.		100220	Ref. No.	201547
	pilot burner nozzle LPG gas pressure 50mbar code 2 Qty 1 pcs suitable for JUNKERS CB503_			
	pilot burner nozzle LPG gas pressure 30mbar code 29 Qty 1 pcs suitable for JUNKERS CB50203_			—

Table continues overleaf



accessories for		100121		
	Part No.	100222	Ref. No.	201641
	pilot burner nozzle LPG gas pressure 50mbar code 5 Qty 1 pcs suitable for JUNKERS CB50203_			
	Part No.	100224	Ref. No.	—
	pilot burner nozzle natural gas gas pressure 25mbar code 26 Qty 1 pcs suitable for JUNKERS CB503_			
	Part No.	100226	Ref. No.	—
	pilot burner nozzle LPG gas pressure 50mbar code 15 suitable for JUNKERS			
	Part No.	100227	Ref. No.	—
	pilot burner nozzle natural gas gas pressure 25mbar code 6 Qty 1 pcs suitable for JUNKERS CB50203_			
	Part No.	100228	Ref. No.	—
	pilot burner nozzle town gas gas pressure 8mbar code 4 Qty 1 pcs suitable for JUNKERS CB50203_			
	Part No.	100909	Ref. No.	—
	union screw thread M10x1 for pipe ø 6mm Qty 1 pcs			
	Part No.	101287	Ref. No.	—
	olive for pipe ø 6mm Qty 1 pcs			

				
1				
Part No.	100058	Ref. No.	201544	
description	pilot burner JUNKERS type CB503006 natural gas nozzle no.26 gas connection 4mm			
spare parts for	100058			
	Part No.	100224	Ref. No.	—
	pilot burner nozzle natural gas gas pressure 25mbar code 26 Qty 1 pcs suitable for JUNKERS CB503_			
	Part No.	101281	Ref. No.	201560
	olive for pipe ø 4mm L 8.7mm Qty 1 pcs suitable for CB 502/503			
	Part No.	101283	Ref. No.	201692
	union screw thread M10x1 for pipe ø 4mm Qty 1 pcs			
accessories for	100058			
	Part No.	100220	Ref. No.	201547
	pilot burner nozzle LPG gas pressure 50mbar code 2 Qty 1 pcs suitable for JUNKERS CB503_			
	Part No.	100221	Ref. No.	—
	pilot burner nozzle LPG gas pressure 30mbar code 29 Qty 1 pcs suitable for JUNKERS CB50203_			
	Part No.	100222	Ref. No.	201641
	pilot burner nozzle LPG gas pressure 50mbar code 5 Qty 1 pcs suitable for JUNKERS CB50203_			
	Part No.	100223	Ref. No.	—
	pilot burner nozzle natural gas gas pressure 20mbar code 3 Qty 1 pcs suitable for JUNKERS CB503_			
	Part No.	100226	Ref. No.	—
	pilot burner nozzle LPG gas pressure 50mbar code 15 suitable for JUNKERS			
	Part No.	100227	Ref. No.	—
	pilot burner nozzle natural gas gas pressure 25mbar code 6 Qty 1 pcs suitable for JUNKERS CB50203_			

accessories for		100058		
	Part No.	100228	Ref. No.	—
	pilot burner nozzle town gas gas pressure 8mbar code 4 Qty 1 pcs suitable for JUNKERS CB50203_			
	Part No.	100909	Ref. No.	—
	union screw thread M10x1 for pipe ø 6mm Qty 1 pcs			
	Part No.	101287	Ref. No.	—
	olive for pipe ø 6mm Qty 1 pcs			
	Part No.	102110	Ref. No.	—
	pilot tube copper pipe ø 4mm thickness 1mm L 3000mm			
	Part No.	102111	Ref. No.	—
	pilot tube copper pipe ø 6mm thickness 1mm L 3000mm			

producer-specific pilot burners

MKN

EA_ , HL_ , SL_ , Optima700 series













				
1				
Part No.	102841	Ref. No.	201681	
description	pilot burner SIT type 160 series 2 flames natural gas nozzle ø 0.41mm gas connection 4mm nozzle no.41			
For models:	1260301-00, 1260301-01, 1260302-00, 1260302-01, 1261301-00, 1261301-01, 1261301-02, 1261601-00, 1261601-01, 1361301-00, 1361301-01, 1361301-02, 1361301-03, 1361601-00, 1361601-01, 1361601-02, 1460302-01, 1460302-02, 1461601-00, 2060301-01, 2060301-02, 2061301-01			
spare parts for	102841			
	Part No.	100202	Ref. No.	—
	pilot burner nozzle natural gas code 41 Qty 1 pcs nozzle ø 0.41mm			
	Part No.	100701	Ref. No.	201690 201691
	ignition electrode connection M4 Qty 1 pcs			
	Part No.	100906	Ref. No.	201693
	screw connection thread M10x1 for ignition electrode brass Qty 1 pcs WS 10			
	Part No.	100907	Ref. No.	—
	screw connection thread M10x1 Qty 1 pcs type SEF 1 ømm for thermocouple			
	Part No.	100908	Ref. No.	—
	union screw thread M10x1 for pipe ø 4mm Qty 1 pcs			
	Part No.	101282	Ref. No.	—
	olive for pipe ø 4mm L 7.4mm Qty 1 pcs			
accessories for	102841			
	Part No.	100203	Ref. No.	—
	pilot burner nozzle LPG code 25 Qty 1 pcs nozzle ø 0.25mm			







Table continues overleaf







accessories for		102841	
Part No.	100869	Ref. No.	—
	pilot burner nozzle natural gas code 51 Qty 1 pcs suitable for 160 series nozzle ø 0.51mm		
Part No.	100909	Ref. No.	—
	union screw thread M10x1 for pipe ø 6mm Qty 1 pcs		
Part No.	101287	Ref. No.	—
	olive for pipe ø 6mm Qty 1 pcs		
Part No.	107650	Ref. No.	—
	pilot burner nozzle SIT LPG code 30 Qty 1 pcs		



Part No.	102840	Ref. No.	201680
description	pilot burner SIT type 160 series 2 flames nozzle ø 0.41mm gas connection 6mm with igniter		
For models:	1260501-00, 1261101-00, 1261101-01, 1261101-02, 1261102-00, 1261102-01, 1261102-02, 1261602-00, 1261602-01, 1261602-02, 1261602-03, 1261604-03, 1360501-00, 1360501-01, 1361101-00, 1361101-01, 1361101-02, 1361101-03, 1361102-00, 1361102-01, 1361102-02, 1361102-03, 1361602-00, 1361602-01, 1361602-02, 1361604-02, 1460503-01, 1461101-01, 1461101-02, 1461101-03, 1461102-01, 1461102-02, 1461102-03, 1461104-01, 1461104-02, 1461104-03, 1461105-01, 1461105-02, 1461105-03, 1461109-01, 1461109-02, 1461109A01, 1461109A02, 1461602-00, 1462101-03, 1462101-04, 1462102-02, 1462102-03, 1561110-00, 2061101-01... (Other models you can see in the webshop)		

spare parts for		102840	
Part No.	100202	Ref. No.	—
	pilot burner nozzle natural gas code 41 Qty 1 pcs nozzle ø 0.41mm		
Part No.	100701	Ref. No.	201690 201691
	ignition electrode connection M4 Qty 1 pcs		
Part No.	100906	Ref. No.	201693
	screw connection thread M10x1 for ignition electrode brass Qty 1 pcs WS 10		
Part No.	100907	Ref. No.	—
	screw connection thread M10x1 Qty 1 pcs type SEF 1 ømm for thermocouple		
Part No.	100909	Ref. No.	—
	union screw thread M10x1 for pipe ø 6mm Qty 1 pcs		
Part No.	101287	Ref. No.	—
	olive for pipe ø 6mm Qty 1 pcs		



accessories for		102840	
Part No.	100203	Ref. No.	—
	pilot burner nozzle LPG code 25 Qty 1 pcs nozzle ø 0.25mm		
Part No.	100869	Ref. No.	—
	pilot burner nozzle natural gas code 51 Qty 1 pcs suitable for 160 series nozzle ø 0.51mm		



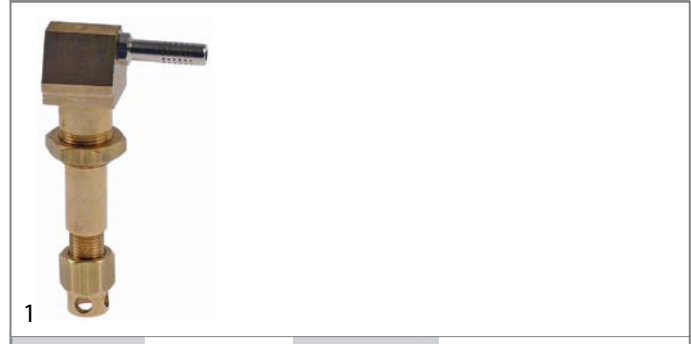

accessories for		102840	
Part No.	100908	Ref. No.	—
	union screw thread M10x1 for pipe ø 4mm Qty 1 pcs		
Part No.	101282	Ref. No.	—
	olive for pipe ø 4mm L 7.4mm Qty 1 pcs		
Part No.	107650	Ref. No.	—
	pilot burner nozzle SIT LPG code 30 Qty 1 pcs		

Universal series



Part No.	100088	Ref. No.	201820
description	pilot burner EGA type B		
For models:	0263401-00, 0263401-01, 1263401-00, 1263402-00, 1263402-01, 1263402-02, 1263404-00, 1263404-01, 1263404-02, 1263405-00, 1263405-01, 1263413-02, 1263414-02, 1363401-00, 1363402-00, 1363402-01, 1363402-02, 1363403-00, 1363403-01, 1363403-02, 1363403-03, 1363403-04, 1363403-05, 1363404-00, 1363404-01, 1363404-02, 1363404-03, 1363405-00, 1363405-01, 1363413-03, 1363415-05, 1464802-01, 1464802-02, 1464803-01, 1464803-02, 1464803-03, 1464808-01, 1464808-02, 1464808-03, 1464809-01, 1464809-02, 1464809-03, 1464810-01, 1464810-02, 1464811-01, 1464811-02, 1464812-00, 1464812-01, 1464812-02, 2063401-00... (Other models you can see in the webshop)		

spare parts for		100088	
Part No.	100961	Ref. No.	201819
	pilot burner head thread M7x0.75mm thread L 5mm ED ø 6mm ID ø 4.4mm total length 30mm L 20mm WS 8		
Part No.	101345	Ref. No.	—
	nut thread M15x1 H 3mm WS 19 brass Qty 1 pcs		

accessories for		100088	
Part No.	100270	Ref. No.	201821
	pilot burner nozzle LPG bore ø 0.2mm thread M8x0.75 T1: M8x1		
Part No.	100271	Ref. No.	201822
	pilot burner nozzle natural gas bore ø 0.3mm		
Part No.	100960	Ref. No.	201040 575286
	cover for pilot burner		
Part No.	101259	Ref. No.	—
	union nut thread M8x1 for pipe ø 4mm		
Part No.	101284	Ref. No.	201827
	olive for pipe ø 4mm Qty 1 pcs		

Part No.	103183	Ref. No.	N/A
description	pilot burner EGA type B		
spare parts for	103183		
	Part No.	100960	Ref. No. 201040 575286
cover for pilot burner			

electrodes

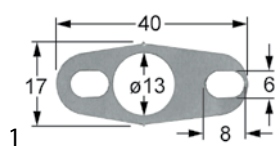

Part No.	107886	Ref. No.	911589
description	bracket for glow electrode plate L 40mm W 17mm bore ϕ 13mm		
For models:	CGG11-L, CGG11-R, CGG12-L, CGG12-R, CGG21-L, CGG21-R, CGG22-L, CGG22-R, CGG61-L, CGG61-R, CGG62-L, CGG62-R, CSG11-L, CSG11-R, CSG11-R-DG, CSG12-L, CSG12-R, CSG12-R-DG, CSG21-L, CSG21-R, CSG21-R-DG, CSG22-L, CSG22-R, CSG22-R-DG, CSG61-L, CSG61-R, CSG61-R-DG, CSG62-L, CSG62-R, CSG62-R-DG		



Part No.	102289	Ref. No.	201176 201176+ 211137+ 2x211143
description	glow plug mounting distance 28mm cable length 600mm connection male faston 2.8mm		
For models:	CGG11-L, CGG11-R, CGG12-L, CGG12-R, CGG21-L, CGG21-R, CGG22-L, CGG22-R, CGG61-L, CGG61-R, CGG62-L, CGG62-R, CSG11-L, CSG11-R, CSG11-R-DG, CSG12-L, CSG12-R, CSG12-R-DG, CSG21-L, CSG21-R, CSG21-R-DG, CSG22-L, CSG22-R, CSG22-R-DG, CSG61-L, CSG61-R, CSG61-R-DG, CSG62-L, CSG62-R, CSG62-R-DG		
spare parts for	102289		
	Part No.	691609	Ref. No. 211143
gasket graphite ED ϕ 150mm ID ϕ 115mm thickness 2mm Qty 1 pcs			

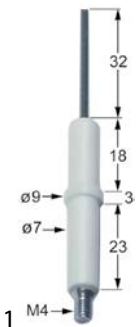

Part No.	100701	Ref. No.	201690 201691
description	ignition electrode connection M4 Qty 1 pcs		
accessories for	100701		
	Part No.	100906	Ref. No. 201693
screw connection thread M10x1 for ignition electrode brass Qty 1 pcs WS 10			

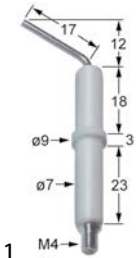

Part No.	100719	Ref. No.	201577
description	ignition electrode D1 ϕ 7mm D2 ϕ 9mm connection M4 L1 12mm L2 17mm BL1 18mm BL2 3mm BL3 23mm		
For models:	2061403-00, 20614033-0		

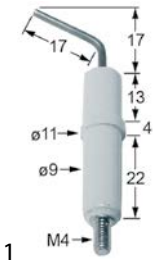

Part No.	100704	Ref. No.	201570 201572 201578
description	ignition electrode D1 ϕ 9mm connection M4 D2 ϕ 11mm L1 17mm L2 17mm BL1 13mm BL2 4mm BL3 22mm		



Part No.	100703	Ref. No.	636700
description	ignition electrode D1 ϕ 9mm connection M4 D2 ϕ 11mm L1 8mm BL1 13mm BL2 4mm BL3 22mm to clip		

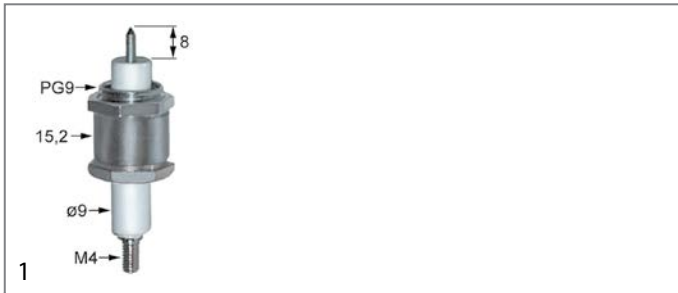

Part No.	100741	Ref. No.	201597
description	ignition electrode D1 ø9mm L1 8mm connection M4 PG9		
For models:	14621011-0, 1463501-00, 1463501-01, 2060501-00, 2060501-01, 20605011-0, 2061401-00, 2061401-01, 2061401A00, 2061401B00, 2061401C00, 2061402-00, 2061402-01, 2061402A00, 2061402B00, 2061402C00, 2063501-00, 2063501-01, 20635011-0, 2063502-00, 2063502-01, 2063502-02, 20635022-0, 2063503-00, 2063503-01, 20635033-0, 2063504-00, 2063504-01, 20635044-0, 2063505-00, 20635055-0, 2063506-00, 2063506-01, 20635066-0, 2063507-00, 2063507-01, 2063507-02, 20635077-0, 2063508-00, 2063508-01, 20635088-0, 2063509-00, 2063509-01, 2063509-02		

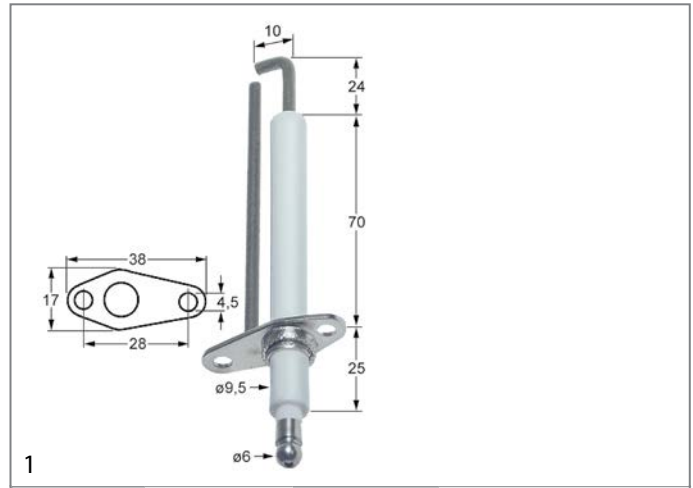

Part No.	102268	Ref. No.	201719
description	ignition electrode flange length 38mm flange width 17mm D1 ø 9.5mm L1 24mm L2 10mm BL1 70mm BL2 25mm fixing dimensions ø4.5mm mounting distance 28mm with flange with earthing contact connection ø 6mm		
For models:	1462802B00, 1462802B01, 1462802B02, 1462802B03, 1462802B04, 1462802B05, 1462804B00, 1462804B01, 1462804B02, 1462804B03, 1462804B04, 1462804B05, 2061409B00, 2061409B01, 2061411B00, 2062801-06, 2062801A06, 2062801B06, 2062801C06, 2062802-06, 2062802A06, 2062802B06, 2062802B07, 2062802B08, 2062802B09, 2062802B10, 2062802B11, 2062802B12, 2062802B13, 2062802C06, 2062803-06, 2062803A06, 2062803B06, 2062803C06, 2062804-06, 2062804A06, 2062804B06, 2062804B07, 2062804B08, 2062804B09, 2062804B10, 2062804B11, 2062804B12, 2062804B13, 2062804C06, 2062807B00, 2062807B01, 2062807B02, 2062807B03, 2062808B00... (Other models you can see in the webshop)		

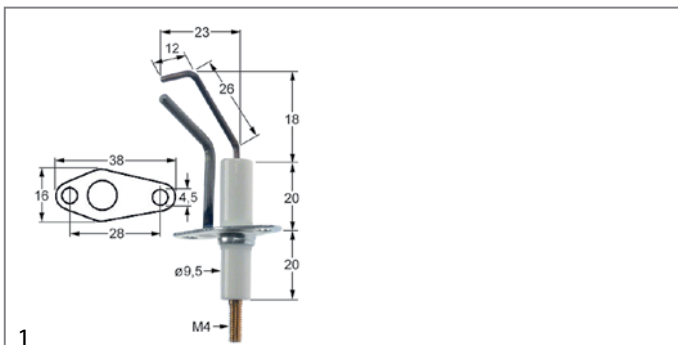

Part No.	102834	Ref. No.	201639
description	ignition electrode flange length 38mm flange width 16mm D1 ø 9.5mm L1 18mm L2 23mm L4 26mm L3 12mm BL1 20mm BL2 20mm connection M4 fixing dimensions ø4.5mm mounting distance 28mm with flange with earthing contact		
For models:	1463501-02, 1463501-03, 1463501-04, 1463501-05, 2061401-05, 2061401-06, 2061401-07, 2061401-08, 2061401A05, 2061401A06, 2061401A07, 2061401A08, 2061401B05, 2061401B06, 2061401B07, 2061401B08, 2061401C05, 2061401C06, 2061401C07, 2061401C08, 2061402-05, 2061402-06, 2061402-07, 2061402A05, 2061402A06, 2061402A07, 2061402B05, 2061402B06, 2061402B07, 2061402C05, 2061402C06, 2061402C07, 2061403-01, 2061403-02, 2061403-03, 2061403-04, 2061403-05, 20614033-0, 2061403A00, 2061403A02, 2061403A03, 2061403A04, 2061403A05, 2061403B00, 2061403B02, 2061403B03, 2061403B04, 2061403B05, 2061403C00, 2061403C02... (Other models you can see in the webshop)		

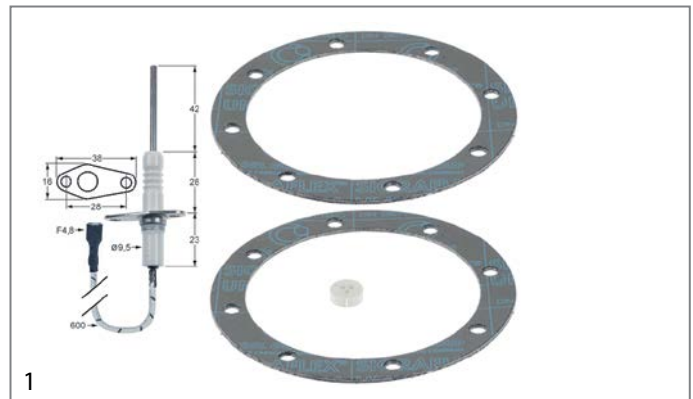

Part No.	102290	Ref. No.	201177
description	monitoring electrode flange length 38mm D1 ø 9.5mm flange width 16mm L1 42mm BL1 28mm BL2 23mm connection F4.8x0.8 cable length 600mm fixing dimensions 28mm		
For models:	CGG11-L, CGG11-R, CGG12-L, CGG12-R, CGG21-L, CGG21-R, CGG22-L, CGG22-R, CGG61-L, CGG61-R, CGG62-L, CGG62-R, CSG11-L, CSG11-R, CSG11-R-DG, CSG12-L, CSG12-R, CSG12-R-DG, CSG21-L, CSG21-R, CSG21-R-DG, CSG22-L, CSG22-R, CSG22-R-DG, CSG61-L, CSG61-R, CSG61-R-DG, CSG62-L, CSG62-R, CSG62-R-DG		



Part No.	100906	Ref. No.	201693
description	screw connection thread M10x1 for ignition electrode brass Qty 1 pcs WS 10		



1 gas components

ignition cables

pre-assembled cables



Part No.	102164	Ref. No.	203422
description	ignition cable cable length 1000mm connection F6.3mm / lug M4		
For models:	1260301-00, 1260301-01, 1260302-00, 1260302-01, 1260501-00, 1261101-01, 1261101-02, 1261102-01, 1261102-02, 1261301-00, 1261301-01, 1261301-02, 1261601-01, 1261602-00, 1261602-01, 1261602-02, 1261602-03, 1261604-03, 1360501-00, 1360501-01, 1361101-01, 1361101-02, 1361101-03, 1361102-01, 1361102-02, 1361102-03, 1361301-00, 1361301-01, 1361301-02, 1361301-03, 1361601-01, 1361601-02, 1361602-00, 1361602-01, 1361602-02, 1361604-02, 1460302-01, 1460302-02, 1460503-01, 1461101-02, 1461101-03, 1461102-02, 1461102-03, 1461104-02, 1461104-03, 1461105-02, 1461105-03, 1461109-01, 1461109-02, 1461109A01... (Other models you can see in the webshop)		

piezoelectric igniters

mounting diameter 22mm



Part No.	105209 ¹	Ref. No.	910736
description	piezoelectric igniter body plastic blowing mounting ø 22mm connection F6.3x0.8 cable length 200mm		
For models:	1260501-00, 1261101-00, 1261101-01, 1261101-02, 1261102-00, 1261102-01, 1261102-02, 1261301-00, 1261301-01, 1261301-02, 1261601-00, 1261601-01, 1261602-00, 1261602-01, 1261602-02, 1261602-03, 1261604-03, 1360501-00, 1360501-01, 1361101-00, 1361101-01, 1361101-02, 1361101-03, 1361102-00, 1361102-01, 1361102-02, 1361102-03, 1361301-00, 1361301-01, 1361301-02, 1361301-03, 1361601-00, 1361601-01, 1361601-02, 1361602-00, 1361602-01, 1361602-02, 1361604-02, 1461101-01, 1461101-02, 1461101-03, 1461102-01, 1461102-02, 1461102-03, 1461104-01, 1461104-02, 1461104-03, 1461105-01, 1461105-02, 1461105-03... (Other models you can see in the webshop)		

¹cable length 200mm



Part No.	100039	Ref. No.	201519 201537
description	piezoelectric igniter body plastic blowing mounting ø 22mm connection F6.3x0.8 cable lengthmm		
For models:	1260501-00, 1261101-00, 1261101-01, 1261101-02, 1261102-00, 1261102-01, 1261102-02, 1261301-00, 1261301-01, 1261301-02, 1261601-00, 1261601-01, 1261602-00, 1261602-01, 1261602-02, 1261602-03, 1261604-03, 1360501-00, 1360501-01, 1361101-00, 1361101-01, 1361101-02, 1361101-03, 1361102-00, 1361102-01, 1361102-02, 1361102-03, 1361301-00, 1361301-01, 1361301-02, 1361301-03, 1361601-00, 1361601-01, 1361601-02, 1361602-00, 1361602-01, 1361602-02, 1361604-02, 1461101-01, 1461101-02, 1461101-03, 1461102-01, 1461102-02, 1461102-03, 1461104-01, 1461104-02, 1461104-03, 1461105-01, 1461105-02, 1461105-03... (Other models you can see in the webshop)		
accessories for	100039		
	Part No.	100115	Ref. No.
			—
	union nut ID ø M22x1mm		

miscellaneous



Part No.	nla ¹	Ref. No.	201536
description	piezoelectric igniter body metal connection F6.3x0.8 2 hole fixing ø 22mm		
For models:	0260501-00, 0261101-00, 0261101-01, 0261102-00, 0261102-01, 0261103-00, 0261103-01, 0261301-00, 0261601-00, 0261401-00, 0261401-01, 0261401A00, 0261401B00, 0261401C00, 0261402-00, 0261402-01, 0261402A00, 0261402B00, 0261402C00		

¹no longer available



Part No.	nla ¹	Ref. No.	201535
description	piezoelectric igniter suitable for Minisit with cover cap ømm connection F6.3x0.8		
spare parts for	101136		
	Part No.	100001	Ref. No.
			—
	piezoelectric igniter suitable for Minisit connection F6.3x0.8 ømm		

¹no longer available

thermocouples

plug-in thermocouples

plug-in thermocouples standard

with barrel socket ø5mm - type Junkers with aluminised tip

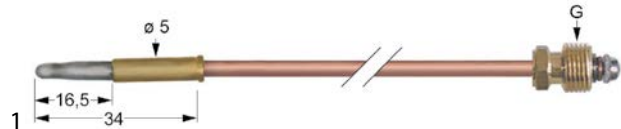

Part No.	102132	Ref. No.	201513
description	thermocouple M10x1 L 1000mm plug connection ø5.0mm		
For models:	0260301-01, 0260302-01, 1461101-00, 1461102-00, 1461103-00, 1462101-00, 1462101-01, 1462101-02, 1462101-0, 1462102-00, 1462102-00_V2, 1462102-01, 2061101-00, 2061102-00, 2061103-00, 2061401-02, 2061401-03, 2061401-04, 2061401A01, 2061401A02, 2061401A03, 2061401B01, 2061401B02, 2061401B03, 2061401C01, 2061401C02, 2061401C03, 2061402-02, 2061402-03, 2061402-04, 2061402A01, 2061402A02, 2061402A03, 2061402B01, 2061402B02, 2061402B03, 2061402C01, 2061402C02, 2061402C03, 2062806-00, 2062806A00, 2062806B00, 2062806B01, 2062806B02, 2062806B03, 2062806C00, 2062806C01, 2062806C02, 2062806C03, 2063404-00... (Other models you can see in the webshop)		



with barrel socket ø6mm

SIT

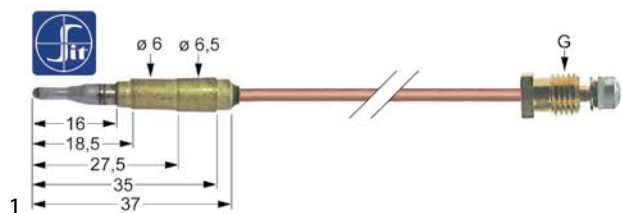

Part No. 102267 **Ref. No.** 201670

description thermocouple M8x1 L 850mm plug connection ø6.0mm

For models: 1260501-00, 1261101-00, 1261101-01, 1261101-02, 1261102-00, 1261102-01, 1261102-02, 1261602-00, 1261602-01, 1261602-02, 1261602-03, 1261604-03, 1360501-00, 1360501-01, 1361101-00, 1361101-01, 1361101-02, 1361101-03, 1361102-00, 1361102-01, 1361102-02, 1361102-03, 1361602-00, 1361602-01, 1361602-02, 1361604-02, 1460503-01, 1461101-01, 1461101-02, 1461101-03, 1461102-01, 1461102-02, 1461102-03, 1461104-01, 1461104-02, 1461104-03, 1461105-01, 1461105-02, 1461105-03, 1461109-01, 1461109-02, 1461109A01, 1461109A02, 1461602-00, 1462101-03, 1462101-04, 1462102-02, 1462102-03, 1561110-00, 2061101-01... (Other models you can see in the webshop)

with barrel socket ø6(6.5)mm

thermocouples SIT

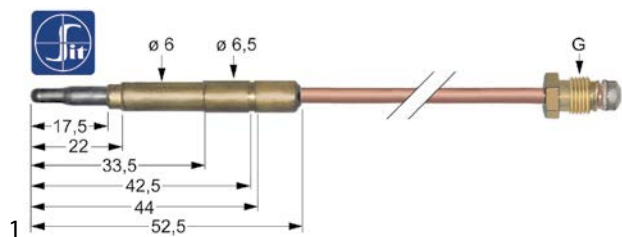

Part No. 107617 **Ref. No.** 201669

description thermocouple SIT M10x1 L 600mm plug connection ø6.0(6.5)mm

For models: 1260301-00, 1260301-01, 1260302-00, 1260302-01, 1460302-01, 1460302-02, 2060301-01, 2060301-02

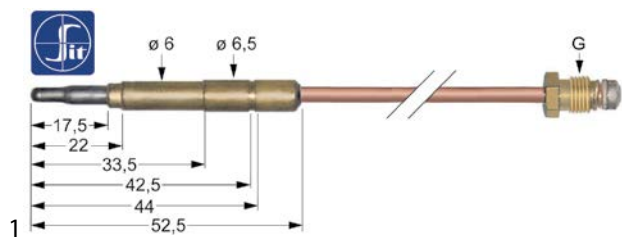

Part No. 107601 **Ref. No.** 201668

description thermocouple SIT M8x1 L 600mm plug connection ø6.0(6.5)mm

For models: 1261301-00, 1261301-01, 1261301-02, 1261601-00, 1261601-01, 1361301-00, 1361301-01, 1361301-02, 1361301-03, 1361601-00, 1361601-01, 1361601-02, 1461601-00, 2061301-01

threaded thermocouples

threaded thermocouples standard

with socket with thread M8x1

SIT

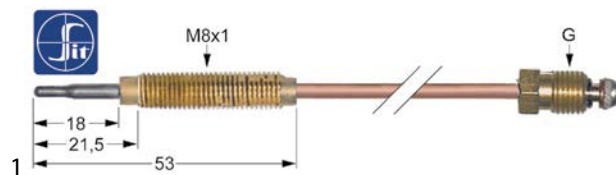

Part No. 107645 **Ref. No.** 201538

description thermocouple SIT M10x1 L 1500mm M8x1

accessories for 107645



Part No. 102067 **Ref. No.** 201524
nut thread M8x1 H 3mm brass Qty 1 pcs type SEF 1

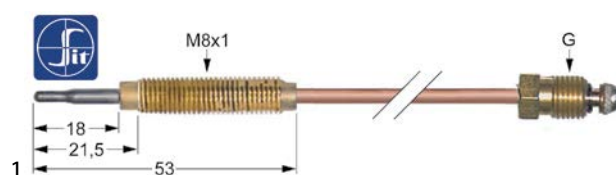

Part No. 107643 **Ref. No.** 201533

description thermocouple SIT M10x1 L 600mm M8x1

accessories for 107643



Part No. 102067 **Ref. No.** 201524
nut thread M8x1 H 3mm brass Qty 1 pcs type SEF 1

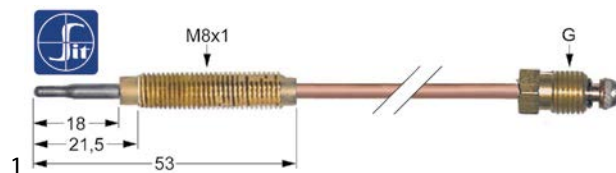

Part No. 107632 **Ref. No.** 201352, 201532, 201539

description thermocouple SIT M8x1 L 1000mm M8x1

For models: 0261301-00, 0263401-00, 0263401-01, 1263401-00, 1263402-00, 1263402-01, 1263402-02, 1263404-00, 1263404-01, 1263404-02, 1263405-00, 1263405-01, 1263413-02, 1263414-02, 1363401-00, 1363402-00, 1363402-01, 1363402-02, 1363403-00, 1363403-01, 1363403-02, 1363403-03, 1363403-04, 1363403-05, 1363404-00, 1363404-01, 1363404-02, 1363404-03, 1363405-00, 1363405-01, 1363413-03, 1363415-05, 1463501-04, 1463501-05, 1464802-01, 1464802-02, 1464803-01, 1464803-02, 1464803-03, 1464808-01, 1464808-02, 1464808-03, 1464809-01, 1464809-02, 1464809-03, 1464810-01, 1464810-02, 1464811-01, 1464811-02, 1464812-00... (Other models you can see in the webshop)

accessories for 107632



Part No. 102067 **Ref. No.** 201524
nut thread M8x1 H 3mm brass Qty 1 pcs type SEF 1



Part No.	107633	Ref. No.	201534
description	thermocouple SIT M8x1 L 1200mm M8x1		
For models:	1463501-00		
accessories for	107633		
	Part No.	102067	Ref. No. 201524
	nut thread M8x1 H 3mm brass Qty 1 pcs type SEF 1		

Part No.	107629	Ref. No.	201530
description	thermocouple SIT M8x1 L 450mm M8x1		

accessories

displays

Part No.	101414	Ref. No.	201554
description	display soldering connection		
For models:	2062801-00, 2062801A00, 2062801B00, 2062801C00, 2062802-00, 20628022-0, 20628022-1, 20628022-2, 2062802A00, 2062802B00, 2062802C00, 2062803-00, 20628033-0, 20628033-1, 20628033-2, 2062803A00, 2062803B00, 2062803C00, 2062804-00, 20628044-0, 20628044-1, 20628044-2, 2062804A00, 2062804B00, 2062804C00, 2062806-00, 2062806A00, 2062806B00, 2062806B01, 2062806B02, 2062806B03, 2062806C00, 2062806C01, 2062806C02, 2062806C03, 2062901-00, 20629011-0, 20629011-1, 20629011-2, 2062901A00, 2062901B00, 2062901B01, 2062901B02, 2062901B03, 2062901B04, 2062901B05, 2062901C00, 2062901C01, 2062901C02, 2062901C03... (Other models you can see in the webshop)		

nuts

Part No.	102067	Ref. No.	201524
description	nut thread M8x1 H 3mm brass Qty 1 pcs type SEF 1		
For models:	0260301-00, 0260302-00, 0260501-00, 0261101-00, 0261101-01, 0261102-00, 0261102-01, 0261103-00, 0261103-01, 0261301-00, 0261601-00, 0263401-00, 0263401-01, 1263401-00, 1263402-00, 1263402-01, 1263402-02, 1263404-00, 1263404-01, 1263404-02, 1263405-00, 1263405-01, 1263413-02, 1263414-02, 1363401-00, 1363402-00, 1363402-01, 1363402-02, 1363403-00, 1363403-01, 1363403-02, 1363403-03, 1363403-04, 1363403-05, 1363404-00, 1363404-01, 1363404-02, 1363404-03, 1363405-00, 1363405-01, 1363413-03, 1363415-05, 14621011-0, 1462831-00, 1462832-00, 1462833-00, 1462834-00, 1462835-00, 1462836-00, 1462837-00... (Other models you can see in the webshop)		

Part No.	100965	Ref. No.	201525
description	thermocouple nut thread M8x1 H 15mm WS 11 brass Qty 1 pcs		
For models:	0263401-00, 0263401-01, 1263401-00, 1263402-00, 1263402-01, 1263402-02, 1263404-00, 1263404-01, 1263404-02, 1263405-00, 1263405-01, 1263413-02, 1263414-02, 1363401-00, 1363402-00, 1363402-01, 1363402-02, 1363403-00, 1363403-01, 1363403-02, 1363403-03, 1363403-04, 1363403-05, 1363404-00, 1363404-01, 1363404-02, 1363404-03, 1363405-00, 1363405-01, 1363413-03, 1363415-05, 1464802-01, 1464802-02, 1464803-01, 1464803-02, 1464803-03, 1464808-01, 1464808-02, 1464808-03, 1464809-01, 1464809-02, 1464809-03, 1464810-01, 1464810-02, 1464811-01, 1464811-02, 1464812-00, 1464812-01, 1464812-02, 2063401-00... (Other models you can see in the webshop)		

SCREWS

Part No.	101262	Ref. No.	201123
description	thermocouple fitting thread M10x1 Qty 1 pcs		
For models:	1462101-03, 1462101-04, 2062901B02, 2062901C02, 2062902B02, 2062902C02, 2063404-05, 2063404-06, 2063404-07, 2063407-05, 2063407-06, 2063407-07, 2063416-02, 2063419-02, 2063503-06, 2063503-07, 2063508-05, 2063508-06		

interrupters

Part No.	101258	Ref. No.	201478 203478
description	interrupter thread M10x1		
For models:	0260301-00, 0260301-01, 0260302-00, 0260302-01, 1260301-00, 1260301-01, 1260302-00, 1260302-01, 1460302-00, 1460302-01, 1460302-02, 2060301-00, 2060301-01, 2060301-02, 20628022-0, 20628022-1, 20628022-2, 20628033-0, 20628033-1, 20628033-2, 20628044-0, 20628044-1, 20628044-2, 20629011-0, 20629011-1, 20629011-2, 20629022-0, 20629022-1, 20629022-2, 2160501-00		

ignition bridges

Part No.	104296	Ref. No.	201620
description	ignition bridge L 330mm		
For models:	14621011-0, 2060501-00, 2060501-01, 20605011-0		



			
Part No.	105930	Ref. No.	201612
description	ignition bridge L 530mm		

gas burners

hob burners

producer-specific hob burners

MKN

burner head 29mm

			
Part No.	104214	Ref. No.	201863
description	air mixing tube ID ø 12mm C		
For models:	1260501-00, 1263401-00, 1263402-00, 1263402-01, 1263402-02, 1263404-00, 1263404-01, 1263404-02, 1263413-02, 1263414-02, 1360501-00, 1360501-01, 1363401-00, 1363402-00, 1363402-01, 1363402-02, 1363403-00, 1363403-01, 1363403-02, 1363403-03, 1363403-04, 1363403-05, 1363404-00, 1363404-01, 1363404-02, 1363404-03, 1363413-03, 1363415-05, 1460503-01, 1464802-01, 1464802-02, 1464803-01, 1464803-02, 1464803-03, 1464808-01, 1464808-02, 1464808-03, 1464809-01, 1464809-02, 1464809-03, 1464810-01, 1464810-02, 1464811-01, 1464811-02, 2063401-00, 2063401-01, 2063401-02, 2063401-03, 2063401-04, 2063401-05... (Other models you can see in the webshop)		

			
Part No.	104215	Ref. No.	201864
description	air mixing tube ID ø 14mm D		
For models:	0261601-00, 1261301-00, 1261301-01, 1261301-02, 1261601-00, 1261601-01, 1261602-00, 1261602-01, 1261602-02, 1261602-03, 1261604-03, 1263402-00, 1263402-01, 1263402-02, 1263404-00, 1263404-01, 1263404-02, 1263413-02, 1263414-02, 1361301-00, 1361301-01, 1361301-02, 1361301-03, 1361601-00, 1361601-01, 1361601-02, 1361602-00, 1361602-01, 1361602-02, 1361604-02, 1363402-00, 1363402-01, 1363402-02, 1363403-00, 1363403-01, 1363403-02, 1363403-03, 1363403-04, 1363403-05, 1363404-00, 1363404-01, 1363404-02, 1363404-03, 1363413-03, 1363415-05, 1461601-00, 1461602-00, 14621011-0, 1462802B00, 1462804B00... (Other models you can see in the webshop)		

			
Part No.	103090	Ref. No.	201618
description	burner cap C ø 78mm		
For models:	0263401-00, 0263401-01, 1263401-00, 1263402-00, 1263402-01, 1263402-02, 1263404-00, 1263404-01, 1263404-02, 1263413-02, 1263414-02, 1363401-00, 1363402-00, 1363402-01, 1363402-02, 1363403-00, 1363403-01, 1363403-02, 1363403-03, 1363403-04, 1363403-05, 1363404-00, 1363404-01, 1363404-02, 1363404-03, 1363413-03, 1363415-05, 1464802-01, 1464802-02, 1464803-01, 1464803-02, 1464803-03, 1464808-01, 1464808-02, 1464808-03, 1464809-01, 1464809-02, 1464809-03, 1464810-01, 1464810-02, 1464811-01, 1464811-02, 2063401-00, 2063401-01, 2063401-02, 2063401-03, 2063401-04, 2063401-05, 2063401-06, 2063401-07... (Other models you can see in the webshop)		

			
Part No.	104362	Ref. No.	201619
description	burner cap D ø 94mm with central hole		
For models:	2063401-00, 20634011-0, 2063402-00, 20634022-0, 2063403-00, 2063404-00, 2063405-00, 20634055-0, 2063406-00, 2063407-00, 2063413-00, 2063414-00, 2063415-00, 2063417-00, 2063418-00, 2083202A00, 2083501B00, 2083501C00, 2083502B00, 2083502B01, 2083502C00, 2083502C01		

			
Part No.	104088	Ref. No.	201855 550069
description	burner head C for burner cap ø 78mm H 29mm		
For models:	0263401-00, 2063401-00, 20634011-0, 2063402-00, 20634022-0, 2063403-00, 2063404-00, 2063405-00, 20634055-0, 2063406-00, 2063407-00, 2063413-00, 2063414-00, 2063415-00, 2063417-00, 2063418-00, 2163401-00, 2163402-00, 2163403-00, 2163404-00, 2163405-00, 2163406-00, 2163407-00		

			
Part No.	104089	Ref. No.	201856 550070
description	burner head D for burner cap ø 94mm H 29mm		
For models:	2063401-00, 20634011-0, 2063402-00, 20634022-0, 2063403-00, 2063404-00, 2063405-00, 20634055-0, 2063406-00, 2063407-00, 2063413-00, 2063414-00, 2063415-00, 2063417-00, 2063418-00, 2083202A00, 2083501B00, 2083501C00, 2083502B00, 2083502B01, 2083502C00, 2083502C01		

			
Part No.	104098	Ref. No.	201842
description	burner lower part		
For models:	1263401-00, 1263402-00, 1263402-01, 1263402-02, 1263404-00, 1263404-01, 1263404-02, 1263413-02, 1263414-02, 1363401-00, 1363402-00, 1363402-01, 1363402-02, 1363403-00, 1363403-01, 1363403-02, 1363403-03, 1363403-04, 1363403-05, 1363404-00, 1363404-01, 1363404-02, 1363404-03, 1363413-03, 1363415-05, 1464802-01, 1464802-02, 1464803-01, 1464803-02, 1464803-03, 1464808-01, 1464808-02, 1464808-03, 1464809-01, 1464809-02, 1464809-03, 1464810-01, 1464810-02, 1464811-01, 1464811-02, 2063401-00, 2063401-01, 2063401-02, 2063401-03, 2063401-04, 2063401-05, 2063401-06, 20634011-0, 2063402-00, 2063402-01... (Other models you can see in the webshop)		

1 gas components



1			
Part No.		Ref. No.	201843
description	burner lower part		

2			
Part No.	104205	Ref. No.	211020
description	gasket C for burner head		
For models:	0263401-00, 0263401-01, 1263401-00, 1263402-00, 1263402-01, 1263402-02, 1263404-00, 1263404-01, 1263404-02, 1263413-02, 1263414-02, 1363401-00, 1363402-00, 1363402-01, 1363402-02, 1363403-00, 1363403-01, 1363403-02, 1363403-03, 1363403-04, 1363403-05, 1363404-00, 1363404-01, 1363404-02, 1363404-03, 1363413-03, 1363415-05, 1464802-01, 1464802-02, 1464803-01, 1464803-02, 1464803-03, 1464808-01, 1464808-02, 1464808-03, 1464809-01, 1464809-02, 1464809-03, 1464810-01, 1464810-02, 1464811-01, 1464811-02, 2063401-00, 2063401-01, 2063401-02, 2063401-03, 2063401-04, 2063401-05, 2063401-06, 20634011-0... (Other models you can see in the webshop)		

1			
Part No.	104206	Ref. No.	211021
description	gasket D for burner head		
For models:	1464803-02, 1464803-03, 1464808-02, 1464808-03, 1464809-02, 1464809-03, 2063401-00, 2063401-03, 2063401-04, 2063401-05, 2063401-06, 20634011-0, 2063402-00, 2063402-04, 2063402-05, 2063402-06, 20634022-0, 2063403-00, 2063403-07, 2063403-08, 2063403-09, 2063403-10, 2063404-00, 2063404-04, 2063404-05, 2063404-06, 2063404-07, 2063405-00, 2063405-04, 2063405-05, 2063405-06, 20634055-0, 2063406-00, 2063406-07, 2063406-08, 2063406-09, 2063406-10, 2063407-00, 2063407-04, 2063407-05, 2063407-06, 2063407-07, 2063413-00, 2063413-02, 2063414-00, 2063414-03, 2063415-00, 2063415-05, 2063416-02, 2063417-00... (Other models you can see in the webshop)		

1			
Part No.	104212	Ref. No.	211018
description	O-ring Viton thickness 3mm ID ø 32.5mm Qty 1 pcs		
For models:	0263401-00, 0263401-01, 1220501-00, 1220501-01, 1220501-02, 1220502-00, 1220502-01, 1220802-00, 1220802-01, 1222507-00, 1222509-00, 1263401-00, 1263402-00, 1263402-01, 1263402-02, 1263404-00, 1263404-01, 1263404-02, 1263413-02, 1263414-02, 1320501-00, 1320502-00, 1320802-00, 1322507-00, 1322509-00, 1363401-00, 1363402-00, 1363402-01, 1363402-02, 1363403-00, 1363403-01, 1363403-02, 1363403-03, 1363403-04, 1363403-05, 1363404-00, 1363404-01, 1363404-02, 1363404-03, 1363413-03, 1363415-05, 1422513B00, 1422513B01, 1422515B01, 1422515B02, 1422701-00, 1422701-01, 1422701-02, 1422701-03, 1422702-00... (Other models you can see in the webshop)		

1			
Part No.	104204	Ref. No.	204457
description	spacer piece		
For models:	1464803-01, 1464803-02, 1464803-03, 1464808-01, 1464808-02, 1464808-03, 1464809-01, 1464809-02, 1464809-03, 2063401-00, 2063401-01, 2063401-02, 2063401-03, 2063401-04, 2063401-05, 2063401-06, 20634011-0, 2063402-00, 2063402-01, 2063402-02, 2063402-03, 2063402-04, 2063402-05, 2063402-06, 20634022-0, 2063403-00, 2063403-01, 2063403-02, 2063403-03, 2063403-04, 2063403-05, 2063403-06, 2063403-07, 2063403-08, 2063403-09, 2063403-10, 2063404-00, 2063404-01, 2063404-02, 2063404-03, 2063404-04, 2063404-05, 2063404-06, 2063404-07, 2063405-00, 2063405-01, 2063405-02, 2063405-03, 2063405-04, 2063405-05... (Other models you can see in the webshop)		

1			
Part No.	104213	Ref. No.	201845
description	venturi C/D		
For models:	1263401-00, 1263402-00, 1263402-01, 1263402-02, 1263404-00, 1263404-01, 1263404-02, 1263413-02, 1263414-02, 1363401-00, 1363402-00, 1363402-01, 1363402-02, 1363403-00, 1363403-01, 1363403-02, 1363403-03, 1363403-04, 1363403-05, 1363404-00, 1363404-01, 1363404-02, 1363404-03, 1363413-03, 1363415-05, 1464802-01, 1464802-02, 1464803-01, 1464803-02, 1464803-03, 1464808-01, 1464808-02, 1464808-03, 1464809-01, 1464809-02, 1464809-03, 1464810-01, 1464810-02, 1464811-01, 1464811-02, 2063401-00, 2063401-01, 2063401-02, 2063401-03, 2063401-04, 2063401-05, 2063401-06, 20634011-0, 2063402-00, 2063402-01... (Other models you can see in the webshop)		

burner head 34mm			
1			
Part No.	104214	Ref. No.	201863
description	air mixing tube ID ø 12mm C		
For models:	1260501-00, 1263401-00, 1263402-00, 1263402-01, 1263402-02, 1263404-00, 1263404-01, 1263404-02, 1263413-02, 1263414-02, 1360501-00, 1360501-01, 1363401-00, 1363402-00, 1363402-01, 1363402-02, 1363403-00, 1363403-01, 1363403-02, 1363403-03, 1363403-04, 1363403-05, 1363404-00, 1363404-01, 1363404-02, 1363404-03, 1363413-03, 1363415-05, 1460503-01, 1464802-01, 1464802-02, 1464803-01, 1464803-02, 1464803-03, 1464808-01, 1464808-02, 1464808-03, 1464809-01, 1464809-02, 1464809-03, 1464810-01, 1464810-02, 1464811-01, 1464811-02, 2063401-00, 2063401-01, 2063401-02, 2063401-03, 2063401-04, 2063401-05... (Other models you can see in the webshop)		

1			
Part No.	104215	Ref. No.	201864
description	air mixing tube ID ø 14mm D		
For models:	0261601-00, 1261301-00, 1261301-01, 1261301-02, 1261601-00, 1261601-01, 1261602-00, 1261602-01, 1261602-02, 1261602-03, 1261604-03, 1263402-00, 1263402-01, 1263402-02, 1263404-00, 1263404-01, 1263404-02, 1263413-02, 1263414-02, 1361301-00, 1361301-01, 1361301-02, 1361301-03, 1361601-00, 1361601-01, 1361601-02, 1361602-00, 1361602-01, 1361602-02, 1361604-02, 1363402-00, 1363402-01, 1363402-02, 1363403-00, 1363403-01, 1363403-02, 1363403-03, 1363403-04, 1363403-05, 1363404-00, 1363404-01, 1363404-02, 1363404-03, 1363413-03, 1363415-05, 1461601-00, 1461602-00, 14621011-0, 1462802B00, 1462804B00... (Other models you can see in the webshop)		





			
Part No.	104606	Ref. No.	201767
description	air mixing tube ID ø 16mm E		
For models:	1464803-02, 1464803-03, 1464808-02, 1464808-03, 1464809-02, 1464809-03, 2063401-03, 2063401-04, 2063401-05, 2063401-06, 2063402-04, 2063402-05, 2063402-06, 2063403-07, 2063403-08, 2063403-09, 2063403-10, 2063404-04, 2063404-05, 2063404-06, 2063404-07, 2063405-04, 2063405-05, 2063405-06, 2063406-07, 2063406-08, 2063406-09, 2063406-10, 2063407-04, 2063407-05, 2063407-06, 2063407-07, 2063413-02, 2063414-03, 2063415-05, 2063416-02, 2063417-03, 2063418-05, 2063419-02, 3063401-02, 3063401-03, 3063401-04, 3063402-02, 3063402-03, 3063402-04, 3063405-02, 3063405-03, 3063405-04		

			
Part No.	103090	Ref. No.	201618
description	burner cap C ø 78mm		
For models:	0263401-00, 0263401-01, 1263401-00, 1263402-00, 1263402-01, 1263402-02, 1263404-00, 1263404-01, 1263404-02, 1263413-02, 1263414-02, 1363401-00, 1363402-00, 1363402-01, 1363402-02, 1363403-00, 1363403-01, 1363403-02, 1363403-03, 1363403-04, 1363403-05, 1363404-00, 1363404-01, 1363404-02, 1363404-03, 1363413-03, 1363415-05, 1464802-01, 1464802-02, 1464803-01, 1464803-02, 1464803-03, 1464808-01, 1464808-02, 1464808-03, 1464809-01, 1464809-02, 1464809-03, 1464810-01, 1464810-02, 1464811-01, 1464811-02, 2063401-00, 2063401-01, 2063401-02, 2063401-03, 2063401-04, 2063401-05, 2063401-06, 20634011-0... (Other models you can see in the webshop)		

			
Part No.	103092	Ref. No.	201661
description	burner cap D ø 87mm		
For models:	1263402-00, 1263402-01, 1263402-02, 1263404-00, 1263404-01, 1263404-02, 1263413-02, 1263414-02, 1363402-00, 1363402-01, 1363402-02, 1363403-00, 1363403-01, 1363403-02, 1363403-03, 1363403-04, 1363403-05, 1363404-00, 1363404-01, 1363404-02, 1363404-03, 1363413-03, 1363415-05, 1464802-01, 1464802-02, 1464803-01, 1464803-02, 1464803-03, 1464808-01, 1464808-02, 1464808-03, 1464809-01, 1464809-02, 1464809-03, 1464810-01, 1464810-02, 1464811-01, 1464811-02, 2063401-01, 2063401-02, 2063402-01, 2063402-02, 2063402-03, 2063402-04, 2063402-05, 2063402-06, 2063403-01, 2063403-02, 2063403-03, 2063403-04, 2063403-05, 2063403-06... (Other models you can see in the webshop)		

			
Part No.	105620	Ref. No.	201769
description	burner cap E ø 114mm with central hole bore ø 2.7mm		
For models:	1464803-02, 1464803-03, 1464808-02, 1464808-03, 1464809-02, 1464809-03, 2063401-03, 2063401-04, 2063401-05, 2063401-06, 2063402-04, 2063402-05, 2063402-06, 2063403-07, 2063403-08, 2063403-09, 2063403-10, 2063404-04, 2063404-05, 2063404-06, 2063404-07, 2063405-04, 2063405-05, 2063405-06, 2063406-07, 2063406-08, 2063406-09, 2063406-10, 2063407-04, 2063407-05, 2063407-06, 2063407-07, 2063413-02, 2063414-03, 2063415-05, 2063416-02, 2063417-03, 2063418-05, 2063419-02, 3063401-02, 3063401-03, 3063401-04, 3063402-02, 3063402-03, 3063402-04, 3063405-02, 3063405-03, 3063405-04		

			
Part No.	104207	Ref. No.	201102
description	burner head C for burner cap ø 78mm H 34mm		
For models:	0263401-01, 1263401-00, 1263402-00, 1263402-01, 1263402-02, 1263404-00, 1263404-01, 1263404-02, 1263413-02, 1263414-02, 1363401-00, 1363402-00, 1363402-01, 1363402-02, 1363403-00, 1363403-01, 1363403-02, 1363403-03, 1363403-04, 1363403-05, 1363404-00, 1363404-01, 1363404-02, 1363404-03, 1363413-03, 1363415-05, 1464802-01, 1464802-02, 1464803-01, 1464803-02, 1464803-03, 1464808-01, 1464808-02, 1464808-03, 1464809-01, 1464809-02, 1464809-03, 1464810-01, 1464810-02, 1464811-01, 1464811-02, 2063401-01, 2063401-02, 2063401-03, 2063401-04, 2063401-05, 2063401-06, 2063402-01, 2063402-02, 2063402-03... (Other models you can see in the webshop)		

							
Part No.	104208	Ref. No.	201104				
description	burner head D for burner cap ø 87mm H 34mm						
For models:	1263402-00, 1263402-01, 1263402-02, 1263404-00, 1263404-01, 1263404-02, 1263413-02, 1263414-02, 1363402-00, 1363402-01, 1363402-02, 1363403-00, 1363403-01, 1363403-02, 1363403-03, 1363403-04, 1363403-05, 1363404-00, 1363404-01, 1363404-02, 1363404-03, 1363413-03, 1363415-05, 1464802-01, 1464802-02, 1464803-01, 1464803-02, 1464803-03, 1464808-01, 1464808-02, 1464808-03, 1464809-01, 1464809-02, 1464809-03, 1464810-01, 1464810-02, 1464811-01, 1464811-02, 2063401-01, 2063401-02, 2063402-01, 2063402-02, 2063402-03, 2063402-04, 2063402-05, 2063402-06, 2063403-01, 2063403-02, 2063403-03, 2063403-04, 2063403-05, 2063403-06... (Other models you can see in the webshop)						
accessories for	104208						
	<table border="1"> <tr> <td>Part No.</td> <td>103092</td> <td>Ref. No.</td> <td>201661</td> </tr> </table>	Part No.	103092	Ref. No.	201661		
Part No.	103092	Ref. No.	201661				
		burner cap D ø 87mm					

			
Part No.	104453	Ref. No.	201157
description	burner head D for burner cap ø 87mm H 41mm		





			
1			
Part No.	104604	Ref. No.	201768
description	burner head E for burner cap ø 114mm H 34mm		
For models:	1464803-02, 1464803-03, 1464808-02, 1464808-03, 1464809-02, 1464809-03, 2063401-03, 2063401-04, 2063401-05, 2063401-06, 2063402-04, 2063402-05, 2063402-06, 2063403-07, 2063403-08, 2063403-09, 2063403-10, 2063404-04, 2063404-05, 2063404-06, 2063404-07, 2063405-04, 2063405-05, 2063405-06, 2063406-07, 2063406-08, 2063406-09, 2063406-10, 2063407-04, 2063407-05, 2063407-06, 2063407-07, 2063413-02, 2063414-03, 2063415-05, 2063416-02, 2063417-03, 2063418-05, 2063419-02, 3063401-02, 3063401-03, 3063401-04, 3063402-02, 3063402-03, 3063402-04, 3063405-02, 3063405-03, 3063405-04		

			
1			
Part No.	104206	Ref. No.	211021
description	gasket D for burner head		
For models:	1464803-02, 1464803-03, 1464808-02, 1464808-03, 1464809-02, 1464809-03, 2063401-00, 2063401-03, 2063401-04, 2063401-05, 2063401-06, 2063401-10, 2063402-00, 2063402-04, 2063402-05, 2063402-06, 2063402-07, 2063403-08, 2063403-09, 2063403-10, 2063404-00, 2063404-04, 2063404-05, 2063404-06, 2063404-07, 2063405-00, 2063405-04, 2063405-05, 2063405-06, 2063405-0, 2063406-00, 2063406-07, 2063406-08, 2063406-09, 2063406-10, 2063407-00, 2063407-04, 2063407-05, 2063407-06, 2063407-07, 2063413-00, 2063413-02, 2063414-00, 2063414-03, 2063415-00, 2063415-05, 2063416-02, 2063417-00... (Other models you can see in the webshop)		

			
2			
Part No.	104098	Ref. No.	201842
description	burner lower part		
For models:	1263401-00, 1263402-00, 1263402-01, 1263402-02, 1263404-00, 1263404-01, 1263404-02, 1263413-02, 1263414-02, 1363401-00, 1363402-00, 1363402-01, 1363402-02, 1363403-00, 1363403-01, 1363403-02, 1363403-03, 1363403-04, 1363403-05, 1363404-00, 1363404-01, 1363404-02, 1363404-03, 1363413-03, 1363415-05, 1464802-01, 1464802-02, 1464803-01, 1464803-02, 1464803-03, 1464808-01, 1464808-02, 1464808-03, 1464809-01, 1464809-02, 1464809-03, 1464810-01, 1464810-02, 1464811-01, 1464811-02, 2063401-00, 2063401-01, 2063401-02, 2063401-03, 2063401-04, 2063401-05, 2063401-06, 2063401-10, 2063402-00, 2063402-01... (Other models you can see in the webshop)		

			
1			
Part No.	104212	Ref. No.	211018
description	O-ring Viton thickness 3mm ID ø 32.5mm Qty 1 pcs		
For models:	0263401-00, 0263401-01, 1220501-00, 1220501-01, 1220501-02, 1220502-00, 1220502-01, 1220802-00, 1220802-01, 1222507-00, 1222509-00, 1263401-00, 1263402-00, 1263402-01, 1263402-02, 1263404-00, 1263404-01, 1263404-02, 1263413-02, 1263414-02, 1320501-00, 1320502-00, 1320802-00, 1322507-00, 1322509-00, 1363401-00, 1363402-00, 1363402-01, 1363402-02, 1363403-00, 1363403-01, 1363403-02, 1363403-03, 1363403-04, 1363403-05, 1363404-00, 1363404-01, 1363404-02, 1363404-03, 1363413-03, 1363415-05, 1422513B00, 1422513B01, 1422515B01, 1422515B02, 1422701-00, 1422701-01, 1422701-02, 1422701-03, 1422702-00... (Other models you can see in the webshop)		

			
1			
Part No.	104205	Ref. No.	211020
description	gasket C for burner head		
For models:	0263401-00, 0263401-01, 1263401-00, 1263402-00, 1263402-01, 1263402-02, 1263404-00, 1263404-01, 1263404-02, 1263413-02, 1263414-02, 1363401-00, 1363402-00, 1363402-01, 1363402-02, 1363403-00, 1363403-01, 1363403-02, 1363403-03, 1363403-04, 1363403-05, 1363404-00, 1363404-01, 1363404-02, 1363404-03, 1363413-03, 1363415-05, 1464802-01, 1464802-02, 1464803-01, 1464803-02, 1464803-03, 1464808-01, 1464808-02, 1464808-03, 1464809-01, 1464809-02, 1464809-03, 1464810-01, 1464810-02, 1464811-01, 1464811-02, 2063401-00, 2063401-01, 2063401-02, 2063401-03, 2063401-04, 2063401-05, 2063401-06, 2063401-10, 2063402-00, 2063402-01... (Other models you can see in the webshop)		

			
1			
Part No.	104204	Ref. No.	204457
description	spacer piece		
For models:	1464803-01, 1464803-02, 1464803-03, 1464808-01, 1464808-02, 1464808-03, 1464809-01, 1464809-02, 1464809-03, 2063401-00, 2063401-01, 2063401-02, 2063401-03, 2063401-04, 2063401-05, 2063401-06, 2063401-10, 2063402-00, 2063402-01, 2063402-02, 2063402-03, 2063402-04, 2063402-05, 2063402-06, 2063402-07, 2063403-00, 2063403-01, 2063403-02, 2063403-03, 2063403-04, 2063403-05, 2063403-06, 2063403-07, 2063403-08, 2063403-09, 2063403-10, 2063404-00, 2063404-01, 2063404-02, 2063404-03, 2063404-04, 2063404-05, 2063404-06, 2063404-07, 2063405-00, 2063405-01, 2063405-02, 2063405-03, 2063405-04, 2063405-05... (Other models you can see in the webshop)		

			
1			
Part No.	104213	Ref. No.	201845
description	venturi C/D		
For models:	1263401-00, 1263402-00, 1263402-01, 1263402-02, 1263404-00, 1263404-01, 1263404-02, 1263413-02, 1263414-02, 1363401-00, 1363402-00, 1363402-01, 1363402-02, 1363403-00, 1363403-01, 1363403-02, 1363403-03, 1363403-04, 1363403-05, 1363404-00, 1363404-01, 1363404-02, 1363404-03, 1363413-03, 1363415-05, 1464802-01, 1464802-02, 1464803-01, 1464803-02, 1464803-03, 1464808-01, 1464808-02, 1464808-03, 1464809-01, 1464809-02, 1464809-03, 1464810-01, 1464810-02, 1464811-01, 1464811-02, 2063401-00, 2063401-01, 2063401-02, 2063401-03, 2063401-04, 2063401-05, 2063401-06, 2063401-10, 2063402-00, 2063402-01... (Other models you can see in the webshop)		





			
1			
Part No.	104605	Ref. No.	201766
description	venturi E long		
For models:	1464803-02, 1464803-03, 1464808-02, 1464808-03, 1464809-02, 1464809-03, 2063401-03, 2063401-04, 2063401-05, 2063401-06, 2063402-04, 2063402-05, 2063402-06, 2063403-07, 2063403-08, 2063403-09, 2063403-10, 2063404-04, 2063404-05, 2063404-06, 2063404-07, 2063405-04, 2063405-05, 2063405-06, 2063406-07, 2063406-08, 2063406-09, 2063406-10, 2063407-04, 2063407-05, 2063407-06, 2063407-07, 2063413-02, 2063414-03, 2063415-05, 2063416-02, 2063417-03, 2063418-05, 2063419-02, 3063401-02, 3063401-03, 3063401-04, 3063402-02, 3063402-03, 3063402-04, 3063405-02, 3063405-03, 3063405-04		

			
1			
Part No.	105926	Ref. No.	201876
description	venturi E short		

pan supports			
			
1			
Part No.	210227	Ref. No.	201877
description	pan support W 275mm L 350mm		
For models:	0263401-01, 1263401-00, 1263402-00, 1263402-01, 1263402-02, 1263404-00, 1263404-01, 1263404-02, 1263413-02, 1263414-02, 1363401-00, 1363402-00, 1363402-01, 1363402-02, 1363403-00, 1363403-01, 1363403-02, 1363403-03, 1363403-04, 1363403-05, 1363404-00, 1363404-01, 1363404-02, 1363404-03, 1363413-03, 1363415-05, 1464802-01, 1464802-02, 1464810-01, 1464810-02, 1464811-01, 1464811-02, 2163401-01, 2163401-02, 2163401-03, 2163401-04, 2163401-05, 2163402-01, 2163402-02, 2163402-03, 2163402-04, 2163402-05, 2163403-01, 2163403-02, 2163403-03, 2163403-04, 2163403-05, 2163403-06, 2163403-07, 2163403-08... (Other models you can see in the webshop)		

			
1			
Part No.	210228	Ref. No.	201866 201878 445035
description	pan support W 350mm L 350mm H 35mm		
For models:	1464803-01, 1464808-01, 1464809-01, 2063401-00, 2063401-01, 2063401-02, 20634011-0, 2063402-00, 2063402-01, 2063402-02, 2063402-03, 20634022-0, 2063403-00, 2063403-01, 2063403-02, 2063403-03, 2063403-04, 2063403-05, 2063403-06, 2063404-00, 2063404-01, 2063404-02, 2063404-03, 2063405-00, 2063405-01, 2063405-02, 2063405-03, 20634055-0, 2063406-00, 2063406-01, 2063406-02, 2063406-03, 2063406-04, 2063406-05, 2063406-06, 2063407-00, 2063407-01, 2063407-02, 2063407-03, 2063413-00, 2063413-01, 2063414-00, 2063414-01, 2063414-02, 2063415-00, 2063415-01, 2063415-02, 2063415-03, 2063415-04, 2063416-00... (Other models you can see in the webshop)		

			
1			
Part No.	210231	Ref. No.	206001
description	pan support W 370mm L 700mm		
For models:	1464803-02, 1464803-03, 1464808-02, 1464808-03, 1464809-02, 1464809-03, 2063401-03, 2063401-04, 2063401-05, 2063401-06, 2063402-04, 2063402-05, 2063402-06, 2063403-07, 2063403-08, 2063403-09, 2063403-10, 2063404-04, 2063404-05, 2063404-06, 2063404-07, 2063405-04, 2063405-05, 2063405-06, 2063406-07, 2063406-08, 2063406-09, 2063406-10, 2063407-04, 2063407-05, 2063407-06, 2063407-07, 2063413-02, 2063414-03, 2063415-05, 2063416-02, 2063417-03, 2063418-05, 2063419-02, 3063401-02, 3063401-03, 3063401-04, 3063402-02, 3063402-03, 3063402-04, 3063405-02, 3063405-03, 3063405-04		

reducers for pan supports			
			
1			
Part No.	210015	Ref. No.	201848
description	reducer for pan support L 250mm W 250mm chrome-plated steel suitable for MKN		

accessories			
reducers for pan supports			
			
1			
Part No.	210015	Ref. No.	201848
description	reducer for pan support L 250mm W 250mm chrome-plated steel suitable for MKN		



pan supports



Part No.	210227	Ref. No.	201877
description	pan support W 275mm L 350mm		
For models:	0263401-01, 1263401-00, 1263402-00, 1263402-01, 1263402-02, 1263404-00, 1263404-01, 1263404-02, 1263413-02, 1263414-02, 1363401-00, 1363402-00, 1363402-01, 1363402-02, 1363403-00, 1363403-01, 1363403-02, 1363403-03, 1363403-04, 1363403-05, 1363404-00, 1363404-01, 1363404-02, 1363404-03, 1363413-03, 1363415-05, 1464802-01, 1464802-02, 1464810-01, 1464810-02, 1464811-01, 1464811-02, 2163401-01, 2163401-02, 2163401-03, 2163401-04, 2163401-05, 2163402-01, 2163402-02, 2163402-03, 2163402-04, 2163402-05, 2163403-01, 2163403-02, 2163403-03, 2163403-04, 2163403-05, 2163403-06, 2163403-07, 2163403-08... (Other models you can see in the webshop)		



Part No.	210228	Ref. No.	201866 201878 445035
description	pan support W 350mm L 350mm H 35mm		
For models:	1464803-01, 1464808-01, 1464809-01, 2063401-00, 2063401-01, 2063401-02, 2063401-0, 2063402-00, 2063402-01, 2063402-02, 2063402-03, 2063402-0, 2063403-00, 2063403-01, 2063403-02, 2063403-03, 2063403-04, 2063403-05, 2063403-06, 2063404-00, 2063404-01, 2063404-02, 2063404-03, 2063405-00, 2063405-01, 2063405-02, 2063405-03, 2063405-0, 2063406-00, 2063406-01, 2063406-02, 2063406-03, 2063406-04, 2063406-05, 2063406-06, 2063407-00, 2063407-01, 2063407-02, 2063407-03, 2063413-00, 2063413-01, 2063414-00, 2063414-01, 2063414-02, 2063415-00, 2063415-01, 2063415-02, 2063415-03, 2063415-04, 2063416-00... (Other models you can see in the webshop)		



Part No.	210231	Ref. No.	206001
description	pan support W 370mm L 700mm		
For models:	1464803-02, 1464803-03, 1464808-02, 1464808-03, 1464809-02, 1464809-03, 2063401-03, 2063401-04, 2063401-05, 2063401-06, 2063402-04, 2063402-05, 2063402-06, 2063403-07, 2063403-08, 2063403-09, 2063403-10, 2063404-04, 2063404-05, 2063404-06, 2063404-07, 2063405-04, 2063405-05, 2063405-06, 2063406-07, 2063406-08, 2063406-09, 2063406-10, 2063407-04, 2063407-05, 2063407-06, 2063407-07, 2063413-02, 2063414-03, 2063415-05, 2063416-02, 2063417-03, 2063418-05, 2063419-02, 3063401-02, 3063401-03, 3063401-04, 3063402-02, 3063402-03, 3063402-04, 3063405-02, 3063405-03, 3063405-04		

air mixers



Part No.	104210	Ref. No.	201541
description	air mixing sleeve L 40mm ED ø 42mm ID ø 40mm SS		
For models:	0263401-00, 0263401-01		



Part No.	104214	Ref. No.	201863
description	air mixing tube ID ø 12mm C		
For models:	1260501-00, 1263401-00, 1263402-00, 1263402-01, 1263402-02, 1263404-00, 1263404-01, 1263404-02, 1263413-02, 1263414-02, 1360501-00, 1360501-01, 1363401-00, 1363402-00, 1363402-01, 1363402-02, 1363403-00, 1363403-01, 1363403-02, 1363403-03, 1363403-04, 1363403-05, 1363404-00, 1363404-01, 1363404-02, 1363404-03, 1363413-03, 1363415-05, 1460503-01, 1464802-01, 1464802-02, 1464803-01, 1464803-02, 1464803-03, 1464808-01, 1464808-02, 1464808-03, 1464809-01, 1464809-02, 1464809-03, 1464810-01, 1464810-02, 1464811-01, 1464811-02, 2063401-00, 2063401-01, 2063401-02, 2063401-03, 2063401-04, 2063401-05... (Other models you can see in the webshop)		



Part No.	104215	Ref. No.	201864
description	air mixing tube ID ø 14mm D		
For models:	0261601-00, 1261301-00, 1261301-01, 1261301-02, 1261601-00, 1261601-01, 1261602-00, 1261602-01, 1261602-02, 1261602-03, 1261604-03, 1263402-00, 1263402-01, 1263402-02, 1263404-00, 1263404-01, 1263404-02, 1263413-02, 1263414-02, 1361301-00, 1361301-01, 1361301-02, 1361301-03, 1361601-00, 1361601-01, 1361601-02, 1361602-00, 1361602-01, 1361602-02, 1361604-02, 1363402-00, 1363402-01, 1363402-02, 1363403-00, 1363403-01, 1363403-02, 1363403-03, 1363403-04, 1363403-05, 1363404-00, 1363404-01, 1363404-02, 1363404-03, 1363413-03, 1363415-05, 1461601-00, 1461602-00, 14621011-0, 1462802B00, 1462804B00... (Other models you can see in the webshop)		



Part No.	104606	Ref. No.	201767
description	air mixing tube ID ø 16mm E		
For models:	1464803-02, 1464803-03, 1464808-02, 1464808-03, 1464809-02, 1464809-03, 2063401-03, 2063401-04, 2063401-05, 2063401-06, 2063402-04, 2063402-05, 2063402-06, 2063403-07, 2063403-08, 2063403-09, 2063403-10, 2063404-04, 2063404-05, 2063404-06, 2063404-07, 2063405-04, 2063405-05, 2063405-06, 2063406-07, 2063406-08, 2063406-09, 2063406-10, 2063407-04, 2063407-05, 2063407-06, 2063407-07, 2063413-02, 2063414-03, 2063415-05, 2063416-02, 2063417-03, 2063418-05, 2063419-02, 3063401-02, 3063401-03, 3063401-04, 3063402-02, 3063402-03, 3063402-04, 3063405-02, 3063405-03, 3063405-04		



Part No.	105926	Ref. No.	201876
description	venturi E short		



bar burners

bar burners



Part No.	105889	Ref. No.	201608
description	bar burner 1-row ømm W 28mm H 42mm L 295mm oven with ignition bridge		
For models:	0261101-01, 0261102-01, 0261103-01, 1261101-00, 1261101-01, 1261101-02, 1261102-00, 1261102-01, 1261102-02, 1361101-00, 1361101-01, 1361101-02, 1361101-03, 1361102-00, 1361102-01, 1361102-02, 1361102-03, 1461101-00, 1461101-01, 1461101-02, 1461101-03, 1461102-00, 1461102-01, 1461102-02, 1461102-03, 1461103-00, 1461104-01, 1461104-02, 1461104-03, 1461105-01, 1461105-02, 1461105-03, 1461109-01, 1461109-02, 1461109A01, 1461109A02, 1462102-00, 1462102-00_V2, 1462102-01, 1462102-02, 1462102-03, 1561110-00, 2061101-00, 2061101-01, 2061101-02, 2061101-03, 2061101-04, 2061101-05, 2061102-00, 2061102-01... (Other models you can see in the webshop)		



Part No.	105935	Ref. No.	201617
description	bar burner 2 row L 265mm W 120mm ømm H 73mm fryer		
For models:	0260301-00, 0260301-01		



Part No.	105936	Ref. No.	201686
description	bar burner 2 row L 268mm W 170mm ømm H 50mm fryer		
For models:	1260301-00, 1260301-01		

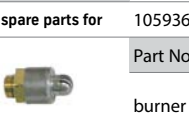

Part No.	100412	Ref. No.	—
description	burner nozzle thread 1/8" 4 slits for flame spreader		



Part No.	105931	Ref. No.	201687
description	bar burner 2 row L 405mm W 170mm ømm H 50mm fryer		
For models:	1260302-00, 1260302-01, 1460302-01, 1460302-02, 2060301-01, 2060301-02		

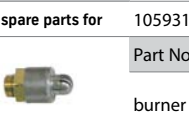

Part No.	100412	Ref. No.	—
description	burner nozzle thread 1/8" 4 slits for flame spreader		



Part No.	105890	Ref. No.	810121
description	bar burner 2 row L 460mm W 310mm ømm H 30mm bain marie		
For models:	14621011-0, 2060501-00, 2060501-01, 20605011-0		



Part No.	105923	Ref. No.	201604
description	bar burner 4 flames ømm W 125mm H 100mm L 300mm		



Part No.	105906	Ref. No.	201007
description	bar burner 4 row L 405mm W 250mm ømm H 40mm		
For models:	1462101-01, 1462101-02, 1462101-03, 1462101-04, 2063404-01, 2063404-02, 2063404-03, 2063404-04, 2063404-05, 2063404-06, 2063404-07, 2063407-01, 2063407-02, 2063407-03, 2063407-04, 2063407-05, 2063407-06, 2063407-07, 2063416-00, 2063416-01, 2063416-02, 2063419-00, 2063419-01, 2063419-02, 2063503-01, 2063503-02, 2063503-03, 2063503-04, 2063503-05, 2063503-06, 2063503-07, 2063508-00, 2063508-01, 2063508-02, 2063508-03, 2063508-04, 2063508-05, 2063508-06		





Part No.	105925	Ref. No.	811906
description	bar burner 4 row L 510mm W 255mm ømm H 145mm		
For models:	1261601-00, 1261601-01, 1261602-00, 1261602-01, 1261602-02, 1261602-03, 1261604-03, 1361601-00, 1361601-01, 1361601-02, 1361602-00, 1361602-01, 1361602-02, 1361604-02, 1461601-00, 1461602-00, 2061602-00, 2061602-01, 2061603-00, 2061603-01, 2061603-02, 2061604-01, 3061602-00		





			
1			
Part No.	104426	Ref. No.	811507
description	bar burner 4 row L 670mm W 338mm ømm H 70mm kettle		
For models:	1462802B00, 2062801-04, 2062801-05, 2062801-06, 2062801A04, 2062801A05, 2062801A06, 2062801B04, 2062801B05, 2062801B06, 2062801C04, 2062801C05, 2062801C06, 2062802-04, 2062802-05, 2062802-06, 2062802A04, 2062802A05, 2062802A06, 2062802B04, 2062802B05, 2062802B06, 2062802B07, 2062802C04, 2062802C05, 2062802C06, 3062801-00, 3062801-01, 3062801A00, 3062801A01, 3062801B00, 3062801B01, 3062801C00, 3062801C01, 3062802-00, 3062802-01, 3062802A00, 3062802A01, 3062802B00, 3062802B01, 3062802B02, 3062802C00, 3062802C01		

			
2			
Part No.	104428	Ref. No.	811512
description	bar burner 6 row L 660mm W 335mm ømm H 70mm kettle		
For models:	1462804B00, 2062803-04, 2062803-05, 2062803-06, 2062803A04, 2062803A05, 2062803A06, 2062803B04, 2062803B05, 2062803B06, 2062803C04, 2062803C05, 2062803C06, 2062804-04, 2062804-05, 2062804-06, 2062804A04, 2062804A05, 2062804A06, 2062804B04, 2062804B05, 2062804B06, 2062804B07, 2062804C04, 2062804C05, 2062804C06, 3062803-00, 3062803-01, 3062803A00, 3062803A01, 3062803B00, 3062803B01, 3062803C00, 3062803C01, 3062804-00, 3062804-01, 3062804A00, 3062804A01, 3062804B00, 3062804B01, 3062804B02, 3062804C00, 3062804C01		

			
1			
Part No.	105603	Ref. No.	201627
description	bar burner 6 row tilting bratt pan		
For models:	2061401-00, 2061401-01, 2061401A00, 2061401B00, 2061401C00, 2061402-00, 2061402-01, 2061402A00, 2061402B00, 2061402C00, 2061403-00, 2061403-01, 2061403-0, 2061403A00, 2061403B00, 2061403C00, 2061404-00, 2061404-01, 2061404-0, 2061404A00, 2061404B00, 2061404C00, 3061403-00, 3061403-01, 3061403A00, 3061403B00, 3061403C00, 3061404-00, 3061404A00, 3061404B00, 3061404C00		

			
1			
Part No.	105924	Ref. No.	201602
description	bar burner 8 flames ømm W 30mm H 65mm L 285mm		

			
1			
Part No.	104200	Ref. No.	201505
description	bar burner ømm W 28mm H 42mm L 295mm flange width 35mm flange length 70mm kettle		
For models:	0261101-01, 0261102-01, 0261103-01, 1261101-00, 1261101-01, 1261101-02, 1261102-00, 1261102-01, 1261102-02, 1361101-00, 1361101-01, 1361101-02, 1361101-03, 1361102-00, 1361102-01, 1361102-02, 1361102-03, 1461101-00, 1461101-01, 1461101-02, 1461101-03, 1461102-00, 1461102-01, 1461102-02, 1461102-03, 1461103-00, 1461104-01, 1461104-02, 1461104-03, 1461105-01, 1461105-02, 1461105-03, 1461109-01, 1461109-02, 1461109A01, 1461109A02, 1462102-00, 1462102-00_V2, 1462102-01, 1462102-02, 1462102-03, 1561110-00, 2061101-00, 2061101-01, 2061101-02, 2061101-03, 2061101-04, 2061101-05, 2061102-00, 2061102-01... (Other models you can see in the webshop)		

			
1			
Part No.	104202	Ref. No.	201507 201728
description	bar burner ømm W 28mm H 53mm L 385mm flange width 35mm flange length 70mm tilting bratt pan		
For models:	2061401-05, 2061401-06, 2061401-07, 2061401-08, 2061401A05, 2061401A06, 2061401A07, 2061401A08, 2061401B05, 2061401B06, 2061401B07, 2061401B08, 2061401C05, 2061401C06, 2061401C07, 2061401C08, 2061402-05, 2061402-06, 2061402-07, 2061402A05, 2061402A06, 2061402A07, 2061402B05, 2061402B06, 2061402B07, 2061402C05, 2061402C06, 2061402C07, 2061403-03, 2061403-04, 2061403-05, 2061403A03, 2061403A04, 2061403A05, 2061403B03, 2061403B04, 2061403B05, 2061403C03, 2061403C04, 2061403C05, 2061404-03, 2061404-04, 2061404-05, 2061404A03, 2061404A04, 2061404A05, 2061404B03, 2061404B04, 2061404B05, 2061404C03... (Other models you can see in the webshop)		

			
1			
Part No.	104201	Ref. No.	201506
description	bar burner with ignition bridge ømm W 28mm H 42mm L 295mm flange width 35mm flange length 70mm kettle		
For models:	2062801-00, 2062801A00, 2062801B00, 2062801C00, 2062802-00, 2062802-2, 2062802A00, 2062802B00, 2062802C00, 2062901B03, 2062901B04, 2062901B05, 2062901C03, 2062901C04, 2062901C05		





			
1			
Part No.	105907	Ref. No.	201611
description	bar burner with ignition bridge ømm W 28mm H 42mm L 385mm flange width 35mm flange length 70mm tilting bratt pan		
For models:	1462101-00, 14621011-0, 2061401-02, 2061401-03, 2061401-04, 2061401A01, 2061401A02, 2061401A03, 2061401B01, 2061401B02, 2061401B03, 2061401C01, 2061401C02, 2061401C03, 2061402-02, 2061402-03, 2061402-04, 2061402A01, 2061402A02, 2061402A03, 2061402B01, 2061402B02, 2061402B03, 2061402C01, 2061402C02, 2061402C03, 2063404-00, 2063407-00, 2063503-00, 2063505-00		

			
2			
Part No.	105908	Ref. No.	201720
description	bar burner with ignition bridge ømm W 28mm H 42mm L 385mm flange width 35mm flange length 70mm tilting bratt pan		
For models:	2061401-05, 2061401-06, 2061401-07, 2061401-08, 2061401A05, 2061401A06, 2061401A07, 2061401A08, 2061401B05, 2061401B06, 2061401B07, 2061401B08, 2061401C05, 2061401C06, 2061401C07, 2061401C08, 2061402-05, 2061402-06, 2061402-07, 2061402A05, 2061402A06, 2061402A07, 2061402B05, 2061402B06, 2061402B07, 2061402C05, 2061402C06, 2061402C07, 2061403-02, 2061403-03, 2061403-04, 2061403-05, 2061403A02, 2061403A03, 2061403A04, 2061403A05, 2061403B02, 2061403B03, 2061403B04, 2061403B05, 2061403C02, 2061403C03, 2061403C04, 2061403C05, 2061404-02, 2061404-03, 2061404-04, 2061404-05, 2061404A02, 2061404A03... (Other models you can see in the webshop)		

			
1			
Part No.	105937	Ref. No.	201729
description	bar burner with ignition bridge ømm W 28mm H 42mm L 385mm flange width 35mm flange length 70mm tilting bratt pan		
For models:	2061401-05, 2061401-06, 2061401-07, 2061401-08, 2061401A05, 2061401A06, 2061401A07, 2061401A08, 2061401B05, 2061401B06, 2061401B07, 2061401B08, 2061401C05, 2061401C06, 2061401C07, 2061401C08, 2061402-05, 2061402-06, 2061402-07, 2061402A05, 2061402A06, 2061402A07, 2061402B05, 2061402B06, 2061402B07, 2061402C05, 2061402C06, 2061402C07, 2161401-03, 2161401-04, 2161401-05, 2161401-06, 2161401A03, 2161401A04, 2161401A05, 2161401A06, 2161401B03, 2161401B04, 2161401B05, 2161401B06, 2161401C03, 2161401C04, 2161401C05, 2161401C06, 2161402-03, 2161402-04, 2161402-05, 2161402A03, 2161402A04, 2161402A05... (Other models you can see in the webshop)		

			
1			
Part No.	104203	Ref. No.	201508
description	bar burner with ignition bridge ømm W 28mm H 53mm L 390mm flange width 35mm flange length 70mm kettle		
For models:	2062803-00, 20628033-2, 2062803A00, 2062803B00, 2062803C00, 2062804-00, 20628044-2, 2062804A00, 2062804B00, 2062804C00, 2062806-00, 2062806A00, 2062806B00, 2062806B01, 2062806B02, 2062806B03, 2062806C00, 2062806C01, 2062806C02, 2062806C03, 2062901-00, 20629011-2, 2062901A00, 2062901B00, 2062901B01, 2062901B02, 2062901B03, 2062901B04, 2062901B05, 2062901C00, 2062901C01, 2062901C02, 2062901C03, 2062901C04, 2062901C05, 2062902-00, 20629022-2, 2062902A00, 2062902B00, 2062902B01, 2062902B02, 2062902B03, 2062902B04, 2062902B05, 2062902C00, 2062902C01, 2062902C02, 2062902C03, 2062902C04, 2062902C05... (Other models you can see in the webshop)		

round burners

			
1			
Part No.	105893	Ref. No.	201622
description	round burner ø 250mm 20-25kW		
For models:	1463501-00, 1463501-01, 1463501-02, 1463501-03, 1463501-04, 1463501-05, 2063501-00, 2063501-01, 2063501-02, 2063501-03, 2063501-04, 2063501-05, 2063501-06, 20635011-0, 2063502-00, 2063502-01, 2063502-02, 2063502-03, 2063502-04, 2063502-05, 2063502-06, 2063502-07, 2063502-08, 2063502-09, 2063502-10, 20635022-0, 2063503-00, 2063503-01, 2063503-02, 2063503-03, 2063503-04, 2063503-05, 2063503-06, 2063503-07, 20635033-0, 2063504-00, 2063504-01, 2063504-02, 2063504-03, 20635044-0, 2063505-00, 20635055-0, 2063506-00, 2063506-01, 2063506-02, 2063506-03, 2063506-04, 2063506-05, 20635066-0, 2063507-00... (Other models you can see in the webshop)		
spare parts for	105893		
	Part No.	102761	Ref. No. 205267
	locking screw thread 3/8" WS 17		
	Part No.	102762	Ref. No. 205268
	locking screw with test nipple thread 3/8" WS 17		
	Part No.	528520	Ref. No. 211004
	gasket copper ED ø 22mm ID ø 16mm thickness 2mm		



forced air burners

			
1			
Part No.	107842	Ref. No.	201178
description	burner L 150mm ø 50mm 20kW combi-steamer		
For models:	CGG11-L, CGG11-R, CGG12-L, CGG12-R, CGG21-L, CGG21-R, CGG22-L, CGG22-R, CGG61-L, CGG61-R, CGG62-L, CGG62-R, CSG11-L, CSG11-R, CSG11-R-DG, CSG12-L, CSG12-R, CSG12-R-DG, CSG21-L, CSG21-R, CSG21-R-DG, CSG22-L, CSG22-R, CSG22-R-DG, CSG61-L, CSG61-R, CSG61-R-DG, CSG62-L, CSG62-R, CSG62-R-DG		

			
1			
Part No.	107877	Ref. No.	201174
description	connecting fitting for burner MKN combi-steamer		
For models:	CGG61-L, CGG61-R, CGG62-L, CGG62-R, CSG61-L, CSG61-R, CSG61-R-DG, CSG62-L, CSG62-R, CSG62-R-DG		

			
1			
Part No.	107878	Ref. No.	201172
description	connecting fitting for burner MKN combi-steamer		
For models:	CGG11-L, CGG11-R, CGG12-L, CGG12-R, CGG21-L, CGG21-R, CGG22-L, CGG22-R, CSG11-L, CSG11-R, CSG11-R-DG, CSG12-L, CSG12-R, CSG12-R-DG, CSG21-L, CSG21-R, CSG21-R-DG, CSG22-L, CSG22-R, CSG22-R-DG		

			
1			
Part No.	108150	Ref. No.	201182
description	venturi MKN combi-steamer with gasket		
For models:	CGG11-L, CGG11-R, CGG12-L, CGG12-R, CGG21-L, CGG21-R, CGG22-L, CGG22-R, CGG61-L, CGG61-R, CGG62-L, CGG62-R, CSG11-L, CSG11-R, CSG11-R-DG, CSG12-L, CSG12-R, CSG12-R-DG, CSG21-L, CSG21-R, CSG21-R-DG, CSG22-L, CSG22-R, CSG22-R-DG, CSG61-L, CSG61-R, CSG61-R-DG, CSG62-L, CSG62-R, CSG62-R-DG		

accessories

nozzle holders

			
1			
Part No.		Ref. No.	201581
description	nozzle holder external nozzle ø 2.1mm internal nozzle ø 1.9mm complete with nozzle tube ø 12mm		
For models:	2063413-02, 2063414-03, 2063415-05, 2063416-02, 2063417-03, 2063418-05, 2063419-02		

			
1			
Part No.		Ref. No.	10013991 10013991-ZF01X
description	nozzle holder external nozzle ø 2.9mm internal nozzle ø 2.9mm ET M17x1 IT M12x1 M12x1 tube ø 10mm		

			
1			
Part No.	101595	Ref. No.	201667
description	nozzle holder external nozzle ø bore ø1.55mm internal nozzle ø bore ø1.35mm		
For models:	1263401-00, 1263402-00, 1263402-01, 1263402-02, 1263404-00, 1263404-01, 1263404-02, 1263413-02, 1263414-02, 1363401-00, 1363402-00, 1363402-01, 1363402-02, 1363403-00, 1363403-01, 1363403-02, 1363403-03, 1363403-04, 1363403-05, 1363404-00, 1363404-01, 1363404-02, 1363404-03, 1363413-03, 1363415-05		

			
1			
Part No.	101858	Ref. No.	201723
description	nozzle holder external nozzle ø bore ø2.05mm internal nozzle ø bore ø1.85mm		
For models:	1263402-00, 1263402-01, 1263402-02, 1263404-00, 1263404-01, 1263404-02, 1263413-02, 1263414-02, 1363402-00, 1363402-01, 1363402-02, 1363403-00, 1363403-01, 1363403-02, 1363403-03, 1363403-04, 1363403-05, 1363404-00, 1363404-01, 1363404-02, 1363404-03, 1363413-03, 1363415-05		





			
1			
Part No.	102771	Ref. No.	201772
description	nozzle holder external nozzle ϕ bore ϕ 2.35mm internal nozzle ϕ bore ϕ 2.00mm		
For models:	1263405-00, 1263405-01, 1363405-00, 1363405-01, 1464803-02, 1464803-03, 1464808-02, 1464808-03, 1464809-02, 1464809-03, 1464812-00, 1464812-01, 1464812-02, 2063401-03, 2063401-04, 2063401-05, 2063401-06, 2063402-04, 2063402-05, 2063402-06, 2063403-07, 2063403-08, 2063403-09, 2063403-10, 2063404-04, 2063404-05, 2063404-06, 2063404-07, 2063405-04, 2063405-05, 2063405-06, 2063406-07, 2063406-08, 2063406-09, 2063406-10, 2063407-04, 2063407-05, 2063407-06, 2063407-07, 2063420-00, 2063420-01, 2063420-02, 2163422-00, 2163422-01, 2163422-02, 3063401-02, 3063401-03, 3063401-04, 3063402-02, 3063402-03... (Other models you can see in the webshop)		

			
1			
Part No.		Ref. No.	202185
description	nozzle holder with cap pipe outlet ϕ M17x1mm nozzle mounting M12x1		

gas nozzles

main nozzles

			
1			
Part No.	100431	Ref. No.	N/A
description	gas injector thread 1/8" bore ϕ 1.3mm LPG		

			
1			
Part No.	106826	Ref. No.	201585
description	gas injector thread 1/8" bore ϕ 1.9mm		

			
1			
Part No.	100430	Ref. No.	N/A
description	gas injector thread 1/8" bore ϕ 2.2mm natural gas		

			
gas nozzles M12x1			
1			
Part No.	100301	Ref. No.	201831
description	gas injector thread M12x1 WS 14 bore ϕ 1.55mm		
For models:	1263402-00, 1263402-01, 1263402-02, 1263404-00, 1263404-01, 1263404-02, 1263413-02, 1263414-02, 1363402-00, 1363402-01, 1363402-02, 1363403-00, 1363403-01, 1363403-02, 1363403-03, 1363403-04, 1363403-05, 1363404-00, 1363404-01, 1363404-02, 1363404-03, 1363413-03, 1363415-05, 1464803-02, 1464803-03, 1464808-02, 1464808-03, 1464809-02, 1464809-03, 1464810-01, 1464810-02, 1464811-01, 1464811-02, 2063401-03, 2063401-04, 2063401-05, 2063401-06, 2063402-04, 2063402-05, 2063402-06, 2063403-07, 2063403-08, 2063403-09, 2063403-10, 2063404-04, 2063404-05, 2063404-06, 2063404-07, 2063405-04, 2063405-05... (Other models you can see in the webshop)		

			
1			
Part No.	100303	Ref. No.	201836
description	gas injector thread M12x1 WS 14 bore ϕ 2.05mm		
For models:	1263402-00, 1263402-01, 1263402-02, 1263404-00, 1263404-01, 1263404-02, 1263413-02, 1263414-02, 1363402-00, 1363402-01, 1363402-02, 1363403-00, 1363403-01, 1363403-02, 1363403-03, 1363403-04, 1363403-05, 1363404-00, 1363404-01, 1363404-02, 1363404-03, 1363413-03, 1363415-05, 1464808-02, 1464808-03, 1464809-02, 1464809-03, 1464810-01, 1464810-02, 1464811-01, 1464811-02, 2063402-04, 2063402-05, 2063402-06, 2063403-07, 2063403-08, 2063403-09, 2063403-10, 2063404-04, 2063404-05, 2063404-06, 2063404-07, 2063405-04, 2063405-05, 2063405-06, 2063406-07, 2063406-08, 2063406-09, 2063406-10, 2063407-04... (Other models you can see in the webshop)		

			
1			
Part No.	100309	Ref. No.	201773
description	gas injector thread M12x1 WS 14 bore ϕ 2.30mm		
For models:	1464803-02, 1464803-03, 1464808-02, 1464808-03, 1464809-02, 1464809-03, 2063401-03, 2063401-04, 2063401-05, 2063401-06, 2063402-04, 2063402-05, 2063402-06, 2063403-07, 2063403-08, 2063403-09, 2063403-10, 2063404-04, 2063404-05, 2063404-06, 2063404-07, 2063405-04, 2063405-05, 2063405-06, 2063406-07, 2063406-08, 2063406-09, 2063406-10, 2063407-04, 2063407-05, 2063407-06, 2063407-07, 3063401-02, 3063401-03, 3063401-04, 3063402-02, 3063402-03, 3063402-04, 3063405-02, 3063405-03, 3063405-04		

			
1			
Part No.	106329	Ref. No.	201858
description	gas injector thread M12x1 WS 14 bore ϕ 2.80mm		
For models:	1263402-02, 1263404-02, 1263413-02, 1263414-02, 1363403-05, 1363404-03, 1363413-03, 1363415-05		



gas nozzles M15x1



1

Part No.	100337	Ref. No.	201808
description	gas injector thread M15x1 bore ø 1.60mm WS 17		



1

Part No.	100338	Ref. No.	201810
description	gas injector thread M15x1 bore ø 2.10mm WS 17		



1

Part No.	100331	Ref. No.	201812
description	gas injector thread M15x1 bore ø 2.70mm WS 17		

For models: 0263401-00, 0263401-01, 2063413-00, 2063413-01, 2063414-00, 2063414-01, 2063414-02, 2063415-00, 2063415-01, 2063415-02, 2063415-03, 2063415-04, 2063416-00, 2063416-01, 2063417-00, 2063417-01, 2063417-02, 2063418-00, 2063418-01, 2063418-02, 2063418-03, 2063418-04, 2063419-00, 2063419-01, 2163415-00, 2163416-00, 2163416-01, 2163417-00, 2163417-01, 2163417-02, 2163417-03, 2163418-00, 2163418-01, 2163419-00, 2163419-01, 2163420-00, 2163420-01, 2163420-02, 2163420-03, 2163421-00, 2163421-01, 3063413-00, 3063414-00, 3063417-00



1

Part No.	100334	Ref. No.	201811
description	gas injector thread M15x1 bore ø 3.50mm WS 17		

For models: 2063413-00, 2063413-01, 2063413-02, 2063414-00, 2063414-01, 2063414-02, 2063414-03, 2063415-00, 2063415-01, 2063415-02, 2063415-03, 2063415-04, 2063415-05, 2063416-00, 2063416-01, 2063416-02, 2063417-00, 2063417-01, 2063417-02, 2063417-03, 2063418-00, 2063418-01, 2063418-02, 2063418-03, 2063418-04, 2063418-05, 2063419-00, 2063419-01, 2063419-02, 2163415-00, 2163416-00, 2163416-01, 2163417-00, 2163417-01, 2163417-02, 2163417-03, 2163418-00, 2163418-01, 2163419-00, 2163419-01, 2163420-00, 2163420-01, 2163420-02, 2163420-03, 2163421-00, 2163421-01, 3063413-00, 3063414-00, 3063417-00

pilot burner nozzles

pilot burner nozzles JUNKERS

CB 50203_/503_ series



1

Part No.	100220	Ref. No.	201547
-----------------	--------	-----------------	--------

description pilot burner nozzle LPG gas pressure 50mbar code 2 Qty 1 pcs suitable for JUNKERS CB503_



1

Part No.	100222	Ref. No.	201641
-----------------	--------	-----------------	--------

description pilot burner nozzle LPG gas pressure 50mbar code 5 Qty 1 pcs suitable for JUNKERS CB50203_

For models: 1462101-02, 1462101-03, 1462102-01, 1462102-02, 1463501-04, 1463501-05, 2060501-01, 2062806B02, 2062806B03, 2062806C02, 2062806C03, 2062901B02, 2062901B03, 2062901B04, 2062901B05, 2062901C02, 2062901C03, 2062901C04, 2062901C05, 2062902B02, 2062902B03, 2062902B04, 2062902B05, 2062902C02, 2062902C03, 2062902C04, 2062902C05, 2063404-04, 2063407-04, 2063501-03, 2063502-04, 2063502-05, 2063502-06, 2063502-07, 2063502-08, 2063502-09, 2063502-10, 2063503-03, 2063503-04, 2063503-05, 2063503-06, 2063503-07, 2063504-03, 2063506-03, 2063506-04, 2063506-05, 2063507-04, 2063507-05, 2063507-06, 2063507-07... (Other models you can see in the webshop)



1

Part No.	102524	Ref. No.	201546
-----------------	--------	-----------------	--------

description pilot burner nozzle natural gas gas pressure 25mbar code 26 Qty 10 pcs suitable for CB 503



pilot burner nozzles SIT

160 series



Part No.	107172	Ref. No.	201671
description	pilot burner nozzle SIT LPG code 25 Qty 1 pcs		
For models:	1260301-00, 1260301-01, 1260302-00, 1260302-01, 1260501-00, 1261101-00, 1261101-01, 1261101-02, 1261102-00, 1261102-01, 1261102-02, 1261301-00, 1261301-01, 1261301-02, 1261601-00, 1261601-01, 1261602-00, 1261602-01, 1261602-02, 1261602-03, 1261604-03, 1360501-00, 1360501-01, 1361101-00, 1361101-01, 1361101-02, 1361101-03, 1361102-00, 1361102-01, 1361102-02, 1361102-03, 1361301-00, 1361301-01, 1361301-02, 1361301-03, 1361601-00, 1361601-01, 1361601-02, 1361602-01, 1361602-02, 1361604-02, 1460302-01, 1460302-02, 1460503-01, 1461101-01, 1461101-02, 1461101-03, 1461102-01, 1461102-02... (Other models you can see in the webshop)		



Part No.	107174	Ref. No.	201672
description	pilot burner nozzle SIT natural gas code 41 Qty 1 pcs		
For models:	1260301-00, 1260301-01, 1260302-00, 1260302-01, 1260501-00, 1261101-01, 1261101-02, 1261102-01, 1261102-02, 1261301-00, 1261301-01, 1261301-02, 1261601-00, 1261601-01, 1261602-00, 1261602-01, 1261602-02, 1261602-03, 1261604-03, 1360501-00, 1360501-01, 1361101-01, 1361101-02, 1361101-03, 1361102-01, 1361102-02, 1361102-03, 1361301-00, 1361301-01, 1361301-02, 1361301-03, 1361601-00, 1361601-01, 1361601-02, 1361602-00, 1361602-01, 1361602-02, 1361604-02, 1460302-01, 1460302-02, 1460503-01, 1461101-02, 1461101-03, 1461102-02, 1461102-03, 1461104-02, 1461104-03, 1461105-02, 1461105-03, 1461109-01... (Other models you can see in the webshop)		

pilot burner nozzles (other)

MKN



Part No.	106228	Ref. No.	201806
description	pilot burner nozzle bore ϕ 0.6mm		
For models:	0263401-00, 0263401-01, 1263402-02, 1263404-02, 1263413-02, 1263414-02, 1363403-05, 1363404-03, 1363413-03, 1363415-05, 2063413-00, 2063413-01, 2063413-02, 2063414-00, 2063414-01, 2063414-02, 2063414-03, 2063415-00, 2063415-01, 2063415-02, 2063415-03, 2063415-04, 2063415-05, 2063416-00, 2063416-01, 2063416-02, 2063417-00, 2063417-01, 2063417-02, 2063417-03, 2063418-00, 2063418-01, 2063418-02, 2063418-03, 2063418-04, 2063418-05, 2063419-00, 2063419-01, 2063419-02, 2163401-00, 2163402-00, 2163403-00, 2163404-00, 2163405-00, 2163406-00, 2163407-00, 2163415-00, 2163416-00, 2163416-01, 2163417-00... (Other models you can see in the webshop)		



Part No.	100270	Ref. No.	201821
description	pilot burner nozzle LPG bore ϕ 0.2mm thread M8x0.75 T1: M8x1		
For models:	1263402-00, 1263402-01, 1263402-02, 1263404-00, 1263404-01, 1263404-02, 1263405-00, 1263405-01, 1263413-02, 1263414-02, 1363402-00, 1363402-01, 1363402-02, 1363403-00, 1363403-01, 1363403-02, 1363403-03, 1363403-04, 1363403-05, 1363404-00, 1363404-01, 1363404-02, 1363404-03, 1363405-00, 1363405-01, 1363413-03, 1363415-05, 1464803-02, 1464803-03, 1464808-02, 1464808-03, 1464809-02, 1464809-03, 1464810-01, 1464810-02, 1464811-01, 1464811-02, 1464812-00, 1464812-01, 1464812-02, 2063401-03, 2063401-04, 2063401-05, 2063401-06, 2063402-04, 2063402-05, 2063402-06, 2063403-07, 2063403-08, 2063403-09... (Other models you can see in the webshop)		



Part No.	100272	Ref. No.	201805
description	pilot burner nozzle natural gas bore ϕ 0.35mm		
For models:	1263402-00, 1263402-01, 1263402-02, 1263404-00, 1263404-01, 1263404-02, 1263405-00, 1263405-01, 1263413-02, 1263414-02, 1363402-00, 1363402-01, 1363402-02, 1363403-00, 1363403-01, 1363403-02, 1363403-03, 1363403-04, 1363403-05, 1363404-00, 1363404-01, 1363404-02, 1363404-03, 1363405-00, 1363405-01, 1363413-03, 1363415-05, 1464803-02, 1464803-03, 1464808-02, 1464808-03, 1464809-02, 1464809-03, 1464810-01, 1464810-02, 1464811-01, 1464811-02, 1464812-00, 1464812-01, 1464812-02, 2063401-03, 2063401-04, 2063401-05, 2063401-06, 2063402-04, 2063402-05, 2063402-06, 2063403-07, 2063403-08, 2063403-09... (Other models you can see in the webshop)		



Part No.	100271	Ref. No.	201822
description	pilot burner nozzle natural gas bore ϕ 0.3mm		

bypass nozzles

bypass nozzles EGA





Part No.	106825	Ref. No.	201833
description	bypass nozzle EGA bore ϕ 0.37mm		
For models:	1260501-00, 1263402-00, 1263404-00, 1360501-00, 1360501-01, 1363402-00, 1363402-01, 1363403-00, 1363403-01, 1363403-02, 1363403-03, 1363404-00, 1363404-01, 1464803-02, 1464808-02, 1464809-02, 1464810-01, 1464811-01, 2063401-03, 2063401-04, 2063402-04, 2063403-07, 2063403-08, 2063404-04, 2063404-05, 2063405-04, 2063406-07, 2063406-08, 2063407-04, 2063407-05, 2163401-02, 2163401-03, 2163402-03, 2163403-06, 2163403-07, 2163404-03, 2163404-04, 2163405-03, 2163406-06, 2163406-07, 2163407-03, 2163407-04, 3063401-02, 3063402-02, 3063405-02		





			
Part No.	100356	Ref. No.	201757
description	bypass nozzle EGA type 31248 series bore \varnothing 0.55mm total length 23mm \varnothing 5mm thread M5x0.5		
For models:	1460503-01, 1462101-01, 1462101-02, 1462101-03, 1462101-04, 1462102-00, 1462102-01, 1462102-02, 1462102-03, 2063404-01, 2063404-02, 2063404-03, 2063404-04, 2063404-05, 2063404-06, 2063404-07, 2063407-01, 2063407-02, 2063407-03, 2063407-04, 2063407-05, 2063407-06, 2063407-07, 2063416-00, 2063416-01, 2063416-02, 2063419-00, 2063419-01, 2063419-02, 2063503-01, 2063503-02, 2063503-03, 2063503-04, 2063503-05, 2063503-06, 2063503-07, 2063508-00, 2063508-01, 2063508-02, 2063508-03, 2063508-04, 2063508-05, 2063508-06, 2160501-00, 2160501-01, 2163404-01, 2163404-02, 2163404-03, 2163404-04, 2163404-05... (Other models you can see in the webshop)		

			
Part No.	100354	Ref. No.	201817
description	bypass nozzle EGA type 31248 series bore \varnothing 0.5mm		
For models:	1263402-00, 1263404-00, 1363402-00, 1363402-01, 1363403-00, 1363403-01, 1363403-02, 1363403-03, 1363404-00, 1363404-01, 1464808-02, 1464809-02, 1464810-01, 1464811-01, 2063402-04, 2063403-07, 2063403-08, 2063404-04, 2063404-05, 2063405-04, 2063406-07, 2063406-08, 2063407-04, 2063407-05, 2163401-02, 2163401-03, 2163402-03, 2163403-06, 2163403-07, 2163404-03, 2163404-04, 2163405-03, 2163406-06, 2163406-07, 2163407-03, 2163407-04, 3063402-02, 3063405-02		

			
Part No.	100368	Ref. No.	201816
description	bypass nozzle EGA type 31248 series bore \varnothing 0.6mm		
For models:	1464803-02, 1464808-02, 1464809-02, 2063401-03, 2063401-04, 2063402-04, 2063403-07, 2063403-08, 2063404-04, 2063404-05, 2063405-04, 2063406-07, 2063406-08, 2063407-04, 2063407-05, 3063401-02, 3063402-02, 3063405-02		

			
Part No.	100346	Ref. No.	201818
description	bypass nozzle EGA type 31248 series bore \varnothing 0.85mm		
For models:	1464812-00, 1464812-01, 2063420-00, 2063420-01, 2163422-00, 2163422-01		

			
Part No.	100348	Ref. No.	201814
description	bypass nozzle EGA type 31248 series bore \varnothing 1.1mm		
For models:	1462101-00, 1462101-0, 1462102-00_V2, 2063404-00, 2063407-00, 2063503-00, 2063505-00, 2163404-00, 2163407-00		

			
Part No.	100349	Ref. No.	201874
description	bypass nozzle EGA type 31248 series bore \varnothing 1.8mm		
For models:	1462102-00_V2, 2163404-00, 2163407-00		

			
Part No.	100362	Ref. No.	201754
description	bypass nozzle EGA type 31248 series bore \varnothing 1mm		
For models:	1261301-00, 1261301-01, 1261601-00, 1261601-01, 1261602-00, 1261602-01, 1361301-00, 1361301-01, 1361301-02, 1361601-00, 1361601-01, 1361601-02, 1361602-00, 1461601-00, 2061603-00, 2061603-01		

bypass nozzles PEL20/21

			
Part No.	100553	Ref. No.	201796
description	bypass nozzle type PEL20/21 bore \varnothing 0.4mm thread M5x0.5		
For models:	1263402-01, 1263402-02, 1263404-01, 1263404-02, 1263413-02, 1263414-02, 1363402-02, 1363403-04, 1363403-05, 1363404-02, 1363404-03, 1363413-03, 1363415-05, 1464803-03, 1464808-03, 1464809-03, 1464810-02, 1464811-02, 2063401-05, 2063401-06, 2063402-05, 2063402-06, 2063403-09, 2063403-10, 2063404-06, 2063404-07, 2063405-05, 2063405-06, 2063406-09, 2063406-10, 2063407-06, 2063407-07, 2163401-04, 2163401-05, 2163402-04, 2163402-05, 2163403-08, 2163403-09, 2163404-05, 2163404-06, 2163405-04, 2163405-05, 2163406-08, 2163406-09, 2163407-05, 2163407-06, 3063401-03, 3063401-04, 3063402-03, 3063402-04... (Other models you can see in the webshop)		

			
Part No.	100551	Ref. No.	201798
description	bypass nozzle type PEL20/21 bore \varnothing 0.6mm thread M5x0.5		
For models:	1464803-03, 1464808-03, 1464809-03, 2063401-05, 2063401-06, 2063402-05, 2063402-06, 2063403-09, 2063403-10, 2063404-06, 2063404-07, 2063405-05, 2063405-06, 2063406-09, 2063406-10, 2063407-06, 2063407-07, 3063401-03, 3063401-04, 3063402-03, 3063402-04, 3063405-03, 3063405-04		

			
Part No.	100528	Ref. No.	201239
description	bypass nozzle type PEL20/21 bore \varnothing 0.9mm thread M5x0.5		
For models:	1464812-02, 2063420-02, 2163422-02		

bypass nozzles PEL22

			
Part No.	100281	Ref. No.	201143
description	bypass nozzle type PEL22 bore \varnothing 0.4mm thread M6x0.5		
For models:	2063413-02, 2063414-03, 2063415-05, 2063416-02, 2063417-03, 2063418-05, 2063419-02, CGE11-L, CGE11-R, CGE61-L, CGE61-R, CSE11-L, CSE11-R, CSE61-L, CSE61-R		

			
Part No.	100392	Ref. No.	201169
description	bypass nozzle type PEL22 bore \varnothing 0.6mm thread M6x0.5		
For models:	2063413-02, 2063414-03, 2063415-05, 2063416-02, 2063417-03, 2063418-05, 2063419-02, CPE63		

			
Part No.	100433	Ref. No.	201164
description	bypass nozzle type PEL22 bore \varnothing 0.9mm thread M6x0.5		
For models:	1261301-02, 1261602-02, 1261602-03, 1261604-03, 1263405-01, 1361301-03, 1361602-01, 1361602-02, 1361604-02, 1363405-01, 1461602-00, 1463501-05, 2061301-01, 2061602-00, 2061602-01, 2061603-02, 2061604-01, 2063501-06, 2063502-10, 2063503-07, 3061602-00		





			
1			
Part No.	100407	Ref. No.	201166
description	bypass nozzle type PEL22 bore ø 1mm thread M6x0.5		
For models:	1261301-02, 1261602-02, 1261602-03, 1261604-03, 1361301-03, 1361602-01, 1361602-02, 1361604-02, 1461602-00, 2061301-01, 2061602-00, 2061602-01, 2061603-02, 2061604-01, 3061602-00		

internal nozzles

internal nozzles for EGA gas taps/nozzle holders

EGA 24197/24362

			
1			
Part No.	100340	Ref. No.	201593
description	internal nozzle bore ø 0.85mm type EGA/PEL22		

			
1			
Part No.	100492	Ref. No.	201800
description	internal nozzle bore ø 0.8mm type EGA/PEL22		
For models:	0263401-00, 0263401-01		

			
1			
Part No.	100341	Ref. No.	201695
description	internal nozzle bore ø 1.15mm type EGA/PEL22		

			
1			
Part No.	100342	Ref. No.	201801
description	internal nozzle bore ø 1.4mm type EGA/PEL22		
For models:	2063413-02, 2063414-03, 2063415-05, 2063416-02, 2063417-03, 2063418-05, 2063419-02		

			
1			
Part No.	100345	Ref. No.	201803
description	internal nozzle bore ø 1.9mm type EGA/PEL22		
For models:	2063413-02, 2063414-03, 2063415-05, 2063416-02, 2063417-03, 2063418-05, 2063419-02		

			
1			
Part No.	100343	Ref. No.	201802
description	internal nozzle bore ø 1mm type EGA/PEL22		
For models:	14621011-0		

			
1			
Part No.	107502	Ref. No.	10013937
description	internal nozzle bore ø 2.7mm		

			
1			
Part No.	107501	Ref. No.	10013936
description	internal nozzle bore ø 2mm		

EGA 26400/26440/23268

			
1			
Part No.	100311	Ref. No.	201834
description	internal nozzle bore ø 0.80mm suitable for EGA26400/26440		
For models:	1263401-00, 1263402-00, 1263402-01, 1263402-02, 1263404-00, 1263404-01, 1263404-02, 1263413-02, 1263414-02, 1363401-00, 1363402-00, 1363402-01, 1363402-02, 1363403-00, 1363403-01, 1363403-02, 1363403-03, 1363403-04, 1363403-05, 1363404-00, 1363404-01, 1363404-02, 1363404-03, 1363413-03, 1363415-05, 1464803-02, 1464803-03, 1464808-02, 1464808-03, 1464809-02, 1464809-03, 1464810-01, 1464810-02, 1464811-01, 1464811-02, 2063401-03, 2063401-04, 2063401-05, 2063401-06, 2063402-04, 2063402-05, 2063402-06, 2063403-07, 2063403-08, 2063403-09, 2063403-10, 2063404-04, 2063404-05, 2063404-06, 2063404-07... (Other models you can see in the webshop)		

			
1			
Part No.	100321	Ref. No.	201823
description	internal nozzle bore ø 0.90mm suitable for EGA26400/26440		
For models:	1263401-00, 1263402-00, 1263402-01, 1263402-02, 1263404-00, 1263404-01, 1263404-02, 1263413-02, 1263414-02, 1363401-00, 1363402-00, 1363402-01, 1363402-02, 1363403-00, 1363403-01, 1363403-02, 1363403-03, 1363403-04, 1363403-05, 1363404-00, 1363404-01, 1363404-02, 1363404-03, 1363413-03, 1363415-05, 1464803-02, 1464803-03, 1464808-02, 1464808-03, 1464809-02, 1464809-03, 1464810-01, 1464810-02, 1464811-01, 1464811-02, 2063401-03, 2063401-04, 2063401-05, 2063401-06, 2063402-04, 2063402-05, 2063402-06, 2063403-07, 2063403-08, 2063403-09, 2063403-10, 2063404-04, 2063404-05, 2063404-06, 2063404-07... (Other models you can see in the webshop)		

			
1			
Part No.	100312	Ref. No.	201839
description	internal nozzle bore ø 1.05mm suitable for EGA26400/26440		
For models:	1263402-00, 1263402-01, 1263402-02, 1263404-00, 1263404-01, 1263404-02, 1263413-02, 1263414-02, 1363402-00, 1363402-01, 1363402-02, 1363403-00, 1363403-01, 1363403-02, 1363403-03, 1363403-04, 1363403-05, 1363404-00, 1363404-01, 1363404-02, 1363404-03, 1363413-03, 1363415-05, 1464808-02, 1464808-03, 1464809-02, 1464809-03, 1464810-01, 1464810-02, 1464811-01, 1464811-02, 2063402-05, 2063402-06, 2063403-07, 2063403-08, 2063403-09, 2063403-10, 2063404-04, 2063404-05, 2063404-06, 2063404-07, 2063405-04, 2063405-05, 2063405-06, 2063406-07, 2063406-08, 2063406-09, 2063406-10, 2063407-04... (Other models you can see in the webshop)		

			
1			
Part No.	100313	Ref. No.	201697
description	internal nozzle bore ø 1.20mm suitable for EGA26400/26440		
For models:	1464803-02, 1464803-03, 1464808-02, 1464808-03, 1464809-02, 1464809-03, 2063401-03, 2063401-04, 2063401-05, 2063401-06, 2063402-04, 2063402-05, 2063402-06, 2063403-07, 2063403-08, 2063403-09, 2063403-10, 2063404-04, 2063404-05, 2063404-06, 2063404-07, 2063405-04, 2063405-05, 2063405-06, 2063406-07, 2063406-08, 2063406-09, 2063406-10, 2063407-04, 2063407-05, 2063407-06, 2063407-07, 3063401-02, 3063401-03, 3063401-04, 3063402-02, 3063402-03, 3063402-04, 3063405-02, 3063405-03, 3063405-04		





			
Part No.	107870	Ref. No.	201765
description	internal nozzle bore ø 1.25mm suitable for EGA26400/26440		
For models:	1263405-00, 1263405-01, 1363405-00, 1363405-01, 1464812-00, 1464812-01, 1464812-02, 2063420-00, 2063420-01, 2063420-02, 2163422-00, 2163422-01, 2163422-02		

			
Part No.	106510	Ref. No.	201770
description	internal nozzle bore ø 1.30mm suitable for EGA26400/26440		
For models:	1464803-02, 1464803-03, 1464808-02, 1464808-03, 1464809-02, 1464809-03, 2063401-03, 2063401-04, 2063401-05, 2063401-06, 2063402-04, 2063402-05, 2063402-06, 2063403-07, 2063403-08, 2063403-09, 2063403-10, 2063405-04, 2063405-05, 2063405-06, 2063406-07, 2063406-08, 2063406-09, 2063406-10, 3063401-02, 3063401-03, 3063401-04, 3063402-02, 3063402-03, 3063402-04, 3063405-02, 3063405-03, 3063405-04		

			
Part No.	100238	Ref. No.	201832
description	internal nozzle bore ø 1.35mm suitable for EGA 23268,26400,26440		
For models:	1263402-00, 1263402-01, 1263402-02, 1263404-00, 1263404-01, 1263404-02, 1263413-02, 1263414-02, 1363402-00, 1363402-01, 1363402-02, 1363403-00, 1363403-01, 1363403-02, 1363403-03, 1363403-04, 1363403-05, 1363404-00, 1363404-01, 1363404-02, 1363404-03, 1363413-03, 1363415-05, 1464803-02, 1464803-03, 1464808-02, 1464808-03, 1464809-02, 1464809-03, 1464810-01, 1464810-02, 1464811-01, 1464811-02, 2063401-03, 2063401-04, 2063401-05, 2063401-06, 2063402-04, 2063402-05, 2063402-06, 2063403-07, 2063403-08, 2063403-09, 2063403-10, 2063404-04, 2063404-05, 2063404-06, 2063404-07, 2063405-04, 2063405-05... (Other models you can see in the webshop)		

			
Part No.	106480	Ref. No.	201824
description	internal nozzle bore ø 1.5mm suitable for EGA26400/26440		
For models:	1263401-00, 1263402-00, 1263402-01, 1263404-00, 1263404-01, 1363401-00, 1363402-00, 1363402-01, 1363403-00, 1363403-01, 1363403-02, 1363403-03, 1363403-04, 1363404-00, 1363404-01, 1363404-02, 1464803-02, 1464808-02, 1464809-02, 1464810-01, 1464811-01, 2063401-03, 2063401-04, 2063401-05, 2063402-04, 2063402-05, 2063403-07, 2063403-08, 2063403-09, 2063404-04, 2063404-05, 2063404-06, 2063405-04, 2063405-05, 2063406-07, 2063406-08, 2063406-09, 2063407-04, 2063407-05, 2063407-06, 2163401-02, 2163401-03, 2163401-04, 2163402-03, 2163402-04, 2163403-06, 2163403-07, 2163403-08, 2163404-03, 2163404-04... (Other models you can see in the webshop)		

			
Part No.	100951	Ref. No.	10016562
description	internal nozzle bore ø 1.75mm suitable for EGA26400/26440		
accessories for	100951		
	Part No.	100927	Ref. No. —
	torsion spring L 2.8-8.0mm for internal nozzle ø 3mm bore ømm		

			
Part No.	100244	Ref. No.	201837
description	internal nozzle bore ø 1.85mm suitable for EGA 23268,26400,26440		
For models:	1263402-00, 1263402-01, 1263402-02, 1263404-00, 1263404-01, 1263404-02, 1263413-02, 1263414-02, 1363402-00, 1363402-01, 1363402-02, 1363403-00, 1363403-01, 1363403-02, 1363403-03, 1363403-04, 1363403-05, 1363404-00, 1363404-01, 1363404-02, 1363404-03, 1363413-03, 1363415-05, 1464808-02, 1464808-03, 1464809-02, 1464809-03, 1464810-01, 1464810-02, 1464811-01, 1464811-02, 2063402-04, 2063402-05, 2063402-06, 2063403-07, 2063403-08, 2063403-09, 2063403-10, 2063404-04, 2063404-05, 2063404-06, 2063404-07, 2063405-04, 2063405-05, 2063405-06, 2063406-07, 2063406-08, 2063406-09, 2063406-10, 2063407-04... (Other models you can see in the webshop)		

			
Part No.	100314	Ref. No.	10016563
description	internal nozzle bore ø 1.90mm suitable for EGA26400/26440		

			
Part No.	100274	Ref. No.	201694
description	internal nozzle bore ø 2.00mm suitable for EGA26400/26440		
For models:	1263402-00, 1263402-01, 1263404-00, 1263404-01, 1363402-00, 1363402-01, 1363403-00, 1363403-01, 1363403-02, 1363403-03, 1363403-04, 1363404-00, 1363404-01, 1363404-02, 1464803-02, 1464803-03, 1464808-02, 1464808-03, 1464809-02, 1464809-03, 1464810-01, 1464811-01, 1464812-02, 2063401-03, 2063401-04, 2063401-05, 2063401-06, 2063402-04, 2063402-05, 2063402-06, 2063403-07, 2063403-08, 2063403-09, 2063403-10, 2063404-04, 2063404-05, 2063404-06, 2063404-07, 2063405-04, 2063405-05, 2063405-06, 2063406-07, 2063406-08, 2063406-09, 2063406-10, 2063407-04, 2063407-05, 2063407-06, 2063407-07, 2063413-02... (Other models you can see in the webshop)		

			
Part No.	100317	Ref. No.	201771
description	internal nozzle bore ø 2.20mm suitable for EGA26400/26440		
For models:	1263405-00, 1263405-01, 1363405-00, 1363405-01, 1464803-02, 1464808-02, 1464809-02, 1464812-00, 1464812-01, 2063401-03, 2063401-04, 2063401-05, 2063402-04, 2063402-05, 2063403-07, 2063403-08, 2063403-09, 2063404-04, 2063404-05, 2063404-06, 2063405-04, 2063405-05, 2063406-07, 2063406-08, 2063406-09, 2063407-04, 2063407-05, 2063407-06, 2063420-00, 2063420-01, 2063420-02, 2163422-00, 2163422-01, 2163422-02, 3063401-02, 3063401-03, 3063402-02, 3063402-03, 3063405-02, 3063405-03		

			
Part No.	100678	Ref. No.	10016564
description	internal nozzle bore ø 2.50mm suitable for EGA26400/26440		



auxiliary gas parts

screw connections

test nipple screws



Part No.	102762	Ref. No.	205268
description	locking screw with test nipple thread 3/8" WS 17		
For models:	1261101-00, 1261101-01, 1261101-02, 1261102-00, 1261102-01, 1261102-02, 1361101-00, 1361101-01, 1361101-02, 1361101-03, 1361102-00, 1361102-01, 1361102-02, 1361102-03, 1461101-01, 1461101-02, 1461101-03, 1461102-01, 1461102-02, 1461102-03, 1461104-01, 1461104-02, 1461104-03, 1461105-01, 1461105-02, 1461105-03, 1461109-01, 1461109-02, 1461109A01, 1461109A02, 1462802B00, 1462804B00, 1463501-02, 1463501-03, 1463501-04, 1463501-05, 1561110-00, 2061101-01, 2061101-02, 2061101-03, 2061101-04, 2061101-05, 2061102-01, 2061102-02, 2061102-03, 2061102-04, 2061102-05, 2061103-04, 2061107-00, 2061107-01... (Other models you can see in the webshop)		

olives



Part No.	101273	Ref. No.	201594
description	olive for pipe ø 12mm L 9.5mm brass Qty 1 pcs suitable for universal		
For models:	1422802B04, 1422802B05, 1422802B06, 1422802B07, 1422802B08, 1422804B04, 1422804B05, 1422804B06, 1422804B07, 1422804B08, 1422805B04, 1422805B05, 1422805B06, 1422805B07, 1422805B08, 1462802B00, 1462802B01, 1462802B02, 1462802B03, 1462802B04, 1462802B05, 1462804B00, 1462804B01, 1462804B02, 1462804B03, 1462804B04, 1462804B05, 1462831-00, 1462832-00, 1462833-00, 1462834-00, 1462835-00, 1462836-00, 1462837-00, 1462838-00, 1462839-00, 1462840-00, 1462908-00, 1462910-00, 2022802B04, 2022802B05, 2022802B06, 2022802B07, 2022802B08, 2022802B09, 2022802B10, 2022802C07, 2022802C08, 2022802C09, 2022802C10... (Other models you can see in the webshop)		
accessories for	101273		
	Part No.	100944	Ref. No. —
	union nut thread M18x1.5 for pipe ø 12mm		
	Part No.	101276	Ref. No. —
	union screw thread 3/8" tube ø 12mm Qty 1 pcs		



Part No.	101281	Ref. No.	201560
description	olive for pipe ø 4mm L 8.7mm Qty 1 pcs suitable for CB 502/503		
For models:	0260301-00, 0260301-01, 0260302-00, 0260302-01, 0260501-00, 0261101-00, 0261101-01, 0261102-00, 0261102-01, 0261103-00, 0261103-01, 0261301-00, 0261601-00, 1261601-01, 1261602-00, 1261602-01, 1261602-02, 1261602-03, 1261604-03, 1361601-01, 1361601-02, 1361602-00, 1361602-01, 1361602-02, 1361604-02, 1460302-00, 1461101-00, 1461102-00, 1461103-00, 1461602-00, 1462101-00, 1462101-01, 1462101-02, 1462101-03, 1462101-04, 1462101-0, 1462102-00, 1462102-00_V2, 1462102-01, 1463501-02, 1463501-03, 1463501-04, 1463501-05, 2060301-00, 2060501-00, 2060501-01, 2060501-0, 2061101-00, 2061101-0, 2061102-00... (Other models you can see in the webshop)		
accessories for	101281		
	Part No.	101283	Ref. No. 201692
	union screw thread M10x1 for pipe ø 4mm Qty 1 pcs		



Part No.	101284	Ref. No.	201827
description	olive for pipe ø 4mm Qty 1 pcs		
For models:	1261601-01, 1261602-00, 1261602-01, 1261602-02, 1261602-03, 1261604-03, 1361601-01, 1361601-02, 1361602-00, 1361602-01, 1361602-02, 1361604-02		
accessories for	101284		
	Part No.	101259	Ref. No. —
	union nut thread M8x1 for pipe ø 4mm		
	Part No.	101285	Ref. No. —
	union screw thread M8x1 for pipe ø 4mm Qty 1 pcs JUNKERS		
	Part No.	101294	Ref. No. —
	union nut thread M10x1 for pipe ø 4mm WS 14 L 12mm Qty 1 pcs		



Part No.	100870	Ref. No.	201696
description	olive for pipe ø 4mm Qty 1 pcs suitable for 160 series for pilot burner		

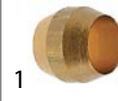

Part No.	101879	Ref. No.	201828
description	olive for pipe ø 5mm Qty 1 pcs		
For models:	0260301-01, 0260302-01, 1260301-00, 1260301-01, 1260302-00, 1260302-01, 1460302-00, 1460302-01, 1460302-02, 2060301-00, 2060301-01, 2060301-02		



Part No.	101286	Ref. No.	201571
description	olive ID ø 6mm Qty 1 pcs		
For models:	0260301-00, 0260301-01, 0260302-00, 0260302-01, 1260301-00, 1260301-01, 1260302-00, 1260302-01, 1412831-00, 1412832-00, 1412833-00, 1412833-01, 1412834-00, 1412834-01, 1412908-00, 1412910-00, 1412910-01, 1422802B04, 1422802B05, 1422802B06, 1422802B07, 1422802B08, 1422804B04, 1422804B05, 1422804B06, 1422804B07, 1422804B08, 1422805B04, 1422805B05, 1422805B06, 1422805B07, 1422805B08, 1422807B00, 1422807B01, 1422807B02, 1422807B03, 1422807B04, 1422831-00, 1422832-00, 1422833-00, 1422834-00, 1422902-00, 1422902-01, 1422902-02, 1422902-03, 1422902-04, 1422908-00, 1422910-00, 1423901-00, 1423901-01... (Other models you can see in the webshop)		
accessories for	101286		
	Part No.	100909	Ref. No. —
	union screw thread M10x1 for pipe ø 6mm Qty 1 pcs		
	Part No.	101464	Ref. No. —
	union nut thread M12x1 for pipe ø 6mm		



union nuts



1

Part No.	101300	Ref. No.	021513
----------	--------	----------	--------

description union nut thread M16x1.5 tube ø 10mm

accessories for 101300



Part No.	101278	Ref. No.	—
----------	--------	----------	---

olive for pipe ø 10mm Qty 1 pcs

union screws



1

Part No.	100906	Ref. No.	201693
----------	--------	----------	--------

description screw connection thread M10x1 for ignition electrode brass Qty 1 pcs WS 10



1

Part No.	101283	Ref. No.	201692
----------	--------	----------	--------

description union screw thread M10x1 for pipe ø 4mm Qty 1 pcs

accessories for 101283



Part No.	101282	Ref. No.	—
----------	--------	----------	---

olive for pipe ø 4mm L 7.4mm Qty 1 pcs



1

Part No.	101878	Ref. No.	945054
----------	--------	----------	--------

description union screw thread M10x1 for pipe ø 5mm Qty 1 pcs for ignition gas pipe

locking screws



1

Part No.	102761	Ref. No.	205267
----------	--------	----------	--------

description locking screw thread 3/8" WS 17

For models: 1261101-00, 1261101-01, 1261101-02, 1261102-00, 1261102-01, 1261102-02, 1361101-00, 1361101-01, 1361101-02, 1361101-03, 1361102-00, 1361102-01, 1361102-02, 1361102-03, 1461101-01, 1461101-02, 1461101-03, 1461102-01, 1461102-02, 1461102-03, 1461104-01, 1461104-02, 1461104-03, 1461105-01, 1461105-02, 1461105-03, 1461109-01, 1461109-02, 1461109A01, 1461109A02, 1462802B00, 1462804B00, 1463501-03, 1463501-04, 1463501-05, 1561110-00, 2061101-01, 2061101-02, 2061101-03, 2061101-04, 2061101-05, 2061102-01, 2061102-02, 2061102-03, 2061102-04, 2061102-05, 2061103-04, 2061107-00, 2061107-01, 2061107-02... (Other models you can see in the webshop)



1

Part No.	102762	Ref. No.	205268
----------	--------	----------	--------

description locking screw with test nipple thread 3/8" WS 17

For models: 1261101-00, 1261101-01, 1261101-02, 1261102-00, 1261102-01, 1261102-02, 1361101-00, 1361101-01, 1361101-02, 1361101-03, 1361102-00, 1361102-01, 1361102-02, 1361102-03, 1461101-01, 1461101-02, 1461101-03, 1461102-01, 1461102-02, 1461102-03, 1461104-01, 1461104-02, 1461104-03, 1461105-01, 1461105-02, 1461105-03, 1461109-01, 1461109-02, 1461109A01, 1461109A02, 1462802B00, 1462804B00, 1463501-02, 1463501-03, 1463501-04, 1463501-05, 1561110-00, 2061101-01, 2061101-02, 2061101-03, 2061101-04, 2061101-05, 2061102-01, 2061102-02, 2061102-03, 2061102-04, 2061102-05, 2061103-04, 2061107-00, 2061107-01... (Other models you can see in the webshop)

gas ball valves

with DIN-DVGW approval



1

Part No.	520508	Ref. No.	201159+203813 201752 845951
----------	--------	----------	-----------------------------------

description gas ball valve straight inlet 3/4" IT outlet 3/4" IT DN20 L 109mm approval DIN-DVGW gas

For models: 1462802B00, 1462802B01, 1462804B00, 1462804B01, 1464812-00, 1464812-01, 2061401-02, 2061401-03, 2061401-04, 2061401-05, 2061401-06, 2061401A01, 2061401A02, 2061401A03, 2061401A05, 2061401A06, 2061401B01, 2061401B02, 2061401B03, 2061401B05, 2061401B06, 2061401C01, 2061401C02, 2061401C03, 2061401C05, 2061401C06, 2061402-02, 2061402-03, 2061402-04, 2061402-05, 2061402-06, 2061402A01, 2061402A02, 2061402A03, 2061402A05, 2061402A06, 2061402B01, 2061402B02, 2061402B03, 2061402B05, 2061402B06, 2061402C01, 2061402C02, 2061402C03, 2061402C05, 2061402C06, 2061403-00, 2061403-01, 2061403-02, 2061403-03... (Other models you can see in the webshop)

consumables

lava rocks / ceramic briquetts



1

Part No.	211100	Ref. No.	201517
----------	--------	----------	--------

description ceramic briquetts size 53x53x24

For models: 0261601-00, 1261601-00, 1261601-01, 1261602-00, 1261602-01, 1261602-02, 1261602-03, 1261604-03, 1361601-00, 1361601-01, 1361601-02, 1361602-00, 1361602-01, 1361602-02, 1361604-02, 1461601-00, 1461602-00, 2061602-00, 2061602-01, 2061603-00, 2061603-01, 2061603-02, 2061604-01, 3061602-00



equipment-specific units

for griddles

spare parts and accessories



1			
Part No.	692883	Ref. No.	203898
description	distance washers for griddle ø 14mm L 25.5mm stainless steel		

for convection ovens/combi-steamers

drain units

drip rails



1			
Part No.	692765	Ref. No.	202125
description	drip rail L 620mm plastic with support plate W 38mm hole ø 5mm for combi-steamer		
For models:	CSE11-R, CSE11-R-DG, CSE12-R, CSE12-R-DG, CSE61-R, CSE61-R-DG, CSE62-R, CSE62-R-DG, CSG11-R-DG, CSG12-R-DG, CSG61-R, CSG61-R-DG, CSG62-R, CSG62-R-DG		
spare parts for	692765		
		Part No.	696808
		Ref. No.	204615
	support bracket zinc-plated sheet steel		



1			
Part No.	694975	Ref. No.	10013386
description	drip rail L 630mm plastic		

accessories



1			
Part No.	696808	Ref. No.	204615
description	support bracket zinc-plated sheet steel		
For models:	CGE11-L, CGE11-R, CGE12-L, CGE12-R, CGE61-L, CGE61-R, CGE62-L, CGE62-R, CGG11-L, CGG11-R, CGG12-L, CGG12-R, CGG61-L, CGG61-R, CGG62-L, CGG62-R, CSE11-L, CSE11-R, CSE11-R-DG, CSE12-L, CSE12-R, CSE12-R-DG, CSE61-L, CSE61-R, CSE61-R-DG, CSE62-L, CSE62-R, CSE62-R-DG, CSG11-L, CSG11-R, CSG11-R-DG, CSG12-L, CSG12-R, CSG12-R-DG, CSG61-L, CSG61-R, CSG61-R-DG, CSG62-L, CSG62-R, CSG62-R-DG		



1			
Part No.	696814	Ref. No.	204416
description	support bracket zinc-plated sheet steel		
For models:	CGE11-L, CGE11-R, CGE12-L, CGE12-R, CGE21-L, CGE21-R, CGE22-L, CGE22-R, CGE61-L, CGE61-R, CGE62-L, CGE62-R, CGG11-L, CGG11-R, CGG12-L, CGG12-R, CGG61-L, CGG61-R, CGG62-L, CGG62-R, CSE11-L, CSE11-R, CSE12-L, CSE12-R, CSE21-L, CSE21-R, CSE22-L, CSE22-R, CSE61-L, CSE61-R, CSE62-L, CSE62-R, CSG11-L, CSG11-R, CSG12-L, CSG12-R, CSG61-L, CSG61-R, CSG62-L, CSG62-R		



1			
Part No.	696812	Ref. No.	205309
description	bush ID ø 10mm L 15mm WS 19 thread ø M16x1mm		
For models:	CGG11-L, CGG11-R, CGG12-L, CGG12-R, CGG21-L, CGG21-R, CGG22-L, CGG22-R, CGG61-L, CGG61-R, CGG62-L, CGG62-R, CSG11-L, CSG11-R, CSG11-R-DG, CSG12-L, CSG12-R, CSG12-R-DG, CSG21-L, CSG21-R, CSG21-R-DG, CSG22-L, CSG22-R, CSG22-R-DG, CSG61-L, CSG61-R, CSG61-R-DG, CSG62-L, CSG62-R, CSG62-R-DG		





1			
Part No.	696813	Ref. No.	204057
description	bush ID ø 12mm ED ø 14mm L 10mm		
For models:	CGE11-L, CGE11-R, CGE12-L, CGE12-R, CGE21-L, CGE21-R, CGE22-L, CGE22-R, CGE61-L, CGE61-R, CGE62-L, CGE62-R, CGG11-L, CGG11-R, CGG12-L, CGG12-R, CGG21-L, CGG21-R, CGG22-L, CGG22-R, CGG61-L, CGG61-R, CGG62-L, CGG62-R, CSE11-L, CSE11-R, CSE11-R-DG, CSE12-L, CSE12-R, CSE12-R-DG, CSE21-L, CSE21-R, CSE21-R-DG, CSE22-L, CSE22-R, CSE22-R-DG, CSE61-L, CSE61-R, CSE61-R-DG, CSE62-L, CSE62-R, CSE62-R-DG, CSG11-L, CSG11-R, CSG11-R-DG, CSG12-L, CSG12-R, CSG12-R-DG, CSG21-L, CSG21-R...(Other models you can see in the webshop)		

1 mechanical components, equipment accessories





			
1			
Part No.	551451	Ref. No.	203820
description	spacer bush ID ø 2.5mm ED ø 9.5mm L 15mm plastic		
For models:	CCE60, CCE63, CGE11-L, CGE11-R, CGE12-L, CGE12-R, CGE21-L, CGE21-R, CGE22-L, CGE22-R, CGE61-L, CGE61-R, CGE62-L, CGE62-R, CGG11-L, CGG11-R, CGG12-L, CGG12-R, CGG21-L, CGG21-R, CGG22-L, CGG22-R, CGG61-L, CGG61-R, CGG62-L, CGG62-R, CPE60, CPE63, CSE11-L, CSE11-R, CSE11-R-DG, CSE12-L, CSE12-R, CSE12-R-DG, CSE21-L, CSE21-R, CSE21-R-DG, CSE22-L, CSE22-R, CSE22-R-DG, CSE61-L, CSE61-R, CSE61-R-DG, CSE62-L, CSE62-R, CSE62-R-DG, CSG11-L, CSG11-R, CSG11-R-DG, CSG12-L...(Other models you can see in the webshop)		

			
1			
Part No.	696810	Ref. No.	203899
description	spacer bush ID ø 4.5mm ED ø 10mm L 8.5mm		

			
1			
Part No.	696803	Ref. No.	203897
description	spacer bush ID ø 6.2mm ED ø 10mm L 3mm stainless steel		

injection pipes

			
1			
Part No.	692826	Ref. No.	935545
description	supply tube for combi-steamer water inlet pipe connection 10/13 1/2" / 3/4"		
For models:	CGG11-L, CGG11-R, CGG12-L, CGG12-R, CGG21-L, CGG21-R, CGG22-L, CGG22-R, CSG11-L, CSG11-R, CSG11-R-DG, CSG12-L, CSG12-R, CSG12-R-DG, CSG21-L, CSG21-R, CSG21-R-DG, CSG22-L, CSG22-R, CSG22-R-DG		

			
1			
Part No.	692825	Ref. No.	10011101
description	water pipe for combi-steamer ED ø 10mm ID ø 8mm		
For models:	CGE11-L, CGE11-R, CGE12-L, CGE12-R, CGE21-L, CGE21-R, CGE22-L, CGE22-R, CGE61-L, CGE61-R, CGE62-L, CGE62-R, CGG11-L, CGG11-R, CGG12-L, CGG12-R, CGG21-L, CGG21-R, CGG22-L, CGG22-R, CGG61-L, CGG61-R, CGG62-L, CGG62-R, CSE11-L, CSE11-R, CSE11-R-DG, CSE12-L, CSE12-R, CSE12-R-DG, CSE61-L, CSE61-R, CSE61-R-DG, CSE62-L, CSE62-R, CSE62-R-DG, CSG11-L, CSG11-R, CSG11-R-DG, CSG12-L, CSG12-R, CSG12-R-DG, CSG21-L, CSG21-R, CSG21-R-DG, CSG22-L, CSG22-R, CSG22-R-DG, CSG61-L, CSG61-R...(Other models you can see in the webshop)		
accessories for	692825		
	Part No.	699481	Ref. No.
			10011098
	gasket suitable for MKN combi-steamer L 58mm W 22mm ID ø 13mm graphite thickness 1.5mm		

			
1			
Part No.	692823	Ref. No.	204580
description	water pipe for combi-steamer ED ø 15mm ID ø 12mm		
For models:	CGE21-L, CGE21-R, CGE22-L, CGE22-R, CGG21-L, CGG21-R, CGG22-L, CGG22-R, CSE21-L, CSE21-R, CSE21-R-DG, CSE22-L, CSE22-R, CSE22-R-DG, CSG21-L, CSG21-R, CSG21-R-DG, CSG22-L, CSG22-R, CSG22-R-DG		

			
1			
Part No.	692824	Ref. No.	935550
description	water pipe for combi-steamer ED ø 15mm ID ø 12mm		
For models:	CGG61-L, CGG61-R, CGG62-L, CGG62-R, CSG61-L, CSG61-R, CSG61-R-DG, CSG62-L, CSG62-R, CSG62-R-DG		

			
1			
Part No.	692822	Ref. No.	204430
description	water pipe for fan wheel for combi-steamer ED ø 15mm ID ø 12mm HD6.x-HD20.x		
For models:	CGE11-L, CGE11-R, CGE12-L, CGE12-R, CGE21-L, CGE21-R, CGE22-L, CGE22-R, CGE61-L, CGE61-R, CGE62-L, CGE62-R, CSE11-L, CSE11-R, CSE11-R-DG, CSE12-L, CSE12-R, CSE12-R-DG, CSE21-L, CSE21-R, CSE21-R-DG, CSE22-L, CSE22-R, CSE22-R-DG, CSE61-L, CSE61-R, CSE61-R-DG, CSE62-L, CSE62-R, CSE62-R-DG		

spare parts and accessories

			
1			
Part No.	699338	Ref. No.	202726
description	battery Lithium H 8mm ø 24.5mm 3V CR2477N		
For models:	CCE60, CCE63, CPE60, CPE63		

Part No.	696807	Ref. No.	204429
description	bracket for cartridge ø 45mm		
For models:	CCE60, CCE63, CGE11-L, CGE11-R, CGE12-L, CGE12-R, CGE21-L, CGE21-R, CGE22-L, CGE22-R, CGE61-L, CGE61-R, CGE62-L, CGE62-R, CGG11-L, CGG11-R, CGG12-L, CGG12-R, CGG21-L, CGG21-R, CGG22-L, CGG22-R, CGG61-L, CGG61-R, CGG62-L, CGG62-R, CPE60, CPE63, CSE11-L, CSE11-R, CSE11-R-DG, CSE12-L, CSE12-R, CSE12-R-DG, CSE61-L, CSE61-R, CSE61-R-DG, CSE62-L, CSE62-R, CSE62-R-DG, CSG11-L, CSG11-R, CSG11-R-DG, CSG12-L, CSG12-R, CSG12-R-DG, CSG61-L, CSG61-R, CSG61-R-DG, CSG62-L, CSG62-R, CSG62-R-DG		



Part No.	850129	Ref. No.	055101
description	insulating mat for combi-steamer L 490mm W 320mm H 15mm cut-out 80x100mm		



Part No.	542435	Ref. No.	201170
description	cover H 25mm ø 57mm		
For models:	CGE11-L, CGE11-R, CGE12-L, CGE12-R, CGE21-L, CGE21-R, CGE22-L, CGE22-R, CGE61-L, CGE61-R, CGE62-L, CGE62-R, CGG11-L, CGG11-R, CGG12-L, CGG12-R, CGG21-L, CGG21-R, CGG22-L, CGG22-R, CGG61-L, CGG61-R, CGG62-L, CGG62-R, CSE11-L, CSE11-R, CSE11-R-DG, CSE12-L, CSE12-R, CSE12-R-DG, CSE21-L, CSE21-R, CSE21-R-DG, CSE22-L, CSE22-R, CSE22-R-DG, CSE61-L, CSE61-R, CSE61-R-DG, CSE62-L, CSE62-R, CSE62-R-DG, CSG11-L, CSG11-R, CSG11-R-DG, CSG12-L, CSG12-R, CSG12-R-DG, CSG21-L, CSG21-R...(Other models you can see in the webshop)		



Part No.	696802	Ref. No.	203724
description	spacer for PCB H 10.5mm plastic ball port ø 3.3mm		
For models:	CGE11-L, CGE11-R, CGE12-L, CGE12-R, CGE21-L, CGE21-R, CGE22-L, CGE22-R, CGE61-L, CGE61-R, CGE62-L, CGE62-R, CGG11-L, CGG11-R, CGG12-L, CGG12-R, CGG21-L, CGG21-R, CGG22-L, CGG22-R, CGG61-L, CGG61-R, CGG62-L, CGG62-R, CPE60, CPE63, CSE11-L, CSE11-R, CSE12-L, CSE12-R, CSE21-L, CSE21-R, CSE22-L, CSE22-R, CSE61-L, CSE61-R, CSE62-L, CSE62-R, CSG11-L, CSG11-R, CSG12-L, CSG12-R, CSG21-L, CSG21-R, CSG22-L, CSG22-R, CSG61-L, CSG61-R, CSG62-L, CSG62-R		



Part No.	696804	Ref. No.	203681
description	cover cap L 39mm ø 12mm ID ø 9.6mm		
For models:	CCE60, CCE63, CGE11-L, CGE11-R, CGE12-L, CGE12-R, CGE21-L, CGE21-R, CGE22-L, CGE22-R, CGE61-L, CGE61-R, CGE62-L, CGE62-R, CGG11-L, CGG11-R, CGG12-L, CGG12-R, CGG21-L, CGG21-R, CGG22-L, CGG22-R, CGG61-L, CGG61-R, CGG62-L, CGG62-R, CPE60, CPE63, CSE11-L, CSE11-R, CSE11-R-DG, CSE12-L, CSE12-R, CSE12-R-DG, CSE21-L, CSE21-R, CSE21-R-DG, CSE22-L, CSE22-R, CSE22-R-DG, CSE61-L, CSE61-R, CSE61-R-DG, CSE62-L, CSE62-R, CSE62-R-DG, CSG11-L, CSG11-R, CSG11-R-DG, CSG12-L, CSG12-R, CSG12-R-DG, CSG21-L, CSG21-R...(Other models you can see in the webshop)		

filters



Part No.	692893	Ref. No.	201134
description	screen H 14mm ø 19.5mm plastic		
For models:	1422807B03, 1422807B04, 1422831-00, 1422832-00, 1422833-00, 1422834-00, 1422902-03, 1422902-04, 1422908-00, 1422910-00, 1423901-00, 1423901-01, 1423901-02, 1423902-00, 1423902-01, 1423902-02, 1423903-00, 1423903-01, 1423903-02, 1462831-00, 1462832-00, 1462833-00, 1462834-00, 1462835-00, 1462836-00, 1462837-00, 1462838-00, 1462839-00, 1462840-00, 1462908-00, 1462910-00, 2022802B08, 2022802B09, 2022802B10, 2022802C08, 2022802C09, 2022802C10, 2022802D00, 2022802D01, 2022802D02, 2022804B08, 2022804B09, 2022804B10, 2022804C08, 2022804C09, 2022804C10, 2022804D00, 2022804D01, 2022804D02, 2022805B08...(Other models you can see in the webshop)		



Part No.	551449	Ref. No.	202755
description	distance washers L 20mm ø 17.5mm plastic		
For models:	CCE60, CCE63, CPE60, CPE63		

housing and bezels



Part No.	694972	Ref. No.	866789
description	bracket L 52mm W 28mm H 115mm		
For models:	CCE60, CCE63, CGE11-L, CGE11-R, CGE12-L, CGE12-R, CGE21-L, CGE21-R, CGE22-L, CGE22-R, CGE61-L, CGE61-R, CGE62-L, CGE62-R, CGG11-L, CGG11-R, CGG12-L, CGG12-R, CGG21-L, CGG21-R, CGG22-L, CGG22-R, CGG61-L, CGG61-R, CGG62-L, CGG62-R, CPE60, CPE63, CSE11-L, CSE11-R, CSE11-R-DG, CSE12-L, CSE12-R, CSE12-R-DG, CSE21-L, CSE21-R, CSE21-R-DG, CSE22-L, CSE22-R, CSE22-R-DG, CSE61-L, CSE61-R, CSE61-R-DG, CSE62-L, CSE62-R, CSE62-R-DG, CSG11-L, CSG11-R, CSG11-R-DG, CSG12-L...(Other models you can see in the webshop)		



			
1			
Part No.	699337	Ref. No.	202782
description	cover cap for USB L 38mm W 29mm		
For models:	CGE11-L, CGE11-R, CGE12-L, CGE12-R, CGE21-L, CGE21-R, CGE22-L, CGE22-R, CGE61-L, CGE61-R, CGE62-L, CGE62-R, CGG11-L, CGG11-R, CGG12-L, CGG12-R, CGG21-L, CGG21-R, CGG22-L, CGG22-R, CGG61-L, CGG61-R, CGG62-L, CGG62-R, CPE60, CPE63		

cleaning system

nozzles

			
1			
Part No.	694665	Ref. No.	201146
description	nozzle thread 1/4" ET H 57mm for cleaning system		
For models:	CGE11-L, CGE11-R, CGE12-L, CGE12-R, CGE21-L, CGE21-R, CGE22-L, CGE22-R, CGE61-L, CGE61-R, CGE62-L, CGE62-R, CSE11-L, CSE11-R, CSE12-L, CSE12-R, CSE21-L, CSE21-R, CSE22-L, CSE22-R, CSE61-L, CSE61-R, CSE62-L, CSE62-R		

			
1			
Part No.	694664	Ref. No.	201152
description	nozzle thread 1/4" ET WS 17 H 37mm for cleaning system		
For models:	CPE63		

screw connections

			
1			
Part No.	362008	Ref. No.	205293
description	connecting piece 1/2" -3/4" L 100,5mm plastic		
For models:	CGE11-L, CGE11-R, CGE12-L, CGE12-R, CGE21-L, CGE21-R, CGE22-L, CGE22-R, CGE61-L, CGE61-R, CGE62-L, CGE62-R, CGG11-L, CGG11-R, CGG12-L, CGG12-R, CGG21-L, CGG21-R, CGG22-L, CGG22-R, CGG61-L, CGG61-R, CGG62-L, CGG62-R, CSE11-L, CSE11-R, CSE11-R-DG, CSE12-L, CSE12-R, CSE12-R-DG, CSE21-L, CSE21-R, CSE21-R-DG, CSE22-L, CSE22-R, CSE22-R-DG, CSE61-L, CSE61-R, CSE61-R-DG, CSE62-L, CSE62-R, CSE62-R-DG, CSG11-L, CSG11-R, CSG11-R-DG, CSG12-L, CSG12-R, CSG12-R-DG, CSG21-L, CSG21-R...(Other models you can see in the webshop)		

service kits

			
1			
Part No.	381514	Ref. No.	205183
description	screw connection kit for temperature probe		
For models:	CGE11-L, CGE11-R, CGE12-L, CGE12-R, CGE21-L, CGE21-R, CGE22-L, CGE22-R, CGE61-L, CGE61-R, CGE62-L, CGE62-R, CGG11-L, CGG11-R, CGG12-L, CGG12-R, CGG21-L, CGG21-R, CGG22-L, CGG22-R, CGG61-L, CGG61-R, CGG62-L, CGG62-R, CPE63, CSE11-L, CSE11-R, CSE12-L, CSE12-R, CSE21-L, CSE21-R, CSE21-R-DG, CSE22-L, CSE22-R, CSE22-R-DG, CSE61-L, CSE61-R, CSE62-L, CSE62-R, CSG11-L, CSG11-R, CSG11-R-DG, CSG12-L, CSG12-R, CSG12-R-DG, CSG21-L, CSG21-R, CSG21-R-DG, CSG22-L, CSG22-R...(Other models you can see in the webshop)		

drip water trays

			
1			
Part No.	692725	Ref. No.	202138
description	gutter for model 10.x L 605mm W 50mm H 20mm plastic		
For models:	CGE11-L, CGE11-R, CGE12-L, CGE12-R, CGE61-R, CGE62-R, CGG11-L, CGG11-R, CGG12-L, CGG12-R, CGG21-R, CGG61-L, CGG61-R, CGG62-L, CGG62-R, CSE11-L, CSE12-L, CSG11-L, CSG11-R, CSG12-L, CSG12-R, CSG61-L, CSG62-L		

door mechanics

door handles

			
1			
Part No.	696815	Ref. No.	207102
description	door handle for combi-steamer L 142mm W 36mm H 55mm grey plastic		
For models:	CCE60, CCE63, CPE60, CPE63		



miscellaneous



1

Part No.	691608	Ref. No.	211137
description	boiler gasket silicone ED ø 15mm suitable for MKN		
For models:	CGG11-L, CGG11-R, CGG12-L, CGG12-R, CGG21-L, CGG21-R, CGG22-L, CGG22-R, CGG61-L, CGG61-R, CGG62-L, CGG62-R, CSG11-L, CSG11-R, CSG11-R-DG, CSG12-L, CSG12-R, CSG12-R-DG, CSG21-L, CSG21-R, CSG21-R-DG, CSG22-L, CSG22-R, CSG22-R-DG, CSG61-L, CSG61-R, CSG61-R-DG, CSG62-L, CSG62-R, CSG62-R-DG		



1

Part No.	692850	Ref. No.	211166
description	cap gasket HDECOD623 D1 ø 19mm D2 ø 5mm ø 15mm		
For models:	CCE60, CCE63, CPE60, CPE63		



1

Part No.	694663	Ref. No.	203356
description	duct bore ø 30mm D1 ø 33.5mm D2 ø 30mm plastic H 12mm		
For models:	0220302A00, 0220302A01, 0220302A02, 0220302A03, 0220302C00, 0220302C01, 0220302C02, 0220302C03, 0220303A00, 0220303A01, 0220303A02, 0220303A03, 0220303C00, 0220303C01, 0220303C02, 0220304-00, 0220305-00, 0220306-00, 0720332R00, 0720332V00, 0723405-01, 0723405-02, 0723412K01, 0723414-02, 1220302-00, 1220302-01, 1220302B00, 1220302B01, 1220302D00, 1220302E00, 1220304-00, 1220304-01, 1220304A00, 1220304A01, 1220304A02, 1220304B00, 1220304B01, 1220304C00, 1220304C01, 1220304C02, 1220304D00, 1220304E00, 1220304F00, 1220304F01, 1220304H00, 1220304H01, 1220306-00, 1220306-01, 1220306A00, 1220306A01... (Other models you can see in the webshop)		



1

Part No.	694988	Ref. No.	204428
description	grommet connection bush Hans Dampf for spray gun		
For models:	CGE11-L, CGE11-R, CGE12-L, CGE12-R, CGE21-L, CGE21-R, CGE22-L, CGE22-R, CGE61-L, CGE61-R, CGE62-L, CGE62-R, CGG11-L, CGG11-R, CGG12-L, CGG12-R, CGG21-L, CGG21-R, CGG22-L, CGG22-R, CGG61-L, CGG61-R, CGG62-L, CGG62-R, CSE11-L, CSE11-R, CSE11-R-DG, CSE12-L, CSE12-R, CSE12-R-DG, CSE21-L, CSE21-R, CSE21-R-DG, CSE22-L, CSE22-R, CSE22-R-DG, CSE61-L, CSE61-R, CSE61-R-DG, CSE62-L, CSE62-R, CSE62-R-DG, CSG11-L, CSG11-R, CSG11-R-DG, CSG12-L, CSG12-R, CSG12-R-DG, CSG21-L, CSG21-R...(Other models you can see in the webshop)		

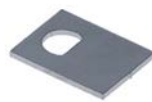

1

Part No.	694661	Ref. No.	866324
description	lever for stop bore ø 6x4.6mm L 17mm W 13mm thickness 1mm		
For models:	0021130A00, 0021130A01, 0021135A00, 2021115-00, 2021115-01, 2021115-02, 2021115-03, 2021115-04, 2221115-00, 2221115-01		



1

Part No.	692813	Ref. No.	201135
description	screen for drain D1 ø 90mm		
For models:	CGE11-L, CGE11-R, CGE12-L, CGE12-R, CGE21-L, CGE21-R, CGE22-L, CGE22-R, CGE61-L, CGE61-R, CGE62-L, CGE62-R, CGG11-L, CGG11-R, CGG12-L, CGG12-R, CGG21-L, CGG21-R, CGG22-L, CGG22-R, CGG61-L, CGG61-R, CGG62-L, CGG62-R, CSE11-L, CSE11-R, CSE11-R-DG, CSE12-L, CSE12-R, CSE12-R-DG, CSE21-L, CSE21-R, CSE21-R-DG, CSE22-L, CSE22-R, CSE22-R-DG, CSE61-L, CSE61-R, CSE61-R-DG, CSE62-L, CSE62-R, CSE62-R-DG, CSG11-L, CSG11-R, CSG11-R-DG, CSG12-L, CSG12-R, CSG12-R-DG, CSG21-L, CSG21-R...(Other models you can see in the webshop)		

for tilting bratt pans

spare parts and accessories



1

Part No.	693493	Ref. No.	204576
description	bush L 49mm ID ø 16mm ext. ø 20		

spindles



1

Part No.	514365	Ref. No.	110115
description	threaded rod		
For models:	2021403-00, 2021403-01, 2021403-02, 2021403-03, 2021403-04, 2021403-05, 2021403-06, 20214033-0, 2021403A00, 2021403A01, 2021403A02, 2021403A04, 2021403A05, 2021403A06, 2021403B00, 2021403B01, 2021403B02, 2021403B04, 2021403B05, 2021403B06, 2021403C01, 2021403C02, 2021403C04, 2021403C05, 2021403C06, 2021405-00, 2021405-01, 2021405-02, 2021405-03, 20214055-0, 2021405B00, 2021405B01, 2021405B02, 2021405B03, 2021413-00, 2021413B00, 2021415B00, 2021432C00, 2023001-00, 20230011-0, 20230011-1, 2023001A00, 2023001B00, 2023001C00, 2023003-00, 20230033-0, 20230033-1, 2023003A00, 2023003B00, 2023003C00... (Other models you can see in the webshop)		



miscellaneous



1

Part No.	514366	Ref. No.	113118
description	threaded bush		
For models:	2021403-00, 2021403-01, 2021403-02, 2021403-03, 2021403-04, 2021403-05, 2021403-06, 20214033-0, 2021403A00, 2021403A01, 2021403A02, 2021403A04, 2021403A05, 2021403A06, 2021403B00, 2021403B01, 2021403B02, 2021403B04, 2021403B05, 2021403B06, 2021403C01, 2021403C02, 2021403C04, 2021403C05, 2021403C06, 2021405-00, 2021405-01, 2021405-02, 2021405-03, 20214055-0, 2021405B00, 2021405B01, 2021405B02, 2021405B03, 2021413-00, 2021413B00, 2021415B00, 2021432C00, 2023001-00, 20230011-0, 20230011-1, 2023001A00, 2023001B00, 2023001C00, 2023003-00, 20230033-0, 20230033-1, 2023003A00, 2023003B00, 2023003C00... (Other models you can see in the webshop)		

for boiling pans

gearboxes



1

Part No.	514365	Ref. No.	110115
description	threaded rod		
For models:	2021403-00, 2021403-01, 2021403-02, 2021403-03, 2021403-04, 2021403-05, 2021403-06, 20214033-0, 2021403A00, 2021403A01, 2021403A02, 2021403A04, 2021403A05, 2021403A06, 2021403B00, 2021403B01, 2021403B02, 2021403B04, 2021403B05, 2021403B06, 2021403C01, 2021403C02, 2021403C04, 2021403C05, 2021403C06, 2021405-00, 2021405-01, 2021405-02, 2021405-03, 20214055-0, 2021405B00, 2021405B01, 2021405B02, 2021405B03, 2021413-00, 2021413B00, 2021415B00, 2021432C00, 2023001-00, 20230011-0, 20230011-1, 2023001A00, 2023001B00, 2023001C00, 2023003-00, 20230033-0, 20230033-1, 2023003A00, 2023003B00, 2023003C00... (Other models you can see in the webshop)		

knobs

producer-specific knobs

MKN



1

Part No.	110640	Ref. No.	209230 209236 209917
description	knob energy regulator 1-10 t.max. °C ø 53mm shaft ø 6x4.6mm shaft flat right black		
For models:	00217022-0, 0521701-00, 0521701-01, 0521702-00, 0521702-01, 0521702-02, 0521702-03, 0521702-04, 0521702A02, 0521702A03, 0521702A04, 0521702B03, 0521702B04, 0521702C04, 0521704-0, 0521704-00, 0521704-01, 0521704-02, 0521704-03, 0521704-04, 0521704-05, 0521704-06, 0521704-07, 0521705-00, 0521705-01		



1

Part No.	110637	Ref. No.	209227 209233 209909 209911
description	knob ON-OFF t.max. °C ø 54mm shaft ø 6x4.6mm shaft flat upper black		
For models:	0021130A00, 0021130A01, 0021135A00, 0120101-00, 0120101C00, 0120105-00, 0120105C00, 0220302F00, 0520302-00, 0520303-00, 0520303-01, 0520303-02, 0520901-00, 0522101-01, 0522101-02, 0522102-00, 0522102-01, 0522102-02, 1323208-00, 1323208-01, 1363403-00, 1422101-00, 1422101-01, 1422101-02, 1422102-00, 1422102-01, 1422102-02, 1424816-00, 1820301-00, 1820301-01, 2063403-00, 2063403-01, 2063403-02, 2063403-03, 2063403-04, 2063403-05, 2063406-00, 2063406-01, 2063406-02, 2063406-03, 2063406-04, 2063406-05, 2063415-00, 2063415-01, 2063415-02, 2063415-03, 2063415-04, 2063418-00, 2063418-01, 2063418-02... (Other models you can see in the webshop)		



1

Part No.	111887	Ref. No.	209226 209914
description	knob switch 7-position ø 53mm shaft ø 6x4.6mm shaft flat upper black		
For models:	1424816-00, 18232011-0		



1

Part No.	110638	Ref. No.	209229 209910
description	knob thermostat t.max. 110°C ø 53mm shaft ø 6x4.6mm shaft flat upper black temperature range 30-110°C		
For models:	0520901-00, 1224002-00, 1224002-01, 1224003-00, 1224003-01, 1224004-00, 1224004-01, 1224005-00, 1224005-01, 1224006-00, 1224006-01, 1224007-00, 1224007-01, 1224008-00, 1224008-01, 1224009-00, 1224009-01, 1820501-00, 18208011-0		



1

Part No.	110636	Ref. No.	209232 209233 209911
description	knob thermostat t.max. 185°C ø 53mm shaft ø 6x4.6mm shaft flat upper black temperature range 100-185°C rotation 270°		





			
1			
Part No.	110641	Ref. No.	209228 209912
description	knob thermostat t.max. 300°C ø 52mm shaft ø 6x4.6mm shaft flat upper black temperature range 50-300°C rotation 270°		
For models:	0021130A00, 0021130A01, 0021135A00, 0522101-01, 0522101-02, 0522102-00, 0522102-01, 0522102-02, 1323208-00, 1323208-01, 1363403-00, 1422101-00, 1422101-01, 1422101-02, 1422102-00, 1422102-01, 1422102-02, 1424816-00, 1821101-00, 2063403-00, 2063403-01, 2063403-02, 2063403-03, 2063403-04, 2063403-05, 2063406-00, 2063406-01, 2063406-02, 2063406-03, 2063406-04, 2063406-05, 2063415-00, 2063415-01, 2063415-02, 2063415-03, 2063415-04, 2063418-00, 2063418-01, 2063418-02, 2063418-03, 2063418-04, 2063502-00, 2063502-01, 2063502-02, 2063502-03, 2063502-04, 2063502-05, 2063502-06, 2063507-00, 2063507-01... (Other models you can see in the webshop)		

			
1			
Part No.	111867 ¹	Ref. No.	209906
description	knob gas tap with ignition flame t.max.°C ø 65mm shaft ø 6x4.6mm shaft flat left black for EGA24197/PEL		
For models:	0260501-00, 0261101-00, 0261101-01, 0261102-00, 0261102-01, 0261103-00, 0261103-01, 0261301-00, 0261601-00, 0263401-00, 0263401-01, 1261301-00, 1261301-01, 1261301-02, 1261601-00, 1261601-01, 1261602-00, 1261602-01, 1261602-02, 1261602-03, 1261604-03, 1263405-00, 1263405-01, 1361301-00, 1361301-01, 1361301-02, 1361301-03, 1361601-00, 1361601-01, 1361601-02, 1361602-00, 1361602-01, 1361602-02, 1361604-02, 1363405-00, 1363405-01, 1461601-00, 1461602-00, 1463501-00, 1463501-01, 1463501-02, 1463501-03, 1463501-04, 1463501-05, 2061301-01, 2061401-00, 2061401-01, 2061401A00, 2061401B00, 2061401C00... (Other models you can see in the webshop)		

¹for EGA24197/PEL

			
1			
Part No.	112731	Ref. No.	209239
description	knob thermostat t.max.°C 30-70°C ø 53mm shaft ø 6x4.6mm shaft flat left black		
For models:	0120201-01, 0120202-01, 0120203-01		

			
1			
Part No.	111433	Ref. No.	209282
description	knob gas tap with ignition flame t.max.°C ø 65mm shaft ø 6x4.6mm shaft flat lower black		
For models:	1263402-01, 1263402-02, 1263404-01, 1263404-02, 1263413-02, 1263414-02, 1363402-02, 1363403-04, 1363403-05, 1363404-02, 1363404-03, 1363413-03, 1363415-05, 1464802-02, 1464803-03, 1464808-03, 1464809-03, 1464810-02, 1464811-02, 1464812-01, 1464812-02, 2063401-05, 2063401-06, 2063402-05, 2063402-06, 2063403-09, 2063403-10, 2063404-06, 2063404-07, 2063405-05, 2063405-06, 2063406-09, 2063406-10, 2063407-06, 2063407-07, 2063420-01, 2063420-02, 2163401-04, 2163401-05, 2163402-04, 2163402-05, 2163403-08, 2163403-09, 2163404-05, 2163404-06, 2163405-04, 2163405-05, 2163406-08, 2163406-09, 2163407-05... (Other models you can see in the webshop)		

			
1			
Part No.	111862	Ref. No.	209904
description	knob energy regulator 1-10 t.max.°C ø 65mm shaft ø 6x4.6mm shaft flat upper black		
For models:	0221001H00, 0221202-00, 0221501-00, 0221502-00, 1022603-00, 1023401-00, 1023401K00, 1220402-00, 1220402-01, 1221501-00, 1221501-01, 1221501-02, 1222603-00, 1223202A00, 1223202A01, 1223202J00, 1223202J01, 1223203-00, 1223203-01, 1223203-02, 1223204-00, 1223204-01, 1223204-02, 1223205-00, 1223205-01, 1223205-02, 1223206-00, 1223206-01, 1223206-02, 1223209-00, 1223209-01, 1223211-00, 1223212-00, 1223213-00, 1223214-00, 1223401-00, 1223401J00, 1223401K00, 1223401L00, 1223402-00, 1223402K00, 1320402-00, 1320402-01, 1321501-00, 1321501-01, 1321501-02, 1321501-03, 1322603-00, 1323202A00, 1323202A01... (Other models you can see in the webshop)		

			
1			
Part No.	111863 ¹	Ref. No.	209907
description	knob gas tap with ignition flame t.max.°C ø 65mm shaft ø 6x4.6mm shaft flat right black for EGA24197/PEL		
For models:	0263401-00, 0263401-01, 2063413-00, 2063413-01, 2063413-02, 2063414-03, 2063415-05, 2063416-02, 2063417-03, 2063418-05, 2063419-02, 2163415-00, 3063413-00		

¹for EGA24197/PEL



			
1			
Part No.	111902 ¹	Ref. No.	209944
description	knob gas tap with ignition flame t.max.°C°C ø 65mm shaft ø 6x4.6mm shaft flat right black for EGA26400		
For models:	1260501-00, 1360501-00, 1360501-01		

¹for EGA26440

			
1			
Part No.	111864 ¹	Ref. No.	209908
description	knob gas tap with ignition flame t.max.°C°C ø 65mm shaft ø 6x4.6mm shaft flat upper black for EGA24197/PEL		
For models:	20611011-0, 20611022-0, 20611033-0, 2061104-00, 20611044-0, 2061105-00, 20611055-0, 2061106-00, 20611066-0, 2063501-00, 2063501-01, 2063501-02, 2063501-03, 2063501-04, 2063501-05, 2063501-06, 2063501-1-0, 2063502-00, 2063502-01, 2063502-02, 2063502-03, 2063502-04, 2063502-05, 2063502-06, 2063502-07, 2063502-08, 2063502-09, 2063502-10, 20635022-0, 2063503-00, 2063503-01, 2063503-02, 2063503-03, 2063503-04, 2063503-05, 2063503-06, 2063503-07, 20635033-0, 2063504-00, 2063504-01, 2063504-02, 2063504-03, 20635044-0, 2063505-00, 20635055-0, 2063506-01, 2063506-02, 2063506-03, 2063506-04, 2063506-05... (Other models you can see in the webshop)		

¹for EGA24197/PEL

			
1			
Part No.	111886 ¹	Ref. No.	209013
description	knob gas tap with ignition flame t.max.°C°C ø 65mm shaft ø 6x4.6mm shaft flat upper black for EGA26400		
For models:	1263401-00, 1263402-00, 1263404-00, 1363401-00, 1363402-00, 1363402-01, 1363403-00, 1363403-01, 1363403-02, 1363403-03, 1363404-00, 1363404-01, 1464802-01, 1464803-01, 1464803-02, 1464808-01, 1464808-02, 1464809-01, 1464809-02, 1464810-01, 1464811-01, 1464812-00, 2063401-00, 2063401-01, 2063401-02, 2063401-03, 2063401-04, 2063401-1-0, 2063402-00, 2063402-01, 2063402-02, 2063402-03, 2063402-04, 20634022-0, 2063403-00, 2063403-01, 2063403-02, 2063403-03, 2063403-04, 2063403-05, 2063403-06, 2063403-07, 2063403-08, 2063404-00, 2063404-01, 2063404-02, 2063404-03, 2063404-04, 2063404-05, 2063405-00... (Other models you can see in the webshop)		

¹for EGA26440

			
1			
Part No.	111781	Ref. No.	209051
description	knob OEKO/HAND t.max.°C°C ø 65mm shaft ø 6x4.6mm shaft flat upper		
For models:	1023401-00, 1023410-00, 1223202A00, 1223202A01, 1223202J00, 1223202J01, 1223209-00, 1223209-01, 1223401-00, 1223401J00, 1223402-00, 1323202A00, 1323202A01, 1323202A02, 1323209-00, 1323209-01, 1323209-02, 1323209-03, 1323210-00, 1323210-01, 1323210-02, 1323210-03, 1323210-04, 1323401-00, 1323402-00, 1323403-00, 1423401-00, 1423402-00, 1423404-00, 1423404-01, 1423405-00, 1423405-01, 1423405-02, 1423409-00, 1423409-01, 1423409-02, 1423414-02, 1424818A00, 1424819-00, 1424825-00, 1424826-00, 1523401-00, 1523402-00, 1523405-00, 1523405-01, 1523409-00, 1523409-01, 1523410-00, 2023206-00, 2023206-01... (Other models you can see in the webshop)		

			
1			
Part No.	111889	Ref. No.	209248
description	knob oven TH/BH/TH+BH t.max.°C°C ø 65mm shaft ø 6x4.6mm shaft flat right black		
For models:	0522101-03, 0522101-04, 0522102-03, 0522102-04, 1323208-02, 1323208-03, 1323208-04, 1323210-00, 1323210-01, 1323210-02, 1323210-03, 1323210-04, 1323403-00, 1323403K00, 1323506-00, 1323506-01, 1323506A00, 1323506A01, 1323517-00, 1323517A00, 1363403-01, 1363403-02, 1363403-03, 1363403-04, 1363403-05, 1363415-05, 1422101-03, 1422101-04, 1422101-05, 1422101-06, 1422102-03, 1422102-04, 1422102-05, 1422104-05, 1422104A05, 1422105-05, 1422105A05, 1422106-05, 1422106-06, 1422106A05, 1422106A06, 1422107-05, 1422107-06, 1422107A05, 1422107A06, 1422301-01, 2023114-00, 2023118-00, 2023119-00, 2023203-05... (Other models you can see in the webshop)		

			
1			
Part No.	112526	Ref. No.	209481
description	knob potentiometer t.max.°C°C ø 71mm shaft ø 6x4.6mm shaft flat upper with spring		
For models:	CGE11-L, CGE11-R, CGE12-L, CGE12-R, CGE21-L, CGE21-R, CGE22-L, CGE22-R, CGE61-L, CGE61-R, CGE62-L, CGE62-R, CGG11-L, CGG11-R, CGG12-L, CGG12-R, CGG21-L, CGG21-R, CGG22-L, CGG22-R, CGG61-L, CGG61-R, CGG62-L, CGG62-R, CPE60, CPE63, CSE11-L, CSE11-R, CSE12-L, CSE12-R, CSE21-L, CSE21-R, CSE22-L, CSE22-R, CSE61-L, CSE61-R, CSE62-L, CSE62-R, CSG11-L, CSG11-R, CSG12-L, CSG12-R, CSG21-L, CSG21-R, CSG22-L, CSG22-R, CSG61-L, CSG61-R, CSG62-L, CSG62-R		





			
1			
Part No.	111778	Ref. No.	209900
description	knob switch 0-1-0-1 t.max.°C ø 65mm shaft ø 6x4.6mm shaft flat upper black		
For models:	0220301-00, 0220301B00, 0220301B01, 0220301B02, 0220301D00, 0220302-00, 0220302A00, 0220302A01, 0220302A02, 0220302A03, 0220302B00, 0220302B01, 0220302B02, 0220302C00, 0220302C01, 0220302C02, 0220302C03, 0220302D00, 0220302E00, 0220302E01, 0220302H00, 0220302H01, 0220303-00, 0220303-01, 0220303A00, 0220303A01, 0220303A02, 0220303A03, 0220303B00, 0220303B01, 0220303C00, 0220303C01, 0220303C02, 0220303D00, 0220303D01, 0220303E00, 0220303E01, 0220303H00, 0220303H01, 0220304-00, 0220305-00, 0220306-00, 0220501-00, 0220502-00, 0220503-00, 0220601-00, 0220802-00, 0221001H00, 0221101-00, 0221101-01... (Other models you can see in the webshop)		

			
1			
Part No.	111800	Ref. No.	209222
description	knob t.max.°C ø 65mm shaft ø 6x4.6mm shaft flat upper black		
For models:	1461101-02, 1461102-02, 1461104-02, 1461105-02, 1461109-01, 1461109A01, 1461109A02, 2061107-01, 2061107A01, 3061101-01, 3061101-02, 3061102-01, 3061102-02, 3061107-01, 3061107A01		

			
1			
Part No.	110198	Ref. No.	209012
description	knob switch 4-position t.max.°C ø 65mm shaft ø 6x4.6mm shaft flat upper black		
For models:	1220304-00, 1220304-01, 1220304A00, 1220304A01, 1220304A02, 1220304B00, 1220304B01, 1220304C00, 1220304C01, 1220304C02, 1220304D00, 1220304E00, 1220304F00, 1220304F01, 1220304H00, 1220304H01, 1220504-01, 1222601-00, 1320304-00, 1320304-01, 1320304A00, 1320304A01, 1320304A02, 1320304B00, 1320304B01, 1320304C00, 1320304C01, 1320304C02, 1320304D00, 1320304D01, 1320304E00, 1320304E01, 1320304F00, 1320304F01, 1320304F02, 1320304F03, 1320304F04, 1320304H00, 1320304H01, 1320304H02, 1320304H03, 1320304H04, 1320504-01, 1320504-02, 1322601-00, 1420509-01, 1422601-00, 1422602-00, 1422802B04, 1422802B05... (Other models you can see in the webshop)		

			
1			
Part No.	111780	Ref. No.	209052
description	knob thermostat 1-10 t.max.°C ø 65mm shaft ø 6x4.6mm shaft flat upper		
For models:	1023410-00, 1423404-00, 1423404-01, 1423405-00, 1423405-01, 1423405-02, 1423409-00, 1423409-01, 1423409-02, 1423414-02, 1424819-00, 1424826-00, 1523405-00, 1523405-01, 1523409-00, 1523409-01, 1523410-00, 2023206-00, 2023206-01, 2023206-02, 2023207-00, 2023207-01, 2023207-02, 2023207-03, 2023207-04, 2023207-05, 2023405-00, 2023405D00, 2023406-00, 2023409-00, 3023206-00, 3023206-01, 3023206-02, 3023405-00, 3023406-00, 3023409-00		

			
1			
Part No.	111779	Ref. No.	209905
description	knob switch 7-position t.max.°C ø 65mm shaft ø 6x4.6mm shaft flat upper black		
For models:	0223202-00, 1223201-00, 1223201-01, 1223202-00, 1223207-00, 1223207-01, 1320401-00, 1320401-01, 1323201-00, 1323201-01, 1323201-02, 1323207-00, 1323207-02, 1323208-00, 1323208-01, 1323208-02, 1323208-03, 1323208-04, 1420401-00, 1420401-01, 1424802-00, 1424802-01, 1424802-02, 1424808-00, 1424808-01, 1424808-02, 1424808-03, 1424809-00, 1424809-01, 1424809-02, 1424809-03, 1424809-04, 1424809-05, 1424809-06, 1424809-07, 1424809-08, 1424809-09, 1424809-10, 1424809-11, 1424809-12, 1424809-13, 1424812-00, 1424812-01, 1424812-02, 1424813-00, 1424813-01, 1424813-02, 2020401-00, 2020401-01, 2023201-00, 2023201-01, 2023201-02, 2023201-03, 2023201-04, 2023201-05, 2023201-06, 2023201-07, 2023201-08, 2023201-09, 2023201-10, 2023201-11, 2023202-00... (Other models you can see in the webshop)		

			
1			
Part No.	111868	Ref. No.	209930
description	knob thermostat 1-10 t.max.°C ø 65mm shaft ø 6x4.6mm shaft flat upper		
For models:	1223215-00, 1223215A00, 1223216-00, 1223216A00, 1223504A00, 1223505-00, 1223505A00, 1323504-00, 1323504A00, 1323505-00, 1323505A00, 1323506-00, 1323506A00, 1323515-00, 1323515A00, 1323516-00, 1323516A00, 1323517-00, 1323517A00, 1423501-00, 1423501A00, 1423502-00, 1423502-01, 1423502A00, 1423502A01, 1423504-00, 1423504A00, 1423505-00, 1423505A00, 1423507A00, 1423508A00, 1423524A00, 1423525A00, 1424814-00, 1424814-01, 1424814-02, 1424814-03, 1424814-04, 1424814A00, 1424814A01, 1424814A03, 1424814A04, 1424815-00, 1424815-01, 1424815-02, 1424815-03, 1424815-04, 1424815A00, 1424815A01, 1424815A03... (Other models you can see in the webshop)		

1

Part No.	110199	Ref. No.	209901
description	knob thermostat t.max. 110°C ø 65mm shaft ø 6x4.6mm shaft flat upper black temperature range 30-110°C rotation 270°		
For models:	0220501-00, 0220502-00, 0220503-00, 0220802-00, 1020510-00, 1022603-00, 1120510-00, 1120510-01, 1220402-00, 1220402-01, 1220501-00, 1220501-01, 1220501-02, 1220502-00, 1220502-01, 1220503-00, 1220504-01, 1220802-00, 1220802-01, 1222601-00, 1222603-00, 1320402-00, 1320402-01, 1320501-00, 1320501A00, 1320501A01, 1320502-00, 1320502A00, 1320502A01, 1320504-01, 1320504-02, 1320802-00, 1320802A00, 1322601-00, 1322603-00, 1420402-00, 1420402-01, 1420405-00, 1420501-00, 1420501-01, 1420501-02, 1420501-03, 1420502-00, 1420502-01, 1420502-02, 1420504-00, 1420504-01, 1420504-02, 1420504-03, 1420504-04... (Other models you can see in the webshop)		



1

Part No.	111938	Ref. No.	209075
description	knob time 15min t.max.°C ø 65mm shaft ø 6x4.6mm shaft flat upper black		
For models:	0220302A03, 0220302C03, 0220302H01, 0220303A03, 0220303C02, 0220303H01, 1220303A00, 1220303A01, 1220303A02, 1220303A03, 1220303C00, 1220303C01, 1220303C02, 1220303C03, 1220303F01, 1220303F02, 1220303F03, 1220303H00, 1220303H01, 1220303H02, 1220303H03, 1220305A00, 1220305A01, 1220305A02, 1220305A03, 1220305A04, 1220305A05, 1220305C00, 1220305C01, 1220305C02, 1220305C03, 1220305C04, 1220305C05, 1220305E00, 1220305E01, 1220305F01, 1220305F02, 1220305F03, 1220305F04, 1220305F05, 1220305H00, 1220305H01, 1220305H02, 1220305H03, 1220305H04, 1220305H05, 1320303A00, 1320303A01, 1320303A02, 1320303C00... (Other models you can see in the webshop)		



2

Part No.	111905	Ref. No.	209902
description	knob thermostat t.max. 185°C ø 65mm shaft ø 6x4.6mm shaft flat upper black temperature range 100-185°C rotation 270°		
For models:	0220301-00, 0220301B00, 0220301B01, 0220301B02, 0220301D00, 0220302-00, 0220302A00, 0220302A01, 0220302A02, 0220302A03, 0220302B00, 0220302B01, 0220302B02, 0220302C00, 0220302C01, 0220302C02, 0220302C03, 0220302D00, 0220302E00, 0220302E01, 0220302H00, 0220302H01, 0220303-00, 0220303-01, 0220303A00, 0220303A01, 0220303A02, 0220303A03, 0220303B00, 0220303B01, 0220303C00, 0220303C01, 0220303C02, 0220303D00, 0220303D01, 0220303E00, 0220303E01, 0220303H00, 0220303H01, 0220304-00, 0220305-00, 0220306-00, 0720332R00, 0720332V00, 1220301-00, 1220301-01, 1220301-02, 1220301-03, 1220301-04, 1220301B00... (Other models you can see in the webshop)		



1

Part No.	112801	Ref. No.	209918
description	knob zero mark ø 65mm MKN shaft ø 6x4.6mm shaft flat upper black		
For models:	14228011-0, 14228022-0, 14228033-0, 14228044-0, 14228055-0, 2012801-00, 2012801-01, 2012801A00, 2012801A01, 2012801B00, 2012801B01, 2012801C00, 2012801C01, 2012802-00, 2012802-01, 2012802A00, 2012802A01, 2012802B00, 2012802B01, 2012802C00, 2012802C01, 2012803-00, 2012803-01, 2012803A00, 2012803A01, 2012803B00, 2012803B01, 2012803C00, 2012803C01, 2012804-00, 2012804-01, 2012804A00, 2012804A01, 2012804B00, 2012804B01, 2012804C00, 2012804C01, 2012805-00, 2012805-01, 2012805A00, 2012805A01, 2012805B00, 2012805B01, 2012805C00, 2012805C01, 2012806B00, 2012806C00, 2012807B00, 2012807C00, 2012901B00... (Other models you can see in the webshop)		



1

Part No.	111888	Ref. No.	209903
description	knob thermostat t.max. 300°C 50-300°C ø 65mm shaft ø 6x4.6mm shaft flat upper black rotation 270°		
For models:	0221101-00, 0221101-01, 0221101A00, 0221101A01, 0221102-00, 0221102-01, 0221103-00, 0221103-01, 0221104-00, 0221104-01, 0221104A00, 0221104A01, 0221105-00, 0221105-01, 0221106-00, 0221106-01, 0221107-00, 0221107A00, 0221108-00, 0221109-00, 0221109A00, 0221110-00, 0522101-00, 0522101-03, 0522101-04, 0522102-03, 0522102-04, 1121117-00, 1121117-01, 1121117A00, 1121118-00, 1121118-01, 1121119-00, 1121119A00, 1121120-00, 1121121-00, 1121121A00, 1121135A01, 1221101-00, 1221101A00, 1221101B00, 1221102-00, 1221102A00, 1221102B00, 1221103-00, 1221103-01, 1221103-02, 1221103-04, 1221103A00, 1221103A01... (Other models you can see in the webshop)		

1

Part No.		Ref. No.	580029
description	knob		



1

Part No.	111885	Ref. No.	209224
description	knob switch zero mark ø 21mm shaft ø 6mm black		



1

Part No.		Ref. No.	580030
description	knob		

1

Part No.		Ref. No.	209007
description	knob		

1

Part No.		Ref. No.	209024
description	knob		



1

Part No.	690965	Ref. No.	216076
description	hand wheel ø 175mm D1 ø 40mm bore ø 16mm thread M6 hole distance 7mm groove widthmm L1 42mm L2 55mm handle length 80mm with folding handle		
For models:	2013003B04, 2013003B05, 2013003B06, 2013007B04, 2013007B05, 2013007B06, 2013009B04, 2013009B05, 2013009B06, 2013017B03, 2013017B04, 2013017B05, 2021401-09, 2021401A09, 2021401B09, 2021401C09, 2021407-03, 2021407A03, 2021407B03, 2021407C03, 2021409-02, 2021409B02, 2021430-01, 2021430-02, 2021430A01, 2021430A02, 2021430B02, 2021430B03, 2021430C02, 2021430C03, 2021436-02, 2021436-03, 2021436A02, 2021436A03, 2021436B02, 2021436B03, 2021436C02, 2021436C03, 2021440-04, 2021440-05, 2021440A04, 2021440A05, 2021440B04, 2021440B05, 2021440C04, 2021440C05, 2021441-04, 2021441-05, 2021441-06, 2021441-07... (Other models you can see in the webshop)		
accessories for	690965		
		Part No.	560555 Ref. No. —
	hexagonal screw thread M6 thread L 15mm SS WS 10 Qty 1 pcs DIN 933 / ISO 4017		

handles and hand wheels

hand wheels

hand wheels



1

Part No.	690966	Ref. No.	216004
description	hand wheel ø 175mm D1 ø 40mm bore ø 16mm thread M6 hole distance 7mm groove widthmm L1 41mm L2 55mm handle length 80mm with folding handle with fixing kit		
For models:	2013003B01, 2013003B02, 2013003B03, 2013007B01, 2013007B02, 2013007B03, 2013009B01, 2013009B02, 2013009B03, 2013017B00, 2013017B01, 2013017B02, 2021401-02, 2021401-03, 2021401-04, 2021401-05, 2021401-06, 2021401-07, 2021401-08, 2021401A01, 2021401A02, 2021401A03, 2021401A04, 2021401A06, 2021401A07, 2021401A08, 2021401B01, 2021401B02, 2021401B03, 2021401B04, 2021401B06, 2021401B07, 2021401B08, 2021401C01, 2021401C02, 2021401C03, 2021401C04, 2021401C06, 2021401C07, 2021401C08, 2021405C00, 2021407-00, 2021407-01, 2021407-02, 2021407A02, 2021407B00, 2021407B01, 2021407B02, 2021407C02, 2021409-00... (Other models you can see in the webshop)		





1

Part No.	690964	Ref. No.	216907
description	hand wheel ø 200mm D1 ø 40mm bore ø 20mm thread M6 groove widthmm L1 20mm L2 60mm handle length 90mm with folding handle		
For models:	2021403-00, 2021403-01, 2021403-02, 2021403-03, 2021403-04, 2021403-05, 2021403-06, 20214033-0, 2021403A00, 2021403A01, 2021403A02, 2021403A04, 2021403A05, 2021403A06, 2021403B00, 2021403B01, 2021403B02, 2021403B04, 2021403B05, 2021403B06, 2021403C01, 2021403C02, 2021403C04, 2021403C05, 2021403C06, 2021405-00, 2021405-01, 2021405-02, 2021405-03, 20214055-0, 2021405B00, 2021405B01, 2021405B02, 2021405B03, 2021413-00, 2021413B00, 2021415B00, 2021432C00, 2023001-00, 20230011-0, 20230011-1, 2023001A00, 2023001B00, 2023001C00, 2023003-00, 20230033-0, 20230033-1, 2023003A00, 2023003B00, 2023003C00... (Other models you can see in the webshop)		
spare parts for	690964		
		Part No.	690859 Ref. No. —
	folding handle ø 28mm total length 110mm seat ø 26mm shaft ømm thread M6 with pin L 110mm		



ball handles

			
1			
Part No.	693474	Ref. No.	207035
description	ball handle ø 40mm bore ø conical 12mm for drive into black		
For models:	0521704-00, 0521704-02, 0521704-03, 0521704-04, 0521704-05, 0521704-06, 0521704-07, 0521704A00, 0521704A01, 0521705-00, 0521705-01, 0522101-00, 0522101-01, 0522101-02, 0522101-03, 0522101-04, 0522102-00, 0522102-01, 0522102-02, 0522102-03, 0522102-04, 0722101-06, 1323208-00, 1323208-01, 1323208-02, 1323208-03, 1323208-04, 1323210-00, 1323210-01, 1323210-02, 1323210-03, 1323210-04, 1323403-00, 1323403K00, 1323506-00, 1323506-01, 1323506A00, 1323506A01, 1323517-00, 1323517A00, 1363403-00, 1363403-01, 1363403-02, 1363403-03, 1363403-04, 1363403-05, 1363415-05, 1412831-00, 1412832-00, 1412833-00... (Other models you can see in the webshop)		
accessories for	693474		
		Part No.	696529
		Ref. No.	—
	lever for ball handle thread M8x1.25 ø 12/14mm angled 90° SS		

lever handles

			
1			
Part No.	692814	Ref. No.	10013388
description	door handle plastic ø 48mm L 190mm suitable for MKN black		

door handles

door handles

			
1			
Part No.	693473	Ref. No.	207179
description	door handle metal dimensions ø10mm		
For models:	0522101-00, 0522101-01, 0522101-02, 0522101-03, 0522101-04, 0522102-00, 0522102-01, 0522102-02, 0522102-03, 0522102-04, 0722101-06, 1323208-00, 1323208-01, 1323208-02, 1323208-03, 1323208-04, 1323210-00, 1323210-01, 1323210-02, 1323210-03, 1323210-04, 1323403-00, 1323403K00, 1323506-00, 1323506-01, 1323506A00, 1323506A01, 1323517-00, 1323517A00, 1363403-00, 1363403-01, 1363403-02, 1363403-03, 1363403-04, 1363403-05, 1363415-05, 1422101-00, 1422101-01, 1422101-02, 1422101-03, 1422101-04, 1422101-05, 1422101-06, 1422102-00, 1422102-01, 1422102-02, 1422102-03, 1422102-04, 1422102-05, 1422104-05... (Other models you can see in the webshop)		

locks





electromagnetic closer

			
1			
Part No.	692216	Ref. No.	203768
description	electromagnetic closer 24V voltage DC L 104mm W 24mm H 34mm series 8440		
For models:	CPE63		

handle latches

producer-specific

MKN

			
1			
Part No.	691666	Ref. No.	207092
description	catch clamp length 46mm BL 31mm for off-set 59-69mm		
For models:	CGE11-L, CGE11-R, CGE12-L, CGE12-R, CGE61-L, CGE61-R, CGE62-L, CGE62-R, CGG11-L, CGG11-R, CGG12-L, CGG12-R, CGG61-L, CGG61-R, CGG62-L, CGG62-R, CSE11-L, CSE11-R, CSE11-R-DG, CSE12-L, CSE12-R, CSE12-R-DG, CSE61-L, CSE61-R, CSE61-R-DG, CSE62-L, CSE62-R, CSE62-R-DG, CSG11-L, CSG11-R, CSG11-R-DG, CSG12-L, CSG12-R, CSG12-R-DG, CSG61-L, CSG61-R, CSG61-R-DG, CSG62-L, CSG62-R, CSG62-R-DG		
spare parts for	691666		
		Part No.	514390
		Ref. No.	—
	spring for door handle ø 6mm L 54mm W 27.5mm		
accessories for	691666		
		Part No.	691780
		Ref. No.	207090
	door catch L 24mm H 21mm thread M8 thread L 20mm		
		Part No.	694066
		Ref. No.	—
	door catch with spigot 2-stage L 28mm W 14mm H 15mm H1 16mm total length 51mm thread M8 thread L 23mm stainless steel		
		Part No.	694067
		Ref. No.	—
	door catch with spigot 1-stage L 26mm total length 51mm thread M8		





 <p>1</p>			
Part No.	692726	Ref. No.	10012036
description	catch for combi-steamer mounting thread M4/M8 clamp length 48mm BL 45mm ø 42mm		
For models:	CGE11-L, CGE11-R, CGE12-L, CGE12-R, CGE61-L, CGE61-R, CGE62-L, CGE62-R, CGG11-L, CGG11-R, CGG12-L, CGG12-R, CGG61-L, CGG61-R, CGG62-L, CGG62-R, CSE11-L, CSE11-R, CSE11-R-DG, CSE12-L, CSE12-R, CSE12-R-DG, CSE61-L, CSE61-R, CSE61-R-DG, CSE62-L, CSE62-R, CSE62-R-DG, CSG11-L, CSG11-R, CSG11-R-DG, CSG12-L, CSG12-R, CSG12-R-DG, CSG61-L, CSG61-R, CSG61-R-DG, CSG62-L, CSG62-R, CSG62-R-DG		

 <p>2</p>			
Part No.	694660	Ref. No.	207094
description	catch L 103mm clamp length 60mm		
For models:	CGE21-L, CGE21-R, CGE22-L, CGE22-R, CGG21-L, CGG21-R, CGG22-L, CGG22-R, CSE21-L, CSE21-R, CSE22-L, CSE22-R, CSG21-L, CSG21-R, CSG22-L, CSG22-R		

 <p>1</p>			
Part No.	699292	Ref. No.	203737
description	counterpart for door handle L 136mm W 34mm H 42mm hole ø 18mm		
For models:	CCE60, CCE63, CPE60, CPE63		

 <p>1</p>			
Part No.	694662	Ref. No.	203667
description	cover for door latch plastic grey L 185mm W 48mm mounting distance 186mm D 37mm		
For models:	CGE11-L, CGE11-R, CGE12-L, CGE12-R, CGE21-L, CGE21-R, CGE22-L, CGE22-R, CGE61-L, CGE61-R, CGE62-L, CGE62-R, CGG11-L, CGG11-R, CGG12-L, CGG12-R, CGG21-L, CGG21-R, CGG22-L, CGG22-R, CGG61-L, CGG61-R, CGG62-L, CGG62-R, CSE11-L, CSE11-R, CSE12-L, CSE12-R, CSE21-L, CSE21-R, CSE22-L, CSE22-R, CSE61-L, CSE61-R, CSE62-L, CSE62-R, CSG11-L, CSG11-R, CSG12-L, CSG12-R, CSG21-L, CSG21-R, CSG22-L, CSG22-R, CSG61-L, CSG61-R, CSG62-L, CSG62-R		

 <p>1</p>			
Part No.	696809	Ref. No.	207101
description	door catch for combi-steamer L 42mm W 30mm H 36mm mounting thread M5		
For models:	CCE60, CCE63, CPE60, CPE63		

 <p>1</p>			
Part No.	692767	Ref. No.	207144
description	door catch for combi-steamer with roller L 44mm W 11.5mm H 11.5mm M6 thread L 18mm B1 6mm rollerø 7.8mm		
For models:	CPE63		

 <p>1</p>			
Part No.	691780	Ref. No.	207090
description	door catch L 24mm H 21mm thread M8 thread L 20mm		
For models:	CGE11-L, CGE11-R, CGE12-L, CGE12-R, CGE21-L, CGE21-R, CGE22-L, CGE22-R, CGE61-L, CGE61-R, CGE62-L, CGE62-R, CGG11-L, CGG11-R, CGG12-L, CGG12-R, CGG21-L, CGG21-R, CGG22-L, CGG22-R, CGG61-L, CGG61-R, CGG62-L, CGG62-R, CSE11-L, CSE11-R, CSE11-R-DG, CSE12-L, CSE12-R, CSE12-R-DG, CSE21-L, CSE21-R, CSE22-L, CSE22-R, CSE61-L, CSE61-R, CSE61-R-DG, CSE62-L, CSE62-R, CSE62-R-DG, CSG11-L, CSG11-R, CSG11-R-DG, CSG12-L, CSG12-R, CSG12-R-DG, CSG21-L, CSG21-R, CSG22-L, CSG22-R...(Other models you can see in the webshop)		

 <p>1</p>			
Part No.	705011	Ref. No.	207103
description	door catch L 57mm W 13mm mounting thread 6mm BL 6mm		
For models:	CCE60, CCE63, CPE60, CPE63		

 <p>1</p>			
Part No.	696815	Ref. No.	207102
description	door handle for combi-steamer L 142mm W 36mm H 55mm grey plastic		
For models:	CCE60, CCE63, CPE60, CPE63		

 <p>1</p>			
Part No.	692766	Ref. No.	207143
description	door handle for combi-steamer L 143mm W 37mm H 59mm grey plastic		
For models:	CPE63		





			
1			
Part No.	691617	Ref. No.	207089
description	door handle grey plastic		
For models:	CGE11-L, CGE11-R, CGE12-L, CGE12-R, CGE21-L, CGE21-R, CGE22-L, CGE22-R, CGE61-L, CGE61-R, CGE62-L, CGE62-R, CGG11-L, CGG11-R, CGG12-L, CGG12-R, CGG21-L, CGG21-R, CGG22-L, CGG22-R, CGG61-L, CGG61-R, CGG62-L, CGG62-R, CSE11-L, CSE11-R, CSE11-R-DG, CSE12-L, CSE12-R, CSE12-R-DG, CSE21-L, CSE21-R, CSE22-L, CSE22-R, CSE61-L, CSE61-R, CSE61-R-DG, CSE62-L, CSE62-R, CSE62-R-DG, CSG11-L, CSG11-R, CSG11-R-DG, CSG12-L, CSG12-R, CSG12-R-DG, CSG21-L, CSG21-R, CSG22-L, CSG22-R...(Other models you can see in the webshop)		
accessories for	691617		
	Part No.	691666	Ref. No. 207092
	catch clamp length 46mm BL 31mm for off-set 59-69mm		
	Part No.	691777	Ref. No. 202662
	cover cap plastic grey L 94mm W 40mm mounting distance 75mm D 36mm		
	Part No.	691780	Ref. No. 207090
	door catch L 24mm H 21mm thread M8 thread L 20mm		
	Part No.	691782	Ref. No. 801064
	cover plate round ø 40mm thickness 1mm		
	Part No.	691783	Ref. No. 801059
	cover plate rectangular L 35mm W 14mm thickness 1mm		

			
1			
Part No.	691785	Ref. No.	207147
description	catch L 97mm clamp length 54mm BL 39mm ø 51.5mm		
For models:	CGE21-L, CGE21-R, CGE22-L, CGE22-R, CGG21-L, CGG21-R, CGG22-L, CGG22-R, CSE21-L, CSE21-R, CSE21-R-DG, CSE22-L, CSE22-R, CSE22-R-DG, CSG21-L, CSG21-R, CSG21-R-DG, CSG22-L, CSG22-R, CSG22-R-DG		

			
1			
Part No.	691786	Ref. No.	207148
description	door catch L 38mm H 19mm thread M8 thread L 21mm		
For models:	CGE21-L, CGE21-R, CGE22-L, CGE22-R, CGG21-L, CGG21-R, CGG22-L, CGG22-R, CSE21-L, CSE21-R, CSE21-R-DG, CSE22-L, CSE22-R, CSE22-R-DG, CSG21-L, CSG21-R, CSG21-R-DG, CSG22-L, CSG22-R, CSG22-R-DG		

			
1			
Part No.	691784	Ref. No.	207149
description	door handle L 200mm W 32mm H 70mm grey plastic		
For models:	CGE21-L, CGE21-R, CGE22-L, CGE22-R, CGG21-L, CGG21-R, CGG22-L, CGG22-R, CSE21-L, CSE21-R, CSE21-R-DG, CSE22-L, CSE22-R, CSE22-R-DG, CSG21-L, CSG21-R, CSG21-R-DG, CSG22-L, CSG22-R, CSG22-R-DG		
accessories for	691784		
	Part No.	691777	Ref. No. 202662
	cover cap plastic grey L 94mm W 40mm mounting distance 75mm D 36mm		
	Part No.	691781	Ref. No. 802694
	cover plate round ø 38mm thickness 1mm		
	Part No.	691785	Ref. No. 207147
	catch L 97mm clamp length 54mm BL 39mm ø 51.5mm		
	Part No.	691786	Ref. No. 207148
	door catch L 38mm H 19mm thread M8 thread L 21mm		

			
1			
Part No.	691777	Ref. No.	202662
description	cover cap plastic grey L 94mm W 40mm mounting distance 75mm D 36mm		
For models:	CGE11-L, CGE11-R, CGE12-L, CGE12-R, CGE21-L, CGE21-R, CGE22-L, CGE22-R, CGE61-L, CGE61-R, CGE62-L, CGE62-R, CGG11-L, CGG11-R, CGG12-L, CGG12-R, CGG21-L, CGG21-R, CGG22-L, CGG22-R, CGG61-L, CGG61-R, CGG62-L, CGG62-R, CSE11-L, CSE11-R, CSE11-R-DG, CSE12-L, CSE12-R, CSE12-R-DG, CSE21-L, CSE21-R, CSE21-R-DG, CSE22-L, CSE22-R, CSE22-R-DG, CSE61-L, CSE61-R, CSE61-R-DG, CSE62-L, CSE62-R, CSE62-R-DG, CSG11-L, CSG11-R, CSG11-R-DG, CSG12-L, CSG12-R, CSG12-R-DG, CSG21-L, CSG21-R...(Other models you can see in the webshop)		

			
1			
Part No.	691783	Ref. No.	801059
description	cover plate rectangular L 35mm W 14mm thickness 1mm		
For models:	CGE11-L, CGE11-R, CGE12-L, CGE12-R, CGE61-L, CGE61-R, CGE62-L, CGE62-R, CGG11-L, CGG11-R, CGG12-L, CGG12-R, CGG61-L, CGG61-R, CGG62-L, CGG62-R, CSE11-L, CSE11-R, CSE11-R-DG, CSE12-L, CSE12-R, CSE12-R-DG, CSE61-L, CSE61-R, CSE61-R-DG, CSE62-L, CSE62-R, CSE62-R-DG, CSG11-L, CSG11-R, CSG11-R-DG, CSG12-L, CSG12-R, CSG12-R-DG, CSG61-L, CSG61-R, CSG61-R-DG, CSG62-L, CSG62-R, CSG62-R-DG		



			
1			
Part No.	691781	Ref. No.	802694
description	cover plate round ø 38mm thickness 1mm		
For models:	CGE21-L, CGE21-R, CGE22-L, CGE22-R, CGG21-L, CGG21-R, CGG22-L, CGG22-R, CSE21-L, CSE21-R, CSE21-R-DG, CSE22-L, CSE22-R, CSE22-R-DG, CSG21-L, CSG21-R, CSG21-R-DG, CSG22-L, CSG22-R, CSG22-R-DG		

			
1			
Part No.	691782	Ref. No.	801064
description	cover plate round ø 40mm thickness 1mm		
For models:	CGE11-L, CGE11-R, CGE12-L, CGE12-R, CGE21-L, CGE21-R, CGE22-L, CGE22-R, CGE61-L, CGE61-R, CGE62-L, CGE62-R, CGG11-L, CGG11-R, CGG12-L, CGG12-R, CGG21-L, CGG21-R, CGG22-L, CGG22-R, CGG61-L, CGG61-R, CGG62-L, CGG62-R, CSE11-L, CSE11-R, CSE11-R-DG, CSE12-L, CSE12-R, CSE12-R-DG, CSE21-L, CSE21-R, CSE22-L, CSE22-R, CSE61-L, CSE61-R, CSE61-R-DG, CSE62-L, CSE62-R, CSE62-R-DG, CSG11-L, CSG11-R, CSG11-R-DG, CSG12-L, CSG12-R, CSG12-R-DG, CSG21-L, CSG21-R, CSG22-L, CSG22-R...(Other models you can see in the webshop)		

			
1			
Part No.	520507	Ref. No.	201093
description	outlet tap brass L 210mm thread 1/2" IT - 3/4" IT		
For models:	0220301-00, 0220301B00, 0220301B01, 0220301B02, 0220302-00, 0220302A00, 0220302A01, 0220302A02, 0220302A03, 0220302B00, 0220302B01, 0220302B02, 0220302C00, 0220302C01, 0220302C02, 0220302C03, 0220302F00, 0220303-00, 0220303-01, 0220303A00, 0220303A01, 0220303A02, 0220303A03, 0220303B00, 0220303B01, 0220303C00, 0220303C01, 0220303C02, 0220304-00, 0220305-00, 0220306-00		

			
1			
Part No.	520536	Ref. No.	201114
description	outlet tap L 175mm thread 1/2" IT - 3/4" IT shaft L 92mm total length 174mm shaft intake ø 6x6mm shaft ø 8mm		
For models:	1220301-00, 1220301-01, 1220301-02, 1220301-03, 1220301-04, 1220301B00, 1220301B01, 1220301B02, 1220301B03, 1220301B04, 1220301J00, 1220301J01, 1220301J02, 1220301J03, 1220302-00, 1220302-01, 1220302B00, 1220302B01, 1220303-00, 1220303-01, 1220303-02, 1220303-03, 1220303-04, 1220303-05, 1220303A00, 1220303A01, 1220303A02, 1220303A03, 1220303B00, 1220303B01, 1220303B02, 1220303B03, 1220303B04, 1220303B05, 1220303C00, 1220303C01, 1220303C02, 1220303C03, 1220303I00, 1220303I01, 1220303I02, 1220303J01, 1220303J02, 1220303J03, 1220303J04, 1220303K00, 1220303K01, 1220304-00, 1220304-01, 1220304A00... (Other models you can see in the webshop)		



fittings for catering equipment

outlet taps

producer-specific

MKN

			
1			
Part No.	520376	Ref. No.	205252
description	drain pipe thread 1/2" ET connection 1/2"		
For models:	0220501-00, 0220502-00, 0220503-00, 0220802-00, 0221501-00, 0221502-00, 0260501-00		

							
1							
Part No.	520378	Ref. No.	201092				
description	outlet tap brass L 100mm thread 1/2" IT - 3/4" IT						
For models:	0220501-00, 0220502-00, 0220503-00, 0220802-00, 0221501-00, 0221502-00, 0260501-00, 0520303-00, 0520303-01, 0520303-02, 1020510-00, 1022603-00, 1220501-00, 1220501-01, 1220501-02, 1220502-00, 1220502-01, 1220802-00, 1220802-01, 1221501-00, 1221501-01, 1221501-02, 1260501-00, 1320501-00, 1320502-00, 1320802-00, 1321501-00, 1321501-01, 1321501-02, 1321501-03, 1360501-00, 1360501-01, 4228801-00, 4228801-01						
accessories for	520378						
	<table border="1"> <tr> <td>Part No.</td> <td>520376</td> <td>Ref. No.</td> <td>205252</td> </tr> </table>	Part No.	520376	Ref. No.	205252		
Part No.	520376	Ref. No.	205252				
	 drain pipe thread 1/2" ET connection 1/2"						

aerators and air bleeders

			
1			
Part No.	540949	Ref. No.	201091
description	aerator and air bleeder thread 1/2" ET chrome-plated with O-ring L 15mm ø 25mm		
For models:	2012801-01, 2012801A01, 2012801B01, 2012801C01, 2012802-01, 2012802A01, 2012802B01, 2012802C01, 2012803-01, 2012803A01, 2012803B01, 2012803C01, 2012804-01, 2012804A01, 2012804B01, 2012804C01, 2012805-01, 2012805A01, 2012805B01, 2012805C01, 2012827-00, 2012827-01, 2012827-02, 2012828-00, 2012828-01, 2012828-02, 2012828-03, 2012828-04, 2012828-05, 2012829-00, 2012829-01, 2012829-02, 2022801-02, 2022801-03, 2022801A02, 2022801A03, 2022801B02, 2022801B03, 2022801C02, 2022801C03, 2022802-02, 2022802-03, 2022802A02, 2022802A03, 2022802B02, 2022802B03, 2022802C02, 2022802C03, 2022803-02, 2022803-03... (Other models you can see in the webshop)		







			
1			
Part No.	541428	Ref. No.	201084
description	aerator and air bleeder thread 3/4" ET chrome-plated L 25mm ø 33mm		
For models:	14228011-0, 14228022-0, 14228033-0, 14228044-0, 14228055-0, 2022801-00, 2022801-01, 20228011-0, 20228011-1, 2022801A00, 2022801A01, 2022801B00, 2022801B01, 2022801C00, 2022802-00, 2022802-01, 20228022-0, 20228022-1, 2022802A00, 2022802A01, 2022802B00, 2022802B01, 2022802C00, 2022802C01, 2022803-00, 2022803-01, 20228033-0, 20228033-1, 2022803A00, 2022803A01, 2022803B00, 2022803B01, 2022803C00, 2022803C01, 2022804-00, 2022804-01, 20228044-0, 20228044-1, 2022804A00, 2022804A01, 2022804B00, 2022804B01, 2022804C00, 2022804C01, 2022805-00, 2022805-01, 20228055-0, 20228055-1, 2022805A00, 2022805A01... (Other models you can see in the webshop)		

			
2			
Part No.	541430	Ref. No.	201736
description	air valve thread 1/2" ET chrome-plated L 16mm ø 25mm		
For models:	1422802B04, 1422802B05, 1422802B06, 1422802B07, 1422802B08, 1422804B04, 1422804B05, 1422804B06, 1422804B07, 1422804B08, 1422805B04, 1422805B05, 1422805B06, 1422805B07, 1422805B08, 1462802B00, 1462802B01, 1462802B02, 1462802B03, 1462802B04, 1462802B05, 1462804B00, 1462804B01, 1462804B02, 1462804B03, 1462804B04, 1462804B05, 1462835-00, 1462836-00, 1462837-00, 1462838-00, 1462839-00, 1462840-00, 2012802B02, 2012802B03, 2012802B04, 2012802B05, 2012802B06, 2012802B07, 2012804B02, 2012804B03, 2012804B04, 2012804B05, 2012804B06, 2012804B07, 2012805B02, 2012805B03, 2012805B04, 2012805B05, 2012805B06... (Other models you can see in the webshop)		

steam valves

			
1			
Part No.	541544	Ref. No.	201052
description	steam valve angled connection 1" IT - 1" ET total length 82mm H 136mm brass		
For models:	1412831-00, 1412832-00, 1412833-00, 1412834-00, 1412908-00, 1412910-00, 2012801-00, 2012801-01, 2012801A00, 2012801A01, 2012801B00, 2012801B01, 2012801C00, 2012801C01, 2012802-00, 2012802-01, 2012802A00, 2012802A01, 2012802B00, 2012802B01, 2012802B02, 2012802B03, 2012802B04, 2012802B05, 2012802B06, 2012802B07, 2012802C00, 2012802C01, 2012803-00, 2012803-01, 2012803A00, 2012803A01, 2012803B00, 2012803B01, 2012803C00, 2012803C01, 2012804-00, 2012804-01, 2012804A00, 2012804A01, 2012804B00, 2012804B01, 2012804B02, 2012804B03, 2012804B04, 2012804B05, 2012804B06, 2012804B07, 2012804C00, 2012804C01... (Other models you can see in the webshop)		
spare parts for	541544		
	Part No.	540229	Ref. No. —
	star handle shaft 9x9mm ø 80mm L 23mm black thermoplastic		



spare parts for	541544		
	Part No.	541546	Ref. No. —
	screw chrome-plated brass thread M5 thread L 10mm		
	Part No.	541548	Ref. No. —
	gasket PTFE ID ø 15mm H 7mm for thread 1 1/4" ED ø 35mm		
	Part No.	541554	Ref. No. —
	gasket copper ext. ø 49 ID ø 42mm H 2mm for thread 1 1/4"		
	Part No.	541557	Ref. No. —
	tap head chrome-plated thread 1 1/4" for steam tap 1"		

lid hinges

type ECHTERMANN

10 series

10.71

			
1			
Part No.	693502	Ref. No.	207175
description	lid hinge type 6910.71 level of centre of rotation 32mm load capacity 10-20NM opening angle 80° closing angle 10° mounting distance 198mm bore ø 11mm MT lid M8mm chrome-plated brass L 270mm		
For models:	14228011-0, 2012801-00, 2012801-01, 2012801A00, 2012801A01, 2022801-00, 2022801-01, 2022801-02, 2022801-03, 20228011-0, 20228011-1, 2022801A00, 2022801A01, 2022801A02, 2022801A03, 2062801-00, 2062801-01, 2062801-02, 2062801-03, 2062801-04, 2062801-05, 2062801-06, 2062801A00, 2062801A01, 2062801A02, 2062801A03, 2062801A04, 2062801A05, 2062801A06, 20628022-0, 20628022-1, 20628022-2, 2112801-00, 2112801-01, 2112801A00, 2112801A01, 2122801-00, 2122801-01, 2122801-02, 2122801-03, 2122801A00, 2122801A01, 2122801A02, 2122801A03, 2122802A00, 3012801-00, 3012801-01, 3012801A00, 3012801A01, 3022801-00... (Other models you can see in the webshop)		
spare parts for	693502		
	Part No.	691611	Ref. No. —
	repair kit for lid hinge load capacity 10-20NM		



10.72			
1			
Part No.	693503	Ref. No.	207170
description	lid hinge type 6910.72 level of centre of rotation 35mm load capacity 10-20NM opening angle 80° closing angle 10° mounting distance 198mm bore ø 11mm MT lid M8mm chrome-plated brass L 270mm		
For models:	14228022-0, 14228033-0, 2012802-00, 2012802-01, 2012802A00, 2012802A01, 2012803-00, 2012803-01, 2012803A00, 2012803A01, 2022802-00, 2022802-01, 2022802-02, 2022802-03, 20228022-0, 20228022-1, 2022802A00, 2022802A01, 2022802A02, 2022802A03, 2022803-00, 2022803-01, 2022803-02, 2022803-03, 20228033-0, 20228033-1, 2022803A00, 2022803A01, 2022803A02, 2022803A03, 2062802-00, 2062802-01, 2062802-02, 2062802-03, 2062802-04, 2062802-05, 2062802-06, 2062802A00, 2062802A01, 2062802A02, 2062802A03, 2062802A04, 2062802A05, 2062802A06, 2062803-00, 2062803-01, 2062803-02, 2062803-03, 2062803-04, 2062803-05... (Other models you can see in the webshop)		

10.73				
1				
Part No.	693504	Ref. No.	207171	
description	lid hinge type 6910.73 level of centre of rotation 35mm load capacity 20-30NM opening angle 80° closing angle 10° mounting distance 198mm bore ø 11mm MT lid M8mm chrome-plated brass L 270mm			
For models:	14228044-0, 14228055-0, 2012804-00, 2012804-01, 2012804A00, 2012804A01, 2022804-00, 2022804-01, 2022804-02, 2022804-03, 20228044-0, 20228044-1, 2022804A00, 2022804A01, 2022804A02, 2022804A03, 2022805-00, 2022805-01, 20228055-0, 20228055-1, 2022805A00, 2022805A01, 2062804-00, 2062804-01, 2062804-02, 2062804-03, 2062804-04, 2062804-05, 2062804-06, 20628044-0, 20628044-1, 20628044-2, 2062804A00, 2062804A01, 2062804A02, 2062804A03, 2062804A04, 2062804A05, 2062804A06, 3012804-00, 3012804-01, 3012804A00, 3012804A01, 3012805-00, 3012805-01, 3012805A00, 3012805A01, 3022804-00, 3022804-01, 3022804-02... (Other models you can see in the webshop)			
spare parts for	693504			
	Part No.	691612	Ref. No.	—
	repair kit for lid hinge load capacity 20-30NM			

12 series			
12.84			
1			
Part No.	693505	Ref. No.	207160
description	lid hinge type 1284 level of centre of rotation 35mm load capacity 10-20NM opening angle 80° closing angle 10° mounting distance 198mm bore ø 11mm MD lid 90mm 26.5 MT lid M8mm chrome-plated brass		
For models:	14228011-0, 14228022-0, 1422802B04, 1422802B05, 1422802B06, 1462802B00, 1462802B01, 1462802B02, 1462802B03, 1462802B04, 1462802B05, 2012801B00, 2012801B01, 2012801C00, 2012801C01, 2012802B00, 2012802B01, 2012802B02, 2012802B03, 2012802B04, 2012802C00, 2012802C01, 2021407-00, 2021407-01, 2021407-02, 2021407-03, 2021407A02, 2021407A03, 2021408-00, 2021408-01, 2021408-02, 2021408A02, 2021417-00, 2021436-00, 2021436-01, 2021436-02, 2021436-03, 2021436A01, 2021436A02, 2021436A03, 2021437-01, 2021437-02, 2021437A00, 2021437A01, 2022801B00, 2022801B01, 2022801B02, 2022801B03, 2022801C00, 2022801C01... (Other models you can see in the webshop)		

1				
Part No.	693506	Ref. No.	207180	
description	lid hinge type 1284 level of centre of rotation 35mm load capacity 20-30NM opening angle 80° closing angle 10° mounting distance 198mm bore ø 11mm MD lid 90mm 26.5 MT lid M8mm chrome-plated brass			
For models:	1422705-00, 1422705-01, 1422705-02, 1422706-00, 1422706-01, 1422706-02, 1422707-00, 1422707-01, 1422707-02, 1422708-00, 1422708-01, 1422708-02, 1422804B04, 1422804B05, 1422804B06, 1422805B05, 1422805B06, 1462804B00, 1462804B01, 1462804B02, 1462804B03, 1462804B04, 1462804B05, 2012803B00, 2012803B01, 2012803C00, 2012803C01, 2012804B02, 2012804B03, 2012804B04, 2012805B02, 2012805B03, 2012805B04, 2012806B00, 2012806C00, 2013003B01, 2013003B02, 2013003B03, 2013003B04, 2013003B05, 2013003B06, 2013004B01, 2013004B02, 2013004B03, 2013004B04, 2013004B05, 2021401-09, 2021401A09, 2021402-08, 2021402A08... (Other models you can see in the webshop)			
spare parts for	693506			
	Part No.	691612	Ref. No.	—
	repair kit for lid hinge load capacity 20-30NM			

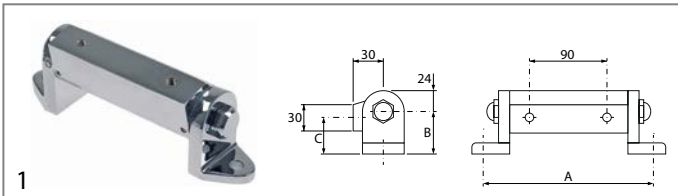
Part No.	693507	Ref. No.	207174
description	lid hinge type 1284 level of centre of rotation 35mm load capacity 30-50NM opening angle 80° closing angle 10° mounting distance 198mm bore ø 11mm MD lid 90mm 26.5 MT lid M8mm chrome-plated brass		
For models:	1422701-00, 1422701-01, 1422701-02, 1422701-03, 1422702-00, 1422702-01, 1422702-02, 1422702-03, 1422703-00, 1422703-01, 1422703-02, 1422704-00, 1422704-01, 1422704-02, 14228033-0, 14228044-0, 14228055-0, 1422805B04, 1422807B00, 1422807B01, 1422807B02, 1422807B03, 1422807B04, 1422902-00, 1422902-01, 1422902-02, 1422902-03, 1422902-04, 2012804B00, 2012804B01, 2012804C00, 2012804C01, 2012805-00, 2012805-01, 2012805A00, 2012805A01, 2012805B00, 2012805B01, 2012805C00, 2012805C01, 2012807B00, 2012807B01, 2012807B02, 2012807B03, 2012807B04, 2012807C00, 2012815-00, 2012815-01, 2012901B00, 2012901C00... (Other models you can see in the webshop)		

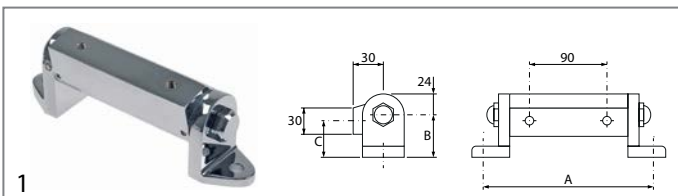

Part No.	693508	Ref. No.	207015
description	lid hinge type 1284 level of centre of rotation 35mm load capacity 50-60NM opening angle 80° closing angle 10° mounting distance 198mm bore ø 11mm MD lid 90mm 26.5 MT lid M8mm chrome-plated brass		
For models:	2012903-01, 2012903-02, 2012903-03, 2012903-04, 2012909-00, 2012909-01, 2012909-02, 2021401B00, 2021401B01, 2021401B02, 2021401B03, 2021401B04, 2021401B06, 2021401B07, 2021401B08, 2021401B09, 2021401C00, 2021401C01, 2021401C02, 2021401C03, 2021401C04, 2021401C06, 2021401C07, 2021401C08, 2021401C09, 2021402B00, 2021402B01, 2021402B02, 2021402B03, 2021402B04, 2021402B06, 2021402B07, 2021402B08, 2021402C00, 2021402C01, 2021402C02, 2021402C03, 2021402C04, 2021402C06, 2021402C07, 2021402C08, 2021403B04, 2021403B05, 2021403B06, 2021403C04, 2021403C05, 2021403C06, 2021404B04, 2021404B05, 2021404B06... (Other models you can see in the webshop)		
spare parts for	693508		
	Part No.	691614	Ref. No. —
repair kit for lid hinge load capacity 50-60NM			

drain taps

accessories

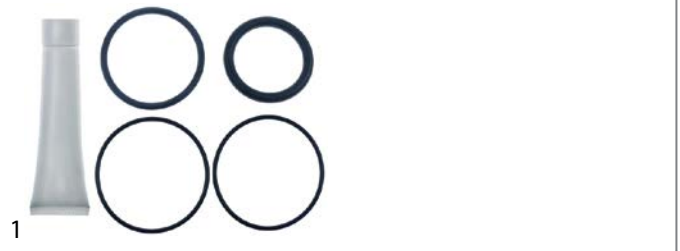

Part No.	541531	Ref. No.	211125
description	repair kit for drain tap 1 1/2" 4x O-ring + fitting grease		
For models:	1422802B06, 1422802B07, 1422802B08, 1422804B06, 1422804B07, 1422804B08, 1422805B06, 1422805B07, 1422805B08, 1422807B03, 1422807B04, 1422902-03, 1422902-04, 1462802B03, 1462804B03, 2012802B05, 2012802B06, 2012802B07, 2012804B05, 2012804B06, 2012804B07, 2012805B05, 2012805B06, 2012805B07, 2012807B03, 2012807B04, 2012812-00, 2012812-01, 2012812-02, 2012813-00, 2012813-01, 2012813-02, 2012813-03, 2012814-00, 2012814-01, 2012814-02, 2012814-03, 2012815-00, 2012902-02, 2012902-03, 2012903-01, 2012903-02, 2012903-03, 2012907-00, 2012907-01, 2012907-02, 2012909-01, 2013003B04, 2013003B05, 2013003B06... (Other models you can see in the webshop)		

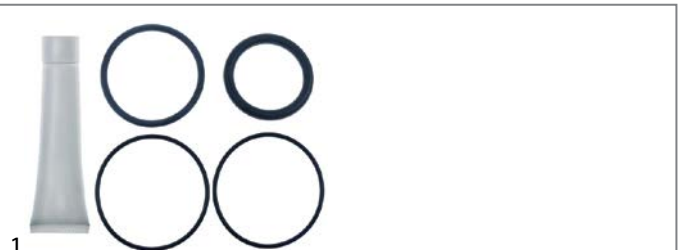

Part No.	541532	Ref. No.	211126
description	repair kit for drain tap 2" 4x O-ring + fitting grease		
For models:	1422701-02, 1422701-03, 1422702-02, 1422702-03, 1422703-01, 1422703-02, 1422704-01, 1422704-02, 1422705-01, 1422705-02, 1422706-01, 1422706-02, 1422707-01, 1422707-02, 1422708-01, 1422708-02, 1423901-00, 1423901-01, 1423901-02, 1423902-00, 1423902-01, 1423902-02, 1423903-00, 1423903-01, 1423903-02, 1424101-01, 1424102-01, 1424103-00, 1424104-00, 2012903-04, 2012909-02, 2013901-00, 2013901-01, 2013901-02, 2013901-03, 2013902-00, 2013902-01, 2013902-02, 2013902-03, 2013903-00, 2013903-01, 2013903-02, 2013903-03, 2022701-03, 2022701-04, 2022703-03, 2022703-04, 2022705-03, 2022705-04, 2022707-03... (Other models you can see in the webshop)		



steam traps

steam traps

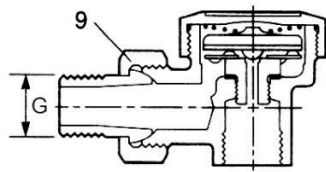

1

Part No.	540243	Ref. No.	201734
description	thermostatic steam trap thread 1/2" type BPT13UA brass		
For models:	1412831-00, 1412832-00, 1412833-00, 1412833-01, 1412834-00, 1412834-01, 1412908-00, 1412910-00, 1412910-01, 1422802B04, 1422802B05, 1422802B06, 1422802B07, 1422802B08, 1422804B04, 1422804B05, 1422804B06, 1422804B07, 1422804B08, 1422805B04, 1422805B05, 1422805B06, 1422805B07, 1422805B08, 1422807B00, 1422807B01, 1422807B02, 1422807B03, 1422807B04, 1422831-00, 1422832-00, 1422833-00, 1422834-00, 1422902-00, 1422902-01, 1422902-02, 1422902-03, 1422902-04, 1422908-00, 1422910-00, 1423901-00, 1423901-01, 1423901-02, 1423902-00, 1423902-01, 1423902-02, 1423903-00, 1423903-01, 1423903-02, 1462802B00... (Other models you can see in the webshop)		

test taps

test taps

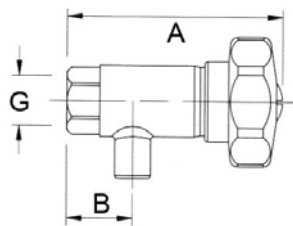

1

Part No.	514277	Ref. No.	201051
description	test tap thread 3/8" IT W 70mm W1 25mm		
For models:	14228011-0, 14228022-0, 14228033-0, 14228044-0, 14228055-0, 2022801-00, 2022801-01, 20228011-0, 20228011-1, 2022801A00, 2022801A01, 2022801B00, 2022801B01, 2022801C00, 2022801C01, 2022802-00, 2022802-01, 20228022-0, 20228022-1, 2022802A00, 2022802A01, 2022802B00, 2022802B01, 2022802C00, 2022802C01, 2022803-00, 2022803-01, 20228033-0, 20228033-1, 2022803A00, 2022803A01, 2022803B00, 2022803B01, 2022803C00, 2022803C01, 2022804-00, 2022804-01, 20228044-0, 20228044-1, 2022804A00, 2022804A01, 2022804B00, 2022804B01, 2022804C00, 2022804C01, 2022805-00, 2022805-01, 20228055-0, 20228055-1, 2022805A00... (Other models you can see in the webshop)		

safety fittings

safety fittings



1

Part No.	514328	Ref. No.	201050	
description	safety fitting thread 1" 0.4bar 130kg/h thread size manometer 1/4"-1/2" chrome-plated H 200mm W 180mm			
spare parts for	514328			
	Part No.	540320	Ref. No.	—
	ball handle thread M5 ø 20mm with metal bush			
	Part No.	540322	Ref. No.	—
	ball handle thread M8 ø 32mm with metal bush			
	Part No.	540926	Ref. No.	—
	filling funnel thread 3/8" for safety fitting			
	Part No.	540949	Ref. No.	201091
	aerator and air bleeder thread 1/2" ET chrome-plated with O-ring L 15mm ø 25mm			
accessories for	514328			
	Part No.	541062	Ref. No.	201105
	manometer ø 63mm pressure range 0 up to 1bar connection marking adjustable kettle thread 1/4"			

safety valves



1

Part No.	541436	Ref. No.	201044
description	safety valve thread 3/4"		
For models:	14228011-0, 14228022-0, 14228033-0, 14228044-0, 14228055-0, 2012801-00, 2012801-01, 2012801A00, 2012801A01, 2012801B00, 2012801B01, 2012801C00, 2012801C01, 2012802-00, 2012802-01, 2012802A00, 2012802A01, 2012802B00, 2012802B01, 2012802C00, 2012802C01, 2012803-00, 2012803-01, 2012803A00, 2012803A01, 2012803B00, 2012803B01, 2012803C00, 2012803C01, 2012804-00, 2012804-01, 2012804A00, 2012804A01, 2012804B00, 2012804B01, 2012804C00, 2012804C01, 2012805-00, 2012805-01, 2012805A00, 2012805A01, 2012805B00, 2012805B01, 2012805C00, 2012805C01, 2012806B00, 2012806C00, 2012807B00, 2012807C00, 2012901B00... (Other models you can see in the webshop)		

mechanical components, equipment accessories

1

Part No.	518668	Ref. No.	211124
description	gasket set EPDM ID ø 24/38/52/63mm for safety valve		
For models:	1423901-00, 1423901-01, 1423901-02, 1423902-00, 1423902-01, 1423902-02, 1423903-00, 1423903-01, 1423903-02, 1424101-01, 1424102-01, 1424103-00, 1424104-00, 2013901-00, 2013901-01, 2013901-02, 2013901-03, 2013902-00, 2013902-01, 2013902-02, 2013902-03, 2013903-00, 2013903-01, 2013903-02, 2013903-03, 2023901-00, 2023901-01, 2023901-02, 2023901-03, 2023902-00, 2023902-01, 2023902-02, 2023903-00, 2023903-01, 2023903-02, 2024101-01, 2024102-01, 2024103-01, 2024104-01, 2024201-04, 2024202-01, 2024203-04, 2024204-01, 2024205-01, 2024206-00, 2024207-01, 2024208-00, 3023901-03, 3023902-00, 3023902-01... (Other models you can see in the webshop)		

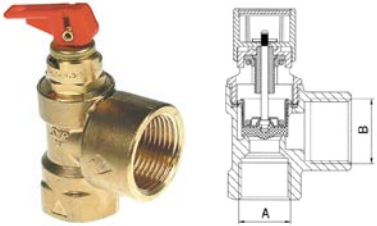

1

Part No.	541431	Ref. No.	201730
description	safety valve T1: 3/4" T2: 1" triggering pressure 1bar		
For models:	1412831-00, 1412832-00, 1412833-00, 1412833-01, 1412834-00, 1412834-01, 1412908-00, 1412910-00, 1412910-01, 1422802B04, 1422802B05, 1422802B06, 1422802B07, 1422802B08, 1422804B04, 1422804B05, 1422804B06, 1422804B07, 1422804B08, 1422805B04, 1422805B05, 1422805B06, 1422805B07, 1422805B08, 1422807B00, 1422807B01, 1422807B02, 1422807B03, 1422807B04, 1422831-00, 1422832-00, 1422833-00, 1422834-00, 1422902-00, 1422902-01, 1422902-02, 1422902-03, 1422902-04, 1422908-00, 1422910-00, 1462802B00, 1462802B01, 1462802B02, 1462802B03, 1462802B04, 1462802B05, 1462804B00, 1462804B01, 1462804B02, 1462804B03... (Other models you can see in the webshop)		

equipment feet and end caps

equipment feet

with screw mounting

universal



1

Part No.	701646	Ref. No.	204561
description	equipment foot tube ø 64mm thread M10x1.5 thread L 17mm H 100-135mm SS Qty 1 pcs		
For models:	CGE11-L, CGE11-R, CGE12-L, CGE12-R, CGE61-L, CGE61-R, CGE62-L, CGE62-R, CGG11-L, CGG11-R, CGG12-L, CGG12-R, CGG61-L, CGG61-R, CGG62-L, CGG62-R, CSE11-L, CSE11-R, CSE11-R-DG, CSE12-L, CSE12-R, CSE12-R-DG, CSE61-L, CSE61-R, CSE61-R-DG, CSE62-L, CSE62-R, CSE62-R-DG, CSG11-L, CSG11-R, CSG11-R-DG, CSG12-L, CSG12-R, CSG12-R-DG, CSG61-L, CSG61-R, CSG61-R-DG, CSG62-L, CSG62-R, CSG62-R-DG		

baskets

fryer baskets

MKN



1

Part No.	970735	Ref. No.	206008
description	fryer basket W1 135mm L1 176mm H1 114mm L2 375mm H3 180mm chrome-plated steel		
For models:	0520302-00, 0520302-01, 0520302-02, 0520302A00, 0520302A01		



1

Part No.	970152	Ref. No.	206129
description	fryer basket W1 160mm L1 310mm H1 115mm chrome-plated steel		
For models:	0220301-00, 0220301B00, 0220301B01, 0220301B02, 0220301D00, 0220302-00, 0220302A00, 0220302A01, 0220302A02, 0220302A03, 0220302B00, 0220302B01, 0220302B02, 0220302C00, 0220302C01, 0220302C02, 0220302C03, 0220302D00, 0220302E00, 0220302E01, 0220302F00, 0220302H00, 0220302H01, 0220303-00, 0220303-01, 0220303A00, 0220303A01, 0220303A02, 0220303A03, 0220303B00, 0220303B01, 0220303C00, 0220303C01, 0220303C02, 0220303D00, 0220303D01, 0220303E00, 0220303E01, 0220303H00, 0220303H01, 0220304-00, 0220305-00, 0220306-00, 0260301-00, 0260301-01, 0260302-00, 0260302-01, 0720325-03, 0720325-04, 0720325B03... (Other models you can see in the webshop)		



1

Part No.	970293	Ref. No.	206000
description	fryer basket W1 205mm L1 240mm H1 110mm		
For models:	1820301-00, 1820301-01, 1820301-02		



1

Part No.	970464	Ref. No.	206130
description	fryer basket W1 343mm L1 368mm H1 114mm L2 392mm H2 133mm H3 243mm chrome-plated steel gas fryer		
For models:	0260302-00, 0260302-01, 1260302-00, 1260302-01, 1460302-00, 1460302-01, 1460302-02, 2060301-00, 2060301-01, 2060301-02		

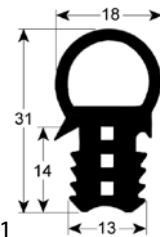

			
Part No.	970414	Ref. No.	206020
description	fryer basket W1 380mm L1 345mm H1 100mm H2 130mm H3 230mm chrome-plated steel electric fryer		
For models:	0220303-00, 0220303-01, 0220303A00, 0220303A01, 0220303A02, 0220303A03, 0220303B00, 0220303B01, 0220303C00, 0220303C01, 0220303C02, 0220303D00, 0220303D01, 0220303E00, 0220303E01, 0220303H00, 0220303H01, 0220306-00, 1220305-00, 1220305-01, 1220305-02, 1220305-03, 1220305-04, 1220305-05, 1220305-06, 1220305-07, 1220305A00, 1220305A01, 1220305A02, 1220305A03, 1220305A04, 1220305A05, 1220305B00, 1220305B01, 1220305B02, 1220305B03, 1220305B04, 1220305B05, 1220305B06, 1220305B07, 1220305C00, 1220305C01, 1220305C02, 1220305C03, 1220305C04, 1220305C05, 1220305D00, 1220305D01, 1220305D02, 1220305D03... (Other models you can see in the webshop)		

			
Part No.	902213	Ref. No.	10012490
description	door seal profile 2064 W 600mm L 740mm outer plug size		
For models:	CGE11-L, CGE11-R, CGE12-L, CGE12-R, CGG11-L, CGG11-R, CGG12-L, CGG12-R, CSE11-L, CSE11-R, CSE11-R-DG, CSE12-L, CSE12-R, CSE12-R-DG, CSG11-L, CSG11-R, CSG11-R-DG, CSG12-L, CSG12-R, CSG12-R-DG		

gaskets

gaskets for heated units

door seals

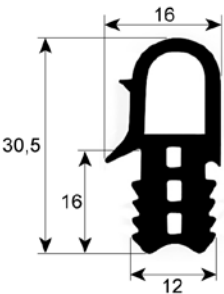
			
Part No.	901456	Ref. No.	211112
description	door seal profile 2063 perimeter 1540mm Qty 1		
For models:	CCE60, CCE63, CPE60, CPE63		

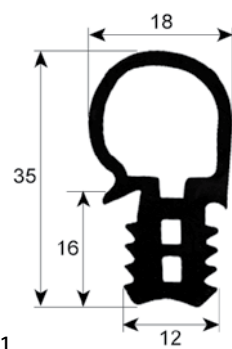
			
Part No.	900793	Ref. No.	211096
description	door seal profile 2065 W 605mm L 1480mm external size Qty 1		
For models:	CGE21-L, CGE21-R, CGE22-L, CGE22-R, CGG21-L, CGG21-R, CGG22-L, CGG22-R, CSE21-L, CSE21-R, CSE21-R-DG, CSE22-L, CSE22-R, CSE22-R-DG, CSG21-L, CSG21-R, CSG21-R-DG, CSG22-L, CSG22-R, CSG22-R-DG		

			
Part No.	902501	Ref. No.	10012489
description	door seal profile 2064 W 472mm L 600mm outer plug size suitable for MKN		
For models:	CGE61-L, CGE61-R, CGE62-L, CGE62-R, CGG61-L, CGG61-R, CGG62-L, CGG62-R, CSE61-L, CSE61-R, CSE61-R-DG, CSE62-L, CSE62-R, CSE62-R-DG, CSG61-L, CSG61-R, CSG61-R-DG, CSG62-L, CSG62-R, CSG62-R-DG		

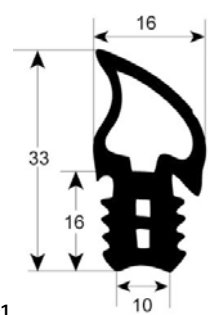
			
Part No.	900783	Ref. No.	211094
description	door seal profile 2743 W 480mm L 610mm external size Qty 1		
For models:	CGE61-L, CGE61-R, CGE62-L, CGE62-R, CGG61-L, CGG61-R, CGG62-L, CGG62-R, CSE61-L, CSE61-R, CSE61-R-DG, CSE62-L, CSE62-R, CSE62-R-DG, CSG61-L, CSG61-R, CSG61-R-DG, CSG62-L, CSG62-R, CSG62-R-DG		

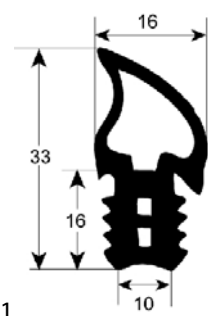

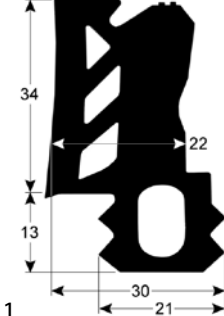

Part No.	900784	Ref. No.	211095
description	door seal profile 2743 W 610mm L 750mm external size Qty 1		
For models:	CGE11-L, CGE11-R, CGE12-L, CGE12-R, CGG11-L, CGG11-R, CGG12-L, CGG12-R, CSE11-L, CSE11-R, CSE11-R-DG, CSE12-L, CSE12-R, CSE12-R-DG, CSG11-L, CSG11-R, CSG11-R-DG, CSG12-L, CSG12-R, CSG12-R-DG		



Part No.	902499	Ref. No.	211171
description	tray rack trolley gasket profile 4120 L 630mm Qty 1		
For models:	CGE21-L, CGE21-R, CGE22-L, CGE22-R, CGG21-L, CGG21-R, CGG22-L, CGG22-R, CSE21-L, CSE21-R, CSE22-L, CSE22-R, CSG21-L, CSG21-R, CSG22-L, CSG22-R		

door seals with fixing hook



Part No.	900512	Ref. No.	211063
description	door seal L 525mm W 270mm 3-sided long side open with 5 mounting clips		
For models:	0522101-04, 0522102-04, 0722101-06, 1323208-04, 1323210-03, 1323210-04, 1323403-00, 1323403K00, 1323506-00, 1323506-01, 1323506A00, 1323506A01, 1323517-00, 1323517A00, 1363403-03, 1363403-04, 1363403-05, 1363415-05, 1422101-04, 1422101-05, 1422101-06, 1422102-04, 1422102-05, 1422301-01, 2023114-00, 2023118-00, 2023119-00, 2023203-07, 2023205-07, 2023207-03, 2023207-04, 2023207-05, 2023406-00, 2023503-10, 2023503-11, 2023503-12, 2023503-13, 2023503A10, 2023503A11, 2023503A12, 2023503A13, 2063403-08, 2063403-09, 2063403-10, 2063406-08, 2063406-09, 2063406-10, 2063415-05, 2063418-05, 2063502-08... (Other models you can see in the webshop)		

gaskets for tray rack trolleys



Part No.	901157	Ref. No.	211104
description	tray rack trolley gasket profile 4075 L 645mm		
For models:	CGE21-L, CGE21-R, CGE22-L, CGE22-R, CGG21-L, CGG21-R, CGG22-L, CGG22-R, CSE21-L, CSE21-R, CSE22-L, CSE22-R, CSG21-L, CSG21-R, CSG22-L, CSG22-R		

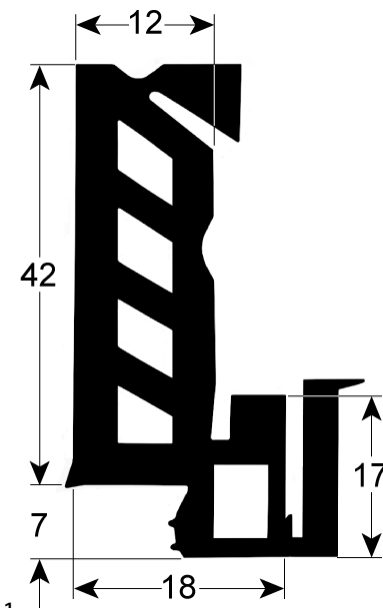

Part No.	902500	Ref. No.	211156
description	tray rack trolley gasket profile 4130 L 654mm Qty 1		
For models:	CSE21-R-DG, CSE22-R-DG, CSG21-R-DG, CSG22-R-DG		

gaskets for control panels



Part No.	902484	Ref. No.	211089
description	gasket for control panel W 220mm L 1420mm suitable for MKN combi-steamer with 10 mounting clips model HD20.x		
For models:	CGE21-L, CGE21-R, CGE22-L, CGE22-R, CGG21-L, CGG21-R, CGG22-L, CGG22-R, CSE21-L, CSE21-R, CSE21-R-DG, CSE22-L, CSE22-R, CSE22-R-DG, CSG21-L, CSG21-R, CSG21-R-DG, CSG22-L, CSG22-R, CSG22-R-DG		

Part No.	902447	Ref. No.	211087
description	gasket for cover L 1580mm suitable for MKN for combi-steamer with 6 mounting clips		
For models:	CGE61-L, CGE61-R, CGE62-L, CGE62-R, CGG61-L, CGG61-R, CGG62-L, CGG62-R, CSE61-L, CSE61-R, CSE61-R-DG, CSE62-L, CSE62-R, CSE62-R-DG, CSG61-L, CSG61-R, CSG61-R-DG, CSG62-L, CSG62-R, CSG62-R-DG		



Part No.	902448	Ref. No.	211088
description	gasket for cover L 2040mm suitable for MKN for combi-steamer with 6 mounting clips		
For models:	CGE11-L, CGE11-R, CGE12-L, CGE12-R, CGG11-L, CGG11-R, CGG12-L, CGG12-R, CSE11-L, CSE11-R, CSE11-R-DG, CSE12-L, CSE12-R, CSE12-R-DG, CSG11-L, CSG11-R, CSG11-R-DG, CSG12-L, CSG12-R, CSG12-R-DG		

miscellaneous

miscellaneous

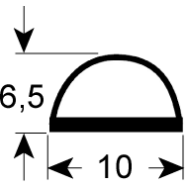

Part No.	902485	Ref. No.	211090
description	lid gasket profile 10x6.5 L 1075mm combi-steamer self-adhesive mounting pos. casing cover suitable for MKN		
For models:	CGE11-L, CGE11-R, CGE12-L, CGE12-R, CGE21-L, CGE21-R, CGE22-L, CGE22-R, CGE61-L, CGE61-R, CGE62-L, CGE62-R, CGG11-L, CGG11-R, CGG12-L, CGG12-R, CGG21-L, CGG21-R, CGG22-L, CGG22-R, CGG61-L, CGG61-R, CGG62-L, CGG62-R, CSE11-L, CSE11-R, CSE11-R-DG, CSE12-L, CSE12-R, CSE12-R-DG, CSE21-L, CSE21-R, CSE21-R-DG, CSE22-L, CSE22-R, CSE22-R-DG, CSE61-L, CSE61-R, CSE61-R-DG, CSE62-L, CSE62-R, CSE62-R-DG, CSG11-L, CSG11-R, CSG11-R-DG, CSG12-L, CSG12-R, CSG12-R-DG, CSG21-L, CSG21-R...(Other models you can see in the webshop)		

lid gaskets

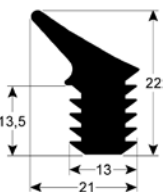

Part No.	902503	Ref. No.	10011826
description	gasket for lid profile 2719 W 685mm L 1098mm outer plug size suitable for MKN Qty 1		

O-rings

EPDM

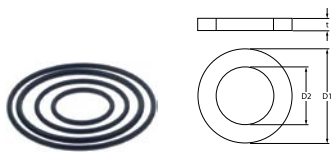

Part No.	518668	Ref. No.	211124
description	gasket set EPDM ID \varnothing 24/38/52/63mm for safety valve		
For models:	1423901-00, 1423901-01, 1423901-02, 1423902-00, 1423902-01, 1423902-02, 1423903-00, 1423903-01, 1423903-02, 1424101-01, 1424102-01, 1424103-00, 1424104-00, 2013901-00, 2013901-01, 2013901-02, 2013901-03, 2013902-00, 2013902-01, 2013902-02, 2013902-03, 2013903-00, 2013903-01, 2013903-02, 2013903-03, 2023901-00, 2023901-01, 2023901-02, 2023901-03, 2023902-00, 2023902-01, 2023902-02, 2023903-00, 2023903-01, 2023903-02, 2024101-01, 2024102-01, 2024103-01, 2024104-01, 2024201-04, 2024202-01, 2024203-04, 2024204-01, 2024205-01, 2024206-00, 2024207-01, 2024208-00, 3023901-03, 3023902-00, 3023902-01... (Other models you can see in the webshop)		

Viton

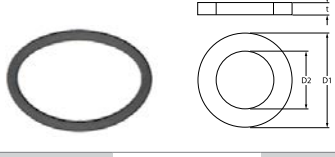

Part No.	104212	Ref. No.	211018
description	O-ring Viton thickness 3mm ID \varnothing 32.5mm Qty 1 pcs		
For models:	0263401-00, 0263401-01, 1220501-00, 1220501-01, 1220501-02, 1220502-00, 1220502-01, 1220802-00, 1220802-01, 1222507-00, 1222509-00, 1263401-00, 1263402-00, 1263402-01, 1263402-02, 1263404-00, 1263404-01, 1263404-02, 1263413-02, 1263414-02, 1320501-00, 1320502-00, 1320802-00, 1322507-00, 1322509-00, 1363401-00, 1363402-00, 1363402-01, 1363402-02, 1363403-00, 1363403-01, 1363403-02, 1363403-03, 1363403-04, 1363403-05, 1363404-00, 1363404-01, 1363404-02, 1363404-03, 1363413-03, 1363415-05, 1422513B00, 1422513B01, 1422515B01, 1422515B02, 1422701-00, 1422701-01, 1422701-02, 1422701-03, 1422702-00... (Other models you can see in the webshop)		



Part No.	532733	Ref. No.	211086
description	O-ring Viton thickness 5mm ID \varnothing 65mm Qty 1 pcs		
For models:	CGE11-L, CGE11-R, CGE12-L, CGE12-R, CGE21-L, CGE21-R, CGE22-L, CGE22-R, CGE61-L, CGE61-R, CGE62-L, CGE62-R, CGG11-L, CGG11-R, CGG12-L, CGG12-R, CGG21-L, CGG21-R, CGG22-L, CGG22-R, CGG61-L, CGG61-R, CGG62-L, CGG62-R, CSE11-L, CSE11-R, CSE11-R-DG, CSE12-L, CSE12-R, CSE12-R-DG, CSE21-L, CSE21-R, CSE21-R-DG, CSE22-L, CSE22-R, CSE22-R-DG, CSE61-L, CSE61-R, CSE61-R-DG, CSE62-L, CSE62-R, CSE62-R-DG, CSG11-L, CSG11-R, CSG11-R-DG, CSG12-L, CSG12-R, CSG21-L, CSG21-R, CSG21-R-DG...(Other models you can see in the webshop)		



miscellaneous

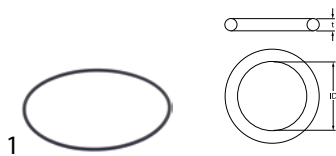

Part No.	519627	Ref. No.	10010994
description	O-ring thickness 1.5mm ID ø 56mm Qty 1 pcs suitable for MKN		

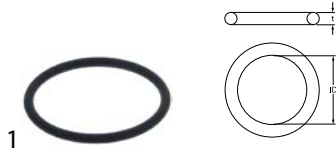

Part No.	519628	Ref. No.	10014116
description	O-ring thickness 3.5mm ID ø 45mm Qty 1 pcs suitable for MKN		

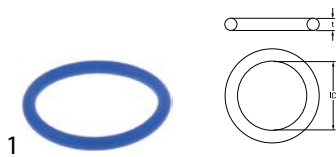

Part No.	532734	Ref. No.	211116
description	O-ring thickness 5mm ID ø 45mm for outflow plug blue		
For models:	1222507-00, 1222509-00, 1322507-00, 1322509-00, 1422513B00, 1422513B01, 1422515B01, 1422515B02, 1422701-02, 1422701-03, 1422702-02, 1422702-03, 1422703-01, 1422703-02, 1422704-01, 1422704-02, 1422705-01, 1422705-02, 1422706-01, 1422706-02, 1422707-01, 1422707-02, 1422708-01, 1422708-02, 1424101-01, 1424102-01, 1424103-00, 1424104-00, 1522507-00, 1522507-01, 1522509-00, 1522509-01, 2022509-00, 2022513-00, 2022701-02, 2022701-03, 2022701-04, 2022703-01, 2022703-03, 2022703-04, 2022705-02, 2022705-03, 2022705-04, 2022707-01, 2022707-03, 2022707-04, 2024101-01, 2024102-01, 2024103-01, 2024104-01... (Other models you can see in the webshop)		

sealing washers

aluminium gaskets



Part No.	560307	Ref. No.	214006
description	flat gasket aluminium ED ø 21mm ID ø 17mm thickness 1.5mm Qty 1 pcs		
For models:	2013003B04, 2013003B05, 2013003B06, 2013007B04, 2013007B05, 2013007B06, 2013009B04, 2013009B05, 2013009B06, 2013017B03, 2013017B04, 2013017B05, 2021401-09, 2021401A09, 2021401B09, 2021401C09, 2021407-03, 2021407A03, 2021407B03, 2021407C03, 2021409-02, 2021409B02, 2021430-01, 2021430-02, 2021430A01, 2021430A02, 2021430B02, 2021430B03, 2021430C02, 2021430C03, 2021436-02, 2021436-03, 2021436A02, 2021436A03, 2021436B02, 2021436B03, 2021436C02, 2021436C03, 2021440-04, 2021440-05, 2021440A04, 2021440A05, 2021440B04, 2021440B05, 2021440C04, 2021440C05, 2021441-04, 2021441-05, 2021441-06, 2021441-07... (Other models you can see in the webshop)		

fibre gaskets

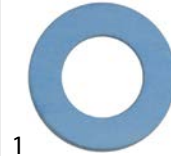

Part No.	540071	Ref. No.	214001
description	flat gasket FIBER ED ø 18mm ID ø 10mm thickness 2mm Qty 1 pcs		
For models:	1423901-00, 1423901-01, 1423901-02, 1423902-00, 1423902-01, 1423902-02, 1423903-00, 1423903-01, 1423903-02, 1424101-00, 1424101-01, 1424102-00, 1424102-01, 1424103-00, 1424104-00, 2013901-00, 2013901-01, 2013901-02, 2013901-03, 2013902-00, 2013902-01, 2013902-02, 2013902-03, 2013903-00, 2013903-01, 2013903-02, 2013903-03, 2020406A01, 2023901-00, 2023901-01, 2023901-02, 2023901-03, 2023902-00, 2023902-01, 2023902-02, 2023903-00, 2023903-01, 2023903-02, 2024101-00, 2024101-01, 2024102-00, 2024102-01, 2024103-00, 2024103-01, 2024104-00, 2024104-01, 2024201-00, 2024201-01, 2024201-02, 2024201-03... (Other models you can see in the webshop)		

graphite gaskets



Part No.	691609	Ref. No.	211143
description	gasket graphite ED ø 150mm ID ø 115mm thickness 2mm Qty 1 pcs		
For models:	CGG11-L, CGG11-R, CGG12-L, CGG12-R, CGG21-L, CGG21-R, CGG22-L, CGG22-R, CGG61-L, CGG61-R, CGG62-L, CGG62-R, CSG11-L, CSG11-R, CSG11-R-DG, CSG12-L, CSG12-R, CSG12-R-DG, CSG21-L, CSG21-R, CSG21-R-DG, CSG22-L, CSG22-R, CSG22-R-DG, CSG61-L, CSG61-R, CSG61-R-DG, CSG62-L, CSG62-R, CSG62-R-DG		

rubber gaskets



Part No.	512514	Ref. No.	211139
description	flat gasket rubber ED ø 19mm ID ø 8mm thickness 2mm for combi-steamer Qty 1 pcs		
For models:	CGE11-L, CGE11-R, CGE12-L, CGE12-R, CGE21-L, CGE21-R, CGE22-L, CGE22-R, CGE61-L, CGE61-R, CGE62-L, CGE62-R, CGG11-L, CGG11-R, CGG12-L, CGG12-R, CGG21-L, CGG21-R, CGG22-L, CGG22-R, CGG61-L, CGG61-R, CGG62-L, CGG62-R, CSE11-L, CSE11-R, CSE11-R-DG, CSE12-L, CSE12-R, CSE12-R-DG, CSE21-L, CSE21-R, CSE21-R-DG, CSE22-L, CSE22-R, CSE22-R-DG, CSE61-L, CSE61-R, CSE61-R-DG, CSE62-L, CSE62-R, CSE62-R-DG, CSG11-L, CSG11-R, CSG11-R-DG, CSG12-L, CSG12-R, CSG12-R-DG, CSG21-L, CSG21-R... (Other models you can see in the webshop)		



copper gaskets

DIN-7603-C



1

Part No.	528520	Ref. No.	211004
description	gasket copper ED ø 22mm ID ø 16mm thickness 2mm		
For models:	1223212-00, 1261101-00, 1261101-01, 1261101-02, 1261102-00, 1261102-01, 1261102-02, 1361101-00, 1361101-01, 1361101-02, 1361101-03, 1361102-00, 1361102-01, 1361102-02, 1361102-03, 1461101-01, 1461101-02, 1461101-03, 1461102-01, 1461102-02, 1461102-03, 1461104-01, 1461104-02, 1461104-03, 1461105-01, 1461105-02, 1461105-03, 1461109-01, 1461109-02, 1461109A01, 1461109A02, 1462802B00, 1462804B00, 1463501-03, 1463501-04, 1463501-05, 1561110-00, 2061101-01, 2061101-02, 2061101-03, 2061101-04, 2061101-05, 2061102-01, 2061102-02, 2061102-03, 2061102-04, 2061102-05, 2061103-04, 2061107-00, 2061107-01... (Other models you can see in the webshop)		

PTFE gaskets



1

Part No.	507588	Ref. No.	10011097
description	flat gasket PTFE ED ø 14mm ID ø 10mm thickness 1mm Qty 1 pcs suitable for		
For models:	CGE11-L, CGE11-R, CGE12-L, CGE12-R, CGE21-L, CGE21-R, CGE22-L, CGE22-R, CGE61-L, CGE61-R, CGE62-L, CGE62-R, CGG11-L, CGG11-R, CGG12-L, CGG12-R, CGG21-L, CGG21-R, CGG22-L, CGG22-R, CGG61-L, CGG61-R, CGG62-L, CGG62-R, CSE11-L, CSE11-R, CSE11-R-DG, CSE12-L, CSE12-R, CSE12-R-DG, CSE61-L, CSE61-R, CSE61-R-DG, CSE62-L, CSE62-R, CSE62-R-DG, CSG11-L, CSG11-R, CSG11-R-DG, CSG12-L, CSG12-R, CSG12-R-DG, CSG21-L, CSG21-R, CSG21-R-DG, CSG22-L, CSG22-R, CSG22-R-DG, CSG61-L, CSG61-R...(Other models you can see in the webshop)		

sealing cords

round



1

Part No.	693464	Ref. No.	211047
description	sealing cord ø 10mm Qty supplied by meter		
For models:	1424802-00, 1424802-01, 1424802-02, 1424808-01, 1424808-02, 1424808-03, 1424809-01, 1424809-02, 1424811-01, 1424811-02, 1424811-03, 1424812-01, 1424812-02, 1424813-01, 1424813-02, 2023201-01, 2023201-02, 2023201-03, 2023201A01, 2023202-01, 2023202-02, 2023202A01, 2023203-02, 2023203-03, 2023203-04, 2023203-05, 2023203-06, 2023203-07, 2023203A02, 2023203A03, 2023204-01, 2023204-02, 2023204A01, 2023205-02, 2023205-03, 2023205-04, 2023205-05, 2023205-06, 2023205-07, 2023205A02, 2023205A03, 2083201A01, 2083202A02, 2083202A03, 2123201-01, 2123201-02, 2123201-03, 2123201-04, 2123202-01, 2123202-02... (Other models you can see in the webshop)		



1

Part No.	693451	Ref. No.	211031
description	sealing cord ø 8mm Qty supplied by meter		
For models:	1223215-00, 1223215A00, 1223216-00, 1223216A00, 1223504A00, 1223504A01, 1223505-00, 1223505-01, 1223505A00, 1223505A01, 1323504-00, 1323504-01, 1323504A00, 1323504A01, 1323505-00, 1323505-01, 1323505A00, 1323505A01, 1323506-00, 1323506-01, 1323506A00, 1323506A01, 1323515-00, 1323515A00, 1323516-00, 1323516A00, 1323517-00, 1323517A00, 1423501-00, 1423501-01, 1423501A00, 1423501A01, 1423502-00, 1423502-01, 1423502-02, 1423502A00, 1423502A01, 1423502A02, 1423504-00, 1423504-01, 1423504A00, 1423504A01, 1423505-00, 1423505-01, 1423505A00, 1423505A01, 1423507A00, 1423508A00, 1423510A00, 1423511A00... (Other models you can see in the webshop)		

shaft gaskets

miscellaneous



1

Part No.	691513	Ref. No.	211084
description	shaft seal ID ø 16.5mm ED ø 29mm thickness 4.8mm		
For models:	CCE60, CGE11-L, CGE11-R, CGE12-L, CGE12-R, CGE21-L, CGE21-R, CGE22-L, CGE22-R, CGE61-L, CGE61-R, CGE62-L, CGE62-R, CGG11-L, CGG11-R, CGG12-L, CGG12-R, CGG21-L, CGG21-R, CGG22-L, CGG22-R, CGG61-L, CGG61-R, CGG62-L, CGG62-R, CPE60, CSE11-L, CSE11-R, CSE11-R-DG, CSE12-L, CSE12-R, CSE12-R-DG, CSE21-L, CSE21-R, CSE21-R-DG, CSE22-L, CSE22-R, CSE22-R-DG, CSE61-L, CSE61-R, CSE61-R-DG, CSE62-L, CSE62-R, CSE62-R-DG, CSG11-L, CSG11-R, CSG11-R-DG, CSG12-L, CSG12-R, CSG12-R-DG...(Other models you can see in the webshop)		

special gaskets

for combi-steamers



1

Part No.	699480	Ref. No.	10010162
description	gasket suitable for MKN combi-steamer ED ø 74mm ID ø 60mm graphite thickness 1.5mm		
For models:	CGE11-L, CGE11-R, CGE12-L, CGE12-R, CGE21-L, CGE21-R, CGE22-L, CGE22-R, CGE61-L, CGE61-R, CGE62-L, CGE62-R, CGG11-L, CGG11-R, CGG12-L, CGG12-R, CGG21-L, CGG21-R, CGG22-L, CGG22-R, CGG61-L, CGG61-R, CGG62-L, CGG62-R, CSE11-L, CSE11-R, CSE11-R-DG, CSE12-L, CSE12-R, CSE12-R-DG, CSE21-L, CSE21-R, CSE21-R-DG, CSE22-L, CSE22-R, CSE22-R-DG, CSE61-L, CSE61-R, CSE61-R-DG, CSE62-L, CSE62-R, CSE62-R-DG, CSG11-L, CSG11-R, CSG11-R-DG, CSG12-L, CSG12-R, CSG12-R-DG, CSG21-L, CSG21-R...(Other models you can see in the webshop)		





1

Part No.	699465	Ref. No.	211129
description	gasket suitable for MKN combi-steamer L 148mm W 121mm mounting pos. - thickness 3mm		
For models:	CGE11-L, CGE11-R, CGE12-L, CGE12-R, CGE61-L, CGE61-R, CGE62-L, CGE62-R, CGG11-L, CGG11-R, CGG12-L, CGG12-R, CGG21-L, CGG21-R, CGG22-L, CGG22-R, CGG61-L, CGG61-R, CGG62-L, CGG62-R, CSE11-L, CSE11-R, CSE11-R-DG, CSE12-L, CSE12-R, CSE12-R-DG, CSE61-L, CSE61-R, CSE61-R-DG, CSE62-L, CSE62-R, CSE62-R-DG, CSG11-L, CSG11-R, CSG11-R-DG, CSG12-L, CSG12-R, CSG12-R-DG, CSG61-L, CSG61-R, CSG61-R-DG, CSG62-L, CSG62-R, CSG62-R-DG		





			
Part No.	699464	Ref. No.	211145
description	gasket suitable for MKN combi-steamer L 43mm W 19mm mounting pos. level glass graphite thickness 1.5mm		
For models:	CGG11-L, CGG11-R, CGG12-L, CGG12-R, CGG21-L, CGG21-R, CGG22-L, CGG22-R, CGG61-L, CGG61-R, CGG62-L, CGG62-R, CSG11-L, CSG11-R, CSG11-R-DG, CSG12-L, CSG12-R, CSG12-R-DG, CSG21-L, CSG21-R, CSG21-R-DG, CSG22-L, CSG22-R, CSG22-R-DG, CSG61-L, CSG61-R, CSG61-R-DG, CSG62-L, CSG62-R, CSG62-R-DG		

			
Part No.	699481	Ref. No.	10011098
description	gasket suitable for MKN combi-steamer L 58mm W 22mm ID ø 13mm graphite thickness 1.5mm		
For models:	CGE11-L, CGE11-R, CGE12-L, CGE12-R, CGE21-L, CGE21-R, CGE22-L, CGE22-R, CGE61-L, CGE61-R, CGE62-L, CGE62-R, CGG11-L, CGG11-R, CGG12-L, CGG12-R, CGG21-L, CGG21-R, CGG22-L, CGG22-R, CGG61-L, CGG61-R, CGG62-L, CGG62-R, CSE11-L, CSE11-R, CSE11-R-DG, CSE12-L, CSE12-R, CSE12-R-DG, CSE61-L, CSE61-R, CSE61-R-DG, CSE62-L, CSE62-R, CSE62-R-DG, CSG11-L, CSG11-R, CSG11-R-DG, CSG12-L, CSG12-R, CSG12-R-DG, CSG21-L, CSG21-R, CSG21-R-DG, CSG22-L, CSG22-R, CSG22-R-DG, CSG61-L, CSG61-R...(Other models you can see in the webshop)		

			
Part No.	699462	Ref. No.	211144
description	gasket suitable for MKN combi-steamer L 64mm W 64mm mounting pos. heat exchanger ID ø 43mm graphite thickness 1.5mm		
For models:	CGG11-L, CGG11-R, CGG12-L, CGG12-R, CGG21-L, CGG21-R, CGG22-L, CGG22-R, CGG61-L, CGG61-R, CGG62-L, CGG62-R, CSG11-L, CSG11-R, CSG11-R-DG, CSG12-L, CSG12-R, CSG12-R-DG, CSG21-L, CSG21-R, CSG21-R-DG, CSG22-L, CSG22-R, CSG22-R-DG, CSG61-L, CSG61-R, CSG61-R-DG, CSG62-L, CSG62-R, CSG62-R-DG		

			
Part No.	699463	Ref. No.	211097
description	gasket suitable for MKN combi-steamer L 70mm W 35mm mounting pos. for injection pipe ID ø 13mm graphite thickness 1mm		
For models:	CGE11-L, CGE11-R, CGE12-L, CGE12-R, CGE21-L, CGE21-R, CGE22-L, CGE22-R, CGE61-L, CGE61-R, CGE62-L, CGE62-R, CGG11-L, CGG11-R, CGG12-L, CGG12-R, CGG21-L, CGG21-R, CGG22-L, CGG22-R, CGG61-L, CGG61-R, CGG62-L, CGG62-R, CPE63, CSE11-L, CSE11-R, CSE11-R-DG, CSE12-L, CSE12-R, CSE12-R-DG, CSE21-L, CSE21-R, CSE21-R-DG, CSE22-L, CSE22-R, CSE22-R-DG, CSE61-L, CSE61-R, CSE61-R-DG, CSE62-L, CSE62-R, CSE62-R-DG, CSG11-L, CSG11-R, CSG11-R-DG, CSG12-L, CSG12-R, CSG12-R-DG, CSG21-L, CSG21-R, CSG21-R-DG, CSG22-L...(Other models you can see in the webshop)		

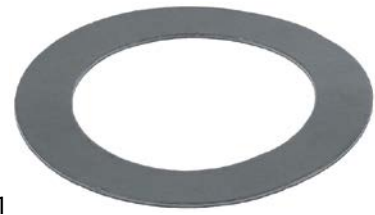
			
Part No.	692800	Ref. No.	211141
description	gasket suitable for MKN combi-steamer L 82mm W 62mm mounting pos. burner thickness 1.5mm graphite Qty 1 pcs		
For models:	CGG11-L, CGG11-R, CGG12-L, CGG12-R, CGG21-L, CGG21-R, CGG22-L, CGG22-R, CGG61-L, CGG61-R, CGG62-L, CGG62-R, CSG11-L, CSG11-R, CSG11-R-DG, CSG12-L, CSG12-R, CSG12-R-DG, CSG21-L, CSG21-R, CSG21-R-DG, CSG22-L, CSG22-R, CSG22-R-DG, CSG61-L, CSG61-R, CSG61-R-DG, CSG62-L, CSG62-R, CSG62-R-DG		

			
Part No.	699482	Ref. No.	211146
description	gasket suitable for MKN combi-steamer mounting pos. for lens ED ø 105mm ID ø 71mm graphite thickness 1mm		
For models:	CGE21-L, CGE21-R, CGE22-L, CGE22-R, CGG21-L, CGG21-R, CGG22-L, CGG22-R, CSE11-L, CSE11-R, CSE11-R-DG, CSE12-L, CSE12-R, CSE12-R-DG, CSE21-L, CSE21-R, CSE21-R-DG, CSE22-L, CSE22-R, CSE22-R-DG, CSE61-L, CSE61-R, CSE61-R-DG, CSE62-L, CSE62-R, CSE62-R-DG, CSG11-L, CSG11-R, CSG11-R-DG, CSG12-L, CSG12-R, CSG12-R-DG, CSG21-L, CSG21-R, CSG21-R-DG, CSG22-L, CSG22-R, CSG22-R-DG, CSG61-L, CSG61-R, CSG61-R-DG, CSG62-L, CSG62-R, CSG62-R-DG		
accessories for	699482		
		Part No.	694294
		Ref. No.	216115
	glass panel ø 90mm thickness 8mm		

			
Part No.	699483	Ref. No.	214009
description	gasket suitable for MKN combi-steamer mounting pos. for temperature probe ED ø 19mm ID ø 12mm graphite thickness 1mm		
For models:	CCE60, CCE63, CGE11-L, CGE11-R, CGE12-L, CGE12-R, CGE21-L, CGE21-R, CGE22-L, CGE22-R, CGE61-L, CGE61-R, CGE62-L, CGE62-R, CGG11-L, CGG11-R, CGG12-L, CGG12-R, CGG21-L, CGG21-R, CGG22-L, CGG22-R, CGG61-L, CGG61-R, CGG62-L, CGG62-R, CPE60, CPE63, CSE11-L, CSE11-R, CSE11-R-DG, CSE12-L, CSE12-R, CSE12-R-DG, CSE61-L, CSE61-R, CSE61-R-DG, CSE62-L, CSE62-R, CSE62-R-DG, CSG11-L, CSG11-R, CSG11-R-DG, CSG12-L, CSG12-R, CSG12-R-DG, CSG21-L, CSG21-R, CSG21-R-DG, CSG22-L...(Other models you can see in the webshop)		

			
Part No.	699479	Ref. No.	10010164
description	gasket suitable for MKN combi-steamer mounting pos. outflow ED ø 115mm ID ø 71mm graphite thickness 1.5mm		
For models:	CGE21-L, CGE21-R, CGE22-L, CGE22-R, CGG21-L, CGG21-R, CGG22-L, CGG22-R, CSG21-L, CSG21-R, CSG21-R-DG, CSG22-L, CSG22-R, CSG22-R-DG		



1

Part No.	699478	Ref. No.	10010161
description	gasket suitable for MKN combi-steamer mounting pos. outflow ED ø 88mm ID ø 53mm graphite thickness 1.5mm		
For models:	CGE11-L, CGE11-R, CGE12-L, CGE12-R, CGE61-L, CGE61-R, CGE62-L, CGE62-R, CGG11-L, CGG11-R, CGG12-L, CGG12-R, CGG61-L, CGG61-R, CGG62-L, CGG62-R, CSE11-L, CSE11-R, CSE11-R-DG, CSE12-L, CSE12-R, CSE12-R-DG, CSE61-L, CSE61-R, CSE61-R-DG, CSE62-L, CSE62-R, CSE62-R-DG, CSG11-L, CSG11-R, CSG11-R-DG, CSG12-L, CSG12-R, CSG12-R-DG, CSG61-L, CSG61-R, CSG61-R-DG, CSG62-L, CSG62-R, CSG62-R-DG		

1

Part No.	699461	Ref. No.	211142
description	gasket suitable for MKN combi-steamer mounting pos. radial fan ED ø 82mm ID ø 52mm graphite thickness 1.5mm		
For models:	1462831-00, 1462832-00, 1462833-00, 1462834-00, 1462835-00, 1462836-00, 1462837-00, 1462838-00, 1462839-00, 1462840-00, 1462908-00, 1462910-00, 2062831-00, 2062832-00, 2062833-00, 2062834-00, 2062835-00, 2062835-01, 2062836-00, 2062836-01, 2062837-00, 2062837-01, 2062838-00, 2062838-01, 2062839-00, 2062839-01, 2062840-00, 2062840-01, 2062908-00, 2062910-00, 2162835-00, 2162835-01, 2162838-00, 2162838-01, 3062831-00, 3062832-00, 3062833-00, 3062834-00, 3062835-00, 3062836-00, 3062837-00, 3062838-00, 3062839-00, 3062840-00, 3062908-00, 3062910-00, CGG11-L, CGG11-R, CGG12-L, CGG12-R...(Other models you can see in the webshop)		

1

Part No.	699466	Ref. No.	211123
description	gasket suitable for MKN ED ø 9mm ID ø 5mm thickness 3.7mm		
For models:	CGE11-L, CGE11-R, CGE12-L, CGE12-R, CGE61-L, CGE61-R, CGE62-L, CGE62-R, CGG11-L, CGG11-R, CGG12-L, CGG12-R, CGG61-L, CGG61-R, CGG62-L, CGG62-R, CSE11-L, CSE11-R, CSE11-R-DG, CSE12-L, CSE12-R, CSE12-R-DG, CSE61-L, CSE61-R, CSE61-R-DG, CSE62-L, CSE62-R, CSE62-R-DG, CSG11-L, CSG11-R, CSG11-R-DG, CSG12-L, CSG12-R, CSG12-R-DG, CSG61-L, CSG61-R, CSG61-R-DG, CSG62-L, CSG62-R, CSG62-R-DG		

1

Part No.	699458	Ref. No.	211099
description	gasket suitable for MKN for pipe DN70 ring - combi-steamer		
For models:	CGE21-L, CGE21-R, CGE22-L, CGE22-R, CGG21-L, CGG21-R, CGG22-L, CGG22-R, CSE21-L, CSE21-R, CSE21-R-DG, CSE22-L, CSE22-R, CSE22-R-DG, CSG21-L, CSG21-R, CSG21-R-DG, CSG22-L, CSG22-R, CSG22-R-DG		

1

Part No.	699460	Ref. No.	211092
description	gasket suitable for MKN for spray gun grommet ED ø 56mm ID ø 32.5mm foam seal thickness 13mm combi-steamer		
For models:	CGE11-L, CGE11-R, CGE12-L, CGE12-R, CGE21-L, CGE21-R, CGE22-L, CGE22-R, CGE61-L, CGE61-R, CGE62-L, CGE62-R, CGG11-L, CGG11-R, CGG12-L, CGG12-R, CGG21-L, CGG21-R, CGG22-L, CGG22-R, CGG61-L, CGG61-R, CGG62-L, CGG62-R, CSE11-L, CSE11-R, CSE11-R-DG, CSE12-L, CSE12-R, CSE12-R-DG, CSE21-L, CSE21-R, CSE22-L, CSE22-R, CSE61-L, CSE61-R, CSE61-R-DG, CSE62-L, CSE62-R, CSE62-R-DG, CSG11-L, CSG11-R, CSG11-R-DG, CSG12-L, CSG12-R, CSG12-R-DG, CSG21-L, CSG21-R, CSG22-L, CSG22-R...(Other models you can see in the webshop)		

1

Part No.	699362	Ref. No.	211079
description	gasket suitable for MKN profile no to be sold in France for combi-steamer ED ø 58mm rubber DN 50mm		
For models:	815156, 815157, 815166, 815167, 845906, 845986, 846111, 846116, CGE11-L, CGE11-R, CGE12-L, CGE12-R, CGE61-L, CGE61-R, CGE62-L, CGE62-R, CGG11-L, CGG11-R, CGG12-L, CGG12-R, CGG21-L, CGG21-R, CGG22-L, CGG22-R, CGG61-L, CGG61-R, CGG62-L, CGG62-R, CSE11-L, CSE11-R, CSE11-R-DG, CSE12-L, CSE12-R, CSE12-R-DG, CSE61-L, CSE61-R, CSE61-R-DG, CSE62-L, CSE62-R, CSE62-R-DG, CSG11-L, CSG11-R, CSG11-R-DG, CSG12-L, CSG12-R, CSG12-R-DG, CSG21-L, CSG21-R, CSG21-R-DG, CSG22-L...(Other models you can see in the webshop)		

1

Part No.	699459	Ref. No.	211131
description	gasket suitable for MKN size 24x34x10 ring - combi-steamer		
For models:	CCE60, CCE63, CGE11-L, CGE11-R, CGE12-L, CGE12-R, CGE21-L, CGE21-R, CGE22-L, CGE22-R, CGE61-L, CGE61-R, CGE62-L, CGE62-R, CGG11-L, CGG11-R, CGG12-L, CGG12-R, CGG21-L, CGG21-R, CGG22-L, CGG22-R, CGG61-L, CGG61-R, CGG62-L, CGG62-R, CPE60, CPE63, CSE11-L, CSE11-R, CSE11-R-DG, CSE12-L, CSE12-R, CSE12-R-DG, CSE21-L, CSE21-R, CSE21-R-DG, CSE22-L, CSE22-R, CSE22-R-DG, CSE61-L, CSE61-R, CSE61-R-DG, CSE62-L, CSE62-R, CSE62-R-DG, CSG11-L, CSG11-R, CSG11-R-DG, CSG12-L...(Other models you can see in the webshop)		



			
1			
Part No.	699366	Ref. No.	211080
description	gasket suitable for profile for combi-steamer ED ø 42mm ID ø 36mm rubber thickness 6.5mm		
For models:	CCE60, CCE63, CGE11-L, CGE11-R, CGE12-L, CGE12-R, CGE21-L, CGE21-R, CGE22-L, CGE22-R, CGE61-L, CGE61-R, CGE62-L, CGE62-R, CGG11-L, CGG11-R, CGG12-L, CGG12-R, CGG21-L, CGG21-R, CGG22-L, CGG22-R, CGG61-L, CGG61-R, CGG62-L, CGG62-R, CPE60, CPE63, CSE11-L, CSE11-R, CSE11-R-DG, CSE12-L, CSE12-R, CSE12-R-DG, CSE21-L, CSE21-R, CSE21-R-DG, CSE22-L, CSE22-R, CSE22-R-DG, CSE61-L, CSE61-R, CSE61-R-DG, CSE62-L, CSE62-R, CSE62-R-DG, CSG11-L, CSG11-R, CSG11-R-DG, CSG12-L...(Other models you can see in the webshop)		

			
1			
Part No.	699365	Ref. No.	211078
description	gasket U-bend L 73mm W 73mm ID ø 60mm thickness 3mm		
For models:	CGE11-L, CGE11-R, CGE12-L, CGE12-R, CGE21-L, CGE21-R, CGE22-L, CGE22-R, CGE61-L, CGE61-R, CGE62-L, CGE62-R, CGG11-L, CGG11-R, CGG12-L, CGG12-R, CGG21-L, CGG21-R, CGG22-L, CGG22-R, CGG61-L, CGG61-R, CGG62-L, CGG62-R, CSE11-L, CSE11-R, CSE11-R-DG, CSE12-L, CSE12-R, CSE12-R-DG, CSE21-L, CSE21-R, CSE21-R-DG, CSE22-L, CSE22-R, CSE22-R-DG, CSE61-L, CSE61-R, CSE61-R-DG, CSE62-L, CSE62-R, CSE62-R-DG, CSG11-L, CSG11-R, CSG11-R-DG, CSG12-L, CSG12-R, CSG12-R-DG, CSG21-L, CSG21-R...(Other models you can see in the webshop)		

miscellaneous			
			
1			
Part No.	550289	Ref. No.	211003
description	flat gasket		
For models:	0524301-01, 0524302-01, 0524303-01, 0524304-01, 0720325-03, 0720325-04, 0720325B03, 0720325B04, 0720332P00, 0720332R00, 0720332T00, 0720332V00, 0720504-04, 0721134-01, 0721134A01, 0721172A01, 0721173A01, 0721174A01, 0721175A01, 0722101-06, 0723104-03, 0723104A03, 0723104B03, 0723105-03, 0723105A03, 0723105B03, 0723405-01, 0723405-02, 0723409-01, 0723409-02, 0723412K01, 0723413-02, 0723414-02, 1020510-00, 1022603-00, 1023101-00, 1023101-01, 1023106-00, 1023106-01, 1023111-00, 1023111-01, 1023401-00, 1023401K00, 1023410-00, 1121121-00, 1121121A00, 1220301-00, 1220301-01, 1220301-02, 1220301-03...(Other models you can see in the webshop)		

evaporators

for fridges

producer-specific

			
1			
Part No.	750238	Ref. No.	935611
description	evaporator L 535mm W 80mm H 205mm		

springs

torsion springs

			
1			
Part No.	699291	Ref. No.	216156
description	torsion spring ø 24mm L2 69mm wire gauge ø 3mm L1 23mm L3 69mm for door handle		
For models:	CCE60, CCE63, CPE60, CPE63		

			
1			
Part No.	700514	Ref. No.	216079
description	torsion spring ø 26.6mm wire gauge ø 6.1mm L1 420mm L3 26mm		
For models:	0522101-00, 0522101-01, 0522101-02, 0522101-03, 0522101-04, 0522102-00, 0522102-01, 0522102-02, 0522102-03, 0522102-04, 0722101-06, 1323208-00, 1323208-01, 1323208-02, 1323208-03, 1323208-04, 1323210-00, 1323210-01, 1323210-02, 1323210-03, 1323210-04, 1323403-00, 1323403K00, 1323506-00, 1323506-01, 1323506A00, 1323506A01, 1323517-00, 1323517A00, 1363403-00, 1363403-01, 1363403-02, 1363403-03, 1363403-04, 1363403-05, 1363415-05, 1422101-00, 1422101-01, 1422101-02, 1422101-03, 1422101-04, 1422101-05, 1422101-06, 1422102-00, 1422102-01, 1422102-02, 1422102-03, 1422102-04, 1422102-05, 1422104-05...(Other models you can see in the webshop)		



tension springs

			
1			
Part No.	700552	Ref. No.	216084
description	tension spring		
For models:	2013003B01, 2013003B02, 2013003B03, 2013003B04, 2013003B05, 2013003B06, 2013007B01, 2013007B02, 2013007B03, 2013007B04, 2013007B05, 2013007B06, 2013009B01, 2013009B02, 2013009B03, 2013009B04, 2013009B05, 2013009B06, 2013017B00, 2013017B01, 2013017B02, 2013017B03, 2013017B04, 2013017B05, 2021403-00, 2021403-01, 2021403-02, 2021403-03, 2021403-04, 2021403-05, 2021403-06, 20214033-0, 2021403A00, 2021403A01, 2021403A02, 2021403A04, 2021403A05, 2021403A06, 2021403B00, 2021403B01, 2021403B02, 2021403B04, 2021403B05, 2021403B06, 2021403C01, 2021403C02, 2021403C04, 2021403C05, 2021403C06, 2021405-00...(Other models you can see in the webshop)		



manometers

 <p>1</p>			
Part No.	541427	Ref. No.	201106
description	manometer ø 62mm pressure range 0 up to 1.6bar thread 1/4" marking 0.5 connection on the backside		
For models:	14228011-0, 14228022-0, 14228033-0, 14228044-0, 14228055-0, 2012801-00, 2012801-01, 2012801A00, 2012801A01, 2012801B00, 2012801B01, 2012801C00, 2012801C01, 2012802-00, 2012802-01, 2012802A00, 2012802A01, 2012802B00, 2012802B01, 2012802C00, 2012802C01, 2012803-00, 2012803-01, 2012803A00, 2012803A01, 2012803B00, 2012803B01, 2012803C00, 2012803C01, 2012804-00, 2012804-01, 2012804A00, 2012804A01, 2012804B00, 2012804B01, 2012804C00, 2012804C01, 2012805-00, 2012805-01, 2012805A00, 2012805A01, 2012805B00, 2012805B01, 2012805C00, 2012805C01, 2012806B00, 2012806C00, 2012807B00, 2012807C00, 2012901B00... (Other models you can see in the webshop)		

 <p>1</p>							
Part No.	541062	Ref. No.	201105				
description	manometer ø 63mm pressure range 0 up to 1bar connection marking adjustable kettle thread 1/4"						
spare parts for	541062						
	<table border="1"> <tr> <td>Part No.</td> <td>541130</td> <td>Ref. No.</td> <td>—</td> </tr> </table>	Part No.	541130	Ref. No.	—		
Part No.	541130	Ref. No.	—				
	 <p>glass panel ø 58mm thickness 2mm</p>						

 <p>1</p>			
Part No.	541099	Ref. No.	201731
description	manometer ø 63mm pressure range -1.5 up to +1.5bar thread 1/4" marking 1 kettle		
For models:	1412831-00, 1412832-00, 1412833-00, 1412833-01, 1412834-00, 1412834-01, 1412908-00, 1412910-00, 1412910-01, 1422802B04, 1422802B05, 1422802B06, 1422802B07, 1422802B08, 1422804B04, 1422804B05, 1422804B06, 1422804B07, 1422804B08, 1422805B04, 1422805B05, 1422805B06, 1422805B07, 1422805B08, 1422807B00, 1422807B01, 1422807B02, 1422807B03, 1422807B04, 1422831-00, 1422832-00, 1422833-00, 1422834-00, 1422902-00, 1422902-01, 1422902-02, 1422902-03, 1422902-04, 1422908-00, 1422910-00, 1462802B00, 1462802B01, 1462802B02, 1462802B03, 1462802B04, 1462802B05, 1462804B00, 1462804B01, 1462804B02, 1462804B03... (Other models you can see in the webshop)		

hose reels and spray guns

spray guns

 <p>1</p>			
Part No.	542800	Ref. No.	201147
description	spray gun for appliances 1/2" ET L 120mm with backflow preventer type MKN		
For models:	CGE11-L, CGE11-R, CGE12-L, CGE12-R, CGE21-L, CGE21-R, CGE22-L, CGE22-R, CGE61-L, CGE61-R, CGE62-L, CGE62-R, CGG11-L, CGG11-R, CGG12-L, CGG12-R, CGG21-L, CGG21-R, CGG22-L, CGG22-R, CGG61-L, CGG61-R, CGG62-L, CGG62-R, CSE11-L, CSE11-R, CSE11-R-DG, CSE12-L, CSE12-R, CSE12-R-DG, CSE21-L, CSE21-R, CSE21-R-DG, CSE22-L, CSE22-R, CSE22-R-DG, CSE61-L, CSE61-R, CSE61-R-DG, CSE62-L, CSE62-R, CSE62-R-DG, CSG11-L, CSG11-R, CSG11-R-DG, CSG12-L, CSG12-R, CSG12-R-DG, CSG21-L, CSG21-R... (Other models you can see in the webshop)		

 <p>1</p>			
Part No.	699460	Ref. No.	211092
description	gasket suitable for MKN for spray gun grommet ED ø 56mm ID ø 32.5mm foam seal thickness 13mm combi-steamer		
For models:	CGE11-L, CGE11-R, CGE12-L, CGE12-R, CGE21-L, CGE21-R, CGE22-L, CGE22-R, CGE61-L, CGE61-R, CGE62-L, CGE62-R, CGG11-L, CGG11-R, CGG12-L, CGG12-R, CGG21-L, CGG21-R, CGG22-L, CGG22-R, CGG61-L, CGG61-R, CGG62-L, CGG62-R, CSE11-L, CSE11-R, CSE11-R-DG, CSE12-L, CSE12-R, CSE12-R-DG, CSE21-L, CSE21-R, CSE22-L, CSE22-R, CSE61-L, CSE61-R, CSE61-R-DG, CSE62-L, CSE62-R, CSE62-R-DG, CSG11-L, CSG11-R, CSG11-R-DG, CSG12-L, CSG12-R, CSG12-R-DG, CSG21-L, CSG21-R, CSG22-R... (Other models you can see in the webshop)		

 <p>1</p>			
Part No.	694988	Ref. No.	204428
description	grommet connection bush Hans Dampf for spray gun		
For models:	CGE11-L, CGE11-R, CGE12-L, CGE12-R, CGE21-L, CGE21-R, CGE22-L, CGE22-R, CGE61-L, CGE61-R, CGE62-L, CGE62-R, CGG11-L, CGG11-R, CGG12-L, CGG12-R, CGG21-L, CGG21-R, CGG22-L, CGG22-R, CGG61-L, CGG61-R, CGG62-L, CGG62-R, CSE11-L, CSE11-R, CSE11-R-DG, CSE12-L, CSE12-R, CSE12-R-DG, CSE21-L, CSE21-R, CSE21-R-DG, CSE22-L, CSE22-R, CSE22-R-DG, CSE61-L, CSE61-R, CSE61-R-DG, CSE62-L, CSE62-R, CSE62-R-DG, CSG11-L, CSG11-R, CSG11-R-DG, CSG12-L, CSG12-R, CSG12-R-DG, CSG21-L, CSG21-R... (Other models you can see in the webshop)		

mechanical components, equipment accessories



hose reels

appliance hose reels



Part No.	542804	Ref. No.	204410
description	hose reel without spray gun hose length 1.8m		
For models:	CGE11-L, CGE11-R, CGE12-L, CGE12-R, CGE21-L, CGE21-R, CGE22-L, CGE22-R, CGE61-L, CGE61-R, CGE62-L, CGE62-R, CGG11-L, CGG11-R, CGG12-L, CGG12-R, CGG21-L, CGG21-R, CGG22-L, CGG22-R, CGG61-L, CGG61-R, CGG62-L, CGG62-R, CSE11-L, CSE11-R, CSE11-R-DG, CSE12-L, CSE12-R, CSE12-R-DG, CSE21-L, CSE21-R, CSE21-R-DG, CSE22-L, CSE22-R, CSE22-R-DG, CSE61-L, CSE61-R, CSE61-R-DG, CSE62-L, CSE62-R, CSE62-R-DG, CSG11-L, CSG11-R, CSG11-R-DG, CSG12-L, CSG12-R, CSG21-L, CSG21-R, CSG21-R-DG...(Other models you can see in the webshop)		

dosing pumps



membrane dosing pumps

self-priming

LANG

accessories



Part No.	101286	Ref. No.	201571	
description	olive ID ø 6mm Qty 1 pcs			
For models:	0260301-00, 0260301-01, 0260302-00, 0260302-01, 1260301-00, 1260301-01, 1260302-00, 1260302-01, 1412831-00, 1412832-00, 1412833-00, 1412833-01, 1412834-00, 1412834-01, 1412908-00, 1412910-00, 1412910-01, 1422802B04, 1422802B05, 1422802B06, 1422802B07, 1422802B08, 1422804B04, 1422804B05, 1422804B06, 1422804B07, 1422804B08, 1422805B04, 1422805B05, 1422805B06, 1422805B07, 1422805B08, 1422807B00, 1422807B01, 1422807B02, 1422807B03, 1422807B04, 1422831-00, 1422832-00, 1422833-00, 1422834-00, 1422902-00, 1422902-01, 1422902-02, 1422902-03, 1422902-04, 1422908-00, 1422910-00, 1423901-00, 1423901-01...(Other models you can see in the webshop)			
accessories for	101286			
	Part No.	100909	Ref. No.	—
	union screw thread M10x1 for pipe ø 6mm Qty 1 pcs			
	Part No.	101464	Ref. No.	—
	union nut thread M12x1 for pipe ø 6mm			

hoses

industrial hoses

nylon hoses



Part No.	530566	Ref. No.	050016
description	nylon hose ID ø 8mm ED ø 10mm L 5m thickness 1mm operating p. 10bar burst p. 50bar t.max. 100°C transparent		
For models:	CGE11-L, CGE11-R, CGE12-L, CGE12-R, CGE21-L, CGE21-R, CGE22-L, CGE22-R, CGE61-L, CGE61-R, CGE62-L, CGE62-R, CGG11-L, CGG11-R, CGG12-L, CGG12-R, CGG21-L, CGG21-R, CGG22-L, CGG22-R, CGG61-L, CGG61-R, CGG62-L, CGG62-R, CSE11-L, CSE11-R, CSE11-R-DG, CSE12-L, CSE12-R, CSE12-R-DG, CSE21-L, CSE21-R, CSE21-R-DG, CSE22-L, CSE22-R, CSE22-R-DG, CSE61-L, CSE61-R, CSE61-R-DG, CSE62-L, CSE62-R, CSE62-R-DG, CSG11-L, CSG11-R, CSG11-R-DG, CSG12-L, CSG12-R, CSG12-R-DG, CSG21-L, CSG21-R...(Other models you can see in the webshop)		

silicone hoses

without fabric



Part No.	530898	Ref. No.	050015
description	silicone hose ID ø 60mm ED ø 64mm L 1m thickness 2mm		
For models:	815156, 815157, 815166, 815167, CCE60, CCE63, CGE11-L, CGE11-R, CGE12-L, CGE12-R, CGE21-L, CGE21-R, CGE22-L, CGE22-R, CGE61-L, CGE61-R, CGE62-L, CGE62-R, CGG11-L, CGG11-R, CGG12-L, CGG12-R, CGG21-L, CGG21-R, CGG22-L, CGG22-R, CGG61-L, CGG61-R, CGG62-L, CGG62-R, CPE60, CPE63, CSE11-L, CSE11-R, CSE11-R-DG, CSE12-L, CSE12-R, CSE12-R-DG, CSE21-L, CSE21-R, CSE21-R-DG, CSE22-L, CSE22-R, CSE22-R-DG, CSE61-L, CSE61-R, CSE61-R-DG, CSE62-L, CSE62-R, CSE62-R-DG...(Other models you can see in the webshop)		

pressure hoses (other)



Part No.	520107	Ref. No.	050003
description	pressure hose		
For models:	1412831-00, 1412832-00, 1412833-00, 1412833-01, 1412834-00, 1412834-01, 1412908-00, 1412910-00, 1412910-01, 14228011-0, 14228022-0, 1422802B04, 1422802B05, 1422802B06, 1422802B07, 1422802B08, 14228033-0, 14228044-0, 1422804B04, 1422804B05, 1422804B06, 1422804B07, 1422804B08, 14228055-0, 1422805B04, 1422805B05, 1422805B06, 1422805B07, 1422805B08, 1422807B00, 1422807B01, 1422807B02, 1422807B03, 1422807B04, 1422831-00, 1422832-00, 1422833-00, 1422834-00, 1422902-00, 1422902-01, 1422902-02, 1422902-03, 1422902-04, 1422908-00, 1422910-00, 1423901-00, 1423901-01, 1423901-02, 1423902-00, 1423902-01...(Other models you can see in the webshop)		



formed hoses

miscellaneous



Part No.	513326	Ref. No.	050024 204690
description	formed hose ID ø 15mm ED ø 24mm U-bend		
For models:	CGE11-L, CGE11-R, CGE12-L, CGE12-R, CGE61-L, CGE61-R, CGE62-L, CGE62-R, CGG11-L, CGG11-R, CGG12-L, CGG12-R, CGG61-L, CGG61-R, CGG62-L, CGG62-R, CSE11-L, CSE11-R, CSE11-R-DG, CSE12-L, CSE12-R, CSE12-R-DG, CSE61-L, CSE61-R, CSE61-R-DG, CSE62-L, CSE62-R, CSE62-R-DG, CSG11-L, CSG11-R, CSG11-R-DG, CSG12-L, CSG12-R, CSG12-R-DG, CSG61-L, CSG61-R, CSG61-R-DG, CSG62-L, CSG62-R, CSG62-R-DG		

miscellaneous

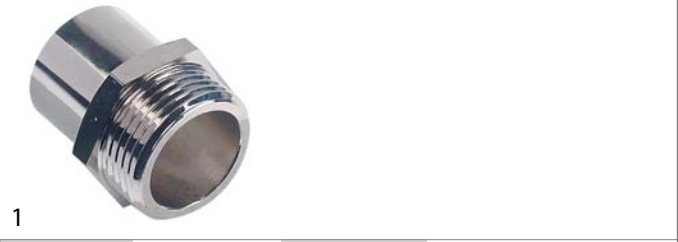

Part No.	520375	Ref. No.	201038
description	screw connection thread 1" L 42mm ø 30mm		
For models:	0220301D00, 0220302D00, 0220302E00, 0220302E01, 0220303D00, 0220303D01, 0220303E00, 0220303E01, 0260301-00, 0260301-01, 0260302-00, 0260302-01, 0720504-04, 1220301D00, 1220301D01, 1220301E00, 1220301E01, 1220302D00, 1220302E00, 1220303D00, 1220303D01, 1220303D02, 1220303E00, 1220303E01, 1220303E02, 1220303F01, 1220303F02, 1220303F03, 1220303H00, 1220303H01, 1220303H02, 1220303H03, 1220304D00, 1220304E00, 1220304F00, 1220304H00, 1220305D00, 1220305D01, 1220305D02, 1220305D03, 1220305D04, 1220305E00, 1220305E01, 1220305E02, 1220305E03, 1220305E04, 1220305F01, 1220305F02, 1220305F03, 1220305F04... (Other models you can see in the webshop)		

fittings, hose and pipe connectors

hose connectors

without screw connection



Part No.	504817	Ref. No.	205174
description	T-piece SS hose ø 10-10-10mm		
For models:	CCE60, CCE63, CGE21-L, CGE21-R, CGE22-L, CGE22-R, CGG21-L, CGG21-R, CGG22-L, CGG22-R, CPE60, CPE63, CSE21-L, CSE21-R, CSE21-R-DG, CSE22-L, CSE22-R, CSE22-R-DG, CSG21-L, CSG21-R, CSG21-R-DG, CSG22-L, CSG22-R, CSG22-R-DG		

hose connectors

plastic



Part No.	506275	Ref. No.	205320
description	hose connector plastic straight thread G 3/4" hose ø 11mm Qty 1 pcs with gasket		
For models:	CCE60, CCE63, CGE11-L, CGE11-R, CGE12-L, CGE12-R, CGE21-L, CGE21-R, CGE22-L, CGE22-R, CGE61-L, CGE61-R, CGE62-L, CGE62-R, CGG11-L, CGG11-R, CGG12-L, CGG12-R, CGG21-L, CGG21-R, CGG22-L, CGG22-R, CGG61-L, CGG61-R, CGG62-L, CGG62-R, CPE60, CPE63, CSE11-L, CSE11-R, CSE11-R-DG, CSE12-L, CSE12-R, CSE12-R-DG, CSE21-L, CSE21-R, CSE21-R-DG, CSE22-L, CSE22-R, CSE22-R-DG, CSE61-L, CSE61-R, CSE61-R-DG, CSE62-L, CSE62-R, CSE62-R-DG, CSG11-L, CSG11-R, CSG11-R-DG, CSG12-L... (Other models you can see in the webshop)		

fittings

sleeves



Part No.	521282	Ref. No.	205296
description	sleeve thread 1/4" - 1/4" SS WS 17 total length 22mm		
For models:	CGE11-L, CGE11-R, CGE12-L, CGE12-R, CGE21-L, CGE21-R, CGE22-L, CGE22-R, CGE61-L, CGE61-R, CGE62-L, CGE62-R, CGG11-L, CGG11-R, CGG12-L, CGG12-R, CGG21-L, CGG21-R, CGG22-L, CGG22-R, CGG61-L, CGG61-R, CGG62-L, CGG62-R, CSE11-L, CSE11-R, CSE11-R-DG, CSE12-L, CSE12-R, CSE12-R-DG, CSE21-L, CSE21-R, CSE21-R-DG, CSE22-L, CSE22-R, CSE22-R-DG, CSE61-L, CSE61-R, CSE61-R-DG, CSE62-L, CSE62-R, CSE62-R-DG, CSG11-L, CSG11-R, CSG11-R-DG, CSG12-L, CSG12-R, CSG12-L, CSG21-R, CSG21-R-DG... (Other models you can see in the webshop)		

nickel-plated brass



Part No.	362019	Ref. No.	205298
description	screw pipe fitting straight nickel-plated brass thread 1/2" hose ø 8/10mm Qty 1 pcs		
For models:	CGE11-L, CGE11-R, CGE12-L, CGE12-R, CGE21-L, CGE21-R, CGE22-L, CGE22-R, CGE61-L, CGE61-R, CGE62-L, CGE62-R, CGG11-L, CGG11-R, CGG12-L, CGG12-R, CGG21-L, CGG21-R, CGG22-L, CGG22-R, CGG61-L, CGG61-R, CGG62-L, CGG62-R, CSE11-L, CSE11-R, CSE11-R-DG, CSE12-L, CSE12-R, CSE12-R-DG, CSE21-L, CSE21-R, CSE21-R-DG, CSE22-L, CSE22-R, CSE22-R-DG, CSE61-L, CSE61-R, CSE61-R-DG, CSE62-L, CSE62-R, CSE62-R-DG, CSG11-L, CSG11-R, CSG11-R-DG, CSG12-L, CSG12-R, CSG12-R-DG, CSG21-L, CSG21-R... (Other models you can see in the webshop)		



			
Part No.	362018	Ref. No.	205297
description	screw pipe fitting angled 90° nickel-plated brass thread 1/4" hose ø 8/10mm Qty 1 pcs		
For models:	CGE11-L, CGE11-R, CGE12-L, CGE12-R, CGE21-L, CGE21-R, CGE22-L, CGE22-R, CGE61-L, CGE61-R, CGE62-L, CGE62-R, CGG11-L, CGG11-R, CGG12-L, CGG12-R, CGG21-L, CGG21-R, CGG22-L, CGG22-R, CGG61-L, CGG61-R, CGG62-L, CGG62-R, CSE11-L, CSE11-R, CSE11-R-DG, CSE12-L, CSE12-R, CSE12-R-DG, CSE21-L, CSE21-R, CSE21-R-DG, CSE22-L, CSE22-R, CSE22-R-DG, CSE61-L, CSE61-R, CSE61-R-DG, CSE62-L, CSE62-R, CSE62-R-DG, CSG11-L, CSG11-R, CSG11-R-DG, CSG12-L, CSG12-R, CSG12-R-DG, CSG21-L, CSG21-R...(Other models you can see in the webshop)		

producer-specific			
MKN			
			
Part No.	541457	Ref. No.	201012
description	ball valve connection 1/2" ET		
For models:	14228011-0, 14228022-0, 1422802B04, 1422802B05, 1422802B06, 1422802B07, 1422802B08, 14228033-0, 14228044-0, 1422804B04, 1422804B05, 1422804B06, 1422804B07, 1422804B08, 14228055-0, 1422805B04, 1422805B05, 1422805B06, 1422805B07, 1422805B08, 1422807B00, 1422807B01, 1422807B02, 1422807B03, 1422807B04, 1422831-00, 1422832-00, 1422833-00, 1422834-00, 1422902-00, 1422902-01, 1422902-02, 1422902-03, 1422902-04, 1422908-00, 1422910-00, 1423901-00, 1423901-01, 1423901-02, 1423902-00, 1423902-01, 1423902-02, 1423903-00, 1423903-01, 1423903-02, 1462802B00, 1462802B01, 1462802B02, 1462802B03, 1462802B04...(Other models you can see in the webshop)		

valves and tank inlets

ball valves

universal

ball valves with butterfly handle

			
Part No.	542430	Ref. No.	201171
description	ball valve connection 3/4" IT - 3/4" IT DN20 PN 64 total length 78mm stainless steel		
For models:	0720325-03, 0720325-04, 0720325B03, 0720325B04, 0720332P00, 0720332R00, 0720332T00, 0720332V00, 1220321-00, 1220321-01, 1220321B00, 1220321B01, 1220325-00, 1220325-01, 1220325-02, 1220325B00, 1220325B01, 1220325B02, 1220327-00, 1220327-01, 1220327B01, 1220329-00, 1220329-01, 1220329B00, 1220329B01, 1220330-00, 1220330-01, 1220330B00, 1220330B01, 1320321-00, 1320321-01, 1320321-02, 1320321B00, 1320321B01, 1320321B02, 1320323-00, 1320323B00, 1320325-00, 1320325-01, 1320325-02, 1320325A00, 1320325A01, 1320325A02, 1320325B00, 1320325B01, 1320325B02, 1320325C00, 1320325C01, 1320325C02, 1320327-00...(Other models you can see in the webshop)		

gate valves

			
Part No.	520377	Ref. No.	201033 201071
description	gate valve connection 1" IT - 1" IT total length 51mm chrome-plated brass		
For models:	0220301D00, 0220302D00, 0220302E00, 0220302E01, 0220303D00, 0220303D01, 0220303E00, 0220303E01, 0260301-00, 0260301-01, 0260302-00, 0260302-01, 0720504-04, 1220301D00, 1220301D01, 1220301E00, 1220301E01, 1220302D00, 1220302E00, 1220303D00, 1220303D01, 1220303D02, 1220303E00, 1220303E01, 1220303E02, 1220303F01, 1220303F02, 1220303F03, 1220303H00, 1220303H01, 1220303H02, 1220303H03, 1220304D00, 1220304E00, 1220304F00, 1220304H00, 1220305D00, 1220305D01, 1220305D02, 1220305D03, 1220305D04, 1220305E00, 1220305E01, 1220305E02, 1220305E03, 1220305E04, 1220305F01, 1220305F02, 1220305F03, 1220305F04...(Other models you can see in the webshop)		

ball valves with lever handle

			
Part No.	514442	Ref. No.	201762
description	ball valve connection 1 1/2" IT - 1 1/2" IT total length 93mm with lever handle handle length 155mm		
For models:	1220402-00, 1220402-01, 1220504-01, 1222601-00, 1222603-00, 1320402-00, 1320402-01, 1320504-01, 1320504-02, 1322601-00, 1322603-00, 1322604-00, 1420402-00, 1420402-01, 1420403-00, 1420403-01, 1420403-02, 1420403B02, 1420509-01, 1422601-00, 1422602-00, 1520402-00, 1520402-01, 1520403-00, 1520403-01, 1522603-00, 1522603-01, 2020402-00, 2020402-01, 2020403-00, 2020403-01, 2020506-01, 2022601-00, 2022601-01, 2022603-00, 2022604-00, 2120402-00, 2120402-01, 2120403-00, 2120504-01, 2122601-00, 2122601-01, 2122602-00, 2122604-00, 2220403-00, 2220403-01, 2220403-02, 2222608-02, 2420403-00, 2420403-01...(Other models you can see in the webshop)		



shut-off valves

universal



Part No.	514482	Ref. No.	201077
description	shut-off valve connection 1/2" tap head 1/2" cold/warm total length 45mm		
For models:	1320401-00, 1320401-01, 1420401-00, 1420401-01, 1420405-00, 14228011-0, 14228022-0, 14228033-0, 14228044-0, 14228055-0, 2020401-00, 2020401-01, 2022801-00, 2022801-01, 20228011-0, 20228011-1, 2022801A00, 2022801A01, 2022801B00, 2022801B01, 2022801C00, 2022801C01, 2022802-00, 2022802-01, 20228022-0, 20228022-1, 2022802A00, 2022802A01, 2022802B00, 2022802B01, 2022802C00, 2022802C01, 2022803-00, 2022803-01, 20228033-0, 20228033-1, 2022803A00, 2022803A01, 2022803B00, 2022803B01, 2022803C00, 2022803C01, 2022804-00, 2022804-01, 20228044-0, 20228044-1, 2022804A00, 2022804A01, 2022804B00, 2022804B01... (Other models you can see in the webshop)		
spare parts for	514482		
	Part No.	547951	Ref. No. —
	tap head connection 3/4" without handle total lengthmm		

spare parts for	541544		
	Part No.	541557	Ref. No. —
	tap head chrome-plated thread 1 1/4" for steam tap 1"		

tank inlets



Part No.	691607	Ref. No.	201006
description	tank inlet connection 1/2" WS 34 L1 20mm L2 34mm with non-return valve		
For models:	1320401-00, 1320401-01, 1420401-00, 1420401-01, 1420405-00, 2020401-00, 2020401-01, 2120401-00, 2120401-01		

water cycle components





supply filters



Part No.	692893	Ref. No.	201134
description	screen H 14mm ø 19.5mm plastic		
For models:	1422807B03, 1422807B04, 1422831-00, 1422832-00, 1422833-00, 1422834-00, 1422902-03, 1422902-04, 1422908-00, 1422910-00, 1423901-00, 1423901-01, 1423901-02, 1423902-00, 1423902-01, 1423902-02, 1423903-00, 1423903-01, 1423903-02, 1462831-00, 1462832-00, 1462833-00, 1462834-00, 1462835-00, 1462836-00, 1462837-00, 1462838-00, 1462839-00, 1462840-00, 1462908-00, 1462910-00, 2022802B08, 2022802B09, 2022802B10, 2022802C08, 2022802C09, 2022802C10, 2022802D00, 2022802D01, 2022802D02, 2022804B08, 2022804B09, 2022804B10, 2022804C08, 2022804C09, 2022804C10, 2022804D00, 2022804D01, 2022804D02, 2022805B08... (Other models you can see in the webshop)		

steam valves



Part No.	541544	Ref. No.	201052
description	steam valve angled connection 1" IT - 1" ET total length 82mm H 136mm brass		
For models:	1412831-00, 1412832-00, 1412833-00, 1412834-00, 1412908-00, 1412910-00, 2012801-00, 2012801-01, 2012801A00, 2012801A01, 2012801B00, 2012801B01, 2012801C00, 2012801C01, 2012802-00, 2012802-01, 2012802A00, 2012802A01, 2012802B00, 2012802B01, 2012802B02, 2012802B03, 2012802B04, 2012802B05, 2012802B06, 2012802B07, 2012802C00, 2012802C01, 2012803-00, 2012803-01, 2012803A00, 2012803A01, 2012803B00, 2012803B01, 2012803C00, 2012803C01, 2012804-00, 2012804-01, 2012804A00, 2012804A01, 2012804B00, 2012804B01, 2012804B02, 2012804B03, 2012804B04, 2012804B05, 2012804B06, 2012804B07, 2012804C00, 2012804C01... (Other models you can see in the webshop)		
spare parts for	541544		
	Part No.	540229	Ref. No. —
	star handle shaft 9x9mm ø 80mm L 23mm black thermoplastic		
	Part No.	541546	Ref. No. —
	screw chrome-plated brass thread M5 thread L 10mm		
	Part No.	541548	Ref. No. —
	gasket PTFE ID ø 15mm H 7mm for thread 1 1/4" ED ø 35mm		
	Part No.	541554	Ref. No. —
	gasket copper ext. ø 49 ID ø 42mm H 2mm for thread 1 1/4"		

ancillary products

clamps

hose clamps

DIN 3017 - W2



Part No.	520113	Ref. No.	208045 W1 Stahl verzinkt 1 Stk
description	hose clamp ø 16-27mm width 9mm Qty 10 pcs DIN 3017		



DIN 3017 - W4



Part No.	520120	Ref. No.	208049
description	hose clamp SS W4 ø 12-20mm width 9mm Qty 1 pcs DIN 3017		
For models:	CCE60, CCE63, CGE11-L, CGE11-R, CGE12-L, CGE12-R, CGE21-L, CGE21-R, CGE22-L, CGE22-R, CGE61-L, CGE61-R, CGE62-L, CGE62-R, CGG11-L, CGG11-R, CGG12-L, CGG12-R, CGG21-L, CGG21-R, CGG22-L, CGG22-R, CGG61-L, CGG61-R, CGG62-L, CGG62-R, CPE60, CPE63, CSE11-L, CSE11-R, CSE11-R-DG, CSE12-L, CSE12-R, CSE12-R-DG, CSE21-L, CSE21-R, CSE21-R-DG, CSE22-L, CSE22-R, CSE22-R-DG, CSE61-L, CSE61-R, CSE61-R-DG, CSE62-L, CSE62-R, CSE62-R-DG, CSG11-L, CSG11-R, CSG11-R-DG, CSG12-L...(Other models you can see in the webshop)		

tools

hand tools

screwdrivers

nut spinners



Part No.	801436	Ref. No.	204206
description	nut spinner size 6x6mm total length 213mm blade length 125mm square		
For models:	0220301-00, 0220301B00, 0220301B01, 0220301B02, 0220302-00, 0220302A00, 0220302A01, 0220302A02, 0220302A03, 0220302B00, 0220302B01, 0220302B02, 0220302C00, 0220302C01, 0220302C02, 0220302C03, 0220302F00, 0220303-00, 0220303-01, 0220303A00, 0220303A01, 0220303A02, 0220303A03, 0220303B00, 0220303B01, 0220303C00, 0220303C01, 0220303C02, 0220304-00, 0220305-00, 0220306-00, 0220501-00, 0220502-00, 0220503-00, 0220802-00, 0221501-00, 0221502-00, 0260301-00, 0260301-01, 0260302-00, 0260302-01, 0260501-00, 0520303-00, 0520303-01, 0520303-02, 1020510-00, 1022603-00, 1220301-00, 1220301-01, 1220301-02...(Other models you can see in the webshop)		

measuring equipment

thermometers

built-in thermometers



Part No.	541411	Ref. No.	201562
description	thermometer mounting measurements 58x25.5mm 0 up to +250°C capillary pipe 2100mm probe ø 6mm probe L 200mm		
For models:	0260301-00, 0260301-01, 0260302-00, 0260302-01, 1260301-00, 1260301-01, 1260302-00, 1260302-01, 1460302-00, 1460302-01, 1460302-02, 2020303-00, 2020303-01, 2020303-02, 2020303-03, 2020303-04, 2020303A00, 2020310-00, 2020310-01, 2020310-02, 2020310-03, 2020310A00, 2020310A01, 2020310A02, 2020310A03, 2020311-00, 2020311-01, 2020311-02, 2020311-03, 2020311A00, 2020311A01, 2020311A02, 2020311A03, 2020339A00, 2020339A01, 2020340A00, 2020340A01, 2060301-00, 2060301-01, 2060301-02, 3020310-00, 3020310-01, 3020310A00, 3020310A01, 3020311-00, 3020311-01, 3020311A00, 3020311A01		

fastening material

rivets/rivet nuts

blind rivet nuts hexagonal



Part No.	551382	Ref. No.	208039
description	rivet nut thread M8 DN 11mm L 16.4mm SS Qty 1 pcs		
For models:	CGE11-L, CGE11-R, CGE12-L, CGE12-R, CGE21-L, CGE21-R, CGE22-L, CGE22-R, CGE61-L, CGE61-R, CGE62-L, CGE62-R, CGG11-L, CGG11-R, CGG12-L, CGG12-R, CGG21-L, CGG21-R, CGG22-L, CGG22-R, CGG61-L, CGG61-R, CGG62-L, CGG62-R, CSE11-L, CSE11-R, CSE11-R-DG, CSE12-L, CSE12-R, CSE12-R-DG, CSE21-L, CSE21-R, CSE21-R-DG, CSE22-L, CSE22-R, CSE22-R-DG, CSE61-L, CSE61-R, CSE61-R-DG, CSE62-L, CSE62-R, CSE62-R-DG, CSG11-L, CSG11-R, CSG11-R-DG, CSG12-L, CSG12-R, CSG12-R-DG, CSG21-L, CSG21-R...(Other models you can see in the webshop)		

screws

sheet metal screws



Part No.	560102	Ref. No.	111202
description	sheet metal screws ø 3.9mm L 9.5mm SS Qty 20 pcs DIN 7981/ISO 7049 head ø 7.5mm oval head		

countersunk screws



Part No.	560263	Ref. No.	105470
description	countersunk screw thread M4 L 25mm SS DIN 963/ISO 2009 Qty 20 pcs intake slotted head ø 7.5mm		
For models:	CGE21-L, CGE21-R, CGE22-L, CGE22-R, CGG11-L, CGG11-R, CGG12-L, CGG12-R, CGG21-L, CGG21-R, CGG22-L, CGG22-R, CGG61-L, CGG61-R, CGG62-L, CGG62-R, CSE21-L, CSE21-R, CSE21-R-DG, CSE22-L, CSE22-R, CSE22-R-DG, CSG11-L, CSG11-R, CSG11-R-DG, CSG12-L, CSG12-R, CSG12-R-DG, CSG21-L, CSG21-R, CSG21-R-DG, CSG22-L, CSG22-R, CSG22-R-DG, CSG61-L, CSG61-R, CSG61-R-DG, CSG62-L, CSG62-R, CSG62-R-DG		





Part No.	560425	Ref. No.	105466
description	countersunk screw thread M4 L 13mm stainless steel DIN 965/ISO 7046 Qty 1 pcs head ø 7.5mm		



flat-headed bolts

			
1			
Part No.	560635	Ref. No.	105008
description	flat-headed bolt thread M3 thread L 6mm with plain washer		
For models:	CCE60, CCE63, CGE11-L, CGE11-R, CGE12-L, CGE12-R, CGE21-L, CGE21-R, CGE22-L, CGE22-R, CGE61-L, CGE61-R, CGE62-L, CGE62-R, CGG11-L, CGG11-R, CGG12-L, CGG12-R, CGG21-L, CGG21-R, CGG22-L, CGG22-R, CGG61-L, CGG61-R, CGG62-L, CGG62-R, CPE60, CPE63, CSE11-L, CSE11-R, CSE11-R-DG, CSE12-L, CSE12-R, CSE12-R-DG, CSE21-L, CSE21-R, CSE21-R-DG, CSE22-L, CSE22-R, CSE22-R-DG, CSE61-L, CSE61-R, CSE61-R-DG, CSE62-L, CSE62-R, CSE62-R-DG, CSG11-L, CSG11-R, CSG11-R-DG, CSG12-L...(Other models you can see in the webshop)		

			
1			
Part No.	560626	Ref. No.	105001
description	flat-headed bolt thread M4 thread L 8mm head ø 8mm head thickness 3mm torx		
For models:	0021130A00, 0021130A01, 0021135A00, 0220601-00, 0521704-06, 0521704-07, 0521705-01, 0720325-03, 0720325-04, 0720325B03, 0720325B04, 0720332P00, 0720332R00, 0720332T00, 0720332V00, 0721134-01, 0721134A01, 0721172A01, 0721173A01, 0721174A01, 0721175A01, 0723104-03, 0723104A03, 0723104B03, 0723105-03, 0723105A03, 0723105B03, 0723405-01, 0723405-02, 0723409-01, 0723409-02, 0723412K01, 0723413-02, 0723414-02, 1003601-00, 1003602-00, 1020510-00, 1021130A00, 1021135A00, 1022512-00, 1022603-00, 1023101-00, 1023101-01, 1023106-00, 1023106-01, 1023111-00, 1023111-01, 1023401-00, 1023401K00, 1023410-00...(Other models you can see in the webshop)		

			
1			
Part No.	511004	Ref. No.	105115
description	flat-headed bolt thread M4 thread L 12mm SS DIN 84/ISO 1207 Qty 1 pcs intake slotted L 14.5mm		
For models:	0120101-00, 0120101-01, 0120101-02, 0120101-03, 0120101-04, 0120101C00, 0120101D00, 0120101D01, 0120101D02, 0120101D04, 0120105-00, 0120105-01, 0120105-02, 0120105-03, 0120105-04, 0120105C00, 0120105D00, 0120105D01, 0120105D02, 0120105D04, 0120201-00, 0120201-01, 0220301-00, 0220301B00, 0220301B01, 0220301B02, 0220301D00, 0220302-00, 0220302A00, 0220302A01, 0220302A02, 0220302A03, 0220302B00, 0220302B01, 0220302B02, 0220302C00, 0220302C01, 0220302C02, 0220302C03, 0220302D00, 0220302E00, 0220302E01, 0220302F00, 0220302H00, 0220302H01, 0220303-00, 0220303-01, 0220303A00, 0220303A01, 0220303A02...(Other models you can see in the webshop)		

			
1			
Part No.	560454	Ref. No.	105121
description	flat-headed bolt thread M4 thread L 22mm SS DIN 84/ISO 1207 Qty 1 pcs intake slotted head ø 7mm head thickness 2.5mm		
For models:	0220301-00, 0220301B00, 0220301B01, 0220301B02, 0220301D00, 0220302-00, 0220302A00, 0220302A01, 0220302A02, 0220302A03, 0220302B00, 0220302B01, 0220302B02, 0220302C00, 0220302C01, 0220302C02, 0220302C03, 0220302D00, 0220302E00, 0220302E01, 0220302F00, 0220303-00, 0220303-01, 0220303A00, 0220303A01, 0220303A02, 0220303A03, 0220303B00, 0220303B01, 0220303C00, 0220303C01, 0220303C02, 0220303D00, 0220303D01, 0220303E00, 0220303E01, 0220304-00, 0220305-00, 0220306-00, 0521704-0, 0521704-03, 0521704-04, 0521704-05, 0521704-06, 0521704-07, 0521704A01, 0521705-01, 1424814-01, 1424814A00, 1424815-01...(Other models you can see in the webshop)		

raised countersunk head screws

			
1			
Part No.	560627	Ref. No.	105466
description	raised countersunk head screw thread M4 thread L 12mm SS DIN 966/ISO 7047 Qty 1 pcs head thickness 3mm		
For models:	CCE60, CCE63, CGE11-L, CGE11-R, CGE12-L, CGE12-R, CGE21-L, CGE21-R, CGE22-L, CGE22-R, CGE61-L, CGE61-R, CGE62-L, CGE62-R, CGG11-L, CGG11-R, CGG12-L, CGG12-R, CGG21-L, CGG21-R, CGG22-L, CGG22-R, CGG61-L, CGG61-R, CGG62-L, CGG62-R, CPE60, CPE63, CSE11-L, CSE11-R, CSE11-R-DG, CSE12-L, CSE12-R, CSE12-R-DG, CSE21-L, CSE21-R, CSE21-R-DG, CSE22-L, CSE22-R, CSE22-R-DG, CSE61-L, CSE61-R, CSE61-R-DG, CSE62-L, CSE62-R, CSE62-R-DG, CSG11-L, CSG11-R, CSG11-R-DG, CSG12-L...(Other models you can see in the webshop)		

			
1			
Part No.	560634	Ref. No.	105471
description	raised countersunk head screw thread M4 thread L 40mm SS Qty 1 pcs intake slotted head ø 7.3mm		
For models:	CGE11-L, CGE11-R, CGE12-L, CGE12-R, CGE21-L, CGE21-R, CGE22-L, CGE22-R, CGE61-L, CGE61-R, CGE62-L, CGE62-R, CGG11-L, CGG11-R, CGG12-L, CGG12-R, CGG21-L, CGG21-R, CGG22-L, CGG22-R, CGG61-L, CGG61-R, CGG62-L, CGG62-R, CPE60, CPE63, CSE11-L, CSE11-R, CSE11-R-DG, CSE12-L, CSE12-R, CSE12-R-DG, CSE21-L, CSE21-R, CSE21-R-DG, CSE22-L, CSE22-R, CSE22-R-DG, CSE61-L, CSE61-R, CSE61-R-DG, CSE62-L, CSE62-R, CSE62-R-DG, CSG11-L, CSG11-R, CSG11-R-DG, CSG12-L, CSG12-R, CSG12-R-DG, CSG21-L, CSG21-R...(Other models you can see in the webshop)		

hexagonal screws

			
1			
Part No.	560311	Ref. No.	101451
description	hexagonal screw thread M10 thread L 20mm SS W5 17 Qty 1 pcs DIN 933 / ISO 4017		
For models:	CCE60, CGE11-L, CGE11-R, CGE12-L, CGE12-R, CGE21-L, CGE21-R, CGE22-L, CGE22-R, CGE61-L, CGE61-R, CGE62-L, CGE62-R, CGG11-L, CGG11-R, CGG12-L, CGG12-R, CGG21-L, CGG21-R, CGG22-L, CGG22-R, CGG61-L, CGG61-R, CGG62-L, CGG62-R, CPE60, CSE11-L, CSE11-R, CSE11-R-DG, CSE12-L, CSE12-R, CSE12-R-DG, CSE21-L, CSE21-R, CSE21-R-DG, CSE22-L, CSE22-R, CSE22-R-DG, CSE61-L, CSE61-R, CSE61-R-DG, CSE62-L, CSE62-R, CSE62-R-DG, CSG11-L, CSG11-R, CSG11-R-DG, CSG12-L, CSG12-R, CSG12-R-DG...(Other models you can see in the webshop)		



			
1			
Part No.	560081	Ref. No.	101412
description	hexagonal screw thread M4 thread L 10mm SS WS 7 Qty 20 pcs DIN 933 / ISO 4017		
For models:	0021130A00, 0021130A01, 0021135A00, 0120101-01, 0120101-02, 0120101-03, 0120101-04, 0120101D00, 0120101D01, 0120101D02, 0120101D04, 0120105-01, 0120105-02, 0120105-03, 0120105-04, 0120105D00, 0120105D01, 0120105D02, 0120105D04, 0221107-00, 0221107A00, 0221108-00, 0221109-00, 0221109A00, 0221110-00, 0263401-00, 0520302-01, 0520302-02, 0520302A00, 0520302A01, 0521702A03, 0521702A04, 0521704-00, 0521704-01, 0521704-02, 0521704-03, 0521704-04, 0521704-05, 0521704-06, 0521704-07, 0521704A00, 0521704A01, 0521705-00, 0521705-01, 0521706-00, 0522101-00, 0522101-01, 0522101-02, 0522101-03, 0522101-04... (Other models you can see in the webshop)		

			
1			
Part No.	560086	Ref. No.	101405
description	hexagonal screw thread M6 thread L 10mm SS WS 10 Qty 20 pcs DIN 933 / ISO 4017		

			
1			
Part No.	550682	Ref. No.	101435
description	hexagonal screw thread M8 thread L 20mm SS WS 13 Qty 1 pcs DIN 933 / ISO 4017		
For models:	CCE60, CCE63, CGE11-L, CGE11-R, CGE12-L, CGE12-R, CGE21-L, CGE21-R, CGE22-L, CGE22-R, CGE61-L, CGE61-R, CGE62-L, CGE62-R, CGG11-L, CGG11-R, CGG12-L, CGG12-R, CGG21-L, CGG21-R, CGG22-L, CGG22-R, CGG61-L, CGG61-R, CGG62-L, CGG62-R, CPE60, CPE63, CSE11-L, CSE11-R, CSE11-R-DG, CSE12-L, CSE12-R, CSE12-R-DG, CSE21-L, CSE21-R, CSE21-R-DG, CSE22-L, CSE22-R, CSE22-R-DG, CSE61-L, CSE61-R, CSE61-R-DG, CSE62-L, CSE62-R, CSE62-R-DG, CSG11-L, CSG11-R, CSG11-R-DG, CSG12-L... (Other models you can see in the webshop)		

			
2			
Part No.	560080	Ref. No.	101127
description	hexagonal screw thread M4 thread L 8mm SS WS 7 Qty 20 pcs DIN 933 / ISO 4017		
For models:	0263401-01, 0522101-02, 0522101-03, 0522102-02, 0522102-03, 0720325-03, 0720325-04, 0720325B03, 0720325B04, 1220301-00, 1220301-01, 1220301-02, 1220301-03, 1220301-04, 1220301B00, 1220301B01, 1220301B02, 1220301B03, 1220301B04, 1220301D00, 1220301D01, 1220301E00, 1220301E01, 1220301J00, 1220301J01, 1220301J02, 1220301J03, 1220302-00, 1220302-01, 1220302B00, 1220302B01, 1220302D00, 1220302E00, 1220303-00, 1220303-01, 1220303-02, 1220303-03, 1220303-04, 1220303-05, 1220303A00, 1220303A01, 1220303A02, 1220303A03, 1220303B00, 1220303B01, 1220303B02, 1220303B03, 1220303B04, 1220303B05, 1220303C00... (Other models you can see in the webshop)		

cylinder head bolts

DIN 912/ISO 4762

			
1			
Part No.	560305	Ref. No.	102008
description	cylinder head bolt thread M5 thread L 16mm WS 4 intake internal hexagon DIN 912/ISO 4762		
For models:	0720325-03, 0720325-04, 0720325B03, 0720325B04, 0720332P00, 0720332R00, 0720332T00, 0720332V00, 1220301-00, 1220301-01, 1220301-02, 1220301-03, 1220301-04, 1220301B00, 1220301B01, 1220301B02, 1220301B03, 1220301B04, 1220301D00, 1220301D01, 1220301E00, 1220301E01, 1220301J00, 1220301J01, 1220301J02, 1220301J03, 1220302-00, 1220302-01, 1220302B00, 1220302B01, 1220302D00, 1220302E00, 1220303-00, 1220303-01, 1220303-02, 1220303-03, 1220303-04, 1220303-05, 1220303A00, 1220303A01, 1220303A02, 1220303A03, 1220303B00, 1220303B01, 1220303B02, 1220303B03, 1220303B04, 1220303B05, 1220303C00, 1220303C01... (Other models you can see in the webshop)		

			
1			
Part No.	560083	Ref. No.	101125
description	hexagonal screw thread M5 thread L 10mm SS WS 8 Qty 20 pcs DIN 933 / ISO 4017		
For models:	0021130A00, 0021130A01, 0021135A00, 0263401-00, 0263401-01, 0521704-0, 0521704-00, 0521704-01, 0521704-02, 0521704-03, 0521704-04, 0521704-05, 0521704-06, 0521704-07, 0521704A00, 0521704A01, 0521705-00, 0521705-01, 0521706-00, 1121117-00, 1121117-01, 1121117A00, 1121118-00, 1121118-01, 1121119-00, 1121119A00, 1121120-00, 1121121-00, 1121121A00, 1121135A01, 1203603-00, 1204012-00, 1204012-01, 1204014-00, 1204014-01, 1204015-00, 1204015-01, 1204017-00, 1204017-01, 1204018-00, 1204018-01, 1204019-00, 1204019-01, 1220301-00, 1220301B00, 1220301D00, 1220301E00, 1220302-00, 1220302-01, 1220302B00... (Other models you can see in the webshop)		

			
1			
Part No.	520455	Ref. No.	102050
description	screw thread M8 thread L 20mm WS 6 SS Qty 1 pcs DIN 912/ISO 4762		
For models:	CGE11-L, CGE11-R, CGE12-L, CGE12-R, CGE61-L, CGE61-R, CGE62-L, CGE62-R, CGG11-L, CGG11-R, CGG12-L, CGG12-R, CGG61-L, CGG61-R, CGG62-L, CGG62-R, CSE11-L, CSE11-R, CSE11-R-DG, CSE12-L, CSE12-R, CSE12-R-DG, CSE61-L, CSE61-R, CSE61-R-DG, CSE62-L, CSE62-R, CSE62-R-DG, CSG11-L, CSG11-R, CSG11-R-DG, CSG12-L, CSG12-R, CSG12-R-DG, CSG61-L, CSG61-R, CSG61-R-DG, CSG62-L, CSG62-R, CSG62-R-DG		

			
1			
Part No.	560084	Ref. No.	101403
description	hexagonal screw thread M5 thread L 8mm SS WS 8 Qty 20 pcs DIN 933 / ISO 4017		
For models:	CCE60, CCE63, CGG11-L, CGG11-R, CGG12-L, CGG12-R, CGG21-L, CGG21-R, CGG22-L, CGG22-R, CGG61-L, CGG61-R, CGG62-L, CGG62-R, CPE60, CPE63, CSG11-L, CSG11-R, CSG11-R-DG, CSG12-L, CSG12-R, CSG12-R-DG, CSG21-L, CSG21-R, CSG21-R-DG, CSG22-L, CSG22-R, CSG22-R-DG, CSG61-L, CSG61-R, CSG61-R-DG, CSG62-L, CSG62-R, CSG62-R-DG		



side bolts

 <p>1</p>			
Part No.	560051	Ref. No.	118005
description	side bolts thread M4 L 16mm SS Qty 20 pcs intake slotted head ø 10mm		
For models:	0021130A00, 0021130A01, 0021135A00, 0120101-00, 0120101-01, 0120101-02, 0120101-03, 0120101-04, 0120101C00, 0120101D00, 0120101D01, 0120101D02, 0120101D04, 0120105-00, 0120105-01, 0120105-02, 0120105-03, 0120105-04, 0120105C00, 0120105D00, 0120105D01, 0120105D02, 0120105D04, 0120202-00, 0120202-01, 0120203-00, 0120203-01, 0203601-00, 0203602-00, 0203603-00, 0204601-00, 0220301-00, 0220301B00, 0220301B01, 0220301B02, 0220301D00, 0220302-00, 0220302A00, 0220302A01, 0220302A02, 0220302A03, 0220302B00, 0220302B01, 0220302B02, 0220302C00, 0220302C01, 0220302C02, 0220302C03, 0220302D00, 0220302E00... (Other models you can see in the webshop)		

 <p>1</p>			
Part No.	560053	Ref. No.	118009
description	side bolts thread M5 L 16mm SS Qty 20 pcs intake slotted head ø 12.5mm		
For models:	1203603-00, 1204012-00, 1204014-00, 1204015-00, 1204017-00, 1204018-00, 1204019-00, 1303703-00, 1303703-01, 1420309A01, 1420309A02, 1420309A03, 1420309C01, 1420309C02, 1420309C03, 1420310A01, 1420310A02, 1420310A03, 1420310A04, 1420310A05, 1420310C01, 1420310C02, 1420310C03, 1420310C04, 1420310C05, 1420325A00, 1420325A01, 1420325A02, 1420325A03, 1420325C00, 1420325C01, 1420325C02, 1420325C03, 1420327A00, 1420327A01, 1420327C00, 1420327C01, 1420329A00, 1420329A01, 1420329C00, 1420329C01, 1420330A00, 1420330A01, 1420330A02, 1420330A03, 1420330C00, 1420330C01, 1420330C02, 1420330C03, 1422807B00... (Other models you can see in the webshop)		

grub screws

miscellaneous

 <p>1</p>			
Part No.	560306	Ref. No.	110124
description	grub screw thread M6 L 10mm DIN 915 intake internal hexagon Qty 1 pcs		

nuts

cap nuts

 <p>1</p>			
Part No.	696820	Ref. No.	116064
description	cap nuts thread M10 IT WS 17 SS Qty 1 pcs DIN/ISO 917		
For models:	0522102-02, 0522102-03, 0522102-04, 14228011-0, 14228022-0, 14228033-0, 14228044-0, 14228055-0, 1462802B00, 1462804B00, 2012801-00, 2012801-01, 2012801A00, 2012801A01, 2012801B00, 2012801B01, 2012801C00, 2012801C01, 2012802-00, 2012802-01, 2012802A00, 2012802A01, 2012802B00, 2012802B01, 2012802C00, 2012802C01, 2012803-00, 2012803-01, 2012803A00, 2012803A01, 2012803B00, 2012803B01, 2012803C00, 2012803C01, 2012804-00, 2012804-01, 2012804A00, 2012804A01, 2012804B00, 2012804B01, 2012804C00, 2012804C01, 2012805-00, 2012805-01, 2012805A00, 2012805A01, 2012805B00, 2012805B01, 2012805C00, 2012805C01... (Other models you can see in the webshop)		

 <p>1</p>			
Part No.	696826	Ref. No.	116067
description	cap nuts thread M12 WS 19 SS Qty 1 pcs with bore		
For models:	CCE60, CCE63, CGE11-L, CGE11-R, CGE12-L, CGE12-R, CGE21-L, CGE21-R, CGE22-L, CGE22-R, CGE61-L, CGE61-R, CGE62-L, CGE62-R, CGG11-L, CGG11-R, CGG12-L, CGG12-R, CGG21-L, CGG21-R, CGG22-L, CGG22-R, CGG61-L, CGG61-R, CGG62-L, CGG62-R, CPE60, CPE63, CSE11-L, CSE11-R, CSE11-R-DG, CSE12-L, CSE12-R, CSE12-R-DG, CSE61-L, CSE61-R, CSE61-R-DG, CSE62-L, CSE62-R, CSE62-R-DG		

 <p>1</p>			
Part No.	696822	Ref. No.	116058
description	cap nuts thread M6 WS 10 SS Qty 1 pcs DIN/ISO 917		
For models:	0720332P00, 0720332R00, 0720332T00, 0720332V00, 1220301J02, 1220301J03, 1220303J03, 1220303J04, 1220303K00, 1220303K01, 1220305J03, 1220305J04, 1220305K02, 1220305K03, 1260302-00, 1260302-01, 1320401-01, 1420332P01, 1420332P02, 1420332P03, 1420332R00, 1420332R01, 1420332R02, 1420332R03, 1420332T01, 1420332T02, 1420332T03, 1420332V01, 1420332V02, 1420332V03, 1420333P01, 1420333P02, 1420333R00, 1420333R01, 1420333R02, 1420333T01, 1420333T02, 1420333V01, 1420333V02, 1420334P00, 1420334P01, 1420334P02, 1420334P03, 1420334P04, 1420334R02, 1420334R03, 1420334R04, 1420334T02, 1420334T03, 1420334T04... (Other models you can see in the webshop)		



hexagonal nuts

DIN 934 / ISO 4032/8673



1

Part No.	560223	Ref. No.	113081
description	hexagonal nut thread M3 H 2.4mm WS 5.5 SS DIN/ISO DIN 934 / ISO 4032/8673 Qty 1 pcs		
For models:	0120201-01, 0120202-00, 0120202-01, 0120203-00, 0120203-01, 0220303A00, 0220303A01, 0220303A02, 0220303A03, 0220303C00, 0220303C01, 0220303C02, 0220306-00, 0260302-00, 0260302-01, 0521706-00, 1220303A00, 1220303A01, 1220303A02, 1220303A03, 1220303C00, 1220303C01, 1220303C02, 1220303C03, 1220303F01, 1220303F02, 1220303F03, 1220303H00, 1220303H01, 1220303H02, 1220303H03, 1220304A00, 1220304A01, 1220304A02, 1220304C00, 1220304C01, 1220304C02, 1220304F00, 1220304F01, 1220304H00, 1220304H01, 1220305A00, 1220305A01, 1220305A02, 1220305A03, 1220305A04, 1220305A05, 1220305C00, 1220305C01, 1220305C02... (Other models you can see in the webshop)		



1

Part No.	560340	Ref. No.	113082
description	hexagonal nut thread M4 H 3.2mm WS 7 SS DIN/ISO DIN 934 / ISO 4032/8673 Qty 1 pcs		
For models:	0021130A00, 0021130A01, 0021135A00, 0120101-00, 0120101-01, 0120101-02, 0120101-03, 0120101-04, 0120101C00, 0120101D00, 0120101D01, 0120101D02, 0120101D04, 0120105-00, 0120105-01, 0120105-02, 0120105-03, 0120105-04, 0120105C00, 0120105D00, 0120105D01, 0120105D02, 0120105D04, 0120201-00, 0120201-01, 0120202-00, 0120202-01, 0120203-00, 0120203-01, 0203603-00, 0220301-00, 0220301B00, 0220301B01, 0220301B02, 0220301D00, 0220302-00, 0220302A00, 0220302A01, 0220302A02, 0220302A03, 0220302B00, 0220302B01, 0220302B02, 0220302C00, 0220302C01, 0220302C02, 0220302C03, 0220302D00, 0220302E00, 0220302E01... (Other models you can see in the webshop)		



1

Part No.	560129	Ref. No.	113087 113088
description	hexagonal nut thread M5 H 4mm WS 8 SS DIN/ISO DIN 934 / ISO 4032/8673 Qty 1 pcs		



1

Part No.	511212	Ref. No.	113091
description	hexagonal nut thread M6 H 5mm WS 10 SS DIN/ISO DIN 934 / ISO 4032/8673 Qty 1 pcs		
For models:	0021130A00, 0021130A01, 0021135A00, 0203601-00, 0203602-00, 0203603-00, 0204601-00, 0220301-00, 0220301B00, 0220301B01, 0220301B02, 0220301D00, 0220302-00, 0220302A00, 0220302A01, 0220302A02, 0220302A03, 0220302B00, 0220302B01, 0220302B02, 0220302C00, 0220302C01, 0220302C02, 0220302C03, 0220302D00, 0220302E00, 0220302E01, 0220302F00, 0220302H00, 0220302H01, 0220303-00, 0220303-01, 0220303A00, 0220303A01, 0220303A02, 0220303A03, 0220303B00, 0220303B01, 0220303C00, 0220303C01, 0220303C02, 0220303D00, 0220303D01, 0220303E00, 0220303E01, 0220303H00, 0220303H01, 0220304-00, 0220305-00, 0220306-00... (Other models you can see in the webshop)		



1

Part No.	560197	Ref. No.	113096
description	nut thread M10 H 8mm WS 17 SS DIN/ISO DIN 934 / ISO 4032/8673 Qty 1 pcs		
For models:	1220301J02, 1220301J03, 1220303J03, 1220303J04, 1220303K00, 1220303K01, 1220305J03, 1220305J04, 1220305K02, 1220305K03, 2013003B01, 2013003B02, 2013003B03, 2013003B04, 2013003B05, 2013003B06, 2013004B01, 2013004B02, 2013004B03, 2013004B04, 2013004B05, 2013007B01, 2013007B02, 2013007B03, 2013007B04, 2013007B05, 2013007B06, 2013008B01, 2013008B02, 2013008B03, 2013008B04, 2013008B05, 2013009B01, 2013009B02, 2013009B03, 2013009B04, 2013009B05, 2013009B06, 2013010B01, 2013010B02, 2013010B03, 2013010B04, 2013010B05, 2013017B00, 2013017B01, 2013017B02, 2013017B03, 2013017B04, 2013017B05, 2013018B00... (Other models you can see in the webshop)		



1

Part No.	517174	Ref. No.	113092
description	nut thread M8 H 6.5mm WS 13 SS DIN/ISO DIN 934 / ISO 4032/8673 Qty 1 pcs		
For models:	0261301-00, 0521704-00, 0521704-01, 0521704-02, 0521704-03, 0521704-04, 0521704-05, 0521704-06, 0521704-07, 0521704A00, 0521704A01, 0521705-00, 0521705-01, 0521706-00, 1223201-00, 1223201-01, 1223207-00, 1223207-01, 1261101-01, 1261101-02, 1261102-01, 1261102-02, 1323201-00, 1323201-01, 1323201-02, 1323207-00, 1323207-02, 1323208-00, 1323208-01, 1323208-03, 1323208-04, 1361101-01, 1361101-02, 1361101-03, 1361102-01, 1361102-02, 1361102-03, 1422802B04, 1422804B04, 1422805B04, 1422807B00, 1422902-00, 1424802-00, 1424802-01, 1424802-02, 1424808-00, 1424808-01, 1424808-02, 1424808-03, 1424809-00... (Other models you can see in the webshop)		

DIN 985





1

Part No.	560227	Ref. No.	116041
description	hexagonal nut thread M3 H 4mm SS WS 5.5 Qty 1 pcs self-locking		
For models:	CCE60, CCE63, CGE11-L, CGE11-R, CGE12-L, CGE12-R, CGE21-L, CGE21-R, CGE22-L, CGE22-R, CGE61-L, CGE61-R, CGE62-L, CGE62-R, CGG11-L, CGG11-R, CGG12-L, CGG12-R, CGG21-L, CGG21-R, CGG22-L, CGG22-R, CGG61-L, CGG61-R, CGG62-L, CGG62-R, CPE60, CPE63, CSE11-L, CSE11-R, CSE11-R-DG, CSE12-L, CSE12-R, CSE12-R-DG, CSE21-L, CSE21-R, CSE21-R-DG, CSE22-L, CSE22-R, CSE22-R-DG, CSE61-L, CSE61-R, CSE61-R-DG, CSE62-L, CSE62-R, CSE62-R-DG, CSG11-L, CSG11-R, CSG11-R-DG, CSG12-L... (Other models you can see in the webshop)		





			
1			
Part No.	560140	Ref. No.	113014 116042
description	hexagonal nut thread M4 H 4.8mm SS WS 7 Qty 20 pcs DIN/ISO DIN 985 self-locking		
For models:	CCE60, CCE63, CGE11-L, CGE11-R, CGE12-L, CGE12-R, CGE21-L, CGE21-R, CGE22-L, CGE22-R, CGE61-L, CGE61-R, CGE62-L, CGE62-R, CGG11-L, CGG11-R, CGG12-L, CGG12-R, CGG21-L, CGG21-R, CGG22-L, CGG22-R, CGG61-L, CGG61-R, CGG62-L, CGG62-R, CPE60, CPE63, CSE11-L, CSE11-R, CSE11-R-DG, CSE12-L, CSE12-R, CSE12-R-DG, CSE21-L, CSE21-R, CSE21-R-DG, CSE22-L, CSE22-R, CSE22-R-DG, CSE61-L, CSE61-R, CSE61-R-DG, CSE62-L, CSE62-R, CSE62-R-DG, CSG11-L, CSG11-R, CSG11-R-DG, CSG12-L, CSG12-R, CSG12-R-DG, CSG21-L, CSG21-R, CSG21-R-DG, CSG22-L, CSG22-R, CSG22-R-DG, CSG61-L, CSG61-R, CSG61-R-DG, CSG62-L, CSG62-R, CSG62-R-DG		

			
2			
Part No.	560141	Ref. No.	116061
description	hexagonal nut thread M5 H 5.4mm SS WS 8 Qty 20 pcs DIN/ISO DIN 985 self-locking		
For models:	CCE60, CCE63, CGG11-L, CGG11-R, CGG12-L, CGG12-R, CGG21-L, CGG21-R, CGG22-L, CGG22-R, CGG61-L, CGG61-R, CGG62-L, CGG62-R, CPE60, CPE63, CSG11-L, CSG11-R, CSG11-R-DG, CSG12-L, CSG12-R, CSG12-R-DG, CSG21-L, CSG21-R, CSG21-R-DG, CSG22-L, CSG22-R, CSG22-R-DG, CSG61-L, CSG61-R, CSG61-R-DG, CSG62-L, CSG62-R, CSG62-R-DG		

			
1			
Part No.	560142	Ref. No.	116063
description	hexagonal nut thread M6 H 6mm SS WS 10 Qty 20 pcs DIN/ISO DIN 985 self-locking		
For models:	CCE60, CCE63, CGE11-L, CGE11-R, CGE12-L, CGE12-R, CGE21-L, CGE21-R, CGE22-L, CGE22-R, CGE61-L, CGE61-R, CGE62-L, CGE62-R, CGG11-L, CGG11-R, CGG12-L, CGG12-R, CGG21-L, CGG21-R, CGG22-L, CGG22-R, CGG61-L, CGG61-R, CGG62-L, CGG62-R, CPE60, CPE63, CSE11-L, CSE11-R, CSE11-R-DG, CSE12-L, CSE12-R, CSE12-R-DG, CSE61-L, CSE61-R, CSE61-R-DG, CSE62-L, CSE62-R, CSE62-R-DG, CSG11-L, CSG11-R, CSG11-R-DG, CSG12-L, CSG12-R, CSG12-R-DG, CSG21-L, CSG21-R, CSG21-R-DG, CSG22-L, CSG22-R, CSG22-R-DG, CSG61-L, CSG61-R, CSG61-R-DG, CSG62-L, CSG62-R, CSG62-R-DG		

			
1			
Part No.	560143	Ref. No.	121124
description	hexagonal nut thread M8 H 8.5mm SS WS 13 Qty 20 pcs DIN/ISO DIN 985 self-locking		
For models:	2012827-00, 2012827-01, 2012827-02, 2012828-00, 2012828-01, 2012828-02, 2012828-03, 2012828-04, 2012828-05, 2012829-00, 2012829-01, 2012829-02, 2022827-00, 2022827-01, 2022828-01, 2022828-02, 2022828-03, 2022828-04, 2022828-05, 2022828-06, 2022829-00, 2022829-01, 2061603-00, 2061603-01, 2061603-02, 3012827-00, 3012827-01, 3012827-02, 3012828-00, 3012828-01, 3012828-02, 3012828-03, 3012828-04, 3012828-05, 3012829-00, 3012829-01, 3012829-02, 3022827-00, 3022827-01, 3022828-03, 3022828-04, 3022828-05, 3022828-06, 3022828-07, 3022829-00, 3022829-01, CCE60, CCE63, CGE11-L, CGE11-R...(Other models you can see in the webshop)		

			
1			
Part No.	560653	Ref. No.	113097
description	nut thread M12 H 6mm SS WS 19 Qty 1 pcs DIN/ISO 439		
For models:	CCE60, CCE63, CGE11-L, CGE11-R, CGE12-L, CGE12-R, CGE21-L, CGE21-R, CGE22-L, CGE22-R, CGE61-L, CGE61-R, CGE62-L, CGE62-R, CGG11-L, CGG11-R, CGG12-L, CGG12-R, CGG21-L, CGG21-R, CGG22-L, CGG22-R, CGG61-L, CGG61-R, CGG62-L, CGG62-R, CPE60, CPE63, CSE11-L, CSE11-R, CSE11-R-DG, CSE12-L, CSE12-R, CSE12-R-DG, CSE61-L, CSE61-R, CSE61-R-DG, CSE62-L, CSE62-R, CSE62-R-DG, CSG11-L, CSG11-R, CSG11-R-DG, CSG12-L, CSG12-R, CSG12-R-DG, CSG21-L, CSG21-R, CSG21-R-DG, CSG22-L, CSG22-R, CSG22-R-DG, CSG61-L, CSG61-R, CSG61-R-DG, CSG62-L, CSG62-R, CSG62-R-DG		

			
1			
hexagonal nuts metric (without norm)			
Part No.	521101	Ref. No.	113000
description	nut thread M14x1.5 H 5mm WS 19 SS Qty 1 pcs		
For models:	00217022-0, 0120101-00, 0120101-01, 0120101-02, 0120101-03, 0120101-04, 0120101C00, 0120101D00, 0120101D01, 0120101D02, 0120101D04, 0120105-00, 0120105-01, 0120105-02, 0120105-03, 0120105-04, 0120105C00, 0120105D00, 0120105D01, 0120105D02, 0120105D04, 0120201-00, 0120201-01, 0120202-00, 0120202-01, 0120203-00, 0120203-01, 0220301-00, 0220301B00, 0220301B01, 0220301B02, 0220301D00, 0220302-00, 0220302A00, 0220302A01, 0220302A02, 0220302A03, 0220302B00, 0220302B01, 0220302B02, 0220302C00, 0220302C01, 0220302C02, 0220302C03, 0220302D00, 0220302E00, 0220302E01, 0220302F00, 0220302H00, 0220302H01...		

			
1			
Part No.	102067	Ref. No.	201524
description	nut thread M8x1 H 3mm brass Qty 1 pcs type SEF 1		
For models:	0260301-00, 0260302-00, 0260501-00, 0261101-00, 0261101-01, 0261102-00, 0261102-01, 0261103-00, 0261103-01, 0261301-00, 0261601-00, 0263401-00, 0263401-01, 1263401-00, 1263402-00, 1263402-01, 1263402-02, 1263404-00, 1263404-01, 1263404-02, 1263405-00, 1263405-01, 1263413-02, 1263414-02, 1363401-00, 1363402-00, 1363402-01, 1363403-00, 1363403-01, 1363403-02, 1363403-03, 1363403-04, 1363403-05, 1363404-00, 1363404-01, 1363404-02, 1363404-03, 1363405-00, 1363405-01, 1363413-03, 1363415-05, 14621011-0, 1462831-00, 1462832-00, 1462833-00, 1462834-00, 1462835-00, 1462836-00, 1462837-00...		



miscellaneous



1

Part No.	560548	Ref. No.	208025
description	nut thread M4 Qty 1 pcs		
For models:	0021130A00, 0021130A01, 0021135A00, 0221107-00, 0221107A00, 0221108-00, 0221109-00, 0221109A00, 0221110-00, 0521702-01, 0521702-02, 0521702-03, 0521702-04, 0521702A02, 0521702A03, 0521702A04, 0521702B03, 0521702B04, 0521702C04, 0521704-04, 0521704-05, 0521704-06, 0521704-07, 0522101-03, 0522101-04, 0522102-03, 0522102-04, 0721134-01, 0721134A01, 0721172A01, 0721173A01, 0721174A01, 0721175A01, 0722101-06, 0723412K01, 1003601-00, 1003602-00, 1020510-00, 1021130A00, 1021135A00, 1022512-00, 1022603-00, 1023101-00, 1023101-01, 1023106-00, 1023106-01, 1023111-00, 1023111-01, 1023401-00, 1023401K00... (Other models you can see in the webshop)		

washers

spring rings



1

Part No.	560655	Ref. No.	121035
description	lock washer ID ø 10.5mm ext. ø 18.1mm max. spring steel DIN 127A Qty 1 pcs for thread M10		
For models:	1412831-00, 1412832-00, 1412833-00, 1412833-01, 1412834-00, 1412834-01, 1412908-00, 1412910-00, 1412910-01, 1422701-00, 1422701-01, 1422701-02, 1422701-03, 1422702-00, 1422702-01, 1422702-02, 1422702-03, 1422703-00, 1422703-01, 1422703-02, 1422704-00, 1422704-01, 1422704-02, 1422705-00, 1422705-01, 1422705-02, 1422706-00, 1422706-01, 1422706-02, 1422707-00, 1422707-01, 1422707-02, 1422708-00, 1422708-01, 1422708-02, 1422807B00, 1422807B01, 1422807B02, 1422807B03, 1422807B04, 1422831-00, 1422832-00, 1422833-00, 1422834-00, 1422902-00, 1422902-01, 1422902-02, 1422902-03, 1422902-04, 1422908-00... (Other models you can see in the webshop)		



1

Part No.	560657	Ref. No.	121030
description	lock washer ID ø 3.1mm ext. ø 6.2mm max. spring steel DIN 127A Qty 1 pcs for thread M3		
For models:	0120201-01, 0120202-00, 0120202-01, 0120203-00, 0120203-01, 0260302-00, 0260302-01, 0520303-02, 1420309A01, 1420309A02, 1420309C01, 1420309C02, 1420310A01, 1420310A02, 1420310A03, 1420310C01, 1420310C02, 1420310C03, 1424824-00, 1424824-01, 1462802B01, 1462802B02, 1462802B03, 1462802B04, 1462802B05, 1462804B01, 1462804B02, 1462804B03, 1462804B04, 1462804B05, 1462831-00, 1462832-00, 1462833-00, 1462834-00, 1462835-00, 1462836-00, 1462837-00, 1462838-00, 1462839-00, 1462840-00, 1462908-00, 1462910-00, 1463501-03, 1463501-04, 1463501-05, 2020301A01, 2020301A02, 2020301C01, 2020301C02, 2020302A01... (Other models you can see in the webshop)		



1

Part No.	560122	Ref. No.	121032
description	lock washer ID ø 5.2mm ED ø 9mm SS DIN127 Qty 20 pcs for thread M5		
For models:	0021130A00, 0021130A01, 0021135A00, 0221101-01, 0221101A01, 0221102-01, 0221103-01, 0221104-01, 0221104A01, 0221105-01, 0221106-01, 0261101-01, 0261102-01, 0261103-01, 0263401-00, 0263401-01, 0521704-0, 0521704-00, 0521704-01, 0521704-02, 0521704-03, 0521704-04, 0521704-05, 0521704-06, 0521704-07, 0521704A00, 0521704A01, 0521705-00, 0521705-01, 0521706-00, 0522101-00, 0522101-02, 0522101-03, 0522101-04, 0522102-00, 0522102-02, 0522102-03, 0522102-04, 0720325-03, 0720325-04, 0720325B03, 0720325B04, 0720332P00, 0720332R00, 0720332T00, 0720332V00, 0722101-06, 1023101-01, 1023106-01, 1023111-01... (Other models you can see in the webshop)		



1

Part No.	560656	Ref. No.	121034
description	lock washer ID ø 8.1mm ext. ø 14.8mm max. spring steel DIN 127A Qty 1 pcs for thread M8		
For models:	0120101-00, 0120101-01, 0120101-02, 0120101-03, 0120101C00, 0120101D00, 0120101D01, 0120101D02, 0120105-00, 0120105-01, 0120105-02, 0120105-03, 0120105C00, 0120105D00, 0120105D01, 0120105D02, 0521704-0, 0521704-00, 0521704-01, 0521704-02, 0521704-03, 0521704-04, 0521704-05, 0521704-06, 0521704-07, 0521704A00, 0521704A01, 0521705-00, 0521705-01, 0521706-00, 1223201-00, 1223201-01, 1223207-00, 1223207-01, 1323201-00, 1323201-01, 1323201-02, 1323207-00, 1323207-02, 1323208-00, 1323208-01, 1323208-03, 1323208-04, 1422701-00, 1422702-00, 1422802B04, 1422802B05, 1422804B04, 1422804B05, 1422805B04... (Other models you can see in the webshop)		

washers

DIN 125A





1

Part No.	560110	Ref. No.	120005
description	plain washer ID ø 3.2mm ED ø 7mm thickness 0.5mm SS Qty 20 pcs DIN 125A for thread M3		
For models:	0220302A03, 0220302C03, 0220302H01, 0220303A00, 0220303A01, 0220303A02, 0220303A03, 0220303C00, 0220303C01, 0220303C02, 0220303H01, 0220306-00, 0520303-02, 0521706-00, 1220303A00, 1220303A01, 1220303A02, 1220303A03, 1220303C00, 1220303C01, 1220303C02, 1220303C03, 1220303F01, 1220303F02, 1220303F03, 1220303H00, 1220303H01, 1220303H02, 1220303H03, 1220305A00, 1220305A01, 1220305A02, 1220305A03, 1220305A04, 1220305A05, 1220305C00, 1220305C01, 1220305C02, 1220305C03, 1220305C04, 1220305C05, 1220305F01, 1220305F02, 1220305F03, 1220305F04, 1220305F05, 1220305H00, 1220305H01, 1220305H02, 1220305H03... (Other models you can see in the webshop)		





			
1			
Part No.	560111	Ref. No.	120017
description	plain washer ID ø 4.3mm ED ø 9mm thickness 0.8mm SS Qty 20 pcs DIN 125A for thread M4		
For models:	0021130A00, 0021130A01, 0021135A00, 0120101-01, 0120101-02, 0120101-03, 0120101-04, 0120101D00, 0120101D01, 0120101D02, 0120101D04, 0120105-01, 0120105-02, 0120105-03, 0120105-04, 0120105D00, 0120105D01, 0120105D02, 0120105D04, 0203603-00, 0220301-00, 0220301B00, 0220301B01, 0220301B02, 0220301D00, 0220302-00, 0220302A00, 0220302A01, 0220302A02, 0220302A03, 0220302B00, 0220302B01, 0220302B02, 0220302C00, 0220302C01, 0220302C02, 0220302C03, 0220302D00, 0220302E00, 0220302E01, 0220302F00, 0220302H00, 0220302H01, 0220303-00, 0220303-01, 0220303A00, 0220303A01, 0220303A02, 0220303A03, 0220303B00... (Other models you can see in the webshop)		

			
1			
Part No.	560114	Ref. No.	120108
description	plain washer ID ø 8.4mm ED ø 16mm thickness 1.6mm SS Qty 20 pcs DIN 125A for thread M8		
For models:	0120101-00, 0120101-01, 0120101-02, 0120101-03, 0120101C00, 0120101D00, 0120101D01, 0120101D02, 0120105-00, 0120105-01, 0120105-02, 0120105-03, 0120105C00, 0120105D00, 0120105D01, 0120105D02, 0521704-0, 0521704-00, 0521704-01, 0521704-02, 0521704-03, 0521704-04, 0521704-05, 0521704-06, 0521704-07, 0521704A00, 0521704A01, 0521705-00, 0521705-01, 0521706-00, 1220402-00, 1220402-01, 1220504-01, 1222601-00, 1222603-00, 1223201-00, 1223201-01, 1223207-00, 1223207-01, 1261101-00, 1261101-01, 1261101-02, 1261102-00, 1261102-01, 1261102-02, 1320402-00, 1320402-01, 1320504-01, 1320504-02, 1322601-00... (Other models you can see in the webshop)		

			
2			
Part No.	560112	Ref. No.	120022
description	plain washer ID ø 5.3mm ED ø 10mm thickness 1mm SS Qty 20 pcs DIN 125A for thread M5		
For models:	0221101-01, 0221101A01, 0221102-01, 0221103-01, 0221104-01, 0221104A01, 0221105-01, 0221106-01, 0261101-01, 0261102-01, 0261103-01, 0521706-00, 0522101-00, 0522101-02, 0522101-03, 0522101-04, 0522102-00, 0522102-02, 0522102-03, 0522102-04, 0722101-06, 0723104-03, 0723104A03, 0723104B03, 0723105-03, 0723105A03, 0723105B03, 1203603-00, 1204001-00, 1204001-01, 1204002-00, 1204002-01, 1204003-00, 1204003-01, 1204004-00, 1204004-01, 1204005-00, 1204005-01, 1204006-00, 1204006-01, 1204007-00, 1204007-01, 1204008-00, 1204008-01, 1204009-00, 1204009-01, 1204012-01, 1204014-01, 1204015-01, 1204017-01... (Other models you can see in the webshop)		

DIN 9021			
			
1			
Part No.	560304	Ref. No.	945104
description	plain washer ID ø 10.5mm ED ø 25mm Qty 1 pcs for thread M9		

			
1			
Part No.	560303	Ref. No.	120030
description	plain washer ID ø 6.4mm ED ø 18mm Qty 1 pcs for thread M6		
For models:	0021130A00, 0021130A01, 0021135A00, 0220301-00, 0220301B00, 0220301B01, 0220301B02, 0220301D00, 0220302-00, 0220302A00, 0220302A01, 0220302A02, 0220302A03, 0220302B00, 0220302B01, 0220302B02, 0220302C00, 0220302C01, 0220302C02, 0220302C03, 0220302D00, 0220302E00, 0220302E01, 0220302F00, 0220302H00, 0220302H01, 0220303-00, 0220303-01, 0220303A00, 0220303A01, 0220303A02, 0220303A03, 0220303B00, 0220303B01, 0220303C00, 0220303C01, 0220303C02, 0220303D00, 0220303D01, 0220303E00, 0220303E01, 0220303H00, 0220303H01, 0261101-01, 0261102-01, 0261103-01, 0263401-00, 0263401-01, 0521701-00, 0521701-01... (Other models you can see in the webshop)		

			
1			
Part No.	560333	Ref. No.	120027
description	plain washer ID ø 6.4mm ED ø 12mm thickness 1.6mm SS Qty 1 pcs DIN 125A for thread M6		
For models:	0021130A00, 0021130A01, 0021135A00, 0203601-00, 0203602-00, 0203603-00, 0204601-00, 0220301-00, 0220301B00, 0220301B01, 0220301B02, 0220301D00, 0220302-00, 0220302A00, 0220302A01, 0220302A02, 0220302A03, 0220302B00, 0220302B01, 0220302B02, 0220302C00, 0220302C01, 0220302C02, 0220302C03, 0220302D00, 0220302E00, 0220302E01, 0220302F00, 0220302H00, 0220302H01, 0220303-00, 0220303-01, 0220303A00, 0220303A01, 0220303A02, 0220303A03, 0220303B00, 0220303B01, 0220303C00, 0220303C01, 0220303C02, 0220303D00, 0220303D01, 0220303E00, 0220303E01, 0220303H00, 0220303H01, 0220304-00, 0220305-00, 0220306-00... (Other models you can see in the webshop)		

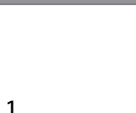
nylon			
			
1			
Part No.		Ref. No.	120007
description	plain washer ID ø 12.5mm ED ø 28mm thickness 3mm nylon Qty 1 pcs		
For models:	CCE60, CCE63, CPE60, CPE63		

			
1			
Part No.	560645	Ref. No.	120008
description	plain washer ID ø 7.4mm ED ø 14mm thickness 1.6mm SS Qty 1 pcs DIN 125A		
For models:	CCE60, CCE63, CGG11-L, CGG11-R, CGG12-L, CGG12-R, CGG21-L, CGG21-R, CGG22-L, CGG22-R, CGG61-L, CGG61-R, CGG62-L, CGG62-R, CPE60, CPE63, CSG11-L, CSG11-R, CSG11-R-DG, CSG12-L, CSG12-R, CSG12-R-DG, CSG21-L, CSG21-R, CSG21-R-DG, CSG22-L, CSG22-R, CSG22-R-DG, CSG61-L, CSG61-R, CSG61-R-DG, CSG62-L, CSG62-R, CSG62-R-DG		



tooth lock washers

DIN 6798A



Part No.	560125	Ref. No.	121023
description	tooth lock washer ID ø 4.2mm ED ø 8mm SS DIN/ISO DIN 6798A Qty 20 pcs for thread M4		
For models:	0720332P00, 0720332R00, 0720332T00, 0720332V00, 1220301-02, 1220301-03, 1220301-04, 1220301B02, 1220301B03, 1220301B04, 1220301J01, 1220301J03, 1220303-03, 1220303-04, 1220303-05, 1220303B03, 1220303B04, 1220303B05, 1220303I02, 1220303J02, 1220303J04, 1220303K01, 1220307-01, 1220326-01, 1220326B01, 1220327-00, 1220327-01, 1220327B01, 1220329-00, 1220329-01, 1220329B00, 1220329B01, 1220402-00, 1220402-01, 1320323-00, 1320323B00, 1320327-00, 1320327A01, 1320327A02, 1320327B00, 1320327C01, 1320327C02, 1320327Z00, 1320327Z01, 1320329-00, 1320329-01, 1320329A01, 1320329A02, 1320329B00, 1320329B01... (Other models you can see in the webshop)		

miscellaneous



Part No.	560654	Ref. No.	121210
description	tooth lock washer ID ø 12.5mm ED ø 20.5mm spring steel DIN/ISO 6797 Qty 1 pcs for thread M12		
For models:	0220501-00, 0220502-00, 0220503-00, 0220802-00, 0522101-00, 0522101-02, 0522101-03, 0522102-00, 0522102-02, 0522102-03, 1323208-00, 1323208-01, 1323208-02, 1323208-03, 1323210-00, 1323210-01, 1323210-02, 1363403-00, 1363403-01, 1363403-02, 1420501-00, 1420502-00, 1420504-00, 1420505-00, 1420801-00, 1420803-00, 1422101-00, 1422101-02, 1422101-03, 1422102-00, 1422102-02, 1422102-03, 14621011-0, 1820501-00, 18208011-0, 2020501-00, 2020501-01, 20205011-0, 2020502-00, 20205033-0, 2020504-00, 2020505-00, 2023203-00, 2023203-03, 2023203-04, 2023203-05, 2023203-06, 2023203A00, 2023203A03, 2023205-00... (Other models you can see in the webshop)		

fasteners

clamps

hose clamps

DIN 3017 - W2



Part No.	520113	Ref. No.	208045 W1 Stahl verzinkt 1 Stk
description	hose clamp ø 16-27mm width 9mm Qty 10 pcs DIN 3017		

DIN 3017 - W4



Part No.	520120	Ref. No.	208049
description	hose clamp SS W4 ø 12-20mm width 9mm Qty 1 pcs DIN 3017		
For models:	CCE60, CCE63, CGE11-L, CGE11-R, CGE12-L, CGE12-R, CGE21-L, CGE21-R, CGE22-L, CGE22-R, CGE61-L, CGE61-R, CGE62-L, CGE62-R, CGG11-L, CGG11-R, CGG12-L, CGG12-R, CGG21-L, CGG21-R, CGG22-L, CGG22-R, CGG61-L, CGG61-R, CGG62-L, CGG62-R, CPE60, CPE63, CSE11-L, CSE11-R, CSE11-R-DG, CSE12-L, CSE12-R, CSE12-R-DG, CSE21-L, CSE21-R, CSE21-R-DG, CSE22-L, CSE22-R, CSE22-R-DG, CSE61-L, CSE61-R, CSE61-R-DG, CSE62-L, CSE62-R, CSE62-R-DG, CSG11-L, CSG11-R, CSG11-R-DG, CSG12-L... (Other models you can see in the webshop)		

miscellaneous



Part No.	521185	Ref. No.	208065
description	hose clamp ø 50-70mm width 12mm Qty 1 pcs		
For models:	815156, 815157, 815166, 815167, CCE60, CCE63, CGE11-L, CGE11-R, CGE12-L, CGE12-R, CGE21-L, CGE21-R, CGE22-L, CGE22-R, CGE61-L, CGE61-R, CGE62-L, CGE62-R, CGG11-L, CGG11-R, CGG12-L, CGG12-R, CGG21-L, CGG21-R, CGG22-L, CGG22-R, CGG61-L, CGG61-R, CGG62-L, CGG62-R, CPE60, CPE63, CSE11-L, CSE11-R, CSE11-R-DG, CSE12-L, CSE12-R, CSE12-R-DG, CSE21-L, CSE21-R, CSE21-R-DG, CSE22-L, CSE22-R, CSE22-R-DG, CSE61-L, CSE61-R, CSE61-R-DG, CSE62-L, CSE62-R, CSE62-R-DG... (Other models you can see in the webshop)		

roll pins



Part No.	696825	Ref. No.	123004
description	roll pin ø 5mm L 10mm spring steel DIN 1481		
For models:	CGE11-L, CGE11-R, CGE12-L, CGE12-R, CGE21-L, CGE21-R, CGE22-L, CGE22-R, CGE61-L, CGE61-R, CGE62-L, CGE62-R, CGG11-L, CGG11-R, CGG12-L, CGG12-R, CGG21-L, CGG21-R, CGG22-L, CGG22-R, CGG61-L, CGG61-R, CGG62-L, CGG62-R, CSE11-L, CSE11-R, CSE11-R-DG, CSE12-L, CSE12-R, CSE12-R-DG, CSE21-L, CSE21-R, CSE21-R-DG, CSE22-L, CSE22-R, CSE22-R-DG, CSE61-L, CSE61-R, CSE61-R-DG, CSE62-L, CSE62-R, CSE62-R-DG, CSG11-L, CSG11-R, CSG11-R-DG, CSG12-L, CSG12-R, CSG12-R-DG, CSG21-L, CSG21-R... (Other models you can see in the webshop)		



			
1			
Part No.	696824	Ref. No.	123005
description	roll pin ø 5mm L 16mm spring steel DIN 1481		
For models:	CGE11-L, CGE11-R, CGE12-L, CGE12-R, CGE21-L, CGE21-R, CGE22-L, CGE22-R, CGE61-L, CGE61-R, CGE62-L, CGE62-R, CGG11-L, CGG11-R, CGG12-L, CGG12-R, CGG21-L, CGG21-R, CGG22-L, CGG22-R, CGG61-L, CGG61-R, CGG62-L, CGG62-R, CSE11-L, CSE11-R, CSE11-R-DG, CSE12-L, CSE12-R, CSE12-R-DG, CSE21-L, CSE21-R, CSE21-R-DG, CSE22-L, CSE22-R, CSE22-R-DG, CSE61-L, CSE61-R, CSE61-R-DG, CSE62-L, CSE62-R, CSE62-R-DG, CSG11-L, CSG11-R, CSG11-R-DG, CSG12-L, CSG12-R, CSG12-R-DG, CSG21-L, CSG21-R...(Other models you can see in the webshop)		

<p>pins</p> 			
1			
Part No.	696823	Ref. No.	123027
description	pin ø 5mm L 10mm SS Qty 1 pcs		
For models:	CGE11-L, CGE11-R, CGE12-L, CGE12-R, CGE21-L, CGE21-R, CGE22-L, CGE22-R, CGE61-L, CGE61-R, CGE62-L, CGE62-R, CGG11-L, CGG11-R, CGG12-L, CGG12-R, CGG21-L, CGG21-R, CGG22-L, CGG22-R, CGG61-L, CGG61-R, CGG62-L, CGG62-R, CSE11-L, CSE11-R, CSE11-R-DG, CSE12-L, CSE12-R, CSE12-R-DG, CSE21-L, CSE21-R, CSE21-R-DG, CSE22-L, CSE22-R, CSE22-R-DG, CSE61-L, CSE61-R, CSE61-R-DG, CSE62-L, CSE62-R, CSE62-R-DG, CSG11-L, CSG11-R, CSG11-R-DG, CSG12-L, CSG12-R, CSG12-R-DG, CSG21-L, CSG21-R...(Other models you can see in the webshop)		

			
1			
Part No.	696827	Ref. No.	123034
description	pin ø 5mm L 20mm steel Qty 1 pcs		
For models:	CGE11-L, CGE11-R, CGE12-L, CGE12-R, CGE21-L, CGE21-R, CGE22-L, CGE22-R, CGE61-L, CGE61-R, CGE62-L, CGE62-R, CGG11-L, CGG11-R, CGG12-L, CGG12-R, CGG21-L, CGG21-R, CGG22-L, CGG22-R, CGG61-L, CGG61-R, CGG62-L, CGG62-R, CSE11-L, CSE11-R, CSE11-R-DG, CSE12-L, CSE12-R, CSE12-R-DG, CSE21-L, CSE21-R, CSE21-R-DG, CSE22-L, CSE22-R, CSE22-R-DG, CSE61-L, CSE61-R, CSE61-R-DG, CSE62-L, CSE62-R, CSE62-R-DG, CSG11-L, CSG11-R, CSG11-R-DG, CSG12-L, CSG12-R, CSG12-R-DG, CSG21-L, CSG21-R...(Other models you can see in the webshop)		

consumables

sealants and adhesives

high temperature silicone

			
1			
Part No.	890060	Ref. No.	303046
description	adhesive PACTAN 6076 310ml 250°C anthracite		
description	<p>PACTAN 6076 - cartridge 310ml - anthracite</p> <p>1-component silicone-based product for specific gluing and sealing purposes that require a high temperature resistance. The material is used for bonding and sealing of parts with high temperature load e.g. inner door of oven as well as for other bonding and sealing purposes especially on ovens and ranges. The product is fast to light, resistant to ageing and ozone and reveals a very good chemical resistance.</p> <p>Temperature resistance up to 250°C</p>		
For models:	0720332P00, 0720332R00, 0720332T00, 0720332V00, 0723104-03, 0723104A03, 0723104B03, 0723105-03, 0723105A03, 0723105B03, 1023101-00, 1023101-01, 1023106-00, 1023106-01, 1023111-00, 1023111-01, 1023401-00, 1023401K00, 1023410-00, 1220301J02, 1220301J03, 1220303J03, 1220303J04, 1220303K00, 1220303K01, 1223101-00, 1223101-01, 1223101-02, 1223103-00, 1223103-01, 1223103-02, 1223106-00, 1223106-01, 1223106-02, 1223202-00, 1223202A00, 1223202A01, 1223202J00, 1223202J01, 1223203-00, 1223203-01, 1223203-02, 1223203-03, 1223204-00, 1223204-01, 1223204-02, 1223205-00, 1223205-01, 1223205-02, 1223206-00... (Other models you can see in the webshop)		

cleaning agents

combi-steamer detergents/descalers

Notice: Articles labelled 'DANGEROUS GOODS' are delivered by road through a forwarder for reasons of safety and are charged separately!

			
1			
Part No.	802061	Ref. No.	303324 40-100575
description	detergent for combi-steamer MKN WaveClean detergent/rinse aid Qty 10 pcs		
description	<p>MKN WaveClean - detergent - box of 10 cartridges</p> <p>Combination product for cleaning and descaling of combi steamers with WaveClean®</p> <p>Innovative 2-in-1 cartridge with cleaner and rinse aid. Easy handling with no direct contact to active agents. Cleans MKN combi steamers reliably, economically and hygienically. Start the WaveClean® cleaning program, unscrew the 2-in-1 cartridge cap and insert the cartridge into the holder when prompted to do so. After the cleaning process remove the cartridge before starting the machine. Rinse off any residue with plenty of water. For commercial use only.</p>		



lava rocks / ceramic briquetts

			
1			
Part No.	211100	Ref. No.	201517
description	ceramic briquetts size 53x53x24		
For models:	0261601-00, 1261601-00, 1261601-01, 1261602-00, 1261602-01, 1261602-02, 1261602-03, 1261604-03, 1361601-00, 1361601-01, 1361601-02, 1361602-00, 1361602-01, 1361602-02, 1361604-02, 1461601-00, 1461602-00, 2061602-00, 2061602-01, 2061603-00, 2061603-01, 2061603-02, 2061604-01, 3061602-00		

fuses

fine fuses

			
1			
Part No.	358598	Ref. No.	202776
description	fine fuse size ø5x20mm 0.63A slow-acting rated 250V Qty 10 pcs		
For models:	0720332R00, 0720332V00		

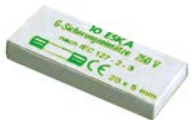
			
1			
Part No.	358599	Ref. No.	203720
description	fine fuse size ø5x20mm 0.8A slow-acting rated 250V Qty 10 pcs		
For models:	0521702B03, 0521702B04, 2022828-01, 2022828-02, 2022828-03, 2022828-04, 2022828-05, 2022828-06, 3022828-03, 3022828-04, 3022828-05, 3022828-06, 3022828-07, CGE11-L, CGE11-R, CGE12-L, CGE12-R, CGE21-L, CGE21-R, CGE22-L, CGE22-R, CGE61-L, CGE61-R, CGE62-L, CGE62-R, CPE63, CSE11-L, CSE11-R, CSE12-L, CSE12-R, CSE21-L, CSE21-R, CSE22-L, CSE22-R, CSE61-L, CSE61-R, CSE62-L, CSE62-R		

			
1			
Part No.	358601	Ref. No.	203722
description	fine fuse size ø5x20mm 1.25A slow-acting rated 250V Qty 10 pcs		
For models:	CCE60, CCE63, CGE12-L, CGE12-R, CGE62-L, CGE62-R, CGG11-L, CGG11-R, CGG12-L, CGG12-R, CGG21-L, CGG21-R, CGG22-L, CGG22-R, CGG61-L, CGG61-R, CGG62-L, CGG62-R, CPE60, CPE63, CSE12-L, CSE12-R, CSE62-L, CSE62-R, CSG11-L, CSG11-R, CSG11-R-DG, CSG12-L, CSG12-R, CSG12-R-DG, CSG21-L, CSG21-R, CSG21-R-DG, CSG22-L, CSG22-R, CSG22-R-DG, CSG61-L, CSG61-R, CSG61-R-DG, CSG62-L, CSG62-R, CSG62-R-DG		

			
1			
Part No.	358608	Ref. No.	203996
description	fine fuse size ø5x20mm 10A slow-acting rated 250V Qty 10 pcs		
For models:	CGE11-L, CGE11-R, CGE12-L, CGE12-R, CGE21-L, CGE21-R, CGE22-L, CGE22-R, CGE61-L, CGE61-R, CGE62-L, CGE62-R, CGG11-L, CGG11-R, CGG12-L, CGG12-R, CGG21-L, CGG21-R, CGG22-L, CGG22-R, CGG61-L, CGG61-R, CGG62-L, CGG62-R, CPE63, CSE11-L, CSE11-R, CSE11-R-DG, CSE12-L, CSE12-R, CSE12-R-DG, CSE21-L, CSE21-R, CSE21-R-DG, CSE22-L, CSE22-R, CSE22-R-DG, CSE61-L, CSE61-R, CSE61-R-DG, CSE62-L, CSE62-R, CSE62-R-DG, CSG11-L, CSG11-R, CSG11-R-DG, CSG12-L, CSG12-R, CSG12-R-DG, CSG21-L...(Other models you can see in the webshop)		

			
1			
Part No.	358603	Ref. No.	203474
description	fine fuse size ø5x20mm 2A slow-acting rated 250V Qty 10 pcs		
For models:	0220302A00, 0220302A01, 0220302A02, 0220302A03, 0220302C00, 0220302C01, 0220302C02, 0220302C03, 0220303A00, 0220303A01, 0220303A02, 0220303A03, 0220303B00, 0220303B01, 0220303C00, 0220303C01, 0220303C02, 0220303E00, 0220303E01, 0220304-00, 0220305-00, 0220306-00, 0221501-00, 0221502-00, 0720332P00, 0720332R00, 0720332T00, 0720332V00, 1220307-00, 1220307-01, 1220308-00, 1220326-00, 1220326-01, 1220326B00, 1220326B01, 1220327-00, 1220327-01, 1220327B01, 1220329-00, 1220329-01, 1220329B00, 1220329B01, 1221112-00, 1320323-00, 1320323B00, 1320327-00, 1320327A00, 1320327A01, 1320327A02, 1320327B00...(Other models you can see in the webshop)		

			
1			
Part No.	358605	Ref. No.	203742
description	fine fuse size ø5x20mm 3.15A slow-acting rated 250V Qty 10 pcs		

			
1			
Part No.	358607	Ref. No.	203473
description	fine fuse size ø5x20mm 6.3A slow-acting rated 250V Qty 10 pcs		
For models:	1422701-01, 1422701-02, 1422701-03, 1422702-01, 1422702-02, 1422702-03, 1422802B04, 1422802B05, 1422802B06, 1422802B07, 1422802B08, 1422804B04, 1422804B05, 1422804B06, 1422804B07, 1422804B08, 1422805B04, 1422805B05, 1422805B06, 1422805B07, 1422805B08, 1422807B00, 1422807B01, 1422807B02, 1422807B03, 1422807B04, 1422902-00, 1422902-01, 1422902-02, 1422902-03, 1422902-04, 2013004B01, 2013004B02, 2013004B03, 2013004B04, 2013004B05, 2013008B01, 2013008B02, 2013008B03, 2013008B04, 2013008B05, 2013010B01, 2013010B02, 2013010B03, 2013010B04, 2013010B05, 2013018B00, 2013018B01, 2013018B02, 2013018B03...(Other models you can see in the webshop)		



			
1			
Part No.	358704	Ref. No.	203741
description	fine fuse size ø5x20mm 8A slow-acting rated 250V Qty 10 pcs		

screw locks

D0-system (NEOZED)

			
1			
Part No.	358045	Ref. No.	203739
description	fuse size D02 35A rated 250/400V E18 ø 15mm L 36mm Qty 10 pcs		
For models:	CGE21-L, CGE21-R, CGG11-L, CGG11-R, CGG12-L, CGG12-R, CGG61-L, CGG61-R, CSE12-L, CSE12-R, CSE12-R-DG, CSE21-L, CSE21-R, CSE21-R-DG, CSG11-L, CSG11-R, CSG11-R-DG		

GASTROPARTS.COM

