



**GASTROPARTS**

# MIWE

- [EN]** Equipment
- [DE]** Geräte
- [ES]** Aparatos
- [FR]** Équipement
- [IT]** Attrezzature
- [PL]** Urządzenia
- [RU]** Оборудование

✉ [gastroparts@gastroparts.com](mailto:gastroparts@gastroparts.com)

☎ tel. +48 56 657 00 66

📘 [fb.com/gastroparts.global](https://fb.com/gastroparts.global)

**GASTROPARTS.COM**





## heating elements

### heating elements for ovens

			
<b>Part No.</b>	420349	<b>Ref. No.</b>	040504.01
<b>description</b>	heating element 4000W 400V heating circuits 1 L 573mm W 115mm thread M14x1.5 mounting distance 105mm tube ø 10mm connection cable cable length 2000mm dry heating element 2 hole fixing		

### heating elements for pizza ovens

			
<b>Part No.</b>	420350	<b>Ref. No.</b>	071489.14
<b>description</b>	heating element 1500W 230V heating circuits 1 L 1295mm W 23mm connection cable connection distance 16.5mm tube ø 6.5mm cable length 740mm dry heating element		

### coil heating elements

			
<b>Part No.</b>	420285	<b>Ref. No.</b>	060004.11
<b>description</b>	heating element 1000W 230V L 285mm W 70mm ø 24.5mm thread M14x1.5 connection M4 mounting distance 45mm connection length 41mm heating circuits 1		

			
<b>Part No.</b>	420286	<b>Ref. No.</b>	060004.00
<b>description</b>	heating element 1500W 230V L 285mm W 70mm ø 24.5mm thread M14x1.5 connection M4 mounting distance 45mm connection length 41mm heating circuits 1		

## thermostats

### control and safety thermostats

EGO

control thermostats

55.13\_series

			
<b>Part No.</b>	375010	<b>Ref. No.</b>	504024.16
<b>description</b>	thermostat t.max. 250°C temperature range 50-250°C 1-pole 1NO 16A probe ø 3.1mm probe L 208mm capillary pipe 1130mm capillary pipe isolatedmm gland nut shaft L 23mm shaft position upper rotation 270°		

safety thermostats

55.32\_series

			
<b>Part No.</b>	390836	<b>Ref. No.</b>	504024.30 504056.18
<b>description</b>	safety thermostat switch-off temp. 355°C 3-pole 3NC 20A probe ø 4mm probe L 120mm capillary pipe 1890mm capillary pipe isolated-mm gland nut probe		

JUMO

control thermostats

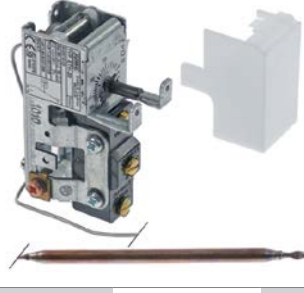
			
<b>Part No.</b>	390912 <sup>1</sup>	<b>Ref. No.</b>	504016.02
<b>description</b>	thermostat t.max. 500°C temperature range 20-500°C 1-pole 1CO 10A probe ø 6mm probe L 125mm capillary pipe 1500mm capillary pipe isolatedmm gland nut shaft ø 5mm shaft L 16mm 230V		

<sup>1</sup>with accessories

safety thermostats

			
<b>Part No.</b>	376059	<b>Ref. No.</b>	504017.05
<b>description</b>	safety thermostat switch-off temp. adjustable 24-500°C temperature range 20-500°C 1-pole 1CO 10A probe ø 6mm probe L 130mm capillary pipe 2200mm capillary pipe isolatedmm gland nut with thermostat control		

1

<b>Part No.</b>	376060	<b>Ref. No.</b>	504048.02
<b>description</b>	safety thermostat temperature range 20-400°C 1-pole 1CO 10A probe ø 6mm probe L 180mm capillary pipe 2180mm capillary pipe isolatedmm gland nut thermostatically controlled outlet 2 probe		

control thermostats with actual value



1

<b>Part No.</b>	379844	<b>Ref. No.</b>	504056.01 504056.11
<b>description</b>	thermostat t.max. 320°C temperature range 0-320°C 1CO 10A probe ø 8mm probe L 265mm capillary pipe 1530mm		

switches and momentary switches

proximity switches



1

<b>Part No.</b>	348134	<b>Ref. No.</b>	504146.08
<b>description</b>	proximity switch 10-30VDC 0.1A ø 18mm D2 ø 12mm L 45mm IGS 206 induction		

lamps

screw-on/push-on fit

halogen lamp

for socket G4 / G6.35 / G9



1

<b>Part No.</b>	357192	<b>Ref. No.</b>	504588.13
<b>description</b>	halogen lamp socket G4 12V 20W temp.-resist.°C OSRAM HALOSTAR STARLITE		

for socket GU5.3 / GU10 / GZ5.3



1

<b>Part No.</b>	359496	<b>Ref. No.</b>	504587.07
<b>description</b>	halogen lamp socket GU5.3 12V 50W temp.-resist. 300°C		

oven lamps

lamps

halogen lamps

for socket G4 / G6.35 / G9



1

<b>Part No.</b>	357192	<b>Ref. No.</b>	504588.13
<b>description</b>	halogen lamp socket G4 12V 20W temp.-resist.°C OSRAM HALOSTAR STARLITE		

for socket GU5,3 / GU10



1

<b>Part No.</b>	359496	<b>Ref. No.</b>	504587.07
<b>description</b>	halogen lamp socket GU5.3 12V 50W temp.-resist. 300°C		

timers

audible timers



1

<b>Part No.</b>	360573	<b>Ref. No.</b>	505192.03
<b>description</b>	audible timer operation time 60min ø 56mm shaft ø 6x4.6mm shaft L 24mm mounting distance 28mm front measurements 72x72mm		



## contactors

### TELEMECANIQUE (Schneider Electric)

#### power contactors



1

<b>Part No.</b>	380965	<b>Ref. No.</b>	504202.07
<b>description</b>	power contactor resistive load 20A 230VAC (AC3/400V) 6A/2.2kW main contacts 3NO auxiliary contacts 1NO connection screw connection type LC1K0610P7+		

## relays

### plug-in/print relays

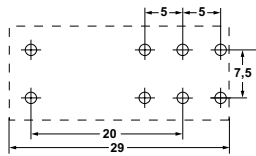

1

<b>Part No.</b>	380335	<b>Ref. No.</b>	504296.00
<b>description</b>	print relay 230VAC 1CO at 250V 16A connection pins raster size 5mm Italiana Relè manuf. no. 40.61.8.230.0000 95.65/95.75		

**accessories for** 380335



<b>Part No.</b>	380340	<b>Ref. No.</b>	—
<b>description</b>	relay socket dimensions 62x36x15mm 250V voltage AC 10A Italiana Relè manuf. no. ZMEM/5		



<b>Part No.</b>	380505	<b>Ref. No.</b>	—
<b>description</b>	relay socket 2CO 40.52 dimensions 81.9x15.5x75mm 250V voltage AC 10A FINDER manuf. no. 95.95.3		



<b>Part No.</b>	381181	<b>Ref. No.</b>	—
<b>description</b>	relay socket 2-pole 40.51/40.52/40.61 connection screw clamp dimensions 15.8x78.6mm 250V voltage AC 10A FINDER manuf. no. 95.75		

## probes

### universal probes

#### humidity probes



1

<b>Part No.</b>	403613	<b>Ref. No.</b>	504007.13
<b>description</b>	humidity probe humidity range 0-100% supply 3.6-30VDC outlet 4-20mA probe ø 12x120mmmm cable lengthm -40 up to +60°C connection coded plug		

## producer-specific probes

### probes



<b>Part No.</b>	378323	<b>Ref. No.</b>	504006.1 504006.55
<b>description</b>	temperature probe Pt1000 cable glass fibre probe -70 up to +500°C cable -50 up to +350°C connection 2-wire thread probe ø5x210mm cable length 2.2m		

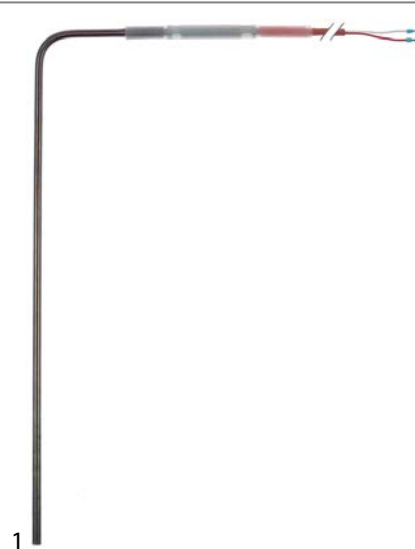

1

<b>Part No.</b>	378510	<b>Ref. No.</b>	504006.13
<b>description</b>	temperature probe Pt1000 cable silicone probe -50 up to +500°C cable -50 up to +180°C connection 2-wire probe ø5x290mm cable length 4.5m		

## electronics

### PCBs



1

<b>Part No.</b>	403269	<b>Ref. No.</b>	504078.90A 504078.91
<b>description</b>	PCB oven 3789,3909,13023,23842,26705 L 205mm W 167mm complete incl. fastening plate		



1

<b>Part No.</b>	403614	<b>Ref. No.</b>	504078.95 504078.95A 504078.96
<b>description</b>	power PCB oven MIWE L 203mm W 130mm 504078.95A		



## solenoid valves

### solenoid valves (water)

metal

solenoid valves (various)



1

<b>Part No.</b>	370713	<b>Ref. No.</b>	505212.11 505212.45
<b>description</b>	solenoid valve 2-ways 230VAC inlet 3/8" connection 3/8" L 44mm type series 8498082 50/60Hz brass		

## flow meters and flow sensors

### flow meters

DIGMESA



1

<b>Part No.</b>	403268	<b>Ref. No.</b>	507570.03
<b>description</b>	flow meter thread 1/4" brass male faston 2.8mm approval NSF reducer ø 2mm		

## fans

### cross flow fans

TRIAL



1

<b>Part No.</b>	601768	<b>Ref. No.</b>	506034.03 506034.07
<b>description</b>	cross flow fan TAL 90/397/N roller ø 90mm roller length 397mm motor position left 220V/50Hz 70W universal bearing silicone connection screw -40 up to +70°C 220V 50/60Hz		

## hot air motors



1

<b>Part No.</b>	601853	<b>Ref. No.</b>	187282.00
<b>description</b>	fan wheel D1 ø 350mm H1 80mm blades 12 D2 ø 13.2mm D3 ø 16.2mm H2 32mm H3 3.5mm		

## motors

### gear motors

for ovens

for flues



1

<b>Part No.</b>	501509	<b>Ref. No.</b>	506605.34
<b>description</b>	actuator GRUNER type 225S-230T-02-004 1.5W 230V voltage AC/DC 50/60Hz shaft ø 16mm L 170mm W 66mm H 61mm load capacity 2NM		

## electric accessories

### cables

PVC cable



1

<b>Part No.</b>	551313	<b>Ref. No.</b>	504781.31
<b>description</b>	PVC cable 3-pole 0.75mm <sup>2</sup> grey conductor copper insulation PVC t.max. 105°C		



1

<b>Part No.</b>	551323	<b>Ref. No.</b>	504781.32
<b>description</b>	PVC cable 5-pole 0.75mm <sup>2</sup> grey conductor copper insulation PVC t.max. 105°C		



1

<b>Part No.</b>	551322	<b>Ref. No.</b>	504783.32
<b>description</b>	PVC cable 5-pole 2.5mm <sup>2</sup> grey conductor copper insulation PVC t.max. 105°C		



1 

<b>Part No.</b>	551316	<b>Ref. No.</b>	504781.33
<b>description</b>	PVC cable 7-pole 0.75mm <sup>2</sup> grey conductor copper insulation PVC t.max. 105°C		

silicone cable

up to 180°C

1 

<b>Part No.</b>	551314	<b>Ref. No.</b>	504781.21
<b>description</b>	silicone cable 3-pole 0.75mm <sup>2</sup> insulation silicone red permanent temperature -60 up to +180°C conductor copper		

1 

<b>Part No.</b>	551312	<b>Ref. No.</b>	504782.21
<b>description</b>	silicone cable 3-pole 1.5mm <sup>2</sup> insulation silicone red permanent temperature -60 up to +180°C t.max. 230°C conductor copper		

1 

<b>Part No.</b>	551315	<b>Ref. No.</b>	504781.22
<b>description</b>	silicone cable 5-pole 0.75mm <sup>2</sup> insulation silicone red permanent temperature -60 up to +180°C conductor copper		

ribbon cables

group 10

1 

<b>Part No.</b>	698698	<b>Ref. No.</b>	9500396
<b>description</b>	ribbon cable 2-pole L 175mm raster size 2mm		

equipment-specific units

for convection ovens/combi-steamers

injection pipes

1 

<b>Part No.</b>	698673	<b>Ref. No.</b>	043148.60
<b>description</b>	injection pipe L 460mm H 69mm ID ø 10mm ED ø 21.7mm W 100mm hole distance 70mm		

spare parts and accessories

1 

<b>Part No.</b>	694620	<b>Ref. No.</b>	507171.00
<b>description</b>	silicon insert for glass plate		

for ovens

housing and bezels

1 

<b>Part No.</b>	698677	<b>Ref. No.</b>	141161.10
<b>description</b>	frame W 622mm L 1710mm stainless steel with rails & screws		

miscellaneous

1 

<b>Part No.</b>	698675	<b>Ref. No.</b>	050045.01
<b>description</b>	casing cover stainless steel L 510mm W 180mm H 145mm 3/4"		





1

<b>Part No.</b>	698674	<b>Ref. No.</b>	044651.30
<b>description</b>	drive shaft L 415mm W 300mm H 300mm ø 40mm		

## for pizza ovens

## miscellaneous



1

<b>Part No.</b>	850120	<b>Ref. No.</b>	506453.14
<b>description</b>	hot plate L 815mm W 613mm H 12mm delivery freight forwarding company only		

## for cleaning and disinfection machines

## nozzles

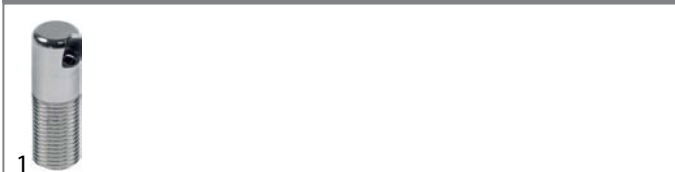

1

<b>Part No.</b>	698683	<b>Ref. No.</b>	8301611
<b>description</b>	nozzle ø 13mm ID ø 3.5mm aperture 3mm L 42mm 1/4"		

## locks

## electromagnetic closer



1

<b>Part No.</b>	692362	<b>Ref. No.</b>	088446.00 088446.01
<b>description</b>	electromagnetic closer 24V voltage DC L 104mm W 24mm H 29mm		

## gaskets

## gaskets for heated units

## door seals

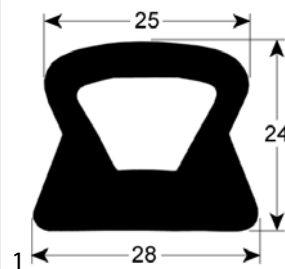

1

<b>Part No.</b>	902077	<b>Ref. No.</b>	046574.75
<b>description</b>	door seal profile 2433 W 1080mm L 1995mm external size		

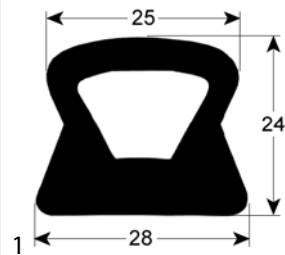

1

<b>Part No.</b>	901639	<b>Ref. No.</b>	046571.70 046574.70
<b>description</b>	door seal profile 2433 W 620mm L 1750mm external size 3-sided		

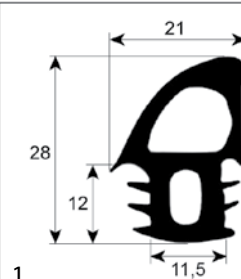

1

<b>Part No.</b>	901474	<b>Ref. No.</b>	188024.01 189016.01
<b>description</b>	door seal profile 2695 perimeter 2200mm		



<b>Part No.</b>	901473	<b>Ref. No.</b>	189016.02 816823
<b>description</b>	door seal profile 2695 perimeter 2520mm		

<b>Part No.</b>	901475	<b>Ref. No.</b>	189016.09
<b>description</b>	door seal profile 2695 perimeter 2670mm		

<b>Part No.</b>	901476	<b>Ref. No.</b>	187719.02
<b>description</b>	door seal profile 2710 perimeter 1960mm Qty 1		

**gaskets for tray rack trolleys**

<b>Part No.</b>	901666	<b>Ref. No.</b>	046569.20
<b>description</b>	tray rack trolley gasket profile 4200 L 558mm W 40mm thickness 13mm		



**GASTRO**PARTS.COM

