



**GASTROPARTS**

# Metalcarrelli

**[EN]** Equipment

**[DE]** Geräte

**[ES]** Aparatos

**[FR]** Équipement

**[IT]** Attrezzature

**[PL]** Urządzenia

**[RU]** Оборудование

✉ [gastroparts@gastroparts.com](mailto:gastroparts@gastroparts.com)

☎ tel. +48 56 657 00 66

📘 [fb.com/gastroparts.global](https://fb.com/gastroparts.global)

**GASTROPARTS.COM**





## heating elements

### heating elements for bain maries

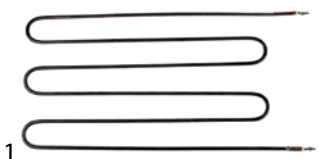

Part No.	418334	Ref. No.	003001040005 R1515
description	heating element 1400W 230V heating circuits 1 L 555mm L1 45mm W 270mm connection M4 connection distance 262mm tube ø 8mm dry heating element L2 510mm H 20mm		

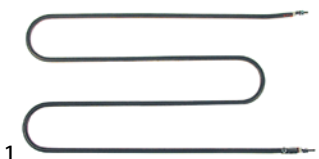

Part No.	418335	Ref. No.	003001040010 R1545
description	heating element 500W 230V heating circuits 1 L 430mm L1 38mm W 280mm connection M4 connection distance 271mm tube ø 8.5mm dry heating element L2 392mm H 16mm		

### heating cables

#### connection on both sides

##### with wire end ferrules



Part No.	418336	Ref. No.	R1504
description	heating cable 230W 230V L 4000mm silicone impregnated glass fibre braiding ø 3mm connection terminal		



Part No.	418337	Ref. No.	R1506
description	heating cable 313W 230V L 6600mm silicone impregnated glass fibre braiding ø 3mm connection terminal		



Part No.	418338	Ref. No.	R1508
description	heating cable 384W 230V L 7900mm silicone impregnated glass fibre braiding ø 4mm connection terminal		

#### with male fastons



Part No.	419108	Ref. No.	003001040011 003001040018
description	heating cable 250W 230V L 4000mm silicone ø 3mm connection female faston 6.3mm		



Part No.	419107	Ref. No.	003001040012 003001040019
description	heating cable 300W 230V L 6000mm silicone ø 3mm		



Part No.	419106	Ref. No.	003001040013 003001040020
description	heating cable 450W 230V L 8000mm silicone ø 3mm		



Part No.	418339	Ref. No.	003001040014 003001040021 R1510
description	heating cable 600W 230V L 9900mm silicone ø 3mm connection male faston 6.3mm		

## immersion heating elements

### with compression flange 70 x 26mm



Part No.	417278	Ref. No.	003001020002 R1535
description	heating element 1950W 230V heating circuits 3 L 230mm W 70mm washing		

## thermostats

### control and safety thermostats

#### IMIT / TEMPOMATIC / ARTHERMO

##### control thermostats



Part No.	375404	Ref. No.	003201820001
description	thermostat t.max. 110°C temperature range 0-90°C 1-pole 1CO 15A probe ø 6mm probe L 104mm capillary pipe 1400mm capillary pipe isolated 1350mm gland nut shaft ø 6x4.6mm shaft L 18mm shaft position upper rotation 270° probe material copper 400V		



## PRODIGY / FIRT

## control thermostats



<b>Part No.</b>	390723	<b>Ref. No.</b>	003201820002
<b>description</b>	thermostat PRODIGY temperature range -35 up to +35°C probe ø 6mm probe L 110mm capillary pipe 1500mm type TR/711-N		
<b>accessories for</b>	390723		
	<b>Part No.</b>	110305	<b>Ref. No.</b>
	knob thermostat t.max. 35°C temperature range -35 up to +35°C ø 45mm shaft ø 6x4.6mm shaft flat inclined rotation 270° white		

## various

## control thermostats with operation switch



<b>Part No.</b>	375762	<b>Ref. No.</b>	R0090
<b>description</b>	thermostat t.max. 120°C temperature range 30-120°C 1-pole 1CO 16A probe ø 6.5mm probe L 98mm capillary pipe 1450mm capillary pipe isolated 1350mm rotation 270°		

## switches and momentary switches

## rocker/momentary rocker switches

## 30x22mm

## labelled



<b>Part No.</b>	300125	<b>Ref. No.</b>	R0056
<b>description</b>	rocker switch mounting measurements 30x22mm green 2NO 230V 16A 0-I connection male faston 6.3mm ambient temperature max. 125/55°C protection IP65 with cover cap		
<b>accessories for</b>	300125		
	<b>Part No.</b>	301036	<b>Ref. No.</b>
	protective cover internal size 30x22mm for rocker switch mounting measurementsmm		



<b>Part No.</b>	301164	<b>Ref. No.</b>	R0056 R0096
<b>description</b>	rocker switch mounting measurements 30x22mm green 2NO 250V 16A illuminated connection male faston 6.3mm ambient temperature max. 85°C protection IP65 with cover cap		
<b>accessories for</b>	301164		
	<b>Part No.</b>	301036	<b>Ref. No.</b>
	protective cover internal size 30x22mm for rocker switch mounting measurementsmm		

## lamps

## indicator lights

## indicator lights (complete)

ø10mm

with plug-in socket

1

<b>Part No.</b>		<b>Ref. No.</b>	R0095
<b>description</b>	indicator light ø 10mm 230V red cable length 200mm		

## hard-glass infrared lamps



1

<b>Part No.</b>	359463	<b>Ref. No.</b>	003151620002 A9560
<b>description</b>	infrared lamp socket E27 240V 250W ø 125mm L 173mm type BR125 red hard glas		

## electronic controllers

## ELIWELL

## universal controllers













## built-in version



1

<b>Part No.</b>	379994	<b>Ref. No.</b>	R0052
<b>description</b>	electronic controller ELIWELL mounting measurements 71x29mm 230V voltage AC NTC/PTC defr. funct. no		



 <p>71 x 29mm</p>			
1			
<b>Part No.</b>	379690	<b>Ref. No.</b>	R0092
<b>description</b>	electronic controller ELIWELL type ICPlus902 model ICP16D0750000 mounting measurements 71x29mm 230V voltage AC NTC/PTC relay outputs 1 CO-15A(8) NTC/PTC built-in depth 60mm defr. funct. -50 up to +150°C display 3½ digits		
<b>accessories for</b>	379690		
	<b>Part No.</b>	378194	<b>Ref. No.</b> —
	temperature probe NTC 10kOhm cable PVC probe -20 up to +80°C cable -10 up to 100°C probe ø7x24.5mm cable length 1.5m without screw connection 2-wire		
	<b>Part No.</b>	379052	<b>Ref. No.</b> —
	temperature probe PTC 1kOhm cable silicone probe -50 up to +150°C cable -50 up to +180°C probe ø6x40mm cable length 1.5m without screw connection 2-wire		
	<b>Part No.</b>	379053	<b>Ref. No.</b> —
	temperature probe PTC 1kOhm cable PVC probe -50 up to +150°C cable -10 up to 100°C probe ø6x30mm cable length 3m without screw connection 2-wire		
	<b>Part No.</b>	379057	<b>Ref. No.</b> —
	temperature probe NTC 10kOhm cable PVC probe -20 up to +80°C cable -10 up to 100°C probe ø6x25mm cable length 3m 2-wire		
	<b>Part No.</b>	379064	<b>Ref. No.</b> —
	temperature probe PTC 1kOhm cable silicone probe -50 up to +150°C cable -50 up to +180°C probe ø6x40mm cable length 3m without screw connection 2-wire		
	<b>Part No.</b>	379142	<b>Ref. No.</b> —
	temperature probe PTC 1kOhm cable PVC probe -50 up to +150°C cable -10 up to 100°C probe ø6x30mm cable length 1.5m without screw connection 2-wire		
	<b>Part No.</b>	379160	<b>Ref. No.</b> —
	temperature probe NTC 10kOhm cable thermoplastic probe -40 up to +110°C cable -40 up to +110°C probe ø6x14mm cable length 1.5m without screw connection 2-wire		
	<b>Part No.</b>	379161	<b>Ref. No.</b> —
	temperature probe NTC 10kOhm cable thermoplastic probe -40 up to +110°C cable -40 up to +110°C probe ø6x14mm cable length 3m without screw connection 2-wire		
	<b>Part No.</b>	379343	<b>Ref. No.</b> —
	temperature probe NTC 10kOhm cable silicone probe -40 up to +110°C cable -50 up to +180°C probe ø6x40mm cable length 3m 2-wire		
	<b>Part No.</b>	379458	<b>Ref. No.</b> —
	temperature probe NTC 10kOhm cable silicone probe -40 up to +110°C cable -50 up to +180°C probe ø6x40mm cable length 1.5m without screw connection 2-wire		
	<b>Part No.</b>	379781	<b>Ref. No.</b> —
	temperature probe PTC 1kOhm cable thermoplastic probe -50 up to +150°C cable -40 up to +110°C probe ø6x14mm cable length 1.5m without screw connection 2-wire		
	<b>Part No.</b>	379782	<b>Ref. No.</b> —
	temperature probe PTC 1kOhm cable thermoplastic probe -50 up to +150°C cable -40 up to +110°C probe ø6x14mm cable length 3m 2-wire resistor 1kOhm		

## fans



### hot air fans

#### miscellaneous

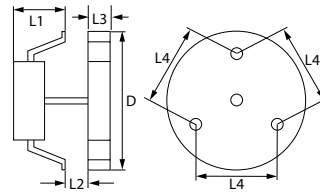

1



<b>Part No.</b>	601011	<b>Ref. No.</b>	R1536
<b>description</b>	hot air fan 220-240V 40W 50/60Hz L1 65mm L2 15mm L3 25mm L4 87mm fan wheel ø 150mm FIME type C25R8023CLH		
<b>accessories for</b>	601011		
	<b>Part No.</b>	550879	<b>Ref. No.</b> —
	insulation ø 130mm thickness 3mm hole ø 20mm for hot air fan		
	<b>Part No.</b>	601260	<b>Ref. No.</b> —
	nut thread M6L IT for hot air fan		

## electric accessories

### cables

#### spiral cables



1

<b>Part No.</b>	550101	<b>Ref. No.</b>	003553280001
<b>description</b>	spiral cable plug type CEE7/7 type E+F 1.5mm <sup>2</sup> 3-pole with plug L 500mm expansion 5:1 countries A/B/D/F/I orange t.max. 70°C		



## gas burners

## hob burners

## producer-specific hob burners

METALCARRELLI

## universal



1

<b>Part No.</b>	105927	<b>Ref. No.</b>	009540650002 A0135
<b>description</b>	burner unit L 350mm W 250mm number of burners: 1 complete 1.75kW LPG		



1

<b>Part No.</b>	105928	<b>Ref. No.</b>	009540650003 A0136
<b>description</b>	burner unit L 470mm W 340mm number of burners: 2 complete		

## equipment feet and end caps

## bolting feet



1

<b>Part No.</b>	693442	<b>Ref. No.</b>	001804340001
<b>description</b>	equipment foot ø 29mm H 15mm rubber bore ø 6mm Qty 1 pcs		

## DERBY RUOTE

## with bolt hole

## plastic



1

<b>Part No.</b>	701413	<b>Ref. No.</b>	005201250020
<b>description</b>	swivel castor ø 125mm bolt hole bolt hole ø 13mm housing polypropylene capacity 100kg bearing ball bearing wheel body polypropylene tread TPE tyres H 161mm wheel width 30mm Qty 1 pcs		

## miscellaneous

## with bolt hole

ø125mm



1

<b>Part No.</b>	700342 <sup>1</sup>	<b>Ref. No.</b>	005201250021 83022000 R3207F
<b>description</b>	swivel castor with swivel brake ø 125mm plug fitting 21x21mm housing zinc-plated sheet steel bearing slide bearing H 157mm wheel width 27mm		

<sup>1</sup>with swivel brake

## with spigot

ø100mm



1

<b>Part No.</b>	700339	<b>Ref. No.</b>	005101000001 R3220
<b>description</b>	swivel castor ø 100mm threaded shaft M10 housing chrome-plated steel bearing ball bearing H 140mm wheel width 25mm Qty 1 pcs		



1

<b>Part No.</b>	700336	<b>Ref. No.</b>	005151250002 R3205F
<b>description</b>	swivel castor with swivel brake ø 125mm plug fitting ø10x38mm housing chrome-plated steel bearing slide bearing wheel body polypropylene tread TPE tyres Qty 1 pcs		

ø125mm



1

<b>Part No.</b>	700341	<b>Ref. No.</b>	00520125000 005201250001 R3207
<b>description</b>	swivel castor ø 125mm plug fitting 21x21mm housing zinc-plated sheet steel bearing slide bearing H 157mm wheel width 27mm		



 <p>1</p>			
<b>Part No.</b>	700340	<b>Ref. No.</b>	005151250001 R3205
<b>description</b>	swivel castor ø 125mm plug fitting ø10x38mm housing zinc-plated sheet steel bearing slide bearing tread thermoplastic rubber H 157mm wheel width 27mm		

**bumper angles**

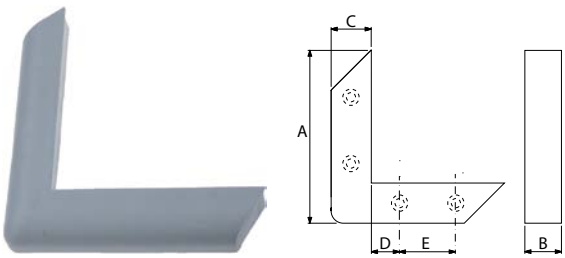
 <p>1</p>			
<b>Part No.</b>	692112	<b>Ref. No.</b>	233004680002 A0034
<b>description</b>	bumper angle outer length 180mm inner length 145mm W 32mm H 30mm mounting distance 51mm hole distance 42mm hole ø 3mm plastic grey		

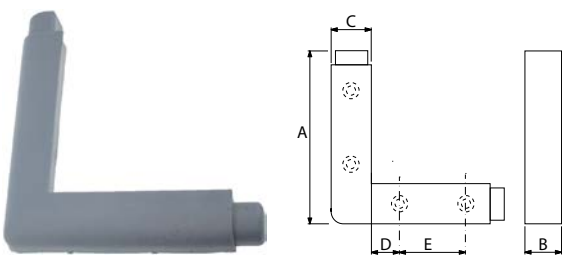
 <p>1</p>			
<b>Part No.</b>	692113	<b>Ref. No.</b>	233004680001
<b>description</b>	bumper angle outer length 180mm inner length 148mm W 34mm H 22mm mounting distance 52mm hole distance 48mm hole ø 3mm plastic grey		

**valves and tank inlets**

**ball valves**

universal

mini ball valves

 <p>1</p>			
<b>Part No.</b>	520724	<b>Ref. No.</b>	M2001020001
<b>description</b>	ball valve connection 1/2" IT - 1/2" ET DN10 total length 45mm chrome-plated brass		

**GASTRO**PARTS.COM

