



**GASTROPARTS**

# Mercatus

- [EN]** Equipment
- [DE]** Geräte
- [ES]** Aparatos
- [FR]** Équipement
- [IT]** Attrezzature
- [PL]** Urządzenia
- [RU]** Оборудование

✉ [gastroparts@gastroparts.com](mailto:gastroparts@gastroparts.com)

☎ tel. +48 56 657 00 66

📘 [fb.com/gastroparts.global](https://fb.com/gastroparts.global)

**GASTROPARTS.COM**





## switches and momentary switches

### rocker/momentary rocker switches

30x22mm



1

<b>Part No.</b>	301003	<b>Ref. No.</b>	43201004
<b>description</b>	rocker switch mounting measurements 30x22mm green 2NO 250V 16A illuminated 0-I connection male faston 6.3mm ambient temperature max. 125/55°C protection IP65		
<b>accessories for</b>	301003		
	<b>Part No.</b>	301036	<b>Ref. No.</b>
	protective cover internal size 30x22mm for rocker switch mounting measurementsmm		



1

<b>Part No.</b>	346474	<b>Ref. No.</b>	43201014
<b>description</b>	dummy element external size 30x22mm suitable for rocker switch		



1

<b>Part No.</b>	346473	<b>Ref. No.</b>	43201005
<b>description</b>	rocker switch mounting measurements 30x22mm orange 2NO 230V 16A illuminated fan connection male faston 6.3mm ambient temperature max. 100/55°C protection IP40		

## lamps

### indicator lights

#### indicator lights (complete)

30x22mm



1

<b>Part No.</b>	359177	<b>Ref. No.</b>	43201006
<b>description</b>	indicator light mounting measurements 30x22mm 230V red connection male faston 6.3mm temp.-resist. 85°C type Marquardt 1667.. IP44		
<b>accessories for</b>	359177		
	<b>Part No.</b>	301036	<b>Ref. No.</b>
	protective cover internal size 30x22mm for rocker switch mounting measurementsmm		

## electronic controllers

### CAREL

#### refrigeration controllers

##### built-in version



1

<b>Part No.</b>	378333 <sup>1</sup>	<b>Ref. No.</b>	41103010
<b>description</b>	electronic controller CAREL IRMEC0HB011 mounting measurements 71x29mm built-in depth 94mm 115-230V voltage AC NTC/PTC relay outputs 4 CO-12A(2) CO-8A(4) CO-8A(4) CO-8A(4) NTC/PTC NTC/PTC DI DI IR/RS-485 protection IP65 -50 up to +99/+150°C display 3 digits		

<sup>1</sup>with IR/RS-485 interface



1

<b>Part No.</b>	379586	<b>Ref. No.</b>	41103001
<b>description</b>	electronic controller CAREL mounting measurements 71x29mm 12V voltage AC protection IP65 heating or cooling refrigeration type IR325E0001		



1

<b>Part No.</b>	378236 <sup>1</sup>	<b>Ref. No.</b>	41103006
<b>description</b>	electronic controller CAREL PBMEH0HB111 mounting measurements 138.5x29mm built-in depth 75mm 115-230V voltage AC NTC/PTC relay outputs 5 NO-10A(10) CO-12A(2) NO-8A(4) NO-8A(4) CO-8A(4) NTC NTC DI DI yes IR/RS-485 yes protection IP54 -50 up to +150°C display 3½ digits		
<b>spare parts for</b>	378236		
	<b>Part No.</b>	378255	<b>Ref. No.</b>
	frame W 197mm H 50mm plastic black for CAREL		

<sup>1</sup>with IR/RS-485 interface

1

<b>Part No.</b>	378326	<b>Ref. No.</b>	41103038
<b>description</b>	electronic controller CAREL PYMT1Z054G mounting measurements 71x29mm built-in depth 59mm 230V voltage AC NTC relay outputs 1 CO-12A(2) NTC NTC DI yes protection IP54 -50 up to +90°C display 3½ digits		

## built-in version 2-piece



140 x 110mm

1

<b>Part No.</b>	378465	<b>Ref. No.</b>	41103005 PSB0001000
<b>description</b>	electronic controller CAREL PSB0001000 mounting measurements 145x110mm built-in depth 30mm 230V voltage AC NTC relay outputs 4 NO-16A(12) CO-16A(12) NO-10A(4) NO-16A(12) NTC NTC DI DI yes yes installation kit inclusive yes protection IP44 DIN rail°C display		



71 x 29mm

1

<b>Part No.</b>	378251	<b>Ref. No.</b>	41201003
<b>description</b>	keypad unit CAREL PST mounting measurements 71x29mm built-in depth 35mmV voltage relay outputs protection IP65°C display		

## accessories



1

<b>Part No.</b>	378255	<b>Ref. No.</b>	41401011
<b>description</b>	frame W 197mm H 50mm plastic black for CAREL		

## DIXELL

## refrigeration controllers

## built-in version



71 x 29mm

1

<b>Part No.</b>	378488	<b>Ref. No.</b>	41103064
<b>description</b>	electronic controller DIXELL XR20CH-5G0C3 mounting measurements 71x29mm built-in depth 61mm 230V voltage AC NTC/PTC relay outputs 1 NO-16A(5) NTC/PTC NTC/PTC/DI protection IP55°C display 3½ digits		



1

<b>Part No.</b>	378676	<b>Ref. No.</b>	41103087
<b>description</b>	electronic controller DIXELL XW20LH mounting measurements 149x30mm built-in depth 65mm 230V NTC display 3 digits		



1

<b>Part No.</b>	378530	<b>Ref. No.</b>	41103042 41103075
<b>description</b>	electronic controller DIXELL XW70LH-5N0W0-B mounting measurements 150x31mm built-in depth 76mm 230V voltage AC NTC relay outputs 5 NO-20A(8) CO-8A(3) NO-8A(3) NO-8A(3) NTC NTC DI DI yes yes IR/RS-485 yes protection IP65 -50 up to +150°C display 2½ digit		

## accessories universal for electronic con-

## electronic controller accessories

## fitting parts



1

<b>Part No.</b>	692723	<b>Ref. No.</b>	41401005
<b>description</b>	bracket plastic dimensions 51.5x198mm cut-out 28x70mm for electronic controller		



## probes

### universal probes

#### temperature probes

1			
<b>Part No.</b>	379160	<b>Ref. No.</b>	41201006
<b>description</b>	temperature probe NTC 10kOhm cable thermoplastic probe -40 up to +110°C cable -40 up to +110°C probe ø6x14mm cable length 1.5m without screw connection 2-wire		

1			
<b>Part No.</b>	379161	<b>Ref. No.</b>	41201005
<b>description</b>	temperature probe NTC 10kOhm cable thermoplastic probe -40 up to +110°C cable -40 up to +110°C probe ø6x14mm cable length 3m without screw connection 2-wire		

## keypads

### front foils

1			
<b>Part No.</b>	403773	<b>Ref. No.</b>	5901326
<b>description</b>	front foil refrigeration MERCATUS L 332mm W 65mm		

## pressure switches

### for refrigeration

#### DANFOSS

1			
<b>Part No.</b>	541464	<b>Ref. No.</b>	41301001
<b>description</b>	pressure control DANFOSS type KP1 60-1101 pressure connection vertical ND refrigeration reset automatic switching diff. 0.7 - 4.0bar pressure range -0.2 up to +7.5bar connection 7/16" UNF (1/4" SAE)		

## compressors

### ACC/ZEL

#### R134A

#### HMBP monophase

High/Medium evaporation temperature above -20/-15 °C

1			
<b>Part No.</b>	605006	<b>Ref. No.</b>	40103007
<b>description</b>	compressor coolant R134a type GD40MB 220-240V 50Hz HMBP fully hermetic 6.7kg 1/8HP power input 200W cylinder capacity 4.1cm <sup>3</sup> CSIR H 162.5mm 64W 87W 117W 153W 196W 245W 301W 363W test method ASHRAE		

1			
<b>Part No.</b>	605012	<b>Ref. No.</b>	40103008
<b>description</b>	compressor coolant R134a type GL45TB 220-240V 50Hz HMBP fully hermetic 8.4kg 1/6HP power input 342W cylinder capacity 4.5cm <sup>3</sup> CSIR H 175.5mmW 76W 101W 134W 175W 223W 278W 342W 413W test method ASHRAE ambient temperature max. 43°C		

1			
<b>Part No.</b>	605007	<b>Ref. No.</b>	40103009
<b>description</b>	compressor coolant R134a type GL60TB 220-240V 50Hz HMBP fully hermetic 9.5kg 1/5HP power input 437W cylinder capacity 5.7cm <sup>3</sup> CSIR H 175.5mm 95W 128W 170W 222W 284W 355W 437W 528W test method ASHRAE ambient temperature max. 43°C		



1

<b>Part No.</b>	605008	<b>Ref. No.</b>	40103001
<b>description</b>	compressor coolant R134a type GL80TB 220-240V 50Hz HMBP fully hermetic 9.5kg 1/5HP power input 554W cylinder capacity 7.6cm <sup>3</sup> CSIR H 175.5mm 165W 215W 290W 390W 500W 615W 727W 840W test method ASHRAE ambient temperature max. 43°C		



1

<b>Part No.</b>	605009	<b>Ref. No.</b>	40103002
<b>description</b>	compressor coolant R134a type GL90TB 220-240V 50Hz HMBP fully hermetic 10.8kg 1/4HP power input 293W cylinder capacity 8.8cm <sup>3</sup> CSIR H 175.5mmW 143W 194W 259W 339W 432W 539W 661W 796W test method ASHRAE		



1

<b>Part No.</b>	605010	<b>Ref. No.</b>	40103003
<b>description</b>	compressor coolant R134a type GP12TB 220-240V 50Hz HMBP fully hermetic 11.2kg 3/8HP power input 661W cylinder capacity 12cm <sup>3</sup> CSIR H 203.6mmW 143W 194W 259W 339W 432W 539W 661W 796W test method ASHRAE ambient temperature max. 43°C		



1

<b>Part No.</b>	605011	<b>Ref. No.</b>	40103004
<b>description</b>	compressor coolant R134a type GP14TB 220-240V 50Hz HMBP fully hermetic 11.5kg 3/8HP power input 566W cylinder capacity 14cm <sup>3</sup> CSIR H 203.6mm 191W 271W 373W 497W 643W 810W 999W 1209W test method ASHRAE ambient temperature max. 43°C		

## fans

### axial fans

#### ebm-papst



1

<b>Part No.</b>	601038 <sup>1</sup>	<b>Ref. No.</b>	40701007	
<b>description</b>	axial fan L 80mm W 80mm H 38mm 230VAC 50/60Hz 12W bearing ball bearing manuf. no. 8556N metal connection cable 300mm ebm-papst fan wheel ø 75mm temp.-resist. 90°C airflow 50m <sup>3</sup> /h			
<b>accessories for</b>	601038			
	<b>Part No.</b>	691102	<b>Ref. No.</b>	—
	guard ø 75mm mounting distance 71mm for axial fan 80mm			

<sup>1</sup>with ball bearings





refrigeration fans

refrigeration motors universal

ebm-papst

IQ series



1

<b>Part No.</b>	601893	<b>Ref. No.</b>	40701060
<b>description</b>	fan motor 10W 230V 50/60Hz L1 43.5mm L3 82mm W 67mm cable length 1500mm 1300rpm ebm-papst IQ3612 5 mounting options bearing ball bearing		

standard motors



1

<b>Part No.</b>	601287	<b>Ref. No.</b>	40701002
<b>description</b>	fan motor 10W 230V 50Hz L1 43mm L3 81mm W 83mm cable length 450mm		
<b>spare parts for</b>	601287		
	<b>Part No.</b>	601413	<b>Ref. No.</b> —
	fixing plate suitable for fanwheel ED ø 32mm shaft ø 7 mounting distance 26mm		



1

<b>Part No.</b>	601286	<b>Ref. No.</b>	40701001
<b>description</b>	fan motor M4Q045-CA01-01 7W 230V 50Hz L1 43mm L3 81mm W 83mm cable length 450mm		
<b>spare parts for</b>	601286		
	<b>Part No.</b>	601413	<b>Ref. No.</b> —
	fixing plate suitable for fanwheel ED ø 32mm shaft ø 7 mounting distance 26mm		

multi fit fan motors



1

<b>Part No.</b>	601758	<b>Ref. No.</b>	40701012
<b>description</b>	fan motor 16W 230V 50/60Hz L1 43.5mm L3 87mm W 72mm cable length 1500mm 1300/1550rpm ebm-papst M4Q045-CF01-75 5 mounting options bearing slide bearing		
<b>spare parts for</b>	601758		
	<b>Part No.</b>	601413	<b>Ref. No.</b> —
	fixing plate suitable for fanwheel ED ø 32mm shaft ø 7 mounting distance 26mm		



1

<b>Part No.</b>	601759	<b>Ref. No.</b>	40701011
<b>description</b>	fan motor 18W 230V 50/60Hz L1 43.5mm L3 93mm W 78mm cable length 1500mm 1300/1550rpm ebm-papst M4Q045-DA01-75 5 mounting options bearing slide bearing		
<b>spare parts for</b>	601759		
	<b>Part No.</b>	601413	<b>Ref. No.</b> —
	fixing plate suitable for fanwheel ED ø 32mm shaft ø 7 mounting distance 26mm		

accessories

fan wheels

aluminium



1

<b>Part No.</b>	601385	<b>Ref. No.</b>	40801005
<b>description</b>	fan wheel sucking ø 172mm fan wheel mounting 25.4mm blade angle 34° W 42mm aluminium		



1

<b>Part No.</b>	601282	<b>Ref. No.</b>	40801001
<b>description</b>	fan wheel sucking ø 200mm fan wheel mounting 25.4mm blade angle 34° W 44mm aluminium		

1

<b>Part No.</b>	601283	<b>Ref. No.</b>	40801002
<b>description</b>	fan wheel sucking ø 230mm fan wheel mounting 25.4mm blade angle 28° W 41mm aluminium		

1

<b>Part No.</b>	601284	<b>Ref. No.</b>	40801003
<b>description</b>	fan wheel sucking ø 254mm fan wheel mounting 25.4mm blade angle 28° W 42mm aluminium		

cold air circulating fans (complete)

1

<b>Part No.</b>	601964	<b>Ref. No.</b>	40701045	
<b>description</b>	fan A2E250AM06-12 fan wheel ø 250mm blades 9 230V 50/60Hz 115/150W ø 250mm 2450rpm cable length 1400mm sucking suitable capacitor 3µF			
<b>spare parts for</b>	601964			
	<b>Part No.</b>	365137	<b>Ref. No.</b>	—
	capacitor capacity 3µF 450V tolerance 5% 50/60Hz ambient temperature max. -25 to +85°C ø 25mm L 56mm M8 plastic connection cable 250mm 416.17.77GF protection			

cross flow fans

ebm-papst

1

<b>Part No.</b>	601291	<b>Ref. No.</b>	40701006	
<b>description</b>	cross flow fan QLZ06/0018A335-2524L-74rk roller ø 60mm roller length 180mm laminated core thickness 23mm motor position left 220-240V/50-60Hz 30W bearing silicone connection male faston 6.3mm airflow 150m³/h 0 up to +60°C 220-240V 50Hz			
<b>accessories for</b>	601291			
	<b>Part No.</b>	550782	<b>Ref. No.</b>	44303016
	connecting cable L 3100mm			



1



<b>Part No.</b>	601290	<b>Ref. No.</b>	40701008
<b>description</b>	cross flow fan QLZ06/1800A310-2524L-71rk roller ø 60mm roller length 180mm laminated core thickness 23mm motor position right 220-240V/50-60Hz 30W universal bearing silicone connection male faston 6.3mm airflow 170m <sup>3</sup> /h 0 up to +60°C 230V 50Hz		
<b>accessories for</b>	601290		
	<b>Part No.</b>	<b>Ref. No.</b>	44303016
	connecting cable L 3100mm		

**COPREL**  
with moulded coils

1



<b>Part No.</b>	602103	<b>Ref. No.</b>	40701051
<b>description</b>	cross flow fan COPREL TFL roller ø 45mm roller length 240mm laminated core thickness 15mm motor position left 230V/50-60Hz 16W universal bearing silicone connection cable 3000mm airflow 110m <sup>3</sup> /h -10 up to +50°C		

1



<b>Part No.</b>	602105	<b>Ref. No.</b>	40701050
<b>description</b>	cross flow fan COPREL TFR roller ø 45mm roller length 240mm laminated core thickness 15mm motor position right 230V/50-60Hz 16W universal bearing silicone connection cable 3000mm airflow 110m <sup>3</sup> /h -10 up to +50°C		

**electric accessories**

**cables**  
connection cables

1



<b>Part No.</b>	550782	<b>Ref. No.</b>	44303016
<b>description</b>	connecting cable L 3100mm		

**equipment-specific units**

**for fridges**

**drawers**

**drawers**

1



<b>Part No.</b>	695269	<b>Ref. No.</b>	60602686
<b>description</b>	drawer L 550mm W 320mm H 100mm		

**for refrigerated counters**

**worktops**

1



<b>Part No.</b>	695268	<b>Ref. No.</b>	45205014
<b>description</b>	cutting board L 1295mm W 150mm H 25mm		

1



<b>Part No.</b>	695267	<b>Ref. No.</b>	45205013
<b>description</b>	cutting board L 860mm W 150mm H 25mm		

→ electric components



1

<b>Part No.</b>	695266	<b>Ref. No.</b>	45205015 61001081
<b>description</b>	cutting board L 880mm W 150mm H 25mm		



1

<b>Part No.</b>	693817	<b>Ref. No.</b>	44901021
<b>description</b>	glass panel L 1460mm W 280mm thickness 10mm rectangular		

## for freezer cabinets

## spare parts and accessories



1

<b>Part No.</b>	692116	<b>Ref. No.</b>	60607149
<b>description</b>	mounting set		



1

<b>Part No.</b>	693822	<b>Ref. No.</b>	44901058
<b>description</b>	glass panel L 1460mm W 340mm thickness 10mm rectangular		

## glass panels



1

<b>Part No.</b>	693818	<b>Ref. No.</b>	44901016
<b>description</b>	glass panel L 1440mm W 156mm thickness 10mm rectangular		

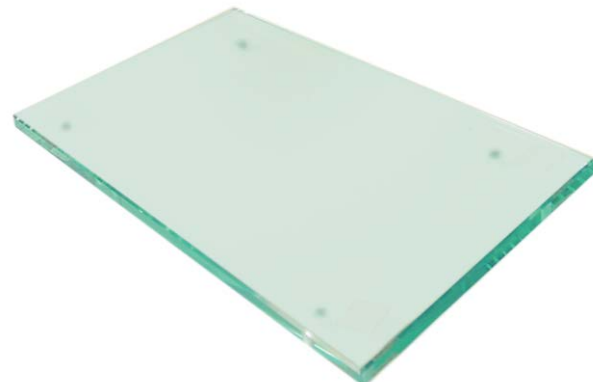

1

<b>Part No.</b>	693816	<b>Ref. No.</b>	44901015
<b>description</b>	glass panel L 342/378mm W 165/185mm thickness 10mm trapezoidal Qty 2 pcs		

1

<b>Part No.</b>	693821	<b>Ref. No.</b>	44901056
<b>description</b>	glass panel L 380mm W 183mm thickness 10mm dimensions 380(340)x183(163)mm		



1

<b>Part No.</b>	693811	<b>Ref. No.</b>	44901068
<b>description</b>	glass panel L 571mm W 260mm thickness 8mm		



1

<b>Part No.</b>	693812	<b>Ref. No.</b>	44901067
<b>description</b>	glass panel L 854mm W 260mm thickness 8mm rectangular		

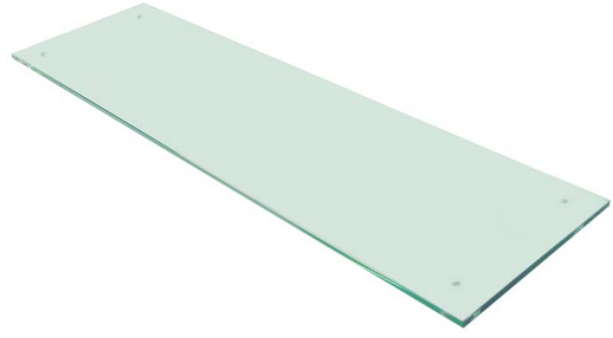

1

<b>Part No.</b>	693813	<b>Ref. No.</b>	44901066
<b>description</b>	glass panel L 870mm W 250mm thickness 10mm rectangular		

1

<b>Part No.</b>		<b>Ref. No.</b>	61004004
<b>description</b>	glass panel set 2-piece		

1

<b>Part No.</b>		<b>Ref. No.</b>	60607168
<b>description</b>	glass panel set 2-piece		

1

<b>Part No.</b>		<b>Ref. No.</b>	60607167
<b>description</b>	glass panel set 2-piece		

1

<b>Part No.</b>		<b>Ref. No.</b>	60607218
<b>description</b>	glass panel set 2-piece		



1

<b>Part No.</b>		<b>Ref. No.</b>	60607217
<b>description</b>	glass panel set 2-piece		

## for display coolers

## glass panels

## accessories



1

<b>Part No.</b>	695264	<b>Ref. No.</b>	42001007
<b>description</b>	bracket for glass plate double		



1

<b>Part No.</b>	695265	<b>Ref. No.</b>	42001008
<b>description</b>	bracket for glass plate triple		

## for espresso machines

## brewing units

## shower screens

## screws



1

<b>Part No.</b>	560300	<b>Ref. No.</b>	44404002
<b>description</b>	countersunk screw thread M5 L 16mm SS DIN 963/ISO 2009 Qty 1 pcs intake slotted head ø 9mm		

## for convection ovens/combi-steamers

## doors



1

<b>Part No.</b>	695263	<b>Ref. No.</b>	42001005
<b>description</b>	bracket for glass plate		

## door mechanics

## holders



1

<b>Part No.</b>	695263	<b>Ref. No.</b>	42001005
<b>description</b>	bracket for glass plate		

## handles and hand wheels

## bracket handles



1

<b>Part No.</b>	690450	<b>Ref. No.</b>	42201011
<b>description</b>	pull handle L 275mm H 43mm mounting distance 227mm		

## recessed handles



1

<b>Part No.</b>	695262	<b>Ref. No.</b>	42601036
<b>description</b>	recessed handle		

## hinges

## piano hinges

## producer-specific

## MERCATUS



1

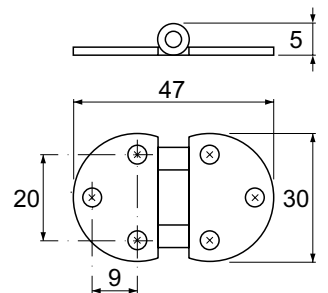

<b>Part No.</b>	690961	<b>Ref. No.</b>	42001001
<b>description</b>	hinge L 47mm W 30mm H 5mm mounting distance 20mm mounting distance 19mm hole ø 4.5mm thickness 2mm		



spring assisted hinges

producer-specific

MERCATUS



<b>Part No.</b>	690957	<b>Ref. No.</b>	42001059 + 42001026 60601201
<b>description</b>	hinge mounting pos. left		



<b>Part No.</b>	690956	<b>Ref. No.</b>	42001025 42001025+42001058 60601202
<b>description</b>	hinge mounting pos. right		

**spare parts for** 690956



<b>Part No.</b>	690958	<b>Ref. No.</b>	42001027 42001058 42001059 60601041
-----------------	--------	-----------------	--

hinge bearing without bolt

door bearing



<b>Part No.</b>	695260	<b>Ref. No.</b>	44601011
<b>description</b>	bush		



<b>Part No.</b>	700896	<b>Ref. No.</b>	60701220
<b>description</b>	hinge L 175mm mounting pos. lower with bolt shaft ø 7mm		



<b>Part No.</b>	690960	<b>Ref. No.</b>	60605086
<b>description</b>	hinge bearing mounting pos. left without bolt		



<b>Part No.</b>	690959	<b>Ref. No.</b>	60605085
<b>description</b>	hinge bearing mounting pos. right without bolt		



<b>Part No.</b>	690958	<b>Ref. No.</b>	42001027 42001058 42001059 60601041
<b>description</b>	hinge bearing without bolt		

miscellaneous



<b>Part No.</b>	690963	<b>Ref. No.</b>	42001004
<b>description</b>	hinge left		



<b>Part No.</b>	690962	<b>Ref. No.</b>	42001003
<b>description</b>	hinge right		



**pullouts**

**frame**



<b>Part No.</b>	690797	<b>Ref. No.</b>	60602692
<b>description</b>	frame fortelescopic rail mounting pos. left		



<b>Part No.</b>	690796	<b>Ref. No.</b>	60602691
<b>description</b>	frame fortelescopic rail mounting pos. right		

**equipment feet and end caps**

**equipment feet**

**with fixing plate**



<b>Part No.</b>	700712	<b>Ref. No.</b>	42101001
<b>description</b>	equipment foot tube ø 57mm plate size 80x100mm hole distance 60x78mm H 135-215mm SS size 2 1/4" Qty 1 pcs		



<b>Part No.</b>		<b>Ref. No.</b>	42101004
<b>description</b>	equipment foot tube ø 57mm plate size 90x100mm hole distance 60x78mm H 130-210mm SS size 2" Qty 1 pcs		

**TENTE**

**with fixing plate**

**chrome-plated steel**



<b>Part No.</b>	700344	<b>Ref. No.</b>	42701003 42701005
<b>description</b>	swivel castor ø 100mm plate fixing housing zinc-plated sheet steel plate size 105x85mm hole distance 60x78mm capacity 80kg bearing slide bearing wheel body polypropylene tread TPE tyres H 128mm wheel width 32mm Qty 1 pcs		

**miscellaneous**

**with fixing plate**

**ø100mm**



<b>Part No.</b>	700345	<b>Ref. No.</b>	42701004
<b>description</b>	swivel castor with swivel brake ø 100mm plates fixing 105x85mm		





diverse sets



1

<b>Part No.</b>	700912	<b>Ref. No.</b>	10001009-0-0-0
<b>description</b>	swivel castor set ø 100mm plates fixing 105x85mm bearing ball bearing H 127mm wheel width 38mm 2x with swivel brake 4-piece		

shelves and shelf rails



grates

universal

without upstand



1

<b>Part No.</b>	970125	<b>Ref. No.</b>	46501009	
<b>description</b>	grate W 325mm D 530mm GN 1/1 plastic-coated steel crossing wires 1 white suitable for refrigerator			
<b>accessories for</b>	970125			
	<b>Part No.</b>	690330	<b>Ref. No.</b>	—
	rack L 1000mm W 22mm H 4mm aperture 3x8mm hole distance 12.5mm stainless steel			
	<b>Part No.</b>	694700	<b>Ref. No.</b>	—
	shelf support L 31/28mm W 22mm H 18mm SS Qty 12 pcs			
	<b>Part No.</b>	694701	<b>Ref. No.</b>	—
	shelf support L 31/28mm W 22mm H 17mm SS with hook Qty 12 pcs			



1

<b>Part No.</b>	970468	<b>Ref. No.</b>	46501003 46502001
<b>description</b>	grate W 400mm D 480mm plastic-coated steel crossing wires 1 suitable for refrigerator		



1

<b>Part No.</b>	970469	<b>Ref. No.</b>	46501002 46502007
<b>description</b>	grate W 400mm D 600mm plastic-coated steel crossing wires 1 suitable for refrigerator		







1

<b>Part No.</b>	970660	<b>Ref. No.</b>	61404045
<b>description</b>	grate W 835mm D 805mm		

with upstand



1

<b>Part No.</b>	970556	<b>Ref. No.</b>	46502004	
<b>description</b>	grate W 530mm D 650mm GN 2/1 plastic-coated steel with hinge camp wire gauge frame 9mm lengthwise wires gauge 5mm crossing wires 2 white suitable for refrigerator			
<b>accessories for</b>	970556			
	<b>Part No.</b>	690330	<b>Ref. No.</b>	—
	rack L 1000mm W 22mm H 4mm aperture 3x8mm hole distance 12.5mm stainless steel			
	<b>Part No.</b>	690332	<b>Ref. No.</b>	—
	shelf support L 31/28mm W 22mm H 17mm SS with hook Qty 1 pcs			
	<b>Part No.</b>	694700	<b>Ref. No.</b>	—
	shelf support L 31/28mm W 22mm H 18mm SS Qty 12 pcs			
	<b>Part No.</b>	694701	<b>Ref. No.</b>	—
	shelf support L 31/28mm W 22mm H 17mm SS with hook Qty 12 pcs			



## producer-specific

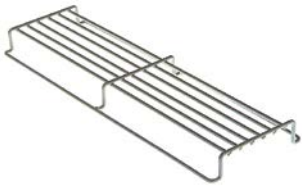

1

<b>Part No.</b>	970467	<b>Ref. No.</b>	46501004
<b>description</b>	grate W 125mm D 385mm H 30mm steel suitable for refrigerator		

## shelf rails and supports

### producer-specific



1

<b>Part No.</b>	700889	<b>Ref. No.</b>	45907006
<b>description</b>	bolt $\varnothing$ 7mm L 10mm M5 stainless steel		



1

<b>Part No.</b>	695249	<b>Ref. No.</b>	60602677
<b>description</b>	pair of setting bar E-shape L 560mm W 31mm H 14mm mounting pos. left/right		



1

<b>Part No.</b>	695252	<b>Ref. No.</b>	61001070
<b>description</b>	pair of setting bar E-shape L 568mm W 10mm H 30mm mounting pos. left/right		



1

<b>Part No.</b>	695860	<b>Ref. No.</b>	60701431
<b>description</b>	pair of setting bar E-shape L 635mm W 14mm H 15mm mounting pos. left/right		

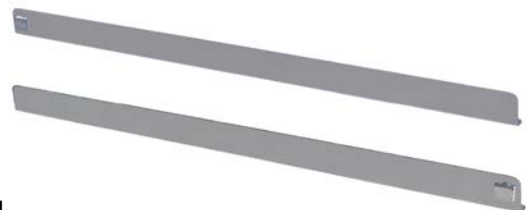

1

<b>Part No.</b>	695250	<b>Ref. No.</b>	60603128
<b>description</b>	pair of setting bar L-shape L 580mm W 31mm H 18mm mounting pos. left/right		
<b>For models:</b>	PK20, PK25		



1

<b>Part No.</b>	695248	<b>Ref. No.</b>	60601785
<b>description</b>	pair of setting bar U-shape L 460mm W 16mm H 29mm mounting pos. left/right		



1

<b>Part No.</b>	695251	<b>Ref. No.</b>	60604292
<b>description</b>	pair of setting bar U-shape L 473mm W 16mm H 29mm mounting pos. left/right		



1

<b>Part No.</b>	695253	<b>Ref. No.</b>	60601694
<b>description</b>	rack L 285mm W 31mm		



1

<b>Part No.</b>	695258	<b>Ref. No.</b>	60601470
<b>description</b>	rack L 338mm W 48mm		



1



<b>Part No.</b>	695259	<b>Ref. No.</b>	61001028
<b>description</b>	rack L 340mm W 31mm		

1



<b>Part No.</b>	695256	<b>Ref. No.</b>	60604278
<b>description</b>	rack L 410mm W 32mm		

1



<b>Part No.</b>	695255	<b>Ref. No.</b>	60602574
<b>description</b>	rack L 483mm W 31mm mounting pos. rear		

1



<b>Part No.</b>	695254	<b>Ref. No.</b>	60601693
<b>description</b>	rack L 505mm W 31mm		

1

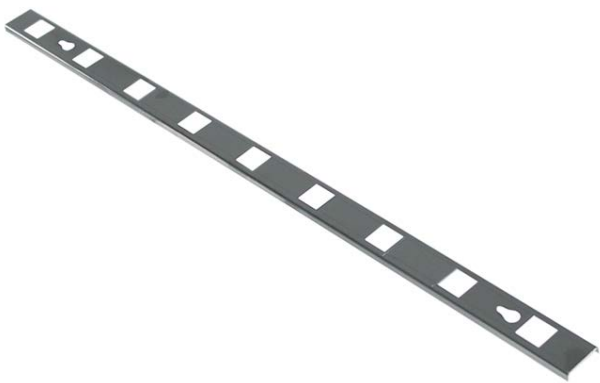

<b>Part No.</b>	695257	<b>Ref. No.</b>	60604277
<b>description</b>	rack L 650mm W 32mm		

1



<b>Part No.</b>	700888	<b>Ref. No.</b>	61503011
<b>description</b>	rack L 990mm W 32mm mounting pos. left/right hole distance 225mm aperture 20x20mm		

## gaskets

### refrigeration gaskets

#### plug-in gaskets

#### profile 9048

We offer custom-made gaskets for this profile

1

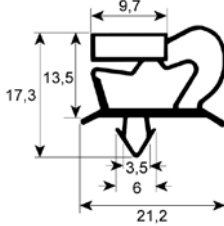

<b>Part No.</b>	900549	<b>Ref. No.</b>	41801031
<b>description</b>	refrigeration gasket profile 9048 W 160mm L 395mm plug size		

1

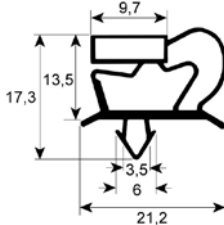

<b>Part No.</b>	901346	<b>Ref. No.</b>	41801023
<b>description</b>	refrigeration gasket profile 9048 W 222mm L 400mm plug size		

1

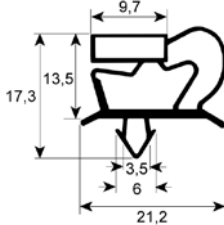

<b>Part No.</b>	900548	<b>Ref. No.</b>	41801030
<b>description</b>	refrigeration gasket profile 9048 W 267mm L 394mm plug size		



<b>Part No.</b>	900546	<b>Ref. No.</b>	41801028
<b>description</b>	refrigeration gasket profile 9048 W 267mm L 472mm plug size		

<b>Part No.</b>	900553	<b>Ref. No.</b>	41801021
<b>description</b>	refrigeration gasket profile 9048 W 394mm L 484mm plug size		

<b>Part No.</b>	900557	<b>Ref. No.</b>	41801016
<b>description</b>	refrigeration gasket profile 9048 W 285mm L 390mm plug size		

<b>Part No.</b>	900550	<b>Ref. No.</b>	41801029
<b>description</b>	refrigeration gasket profile 9048 W 394mm L 600mm plug size		

<b>Part No.</b>	900555	<b>Ref. No.</b>	41801004
<b>description</b>	refrigeration gasket profile 9048 W 285mm L 465mm plug size		

<b>Part No.</b>	900554	<b>Ref. No.</b>	41801002
<b>description</b>	refrigeration gasket profile 9048 W 465mm L 618mm plug size		

<b>Part No.</b>	900551	<b>Ref. No.</b>	41801011
<b>description</b>	refrigeration gasket profile 9048 W 363mm L 466mm plug size		

<b>Part No.</b>	900547	<b>Ref. No.</b>	41801027
<b>description</b>	refrigeration gasket profile 9048 W 470mm L 600mm plug size		

<b>Part No.</b>	900556	<b>Ref. No.</b>	41801015
<b>description</b>	refrigeration gasket profile 9048 W 390mm L 618mm plug size		

<b>Part No.</b>	900552	<b>Ref. No.</b>	41801007
<b>description</b>	refrigeration gasket profile 9048 W 470mm L 770mm plug size		



Part No.	902258	Ref. No.	N/A
description	refrigeration gasket profile 9048 Wmm L 2500mm		

profile 9703

We offer custom-made gaskets for this profile

Part No.	901506	Ref. No.	41801056
description	refrigeration gasket profile 9703 W 478mm L 632mm glass door		

profile 9194

Part No.	902403	Ref. No.	41801037
description	refrigeration gasket profile 9194 W 210mm L 395mm plug size		

Part No.	901344	Ref. No.	41801022
description	refrigeration gasket profile 9194 W 400mm L 174mm plug size Qty 1		

Part No.	901345	Ref. No.	41801024
description	refrigeration gasket profile 9194 W 405mm L 400mm plug size Qty 1		

Part No.	901309	Ref. No.	41801025
description	refrigeration gasket profile 9194 W 650mm L 1480mm plug size Qty 1		

refrigeration cycle components

valves

expansion valves

DANFOSS

valves

type TUA/TUB/TUC

Part No.	750016	Ref. No.	41604006
description	expansion valve DANFOSS type TUB coolant R134a angled 90° thermostatically controlled inlet 6mm ODF outlet 12mm ODF p max 34bar -40 up to +10°C capillary pipe 800mm		





## shut-off valves

## 3-way



1

<b>Part No.</b>	750073	<b>Ref. No.</b>	41602002
<b>description</b>	shut-off valve CASTEL type 6070/23M8 3-way connection 1: 7/16" UNF (1/4" SAE) connection 2: 5/8" UNF (3/8" SAE) connection 3: 8mm soldering connection throughput 1.29m <sup>3</sup> /h p max 30bar -60 up to +120°C		

## filter driers

## DANFOSS



1

<b>Part No.</b>	750037	<b>Ref. No.</b>	41002006
<b>description</b>	dryer connection 7/16" UNF (1/4" SAE) 41cm <sup>3</sup> p max 46bar -40 up to +70°C 216g type DCL 032 size 3 cubic inches		

## evaporators

## for fridges

## producer-specific



1

<b>Part No.</b>	750157	<b>Ref. No.</b>	40209002
<b>description</b>	evaporator L 1250mm W 75mm H 150mm		



1

<b>Part No.</b>	750158	<b>Ref. No.</b>	40209003
<b>description</b>	evaporator L 1750mm W 155mm H 80mm		



1

<b>Part No.</b>	750159	<b>Ref. No.</b>	40209004
<b>description</b>	evaporator L 2244mm W 153mm H 80mm		

1

<b>Part No.</b>		<b>Ref. No.</b>	40211003
<b>description</b>	evaporator L 370mm W 370mm complete with fan		

## spare parts for



<b>Part No.</b>	601030	<b>Ref. No.</b>	—
<b>description</b>	axial fan L 119mm W 119mm H 38mm 230VAC 50Hz 18W bearing ball bearing manuf. no. 4656Z metal connection male faston 2.8mm ebm-papst fan wheel ø 110mm temp.-resist. 75°C		

1

<b>Part No.</b>	750162	<b>Ref. No.</b>	40211001
<b>description</b>	evaporator L 420mm W 85mm H 345mm complete with fan		

## spare parts for



<b>Part No.</b>	601030	<b>Ref. No.</b>	—
<b>description</b>	axial fan L 119mm W 119mm H 38mm 230VAC 50Hz 18W bearing ball bearing manuf. no. 4656Z metal connection male faston 2.8mm ebm-papst fan wheel ø 110mm temp.-resist. 75°C		

1

<b>Part No.</b>	750161	<b>Ref. No.</b>	40210001
<b>description</b>	evaporator L 445mm W 355mm H 68mm		

1

<b>Part No.</b>	750156	<b>Ref. No.</b>	40209001
<b>description</b>	evaporator L 710mm W 80mm H 155mm		

## evaporation and condensing trays

### unheated condensing trays

1

<b>Part No.</b>		<b>Ref. No.</b>	42601063
<b>description</b>	condensing tray L 545mm W 81mm H 25mm plastic		

## fastening material

### screws

#### countersunk screws



1

<b>Part No.</b>	560300	<b>Ref. No.</b>	44404002
<b>description</b>	countersunk screw thread M5 L 16mm SS DIN 963/ISO 2009 Qty 1 pcs intake slotted head ø 9mm		

### hexagonal screws



1

<b>Part No.</b>	560089	<b>Ref. No.</b>	44401003
<b>description</b>	hexagonal screw thread M6 thread L 25mm SS WS 10 Qty 20 pcs DIN 933 / ISO 4017		

1

<b>Part No.</b>		<b>Ref. No.</b>	44401050
<b>description</b>	hexagonal screw thread M5 thread L 12mm		

### nuts

#### cap nuts



1

<b>Part No.</b>	560136	<b>Ref. No.</b>	44503007
<b>description</b>	cap nuts thread M5 WS 8 SS Qty 20 pcs DIN/ISO DIN 1587		

**GASTRO**PARTS.COM

