



**GASTROPARTS**

# Malag

- [EN]** Equipment
- [DE]** Geräte
- [ES]** Aparatos
- [FR]** Équipement
- [IT]** Attrezzature
- [PL]** Urządzenia
- [RU]** Оборудование

✉ [gastroparts@gastroparts.com](mailto:gastroparts@gastroparts.com)

☎ tel. +48 56 657 00 66

📘 [fb.com/gastroparts.global](https://fb.com/gastroparts.global)

**GASTROPARTS.COM**





## heating elements

### heating elements for ovens

<b>Part No.</b>	418225	<b>Ref. No.</b>	105597 (old)
<b>description</b>	heating element 1000W 230V windings 3 mounting pos. upper		

<b>Part No.</b>	415315	<b>Ref. No.</b>	105597
<b>description</b>	heating element 2000W 230V heating circuits 1 L 327mm W 228mm L1 85mm L2 244mm W1 98mm W2 31mm flange length 71mm flange width 23mm hole distance 56mm hole ø M4mm tube ø 6.3mm connection plug-in connection windings 3 rectangular flange grill setting oven		
<b>accessories for</b>	415315		
	<b>Part No.</b>	550404	<b>Ref. No.</b> —
	power socket I-II phase 240V max. 16A countries I with screw connection for heating element		
	<b>Part No.</b>	550405	<b>Ref. No.</b> —
	power socket male faston 6.3mm for heating element 2-pole + earthing		

### heating elements for bain maries

<b>Part No.</b>	415323	<b>Ref. No.</b>	105619 105643
<b>description</b>	heating element 1600W 230V heating circuits 1 L 383mm W 96mm flange length 45mm flange width 12mm hole distance 36mm tube ø 6.3mm cable length 290mm rectangular flange hole ø M5mm dry heating element L1 14mm L2 369mm W1 72mm W2 24mm		

<b>Part No.</b>	415322	<b>Ref. No.</b>	105627
<b>description</b>	heating element 2600W 230V heating circuits 1 L 468mm W 130mm flange length 45mm flange width 17mm hole distance 36mm connection length 53mm tube ø 6.3mm cable length 200mm rectangular flange thread M5 dry heating element L1 13mm L2 455mm W1 105mm W2 25mm		

### heating elements for fryers

<b>Part No.</b>	418226	<b>Ref. No.</b>	144436
<b>description</b>	heating element 6500W 220V heating circuits 3 L 370mm W 185mm H 255mm L1 90mm L2 280mm W1 39mm W2 107mm H1 343mm H2 27mm windings 9 flange ø 43mm rotation flange cable length 1450mm connection cable immersion heater mounting ø 39mm		
<b>For models:</b>	EF224, FF5-224		

### heating elements for heated cabinets

<b>Part No.</b>	415323	<b>Ref. No.</b>	105619 105643
<b>description</b>	heating element 1600W 230V heating circuits 1 L 383mm W 96mm flange length 45mm flange width 12mm hole distance 36mm tube ø 6.3mm cable length 290mm rectangular flange hole ø M5mm dry heating element L1 14mm L2 369mm W1 72mm W2 24mm		

### heating rods

<b>Part No.</b>	480063	<b>Ref. No.</b>	117994
<b>description</b>	heating rod type E2 450W 220V W 22.5mm heated length 700mm		



<b>Part No.</b>	480064	<b>Ref. No.</b>	117995
<b>description</b>	heating rod type E2 450W 380V W 22.5mm heated length 700mm		

### pilot heating elements

<b>Part No.</b>	415653	<b>Ref. No.</b>	105708
<b>description</b>	heating element 600W 230V heating circuits 1 mounting ø 47.5mm L 280mm W 36mm H 16mm round flange connection male faston 6.3mm immersion heater tube ø 6.3mm thermostat sleeves ø 7mm length thermostat sleeves 220mm number of thermostat sleeves 1 pilot heating element		
<b>spare parts for</b>	415653		
	<b>Part No.</b>	510408	<b>Ref. No.</b> —
	O-ring EPDM thickness 5.34mm ID ø 47mm Qty 1 pcs		

Table continues overleaf









accessories for	415653		
	Part No.	510562	Ref. No. —
	O-ring silicone thickness 5.34mm ID ø 47mm Qty 1 pcs		
	Part No.	550675	Ref. No. —
	O-ring Viton thickness 6mm ID ø 47mm Qty 1 pcs		



## quartz heating elements





1			
Part No.	415309	Ref. No.	12050000 (14-01)
description	quartz heating element 400W 230V L 340mm ø 10mm connection plug-in connection		









## immersion heating elements

with round flange ø47.5mm

1			
Part No.	415581	Ref. No.	105716
description	heating element 3000W 230V heating circuits 3 L 268mm W 36mm H 28mm tube ø 6.3mm connection cable cable length 300mm immersion heater mounting ø 47.5mm		
accessories for	415581		
	Part No.	510562	Ref. No. —
	O-ring silicone thickness 5.34mm ID ø 47mm Qty 1 pcs		
	Part No.	520235	Ref. No. —
	3 hole flange hole distance 70.5mm perforation ø 6.5mm ID ø 53.5mm		
	Part No.	520236	Ref. No. —
	flange for heating element ID ø 50mm ED ø 90mm hole ø 6.5mm 3 holes		
	Part No.	521012	Ref. No. —
	gasket graphite ED ø 15mm ID ø 5mm thickness 1.2mm Qty 1 pcs		
	Part No.	550002	Ref. No. —
	tension strap H 10mm L 21mm W 10mm hole ø 6.5mm for heating element		
	Part No.	550362	Ref. No. —
	blind flange ø 64mm mounting ø 47.5mm		

1			
Part No.	415263	Ref. No.	105724
description	heating element 4500W 230V heating circuits 3 mounting ø 47.5mm L 375mm W 38mm H 46mm round flange connection male faston 6.3mm immersion heater tube ø 6.3mm thermostat sleeves ø 7mm number of thermostat sleeves 1 length thermostat sleeves 240mm thermostat sleeve not clinging		
accessories for	415263		
	Part No.	510408	Ref. No. —
	O-ring EPDM thickness 5.34mm ID ø 47mm Qty 1 pcs		
	Part No.	520235	Ref. No. —
	3 hole flange hole distance 70.5mm perforation ø 6.5mm ID ø 53.5mm		

accessories for	415263		
	Part No.	520236	Ref. No. —
	flange for heating element ID ø 50mm ED ø 90mm hole ø 6.5mm 3 holes		
	Part No.	521012	Ref. No. —
	gasket graphite ED ø 15mm ID ø 5mm thickness 1.2mm Qty 1 pcs		
	Part No.	550002	Ref. No. —
	tension strap H 10mm L 21mm W 10mm hole ø 6.5mm for heating element		
	Part No.	550362	Ref. No. —
	blind flange ø 64mm mounting ø 47.5mm		

1			
Part No.	415663	Ref. No.	105732
description	heating element 6000W 230V heating circuits 3 mounting ø 47.5mm L 400mm W 40mm H 28mm round flange connection M4 immersion heater tube ø 6.3mm thermostat sleeves ø 7mm number of thermostat sleeves 2 length thermostat sleeves 150mm thermostat sleeve not clinging		
spare parts for	415663		
	Part No.	510408	Ref. No. —
	O-ring EPDM thickness 5.34mm ID ø 47mm Qty 1 pcs		
accessories for	415663		
	Part No.	510408	Ref. No. —
	O-ring EPDM thickness 5.34mm ID ø 47mm Qty 1 pcs		
	Part No.	510562	Ref. No. —
	O-ring silicone thickness 5.34mm ID ø 47mm Qty 1 pcs		
	Part No.	520235	Ref. No. —
	3 hole flange hole distance 70.5mm perforation ø 6.5mm ID ø 53.5mm		
	Part No.	520236	Ref. No. —
	flange for heating element ID ø 50mm ED ø 90mm hole ø 6.5mm 3 holes		
	Part No.	550002	Ref. No. —
	tension strap H 10mm L 21mm W 10mm hole ø 6.5mm for heating element		
	Part No.	550362	Ref. No. —
	blind flange ø 64mm mounting ø 47.5mm		

## hot plates

## square &amp; rectangular

with radiused edge

1			
Part No.	490065	Ref. No.	161632
description	hot plate dimensions 220x220mm 2000W 230V with spill ring connection 4 screw clamps protector no square		



1

<b>Part No.</b>	490067	<b>Ref. No.</b>	161634
<b>description</b>	hot plate dimensions 220x220mm 2000W 400V with spill ring connection 4 screw clamps protector no square		
<b>accessories for</b>	490067		
	<b>Part No.</b>	<b>Ref. No.</b>	—
	sealing cord ø 10mm Qty supplied by meter		



1

<b>Part No.</b>	490057 <sup>1</sup>	<b>Ref. No.</b>	117902
<b>description</b>	hot plate dimensions 300x300mm 3000W 400V with spill ring connection 4 screw clamps protector yes square		

<sup>1</sup>incl. protector



1

<b>Part No.</b>	490066 <sup>1</sup>	<b>Ref. No.</b>	161624
<b>description</b>	hot plate dimensions 220x220mm 2600W 230V with spill ring connection 4 screw clamps protector yes square		

<sup>1</sup>incl. protector



1

<b>Part No.</b>	490071 <sup>1</sup>	<b>Ref. No.</b>	117889
<b>description</b>	hot plate dimensions 300x300mm 4000W 230V with spill ring connection 4 screw clamps protector yes square		

<sup>1</sup>incl. protector



1

<b>Part No.</b>	490068 <sup>1</sup>	<b>Ref. No.</b>	161635
<b>description</b>	hot plate dimensions 220x220mm 2600W 400V with spill ring connection 4 screw clamps protector yes square		

<sup>1</sup>incl. protector



1

<b>Part No.</b>	490074 <sup>1</sup>	<b>Ref. No.</b>	117890
<b>description</b>	hot plate dimensions 300x300mm 4000W 400V with spill ring connection 4 screw clamps protector yes square		

<sup>1</sup>incl. protector



1

<b>Part No.</b>	490056 <sup>1</sup>	<b>Ref. No.</b>	117897
<b>description</b>	hot plate dimensions 300x300mm 3000W 230V with spill ring connection 4 screw clamps protector yes square		

<sup>1</sup>incl. protector

round

with radiused edge



for domestic and commercial kitchens



1

<b>Part No.</b>	490016	<b>Ref. No.</b>	117854
<b>description</b>	hot plate ø 180mm 2000W 230V connection 4 screw clamps with 8mm spill ring		



			
1			
<b>Part No.</b>	490020	<b>Ref. No.</b>	117846
<b>description</b>	hot plate ø 220mm 2600W 230V connection 4 screw clamps with 8mm spill ring		
<b>accessories for</b>	490020		
	<b>Part No.</b>	550796	<b>Ref. No.</b>
	fixing plate for hot plate ø220mm		

with cast brim

with screw connection

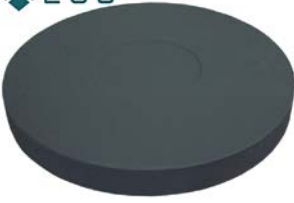
			
1			
<b>Part No.</b>	490106	<b>Ref. No.</b>	HR4067021
<b>description</b>	hot plate ø 400mm 5000W 400V connection 2x 3 screw clamps with cast edge screw bolt H 42mm		

## thermostats

control and safety thermostats

EGO

control thermostats

55.10/19\_ series

			
1			
<b>Part No.</b>	375897	<b>Ref. No.</b>	172154
<b>description</b>	thermostat t.max. 110°C 1-pole 1NC 16A probe ø 6mm probe L 270mm capillary pipe 900mm capillary pipe isolated 750mm gland nut shaft ø 6x4.6mm shaft L 23mm shaft position upper° rotation 270°		

E-G-O

			
1			
<b>Part No.</b>	375546	<b>Ref. No.</b>	105740
<b>description</b>	thermostat t.max. 110°C temperature range 30-110°C 1-pole 1NO 16A probe ø 6mm probe L 130mm capillary pipe 900mm capillary pipe isolated 900mm gland nut shaft ø 6x4.6mm shaft L 15mm shaft position upper rotation 318°		

E-G-O

			
1			
<b>Part No.</b>	375709	<b>Ref. No.</b>	172146
<b>description</b>	thermostat t.max. 110°C temperature range 86-110°C 1-pole 1NO 16A probe ø 6mm probe L 265mm capillary pipe 860mm capillary pipe isolated 800mm gland nut shaft ø 6x4.6mm shaft L 23mm shaft position upper rotation 270° with disc screw connection M14x1 disc ø 12.5mm		

55.13\_ series

E-G-O

			
1			
<b>Part No.</b>	375710	<b>Ref. No.</b>	105767
<b>description</b>	thermostat t.max. 132°C temperature range fixed 132°C 1-pole 1CO 16A probe ø 6mm probe L 86mm capillary pipe 1150mm capillary pipe isolated 350mm gland nut shaft Lmm shaft position° shaft position rotation° switch-off temp. 132°C probe SS		





<b>Part No.</b>	375012	<b>Ref. No.</b>	143702
<b>description</b>	thermostat t.max. 358°C temperature range 50-358°C 1-pole 1NO 16A probe ø 3.1mm probe L 147mm capillary pipe 1730mm capillary pipe isolated 1100mm gland nut shaft L 23mm shaft position upper rotation 270°		
<b>accessories for</b>	375012		
	<b>Part No.</b>	110247	<b>Ref. No.</b>
	knob thermostat t.max. 350°C ø 50mm shaft ø 6x4.6mm shaft flat upper black temperature range 100-350°C		



<b>Part No.</b>	375101	<b>Ref. No.</b>	105849
<b>description</b>	thermostat t.max. 360°C temperature range 140-360°C 3-pole 3NO 16A probe ø 4mm probe L 292mm capillary pipe 990mm capillary pipe isolated 500mm gland nut shaft L 23mm shaft position upper rotation 318°		

55.34\_ series



<b>Part No.</b>	375188	<b>Ref. No.</b>	105813
<b>description</b>	thermostat t.max. 110°C temperature range 30-110°C 3-pole 3NO 16A probe ø 6mm probe L 131mm capillary pipe 1160mm capillary pipe isolatedmm gland nut shaft ø 6x4.6mm shaft L 23mm shaft position upper rotation 310°		



<b>Part No.</b>	375225	<b>Ref. No.</b>	105847
<b>description</b>	thermostat t.max. 400°C temperature range 91-400°C 3-pole 3NO 16A probe ø 3.9mm probe L 308mm capillary pipe 920mm capillary pipe isolated 800mm gland nut shaft ø 6x4.6mm shaft L 23mm shaft position upper rotation 310°		

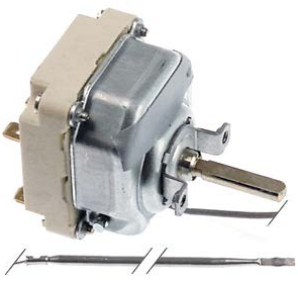

<b>Part No.</b>	375685	<b>Ref. No.</b>	105783
<b>description</b>	thermostat t.max. 300°C temperature range 50-300°C 3-pole 3NO 16A probe ø 3.1mm probe L 226mm capillary pipe 1180mm capillary pipe isolated 500mm gland nut shaft ø 6x4.6mm shaft L 23mm shaft position upper rotation 318°		

safety thermostats

55.31\_ series



<b>Part No.</b>	375686	<b>Ref. No.</b>	174963
<b>description</b>	safety thermostat switch-off temp. 250°C 3-pole 20A probe ø 6mm probe L 219mm capillary pipe 1430mm capillary pipe isolated 1100mm gland nut probe SS		



## switches and momentary switches

## cam switches

## 4-position



1

<b>Part No.</b>	300103	<b>Ref. No.</b>	106062
<b>description</b>	cam switch 4 operating positions 1NO/2CO sequence 0-1-2-3 32A shaft $\varnothing$ 6x4.6mm shaft L 23mm connection screw ceramic		

## 7-position



1

<b>Part No.</b>	300025	<b>Ref. No.</b>	106070
<b>description</b>	cam switch 7 operating positions 1NO/2CO sequence 0-1-2-3-4-5-6 16A shaft $\varnothing$ 6x4.6mm shaft L 23mm connection screw 7-position ceramic		

## accessories for 300025



<b>Part No.</b>	112172	<b>Ref. No.</b>	—
<b>description</b>	knob universal $\varnothing$ 70mm black without adaptor/dial plate		



<b>Part No.</b>	112213	<b>Ref. No.</b>	—
<b>description</b>	knob dial plate silver switch 7-position t.max.°C ED $\varnothing$ 63mm ID $\varnothing$ 45.5mm		



<b>Part No.</b>	112311	<b>Ref. No.</b>	—
<b>description</b>	knob adapter shaft $\varnothing$ 6x4.6mm L 0mm with spring		



1

<b>Part No.</b>	300106	<b>Ref. No.</b>	106072
<b>description</b>	cam switch 7 operating positions 1NO/2CO sequence 0-1-2-3-4-5-6 32A shaft $\varnothing$ 6x4.6mm shaft L 23mm connection screw 7-position shaft flat upper		

## operation switches



1

<b>Part No.</b>	300006	<b>Ref. No.</b>	143774
<b>description</b>	cam switch changeover switch 16A sequence 0-1-2-3-4-5 shaft $\varnothing$ 6x4.6mm connection male faston 6.3mm 3-pole ambient temperature max. 150°C		

## lamps

## indicator lights

## indicator lights 3-piece (housing, lens and bulb)

## lamps

## neon light bulbs



1

<b>Part No.</b>	359602	<b>Ref. No.</b>	105473
<b>description</b>	neon light bulb socket E14 230V clear $\varnothing$ 14mm L 30mm		

## screw-on/push-on fit

## neon light bulbs



1

<b>Part No.</b>	359602	<b>Ref. No.</b>	105473
<b>description</b>	neon light bulb socket E14 230V clear $\varnothing$ 14mm L 30mm		



## solenoid valves

### solenoid valves (water)

metal

BÜRKERT

solenoid valves steam (water)

2-way

0407 series



1

<b>Part No.</b>	370364	<b>Ref. No.</b>	161363 161373
<b>description</b>	solenoid valve 2-ways 230VAC connection 3/8" L 55mm DN 12mm slide-on receptacle DIN 180°C BÜRKERT type series 0407 membranes PTFE p max 10bar brass		

## pressure switches

### for steam control



1

<b>Part No.</b>	541022	<b>Ref. No.</b>	161357
<b>description</b>	pressure control steam control pressure connection vertical pressure range adjustable 0.25-4.5bar connection 1/4" pressure connection 1/4" IT		

## gas taps

### PEL

23S/V series



1

<b>Part No.</b>	101630	<b>Ref. No.</b>	112623
<b>description</b>	gas tap PEL type 23S/V gas inlet 1/2" IT bypass nozzle ø 0.35mm gas outlet 1/2" MT (tube ø 14mm) thermocouple connection M10x1 pilot connection M10x1 shaft ø 10mm shaft L 25mm shaft flat		
<b>spare parts for</b>	101630		
	<b>Part No.</b>	100455	<b>Ref. No.</b> —
	bypass nozzle type PEL23/24 bore ø 0.35mm thread M8x0.5		

<b>spare parts for</b>	101630		
	<b>Part No.</b>	101059	<b>Ref. No.</b> —
	magnet unit T1: M10x1 T2: M22x1 L 46mm ø 18mm suitable for PEL23S M10x1		
	<b>Part No.</b>	102767	<b>Ref. No.</b> —
	gas tap front part shaft ø 10mm shaft L 26.5mm shaft flat suitable for PEL23S		
<b>accessories for</b>	101630		
	<b>Part No.</b>	100908	<b>Ref. No.</b> —
	union screw thread M10x1 for pipe ø 4mm Qty 1 pcs		
	<b>Part No.</b>	100909	<b>Ref. No.</b> —
	union screw thread M10x1 for pipe ø 6mm Qty 1 pcs		
	<b>Part No.</b>	100945	<b>Ref. No.</b> —
	roll pin ø 3.2mm L 10mm		
	<b>Part No.</b>	101218	<b>Ref. No.</b> —
	shaft extension JUNKERS		
	<b>Part No.</b>	101219	<b>Ref. No.</b> —
	shaft extension L 25mm JUNKERS		
	<b>Part No.</b>	101246	<b>Ref. No.</b> —
	olive for pipe ø 4mm Qty 1 pcs		
	<b>Part No.</b>	101286	<b>Ref. No.</b> —
	olive ID ø 6mm Qty 1 pcs		
	<b>Part No.</b>	110064	<b>Ref. No.</b> —
	knob		
	<b>Part No.</b>	110066	<b>Ref. No.</b> —
	knob screw		
	<b>Part No.</b>	550396	<b>Ref. No.</b> —
	shaft extension L 25mm JUNKERS		

## alternatives to EGA

GPEL22 series

with nozzle outlet



1

<b>Part No.</b>	101662	<b>Ref. No.</b>	N/A
<b>description</b>	gas tap alternatives to EGA type GPEL22D with nozzle outlet (with nozzle) gas inlet M18x1.5 (tube ø 12mm) external nozzle ø 2.1mm internal nozzle ø 1mm bypass nozzle ø 0.35mm mixing pipe connection M22x1 thermocouple connection M8x1 pilot connection M10x1 shaft ø 6.5x9mm shaft L 34/15mm shaft flat upper and bottom		
<b>spare parts for</b>	101662		
	<b>Part No.</b>	100259	<b>Ref. No.</b> —
	bypass nozzle type PEL22 bore ø 0.35mm thread M6x0.5		

Table continues overleaf





spare parts for		101662	
	Part No.	100338	Ref. No. —
gas injector thread M15x1 bore ø 2.10mm WS 17			
	Part No.	100343	Ref. No. —
internal nozzle bore ø 1mm type EGA/PEL22			
	Part No.	100908	Ref. No. —
union screw thread M10x1 for pipe ø 4mm Qty 1 pcs			
	Part No.	100927	Ref. No. —
torsion spring L 2.8-8.0mm for internal nozzle ø 3mm bore ømm			
	Part No.	101058	Ref. No. 162589
magnet unit L 39mm D1 ø 15.4mm D2 ø 13.5mm suitable for PEL22/ EGA24197 standard			
	Part No.	101230	Ref. No. —
thermocouple nut T1: M8x1 T2: M18x1 aluminium			
	Part No.	101246	Ref. No. —
olive for pipe ø 4mm Qty 1 pcs			
	Part No.	101460	Ref. No. —
O-ring ø 12.37mm D1 ø 2.62mm suitable for PEL22			
	Part No.	101527	Ref. No. —
O-ring Viton thickness 1.78mm ID ø 6.75mm Qty 1 pcs			
	Part No.	101594	Ref. No. —
adjusting screw for internal nozzle thread M10x0.75			
	Part No.	101821	Ref. No. —
gas tap front part shaft ø 9x6.5mm shaft L 34/15mm shaft flat upper/ lower suitable for PEL22			
accessories for		101662	
	Part No.	100909	Ref. No. —
union screw thread M10x1 for pipe ø 6mm Qty 1 pcs			
	Part No.	100944	Ref. No. —
union nut thread M18x1.5 for pipe ø 12mm			
	Part No.	101273	Ref. No. —
olive for pipe ø 12mm L 9.5mm brass Qty 1 pcs suitable for universal			
	Part No.	101286	Ref. No. —
olive ID ø 6mm Qty 1 pcs			
	Part No.	110217	Ref. No. 179922
knob gas tap with ignition flame ø 64mm shaft ø 9x7mm shaft flat horizontal black			

			
1			
Part No.	101764	Ref. No.	112721 112722
description	gas tap alternatives to EGA type PEL22S with nozzle outlet (with nozzle) gas inlet M18x1.5 (tube ø 12mm) external nozzle ø 1.6mm internal nozzle ø 1mm bypass nozzle ø 0.35mm mixing pipe connection M22x1 thermocouple connection M8x1 pilot connection M10x1 shaft ø 9x6.5mm shaft L 34/15mm shaft flat upper and bottom		
spare parts for	101764		
	Part No.	100259	Ref. No. —
bypass nozzle type PEL22 bore ø 0.35mm thread M6x0.5			
	Part No.	100337	Ref. No. —
gas injector thread M15x1 bore ø 1.60mm WS 17			
	Part No.	100343	Ref. No. —
internal nozzle bore ø 1mm type EGA/PEL22			
	Part No.	100908	Ref. No. —
union screw thread M10x1 for pipe ø 4mm Qty 1 pcs			
	Part No.	100927	Ref. No. —
torsion spring L 2.8-8.0mm for internal nozzle ø 3mm bore ømm			
	Part No.	101058	Ref. No. 162589
magnet unit L 39mm D1 ø 15.4mm D2 ø 13.5mm suitable for PEL22/ EGA24197 standard			
	Part No.	101230	Ref. No. —
thermocouple nut T1: M8x1 T2: M18x1 aluminium			
	Part No.	101246	Ref. No. —
olive for pipe ø 4mm Qty 1 pcs			
	Part No.	101460	Ref. No. —
O-ring ø 12.37mm D1 ø 2.62mm suitable for PEL22			
	Part No.	101527	Ref. No. —
O-ring Viton thickness 1.78mm ID ø 6.75mm Qty 1 pcs			
	Part No.	101594	Ref. No. —
adjusting screw for internal nozzle thread M10x0.75			
	Part No.	101821	Ref. No. —
gas tap front part shaft ø 9x6.5mm shaft L 34/15mm shaft flat upper/ lower suitable for PEL22			
accessories for	101764		
	Part No.	100944	Ref. No. —
union nut thread M18x1.5 for pipe ø 12mm			
	Part No.	101273	Ref. No. —
olive for pipe ø 12mm L 9.5mm brass Qty 1 pcs suitable for universal			
	Part No.	101286	Ref. No. —
olive ID ø 6mm Qty 1 pcs			

Table continues overleaf



<b>accessories for</b> 101764			
Part No.	101909	Ref. No.	—
gas tap type PEL22S			



<b>Part No.</b>	101624	<b>Ref. No.</b>	112721 old version 112722 old version
-----------------	--------	-----------------	--

<b>description</b>	gas tap alternatives to EGA type PEL22S with nozzle outlet (without nozzle) gas inlet M18x1.5 (tube ø 12mm) external nozzle ømm internal nozzle ømm bypass nozzle ø 0.35mm mixing pipe connection M22x1 thermocouple connection M8x1 pilot connection M10x1 shaft ø 9x6.5mm shaft L 34/15mm shaft flat upper and bottom		
--------------------	---	--	--

<b>spare parts for</b>	101624		
------------------------	--------	--	--

Part No.	100259	Ref. No.	—
----------	--------	----------	---

bypass nozzle type PEL22 bore ø 0.35mm thread M6x0.5

Part No.	100927	Ref. No.	—
----------	--------	----------	---

torsion spring L 2.8-8.0mm for internal nozzle ø 3mm bore ømm

Part No.	101058	Ref. No.	162589
----------	--------	----------	--------

magnet unit L 39mm D1 ø 15.4mm D2 ø 13.5mm suitable for PEL22/ EGA24197 standard

Part No.	101230	Ref. No.	—
----------	--------	----------	---

thermocouple nut T1: M8x1 T2: M18x1 aluminium

Part No.	101460	Ref. No.	—
----------	--------	----------	---

O-ring ø 12.37mm D1 ø 2.62mm suitable for PEL22

Part No.	101527	Ref. No.	—
----------	--------	----------	---

O-ring Viton thickness 1.78mm ID ø 6.75mm Qty 1 pcs

Part No.	101594	Ref. No.	—
----------	--------	----------	---

adjusting screw for internal nozzle thread M10x0.75

Part No.	101821	Ref. No.	—
----------	--------	----------	---

gas tap front part shaft ø 9x6.5mm shaft L 34/15mm shaft flat upper/ lower suitable for PEL22

<b>accessories for</b>	101624		
------------------------	--------	--	--

Part No.	100908	Ref. No.	—
----------	--------	----------	---

union screw thread M10x1 for pipe ø 4mm Qty 1 pcs

Part No.	100909	Ref. No.	—
----------	--------	----------	---

union screw thread M10x1 for pipe ø 6mm Qty 1 pcs

Part No.	100944	Ref. No.	—
----------	--------	----------	---

union nut thread M18x1.5 for pipe ø 12mm

Part No.	101246	Ref. No.	—
----------	--------	----------	---

olive for pipe ø 4mm Qty 1 pcs

Part No.	101273	Ref. No.	—
----------	--------	----------	---

olive for pipe ø 12mm L 9.5mm brass Qty 1 pcs suitable for universal

Part No.	101286	Ref. No.	—
----------	--------	----------	---

olive ID ø 6mm Qty 1 pcs

<b>accessories for</b> 101624			
Part No.	110217	Ref. No.	179922
knob gas tap with ignition flame ø 64mm shaft ø 9x7mm shaft flat horizontal black			

## alternatives to JUNKERS



<b>Part No.</b>	101630	<b>Ref. No.</b>	112623
-----------------	--------	-----------------	--------

<b>description</b>	gas tap PEL type 23S/V gas inlet 1/2" IT bypass nozzle ø 0.35mm gas outlet 1/2" MT (tube ø 14mm) thermocouple connection M10x1 pilot connection M10x1 shaft ø 10mm shaft L 25mm shaft flat		
--------------------	--	--	--

<b>spare parts for</b>	101630		
------------------------	--------	--	--

Part No.	100455	Ref. No.	—
----------	--------	----------	---

bypass nozzle type PEL23/24 bore ø 0.35mm thread M8x0.5

Part No.	101059	Ref. No.	—
----------	--------	----------	---

magnet unit T1: M10x1 T2: M22x1 L 46mm ø 18mm suitable for PEL23S M10x1

Part No.	102767	Ref. No.	—
----------	--------	----------	---

gas tap front part shaft ø 10mm shaft L 26.5mm shaft flat suitable for PEL23S

<b>accessories for</b>	101630		
------------------------	--------	--	--

Part No.	100908	Ref. No.	—
----------	--------	----------	---

union screw thread M10x1 for pipe ø 4mm Qty 1 pcs

Part No.	100909	Ref. No.	—
----------	--------	----------	---

union screw thread M10x1 for pipe ø 6mm Qty 1 pcs

Part No.	100945	Ref. No.	—
----------	--------	----------	---

roll pin ø 3.2mm L 10mm

Part No.	101218	Ref. No.	—
----------	--------	----------	---

shaft extension JUNKERS

Part No.	101219	Ref. No.	—
----------	--------	----------	---

shaft extension L 25mm JUNKERS

Part No.	101246	Ref. No.	—
----------	--------	----------	---

olive for pipe ø 4mm Qty 1 pcs

Part No.	101286	Ref. No.	—
----------	--------	----------	---

olive ID ø 6mm Qty 1 pcs

Part No.	110064	Ref. No.	—
----------	--------	----------	---

knob

Part No.	110066	Ref. No.	—
----------	--------	----------	---

knob screw

Part No.	550396	Ref. No.	—
----------	--------	----------	---

shaft extension L 25mm JUNKERS



# ignition parts

## pilot burners

### JUNKERS

#### CB 502 series

##### pilot burners



<b>Part No.</b>	100085	<b>Ref. No.</b>	112569
-----------------	--------	-----------------	--------

**description** pilot burner JUNKERS type CB502031 natural gas nozzle no.6 gas connection 6mm with primary air

**For models:** GK8-40

**spare parts for** 100085

	<b>Part No.</b>	100227	<b>Ref. No.</b>	—
pilot burner nozzle natural gas gas pressure 25mbar code 6 Qty 1 pcs suitable for JUNKERS CB50203_				

	<b>Part No.</b>	100704	<b>Ref. No.</b>	112414
ignition electrode D1 ø 9mm connection M4 D2 ø 11mm L1 17mm L2 17mm BL1 13mm BL2 4mm BL3 22mm				

	<b>Part No.</b>	100909	<b>Ref. No.</b>	—
union screw thread M10x1 for pipe ø 6mm Qty 1 pcs				

	<b>Part No.</b>	101287	<b>Ref. No.</b>	—
olive for pipe ø 6mm Qty 1 pcs				

	<b>Part No.</b>	101292	<b>Ref. No.</b>	—
union screw for igniter suitable for CB 502/505 Qty 1 pcs				

	<b>Part No.</b>	101295	<b>Ref. No.</b>	—
clamping collet for thermocouple suitable for CB 502/505 Qty 1 pcs				

**accessories for** 100085

	<b>Part No.</b>	100220	<b>Ref. No.</b>	—
pilot burner nozzle LPG gas pressure 50mbar code 2 Qty 1 pcs suitable for JUNKERS CB503_				

	<b>Part No.</b>	100221	<b>Ref. No.</b>	—
pilot burner nozzle LPG gas pressure 30mbar code 29 Qty 1 pcs suitable for JUNKERS CB50203_				

	<b>Part No.</b>	100222	<b>Ref. No.</b>	—
pilot burner nozzle LPG gas pressure 50mbar code 5 Qty 1 pcs suitable for JUNKERS CB50203_				

	<b>Part No.</b>	100223	<b>Ref. No.</b>	—
pilot burner nozzle natural gas gas pressure 20mbar code 3 Qty 1 pcs suitable for JUNKERS CB503_				

	<b>Part No.</b>	100224	<b>Ref. No.</b>	—
pilot burner nozzle natural gas gas pressure 25mbar code 26 Qty 1 pcs suitable for JUNKERS CB503_				

	<b>Part No.</b>	100225	<b>Ref. No.</b>	—
pilot burner nozzle LPG gas pressure 30mbar code 39 Qty 1 pcs suitable for JUNKERS CB503_				

	<b>Part No.</b>	100226	<b>Ref. No.</b>	—
pilot burner nozzle LPG gas pressure 50mbar code 15 suitable for JUNKERS				

**accessories for** 100085

	<b>Part No.</b>	100228	<b>Ref. No.</b>	—
pilot burner nozzle town gas gas pressure 8mbar code 4 Qty 1 pcs suitable for JUNKERS CB50203_				

	<b>Part No.</b>	101281	<b>Ref. No.</b>	—
olive for pipe ø 4mm L 8.7mm Qty 1 pcs suitable for CB 502/503				

	<b>Part No.</b>	101283	<b>Ref. No.</b>	—
union screw thread M10x1 for pipe ø 4mm Qty 1 pcs				

#### CB 505 series

##### pilot burners

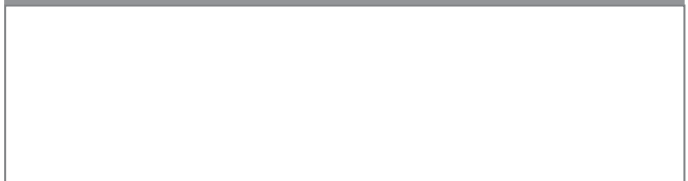

<b>Part No.</b>	100180	<b>Ref. No.</b>	172317
-----------------	--------	-----------------	--------

**description** pilot burner JUNKERS type 7749505104

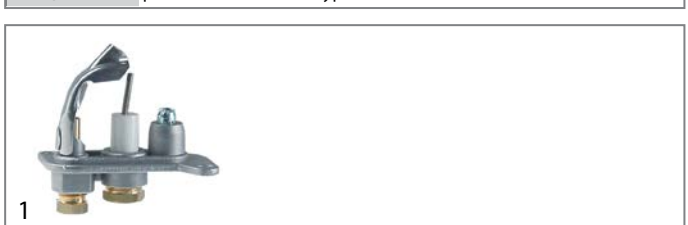

<b>Part No.</b>	100134	<b>Ref. No.</b>	172316
-----------------	--------	-----------------	--------

**description** pilot burner JUNKERS type CB505101 natural gas nozzle no.45 gas connection 4mm no primary air

**spare parts for** 100134

	<b>Part No.</b>	100213	<b>Ref. No.</b>	—
pilot burner nozzle natural gas code 45 gas pressure 20mbar L 16mm Qty 1 pcs suitable for JUNKERS CB5051_				

	<b>Part No.</b>	100702	<b>Ref. No.</b>	—
ignition electrode D1 ø 9mm D2 ø 11mm L1 13mm L2 4mm BL1 13mm BL2 4mm BL3 22mm to clip connection ø 4mm				

	<b>Part No.</b>	100802	<b>Ref. No.</b>	—
gasket for pilot burner				

	<b>Part No.</b>	101282	<b>Ref. No.</b>	—
olive for pipe ø 4mm L 7.4mm Qty 1 pcs				

	<b>Part No.</b>	101283	<b>Ref. No.</b>	—
union screw thread M10x1 for pipe ø 4mm Qty 1 pcs				

	<b>Part No.</b>	101292	<b>Ref. No.</b>	—
union screw for igniter suitable for CB 502/505 Qty 1 pcs				

	<b>Part No.</b>	101295	<b>Ref. No.</b>	—
clamping collet for thermocouple suitable for CB 502/505 Qty 1 pcs				





**accessories for** 100134

	<b>Part No.</b>	100210	<b>Ref. No.</b>	—
pilot burner nozzle LPG code 46 gas pressure 30mbar L 16mm Qty 1 pcs suitable for JUNKERS CB5051_				

Table continues overleaf

1 gas components



accessories for		100134	
Part No.	100211	Ref. No.	—
	pilot burner nozzle natural gas code 44 gas pressure 25mbar L 16mm Qty 1 pcs suitable for JUNKERS CB5051_		
Part No.	100212	Ref. No.	—
	pilot burner nozzle LPG code 42 gas pressure 50mbar L 16mm Qty 1 pcs suitable for JUNKERS CB5051_		
Part No.	100909	Ref. No.	—
	union screw thread M10x1 for pipe ø 6mm Qty 1 pcs		
Part No.	101288	Ref. No.	—
	olive for pipe ø 6mm L 6mm aluminium Qty 1 pcs ED ø 8.5mm		

producer-specific pilot burners

MALAG

AG\_ / AGE\_ series



1

Part No.	107473	Ref. No.	-
description	pilot burner natural/liquid gas complete		

electrodes

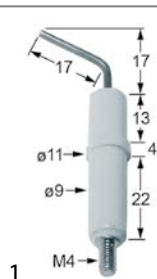

1

Part No.	100704	Ref. No.	112414
description	ignition electrode D1 ø 9mm connection M4 D2 ø 11mm L1 17mm L2 17mm BL1 13mm BL2 4mm BL3 22mm		

piezoelectric igniters

miscellaneous



1

Part No.	nla <sup>1</sup>	Ref. No.	112607
description	piezoelectric igniter body metal connection F6.3x0.8 2 hole fixing ø 22mm		

<sup>1</sup>no longer available

thermocouples

threaded thermocouples

threaded thermocouples standard

with socket with thread M8x1

type Junkers with aluminised tip

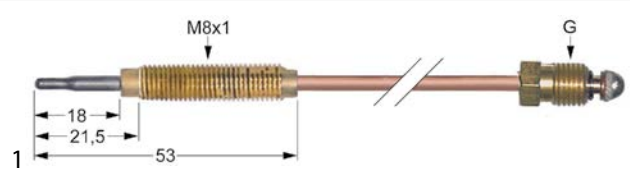

1

Part No.	102234	Ref. No.	112402
description	thermocouple M10x1 L 320mm M8x1		
For models:	GK8-40		

gas burners

hob burners

producer-specific hob burners

MALAG

universal

1

Part No.	105796	Ref. No.	112275
description	burner 3.8kW complete		





			
1	<b>Part No.</b>	105801	<b>Ref. No.</b> 112267
<b>description</b> burner 5.8kW complete			
<b>spare parts for</b> 105801			
	<b>Part No.</b>	105797	<b>Ref. No.</b> 112224
<b>description</b> burner cap ø 104mm 5.8kW with central hole hole ø 39mm			
	<b>Part No.</b>	105798	<b>Ref. No.</b> 177776
<b>description</b> burner ring 5.8kW small			
	<b>Part No.</b>	105799	<b>Ref. No.</b> 177806
<b>description</b> burner ring 5.8kW large			
	<b>Part No.</b>	105801	<b>Ref. No.</b> 112267
<b>description</b> burner 5.8kW complete			

			
1	<b>Part No.</b>	106653	<b>Ref. No.</b> 112232
<b>description</b> burner cap 3.7kW complete			

			
1	<b>Part No.</b>	105797	<b>Ref. No.</b> 112224
<b>description</b> burner cap ø 104mm 5.8kW with central hole hole ø 39mm			

			
1	<b>Part No.</b>	105795	<b>Ref. No.</b> 199992
<b>description</b> burner head 3.7kW			

			
1	<b>Part No.</b>	105800	<b>Ref. No.</b> 199992 old version
<b>description</b> burner head 5.8kW			

			
1	<b>Part No.</b>	105794	<b>Ref. No.</b> 177792
<b>description</b> burner ring 3.7kW large			

			
1	<b>Part No.</b>	105793	<b>Ref. No.</b> 177768
<b>description</b> burner ring 3.7kW small			

			
1	<b>Part No.</b>	105799	<b>Ref. No.</b> 177806
<b>description</b> burner ring 5.8kW large			

			
1	<b>Part No.</b>	105798	<b>Ref. No.</b> 177776
<b>description</b> burner ring 5.8kW small			

## gas nozzles

### pilot burner nozzles

#### pilot burner nozzles EGA

			
1	<b>Part No.</b>	100214	<b>Ref. No.</b> 112534
<b>description</b> pilot burner nozzle LPG bore ø 0.16mm Qty 1 pcs			



			
1	<b>Part No.</b>	100215	<b>Ref. No.</b> 162558
<b>description</b> pilot burner nozzle natural gas bore ø 0.28mm Qty 1 pcs			

## auxiliary gas parts

### gas lines

#### pilot tubes

##### universal

			
1	<b>Part No.</b>	102110	<b>Ref. No.</b> 112488
<b>description</b> pilot tube copper pipe ø 4mm thickness 1mm L 3000mm			
<b>accessories for</b> 102110			
	<b>Part No.</b>	100908	<b>Ref. No.</b> —
<b>description</b> union screw thread M10x1 for pipe ø 4mm Qty 1 pcs			
	<b>Part No.</b>	101246	<b>Ref. No.</b> —
<b>description</b> olive for pipe ø 4mm Qty 1 pcs			



knobs

producer-specific knobs

MALAG



1

<b>Part No.</b>	110217	<b>Ref. No.</b>	179922
<b>description</b>	knob gas tap with ignition flame ø 64mm shaft ø 9x7mm shaft flat horizontal black		



1

<b>Part No.</b>	110218	<b>Ref. No.</b>	1004243,179930
<b>description</b>	knob gas thermostat 1-8 ø 64mm shaft ø 9x7mm shaft flat horizontal		



1

<b>Part No.</b>	110210	<b>Ref. No.</b>	144216
<b>description</b>	knob switch 0-1-0-1 ø 64mm shaft ø 6x4.6mm shaft flat lower black		



1

<b>Part No.</b>	110211	<b>Ref. No.</b>	144452
<b>description</b>	knob switch 4-position ø 64mm shaft ø 6x4.6mm shaft flat lower black		



1

<b>Part No.</b>	110212	<b>Ref. No.</b>	143871
<b>description</b>	knob switch 7-position ø 64mm shaft ø 6x4.6mm shaft flat lower black		



1

<b>Part No.</b>	110213	<b>Ref. No.</b>	106100
<b>description</b>	knob thermostat t.max. 110°C ø 64mm shaft ø 6x4.6mm shaft flat lower black temperature range 30-110°C		



1

<b>Part No.</b>	110215	<b>Ref. No.</b>	106128
<b>description</b>	knob thermostat t.max. 250°C ø 64mm shaft ø 6x4.6mm shaft flat lower black temperature range 50-250°C rotation 270° thermostat		



1

<b>Part No.</b>	110214	<b>Ref. No.</b>	106119 144208
<b>description</b>	knob thermostat t.max. 300°C ø 64mm shaft ø 6x4.6mm shaft flat lower black temperature range 50-300°C thermostat		



1

<b>Part No.</b>	110216	<b>Ref. No.</b>	106135
<b>description</b>	knob thermostat t.max. 370°C ø 64mm shaft ø 6x4.6mm shaft flat lower black temperature range 130-370°C		



## hinges

## oven hinges



1

<b>Part No.</b>	700898 <sup>1</sup>	<b>Ref. No.</b>	143928
<b>description</b>	oven hinge mounting distance 118mm lug mounting 12mm lever length 113mm groove distance 6mm spring thickness 3.5mm mounting ear position left/right spring length 55mm L 155mm W 22mm with opposite support		

<sup>1</sup>with opposite support

## fittings for catering equipment

## aerators and air bleeders



1

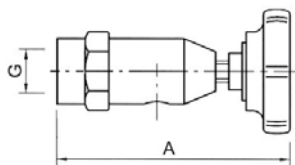

<b>Part No.</b>	540013	<b>Ref. No.</b>	114405
<b>description</b>	aerator and air bleeder thread 3/8" ET WS 27 chrome-plated L 86mm		

spare parts for 540013

	<b>Part No.</b>	112777	<b>Ref. No.</b>	—
	star handle shaft 6x6mm ø 50mm L 18mm black plastic			

	<b>Part No.</b>	540365	<b>Ref. No.</b>	—
	star handle shaft 6x6mm ø 50mm L 18mm black thermoplastic			



1

<b>Part No.</b>	540011	<b>Ref. No.</b>	113905
<b>description</b>	aerator and air bleeder thread 1/2" ET chrome-plated brass metal seated L 42mm ø 26mm		



1

<b>Part No.</b>	540010	<b>Ref. No.</b>	113891
<b>description</b>	aerator and air bleeder thread 3/8" ET WS 22 chrome-plated metal seated L 22mm		

## test taps

## test taps



1

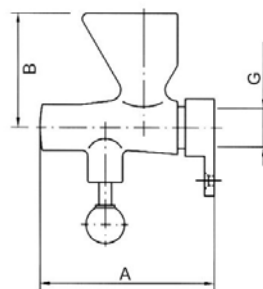

<b>Part No.</b>	540079	<b>Ref. No.</b>	114227
<b>description</b>	funnel thread 1/2" IT W 90mm W1 60mm		

## baskets

## fryer baskets

## MALAG



1

<b>Part No.</b>	970436	<b>Ref. No.</b>	113123
<b>description</b>	fryer basket L1 320mm W1 160mm H1 165mm		



1

<b>Part No.</b>	970437	<b>Ref. No.</b>	113131
<b>description</b>	fryer basket L1 380mm W1 320mm H1 180mm		



## springs

## tension springs



<b>Part No.</b>	700897	<b>Ref. No.</b>	144517
<b>description</b>	tension spring ø 18mm total length 164mm wire gauge ø 2mm L1 17mm L2 130mm L3 17mm		



**GASTRO**PARTS.COM

