



GASTROPARTS

Magister

- [EN]** Equipment
- [DE]** Geräte
- [ES]** Aparatos
- [FR]** Équipement
- [IT]** Attrezzature
- [PL]** Urządzenia
- [RU]** Оборудование

✉ gastroparts@gastroparts.com

☎ tel. +48 56 657 00 66

📘 fb.com/gastroparts.global



GASTROPARTS.COM









heating elements



heating elements for coffee machine

 <p>1</p>			
Part No.	417237	Ref. No.	180050
description	heating element 1600W 230V heating circuits 1 mounting \varnothing 43mm hole distance 72mm L 178mm W 19mm H 40mm windings 2 hole \varnothing 9mm thermostat sleeves \varnothing 5mm length thermostat sleeves 142mm number of thermostat sleeves 1 thermostat sleeve eccentric, non clinging tube \varnothing 8mm connection M3 immersion heater 2 hole flange		
accessories for	417237		
	Part No.	Ref. No.	190007
	flat gasket PTFE D1 \varnothing 61.5mm D2 \varnothing 46mm thickness 1.6mm for heating element Qty 1 pcs		

 <p>1</p>			
Part No.	417238	Ref. No.	180052
description	heating element 2700W 230V heating circuits 3 mounting \varnothing 42mm hole distance 72mm L 210mm W 33mm H 32mm windings 3 hole \varnothing 9mm thermostat sleeves \varnothing 5mm length thermostat sleeves 143mm number of thermostat sleeves 1 thermostat sleeve eccentric, non clinging tube \varnothing 8mm connection M3 immersion heater 2 hole flange		
accessories for	417238		
	Part No.	Ref. No.	190007
	flat gasket PTFE D1 \varnothing 61.5mm D2 \varnothing 46mm thickness 1.6mm for heating element Qty 1 pcs		

 <p>1</p>			
Part No.	420363	Ref. No.	180138
description	heating element 3000W 230V heating circuits 3 mounting \varnothing 42mm L 205mm W 33mm H 32mm hole distance 72mm hole \varnothing 9mm tube \varnothing 8mm connection M3 immersion heater 2 hole flange number of thermostat sleeves 1 thermostat sleeves \varnothing 5mm length thermostat sleeves 130mm thermostat sleeve eccentric, clinging		

 <p>1</p>			
Part No.	417239	Ref. No.	180053
description	heating element 4500W 230V heating circuits 3 mounting \varnothing 42mm hole distance 72mm L 368mm W 34mm H 31mm windings 3 hole \varnothing 9mm thermostat sleeves \varnothing 5mm length thermostat sleeves 142mm number of thermostat sleeves 1 thermostat sleeve eccentric, non clinging tube \varnothing 8mm connection M3 immersion heater 2 hole flange		
accessories for	417239		
	Part No.	Ref. No.	190007
	flat gasket PTFE D1 \varnothing 61.5mm D2 \varnothing 46mm thickness 1.6mm for heating element Qty 1 pcs		

 <p>1</p>			
Part No.	417240	Ref. No.	180054
description	heating element 5400W 230V heating circuits 3 mounting \varnothing 42mm hole distance 72mm L 580mm W 33mm H 31mm windings 3 hole \varnothing 9mm thermostat sleeves \varnothing 5mm length thermostat sleeves 142mm number of thermostat sleeves 1 thermostat sleeve eccentric, non clinging tube \varnothing 8mm connection M3 immersion heater 2 hole flange		
accessories for	417240		
	Part No.	Ref. No.	190007
	flat gasket PTFE D1 \varnothing 61.5mm D2 \varnothing 46mm thickness 1.6mm for heating element Qty 1 pcs		

accessories

sealing washers

PTFE gaskets

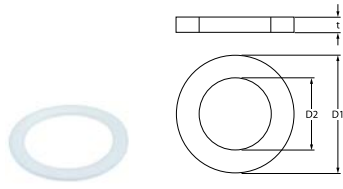
 <p>1</p>			
Part No.	528540	Ref. No.	190007
description	flat gasket PTFE D1 \varnothing 61.5mm D2 \varnothing 46mm thickness 1.6mm for heating element Qty 1 pcs		

thermostats

bi-metal thermostats

safety bi-metal thermostats

 <p>1</p>			
Part No.	390370	Ref. No.	180158
description	bi-metal safety thermostat hole distance mm switch-off temp. 145°C 1NC 1-pole 16A connection F6.3 M4		





control and safety thermostats

RANCO

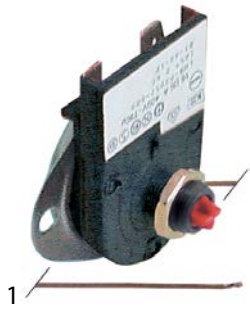
safety thermostats



Part No.	390305	Ref. No.	180039
description	safety thermostat t.max. 165°C temperature range°C 1-pole 1NC 25A probe ø 2mm probe Lmm capillary pipe 490mm capillary pipe isolatedmm gland nut shaft ømm shaft Lmm shaft position rotation° probe material copper with capillary probe screw connection M10x0.75 switch-off temp. 165°C		
accessories for	390305		
	Part No.	390313	Ref. No. —
	screw connection		
	Part No.	390317	Ref. No. —
	double nipple		
	Part No.	390373	Ref. No. —
	union screw thread M10x1 L 20mm ID ø 2.7mm WS 12 thread L 15mm		



1

Part No.	346110	Ref. No.	180034
description	rocker switch mounting measurements 30x22mm red 2NO 250V 16A illuminated coffee connection male faston 6.3mm ambient temperature max. 125/55°C protection IP40		



1

Part No.	346111	Ref. No.	180033
description	rocker switch mounting measurements 30x22mm red 2NO 250V 16A illuminated cup warmer connection male faston 6.3mm ambient temperature max. 125/55°C protection IP40		



1

Part No.	347114	Ref. No.	180032
description	rocker switch mounting measurements 30x22mm red 2NO 250V 16A illuminated heating connection male faston 6.3mm ambient temperature max. 100/55°C protection IP40		

accessories for	347114		
	Part No.	301036	Ref. No. —
	protective cover internal size 30x22mm for rocker switch mounting measurementsmm		



1

Part No.	346109	Ref. No.	180031
description	rocker switch mounting measurements 30x22mm red 2NO 250V 16A illuminated water connection male faston 6.3mm ambient temperature max. 125/55°C protection IP40		

switches and momentary switches

rocker/momentary rocker switches

30x22mm



1

Part No.	346474	Ref. No.	180035
description	dummy element external size 30x22mm suitable for rocker switch		



1

Part No.	347202	Ref. No.	180034
description	rocker switch mounting measurements 30x22mm orange 2NO 250V 16A illuminated cup connection male faston 6.3mm ambient temperature max. 100/55°C protection IP40		



1

Part No.	346108	Ref. No.	180030
description	rocker switch mounting measurements 30x22mm orange 2NO 250V 16A illuminated ignition connection male faston 6.3mm ambient temperature max. 125/55°C protection IP40		

microswitches

roller-lever actuated

microswitches



1

Part No.	345250	Ref. No.	180128
description	microswitch with handle with a switch 250V 16A 1CO connection male faston 6.3mm L 27mm L1 36mm ambient temperature max. 125°C mounting distance 22mm type RL6-1-FGE-P12-5-L actuating force: 90g		



pin-plunger actuated

M10



1

Part No.	347216	Ref. No.	180171
description	microswitch with plunger thread M10x0.75 thread L 14mm 250V 10A 1CO connection male faston 6.3mm stroke 7.5mm mounting distance 22mm L 28mm ambient temperature max. 125°C type NR6K5 actuating force: 260g		

lamps

indicator lights

indicator lights (complete)

ø12mm

with screw socket



1

Part No.	359464	Ref. No.	180067
description	indicator light housings mounting measurements ø12mm green		



1

Part No.	359465	Ref. No.	180069
description	indicator light housings mounting measurements ø12mm yellow		



1

Part No.	359467	Ref. No.	180066
description	indicator lamp 240V green cable length 290mm ø 8mm		



1

Part No.	359466	Ref. No.	180068
description	indicator lamp 240V orange cable length 290mm ø 8mm		

contactors

LOVATO

power contactors



1

Part No.	380713	Ref. No.	180024
description	power contactor resistive load 20A 230VAC (AC3/400V) 9A/4kW main contacts 4NO connection male faston type 11BGF09T4A230		

relays

power relays

with bracket mounting



1

Part No.	380185	Ref. No.	180026
description	power relays Italiana Relè 230VAC 30A 1NO connection F6.3 bracket mounting dimensions 36.5x32.2x51.8mm manuf. no. A10-230AC-FA		

level relays

GICAR



1

Part No.	402103	Ref. No.	180028
description	level controller 230/240V voltage AC 50/60Hz connection F6.3 type NRL30/1E-2C/F		



1

Part No.	528636	Ref. No.	180159
description	level controller 230V voltage AC 50/60Hz 16/5A connection F6.3 type RL30 MICRO ST		

electronics

PCBs



1

Part No.	528981	Ref. No.	900151
description	display L 80mm W 29mm type KAPPA XP		

central units



1

Part No.	528638	Ref. No.	180090 180239
description	central unit 3 groups 230V 50/60Hz type 3d5 3GRCT XLC (SC) voltage AC		



1

Part No.	528639	Ref. No.	180218
description	central unit F2006 230V 50/60Hz type 4d5 Maestro Clock 4GRCTZN-LD voltage AC		

dosing electronics

GICAR



1

Part No.	528635	Ref. No.	180087
description	control box 230V voltage AC 50/60Hz 5/5/10A type RL30 MICRO Z		



1

Part No.	528637	Ref. No.	180168
description	dosing electronics 230V voltage AC 50/60Hz 5/5/10A type RL30 MICRO Z „DOUBLE 5L“		

keypads

keypad units



1

Part No.	527817	Ref. No.	900233
description	control panel suitable for F2006 2-group		



1

Part No.	527818	Ref. No.	900234
description	control panel suitable for F2006 2-group		



1

Part No.	528799	Ref. No.	900149
description	keypad unit 1 group ES STILO, KAPPA XP buttons 6 L 118mm W 29mm		

1

Part No.	528785	Ref. No.	900150
description	keypad unit buttons 3 L 61mm W 29mm F2006, XP		



1

Part No.	528725	Ref. No.	180095
description	keypad unit coffee machine F2006/Kappa/Leva/Stilo buttons 6 L 88mm W 60mm		



1

Part No.	528764	Ref. No.	180170
description	keypad unit coffee machine MS/ES/40/45 buttons 3 L 88mm W 37mm		

pressure switches

for coffee machines

ø 38mm



1

Part No.	541155	Ref. No.	180161
description	pressure control ø 38mm pressure range 1-2.5bar pressure connection vertical 16A 250V coffee machine parts connection 1/8" pressure connection 1/8"		

electrodes



1

Part No.	528989	Ref. No.	900159
description	level electrode 1/4" total length 76mm probe L 62mm insulated probe length 26mm angled connection screw clamp stainless steel ø 2.5mm PTFE		



1

Part No.	528990	Ref. No.	900078
description	level electrode 3/8" total length 120mm probe L 102mm insulated probe length 26mm angled stainless steel ø 2mm		

flow meters and flow sensors

flow meters

GICAR



1

Part No.	542378	Ref. No.	180040
description	flow meter thread 1/4" stainless steel with LED approval NSF		

pumps

booster pumps II

pump motors

clip connection



1

Part No.	500080	Ref. No.	180020
description	pump motor capacitor 10µF ULKA type 128P 180W 230V 50Hz connection clip L 155mm W 130mm H 160mm at 50Hz 1400rpm		
accessories for	500080		
	Part No.	Ref. No.	—
	365014		
description	operating capacitor capacity 12.5µF 450V tolerance 5%Hz ambient temperature max. -25 to +85°C ø 35mm L 70mm M8 plastic connection male faston 6.3mm 45S.C3DS.12.5 protection		



pump heads

PROCON



1	Part No.	501559	Ref. No.	210002
description pump head PROCON L 97mm 200l/h connection 3/8" NPT clip connection shaft ø 5x11mm				



1	Part No.	400229	Ref. No.	180096
description ribbon cable 16-pole L 800mm plug type FC-16P raster size 2.54mm				

equipment-specific units

for espresso machines

filter holders

filter holders standard

filter holders (complete)



1	Part No.	528994	Ref. No.	189075 210030
description filter holder with outlet, 2-fold with filter ID ø 62mm outlet distance 44mm				

filter holder without spout



1	Part No.	525977	Ref. No.	N/A
description filter holder suitable for CREM-EXPOBAR/WEGA/GRIMAC/SANRAMO without outlet mounting ø 83mm outlet 3/8" ID ø 61.5mm wedge height 10mm wedge position horizontal number of wedges 2 lever inclined				

filters

for 1 cup



1	Part No.	528995	Ref. No.	210036 210058
description coffee filter ø 70mm mounting ø 60mm H 16mm cups 1				

fuses

fine fuses



1	Part No.	358676	Ref. No.	180101
description fine fuse size ø5x20mm 3.15A fast-acting rated 250V Qty 10 pcs				

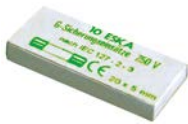

1	Part No.	358607	Ref. No.	180155
description fine fuse size ø5x20mm 6.3A slow-acting rated 250V Qty 10 pcs				

electric accessories

cables

ribbon cables

group 1



1	Part No.	400706	Ref. No.	180097
description ribbon cable 16-pole L 1100mm plug type FC-16P raster size 2.54mm				



1	Part No.	400707	Ref. No.	180098
description ribbon cable 16-pole L 1400mm plug type FC-16P raster size 2.54mm				





1	Part No.	400228	Ref. No.	180173
description ribbon cable 16-pole L 600mm plug type FC-16P raster size 2.54mm				



			
1			
Part No.	526069	Ref. No.	210026
description	coffee filter ø 70mm mounting ø 60mm H 20.5mm cups 1 amount of coffee 7g perforation ø 0.4mm		

for 2 cups			
			
1			
Part No.	529700	Ref. No.	210027
description	coffee filter ø 70mm mounting ø 60mm H 22mm cups 2 amount of coffee 14g		

brewing units			
shower screens			
flat			
			
1			
Part No.	528996	Ref. No.	210057
description	shower screen ø 34mm hole ø 6.2mm flat		

with upstand and central hole			
			
1			
Part No.	528997	Ref. No.	210025
description	shower screen ø 57mm H 4mm hole ø 5.3mm		

filter holder gaskets			
flat			
with external notch			
			
1			
Part No.	528034	Ref. No.	190003
description	filter holder gasket D1 ø 73.5mm D2 ø 57.5mm H 8mm with outside notch Qty 1 pcs		

standard			
			
1			
Part No.	528610	Ref. No.	190003
description	filter holder gasket D1 ø 73.5mm D2 ø 57.5mm H 8.1mm with outside notch		

shim gaskets			
			
1			
Part No.	528599	Ref. No.	190019
description	shim gasket D1 ø 72mm D2 ø 58mm thickness 0.4mm paper Qty 1 pcs		

brewing units with solenoid valve			
components			
			
1			
Part No.	528993	Ref. No.	900091
description	infusor 1/8" L 48mm suitable for MAGISTER WS 32		

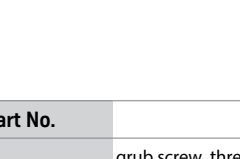
components			
screw connections			
			
1			
Part No.		Ref. No.	171002
description	grub screw thread M12x1.75 L 14.2mm stainless steel DIN 914 intake internal hexagon WS 6 Qty 1 pcs		



water dispersions

water dispersions

group 2



1

Part No.	529535	Ref. No.	100002
-----------------	--------	-----------------	--------

description water distributor ø 21mm hole ø 5.5mm grooves 8

group 3



1

Part No.	528998	Ref. No.	100001
-----------------	--------	-----------------	--------

description water distributor ø 55.5 / 58mm H 8mm 1 holes hole ø 16mm brass



1

Part No.	528999	Ref. No.	100058
-----------------	--------	-----------------	--------

description water distributor ø 55mm H 11.5mm 4 holes hole ø 1.5mm mounting ø 5.6mm brass

accessories for 528999



Part No.	528632	Ref. No.	190026
-----------------	--------	-----------------	--------

O-ring EPDM thickness 3.53mm ID ø 44.04mm Qty 1 pcs



Part No.	528996	Ref. No.	210057
-----------------	--------	-----------------	--------

shower screen ø 34mm hole ø 6.2mm flat

safety valves

safety valves

3/8"



1

Part No.	531313	Ref. No.	900080 900162
-----------------	--------	-----------------	------------------

description safety valve connection 3/8" triggering pressure 1.5bar

expansion valves



1

Part No.	531314	Ref. No.	900081
-----------------	--------	-----------------	--------

description valve T1: 3/8" BL 28mm total length 38mm

with hose connection



1

Part No.	528992	Ref. No.	900027
-----------------	--------	-----------------	--------

description expansion valve T1: 3/8" ET hose ø 7mm L 47mm

drain pans

drain pans



1

Part No.	528982	Ref. No.	900057
-----------------	--------	-----------------	--------

description drain pan 1 group L 90mm W 90mm H 40mm hole ø 18mm connection 3/4" hose length 120/300mm suitable for 60



1

Part No.	528983	Ref. No.	900058
-----------------	--------	-----------------	--------

description drain pan 2 groups L 90mm W 90mm H 40mm hole ø 18mm connection 3/4" hose length 120/300mm suitable for 70/100



1

Part No.	528984	Ref. No.	900059
-----------------	--------	-----------------	--------

description drain pan 3 groups L 90mm W 90mm H 40mm hole ø 18mm connection 3/4" hose length 120/300mm suitable for 100

boilers

pipes





1

Part No.	528988	Ref. No.	900036
-----------------	--------	-----------------	--------

description aspiration tube boiler tube ø 8x1 mm pipe length 110mm PE connection ø 10/14mm copper fitting







heat exchangers			
injector tubes			
			
1			
Part No.	528986	Ref. No.	900035
description	injector pipe boiler tube ø 6x1mm pipe length 130mm PE connection ø 8/14mm copper fitting		

			
1			
Part No.	528987	Ref. No.	900152
description	injector pipe boiler tube ø 6x1mm pipe length 180mm PE connection ø 8/14mm copper fitting		

steam/water taps			
steam/water taps			
steam taps			
bushes			
			
1			
Part No.	529536	Ref. No.	100050
description	bush D1 ø 12mm D2 ø 9mm ID ø 7mm H 5mm brass level glass		

			
1			
Part No.	528618	Ref. No.	100115
description	stop D1 ø 12mm D2 ø 9.7mm ID ø 7mm H 3mm brass steam tap		

steam taps (complete)			
			
1			
Part No.	528612	Ref. No.	900116
description	steam tap complete		
spare parts for	528612		
	Part No.	528344	Ref. No. 190006
	O-ring silicone thickness 2.62mm ID ø 12.37mm Qty 1 pcs		
	Part No.	528615	Ref. No. 160007
	compression spring ø 10.7mm L 34.5mm wire gauge ø 1.5mm steam tap		
	Part No.	528616	Ref. No. 100114
	washer ID ø 7.4mm ED ø 10.9mm thickness 0.5mm stainless steel steam tap		
	Part No.	528617	Ref. No. 190023
	flat gasket PTFE ED ø 11.3mm ID ø 7.6mm thickness 1.1mm steam tap Qty 1 pcs		

spare parts for	528612		
	Part No.	528618	Ref. No. 100115
	stop D1 ø 12mm D2 ø 9.7mm ID ø 7mm H 3mm brass steam tap		
	Part No.	528619	Ref. No. 190020
	gasket rubber ED ø 13.5mm ID ø 4mm thickness 4mm steam/water tap Qty 1 pcs		
	Part No.	528620	Ref. No. 140042
	spacer steam tap stainless steel L 15.1mm W 10mm thickness 2mm		
	Part No.	528621	Ref. No. 171100
	ball ø 9.55mm steam tap SS		
	Part No.	529724	Ref. No. 171101
	retaining ring E D1 ø 4mm D2 ø 9mm SS DIN 6799 thickness 0.7mm for shaft ø 4-5mm		
accessories for	528612		
	Part No.	111259	Ref. No. 030136
	knob ø 50mm black/grey		
	Part No.	111260	Ref. No. 030020
	knob steam ø 50mm black		

knobs			
			
1			
Part No.	111259	Ref. No.	030136
description	knob ø 50mm black/grey		

			
1			
Part No.	111260	Ref. No.	030020
description	knob steam ø 50mm black		

components			
gaskets			
			
1			
Part No.	528617	Ref. No.	190023
description	flat gasket PTFE ED ø 11.3mm ID ø 7.6mm thickness 1.1mm steam tap Qty 1 pcs		



1			
Part No.	528619	Ref. No.	190020
description	gasket rubber ED ø 13.5mm ID ø 4mm thickness 4mm steam/water tap Qty 1 pcs		

springs



1			
Part No.	528615	Ref. No.	160007
description	compression spring ø 10.7mm L 34.5mm wire gauge ø 1.5mm steam tap		



1			
Part No.	528622	Ref. No.	160003
description	spring ø 15.3mm L 25mm wire gauge ø 1.25mm for water filling		

miscellaneous



1			
Part No.	528621	Ref. No.	171100
description	ball ø 9.55mm steam tap SS		

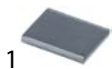

1			
Part No.	528620	Ref. No.	140042
description	spacer steam tap stainless steel L 15.1mm W 10mm thickness 2mm		

water taps

knobs



1			
Part No.	528627	Ref. No.	100020
description	push button ø 20mm chrome-plated brass thread M6		

steam/water pipes



steam pipes



1			
Part No.	531073	Ref. No.	900186
description	steam pipe stainless steel		





1			
Part No.	528624	Ref. No.	900014
description	steam pipe thread M10x1 H 150mm L 135mm ø 14.5mm ball head tube ø 10mm chrome-plated brass 60/60 series		

accessories for	528624		
	Part No.	528623	Ref. No. 160005
description	compression spring ø 12.1mm L 11.5mm wire gauge ø 1.5mm steam pipe coffee machine		
	Part No.	528625	Ref. No. 210071
description	tube handle L 35mm rubber ID ø 8mm		



1			
Part No.	528626	Ref. No.	900001
description	steam pipe thread M10x1 H 150mm L 140mm ø 12mm ball head tube ø 10mm chrome-plated brass 100 series		

accessories for	528626		
	Part No.	528231	Ref. No. —
description	O-ring Viton thickness 2.62mm ID ø 12.37mm Qty 1 pcs		
	Part No.	528623	Ref. No. 160005
description	compression spring ø 12.1mm L 11.5mm wire gauge ø 1.5mm steam pipe coffee machine		
	Part No.	528625	Ref. No. 210071
description	tube handle L 35mm rubber ID ø 8mm		

water pipes



1			
Part No.	528633	Ref. No.	900003
description	water pipe thread 3/8" ø 23.5mm L 58mm ball head WS 22 water hot		

accessories

springs







1			
Part No.	528623	Ref. No.	160005
description	compression spring ø 12.1mm L 11.5mm wire gauge ø 1.5mm steam pipe coffee machine		

tube handles







1			
Part No.	528625	Ref. No.	210071
description	tube handle L 35mm rubber ID ø 8mm		





intake valves			
intake valves			
			
1			
Part No.	528611	Ref. No.	900005
description	intake valve water complete		
spare parts for	528611		
	Part No.	528619	Ref. No. 190020
	gasket rubber ED ø 13.5mm ID ø 4mm thickness 4mm steam/water tap Qty 1 pcs		
	Part No.	528622	Ref. No. 160003
	spring ø 15.3mm L 25mm wire gauge ø 1.25mm for water filling		
	Part No.	528627	Ref. No. 100020
	push button ø 20mm chrome-plated brass thread M6		
	Part No.	528698	Ref. No. 150004
	flat gasket copper ED ø 24mm ID ø 20mm thickness 1mm		

level glasses			
level glasses			
gaskets			
			
1			
Part No.	529537	Ref. No.	190025
description	flat gasket PTFE ED ø 24mm ID ø 20.4mm thickness 1mm Qty 1 pcs		

balls			
			
1			
Part No.	528630	Ref. No.	030100
description	ball ø 6.6mm plastic water level glass		

level glass pipes			
			
1			
Part No.	528629	Ref. No.	210001
description	water level tube ø 12mm H 140mm ID ø 9mm		
accessories for	528629		
	Part No.	528344	Ref. No. 190006
	O-ring silicone thickness 2.62mm ID ø 12.37mm Qty 1 pcs		
	Part No.	528628	Ref. No. 100026
	washer ID ø 13.3mm ED ø 17mm thickness 0.5mm brass Qty 1 pcs water level glass		
	Part No.	528630	Ref. No. 030100
	ball ø 6.6mm plastic water level glass		

non-return valves			
complete			
			
1			
Part No.	529993	Ref. No.	900079
description	non-return valve inlet 3/8" outlet 3/8" L 40mm		

			
1			
Part No.	528991	Ref. No.	900079
description	non-return valve inlet 3/8" outlet 3/8" L 40mm suitable for MAGISTER		

for coffee grinders			
grinding burrs			
grinding burrs straight			
standard			
			
1			
Part No.	527227	Ref. No.	PRCOPMACM12
description	grinding burrs pair turn direction right D1 ø 63mm ID ø 38mm H 9.5mm tooth spacing 3mm hole ø 5.5mm bore ø 8.5mm mounting ø 48 straight suitable for FIORENZATO		

knobs			
steam/water taps			
			
1			
Part No.	111259	Ref. No.	030136
description	knob ø 50mm black/grey		

			
1			
Part No.	111260	Ref. No.	030020
description	knob steam ø 50mm black		



gaskets

O-rings

EPDM

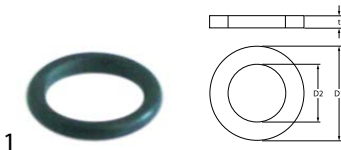

Part No.	528110	Ref. No.	190010
description	O-ring EPDM thickness 2.62mm ID ø 12.37mm Qty 1 pcs		

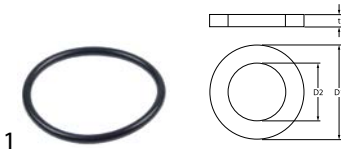

Part No.	528632	Ref. No.	190026
description	O-ring EPDM thickness 3.53mm ID ø 44.04mm Qty 1 pcs		

silicone

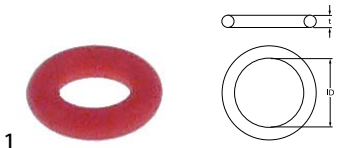

Part No.	526403	Ref. No.	190013
description	O-ring silicone thickness 1.78mm ID ø 3.69mm Qty 1 pcs		



Part No.	528344	Ref. No.	190006
description	O-ring silicone thickness 2.62mm ID ø 12.37mm Qty 1 pcs		

Viton

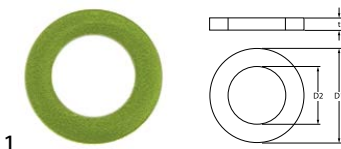

Part No.	101526	Ref. No.	190013
description	O-ring Viton thickness 1.78mm ID ø 4.48mm Qty 1 pcs		

sealing washers

rubber gaskets



Part No.	528619	Ref. No.	190020
description	gasket rubber ED ø 13.5mm ID ø 4mm thickness 4mm steam/water tap Qty 1 pcs		

copper gaskets

DIN-7603-A



Part No.	528698	Ref. No.	150004
description	flat gasket copper ED ø 24mm ID ø 20mm thickness 1mm		

PTFE gaskets



Part No.	528617	Ref. No.	190023
description	flat gasket PTFE ED ø 11.3mm ID ø 7.6mm thickness 1.1mm steam tap Qty 1 pcs		



Part No.	528634	Ref. No.	190011
description	flat gasket PTFE ED ø 20.5mm ID ø 17.5mm thickness 1.5mm Qty 1 pcs		



Part No.	529537	Ref. No.	190025
description	flat gasket PTFE ED ø 24mm ID ø 20.4mm thickness 1mm Qty 1 pcs		



springs

compression springs

			
1			
Part No.	528623	Ref. No.	160005
description	compression spring ø 12.1mm L 11.5mm wire gauge ø 1.5mm steam pipe coffee machine		

coffee accessories

milk foamers

			
1			
Part No.	802043	Ref. No.	900262 VENMONTMAN
description	milk foamer connection 3/8" stainless steel		

manometers

			
1			
Part No.	528843	Ref. No.	210022
description	manometer MAGISTER ø 60mm pressure range 0-3 / 0-15bar connection on the backside thread 1/8"		

			
1			
Part No.	528980	Ref. No.	210089
description	manometer MAGISTER ø 60mm pressure range 0-3 / 0-15bar connection on the backside thread 1/8" suitable for F2006 with hole for lampe		

			
1			
Part No.	528675	Ref. No.	210090
description	manometer ø 51.5mm pressure range 0-16bar MAGISTER thread 1/4" marking 9 pump connection on the backside		

			
1			
Part No.	528714	Ref. No.	210021
description	manometer ø 51.5mm pressure range 0-3bar MAGISTER thread 1/4" marking 1.8 steam connection on the backside		

fittings, hose and pipe connectors

hose connectors

			
1			
Part No.	528985 ¹	Ref. No.	900076
description	hose connector plastic angled thread 3/4" hose ø 13mm Qty 1 pcs		
	¹ incl. flat rubber gasket		

fastening material

screws

countersunk screws

			
1			
Part No.	560383	Ref. No.	170501
description	countersunk screw thread M5 L 16mm SS DIN 965/ISO 7046 Qty 1 pcs head ø 9mm oval head		

			
1			
Part No.	560370	Ref. No.	170413
description	countersunk screw thread M5 L 16mm stainless steel DIN 965/ISO 7046 Qty 1 pcs intake Phillips head ø 9mm		

flat-headed bolts

			
1			
Part No.	560371	Ref. No.	170400
description	flat-headed bolt thread M4 thread L 12mm SS DIN 7985/ISO 7045 Qty 1 pcs intake Phillips head ø 8mm head thickness 3mm		



grub screws

DIN 914/ISO 4027

1

Part No.		Ref. No.	171002
description	grub screw thread M12x1.75 L 14.2mm stainless steel DIN 914 intake internal hexagon WS 6 Qty 1 pcs		

1

Part No.	697410	Ref. No.	171003
description	grub screw thread M5 L 6mm stainless steel DIN 914/ISO 4027 WS 2.5 with spike Qty 1 pcs		

washers

washers

miscellaneous

1

Part No.	528628	Ref. No.	100026
description	washer ID \varnothing 13.3mm ED \varnothing 17mm thickness 0.5mm brass Qty 1 pcs water level glass		

1

Part No.	528616	Ref. No.	100114
description	washer ID \varnothing 7.4mm ED \varnothing 10.9mm thickness 0.5mm stainless steel steam tap		

fasteners

retaining rings

DIN 6799

1

Part No.	529724	Ref. No.	171101
description	retaining ring E D1 \varnothing 4mm D2 \varnothing 9mm SS DIN 6799 thickness 0.7mm for shaft \varnothing 4-5mm		

consumables

fuses

fine fuses

1

Part No.	358676	Ref. No.	180101
description	fine fuse size \varnothing 5x20mm 3.15A fast-acting rated 250V Qty 10 pcs		

1

Part No.	358607	Ref. No.	180155
description	fine fuse size \varnothing 5x20mm 6.3A slow-acting rated 250V Qty 10 pcs		

GASTROPARTS.COM

