



**GASTROPARTS**

# Mafirol

- [EN]** Equipment
- [DE]** Geräte
- [ES]** Aparatos
- [FR]** Équipement
- [IT]** Attrezzature
- [PL]** Urządzenia
- [RU]** Оборудование

✉ [gastroparts@gastroparts.com](mailto:gastroparts@gastroparts.com)

☎ tel. +48 56 657 00 66

📘 [fb.com/gastroparts.global](https://fb.com/gastroparts.global)

**GASTROPARTS.COM**





## heating elements

### heating elements for refrigeration

#### heating elements for condensate evaporation



1

|                    |  |                 |           |
|--------------------|--|-----------------|-----------|
| <b>Part No.</b>    | 418732   | <b>Ref. No.</b> | 877107800 |
| <b>description</b> | heating element 650W 230V L 280mm W 95mm H 87mm L1 65mm L2 215mm cable length 1500mm connection distance 86mm tube ø 8.5mm heating circuits 1 immersion heater |                 |           |
| <b>For models:</b> | 927100100, 927102100, 927200200, 927300200, 927300300  |                 |           |



1

|                    |   |                 |           |
|--------------------|---|-----------------|-----------|
| <b>Part No.</b>    | 418733  | <b>Ref. No.</b> | 877107900 |
| <b>description</b> | heating element 750W 230V L 430mm W 95mm H 98mm L1 85mm L2 345mm cable length 1500mm connection cable connection distance 86mm tube ø 8.5mm heating circuits 1 immersion heater |                 |           |
| <b>For models:</b> | 927100200, 927100300, 927100400, 927102200, 927102300, 927102400, 927200300   |                 |           |

#### condensing trays heated







1

|   |  |                 |                  |
|---|--|-----------------|------------------|
| <b>Part No.</b>   | 750005   | <b>Ref. No.</b> | 222312100        |
| <b>description</b>  | condensing tray heated L 240mm W 240mm H 250mm   |                 |                  |
| <b>For models:</b>  | 927100100, 927102100   |                 |                  |
| <b>spare parts for</b>  | 750005   |                 |                  |
|   | <b>Part No.</b>  | <b>Ref. No.</b> | <b>877107800</b> |
|  | heating element 650W 230V L 280mm W 95mm H 87mm L1 65mm L2 215mm cable length 1500mm connection distance 86mm tube ø 8.5mm heating circuits 1 immersion heater |                 |                  |



1

|   |  |                 |                  |
|---|--|-----------------|------------------|
| <b>Part No.</b>   | 750003   | <b>Ref. No.</b> | 226303600        |
| <b>description</b>  | condensing tray heated L 240mm W 240mm H 75mm 230V 650W connect with power contactor   |                 |                  |
| <b>For models:</b>  | 927200200, 927300200, 927300300  |                 |                  |
| <b>spare parts for</b>  | 750003   |                 |                  |
|   | <b>Part No.</b>  | <b>Ref. No.</b> | <b>—</b>         |
|  | float switch 250V 1A 1NO or 1NC thread M16x1.5 ø 17.4mm L 100.5mm mounting ø 28mm cable cable length 1500mm temp.-resist. -20 up to +90°C                      |                 |                  |
|   | <b>Part No.</b>  | <b>Ref. No.</b> | <b>877107800</b> |
|  | heating element 650W 230V L 280mm W 95mm H 87mm L1 65mm L2 215mm cable length 1500mm connection distance 86mm tube ø 8.5mm heating circuits 1 immersion heater |                 |                  |
| <b>accessories for</b>  | 750003   |                 |                  |
|   | <b>Part No.</b>  | <b>Ref. No.</b> | <b>880302100</b> |
|  | power relays Italiana Relè 230VAC 30A 1NO connection F6.3 bracket mounting dimensions 36.5x32.2x51.8mm manuf. no. A10-230AC-FA                                 |                 |                  |



1





|                    |  |                 |           |
|--------------------|--|-----------------|-----------|
| <b>Part No.</b>    | 750007   | <b>Ref. No.</b> | 224011500 |
| <b>description</b> | condensing tray heated L 300mm W 155mm H 105mm 230V 300W without level electrode |                 |           |



1

|                    |  |                 |           |
|--------------------|--|-----------------|-----------|
| <b>Part No.</b>    | 750006   | <b>Ref. No.</b> | 222312200 |
| <b>description</b> | condensing tray heated L 380mm W 240mm H 250mm                   |                 |           |
| <b>For models:</b> | 927100200, 927100300, 927100400, 927102200, 927102300, 927102400 |                 |           |





|   |   |                 |                           |
|---|---|-----------------|---------------------------|
|  |   |                 |                           |
| 1   |   |                 |                           |
| <b>Part No.</b>   | 750004  | <b>Ref. No.</b> | 227206000                 |
| <b>description</b>  | condensing tray heated L 380mm W 240mm H 75mm 230V 750W with float switch   |                 |                           |
| <b>For models:</b>  | 927200300   |                 |                           |
| <b>spare parts for</b>  | 750004  |                 |                           |
|   | <b>Part No.</b>   | 348139          | <b>Ref. No.</b> —         |
|  | float switch 250V 1A 1NO or 1NC thread M16x1.5 ø 17.4mm L 100.5mm mounting ø 28mm cable length 1500mm temp.-resist. -20 up to +90°C   |                 |                           |
|   | <b>Part No.</b>   | 418733          | <b>Ref. No.</b> 877107900 |
|  | heating element 750W 230V L 430mm W 95mm H 98mm L1 85mm L2 345mm cable length 1500mm connection cable connection distance 86mm tube ø 8.5mm heating circuits 1 immersion heater |                 |                           |
| <b>accessories for</b>  | 750004  |                 |                           |
|  | <b>Part No.</b>   | 380185          | <b>Ref. No.</b> 880302100 |
|   | power relays Italiana Relè 230VAC 30A 1NO connection F6.3 bracket mounting dimensions 36.5x32.2x51.8mm manuf. no. A1O-230AC-FA  |                 |                           |

## heating cables

## drain heating cables

|   |  |                 |           |
|---|--|-----------------|-----------|
|  |  |                 |           |
| 1   |  |                 |           |
| <b>Part No.</b>   | 418735   | <b>Ref. No.</b> | 224820200 |
| <b>description</b>  | drain heating cable 37W 230V L 1980mm L1 (unheated) 190mm L2 (heated) 1790mm silicone 25W/m connection cable |                 |           |
| <b>For models:</b>  | 925701300, 925702300   |                 |           |

|   |   |                 |           |
|---|---|-----------------|-----------|
|  |   |                 |           |
| 1   |   |                 |           |
| <b>Part No.</b>   | 418734  | <b>Ref. No.</b> | 224820100 |
| <b>description</b>  | drain heating cable 37W 230V ø 6mm L 1670mm L1 (unheated) 130mm L2 (heated) 1650mm cable length 110mm silicone 25W/m connection cable |                 |           |
| <b>For models:</b>  | 925701200, 925702200  |                 |           |

|   |   |                 |           |
|---|---|-----------------|-----------|
|  |   |                 |           |
| 1   |   |                 |           |
| <b>Part No.</b>   | 418736  | <b>Ref. No.</b> | 224820300 |
| <b>description</b>  | drain heating cable 50W 230V ø 6mm L 2120mm L1 (unheated) 130mm L2 (heated) 2010mm cable length 110mm silicone 25W/m connection cable |                 |           |
| <b>For models:</b>  | 925701400, 925702400  |                 |           |

|  |  |                 |           |
|--|--|-----------------|-----------|
|  |  |                 |           |
| 1  |  |                 |           |
| <b>Part No.</b>  | 418737   | <b>Ref. No.</b> | 224820400 |
| <b>description</b>   | drain heating cable 62W 230V ø 6mm L 2680mm L1 (unheated) 130mm L2 (heated) 2550mm silicone 25W/m connection cable |                 |           |
| <b>For models:</b>   | 925701500, 925702500   |                 |           |

## accessories



## hexagonal nuts

|   |  |                 |           |
|---|--|-----------------|-----------|
|  |  |                 |           |
| 1   |  |                 |           |
| <b>Part No.</b>   | 560132   | <b>Ref. No.</b> | 886003500 |
| <b>description</b>  | hexagonal nut thread M5 H 4mm WS 8 SS DIN/ISO DIN 934 / ISO 4032/8673 Qty 20 pcs   |                 |           |
| <b>For models:</b>  | 925600100, 925600200, 925600300, 925601200, 925601300, 925601400, 925603300, 925603400, 925603500, 925701100, 925701200, 925701300, 925701400, 925701500, 925701600, 925702100, 925702200, 925702300, 925702400, 925702500, 925702600, 926002000, 926002500, 926002600, 926003000, 926003100 |                 |           |

## switches and momentary switches

## rocker/momentary rocker switches

## 30x22mm

|   |   |                 |                   |
|---|---|-----------------|-------------------|
|  |   |                 |                   |
| 1   |   |                 |                   |
| <b>Part No.</b>   | 301003  | <b>Ref. No.</b> | 877124300         |
| <b>description</b>  | rocker switch mounting measurements 30x22mm green 2NO 250V 16A illuminated 0-I connection male faston 6.3mm ambient temperature max. 125/55°C protection IP65 |                 |                   |
| <b>For models:</b>  | 927100100, 927100200, 927100300, 927100400, 927102100, 927102200, 927102300, 927102400, 927200300, 927300100, 927300200, 927300300                            |                 |                   |
| <b>accessories for</b>  | 301003  |                 |                   |
|   | <b>Part No.</b>   | 301036          | <b>Ref. No.</b> — |
|  | protective cover internal size 30x22mm for rocker switch mounting measurementsmm  |                 |                   |

|   |   |                 |           |
|---|---|-----------------|-----------|
|  |   |                 |           |
| 1   |   |                 |           |
| <b>Part No.</b>   | 347019  | <b>Ref. No.</b> | 877124200 |
| <b>description</b>  | rocker switch mounting measurements 30x22mm orange 2NO 250V 16A illuminated lamp connection male faston 6.3mm ambient temperature max. 100/55°C protection IP40   |                 |           |
| <b>For models:</b>  | 925701100, 925701200, 925701300, 925701400, 925701500, 925701600, 925702100, 925702200, 925702300, 925702400, 925702500, 925702600, 927100100, 927100200, 927100300, 927100400, 927102100, 927102200, 927102300, 927102400, 927200300 |                 |           |



float switches

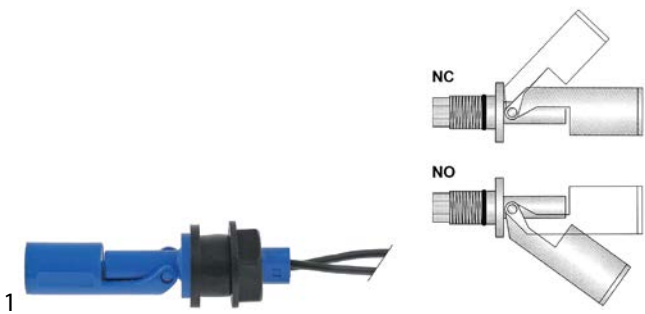

|                    |   |                 |           |
|--------------------|---|-----------------|-----------|
| <b>Part No.</b>    | 347020  | <b>Ref. No.</b> | 877121600 |
| <b>description</b> | float switch thread M16x2 1NO or 1NC ø 16mm L 88.5mm mounting ø 16mm 250V 1A cable cable length 800mm |                 |           |
| <b>For models:</b> | 927200200, 927200300, 927300200, 927300300  |                 |           |

lamps

fluorescent lamps

fluorescent lamps

G13



|                    |   |                 |           |
|--------------------|---|-----------------|-----------|
| <b>Part No.</b>    | 357008  | <b>Ref. No.</b> | 877016000 |
| <b>description</b> | fluorescent lamp socket G13 L 1198mm 36W 230V Qty 1 pcs |                 |           |
| <b>For models:</b> | 927100200, 927100400, 927102200, 927102400              |                 |           |



|                    |   |                 |           |
|--------------------|---|-----------------|-----------|
| <b>Part No.</b>    | 359386  | <b>Ref. No.</b> | 877010700 |
| <b>description</b> | fluorescent lamp socket G13 L 1198mm 36W 230V Qty 1 pcs   |                 |           |
| <b>For models:</b> | 925600300, 925601300, 925603300, 925701300, 925701600, 925702300, 925702600, 927100100, 927100200, 927100300, 927100400, 927102100, 927102200, 927102300, 927102400 |                 |           |



|                    |   |                 |           |
|--------------------|---|-----------------|-----------|
| <b>Part No.</b>    | 359390  | <b>Ref. No.</b> | 877016600 |
| <b>description</b> | fluorescent lamp socket G13 L 1500mm 58W 230V Qty 1 pcs |                 |           |
| <b>For models:</b> | 925601400, 925603400, 925701400, 925702400              |                 |           |



|                    |   |                 |           |
|--------------------|---|-----------------|-----------|
| <b>Part No.</b>    | 359383  | <b>Ref. No.</b> | 877010200 |
| <b>description</b> | fluorescent lamp socket G13 L 438mm 15W 230V Qty 1 pcs light colour 640 |                 |           |
| <b>For models:</b> | 927200100   |                 |           |



|                    |  |                 |           |
|--------------------|--|-----------------|-----------|
| <b>Part No.</b>    | 359371   | <b>Ref. No.</b> | 877010400 |
| <b>description</b> | fluorescent lamp socket G13 L 590mm 18W 230V Qty 1 pcs |                 |           |
| <b>For models:</b> | 925600100, 925701100, 925702100, 927200200             |                 |           |



|                    |  |                 |           |
|--------------------|--|-----------------|-----------|
| <b>Part No.</b>    | 359372   | <b>Ref. No.</b> | 877010500 |
| <b>description</b> | fluorescent lamp socket G13 L 895mm 30W 230V Qty 1 pcs |                 |           |
| <b>For models:</b> | 927200300  |                 |           |



|                    |   |                 |           |
|--------------------|---|-----------------|-----------|
| <b>Part No.</b>    | 357007  | <b>Ref. No.</b> | 877016300 |
| <b>description</b> | fluorescent lamp socket G13 L 895mm 30W ø 27mm 230V Qty 1 pcs |                 |           |
| <b>For models:</b> | 927100100, 927100300, 927102100, 927102300                    |                 |           |

|                        |        |  |  |
|------------------------|--------|--|--|
| <b>accessories for</b> | 357007 |  |  |
|------------------------|--------|--|--|



|                    |               |                 |           |
|--------------------|---------------|-----------------|-----------|
| <b>Part No.</b>    | 380464        | <b>Ref. No.</b> | 877003100 |
| <b>description</b> | starter 4-65W |                 |           |



|                    |                                       |                 |           |
|--------------------|---------------------------------------|-----------------|-----------|
| <b>Part No.</b>    | 401505                                | <b>Ref. No.</b> | 877000500 |
| <b>description</b> | electrical ballast 36W 230V Qty 1 pcs |                 |           |



|                    |   |                 |           |
|--------------------|---|-----------------|-----------|
| <b>Part No.</b>    | 402065  | <b>Ref. No.</b> | 877000400 |
| <b>description</b> | electrical ballast 30W 230V for fluorescent lamps Qty 1 pcs |                 |           |



|                    |   |                 |           |
|--------------------|---|-----------------|-----------|
| <b>Part No.</b>    | 359738  | <b>Ref. No.</b> | 877016700 |
| <b>description</b> | fluorescent lamp socket G13 L 970mm 23W 230V Qty 1 pcs                      |                 |           |
| <b>For models:</b> | 925600200, 925601200, 925603500, 925701200, 925701500, 925702200, 925702500 |                 |           |

accessories

starter



|                    |   |                 |           |
|--------------------|---|-----------------|-----------|
| <b>Part No.</b>    | 380464  | <b>Ref. No.</b> | 877003100 |
| <b>description</b> | starter 4-65W   |                 |           |
| <b>For models:</b> | 925600100, 925600200, 925600300, 925601200, 925601300, 925601400, 925603300, 925603400, 925603500, 925701100, 925701200, 925701300, 925701400, 925701500, 925701600, 925702100, 925702200, 925702300, 925702400, 925702500, 925702600, 927100100, 927100200, 927100300, 927100400, 927102100, 927102200, 927102300, 927102400 |                 |           |

ballasts



|                    |   |                 |           |
|--------------------|---|-----------------|-----------|
| <b>Part No.</b>    | 402063  | <b>Ref. No.</b> | 877000100 |
| <b>description</b> | electrical ballast 15W 230V for fluorescent lamps Qty 1 pcs |                 |           |
| <b>For models:</b> | 927200100   |                 |           |



1

|                    |  |                 |           |
|--------------------|--|-----------------|-----------|
| <b>Part No.</b>    | 401504                                     | <b>Ref. No.</b> | 877000200 |
| <b>description</b> | electrical ballast 18W 230V Qty 1 pcs      |                 |           |
| <b>For models:</b> | 925600100, 925701100, 925702100, 927200200 |                 |           |



1

|                    |   |                 |           |
|--------------------|---|-----------------|-----------|
| <b>Part No.</b>    | 402064  | <b>Ref. No.</b> | 877000300 |
| <b>description</b> | electrical ballast 25W 230V Qty 1 pcs                                       |                 |           |
| <b>For models:</b> | 925600200, 925601200, 925603500, 925701200, 925701500, 925702200, 925702500 |                 |           |



1

|                    |   |                 |           |
|--------------------|---|-----------------|-----------|
| <b>Part No.</b>    | 402065  | <b>Ref. No.</b> | 877000400 |
| <b>description</b> | electrical ballast 30W 230V for fluorescent lamps Qty 1 pcs |                 |           |
| <b>For models:</b> | 927100100, 927100300, 927102100, 927102300, 927200300       |                 |           |



1

|                    |   |                 |           |
|--------------------|---|-----------------|-----------|
| <b>Part No.</b>    | 401505  | <b>Ref. No.</b> | 877000500 |
| <b>description</b> | electrical ballast 36W 230V Qty 1 pcs   |                 |           |
| <b>For models:</b> | 925600300, 925601300, 925603300, 925701300, 925701600, 925702300, 925702600, 927100200, 927100400, 927102200, 927102400 |                 |           |



1

|                    |   |                 |           |
|--------------------|---|-----------------|-----------|
| <b>Part No.</b>    | 402066  | <b>Ref. No.</b> | 877000800 |
| <b>description</b> | electrical ballast 58W 230V for fluorescent lamps Qty 1 pcs |                 |           |
| <b>For models:</b> | 925601400, 925603400, 925701400, 925702400                  |                 |           |

## covers



1

|                    |  |                 |           |
|--------------------|--|-----------------|-----------|
| <b>Part No.</b>    | 551020   | <b>Ref. No.</b> | 877030500 |
| <b>description</b> | protection cap for fluorescent lamps ø 30mm  |                 |           |
| <b>For models:</b> | 927100100, 927100200, 927100300, 927100400, 927102100, 927102200, 927102300, 927102400 |                 |           |

## protective tube



1

|                    |  |                 |           |
|--------------------|--|-----------------|-----------|
| <b>Part No.</b>    | 550614   | <b>Ref. No.</b> | 127113400 |
| <b>description</b> | protection pipe for fluorescent lamps L 1195mm ømm                                     |                 |           |
| <b>For models:</b> | 927100100, 927100200, 927100300, 927100400, 927102100, 927102200, 927102300, 927102400 |                 |           |

1

|                    |   |                 |           |
|--------------------|---|-----------------|-----------|
| <b>Part No.</b>    | 550613  | <b>Ref. No.</b> | 870736300 |
| <b>description</b> | protection pipe for fluorescent lamps ø 28.7mm L 1180mm Qty 1 pcs |                 |           |
| <b>For models:</b> | 927100200, 927100400, 927102200, 927102400                        |                 |           |

1

|                    |  |                 |           |
|--------------------|--|-----------------|-----------|
| <b>Part No.</b>    | 550612   | <b>Ref. No.</b> | 870736100 |
| <b>description</b> | protection pipe for fluorescent lamps ø 28.7mm L 875mm Qty 1 pcs |                 |           |
| <b>For models:</b> | 927100100, 927100300, 927102100, 927102300                       |                 |           |

## contactors

## MOELLER/EATON

## power contactors



1

|                    |  |                 |           |
|--------------------|--|-----------------|-----------|
| <b>Part No.</b>    | 380172   | <b>Ref. No.</b> | 877121000 |
| <b>description</b> | power contactor resistive load 20A 230VAC (AC3/400V) 9A/4kW main contacts 3NO auxiliary contacts 1NC connection screw connection type DILEM 01 |                 |           |
| <b>For models:</b> | 927100100, 927100200, 927100300, 927100400, 927102100, 927102200, 927102300, 927102400, 927200300, 927300100, 927300200, 927300300             |                 |           |



relays

power relays

with bracket mounting



1

|                    |  |                 |           |
|--------------------|--|-----------------|-----------|
| <b>Part No.</b>    | 380185   | <b>Ref. No.</b> | 880302100 |
| <b>description</b> | power relays Italiana Relè 230VAC 30A 1NO connection F6.3 bracket mounting dimensions 36.5x32.2x51.8mm manuf. no. A10-230AC-FA |                 |           |
| <b>For models:</b> | 927200300  |                 |           |

level relays

miscellaneous



1

|                    |  |                 |           |
|--------------------|--|-----------------|-----------|
| <b>Part No.</b>    | 402067   | <b>Ref. No.</b> | 877121500 |
| <b>description</b> | level relay 230V voltage AC type RNP20-023   |                 |           |
| <b>For models:</b> | 927100100, 927100200, 927100300, 927100400, 927102100, 927102200, 927102300, 927102400, 927200100, 927300100 |                 |           |

electronic controllers



DIXELL













refrigeration controllers

built-in version



1

|   |   |                 |                              |
|---|---|-----------------|------------------------------|
| <b>Part No.</b>   | 378000  | <b>Ref. No.</b> | 880313100<br>8803173+8803195 |
| <b>description</b>  | electronic controller DIXELL XR20CX-5N0C1 mounting measurements 71x29mm 230V voltage AC NTC/PTC relay outputs 1 NO-20A(8) NTC/PTC NTC/PTC/DI protection IP54 -50 up to +150°C display 3½ digits |                 |                              |
| <b>accessories for</b>  | 378000  |                 |                              |
|  | <b>Part No.</b>   | 378194          | <b>Ref. No.</b> —            |
|   | temperature probe NTC 10kOhm cable PVC probe -20 up to +80°C cable -10 up to 100°C probe ø7x24.5mm cable length 1.5m without screw connection 2-wire  |                 |                              |
|  | <b>Part No.</b>   | 378551          | <b>Ref. No.</b> —            |
|   | adapter for reducer mounting measurements 71x29mm   |                 |                              |

|   |  |        |                   |
|---|--|--------|-------------------|
| <b>accessories for</b>  | 378000   |        |                   |
|    | <b>Part No.</b>  | 379052 | <b>Ref. No.</b> — |
|   | temperature probe PTC 1kOhm cable silicone probe -50 up to +150°C cable -50 up to +180°C probe ø6x40mm cable length 1.5m without screw connection 2-wire       |        |                   |
|    | <b>Part No.</b>  | 379053 | <b>Ref. No.</b> — |
|   | temperature probe PTC 1kOhm cable PVC probe -50 up to +150°C cable -10 up to 100°C probe ø6x30mm cable length 3m without screw connection 2-wire               |        |                   |
|    | <b>Part No.</b>  | 379057 | <b>Ref. No.</b> — |
|   | temperature probe NTC 10kOhm cable PVC probe -20 up to +80°C cable -10 up to 100°C probe ø6x25mm cable length 3m 2-wire  |        |                   |
|    | <b>Part No.</b>  | 379064 | <b>Ref. No.</b> — |
|   | temperature probe PTC 1kOhm cable silicone probe -50 up to +150°C cable -50 up to +180°C probe ø6x40mm cable length 3m without screw connection 2-wire         |        |                   |
|    | <b>Part No.</b>  | 379142 | <b>Ref. No.</b> — |
|   | temperature probe PTC 1kOhm cable PVC probe -50 up to +150°C cable -10 up to 100°C probe ø6x30mm cable length 1.5m without screw connection 2-wire             |        |                   |
|    | <b>Part No.</b>  | 379160 | <b>Ref. No.</b> — |
|   | temperature probe NTC 10kOhm cable thermoplastic probe -40 up to +110°C cable -40 up to +110°C probe ø6x14mm cable length 1.5m without screw connection 2-wire |        |                   |
|    | <b>Part No.</b>  | 379161 | <b>Ref. No.</b> — |
|   | temperature probe NTC 10kOhm cable thermoplastic probe -40 up to +110°C cable -40 up to +110°C probe ø6x14mm cable length 3m without screw connection 2-wire   |        |                   |
|    | <b>Part No.</b>  | 379343 | <b>Ref. No.</b> — |
|   | temperature probe NTC 10kOhm cable silicone probe -40 up to +110°C cable -50 up to +180°C probe ø6x40mm cable length 3m 2-wire                                 |        |                   |
|  | <b>Part No.</b>  | 379458 | <b>Ref. No.</b> — |
|   | temperature probe NTC 10kOhm cable silicone probe -40 up to +110°C cable -50 up to +180°C probe ø6x40mm cable length 1.5m without screw connection 2-wire      |        |                   |
|  | <b>Part No.</b>  | 379781 | <b>Ref. No.</b> — |
|   | temperature probe PTC 1kOhm cable thermoplastic probe -50 up to +150°C cable -40 up to +110°C probe ø6x14mm cable length 1.5m without screw connection 2-wire  |        |                   |
|  | <b>Part No.</b>  | 379782 | <b>Ref. No.</b> — |
|   | temperature probe PTC 1kOhm cable thermoplastic probe -50 up to +150°C cable -40 up to +110°C probe ø6x14mm cable length 3m 2-wire resistor 1kOhm              |        |                   |
|  | <b>Part No.</b>  | 402818 | <b>Ref. No.</b> — |
|   | programming key 4K for electronic controller DIXELL  |        |                   |
|  | <b>Part No.</b>  | 699260 | <b>Ref. No.</b> — |
|   | connection cable L 2m connection coded plug  |        |                   |

→ electric components





built-in version 2-piece



1

|  |   |                 |                   |
|--|---|-----------------|-------------------|
| <b>Part No.</b>  | 402068  | <b>Ref. No.</b> | 880312100         |
| <b>description</b>   | power PCB DIXELL XM470K-500C1 mounting measurements 132x152mm built-in depth 40mm 230V voltage AC NTC relay outputs 4 NO-8A(3) NO-20A(8) NO-8A(3) NO-16A(3) NO-8A(3) NTC NTC NTC -40 up to +110°C display |                 |                   |
| <b>For models:</b>   | 927300200, 927300300  |                 |                   |
| <b>accessories for</b>   | 402068  |                 |                   |
|  | <b>Part No.</b>   | 378278          | <b>Ref. No.</b> — |
|  | keypad unit DIXELL T640 mounting measurements 150x30mm built-in depth 23mmV voltage relay outputs°C display 3½ digits   |                 |                   |

## compressors

ACC/ZEL

R404a/R507

HMBP monophase

High/Medium evaporation temperature above -20/-15 °C



1

|                    |  |                 |           |
|--------------------|--|-----------------|-----------|
| <b>Part No.</b>    | 605068   | <b>Ref. No.</b> | 880218000 |
| <b>description</b> | compressor coolant R404a/R507 type ML45TB 220-240V 50Hz HMBP fully hermetic 10kg 1/5HP cylinder capacity 4.5cm <sup>3</sup> CSIR H 175.5mmW 192W 246W 309W 382W 465W 557W 659W 771W test method ASHRAE |                 |           |
| <b>For models:</b> | 925600100  |                 |           |



1

|                    |   |                 |           |
|--------------------|---|-----------------|-----------|
| <b>Part No.</b>    | 605069  | <b>Ref. No.</b> | 880218400 |
| <b>description</b> | compressor coolant R404a/R507 type ML80TG 220-240V 50Hz HMBP fully hermetic 11.2kg 3/8HP cylinder capacity 7.6cm <sup>3</sup> CSIR H 175.5mmWWW 386W 487W 603W 734W 880W 1041W test method ASHRAE ambient temperature max. 43°C |                 |           |
| <b>For models:</b> | 925601400, 925603400, 925701100, 925702100  |                 |           |



1

|                    |   |                 |           |
|--------------------|---|-----------------|-----------|
| <b>Part No.</b>    | 605028  | <b>Ref. No.</b> | 880216900 |
| <b>description</b> | compressor coolant R404a/R507 type ML90TB 220-240V 50Hz HMBP fully hermetic 11.6kg 3/8HP cylinder capacity 8.85cm <sup>3</sup> CSIR H 175.5mmW 323W 418W 532W 666W 819W 990W 1181W 1391W test method ASHRAE ambient temperature max. 43°C |                 |           |
| <b>For models:</b> | 925603500, 925701200, 925701300, 925702200, 925702300   |                 |           |





1

|                    |   |                 |           |
|--------------------|---|-----------------|-----------|
| <b>Part No.</b>    | 605071  | <b>Ref. No.</b> | 880217400 |
| <b>description</b> | compressor coolant R404a/R507 type MS26TB 230V 50Hz HMBP fully hermetic 23kg cylinder capacity 25.9cm <sup>3</sup> CSR 1295W 1687W 2132W 2631W 3184W 3791W test method ASHRAE |                 |           |
| <b>For models:</b> | 927100200, 927100400, 927102200, 927102400, 927200300   |                 |           |



1

|   |   |                 |                   |
|---|---|-----------------|-------------------|
| <b>Part No.</b>   | 605072  | <b>Ref. No.</b> | 880216500         |
| <b>description</b>  | compressor coolant R404a/R507 type MX18TBa 220-240V 50Hz HMBP fully hermetic 17.2kg 7/8HP cylinder capacity 18.4cm <sup>3</sup> CSR H 213mmW 640W 839W 1076W 1350W 1663W 2013W 2400W 2826W test method ASHRAE ambient temperature max. 43°C |                 |                   |
| <b>For models:</b>  | 925701600, 925702600, 927100300, 927102300, 927200100, 927300200, 927300300   |                 |                   |
| <b>spare parts for</b>  | 605072  |                 |                   |
|  | <b>Part No.</b>   | 365006          | <b>Ref. No.</b> — |
|   | operating capacitor capacity 16µF 400V tolerance 5% 50/60Hz ambient temperature max. -25 to +85°C ø 35mm L 121mm M8 aluminium connection cable 300mm MKP protection IP65  |                 |                   |
|  | <b>Part No.</b>   | 365128          | <b>Ref. No.</b> — |
|   | operating capacitor capacity 16µF 450V tolerance 5% 50-60Hz ambient temperature max. -25 to +85°C ø 40mm L 100mm M8 aluminium connection male faston 6.3mm 16.26.16 protection  |                 |                   |



1

|                    |  |                 |         |
|--------------------|--|-----------------|---------|
| <b>Part No.</b>    | 605093   | <b>Ref. No.</b> | 8802172 |
| <b>description</b> | compressor coolant R404a/R507 type MX21TB 220-240V 50Hz HMBP 17.5kg 1HP cylinder capacity 20.73cm <sup>3</sup> CSR H 221mmW 733W 813W 892W 970W 1046W 1121W 1195W 1268W test method ASHRAE ambient temperature max. 43°C |                 |         |

CUBIGEL

R404a/R507

HMBP monophase

High/Medium evaporation temperature above -20/-15 °C



1

|                    |   |                 |           |
|--------------------|---|-----------------|-----------|
| <b>Part No.</b>    | 605013  | <b>Ref. No.</b> | 880216700 |
| <b>description</b> | compressor coolant R404a/R507 type ML60TB 220-240V 50Hz HMBP fully hermetic 10.1kg 1/4HP power input 647W cylinder capacity 5.68cm <sup>3</sup> CSIR H 175.5mmW 244W 319W 407W 511W 628W 760W 906W 1067W test method ASHRAE |                 |           |
| <b>For models:</b> | 925600200, 925600300, 925601200, 925601300, 925603300   |                 |           |



1

|                    |  |                 |           |
|--------------------|--|-----------------|-----------|
| <b>Part No.</b>    | 605029   | <b>Ref. No.</b> | 880217000 |
| <b>description</b> | compressor coolant R404a/R507 type MP12RB 220-240V 50Hz HMBP fully hermetic 13.5kg 1/2HP cylinder capacity 12cm <sup>3</sup> CSR H 203.6mmW 561W 734W 933W 1157W 1407W 1681W 1982WW test method ASHRAE ambient temperature max. 43°C |                 |           |
| <b>For models:</b> | 925701400, 925702400   |                 |           |





1

|                    |  |                 |           |
|--------------------|--|-----------------|-----------|
| <b>Part No.</b>    | 605067   | <b>Ref. No.</b> | 880217100 |
| <b>description</b> | compressor coolant R404a/R507 type MPT14RA 220-240V 50Hz HMBP fully hermetic 13.5kg 1/2HP cylinder capacity 14.32cm <sup>3</sup> CSR H 210mmWWW 665W 720W 775W 829W 882W 934W test method ASHRAE |                 |           |
| <b>For models:</b> | 925701500, 925702500, 927300100  |                 |           |

**EMBRACO / ASPERA**

R404a/R507  
HMBP monophase

*High/Medium evaporation temperature above -20/-15 °C*





1

|                    |   |                 |         |
|--------------------|---|-----------------|---------|
| <b>Part No.</b>    | 605149  | <b>Ref. No.</b> | 8802189 |
| <b>description</b> | compressor coolant R404a/R507 type NEK6144GK 220-240V 50Hz HMBP fully hermetic 10kg 1/6HP cylinder capacity 4.51cm <sup>3</sup> CSIR H 190mmW 271W 326W 395W 480W 580W 694W 825W test method ASHRAE46 |                 |         |



1

|                        |  |                 |         |
|------------------------|--|-----------------|---------|
| <b>Part No.</b>        | 605132   | <b>Ref. No.</b> | 8802195 |
| <b>description</b>     | compressor coolant R404a/R507 type NT6222GK 200-240V 50Hz HMBP fully hermetic 17kg 1HP cylinder capacity 17.39cm <sup>3</sup> CSR H 252mmW 810W 1032W 1040W 1174W 1307W 1583W 2247W test method ASHRAE |                 |         |
| <b>accessories for</b> | 605132   |                 |         |

|   |  |        |                 |   |
|---|--|--------|-----------------|---|
|  | <b>Part No.</b>  | 365142 | <b>Ref. No.</b> | — |
|   | operating capacitor capacity 15µF 450V with metal case tolerance 5% 50/60Hz ø 40mm L 110mm M8x1.25                   |        |                 |   |
|  | <b>Part No.</b>  | 365153 | <b>Ref. No.</b> | — |
|   | starting capacitor 52µF 330V 50/60Hz duty cycle 3s 41280A133 2252347 ø 36mm L 83mm M8 plastic connection cable 350mm |        |                 |   |
|  | <b>Part No.</b>  | 390981 | <b>Ref. No.</b> | — |
|   | klixon suitable for NT6222GK   |        |                 |   |

**L'UNITE HERMETIQUE / TECUMSEH**

R404A  
HMBP monophase

*High/Medium evaporation temperature above -20/-15 °C*



1

|                    |   |                 |           |
|--------------------|---|-----------------|-----------|
| <b>Part No.</b>    | 605027  | <b>Ref. No.</b> | 880217400 |
| <b>description</b> | compressor coolant R404A type CAJ4517Z 220-240V 50Hz HMBP fully hermetic 24kg 1.2HP cylinder capacity 25.95cm <sup>3</sup> CSR H 282mmWW 1588W 1987W 2451W 2971W 3536W 4132W test method EN 12900 4742W |                 |           |



1

|                    |  |                 |           |
|--------------------|--|-----------------|-----------|
| <b>Part No.</b>    | 605070   | <b>Ref. No.</b> | 880224900 |
| <b>description</b> | compressor coolant R404a type CAJ9513Z 220-240V 50Hz HMBP fully hermetic 23kg 1.1HP cylinder capacity 24.2cm <sup>3</sup> CSR H 282mmW 930W 1269W 1654W 2086W 2568W 3096W 3671W test method EN 12900 4278W |                 |           |

**SECOP DANFOSS**  
R404a/R507  
HMBP monophase

High/Medium evaporation temperature above -20/-15 °C



1

|                        |  |                 |         |
|------------------------|--|-----------------|---------|
| <b>Part No.</b>        | 605146   | <b>Ref. No.</b> | 8802143 |
| <b>description</b>     | compressor coolant R404a/R507 type SC15MLX 220-240V 50Hz HMBP fully hermetic 14kg 3/4HP cylinder capacity 15.28cm <sup>3</sup> CSIR H 219mmW 758W 951W 1183W 1458W 1780W 2155WW test method ASHRAE |                 |         |
| <b>spare parts for</b> | 605146   |                 |         |
|                        | <b>Part No.</b>  | <b>Ref. No.</b> | —       |
|                        | start relay DANFOSS  |                 |         |

evaporation and condensing trays

condensing trays heated

producer-specific



1

|                        |  |                 |           |
|------------------------|--|-----------------|-----------|
| <b>Part No.</b>        | 750005   | <b>Ref. No.</b> | 222312100 |
| <b>description</b>     | condensing tray heated L 240mm W 240mm H 250mm   |                 |           |
| <b>For models:</b>     | 927100100, 927102100   |                 |           |
| <b>spare parts for</b> | 750005   |                 |           |
|                        | <b>Part No.</b>  | <b>Ref. No.</b> | 877107800 |
|                        | heating element 650W 230V L 280mm W 95mm H 87mm L1 65mm L2 215mm cable length 1500mm connection distance 86mm tube ø 8.5mm heating circuits 1 immersion heater |                 |           |



1

|                        |  |                 |           |
|------------------------|--|-----------------|-----------|
| <b>Part No.</b>        | 750003   | <b>Ref. No.</b> | 226303600 |
| <b>description</b>     | condensing tray heated L 240mm W 240mm H 75mm 230V 650W connect with power contactor   |                 |           |
| <b>For models:</b>     | 927200200, 927300200, 927300300  |                 |           |
| <b>spare parts for</b> | 750003   |                 |           |
|                        | <b>Part No.</b>  | <b>Ref. No.</b> | —         |
|                        | float switch 250V 1A 1NO or 1NC thread M16x1.5 ø 17.4mm L 100.5mm mounting ø 28mm cable cable length 1500mm temp.-resist. -20 up to +90°C                      |                 |           |
|                        | <b>Part No.</b>  | <b>Ref. No.</b> | 877107800 |
|                        | heating element 650W 230V L 280mm W 95mm H 87mm L1 65mm L2 215mm cable length 1500mm connection distance 86mm tube ø 8.5mm heating circuits 1 immersion heater |                 |           |
| <b>accessories for</b> | 750003   |                 |           |
|                        | <b>Part No.</b>  | <b>Ref. No.</b> | 880302100 |
|                        | power relays Italiana Relè 230VAC 30A 1NO connection F6.3 bracket mounting dimensions 36.5x32.2x51.8mm manuf. no. A10-230AC-FA                                 |                 |           |





1

|                    |  |                 |           |
|--------------------|--|-----------------|-----------|
| <b>Part No.</b>    | 750006   | <b>Ref. No.</b> | 222312200 |
| <b>description</b> | condensing tray heated L 380mm W 240mm H 250mm                   |                 |           |
| <b>For models:</b> | 927100200, 927100300, 927100400, 927102200, 927102300, 927102400 |                 |           |



1

|   |   |                 |           |
|---|---|-----------------|-----------|
| <b>Part No.</b>   | 750004  | <b>Ref. No.</b> | 227206000 |
| <b>description</b>  | condensing tray heated L 380mm W 240mm H 75mm 230V 750W with float switch   |                 |           |
| <b>For models:</b>  | 927200300   |                 |           |
| <b>spare parts for</b>  | 750004  |                 |           |
|   | <b>Part No.</b>   | <b>Ref. No.</b> | —         |
|  | 348139  |                 |           |
|   | float switch 250V 1A 1NO or 1NC thread M16x1.5 ø 17.4mm L 100.5mm mounting ø 28mm cable length 1500mm temp.-resist. -20 up to +90°C   |                 |           |
|   | <b>Part No.</b>   | <b>Ref. No.</b> | 877107900 |
|  | 418733  |                 |           |
|   | heating element 750W 230V L 430mm W 95mm H 98mm L1 85mm L2 345mm cable length 1500mm connection cable connection distance 86mm tube ø 8.5mm heating circuits 1 immersion heater |                 |           |
| <b>accessories for</b>  | 750004  |                 |           |
|   | <b>Part No.</b>   | <b>Ref. No.</b> | 880302100 |
|  | 380185  |                 |           |
|   | power relays Italiana Relè 230VAC 30A 1NO connection F6.3 bracket mounting dimensions 36.5x32.2x51.8mm manuf. no. A10-230AC-FA  |                 |           |

## universal



1

|                    |  |                 |           |
|--------------------|--|-----------------|-----------|
| <b>Part No.</b>    | 750007   | <b>Ref. No.</b> | 224011500 |
| <b>description</b> | condensing tray heated L 300mm W 155mm H 105mm 230V 300W without level electrode |                 |           |

## fans

## axial fans

## ebm-papst





1

|                    |   |                 |           |
|--------------------|---|-----------------|-----------|
| <b>Part No.</b>    | 601482 <sup>1</sup>   | <b>Ref. No.</b> | 880102000 |
| <b>description</b> | axial fan L 119mm W 119mm H 38mm 230VAC 50/60Hz 13W bearing slide bearing manuf. no. 4580ZW connection cable 310mm ebm-papst temp.-resist. 65°C                     |                 |           |
| <b>For models:</b> | 925701100, 925701200, 925701300, 925701400, 925701500, 925701600, 925702100, 925702200, 925702300, 925702400, 925702500, 925702600, 927300100, 927300200, 927300300 |                 |           |

<sup>1</sup>with ball bearings

1

|   |  |                 |           |
|---|--|-----------------|-----------|
| <b>Part No.</b>   | 601089 <sup>1</sup>  | <b>Ref. No.</b> | 880101400 |
| <b>description</b>  | axial fan L 119mm W 119mm H 38mm 230VAC 50/60Hz 19W bearing slide bearing manuf. no. 4650N metal connection male faston 2.8mm ebm-papst fan wheel ø 110mm temp.-resist. 55°C |                 |           |
| <b>For models:</b>  | 927100100, 927100300, 927102100, 927102300, 927200300  |                 |           |
| <b>accessories for</b>  | 601089   |                 |           |
|   | <b>Part No.</b>  | <b>Ref. No.</b> | —         |
|  | 550898   |                 |           |
|   | connecting cable cable length 2000mm connection F 2.8 connection distance 7.9mm for axial flow fan   |                 |           |
|   | <b>Part No.</b>  | <b>Ref. No.</b> | —         |
|  | 691104   |                 |           |
|   | guard ø 115mm mounting distance 105mm for axial fan 119mm  |                 |           |

<sup>1</sup>with slide bearings



1

|                    |  |                 |           |
|--------------------|--|-----------------|-----------|
| <b>Part No.</b>    | 601481 <sup>1</sup>  | <b>Ref. No.</b> | 880103500 |
| <b>description</b> | axial fan L 127mm W 127mm H 38mm 230VAC 50/60Hz 18W bearing slide bearing manuf. no. 5950W metal connection male faston 2.8mm ebm-papst fan wheel ø 120mm temp.-resist. 75°C |                 |           |
| <b>For models:</b> | 927100200, 927100400, 927102200, 927102400   |                 |           |

<sup>1</sup>with slide bearings



1

|   |  |                 |                        |
|---|--|-----------------|------------------------|
| <b>Part No.</b>   | 601038 <sup>1</sup>  | <b>Ref. No.</b> | 880100800<br>880101300 |
| <b>description</b>  | axial fan L 80mm W 80mm H 38mm 230VAC 50/60Hz 12W bearing ball bearing manuf. no. 8556N metal connection cable 300mm ebm-papst fan wheel ø 75mm temp.-resist. 90°C airflow 50m <sup>3</sup> /h |                 |                        |
| <b>For models:</b>  | 925600100, 925600200, 925600300, 925601200, 925601300, 925601400, 925603300, 925603400, 925603500  |                 |                        |
| <b>accessories for</b>  | 601038   |                 |                        |
|  | <b>Part No.</b>  | 691102          | <b>Ref. No.</b> —      |
|   | guard ø 75mm mounting distance 71mm for axial fan 80mm   |                 |                        |

<sup>1</sup>with ball bearings

refrigeration fans

refrigeration motors universal

ELCO

N series - multi fit



1

|   |   |                 |                   |
|---|---|-----------------|-------------------|
| <b>Part No.</b>   | 601427  | <b>Ref. No.</b> | 880100300         |
| <b>description</b>  | fan motor ELCO 10W 230V 50/60Hz bearing slide bearing L1 49mm L2 59mm L3 86.5mm W 83mm connection cable 500mm 1300/1550rpm 5 mounting options VNT10-20/028  |                 |                   |
| <b>For models:</b>  | 925600100, 925600200, 925600300, 925601200, 925601300, 925601400, 925603300, 925603400, 925603500, 925701100, 925701200, 925701300, 925701400, 925701500, 925701600, 925702100, 925702200, 925702300, 925702400, 925702500, 925702600, 927100100, 927100200, 927100300, 927100400, 927102100, 927102200, 927102300, 927102400, 927200300, 927300100, 927300200, 927300300 |                 |                   |
| <b>spare parts for</b>  | 601427  |                 |                   |
|   | <b>Part No.</b>   | 560140          | <b>Ref. No.</b> — |
|   | hexagonal nut thread M4 H 4.8mm SS WS 7 Qty 20 pcs DIN/ISO DIN 985 self-locking   |                 |                   |
|  | <b>Part No.</b>   | 560332          | <b>Ref. No.</b> — |
|   | plain washer ID ø 4.3mm ED ø 9mm thickness 0.8mm SS Qty 1 pcs   |                 |                   |
|  | <b>Part No.</b>   | 560340          | <b>Ref. No.</b> — |
|   | hexagonal nut thread M4 H 3.2mm WS 7 SS DIN/ISO DIN 934 / ISO 4032/8673 Qty 1 pcs   |                 |                   |

electronic components

miscellaneous



1

|                    |  |                 |         |
|--------------------|--|-----------------|---------|
| <b>Part No.</b>    | 403602   | <b>Ref. No.</b> | 8803200 |
| <b>description</b> | delayer starting relay suitable for MAFIROL L 70mm W 54mm H 54mm 230V input current 20A 50Hz |                 |         |



## equipment-specific units

## for refrigerated counters

## spare parts and accessories



1

|                    |   |                 |                        |
|--------------------|---|-----------------|------------------------|
| <b>Part No.</b>    | 691499  | <b>Ref. No.</b> | 876032300<br>879008600 |
| <b>description</b> | bush eccentric for glass plate  |                 |                        |
| <b>For models:</b> | 925600100, 925600200, 925600300, 925701100, 925701200, 925701300, 925701400, 925701500, 925701600, 925702100, 925702200, 925702300, 925702400, 925702500, 925702600 |                 |                        |



1

|                    |  |                 |           |
|--------------------|--|-----------------|-----------|
| <b>Part No.</b>    | 691498   | <b>Ref. No.</b> | 870730700 |
| <b>description</b> | bush for glass plate $\varnothing$ 7.5mm   |                 |           |
| <b>For models:</b> | 925600100, 925600200, 925600300, 925601200, 925601300, 925601400, 925603300, 925603400, 925603500, 925701100, 925701200, 925701300, 925701400, 925701500, 925701600, 925702100, 925702200, 925702300, 925702400, 925702500, 925702600, 926002000, 926002500, 926002600, 926003000, 926003100, 926006900, 926007000, 926007500, 926007600, 926008100, 926008200 |                 |           |



1

|                    |   |                 |                        |
|--------------------|---|-----------------|------------------------|
| <b>Part No.</b>    | 691497  | <b>Ref. No.</b> | 879002300<br>890004800 |
| <b>description</b> | fastening angle for glass plate   |                 |                        |
| <b>For models:</b> | 925600100, 925600200, 925600300, 925601200, 925601300, 925601400, 925603300, 925603400, 925603500, 925701100, 925701200, 925701300, 925701400, 925701500, 925701600, 925702100, 925702200, 925702300, 925702400, 925702500, 925702600 |                 |                        |



1

|                    |   |                 |                        |
|--------------------|---|-----------------|------------------------|
| <b>Part No.</b>    | 691493  | <b>Ref. No.</b> | 879002200<br>890004700 |
| <b>description</b> | suction cup for glass plate   |                 |                        |
| <b>For models:</b> | 925600100, 925600200, 925600300, 925601200, 925601300, 925601400, 925603300, 925603400, 925603500, 925701100, 925701200, 925701300, 925701400, 925701500, 925701600, 925702100, 925702200, 925702300, 925702400, 925702500, 925702600 |                 |                        |

## for display coolers

## housing and bezels

## miscellaneous



1

|                    |  |                 |           |
|--------------------|--|-----------------|-----------|
| <b>Part No.</b>    | 692309                                   | <b>Ref. No.</b> | 222357700 |
| <b>description</b> | curtain for display refrigerator W 590mm |                 |           |
| <b>For models:</b> | 927200100                                |                 |           |

## glass panels

## glass panels

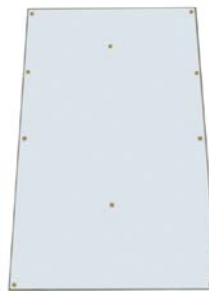

1

|                    |  |                 |           |
|--------------------|--|-----------------|-----------|
| <b>Part No.</b>    | 691501                                     | <b>Ref. No.</b> | 875036200 |
| <b>description</b> | glass panel L 1419mm W 602mm thickness 6mm |                 |           |
| <b>For models:</b> | 925600300                                  |                 |           |



1

|                    |   |                 |           |
|--------------------|---|-----------------|-----------|
| <b>Part No.</b>    | 691500                                    | <b>Ref. No.</b> | 875036000 |
| <b>description</b> | glass panel L 959mm W 602mm thickness 6mm |                 |           |
| <b>For models:</b> | 925600100                                 |                 |           |



1

|                    |                                   |                 |           |
|--------------------|-----------------------------------|-----------------|-----------|
| <b>Part No.</b>    | 691502                            | <b>Ref. No.</b> | 875059400 |
| <b>description</b> | glass panel mounting pos. lateral |                 |           |
| <b>For models:</b> | 925600100, 925600200, 925600300   |                 |           |





doors



1

|                    |   |                 |                      |
|--------------------|---|-----------------|----------------------|
| <b>Part No.</b>    | 691480  | <b>Ref. No.</b> | 8754405<br>875440500 |
| <b>description</b> | door W 545mm H 335mm with gasket  |                 |                      |
| <b>For models:</b> | 925600100, 925600200, 925600300, 925601200, 925601300, 925601400, 925603300, 925603400, 925603500, 925701100, 925701200, 925701300, 925701400, 925701500, 925701600, 925702100, 925702200, 925702300, 925702400, 925702500, 925702600 |                 |                      |

hinges

accessories

shafts



1

|                    |                        |                 |           |
|--------------------|------------------------|-----------------|-----------|
| <b>Part No.</b>    | 693137                 | <b>Ref. No.</b> | 886079700 |
| <b>description</b> | hinge pin ø 6mm L 18mm |                 |           |

bearings



1

|                    |            |                 |           |
|--------------------|------------|-----------------|-----------|
| <b>Part No.</b>    | 693136     | <b>Ref. No.</b> | 870290600 |
| <b>description</b> | hinge camp |                 |           |

gaskets

refrigeration gaskets

plug-in gaskets

profile 9153

We offer custom-made gaskets for this profile

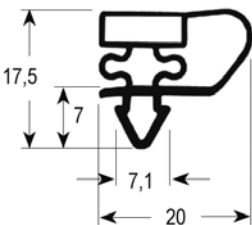

1

|                    |   |                 |           |
|--------------------|---|-----------------|-----------|
| <b>Part No.</b>    | 900940  | <b>Ref. No.</b> | 879007200 |
| <b>description</b> | refrigeration gasket profile 9153 W 345mm L 473mm plug size |                 |           |

refrigeration cycle components

filter driers

miscellaneous



1

|                    |   |                 |           |
|--------------------|---|-----------------|-----------|
| <b>Part No.</b>    | 750254  | <b>Ref. No.</b> | 880409800 |
| <b>description</b> | dryer size 20g ø 19mm L 138mm connection 2,5/6,2mm  |                 |           |
| <b>For models:</b> | 925600100, 925600200, 925600300, 925601200, 925601300, 925601400, 925603300, 925603400, 925603500, 925701100, 925701200, 925701300, 925701400, 925702100, 925702200, 925702300, 925702400 |                 |           |



1

|                    |  |                 |                      |
|--------------------|--|-----------------|----------------------|
| <b>Part No.</b>    | 750255   | <b>Ref. No.</b> | 8804099<br>880410000 |
| <b>description</b> | dryer size 40g ø 24mm L 170mm connection 6,6/6,6mm   |                 |                      |
| <b>For models:</b> | 925701500, 925701600, 925702500, 925702600, 927100100, 927100200, 927100300, 927100400, 927102100, 927102200, 927102300, 927102400 |                 |                      |

fastening material

screws

sheet metal screws



1

|                    |  |                 |           |
|--------------------|--|-----------------|-----------|
| <b>Part No.</b>    | 560104   | <b>Ref. No.</b> | 886015000 |
| <b>description</b> | sheet metal screws ø 3.9mm L 19mm SS Qty 20 pcs DIN 7981/ISO 7049 head ø 7.5mm oval head                     |                 |           |
| <b>For models:</b> | 926002500, 926002600, 926003000, 926003100, 926006900, 926007000, 926007500, 926007600, 926008100, 926008200 |                 |           |



## side bolts



1

|                    |  |                 |           |
|--------------------|--|-----------------|-----------|
| <b>Part No.</b>    | 560052   | <b>Ref. No.</b> | 886012700 |
| <b>description</b> | side bolts thread M5 L 10mm SS Qty 20 pcs intake slotted head ø 12.5mm   |                 |           |
| <b>For models:</b> | 925701100, 925701200, 925701300, 925701400, 925701500, 925701600, 925702100, 925702200, 925702300, 925702400, 925702500, 925702600 |                 |           |



1

|                    |  |                 |           |
|--------------------|--|-----------------|-----------|
| <b>Part No.</b>    | 560053   | <b>Ref. No.</b> | 886012800 |
| <b>description</b> | side bolts thread M5 L 16mm SS Qty 20 pcs intake slotted head ø 12.5mm   |                 |           |
| <b>For models:</b> | 925600100, 925600200, 925600300, 925701100, 925701200, 925701300, 925701400, 925701500, 925701600, 925702100, 925702200, 925702300, 925702400, 925702500, 925702600, 926002000, 926002500, 926002600, 926003000, 926003100, 926006900, 926007000, 926007500, 926007600, 926008100, 926008200, 927100100, 927100200, 927100300, 927100400, 927102100, 927102200, 927102300, 927102400 |                 |           |



1

|                    |   |                 |           |
|--------------------|---|-----------------|-----------|
| <b>Part No.</b>    | 560345  | <b>Ref. No.</b> | 886012400 |
| <b>description</b> | side bolts thread M5 L 22mm SS Qty 1 pcs head ø 12mm  |                 |           |
| <b>For models:</b> | 925600100, 925600200, 925600300, 925601200, 925601300, 925601400, 925603300, 925603400, 925603500 |                 |           |

## nuts

## hexagonal nuts

DIN 934 / ISO 4032/8673



1

|                    |  |                 |           |
|--------------------|--|-----------------|-----------|
| <b>Part No.</b>    | 560132   | <b>Ref. No.</b> | 886003500 |
| <b>description</b> | hexagonal nut thread M5 H 4mm WS 8 SS DIN/ISO DIN 934 / ISO 4032/8673 Qty 20 pcs   |                 |           |
| <b>For models:</b> | 925600100, 925600200, 925600300, 925601200, 925601300, 925601400, 925603300, 925603400, 925603500, 925701100, 925701200, 925701300, 925701400, 925701500, 925701600, 925702100, 925702200, 925702300, 925702400, 925702500, 925702600, 926002000, 926002500, 926002600, 926003000, 926003100 |                 |           |

## consumables

## containers

## canister



1

|                    |   |                 |                        |
|--------------------|---|-----------------|------------------------|
| <b>Part No.</b>    | 890246  | <b>Ref. No.</b> | 876900100<br>879013900 |
| <b>description</b> | canister 5l L 180mm W 180mm H 200mm   |                 |                        |
| <b>For models:</b> | 925600100, 925600200, 925600300, 925601200, 925601300, 925601400, 925603300, 925603400, 925603500, 925701100, 925701200, 925701300, 925701400, 925701500, 925701600, 925702100, 925702200, 925702300, 925702400, 925702500, 925702600 |                 |                        |

**GASTRO**PARTS.COM

