



GASTROPARTS

Macfrin

- [EN]** Equipment
- [DE]** Geräte
- [ES]** Aparatos
- [FR]** Équipement
- [IT]** Attrezzature
- [PL]** Urządzenia
- [RU]** Оборудование

✉ gastroparts@gastroparts.com

☎ tel. +48 56 657 00 66

📘 fb.com/gastroparts.global

GASTROPARTS.COM





heating elements

heating elements for ovens

1			
Part No.	419068	Ref. No.	2127
description	heating element 2400W 230V heating circuits 3 L 505mm W 355mm L1 55mm L2 450mm W1 114mm W2 127mm flange length 170mm flange width 45mm hole distance 138mm bridge length 368mm hole ø 12/7mm tube ø 8mm connection M4 connection length 30mm windings 4 rectangular flange dry heating element oven		
For models:	3310, 4902		

1			
Part No.	419069	Ref. No.	2131
description	heating element 4000W 230V heating circuits 3 L 505mm W 510mm L1 55mm L2 450mm W1 191.5mm W2 127mm flange length 170mm flange width 45mm hole distance 138mm bridge length 520mm hole ø 12/7mm tube ø 8mm connection M4 connection length 30mm windings 6 rectangular flange dry heating element oven		
For models:	3481		

heating elements for fryers

2 hole fixing

group 2

1			
Part No.	419070	Ref. No.	2180
description	heating element 2200W 230V heating circuits 1 L 300mm W 110mm H 170mm L1 35mm L2 15mm L3 250mm thread M12x1.25 mounting distance 102mm tube ø 8mm windings 3 2 hole fixing connection M4 connection length 35mm fryer cover		
For models:	4205, 4255		

group 5

1			
Part No.	419067	Ref. No.	65720019
description	heating element 3000W 220V heating circuits 1 L 300mm W 205mm H 180mm 2 hole fixing connection M4 fryer heaters L1 35mm L2 15mm L3 250mm W1 42.5mm W2 120mm tube ø 8.5mm thread M12x1 mounting distance 112mm connection length 38mm windings 5		
For models:	4208, 4224, 4255, 4288		

heating elements for griddles

1			
Part No.	419077	Ref. No.	2179
description	heating element 1000W 230V heating circuits 1 L 265mm W 180mm H 25mm tube ø 6.2mm W1 55mm W2 70mm connection M5 grill connection distance 65mm dry heating element		
For models:	4401, 4402E, 4403E, 4404E, 4405E, 4442E, 4443E, 4444E, 4445E, 4462		

heating elements for heated cabinets

1			
Part No.	418860	Ref. No.	910950017
description	heating element 800W 230V heating circuits 1 L 345mm W 90mm thread M12x1.5 mounting distance 83mm tube ø 6.5mm connection male faston 6.3mm dry heating element 2 hole fixing		

ceramic heaters

245x60mm

1			
Part No.	415102	Ref. No.	2088
description	ceramic emitter 400W 230V cable beaded cord L 245mm W 60mm H 35mm		
For models:	3018, 4421		
spare parts for	415102		
	Part No.	415109	Ref. No.
			—
	spring clip		

Table continues overleaf



accessories for	415102		
	Part No.	415110	Ref. No.
			—
	reflector L 245mm W 95mm H 31mm thickness 0.75mm hole ø 15x40mm		

coil heating elements

1 			
Part No.	419071	Ref. No.	2264
description	heating element 1000W 230V L 370mm W 50mm H 25mm tube ø 8mm thread M12x1.25 connection M4 connection length 30mm dry heating element heating circuits 1 2 hole fixing		
For models:	3018, 6190, 6190E1		

radiation heaters

1 			
Part No.	419076	Ref. No.	97032038
description	heating element rectangular L 840mm W 190mm 2500W 230/400V H 40mm cable length 450mm chicken rotisserie		
For models:	5305, 53054, 5310, 53104, 5315, 53154, 5320, 53204, 5330, 53304, 5340, 53404, 5360, 53604, 5380, 53804		

foil heating elements

1 			
Part No.	419075	Ref. No.	200800 C5421210
description	foil heating element L 400mm W 290mm 1000W 230V t.max. 150°C silicone cable length 2000mm thickness 1mm bain marie		
For models:	3016, 3701, 3701S, 3702, 3702S, 3703, 3703S, 3704, 3704S, 505		

accessories

capillary tube clips

1 			
Part No.	550138	Ref. No.	68560069
description	capillary tube clip for pipe ø 8.5mm for circular tube heating elements		
For models:	30172, 30252, 4205, 4208, 4212, 4224, 4255, 4288		

spring clips

1 			
Part No.	551078	Ref. No.	69340099
description	probe spring for pipe ø 8mm for probe ø 5mm L 30mm W 10mm wire gauge ø 1mm		
For models:	30172, 30252, 4205, 4208, 4212, 4224, 4255, 4288		



hot plates

round

with radiused edge

for domestic and commercial kitchens

1 			
Part No.	490018	Ref. No.	3216
description	hot plate ø 220mm 2000W 230V connection 4 screw clamps with 8mm spill ring		
For models:	3031, 3310, 4418, 4419, 4481, 4482, 4483		

1 			
Part No.	490020	Ref. No.	3235
description	hot plate ø 220mm 2600W 230V connection 4 screw clamps with 8mm spill ring		
For models:	3031, 3310		
accessories for	490020		
	Part No.	550796	Ref. No.
			—
	fixing plate for hot plate ø220mm		

energy regulators

EGO

1-circuit

1 			
Part No.	380015	Ref. No.	C5322489
description	energy regulator 230V 13A single-circuit turn direction right shaft ø 6x4.6mm shaft L 23mm mounting thread M4 power release 6-100% no. 50.57021.010		
For models:	5305, 53054, 5310, 53104, 5315, 53154, 5320, 53204, 5330, 53304, 5340, 53404, 5355, 5360, 53604, 5375, 5380, 53804		



thermostats

control and safety thermostats

EGO

control thermostats

55.13_series



Part No.	375505	Ref. No.	2221
description	thermostat t.max. 320°C temperature range 50-320°C 1-pole 1NO 16A probe ø 3mm probe L 160mm capillary pipe 870mm capillary pipe isolatedmm gland nut shaft ø 6x4.6mm shaft L 23mm shaft position upper rotation 270°		
For models:	3007, 3009, 3011, 3310, 3481, 3483, 3615, 3626, 4402E, 4403E, 4404E, 4405E, 4442E, 4443E, 4444E, 4445E, 4902, 4904, 4908		

IMIT / TEMPOMATIC / ARTHERMO

control thermostats



Part No.	375939	Ref. No.	C5322059
description	thermostat t.max. 200°C temperature range 0-200°C 1-pole 1CO 16A probe ø 5mm probe L 98mm capillary pipe 1040mm capillary pipe isolatedmm gland nut shaft ø 6x4.6mm shaft L 20mm		
For models:	30172, 30252, 4205, 4208, 4212, 4224, 4255, 4288		

safety thermostats



Part No.	375941	Ref. No.	C5322209
description	safety thermostat switch-off temp. 238°C 1-pole 1NC 16A probe ø 5mm probe L 100mm capillary pipe 1050mm capillary pipe isolatedmm gland nut 250V		
For models:	30172, 30252, 4205, 4208, 4212, 4224, 4255, 4288		

various

control thermostats



Part No.	390750	Ref. No.	C5322609
description	thermostat t.max. 240°C 1-pole 1NO 10A shaft ø 6x4.6mm shaft position 20°		
For models:	4401, 4462		



Part No.	375940	Ref. No.	C5322579
description	thermostat temperature range 30-90°C 1-pole 1CO 16A probe ø 6mm probe L 108mm capillary pipe 1530mm shaft ø 6x4.6mm shaft L 12mm rotation 270° 400V		
For models:	3016, 3018, 3701, 3701S, 3702, 3702S, 3703, 3703S, 3704, 3704S, 4420, 4421		

safety thermostats



Part No.	390754	Ref. No.	92011140	
description	safety thermostat switch-off temp. 240°C 1-pole 0.5A probe ø 6mm probe L 79mm capillary pipe 860mm capillary pipe isolated 750mm probe thread M10x1 connection with cable cable length 600mm			
For models:	3026, 3027, 3027V			
spare parts for	390754			
	Part No.	375783	Ref. No.	—
	safety thermostat switch-off temp. 240°C 1-pole 0.5A probe ø 6mm probe L 77mm capillary pipe 860mm capillary pipe isolated 750mm gland nut M10x1 probe SS			



accessories

capillary tube clips



Part No.	550138	Ref. No.	68560069
description	capillary tube clip for pipe ø 8.5mm for circular tube heating elements		
For models:	30172, 30252, 4205, 4208, 4212, 4224, 4255, 4288		

switches and momentary switches

rocker/momentary rocker switches

ø20mm



Part No.	357074	Ref. No.	C5120729
description	rocker switch mounting measurements 20mm red 2NO 250V 10A I O connection male faston 4.8mm ambient temperature max. 85°C protection IP40		
For models:	1161, 3018, 3310, 3481, 3483, 4401, 4421, 4462, 4902, 4904, 4908, 5305, 53054, 5310, 53104, 5315, 53154, 5320, 53204, 5330, 53304, 5340, 53404, 5355, 5360, 53604, 5375, 5380, 53804, 704, 7050, 70501, 7052, 706, 7062, 731, 734, 743, 7460, 7464, 7500, 7502, 75021, 7530, 7535, 75351		

cam switches

4-position

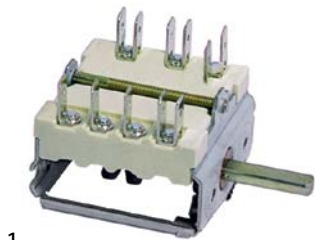

Part No.	300007	Ref. No.	3218
description	cam switch 4 operating positions 1NO/2CO sequence 0-1-2-3 16A shaft ø 6x4.6mm shaft L 23mm connection male faston 6.3mm 4-position ceramic		
For models:	3031, 33075, 3310, 3327, 3481, 3483, 4418, 4419, 4481, 4482, 4483, 54244, 54364, 54484		

lamps

indicator lights

indicator lights (complete)

ø 6mm



Part No.	357072	Ref. No.	C5120219
description	indicator light ø 6mm 220V red connection cable 300mm cable length 300mm metal		
For models:	3007, 3009, 3011, 3016, 30172, 3018, 30252, 3031, 3033, 33075, 3310, 33115, 3327, 3481, 3483, 3615, 3626, 3701, 3701S, 3702, 3702S, 3703, 3703S, 3704, 3704S, 4205, 4208, 4212, 4224, 4255, 4288, 4402E, 4403E, 4404E, 4405E, 4418, 4419, 4420, 4421, 4442E, 4443E, 4444E, 4445E, 4481, 4482, 4483, 4808, 4902, 4904, 4908...(Other models you can see in the webshop)		

ø20mm



Part No.	357073	Ref. No.	C5120719
description	indicator light ø 20mm 250V red connection male faston 4.8mm temp.-resist. 105°C		
For models:	704, 7050, 70501, 7052, 706, 7062, 731, 734, 743, 7460, 7464, 7500, 7502, 75021, 7530, 7535, 75351		

oven lamps

universal oven lamps

55x100mm



Part No.	101372	Ref. No.	C5125419
description	oven lamp complete L 100mm W 55mm 230V 25W socket E14 rectangular temp.-resist. 300°C connection male faston 6.3mm		
For models:	5301, 5305, 53054, 5310, 53104, 5315, 53154, 5320, 53204, 5330, 53304, 5336, 5340, 53404, 5348, 5355, 5360, 53604, 5372, 5375, 5380, 53804, 5396, 5424, 54244, 5436, 54364, 5448, 54484, 5453, 5496		

spare parts for 101372



Part No.	359612	Ref. No.	—
description	light bulb t.max. 300°C socket E14 25W 230V ø 25mm L 56mm lens L 30mm for oven lamp type Philips		



Part No.	359698	Ref. No.	—
description	lamp socket L 100mm W 55mm socket E14 connection male faston 6.3mm		



Part No.	359714	Ref. No.	—
description	gasket for bulb socket		



Part No.	359715	Ref. No.	—
description	lamp glass L 110mm W 65mm thickness 5mm		

Table continues overleaf



spare parts for	101372			
	Part No.	359716	Ref. No.	—
	frame for bulb socket			

contactors

LS Industrial Systems

power contactors



1

Part No.	380944	Ref. No.	C5123179
description	power contactor resistive load 20A 230VAC (AC3/400V) 12A/5.5kW main contacts 3NO auxiliary contacts 1NO/1NC connection screw connection type GMC-12		
For models:	30252, 3615, 3626, 4904, 4908		

electronic controllers

miscellaneous

refrigeration controllers



1

Part No.	378271	Ref. No.	C5322529
description	electronic controller OSAKA type T2001 AN /HSH5 mounting measurements 71x29mm 100-240V voltage AC NTC display 4 digits NTC/PTC		
For models:	1161, 505, 5453, 602, 6021, 6022, 603, 6031, 605, 606, 6190, 6190E1, 704, 7050, 70501, 7052, 706, 7062, 731, 734, 743, 7460, 7464, 7500, 7502, 75021, 7530, 7535, 75351		

motors

gear motors

for grills



1

Part No.	499110	Ref. No.	C5020039
description	gear motor CROUZET 230V 50Hz 4rpm shaft ø 6x5mm L 91mm W 64mm H 58mm		
For models:	5305, 53054, 5310, 5315, 5320, 5330, 5340, 5360, 5380		

	1		
Part No.	499111	Ref. No.	534027P
description	gear motor CEG type MM56A4-STD 90W 230V 50Hz 6500rpm L 705mm W 115mm H 550mm chicken rotisserie 0.12HP		
For models:	5310, 53104, 5315, 53154, 5330, 53304, 5340, 53404, 5355, 5360, 53604, 5375, 5380, 53804		

gas taps

PEL

20S series



1













Part No.	106840	Ref. No.	3780	
description	gas tap PEL type 20S gas inlet pipe flange ø21mm bypass nozzle ø 0mm gas outlet M16x1.5 (tube ø 10/8mm) thermocouple connection M8x1 pilot connection shaft ø 8x6.5mm shaft L 22/15mm shaft flat upper			
For models:	5305, 53054, 5310, 53104, 5315, 53154, 5320, 53204, 5330, 53304, 5340, 53404, 5355, 5360, 53604, 5375, 5380, 53804			
spare parts for	106840			
	Part No.	101060	Ref. No.	—
	magnet unit standard L 39mm D1 ø 15.4mm D2 ø 11mm suitable for PEL20-21/JUNKERS/EGA			
	Part No.	101205	Ref. No.	—
	gas tap front part shaft ø 8x6.5mm shaft L 22/15mm shaft flat upper/lower suitable for PEL20			
	Part No.	101880	Ref. No.	—
	gasket Viton ED ø 14mm ID ø 9mm thickness 7.7mm Qty 1 pcs			
	Part No.	106202	Ref. No.	—
	bypass nozzle type PEL20/21 bore ø 0mm thread M5x0.5			
accessories for	106840			
	Part No.	101230	Ref. No.	—
	thermocouple nut T1: M8x1 T2: M18x1 aluminium			
	Part No.	101278	Ref. No.	3781
	olive for pipe ø 10mm Qty 1 pcs			
	Part No.	101300	Ref. No.	3782
	union nut thread M16x1.5 tube ø 10mm			
	Part No.	101450	Ref. No.	—
	olive for pipe ø 8mm L 12.7mm Qty 1 pcs ED ø 10mm			
	Part No.	101451	Ref. No.	—
	union nut thread M16x1.5 tube ø 8mm			



21S series







1

Part No.	106841	Ref. No.	C5811429
description	gas tap PEL type 21S gas inlet pipe flange ø21mm bypass nozzle ø 0mm gas outlet M16x1.5 (tube ø 10mm) thermocouple connection M9x1 pilot connection M10x1 shaft ø 8x6.5mm shaft L 22/15mm shaft flat right pipe input ø 9mm		
For models:	3013, 3014, 3015, 3302, 3302S, 3303, 3303S, 3304, 3306, 3331, 3401, 3402, 3404S, 3405S, 3411S, 34121S, 3412S-Vers1, 3412S-Vers2, 3413SE1, 34151S, 3415S, 3501, 3501C, 3504, 3511SE1, 3592, 3911, 3912, 4001, 4437, 4701S, 4702, 4703, 4704, 4801, 4803, 4803E, 4805, 4807, 4811, 4815, 4920, 49201, 49202, 4930, 49301, 5051, 5052S		
spare parts for	106841		
	Part No.	101060	Ref. No. —
	magnet unit standard L 39mm D1 ø 15.4mm D2 ø 11mm suitable for PEL20-21/JUNKERS/EGA		
	Part No.	101231	Ref. No. —
	thermocouple nut T1: M9x1 T2: M18x1		
	Part No.	106202	Ref. No. —
	bypass nozzle type PEL20/21 bore ø 0mm thread M5x0.5		
accessories for	106841		
	Part No.	100908	Ref. No. —
	union screw thread M10x1 for pipe ø 4mm Qty 1 pcs		
	Part No.	100909	Ref. No. A1018997
	union screw thread M10x1 for pipe ø 6mm Qty 1 pcs		
	Part No.	101246	Ref. No. —
	olive for pipe ø 4mm Qty 1 pcs		
	Part No.	101278	Ref. No. 3781
	olive for pipe ø 10mm Qty 1 pcs		
	Part No.	101286	Ref. No. —
	olive ID ø 6mm Qty 1 pcs		
	Part No.	101300	Ref. No. 3782
	union nut thread M16x1.5 tube ø 10mm		
	Part No.	101450	Ref. No. —
	olive for pipe ø 8mm L 12.7mm Qty 1 pcs ED ø 10mm		
	Part No.	101451	Ref. No. —
	union nut thread M16x1.5 tube ø 8mm		
	Part No.	110081	Ref. No. —
	knob ø 70mm shaft ø 8x6.5mm shaft flat universal		
	Part No.	112206	Ref. No. —
	knob dial plate silver gas tap PEL21/22/23 t.max.°C ED ø 63mm ID ø 45.5mm		

SABAF



1

Part No.	106842	Ref. No.	C5816299
description	gas tap SABAF type 10 gas inlet pipe flange ø23mm bypass nozzle ø 0mm gas outlet 1/4" (tube ø 8mm) front fixing M13x1 thermocouple connection M8x1 shaft ø 8x6.5mm shaft L 32/12.5mm shaft flat right		
For models:	3300, 35012, 4402, 4402M, 4403, 4403M, 4404, 4404M, 4405, 4405M, 4409, 4410, 4411, 4412, 4413, 4413M, 4416, 4417, 4422, 4423, 4424, 4425, 4442, 4443, 4444, 4445, 4462, 4471, 4472, 4473, 5315, 5320, 5330, 5336, 5340, 5348, 5355, 5372, 5375, 5396, 5424, 5436, 5448, 5448A, 5496		
spare parts for	106842		
	Part No.	101051	Ref. No. —
	magnet unit L 27mm D1 ø 12.5mm D2 ø 8.5mm suitable for JUNKERS/EGA/MADEC/SABAF standard		
	Part No.	101376	Ref. No. —
	gasket ID ø 8mm ED ø 12mm H 3/5mm		
accessories for	106842		
	Part No.	101277	Ref. No. C5815549
	olive ID ø 8mm Qty 1 pcs		
	Part No.	101751	Ref. No. —
	bracket		
	Part No.	520656	Ref. No. —
	union nut thread 1/4" tube ø 6/8mm		



1





Part No.	106843	Ref. No.	C5816289
description	gas tap SABAF type 10 gas inlet pipe flange ø23mm bypass nozzle ø 0mm gas outlet 1/4" (tube ø 8mm) front fixing thermocouple connection M8x1 shaft ø 8x6.5mm shaft L 47/12.5mm shaft flat right		
For models:	30012, 30032, 30132, 30142, 30152, 3300, 3301, 33022, 33042, 33052, 33062, 33092, 35012		
spare parts for	106843		
	Part No.	101051	Ref. No. —
	magnet unit L 27mm D1 ø 12.5mm D2 ø 8.5mm suitable for JUNKERS/EGA/MADEC/SABAF standard		
	Part No.	101376	Ref. No. —
	gasket ID ø 8mm ED ø 12mm H 3/5mm		
accessories for	106843		
	Part No.	101277	Ref. No. C5815549
	olive ID ø 8mm Qty 1 pcs		
	Part No.	101751	Ref. No. —
	bracket		

Table continues overleaf



accessories for	106843			
	Part No.	520656	Ref. No.	—
	union nut thread 1/4" tube ø 6/8mm			



gas thermostats



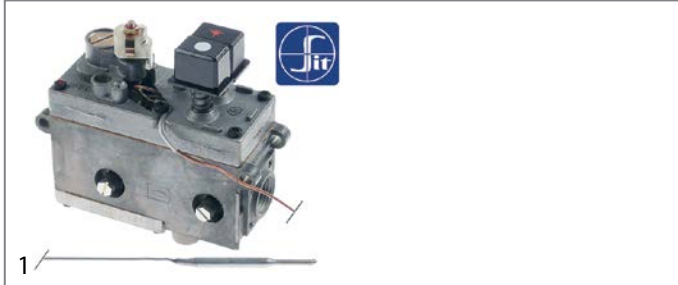





SIT

710 Minisit series



Part No.	101132	Ref. No.	3103
description	gas thermostat SIT type MINISIT 710 t.max. 340°C 100-340°C gas inlet 1/2" gas outlet 3/8" thermocouple connection M9x1 pilot connection M10x1 probe ø 5mm probe L 68mm capillary pipe 1050mm probe type type B1 pressure controller no pressure regulator mbar gland nut ignition gas no		
For models:	3001, 3003, 3005, 3401, 3402, 3501, 3592, 3607, 3611S, 3614S, 3624, 3628H, 3628S, 3683S, 3684S, 3907, 4001, 4812, 4812E, 4815, 4817, 4903, 4907, 4999		

accessories for	101132			
	Part No.	101053	Ref. No.	—
	magnet unit T1: M9x1 T2: M24x1 L 45mm ø 17mm suitable for Minisit			
	Part No.	102102	Ref. No.	—
	probe 100-340°C probe ø 5mm probe L 68mm capillary pipe 1750mm t.max. 340°C oven/grill probe type type B1 suitable for MINISIT 710			

accessories for	101132			
	Part No.	100809	Ref. No.	3785
	O-ring EPDM thickness 2mm ID ø 21mm Qty 1 pcs			
	Part No.	100904	Ref. No.	—
	locking screw M10x1 for pipe ø 4mm Qty 1 pcs			
	Part No.	100905	Ref. No.	C5815359
	locking screw M10x1 for pipe ø 6mm Qty 1 pcs			
	Part No.	101054	Ref. No.	—
	magnet unit T1: M10x1 T2: M24x1 L 45mm ø 17mm suitable for Minisit			
	Part No.	101136	Ref. No.	—
	piezoelectric igniter suitable for Minisit with cover cap ømm connection F6.3x0.8			
	Part No.	101137	Ref. No.	—
	cover cap without piezoelectric igniter			
	Part No.	101267	Ref. No.	—
	reducer IT 3/8" ET 1/2" L 21mm			
	Part No.	101268	Ref. No.	—
	gas connection thread 3/8" angled with O-ring MINISIT 710			
	Part No.	101269	Ref. No.	—
	gas connection thread 1/2" angled with O-ring MINISIT 710			

accessories for	101132			
	Part No.	101270	Ref. No.	—
	screw connection IT 3/8" ET 3/8" L 28mm			
	Part No.	101272	Ref. No.	—
	screw connection IT 1/2" ET 3/8" L 57mm			
	Part No.	101273	Ref. No.	—
	olive for pipe ø 12mm L 9.5mm brass Qty 1 pcs suitable for universal			
	Part No.	101274	Ref. No.	—
	olive for pipe ø 16mm Qty 1 pcs			
	Part No.	101275	Ref. No.	—
	union screw thread 1/2" for pipe ø 16mm Qty 1 pcs			
	Part No.	101276	Ref. No.	—
	union screw thread 3/8" tube ø 12mm Qty 1 pcs			
	Part No.	110068	Ref. No.	—
	knob suitable for Minisit ø 37mm			

gas valves and ignition boxes

gas control valves

SIT			
NOVASIT			
accessories			
	1		
Part No.	100905	Ref. No.	C5815359
description	locking screw M10x1 for pipe ø 6mm Qty 1 pcs		
For models:	3001, 3003, 3005, 3013, 3014, 3015, 3026, 3027, 3027V, 3302, 3302S, 3303, 3303S, 3304, 3306, 3331, 3401, 3402, 3404S, 3405S, 3411S, 3412S, 3412S-Vers1, 3412S-Vers2, 3413SE1, 3415S, 3415S, 3501, 3501C, 3504, 3511SE1, 3592, 3607, 3611S, 3614S, 3624, 3628H, 3628S, 3683S, 3684S, 3907, 3908, 3911, 3912, 4437, 4701S, 4702, 4703, 4704, 4801...(Other models you can see in the webshop)		



ignition parts

pilot burners

SIT

100 series

accessories

pilot burner brackets

universal



1

Part No.	100894	Ref. No.	3705
description	opposite support for pilot burner suitable for 100 series		
For models:	30012, 30032, 30132, 30142, 3300, 3301, 3302, 33022, 35012, 4409, 4410, 4901		



1

Part No.	100893	Ref. No.	3786
description	pilot burner bracket suitable for 100 series 2-piece		
For models:	30012, 30032, 30132, 30142, 3300, 3301, 3302, 33022, 35012, 4409, 4410, 4901		



1

Part No.	100888	Ref. No.	3704
description	screw bolt for pilot burner		
For models:	3300, 3301, 35012, 4409, 4410, 4901		

miscellaneous



1

Part No.	100885	Ref. No.	C5815189
description	air mixing sleeve for pilot burner Qty 1 pcs		
For models:	3015, 3302, 33025, 3303, 33035, 3304, 3306, 3331, 3401, 3402, 3404S, 3405S, 3411S, 34121S, 3412S-Vers1, 3412S-Vers2, 3413SE1, 34151S, 3415S, 3501, 3501C, 3504, 3511SE1, 3592, 4001, 4437, 4920, 49201, 49202, 4930, 49301, 5051, 5052S		

POLIDORO

pilot burners



1

Part No.	106837	Ref. No.	C5810129
description	pilot burner POLIDORO 3 flames natural gas code 27.2		
For models:	3001, 3003, 3005, 3013, 3014, 3026, 3027, 3027V, 3401, 3402, 3501, 3592, 3607, 3611S, 3614S, 3624, 3628H, 3628S, 3683S, 3684S, 3907, 3908, 3911, 3912, 4001, 4701S, 4702, 4703, 4704, 4801, 4803, 4803E, 4805, 4807, 4811, 4812, 4812E, 4815, 4817, 4903, 4907, 4999		







producer-specific pilot burners

MACFRIN



1

Part No.	107485	Ref. No.	C5815249M
description	pilot burner LPG code 20		
For models:	3015, 3302, 33025, 3303, 33035, 3304, 3306, 3331, 3401, 3402, 3404S, 3405S, 3411S, 34121S, 3412S-Vers1, 3412S-Vers2, 3413SE1, 34151S, 3415S, 3501, 3501C, 3511SE1, 4437, 4920, 49201, 49202, 4930, 49301, 5051, 5052S		

spare parts for	107485			
	Part No.	100245	Ref. No.	—
	pilot burner nozzle LPG code 20 bore ø 0.2mm Qty 1 pcs thread M8x0.75			
	Part No.	100885	Ref. No.	C5815189
	air mixing sleeve for pilot burner Qty 1 pcs			
	Part No.	100904	Ref. No.	—
	locking screw M10x1 for pipe ø 4mm Qty 1 pcs			
	Part No.	100905	Ref. No.	C5815359
	locking screw M10x1 for pipe ø 6mm Qty 1 pcs			
	Part No.	106844	Ref. No.	C5815249 C5815309
	pilot burner 1 flame			
	Part No.	106845	Ref. No.	C5815099
	pilot burner centre part ø 8mm			
	Part No.	107483	Ref. No.	C5815169
	pilot burner bottom part LPG code 20			
	Part No.	697942	Ref. No.	C5815279
	gasket for pilot burner ø 35.5mm thickness 1mm			



electrodes

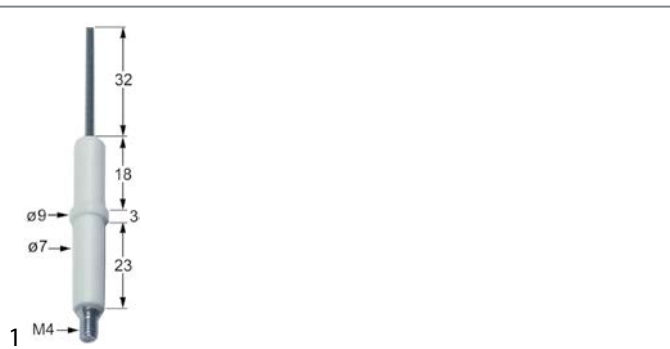

Part No.	100701	Ref. No.	C5810139
description	ignition electrode connection M4 Qty 1 pcs		
For models:	3001, 3003, 3005, 3013, 3014, 3026, 3027, 3027V, 3401, 3402, 3501, 3592, 3607, 3611S, 3614S, 3624, 3628H, 3628S, 3683S, 3684S, 3907, 3908, 3911, 3912, 4001, 4701S, 4702, 4703, 4704, 4801, 4803, 4803E, 4805, 4807, 4811, 4812, 4812E, 4815, 4817, 4903, 4907, 4999		
accessories for	100701		
		Part No.	100906 Ref. No. A1018998
	screw connection thread M10x1 for ignition electrode brass Qty 1 pcs WS 10		

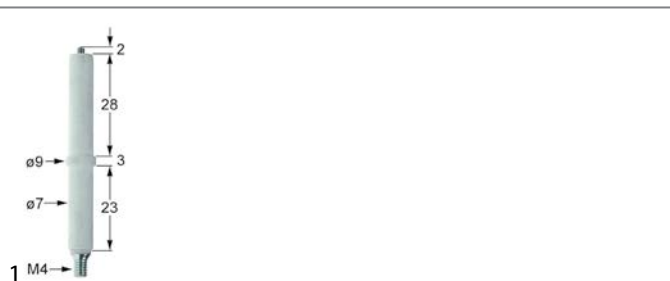

Part No.	102314	Ref. No.	96010061
description	ignition electrode D1 ø 7mm D2 ø 9mm connection M4 L1 2mm BL1 28mm BL2 3mm BL3 23mm to clip		
For models:	3911, 3912		



Part No.	100906	Ref. No.	A1018998
description	screw connection thread M10x1 for ignition electrode brass Qty 1 pcs WS 10		
For models:	3001, 3003, 3005, 3013, 3014, 3026, 3027, 3027V, 3401, 3402, 3501, 3592, 3607, 3611S, 3614S, 3624, 3628H, 3628S, 3683S, 3684S, 3907, 3911, 3912, 4001, 4701S, 4702, 4703, 4704, 4801, 4803, 4803E, 4805, 4807, 4811, 4812, 4812E, 4815, 4817, 4903, 4907, 4999		

ignition cables

pre-assembled cables

Part No.	102164	Ref. No.	2175
description	ignition cable cable length 1000mm connection F6.3mm / lug M4		
For models:	30012, 3003, 30032, 3005, 3013, 30132, 3014, 30142, 3300, 3301, 3302, 33022, 3401, 3402, 3501, 35012, 3592, 3611S, 3628H, 3628S, 3908, 3911, 3912, 4001, 4409, 4410, 4702, 4703, 4704, 4801, 4803, 4803E, 4805, 4807, 4811, 4815, 4901, 4903, 4907, 4999		

Part No.	102177	Ref. No.	2193
description	ignition cable cable length 600mm connection F6.3mm / lug M4		
For models:	3001, 3003, 3005, 3026, 3027, 3027V, 3607, 3611S, 3614S, 3624, 3683S, 3684S, 4701S, 4702, 4812, 4812E, 4815, 4817		

piezoelectric igniters

miscellaneous

Part No.	nla ¹	Ref. No.	3747
description	piezoelectric igniter suitable for Minisit connection F6.3x0.8 ømm		
For models:	3001, 3003, 3005, 3013, 3014, 3027, 3027V, 3300, 3301, 3401, 3402, 3501, 35012, 3592, 3611S, 3614S, 3624, 3628H, 3628S, 3683S, 3684S, 4001, 4409, 4410, 44138, 4702, 4803, 4812, 4815, 4817, 4999		

¹no longer available

thermocouples

plug-in thermocouples

plug-in thermocouples standard

with barrel socket ø6(6.5)mm

thermocouples SIT

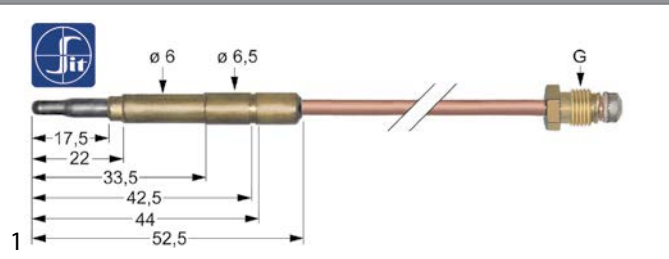



Part No.	107602	Ref. No.	C5811809
description	thermocouple SIT M8x1 L 850mm plug connection ø6.0(6.5)mm		
For models:	30012, 30032, 30132, 30142, 3300, 3301, 3302, 33022, 35012, 4409, 4410, 4901		
accessories for	107602		
		Part No.	100920 Ref. No. —
	thermocouple fitting thread M8x1 / M9x1 Qty 1 pcs		

Table continues overleaf



accessories for	107602		
	Part No.	100922	Ref. No.
			—
	thermocouple fitting thread M10x1 / ASA 11/32 Qty 1 pcs		

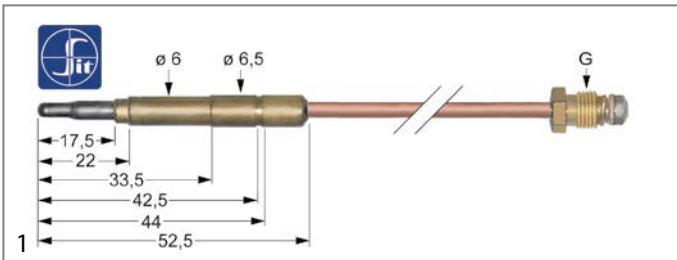

Part No.	107612	Ref. No.	C5811009
description	thermocouple SIT M9x1 L 1000mm plug connection ø6.0(6.5)mm		
For models:	4815		

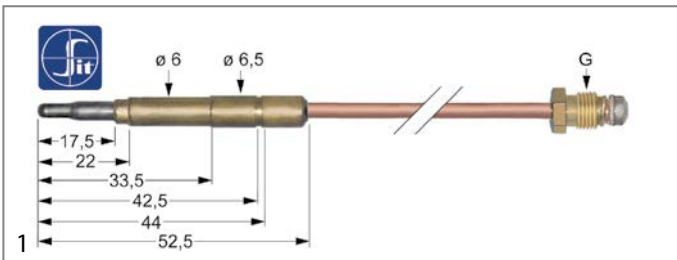

Part No.	107614	Ref. No.	C5811059
description	thermocouple SIT M9x1 L 1500mm plug connection ø6.0(6.5)mm		
For models:	3501, 4801, 4803, 4803E, 4805, 4807, 4811		

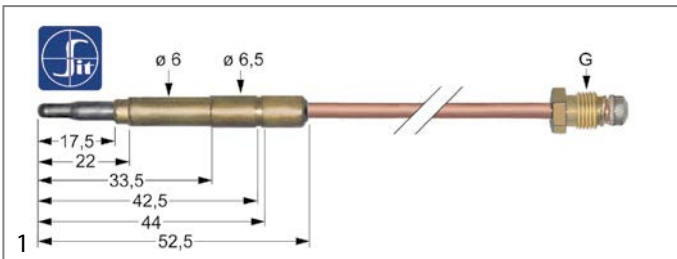

Part No.	107606	Ref. No.	C5820049
description	thermocouple SIT M9x1 L 320mm plug connection ø6.0(6.5)mm		
For models:	3001, 3003, 3005, 3026, 3027, 3027V, 3607, 3611S, 3614S, 3624, 3683S, 3684S, 4701S, 4702, 4812, 4812E, 4817, 5305, 5310, 5315, 5320, 5330, 5340, 5360, 5380		

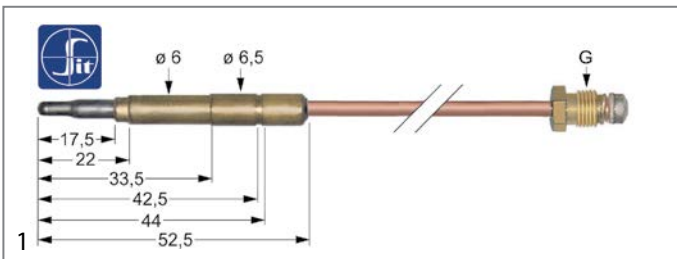

Part No.	107609	Ref. No.	C5811829
description	thermocouple SIT M9x1 L 600mm plug connection ø6.0(6.5)mm		
For models:	3003, 3005, 3013, 3014, 3027, 3027V, 3302, 33022, 3401, 3402, 3501, 3592, 3611S, 3628H, 3628S, 3911, 3912, 4001, 4702, 4703, 4704, 4803, 4815, 4901, 4999		

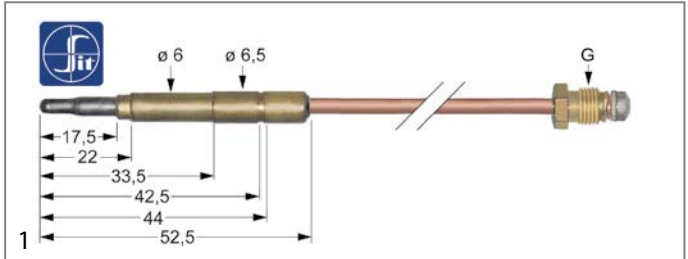

Part No.	107611	Ref. No.	C5811679
description	thermocouple SIT M9x1 L 850mm plug connection ø6.0(6.5)mm		
For models:	3401, 4903, 4907, 4999		

threaded thermocouples

threaded thermocouples standard

with socket with thread M8x1

SIT

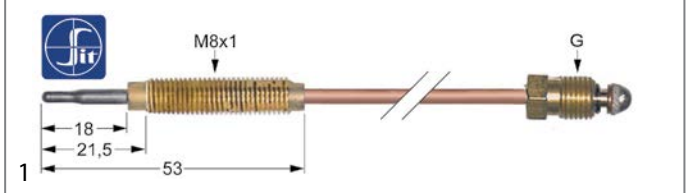

Part No.	107628	Ref. No.	C5811019
description	thermocouple SIT M8x1 L 320mm M8x1		
For models:	3015, 30152, 3300, 3301, 3302, 33022, 33025, 3303, 33035, 3304, 33042, 33052, 3306, 33062, 33092, 3401, 3402, 3404S, 3405S, 3501, 35012, 3501C, 4402, 4402M, 4403, 4403M, 4404, 4404M, 4405, 4405M, 4410, 4411, 4412, 4413, 44138, 4416, 4417, 4422, 4423, 4424, 4425, 4442, 4443, 4444, 4445, 4462, 4471, 4472, 4473		

accessories for	107628		
	Part No.	102067	Ref. No.
			C5811029
	nut thread M8x1 H 3mm brass Qty 1 pcs type SEF 1		

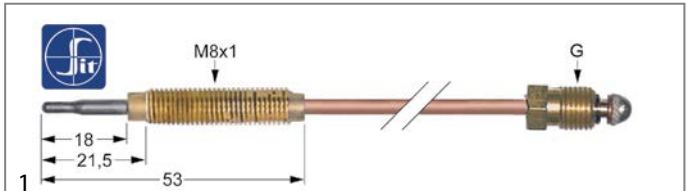

Part No.	107629	Ref. No.	C5811039
description	thermocouple SIT M8x1 L 450mm M8x1		
For models:	5305, 53054, 5310, 53104, 5315, 53154, 5320, 53204, 5330, 53304, 5340, 53404, 5355, 5360, 53604, 5375, 5380, 53804		

accessories for	107629		
	Part No.	102067	Ref. No.
			C5811029
	nut thread M8x1 H 3mm brass Qty 1 pcs type SEF 1		



Part No.	107638	Ref. No.	C5811049
description	thermocouple SIT M9x1 L 1000mm M8x1		
For models:	3401, 3501, 4001		

Part No.	107635	Ref. No.	C5811739	
description	thermocouple SIT M9x1 L 320mm M8x1			
For models:	3331, 4437, 4920, 49201, 49202			
accessories for	107635			
	Part No.	102067	Ref. No.	C5811029
	nut thread M8x1 H 3mm brass Qty 1 pcs type SEF 1			

Part No.	107636	Ref. No.	C5811849	
description	thermocouple SIT M9x1 L 600mm M8x1			
For models:	3411S, 34121S, 3412S-Vers1, 3412S-Vers2, 3413SE1, 34151S, 3415S, 3511SE1, 4930, 49301, 5052S			
accessories for	107636			
	Part No.	102067	Ref. No.	C5811029
	nut thread M8x1 H 3mm brass Qty 1 pcs type SEF 1			

type Junkers with aluminised tip

Part No.	102233	Ref. No.	C5811129	
description	thermocouple M8x1 L 750mm M8x1			
For models:	3401, 3402, 3404S, 3405S			
accessories for	102233			
	Part No.	102067	Ref. No.	C5811029
	nut thread M8x1 H 3mm brass Qty 1 pcs type SEF 1			

accessories

nuts

Part No.	102067	Ref. No.	C5811029
description	nut thread M8x1 H 3mm brass Qty 1 pcs type SEF 1		
For models:	30152, 3300, 3301, 33022, 33042, 33052, 33062, 33092, 35012, 4402, 4402M, 4403, 4403M, 4404, 4404M, 4405, 4405M, 4410, 4411, 4412, 4413, 44138, 4416, 4417, 4422, 4423, 4424, 4425, 4442, 4443, 4444, 4445, 4462, 4471, 4472, 4473, 5305, 53054, 5310, 53104, 5315, 53154, 5320, 53204, 5330, 53304, 5336, 5340, 53404, 5348...(Other models you can see in the webshop)		

gas burners

hob burners

universal hob burners

ARC

65 series

Part No.	104328	Ref. No.	C5815139
description	burner pipe 4.5kW L 93mm total length 108mm air mixer ø 18.2mm ED ø 32.9mm ID ø 22.7mm		
For models:	3015, 3302, 33025, 3303, 33035, 3304, 3306, 3401, 3402, 3404S, 3405S, 3501, 3501C, 3504, 3592, 4001		

SABAF



1 series

Part No.	104288	Ref. No.	C5815589	
description	burner cap 3.6kW ø 120mm			
For models:	30152, 33022, 33042, 33052, 33092, 35012, 4410, 4411, 4412, 4413, 44138, 4416, 4417			
accessories for	104288			
	Part No.	104289	Ref. No.	C5815609
	burner lower part 3/3.6kW for burner cap ø 90/120mm			
	Part No.	105086	Ref. No.	C5815579
	burner ring 3.6kW for burner cap ø 120mm			
	Part No.	105087	Ref. No.	C5815599
	burner head 3.6kW for burner cap ø 120mm			



			
1			
Part No.	105087	Ref. No.	C5815599
description	burner head 3.6kW for burner cap ø 120mm		
For models:	30152, 33022, 33042, 33052, 33092, 35012, 4410, 4411, 4412, 4413, 44138, 4416, 4417		
accessories for	105087		
	Part No.	104288	Ref. No. C5815589
	burner cap 3.6kW ø 120mm		
	Part No.	105085	Ref. No. —
	burner cap ø 120mm		
	Part No.	105086	Ref. No. C5815579
	burner ring 3.6kW for burner cap ø 120mm		
	Part No.	105088	Ref. No. —
	burner cap A ø 110mm with central hole		
	Part No.	105089	Ref. No. —
	burner ring 3kW for burner cap ø 90mm		

			
1			
Part No.	104289	Ref. No.	C5815609
description	burner lower part 3/3.6kW for burner cap ø 90/120mm		
For models:	30152, 33022, 33042, 33052, 33092, 35012, 4410, 4411, 4412, 4413, 44138, 4416, 4417		
accessories for	104289		
	Part No.	104286	Ref. No. —
	burner cap 3kW ø 90mm		
	Part No.	104288	Ref. No. C5815589
	burner cap 3.6kW ø 120mm		
	Part No.	105086	Ref. No. C5815579
	burner ring 3.6kW for burner cap ø 120mm		
	Part No.	105087	Ref. No. C5815599
	burner head 3.6kW for burner cap ø 120mm		
	Part No.	105089	Ref. No. —
	burner ring 3kW for burner cap ø 90mm		
	Part No.	105090	Ref. No. —
	burner head 3kW for burner cap ø 90mm		
	Part No.	106482	Ref. No. —
	gas injector thread M6x0.75 WS 7 bore ø 1.1mm		
	Part No.	106485	Ref. No. —
	gas injector thread M6x0.75 WS 7 bore ø 1.6mm		

			
1			
Part No.	105086	Ref. No.	C5815579
description	burner ring 3.6kW for burner cap ø 120mm		
For models:	30152, 33022, 33042, 33052, 33092, 35012, 4410, 4411, 4412, 4413, 44138, 4416, 4417		
accessories for	105086		
	Part No.	105085	Ref. No. —
	burner cap ø 120mm		
	Part No.	105087	Ref. No. C5815599
	burner head 3.6kW for burner cap ø 120mm		
	Part No.	105088	Ref. No. —
	burner cap A ø 110mm with central hole		
	Part No.	105089	Ref. No. —
	burner ring 3kW for burner cap ø 90mm		

accessories

pan supports

			
1			
Part No.	210029	Ref. No.	3144
description	pan support W 347mm L 397mm H 43mm suitable for MACFRIN		

tube burners

			
1			
Part No.	104414	Ref. No.	C5815399
description	tubular burner ø 74mm L 180mm thread 3/8" H 52mm ID ø 25mm W 74mm		
For models:	3026, 3027, 3027V		



ceramic burners



1

Part No.	101938	Ref. No.	530587M 534030P
description	ceramic burner L 845mm W 86mm firing range 61x801mm chicken rotisserie		
For models:	5305, 53054, 5310, 53104, 5315, 53154, 5320, 53204, 5330, 53304, 5340, 53404, 5355, 5360, 53604, 5375, 5380, 53804		

gas nozzles

main nozzles

gas nozzles M10x1



1

Part No.	107827	Ref. No.	C5812660
description	gas injector thread M10x1 WS 12 bore ø 1.45mm GN		
For models:	4815, 4920, 49201, 49202, 4930, 49301, 5051, 5052S		



1

Part No.	107828	Ref. No.	C5812680
description	gas injector thread M10x1 WS 12 bore ø 1.9mm GLP		
For models:	4815, 4920, 49201, 49202, 4930, 49301, 5051, 5052S, 5315, 5320, 5330, 5336, 5340, 5348, 5355, 5372, 5375, 5396, 5424, 5436, 5448, 5496		



1

Part No.	107826	Ref. No.	C5812640
description	gas injector thread M10x1 WS 12 bore ø 1mm GLP		
For models:	4815, 4920, 49201, 49202, 4930, 49301, 5051, 5052S		



1

Part No.	107829	Ref. No.	C5812689
description	gas injector thread M10x1 WS 12 bore ø 2.2mm GN		
For models:	4930, 49301, 5051, 5052S		

pilot burner nozzles

pilot burner nozzles POLIDORO



1

Part No.	100000	Ref. No.	C5810169
description	pilot burner nozzle POLIDORO LPG code 22 bore ø 0.22mm Qty 1 pcs		
For models:	3001, 3003, 3005, 3013, 3014, 3026, 3027, 3027V, 3401, 3402, 3501, 3592, 3607, 3611S, 3614S, 3624, 3628H, 3628S, 3683S, 3684S, 3907, 3908, 3911, 3912, 4001, 4701S, 4702, 4703, 4704, 4801, 4803, 4803E, 4805, 4807, 4811, 4812, 4812E, 4815, 4817, 4903, 4907, 4999		



1

Part No.	106703	Ref. No.	C5810159
description	pilot burner nozzle POLIDORO natural gas code 27.2 bore ø 2x0.27mm Qty 1 pcs		
For models:	3001, 3003, 3005, 3013, 3014, 3026, 3027, 3027V, 3401, 3402, 3501, 3592, 3607, 3611S, 3614S, 3624, 3628H, 3628S, 3683S, 3684S, 3907, 3908, 3911, 3912, 4001, 4701S, 4702, 4703, 4704, 4801, 4803, 4803E, 4805, 4807, 4811, 4812, 4812E, 4815, 4817, 4903, 4907, 4999		



auxiliary gas parts

screw connections

olives



1



Part No.	101278	Ref. No.	3781	
description	olive for pipe ø 10mm Qty 1 pcs			
For models:	3001, 3003, 30032, 3005, 3013, 30132, 3014, 30142, 3015, 3026, 3027, 3027V, 3302, 3302S, 3303, 3303S, 3304, 3306, 3331, 3401, 3402, 3404S, 3405S, 3411S, 34121S, 3412S-Vers1, 3412S-Vers2, 3413SE1, 34151S, 3415S, 3501, 3501C, 3504, 3511SE1, 3592, 3607, 3611S, 3614S, 3624, 3628H, 3628S, 3683S, 3684S, 3907, 3908, 3911, 3912, 4001, 4404, 4404M...(Other models you can see in the webshop)			
accessories for	101278			
	Part No.	100943	Ref. No.	—
	Part No.	101300	Ref. No.	3782
	Part No.	101478	Ref. No.	—



1 gas components



			
1			
Part No.	102797	Ref. No.	A1018999
description	olive for pipe ø 6mm Qty 1 pcs		
For models:	3001, 3003, 3005, 3013, 3014, 3026, 3027, 3401, 3402, 3501, 3592, 3607, 3611S, 3614S, 3624, 3628H, 3628S, 3683S, 3684S, 3907, 3908, 3911, 3912, 4001, 4701S, 4702, 4703, 4704, 4801, 4803, 4803E, 4805, 4807, 4811, 4812, 4812E, 4815, 4817, 4903, 4907, 4999		

union nuts

			
1			
Part No.	101296	Ref. No.	C5815539
description	union nut thread M12x1 for pipe ø 8mm		
For models:	3300, 3301, 33062		
accessories for	101296		
	Part No.	101277	Ref. No. C5815549
	olive ID ø 8mm Qty 1 pcs		

			
1			
Part No.	101300	Ref. No.	3782
description	union nut thread M16x1.5 tube ø 10mm		
For models:	3001, 3003, 30032, 3005, 3013, 30132, 3014, 30142, 3015, 3026, 3027, 3027V, 3302, 3302S, 3303, 3303S, 3304, 3306, 3331, 3401, 3402, 3404S, 3405S, 3411S, 34121S, 3412S-Vers1, 3412S-Vers2, 3413SE1, 34151S, 3415S, 3501, 3501C, 3504, 3511SE1, 3592, 3607, 3611S, 3614S, 3624, 3628H, 3628S, 3683S, 3684S, 3907, 3908, 3911, 3912, 4001, 4404, 4404M...(Other models you can see in the webshop)		
accessories for	101300		
	Part No.	101278	Ref. No. 3781
	olive for pipe ø 10mm Qty 1 pcs		

union screws

			
1			
Part No.	100905	Ref. No.	C5815359
description	locking screw M10x1 for pipe ø 6mm Qty 1 pcs		
For models:	3001, 3003, 3005, 3013, 3014, 3015, 3026, 3027, 3027V, 3302, 3302S, 3303, 3303S, 3304, 3306, 3331, 3401, 3402, 3404S, 3405S, 3411S, 34121S, 3412S-Vers1, 3412S-Vers2, 3413SE1, 34151S, 3415S, 3501, 3501C, 3504, 3511SE1, 3592, 3607, 3611S, 3614S, 3624, 3628H, 3628S, 3683S, 3684S, 3907, 3908, 3911, 3912, 4437, 4701S, 4702, 4703, 4704, 4801...(Other models you can see in the webshop)		

			
1			
Part No.	100906	Ref. No.	A1018998
description	screw connection thread M10x1 for ignition electrode brass Qty 1 pcs WS 10		
For models:	3001, 3003, 3005, 3013, 3014, 3026, 3027, 3027V, 3401, 3402, 3501, 3592, 3607, 3611S, 3614S, 3624, 3628H, 3628S, 3683S, 3684S, 3907, 3911, 3912, 4001, 4701S, 4702, 4703, 4704, 4801, 4803, 4803E, 4805, 4807, 4811, 4812, 4812E, 4815, 4817, 4903, 4907, 4999		

			
1			
Part No.	100907	Ref. No.	A1018996
description	screw connection thread M10x1 Qty 1 pcs type SEF 1 ømm for thermocouple		
For models:	3001, 3003, 3005, 3013, 3014, 3026, 3027, 3027V, 3401, 3402, 3501, 3592, 3607, 3611S, 3614S, 3624, 3628H, 3628S, 3683S, 3684S, 3907, 3908, 3911, 3912, 4001, 4701S, 4702, 4703, 4704, 4801, 4803, 4803E, 4805, 4807, 4811, 4812, 4812E, 4815, 4817, 4903, 4907, 4999		

			
1			
Part No.	100909	Ref. No.	A1018997
description	union screw thread M10x1 for pipe ø 6mm Qty 1 pcs		
For models:	3001, 3003, 3005, 3013, 3014, 3026, 3027, 3027V, 3401, 3402, 3501, 3592, 3607, 3611S, 3614S, 3624, 3628H, 3628S, 3683S, 3684S, 3907, 3908, 3911, 3912, 4001, 4701S, 4702, 4703, 4704, 4801, 4803, 4803E, 4805, 4807, 4811, 4812, 4812E, 4815, 4817, 4903, 4907, 4999		
accessories for	100909		
	Part No.	100898	Ref. No. —
	olive for pipe ø 6mm Qty 1 pcs for pilot burner		
	Part No.	101286	Ref. No. —
	olive ID ø 6mm Qty 1 pcs		
	Part No.	101287	Ref. No. —
	olive for pipe ø 6mm Qty 1 pcs		
	Part No.	101288	Ref. No. —
	olive for pipe ø 6mm L 6mm aluminium Qty 1 pcs ED ø 8.5mm		



equipment-specific units



for chicken rotisserie

skewers

			
1			
Part No.	689000	Ref. No.	70290029
description	skewer square L 835mm thickness 12mm		
For models:	5305, 53054, 5310, 53104, 5315, 53154, 5320, 53204, 5330, 53304, 5340, 53404, 5355, 5360, 53604, 5375, 5380, 53804		

spit clamp

			
1			
Part No.	693143	Ref. No.	7024D001
description	skewer clamp crimping range 13x13mm ² double for skewer 12x12mm mounting pos. inner skewer 2x60mm skewer ø 4mm		
For models:	5305, 53054, 5310, 53104, 5315, 53154, 5320, 53204, 5330, 53304, 5340, 53404, 5355, 5360, 53604, 5375, 5380, 53804		

							
1							
Part No.	693142	Ref. No.	7024S001				
description	skewer clamp single for skewer 12x12mm mounting pos. outer skewer 75mm skewer ø 4mm						
For models:	5305, 53054, 5310, 53104, 5315, 53154, 5320, 53204, 5330, 53304, 5340, 53404, 5355, 5360, 53604, 5375, 5380, 53804						
accessories for	693142						
		<table border="1"> <tr> <td>Part No.</td> <td>697481</td> <td>Ref. No.</td> <td>—</td> </tr> </table>	Part No.	697481	Ref. No.	—	
Part No.	697481	Ref. No.	—				
	Thumb screw thread M6 thread L 8mm ø 14mm H 6mm SS						

knobs

producer-specific knobs

MACFRIN

			
1			
Part No.	111413	Ref. No.	348173PM N/A
description	knob zero mark ø 71.5mm shaft ø 6x4.6mm shaft flat upper grey/black		
For models:	3007, 3009, 3011, 3016, 30172, 3018, 30252, 3031, 3033, 33075, 3310, 33115, 3327, 34715, 3481, 3483, 3615, 3626, 3701, 3701S, 3702, 3702S, 3703, 3703S, 3704, 3704S, 4205, 4208, 4212, 4224, 4255, 4288, 4402E, 4403E, 4404E, 4405E, 4418, 4419, 4420, 4421, 4442E, 4443E, 4444E, 4445E, 4481, 4482, 4483, 4808, 4902, 4904...(Other models you can see in the webshop)		

			
1			
Part No.	111412	Ref. No.	340173PM N/A
description	knob zero mark ø 71.5mm shaft ø 8x6.5mm shaft flat upper grey/black		
For models:	30012, 30032, 3013, 30132, 3014, 30142, 3015, 30152, 3300, 3301, 3302, 33022, 33025, 3303, 33035, 3304, 33042, 33052, 3306, 33062, 33092, 3331, 3401, 3402, 3404S, 3405S, 3411S, 34121S, 3412S-Vers1, 3412S-Vers2, 3413SE1, 34151S, 3415S, 3501, 35012, 3501C, 3504, 3511SE1, 3592, 3911, 3912, 4001, 4402, 4402M, 4403, 4403M, 4404, 4404M, 4405, 4405M...(Other models you can see in the webshop)		

handles and hand wheels

hand wheels

hand wheels

			
1			
Part No.	694357	Ref. No.	C6262619
description	hand wheel ø 200mm D1 ø 50mm bore ø 15mm hole ø 7.2mm thread groove widthmm L1 46mm L2 50mm handle length 90mm with folding handle		
For models:	4812, 4812E, 4817		

bracket handles

			
1			
Part No.	697944	Ref. No.	70491019
description	handle L 150mm H 38mm mounting distance 135mm thread M6 W 30mm black matt		
For models:	5301, 5302, 5305, 53054, 5310, 53104, 5315, 53154, 5320, 53204, 5330, 53304, 5336, 5340, 53404, 5348, 5355, 5360, 53604, 5372, 5375, 5380, 53804, 5396, 5424, 54244, 5436, 54364, 5448, 54484, 5453, 5496, 6190, 6190E1, 9001, 9002, 9003		



hinges

spring assisted hinges

producer-specific

CORECO



1

Part No.	700830	Ref. No.	C6262001
description	spring assisted hinge right/left L 75mm W 26mm H 102mm refrigeration units mounting distance 25mm		
For models:	6190, 6190E1, 7050, 70501, 7052, 706, 7062, 7460, 7464, 7500, 7502, 75021, 7530, 7535, 75351, 9001, 9002, 9003		
accessories for	700830		
	Part No.	700854	Ref. No. —
	hinge camp type TRB/L1 36mm mounting pos. bottom right L 100mm W 48mm H 17mm zinc die cast, chrome-plated hole distance 6.5x51x28mm shaft diameter torx 12x12mmmm		

FAGOR



1

Part No.	700830	Ref. No.	C6262001
description	spring assisted hinge right/left L 75mm W 26mm H 102mm refrigeration units mounting distance 25mm		
For models:	6190, 6190E1, 7050, 70501, 7052, 706, 7062, 7460, 7464, 7500, 7502, 75021, 7530, 7535, 75351, 9001, 9002, 9003		
accessories for	700830		
	Part No.	700854	Ref. No. —
	hinge camp type TRB/L1 36mm mounting pos. bottom right L 100mm W 48mm H 17mm zinc die cast, chrome-plated hole distance 6.5x51x28mm shaft diameter torx 12x12mmmm		

oven hinges

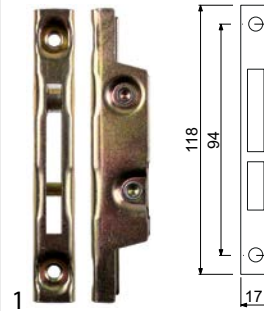

1

Part No.	700001	Ref. No.	61980
description	opposite support L 118mm W 17mm mounting distance 94mm		
For models:	3300, 3301, 3302, 33022, 3310, 3401, 3402, 3481, 3483, 3501, 35012, 3592, 3628H, 4001, 4409, 4410, 4815, 4901, 4902, 4903, 4904, 4907, 4908, 4999		



1

Part No.	694359	Ref. No.	6160 C6262599
description	oven hinge mounting distance 105mm lever length 129.5mm spring thickness 4mm mounting ear position right L 206mm W 25mm Qty 1 pcs		
For models:	3300, 3302, 33022, 3310, 3401, 3402, 3481, 3483, 3501, 35012, 3592, 3628H, 4001, 4409, 4410, 4815, 4901, 4902, 4903, 4904, 4907, 4908, 4999		



1

Part No.	694360	Ref. No.	6163 C6262609
description	oven hinge mounting distance 173mm mounting distance 2 105mm lug mounting 14mm lever length 119mm groove distance 11mm spring thickness 4mm mounting ear position left spring length 111mm L 206mm W 25mm		
For models:	3300, 3302, 33022, 3310, 3401, 3402, 3481, 3483, 3501, 35012, 3592, 3628H, 4001, 4409, 4410, 4815, 4901, 4902, 4903, 4904, 4907, 4908, 4999		



door bearing



1

Part No.	694358	Ref. No.	C6262002
description	bolt L 25mm W 25mm H 19mm ID ø 7mm for hinge		
For models:	7050, 70501, 7052, 706, 7062, 7460, 7464, 7500, 7502, 75021		



1

Part No.	694361	Ref. No.	706203P
description	hinge L 100mm W 48mm mounting pos. centre left/right		
For models:	7050, 70501, 7052, 706, 7062, 7460, 7464, 7500, 7502, 75021		



1

Part No.	694034	Ref. No.	705003P
description	hinge right/left mounting pos. lower for fridge L 130mm W 80mm		
For models:	7050, 70501, 7052, 706, 7062, 7460, 7464, 7500, 7502, 75021, 7530, 7535, 75351		



1

Part No.	694033	Ref. No.	706003P
description	hinge right/left mounting pos. upper for fridge L 130mm W 80mm		
For models:	7050, 70501, 7052, 706, 7062, 7460, 7464, 7500, 7502, 75021, 7530, 7535, 75351, 9001, 9002, 9003		

fittings for catering equipment

lid hinges

type RUBINETTERIE DEL FRIULI

for square and rectangular lids

spare parts



1

Part No.	540848	Ref. No.	C6260349
description	torsion spring ø 43mm wire gauge ø 5mm L1 25mm L2 90mm L3 25mm mounting pos. left		
For models:	4801, 4803, 4803E, 4805, 4807, 4808, 4811, 4812, 4812E, 4817		



1

Part No.	540849	Ref. No.	C6260339
description	torsion spring ø 43mm wire gauge ø 5mm L1 25mm L2 90mm L3 25mm mounting pos. right		
For models:	4801, 4803, 4803E, 4805, 4807, 4808, 4811, 4812, 4812E, 4817		

miscellaneous

spare parts



1

Part No.	514418	Ref. No.	C6260239
description	adjusting bush ID ø 47mm ED ø 50mm L 63.5mm		
For models:	4801, 4803, 4803E, 4805, 4807, 4808, 4811, 4812, 4812E, 4817		



1

Part No.	514194	Ref. No.	481240P
description	bracket for lid hinge ID ø 50mm H 89mm		
For models:	4812, 4812E, 4817		





1

Part No.	514193	Ref. No.	480340P
description	bracket for lid hinge ID ø 51mm H 185mm		
For models:	4801, 4803, 4803E, 4805, 4807, 4808, 4811		

gaskets for heated units

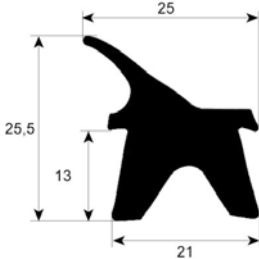
door seals



1

Part No.	901347	Ref. No.	490326P
description	door seal profile 2402 W 350mm L 575mm external size Qty 1		
For models:	3300, 3301, 3302, 33022, 3310, 3401, 3402, 3481, 3483, 3501, 35012, 4409, 4410, 4815, 4901, 4902, 4903, 4904, 4907, 4908		

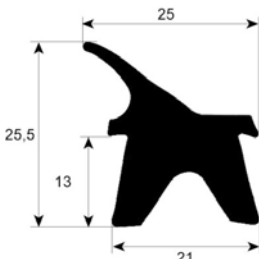

1

Part No.	901348	Ref. No.	499926P
description	door seal profile 2402 W 350mm L 985mm external size Qty 1		
For models:	3402, 3592, 3628H, 4999		

O-rings

EPDM

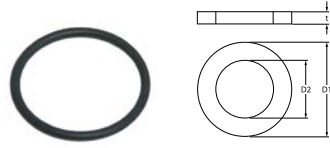

1

Part No.	100809	Ref. No.	3785
description	O-ring EPDM thickness 2mm ID ø 21mm Qty 1 pcs		
For models:	3001, 3003, 3005, 3026, 3027, 3027V, 3401, 3402, 3501, 3592, 3607, 3611S, 3614S, 3624, 3628H, 3628S, 3683S, 3684S, 3907, 3908, 4812, 4812E, 4815, 4817, 4903, 4907, 4999		

gaskets

refrigeration gaskets

plug-in gaskets

profile 9798

We offer custom-made gaskets for this profile

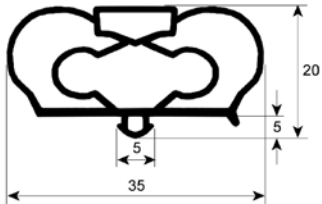

1

Part No.	901349	Ref. No.	705226P
description	refrigeration gasket profile 9798 W 602mm L 704mm plug size		
For models:	7050, 70501, 7052, 706, 7062, 7460, 7464, 7500, 7502, 75021		

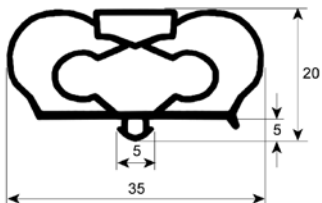

1

Part No.	901350	Ref. No.	746226P
description	refrigeration gasket profile 9798 W 604mm L 1492mm plug size		
For models:	7460, 7464, 7500, 7502, 75021, 7530, 7535, 75351		



springs

torsion springs

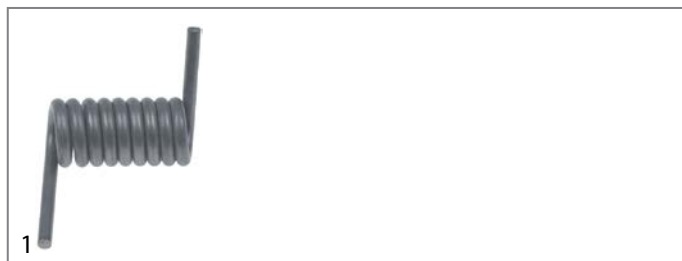

Part No.	692179	Ref. No.	6409
description	torsion spring ø 22.3mm L2 45mm wire gauge ø 4.5mm mounting pos. left L1 45mm L3 52mm Qty 1 pcs		
For models:	4401, 4462		
accessories for	692179		
	Part No.	692178	Ref. No. 6407
	torsion spring ø 22.3mm L2 45mm wire gauge ø 4.5mm mounting pos. right L1 45mm L3 52mm Qty 1 pcs		



Part No.	692178	Ref. No.	6407
description	torsion spring ø 22.3mm L2 45mm wire gauge ø 4.5mm mounting pos. right L1 45mm L3 52mm Qty 1 pcs		
For models:	4401, 4462		
accessories for	692178		
	Part No.	692179	Ref. No. 6409
	torsion spring ø 22.3mm L2 45mm wire gauge ø 4.5mm mounting pos. left L1 45mm L3 52mm Qty 1 pcs		

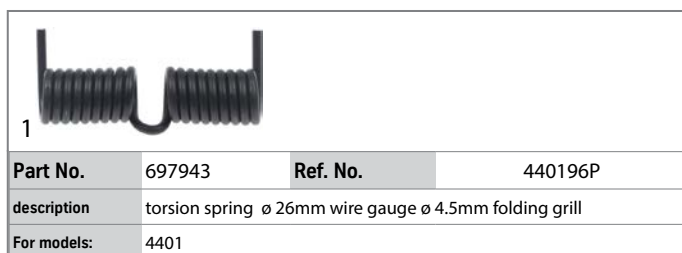

Part No.	697943	Ref. No.	440196P
description	torsion spring ø 26mm wire gauge ø 4.5mm folding grill		
For models:	4401		

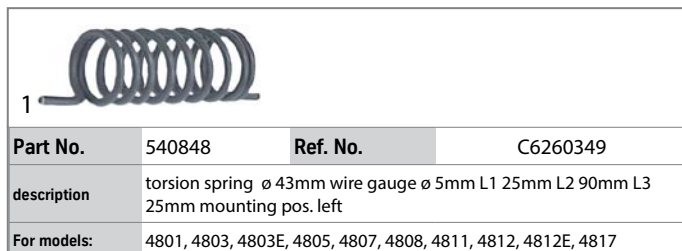

Part No.	540848	Ref. No.	C6260349
description	torsion spring ø 43mm wire gauge ø 5mm L1 25mm L2 90mm L3 25mm mounting pos. left		
For models:	4801, 4803, 4803E, 4805, 4807, 4808, 4811, 4812, 4812E, 4817		

	Part No.	540849	Ref. No.	C6260339
	description	torsion spring ø 43mm wire gauge ø 5mm L1 25mm L2 90mm L3 25mm mounting pos. right		
	For models:	4801, 4803, 4803E, 4805, 4807, 4808, 4811, 4812, 4812E, 4817		

fastening material

screws

flat-headed bolts

	Part No.	101516	Ref. No.	1051
	description	flat-headed bolt thread M4 thread L 16mm SS DIN 7985/ISO 7045 Qty 1 pcs		
	For models:	3001, 3003, 3005, 3026, 3027, 3027V, 3331, 3401, 3402, 3411S, 34121S, 3412S-Vers1, 3412S-Vers2, 3413SE1, 34151S, 3415S, 3501, 3592, 3607, 3611S, 3614S, 3624, 3628H, 3628S, 3683S, 3684S, 3907, 3908, 4812, 4812E, 4815, 4817, 4903, 4907, 4999		

nuts

hexagonal nuts

hexagonal nuts metric (without norm)

	Part No.	102680	Ref. No.	C5815299
	description	nut thread M6x0.75 H 2.6mm WS 8 brass Qty 1 pcs type SEF 2		
	For models:	3401, 3402, 3501, 3504, 3592, 4001		

	Part No.	102067	Ref. No.	C5811029
	description	nut thread M8x1 H 3mm brass Qty 1 pcs type SEF 1		
	For models:	30152, 3300, 3301, 33022, 33042, 33052, 33062, 33092, 35012, 4402, 4402M, 4403, 4403M, 4404, 4404M, 4405, 4405M, 4410, 4411, 4412, 4413, 44138, 4416, 4417, 4422, 4423, 4424, 4425, 4442, 4443, 4444, 4445, 4462, 4471, 4472, 4473, 5305, 53054, 5310, 53104, 5315, 53154, 5320, 53204, 5330, 53304, 5336, 5340, 53404, 5348...(Other models you can see in the webshop)		

GASTROPARTS.COM

