



GASTROPARTS

Lotus

[EN] Equipment

[DE] Geräte

[ES] Aparatos

[FR] Équipement

[IT] Attrezzature

[PL] Urządzenia

[RU] Оборудование

✉ gastroparts@gastroparts.com

☎ +48 56 657 00 66

📘 fb.com/gastroparts.global

GASTROPARTS.COM









heating elements

heating elements for ovens



| | | | |
|--|---|-----------------|-------------------|
| Part No. | 416516 | Ref. No. | 537020901 |
| description | heating element 1200W 230V heating circuits 1 L 505mm W 123mm thread M12x1 mounting distance 115mm tube ø 8.5mm connection male faston 6.3mm mounting pos. lower 2 hole fixing dry heating element | | |
| For models: | CF4-78ET, CF4-78ETX, CF4-78GE, CF4-78GPE, CF6-712ET, CF6-712ETV, CF6-712ETVX, CF6-712ETX, CF6-712GEV, CF6-712GPE, CF6-712GPEV, CF-712GE, CF-712GPE, CFC4-78ET, CFC4-78ETX, CFQ4-78ET, CFQ4-78ETX, CFQ6-712ET, CFQ6-712ETV, CFQ6-712ETVX, CFQ6-712ETX, MF-710ET, TPF2-712GP, TPF2-712GPE, TPF2-712GPEV, TPF2-78GP, TPF2-78GPE, TPF4-712GPE, TPF4-712GPEV, TPF-78ET, TPF-78GE | | |
| accessories for | 416516 | | |
|  | Part No. | 361182 | Ref. No. — |
| | nut thread 1/4" H 5mm nickel-plated brass WS 17 Qty 1 pcs | | |
|  | Part No. | 510417 | Ref. No. — |
| | flat gasket fibre ED ø 20mm ID ø 14mm thickness 2mm Qty 1 pcs | | |
|  | Part No. | 520228 | Ref. No. — |
| | tooth lock washer ID ø 15.3mm ED ø 24mm steel Qty 1 pcs for thread M14 | | |
|  | Part No. | 550262 | Ref. No. — |
| | flat gasket copper ED ø 20mm ID ø 14mm thickness 2mm | | |

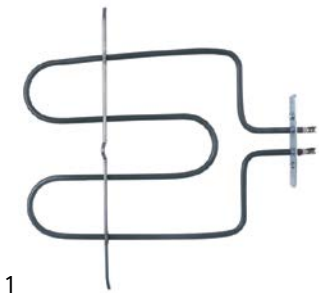





| | | | |
|--------------------|--|-----------------|-----------|
| Part No. | 415776 | Ref. No. | 537006400 |
| description | heating element 1500W 220V heating circuits 1 L 285mm W 205mm L1 52mm L2 233mm W2 32mm flange length 100mm flange width 22mm hole distance 86/43mm bridge length 305mm hole ø 3mm tube ø 6.5mm connection male faston 6.3mm connection length 23mm rectangular flange grill setting oven | | |
| For models: | CF-62EM, CF-62EM-A, CF-62ET, CF-62ET-A, CF-62GEM, CF-62GEM-A, CFC-62EM, CFC-62ET | | |



| | | | |
|--------------------|--|-----------------|-----------|
| Part No. | 419250 | Ref. No. | 537028102 |
| description | heating element 1700W 230V heating circuits 1 L 670mm W 120mm thread M12x1 mounting distance 117mm tube ø 8.5mm connection male faston 6.3mm mounting pos. lower M12x1 dry heating element | | |



| | | | |
|---|---|-----------------|-------------------|
| Part No. | 418068 | Ref. No. | 537028100 |
| description | heating element 1700W 230V heating circuits 1 L 685mm W 125mm thread M12x1 mounting distance 117mm tube ø 8.5mm connection male faston 6.3mm mounting pos. lower M12x1 dry heating element | | |
| For models: | CF4-98ET, CF4-98ETX, CF4-98GE, CF6-912ET, CF6-912ETV, CF6-912ETVX, CF6-912GE, CF6-912GEV, CF8-916ET, CF8-916ETV, CF8-916GE, CF8-916GEV, CFC4-98ET, CFQ4-98ET, CFQ4-98ETX, CFQ6-912ET, CFQ6-912ETV, CFQ6-912ETVX, CFQ8-916ET, CFQ8-916ETV, CFQ9-916ET, CFV6-912ET, CFV6-912GEV, CFVC4-98ET, CFVQ6-912ET, TPF2-912GEV, TPF2-98GE, TPF4-912GE, TPF4-912GEV, TPF-98ET, TPF-98GE | | |
| accessories for | 418068 | | |
|  | Part No. | 520229 | Ref. No. — |
| | nut thread M12x1 H 4mm WS 16 zinc-coated steel Qty 1 pcs | | |
|  | Part No. | 521110 | Ref. No. — |
| | flat gasket fibre ED ø 20mm ID ø 13mm thickness 2mm Qty 1 pcs | | |
|  | Part No. | 521131 | Ref. No. — |
| | nut thread M12x1 H 3.5mm WS 17 SS Qty 1 pcs | | |
|  | Part No. | 528110 | Ref. No. — |
| | O-ring EPDM thickness 2.62mm ID ø 12.37mm Qty 1 pcs | | |

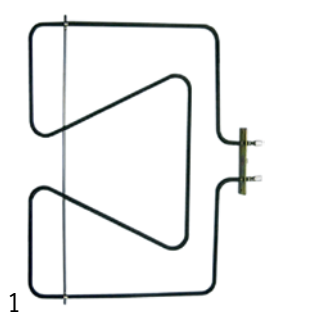



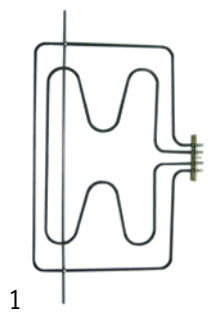

| | | | |
|--------------------|---|-----------------|-----------|
| Part No. | 415775 | Ref. No. | 537006300 |
| description | heating element 1750W 230V heating circuits 1 L 326mm W 405mm L1 34mm L2 292mm W1 170mm W2 60mm flange length 100mm flange width 22mm hole distance 86mm tube ø 6.3mm connection male faston 6.3mm mounting pos. lower rectangular flange dry heating element oven mounting thread M4 | | |
| For models: | CF-10EM, CF-10EM-6, CF-10EM-A, CF-10ET, CF-10ET-6, CF-10ET-A, CF-10GEM, CF-10GEM-6, CF-10GEM6-A, CF-10GEM-A, CF4-68ET, CF4-68ETX, CF4-68GEM, CF4-8ET, CF4-8ETS, CF4-8GEM, CF4-GEMS, CF6-610ET, CF6-610ETX, CF6-610GEM, CF-8EM, CF-8EM-A, CF-8ET, CF-8ET-A, CF-8GEM, CF-8GEM-A, CFC4-8ET, CFM-10EM, CFM-10EM-6, CFM-10EM-A, CFM-10ET, CFM-10ET-6, CFM-10ET-A, CFM-10GEM, CFM-10GEM-6, CFM-10GEM6-A, CFM-10GEM-A, CFM2-68GEM, CFM3-612GEMV, CFM4-68ET, CFM4-68GEM, CFM6-610ET, CFM6-610GEM, CFM-8EM, CFM-8EM-A, CFM-8ET, CFM-8ET-A, CFM-8GEM, CFM-8GEM-A, MFM-610EM...(Other models you can see in the webshop) | | |

1 electric components







| | | | |
|--------------------|---|-----------------|-----------|
| Part No. | 415774 | Ref. No. | 537006200 |
| description | heating element 3050W 230V heating circuits 2 L 325mm W 474mm L1 40mm L2 285mm W1 237mm W2 60mm flange length 100mm flange width 22mm hole distance 85mm bridge length 620mm hole \varnothing M4mm tube \varnothing 6.3mm connection male faston 6.3mm mounting pos. upper rectangular flange dry heating element oven | | |
| For models: | CF-10EM, CF-10EM-6, CF-10EM-A, CF-10ET, CF-10ET-6, CF-10ET-A, CF-10GEM, CF-10GEM-6, CF-10GEM6-A, CF-10GEM-A, CF4-68ET, CF4-68ETX, CF4-68GEM, CF4-8ET, CF4-8ETS, CF4-8GEM, CF4-GEMS, CF6-610ET, CF6-610ETX, CF6-610GEM, CF-8EM, CF-8EM-A, CF-8ET, CF-8ET-A, CF-8GEM, CF-8GEM-A, CFC4-8ET, CFM-10EM, CFM-10EM-6, CFM-10EM-A, CFM-10ET, CFM-10ET-6, CFM-10ET-A, CFM-10GEM, CFM-10GEM-6, CFM-10GEM6-A, CFM-10GEM-A, CFM2-68GEM, CFM3-612GEMV, CFM4-68ET, CFM4-68GEM, CFM6-610ET, CFM6-610GEM, CFM-8EM, CFM-8EM-A, CFM-8ET, CFM-8ET-A, CFM-8GEM, CFM-8GEM-A, MFM-610EM...(Other models you can see in the webshop) | | |



| | | | |
|---|---|-----------------|-------------------|
| Part No. | 416661 | Ref. No. | 537025400 |
| description | heating element 700W 230V L 500mm W 123mm thread M12x1 mounting distance 115mm tube \varnothing 8.5mm connection male faston 6.3mm mounting pos. upper 2 hole fixing dry heating element | | |
| For models: | CF4-78ET, CF4-78ETX, CF4-78GE, CF4-78GPE, CF6-712ET, CF6-712ETV, CF6-712ETVX, CF6-712ETX, CF6-712GEV, CF6-712GPE, CF6-712GPEV, CF-712GE, CF-712GPE, CFC4-78ET, CFC4-78ETX, CFQ4-78ET, CFQ4-78ETX, CFQ6-712ET, CFQ6-712ETV, CFQ6-712ETVX, CFQ6-712ETX, MF-710ET, TPF2-712GP, TPF2-712GPE, TPF2-712GPEV, TPF2-78GP, TPF2-78GPE, TPF4-712GPE, TPF4-712GPEV, TPF-78ET, TPF-78GE | | |
| spare parts for | 416661 | | |
|  | Part No. | 521110 | Ref. No. — |
| | flat gasket fibre ED \varnothing 20mm ID \varnothing 13mm thickness 2mm Qty 1 pcs | | |
| accessories for | 416661 | | |
|  | Part No. | 520229 | Ref. No. — |
| | nut thread M12x1 H 4mm WS 16 zinc-coated steel Qty 1 pcs | | |
|  | Part No. | 521131 | Ref. No. — |
| | nut thread M12x1 H 3.5mm WS 17 SS Qty 1 pcs | | |
|  | Part No. | 528110 | Ref. No. — |
| | O-ring EPDM thickness 2.62mm ID \varnothing 12.37mm Qty 1 pcs | | |



| | | | |
|---|---|-----------------|------------------------|
| Part No. | 418067 | Ref. No. | 537027800 537027801 |
| description | heating element 800W 230V heating circuits 1 L 685mm W 125mm thread M12x1 mounting distance 117mm tube \varnothing 8.5mm connection male faston 6.3mm mounting pos. upper M12x1 dry heating element | | |
| For models: | CF4-98ET, CF4-98ETX, CF4-98GE, CF6-912ET, CF6-912ETV, CF6-912ETVX, CF6-912GE, CF6-912GEV, CF8-916ET, CF8-916ETV, CF8-916GE, CF8-916GEV, CFC4-98ET, CFQ4-98ET, CFQ4-98ETX, CFQ6-912ET, CFQ6-912ETV, CFQ6-912ETVX, CFQ8-916ET, CFQ8-916ETV, CFQ9-916ET, CFV6-912ET, CFV6-912GEV, CFVC4-98ET, CFVQ6-912ET, TPF2-912GEV, TPF2-98GE, TPF4-912GE, TPF4-912GEV, TPF-98ET, TPF-98GE | | |
| accessories for | 418067 | | |
|  | Part No. | 520229 | Ref. No. — |
| | nut thread M12x1 H 4mm WS 16 zinc-coated steel Qty 1 pcs | | |
|  | Part No. | 521110 | Ref. No. — |
| | flat gasket fibre ED \varnothing 20mm ID \varnothing 13mm thickness 2mm Qty 1 pcs | | |
|  | Part No. | 521131 | Ref. No. — |
| | nut thread M12x1 H 3.5mm WS 17 SS Qty 1 pcs | | |
|  | Part No. | 528110 | Ref. No. — |
| | O-ring EPDM thickness 2.62mm ID \varnothing 12.37mm Qty 1 pcs | | |

heating elements for bain maries



| | | | |
|--------------------|---|-----------------|-----------|
| Part No. | 416194 | Ref. No. | 537004800 |
| description | heating element 1189W 230V heating circuits 1 L 278mm W 150mm connection male faston 6.3mm tube \varnothing 6.3mm 2 hole fixing thread 1/8" immersion heater/dry heating element L1 135mm L2 143mm H 22mm mounting distance 144mm | | |
| For models: | BM-61EM, MP-62, MP-62EM, SV-23 | | |







| | | | |
|---|--|-----------------|-------------------|
| Part No. | 415700 | Ref. No. | N/A |
| description | heating element 1300W 230V heating circuits 1 L 280mm W 110mm connection male faston 6.3mm tube \varnothing 6.3mm 2 hole fixing thread M10x1 immersion heater/dry heating element bain marie/pasta cooker L1 135mm L2 145mm H 20mm mounting distance 104mm | | |
| accessories for | 415700 | | |
|  | Part No. | 510416 | Ref. No. — |
| | flat gasket fibre ED \varnothing 19mm ID \varnothing 10.5mm thickness 1.5mm for thread M10 Qty 1 pcs | | |
|  | Part No. | 510893 | Ref. No. — |
| | O-ring EPDM thickness 2.62mm ID \varnothing 9.92mm Qty 1 pcs | | |
|  | Part No. | 520231 | Ref. No. — |
| | nut thread M10x1 H 6mm WS 14 zinc-coated steel Qty 1 pcs | | |

Table continues overleaf











| | | | |
|---|---|--------|-------------------|
| accessories for | 415700 | | |
|  | Part No. | 521129 | Ref. No. — |
| | nut thread M10 H 6mm SS WS 17 Qty 1 pcs DIN/ISO DIN 439 | | |

| | | | | |
|---|---|--------|-----------------|-----------|
|  | Part No. | 415772 | Ref. No. | 537004200 |
| description | heating element 823W 230V L 276mm W 108mm H 20mm 2 hole fixing connection male faston 6.3mm thread M10x1 tube ø 6.3mm connection length 22mm dry heating element | | | |
| For models: | BM-61EM, BM-62EM, BM-62ET, BS-4EM, BS-4EMX, BS-61EM, BS-62EM, BS-74EM, BS-94EM, BSD-64EM, BST-64EM, BST-74EM, BST-94EM, CP-61EM, CP-62ET, SV-11, SV-113, SV-12, SV-123, SV-13 | | | |

heating elements for frying pans

| | | | | |
|---|---|--------|-----------------|-----------|
|  | Part No. | 418072 | Ref. No. | 537029500 |
| description | heating element 2000W 230V heating circuits 1 L 498mm W 92mm connection 6.3 tube ø 8.5mm 2 hole fixing thread M12x1 dry heating element multi purpose roasting pan mounting distance 84mm | | | |
| For models: | BRF-74ET, BRF-78ET, BRFD-64ET | | | |



| | | | | |
|---|--|--------|-----------------|-----------|
|  | Part No. | 415771 | Ref. No. | 537015100 |
| description | heating element 2000W 230V L 280mm W 170mm connection length 23mm connection male faston 6.3mm tube ø 8.5mm 2 hole fixing thread M12x1 immersion heater/dry heating element for frying pan/boiling kettle L1 135mm L2 145mm H 23mm mounting distance 154mm | | | |
| For models: | BR-62ET, BR-6ET, BRT-66ET, BRT-66ETX | | | |
| accessories for | 415771 | | | |
|  | Part No. | 520229 | Ref. No. | — |
| | nut thread M12x1 H 4mm WS 16 zinc-coated steel Qty 1 pcs | | | |
|  | Part No. | 521110 | Ref. No. | — |
| | flat gasket fibre ED ø 20mm ID ø 13mm thickness 2mm Qty 1 pcs | | | |
|  | Part No. | 521131 | Ref. No. | — |
| | nut thread M12x1 H 3.5mm WS 17 SS Qty 1 pcs | | | |
|  | Part No. | 528110 | Ref. No. | — |
| | O-ring EPDM thickness 2.62mm ID ø 12.37mm Qty 1 pcs | | | |

| | | | | |
|--|---|--------|-----------------|-----------|
|  | Part No. | 418071 | Ref. No. | 537030300 |
| description | heating element 2600W 230V heating circuits 1 L 665mm W 95mm connection male faston 6.3mm tube ø 8.5mm 2 hole fixing thread M12x1 dry heating element multi purpose roasting pan mounting distance 88mm | | | |
| For models: | BRF-94ET, BRF-98ET | | | |
| accessories for | 418071 | | | |
|  | Part No. | 520229 | Ref. No. | — |
| | nut thread M12x1 H 4mm WS 16 zinc-coated steel Qty 1 pcs | | | |
|  | Part No. | 521110 | Ref. No. | — |
| | flat gasket fibre ED ø 20mm ID ø 13mm thickness 2mm Qty 1 pcs | | | |
|  | Part No. | 521131 | Ref. No. | — |
| | nut thread M12x1 H 3.5mm WS 17 SS Qty 1 pcs | | | |
|  | Part No. | 528110 | Ref. No. | — |
| | O-ring EPDM thickness 2.62mm ID ø 12.37mm Qty 1 pcs | | | |

heating elements for fryers

side connection

miscellaneous

| | | | | |
|--|---|--------|-----------------|-----------|
|  | Part No. | 418077 | Ref. No. | 537026800 |
| description | heating element 19500W 230/400V heating circuits 3 mounting pos. right L 458mm W 190mm H 35mm flange length 36.5mm flange length 1 3mm flange length 2 33.5mm flange ø1 65mm flange ø2 60mm thermostat sleeves ø 6mm length thermostat sleeves 180mm number of thermostat sleeves 2 thermostat sleeve eccentric, clinging/not clinging L1 18mm L2 440mm W1 38mm W2 152mm tube ø 8.5mm cable length 500mm rotation flange fryer heaters connection length 30mm | | | |
| For models: | F18-94ET, F18-94ETX, F2-18-98ET, F2-18-98ETX, F2-25-98ET, F2-25-98ETX, F25-94ET, F25-94ETX | | | |
| accessories for | 418077 | | | |
|  | Part No. | 550494 | Ref. No. | 536009800 |
| | O-ring Viton thickness 3.53mm ID ø 47.22mm Qty 1 pcs | | | |



off-center connection

miscellaneous



| | | | |
|-----------------|--------|-----------------|-----------|
| Part No. | 416527 | Ref. No. | 537026700 |
|-----------------|--------|-----------------|-----------|

description heating element 13500W 230/400V heating circuits 3 mounting pos. left L 340mm W 215mm H 35mm flange length 36.5mm flange length 1 3mm flange length 2 33.5mm flange ϕ 1 65mm flange ϕ 2 60mm thermostat sleeves ϕ 6.5mm length thermostat sleeves 210mm number of thermostat sleeves 2 windings 8 L1 25mm L2 315mm W1 35mm W2 37mm tube ϕ 8.5mm cable length 280mm rotation flange fryer heaters fryer connection length 35mm

For models: F18-74ET, F18-74ETX, F18-94ET, F18-94ETX, F18D-64ET, F2-18-74ET, F2-18-74ETX, F2-18-78ET, F2-18-78ETX, F2-18-98ET, F2-18-98ETX, F2-25-98ET, F2-25-98ETX, F25-94ET, F25-94ETX

accessories for 416527



| | | | |
|-----------------|--------|-----------------|-----------|
| Part No. | 345032 | Ref. No. | 537011500 |
|-----------------|--------|-----------------|-----------|

microswitch with plunger thread M10x1 thread L 12mm 250V 16A 1CO connection male faston 6.3mm stroke 7mm mounting distance 22mm L 28mm ambient temperature max. 125°C type SP9603 actuating force: 180g



| | | | |
|-----------------|--------|-----------------|-----------|
| Part No. | 550494 | Ref. No. | 536009800 |
|-----------------|--------|-----------------|-----------|

O-ring Viton thickness 3.53mm ID ϕ 47.22mm Qty 1 pcs

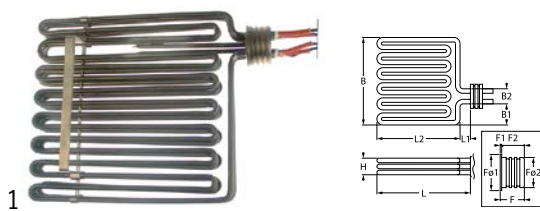

| | | | |
|-----------------|--------|-----------------|------------------------|
| Part No. | 416526 | Ref. No. | 537021400 537021401 |
|-----------------|--------|-----------------|------------------------|

description heating element 13500W 230/400V heating circuits 3 mounting pos. left L 340mm W 300mm H 35mm flange length 36.5mm flange length 2 33.5mm flange ϕ 1 65mm flange ϕ 2 60mm thermostat sleeves ϕ 6.5mm length thermostat sleeves 210mm number of thermostat sleeves 2 windings 8 L1 25mm L2 315mm W1 36mm W2 37mm tube ϕ 8.5mm cable length 300mm rotation flange immersion heater connection length 42mm

For models: F18-74ET, F2-18-78ET

accessories for 416526



| | | | |
|-----------------|--------|-----------------|-----------|
| Part No. | 345032 | Ref. No. | 537011500 |
|-----------------|--------|-----------------|-----------|

microswitch with plunger thread M10x1 thread L 12mm 250V 16A 1CO connection male faston 6.3mm stroke 7mm mounting distance 22mm L 28mm ambient temperature max. 125°C type SP9603 actuating force: 180g



| | | | |
|-----------------|--------|-----------------|-----------|
| Part No. | 550494 | Ref. No. | 536009800 |
|-----------------|--------|-----------------|-----------|

O-ring Viton thickness 3.53mm ID ϕ 47.22mm Qty 1 pcs



| | | | |
|-----------------|--------|-----------------|-----------|
| Part No. | 416525 | Ref. No. | 537021301 |
|-----------------|--------|-----------------|-----------|

description heating element 9750W 230/400V heating circuits 3 mounting pos. left L 305mm W 220mm H 35mm flange length 36.5mm flange length 1 3mm flange length 2 33.5mm flange ϕ 1 65mm flange ϕ 2 60mm thermostat sleeves ϕ 6.5mm length thermostat sleeves 220mm number of thermostat sleeves 2 thermostat sleeve eccentric, clinging/not clinging windings 6 L1 23mm L2 282mm W1 34mm W2 37mm tube ϕ 8mm cable length 280mm rotation flange immersion heater fryer connection length 25mm

For models: F13-74ET, F2-13-78ET

accessories for 416525



| | | | |
|-----------------|--------|-----------------|-----------|
| Part No. | 345032 | Ref. No. | 537011500 |
|-----------------|--------|-----------------|-----------|

microswitch with plunger thread M10x1 thread L 12mm 250V 16A 1CO connection male faston 6.3mm stroke 7mm mounting distance 22mm L 28mm ambient temperature max. 125°C type SP9603 actuating force: 180g



| | | | |
|-----------------|--------|-----------------|-----------|
| Part No. | 550494 | Ref. No. | 536009800 |
|-----------------|--------|-----------------|-----------|

O-ring Viton thickness 3.53mm ID ϕ 47.22mm Qty 1 pcs



| | | | |
|-----------------|--------|-----------------|-----------|
| Part No. | 416524 | Ref. No. | 537021300 |
|-----------------|--------|-----------------|-----------|

description heating element 9750W 230V L1 20mm L2 285mm W1 34mm W2 37mm rotation flange tube ϕ 8.5mm heating circuits 3 cable length 280mm H 35mm L 305mm W 220mm windings 6 thermostat sleeves ϕ 6.5mm number of thermostat sleeves 2 length thermostat sleeves 210mm connection length 45mm flange length 1 3mm flange length 2 33.6mm flange length 36.6mm flange ϕ 1 65mm flange ϕ 2 60mm mounting pos. left fryer thermostat sleeve eccentric, clinging/not clinging immersion heater

For models: F13-74ET, F2-13-78ET

2 hole fixing



| | | | |
|-----------------|--------|-----------------|-----------|
| Part No. | 416651 | Ref. No. | 537010800 |
|-----------------|--------|-----------------|-----------|

description heating element 1800W 230V heating circuits 1 L 388mm W 127mm H 172mm L1 30mm L2 358mm thread M12x1 tube ϕ 8.5mm windings 2 2 hole fixing connection male faston 6.3mm fryer

For models: FMPE-20, FMPE-25, FMPE-30, FPE-20

accessories for 416651



| | | | |
|-----------------|--------|-----------------|---|
| Part No. | 520229 | Ref. No. | — |
|-----------------|--------|-----------------|---|

nut thread M12x1 H 4mm WS 16 zinc-coated steel Qty 1 pcs





| | | | |
|-----------------|--------|-----------------|---|
| Part No. | 521110 | Ref. No. | — |
|-----------------|--------|-----------------|---|





flat gasket fibre ED ϕ 20mm ID ϕ 13mm thickness 2mm Qty 1 pcs

Table continues overleaf

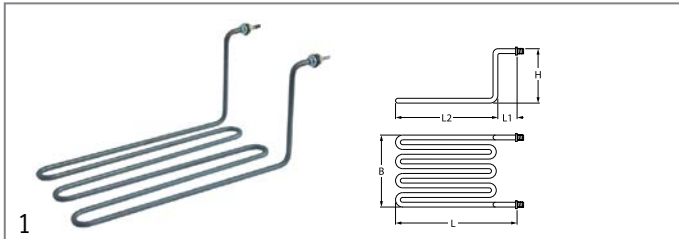





| | | | | |
|---|---|--------|----------|---|
| accessories for | 416651 | | | |
|  | Part No. | 521131 | Ref. No. | — |
| | nut thread M12x1 H 3.5mm WS 17 SS Qty 1 pcs | | | |
|  | Part No. | 528110 | Ref. No. | — |
| | O-ring EPDM thickness 2.62mm ID ø 12.37mm Qty 1 pcs | | | |

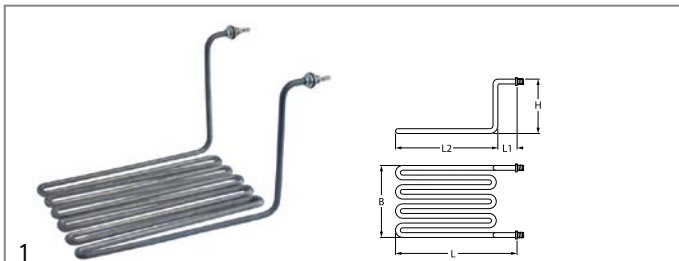





| | | | | |
|---|--|-----------------|-----------|---|
| Part No. | 416652 | Ref. No. | 537010900 | |
| description | heating element 2500W 230V heating circuits 1 L 390mm W 192mm H 170mm L1 29mm L2 361mm thread M12x1 tube ø 9mm windings 3 2 hole fixing connection male faston 6.3mm fryer | | | |
| For models: | FMPE-25, FPE-25 | | | |
| accessories for | 416652 | | | |
|  | Part No. | 520229 | Ref. No. | — |
| | nut thread M12x1 H 4mm WS 16 zinc-coated steel Qty 1 pcs | | | |
|  | Part No. | 521110 | Ref. No. | — |
| | flat gasket fibre ED ø 20mm ID ø 13mm thickness 2mm Qty 1 pcs | | | |
|  | Part No. | 521131 | Ref. No. | — |
| | nut thread M12x1 H 3.5mm WS 17 SS Qty 1 pcs | | | |
|  | Part No. | 528110 | Ref. No. | — |
| | O-ring EPDM thickness 2.62mm ID ø 12.37mm Qty 1 pcs | | | |

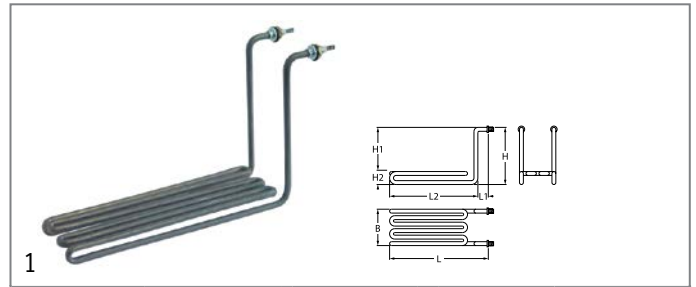

| | | | | |
|---|---|-----------------|-----------|---|
| Part No. | 416648 | Ref. No. | 537003300 | |
| description | heating element 3000W 230V heating circuits 1 L 315mm W 185mm H 180mm L1 28mm L2 277mm thread 1/4" mounting distance 174mm tube ø 8.5mm windings 6 2 hole fixing connection male faston 6.3mm fryer heaters | | | |
| For models: | FEM-2-6, FEM-6, FQ-4EM, FQ-61EM, FQ-61ET, FQ-62EM, FQ-62ET, FQ-6EM | | | |
| accessories for | 416648 | | | |
|  | Part No. | 361182 | Ref. No. | — |
| | nut thread 1/4" H 5mm nickel-plated brass WS 17 Qty 1 pcs | | | |
|  | Part No. | 510417 | Ref. No. | — |
| | flat gasket fibre ED ø 20mm ID ø 14mm thickness 2mm Qty 1 pcs | | | |
|  | Part No. | 520228 | Ref. No. | — |
| | tooth lock washer ID ø 15.3mm ED ø 24mm steel Qty 1 pcs for thread M14 | | | |
|  | Part No. | 550262 | Ref. No. | — |
| | flat gasket copper ED ø 20mm ID ø 14mm thickness 2mm | | | |



| | | | | |
|--|---|-----------------|-----------|---|
| Part No. | 416649 | Ref. No. | 537003700 | |
| description | heating element 2000W 230V heating circuits 1 L 328mm W 110mm H 196mm L1 30mm L2 298mm H1 170mm H2 26mm thread M12x1 tube ø 8.5mm 2 hole fixing connection male faston 6.3mm fryer windings 4 | | | |
| For models: | FE-10, FE2-10, FME-10, FME-2-10 | | | |
| spare parts for | 416649 | | | |
|  | Part No. | 521110 | Ref. No. | — |
| | flat gasket fibre ED ø 20mm ID ø 13mm thickness 2mm Qty 1 pcs | | | |
| accessories for | 416649 | | | |
|  | Part No. | 520229 | Ref. No. | — |
| | nut thread M12x1 H 4mm WS 16 zinc-coated steel Qty 1 pcs | | | |
|  | Part No. | 521131 | Ref. No. | — |
| | nut thread M12x1 H 3.5mm WS 17 SS Qty 1 pcs | | | |
|  | Part No. | 528110 | Ref. No. | — |
| | O-ring EPDM thickness 2.62mm ID ø 12.37mm Qty 1 pcs | | | |

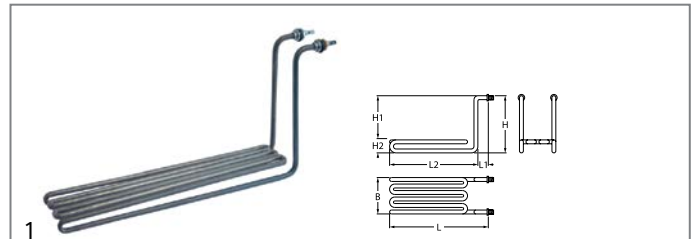

| | | | | |
|---|--|-----------------|-----------|---|
| Part No. | 416650 | Ref. No. | 537004300 | |
| description | heating element 3000W 230V heating circuits 1 L 405mm W 89mm H 198mm L1 29mm L2 376mm H1 169mm H2 29mm thread M12x1 tube ø 8.5mm 2 hole fixing connection male faston 6.3mm fryer windings 4 | | | |
| For models: | FME-15, FME-2-15 | | | |
| accessories for | 416650 | | | |
|  | Part No. | 520229 | Ref. No. | — |
| | nut thread M12x1 H 4mm WS 16 zinc-coated steel Qty 1 pcs | | | |
|  | Part No. | 521110 | Ref. No. | — |
| | flat gasket fibre ED ø 20mm ID ø 13mm thickness 2mm Qty 1 pcs | | | |
|  | Part No. | 521131 | Ref. No. | — |
| | nut thread M12x1 H 3.5mm WS 17 SS Qty 1 pcs | | | |
|  | Part No. | 528110 | Ref. No. | — |
| | O-ring EPDM thickness 2.62mm ID ø 12.37mm Qty 1 pcs | | | |



| | | | |
|------------------------|---|-----------------|-------------------|
| | | | |
| 1 | | | |
| Part No. | 415704 | Ref. No. | 537003500 |
| description | heating element 1800W 230V heating circuits 1 L 310mm W 60mm H 200mm L1 30mm L2 280mm H1 160mm H2 40mm thread M12x1 mounting distance 50mm tube \varnothing 8.5mm 2 hole fixing connection male faston 6.3mm fryer windings 4 | | |
| For models: | FE-2-8, FE-8, FP-62ET, FP-6ET, FQ-4ET, FQ-61EM, FQ-61ET, FQ-62EM, FQ-62ET, FQ-6ET | | |
| spare parts for | 415704 | | |
| | Part No. | 521110 | Ref. No. — |
| | flat gasket fibre ED \varnothing 20mm ID \varnothing 13mm thickness 2mm Qty 1 pcs | | |
| accessories for | 415704 | | |
| | Part No. | 520229 | Ref. No. — |
| | nut thread M12x1 H 4mm WS 16 zinc-coated steel Qty 1 pcs | | |
| | Part No. | 521131 | Ref. No. — |
| | nut thread M12x1 H 3.5mm WS 17 SS Qty 1 pcs | | |
| | Part No. | 528110 | Ref. No. — |
| | O-ring EPDM thickness 2.62mm ID \varnothing 12.37mm Qty 1 pcs | | |

| | | | |
|------------------------|--|-----------------|-------------------|
| | | | |
| 1 | | | |
| Part No. | 415705 | Ref. No. | 537003100 |
| description | heating element 2500W 230V heating circuits 1 L 285mm W 104mm H 205mm L1 20mm L2 265mm H1 169mm H2 36mm thread 1/4" mounting distance 28mm tube \varnothing 8.5mm 2 hole fixing connection male faston 6.3mm immersion heater W1 34mm W2 36mm windings 4 | | |
| For models: | FEC-4 | | |
| spare parts for | 415705 | | |
| | Part No. | 510417 | Ref. No. — |
| | flat gasket fibre ED \varnothing 20mm ID \varnothing 14mm thickness 2mm Qty 1 pcs | | |
| accessories for | 415705 | | |
| | Part No. | 361182 | Ref. No. — |
| | nut thread 1/4" H 5mm nickel-plated brass WS 17 Qty 1 pcs | | |
| | Part No. | 520228 | Ref. No. — |
| | tooth lock washer ID \varnothing 15.3mm ED \varnothing 24mm steel Qty 1 pcs for thread M14 | | |
| | Part No. | 550262 | Ref. No. — |
| | flat gasket copper ED \varnothing 20mm ID \varnothing 14mm thickness 2mm | | |

heating elements for griddles

| | | | |
|--------------------|--|-----------------|-----------|
| | | | |
| 1 | | | |
| Part No. | 415703 | Ref. No. | 537005100 |
| description | heating element 1000W 230V heating circuits 1 L 333mm W 80mm H 64mm tube \varnothing 6.3mm W1 20mm W2 51mm connection male faston 6.3mm connection length 19mm dry heating element | | |
| For models: | FTL-61EM, FTL-61EMS, FTL-61ET, FTL-61ETS, FTL-62EM, FTL-62EMS, FTL-62ET, FTL-62ETS, FTL-63ET, FTL-63ETS, FTL-64ET, FTL-64ETS, FTLR-62EM, FTLR-62EMS, FTLR-62ET, FTLR-62ETS, FTLR-63ET, FTLR-63ETS, FTLR-64ET, FTLR-64ETS, FTR-61EM, FTR-61EMS, FTR-61ET, FTR-61ETS, FTR-62EM, FTR-62EMS, FTR-62ET, FTR-62ETS | | |

| | | | |
|--------------------|--|-----------------|-----------|
| | | | |
| 1 | | | |
| Part No. | 415367 | Ref. No. | 537005200 |
| description | heating element 1500W 230V heating circuits 1 L 425mm W 90mm H 70mm tube \varnothing 6.3mm W2 60mm connection male faston 6.3mm griddle connection distance 52mm dry heating element | | |
| For models: | FTL-4EM, FTL-4EMS, FTL-4ET, FTL-4ETS, FTL-6EM, FTL-6EMS, FTL-6ET, FTL-6ETS, FTL-8EM, FTL-8EMS, FTL-8ET, FTL-8ETS, FTLD-64ET, FTLD-66ET, FTLD-68ET, FTLR-6EM, FTLR-6EMS, FTLR-6ET, FTLR-6ETS, FTLR-8EM, FTLR-8EMS, FTLR-8ET, FTLR-8ETS, FTLRD-66ET, FTLRD-68ET, FTR-4EM, FTR-4EMS, FTR-4ET, FTR-4ETS, FTR-6EM, FTR-6EMS, FTR-6ET, FTR-6ETS, FTRD-64ET, FTRD-66ET, FTRD-68ET | | |

| | | | |
|--------------------|---|-----------------|-----------|
| | | | |
| 1 | | | |
| Part No. | 416518 | Ref. No. | 537021000 |
| description | heating element 1500W 230V heating circuits 1 L 498mm W 158mm H 59mm tube \varnothing 6.3mm W2 67mm connection male faston 6.3mm griddle connection distance 126mm dry heating element | | |
| For models: | FTL-712ET, FTL-712ETS, FTL-712ETX, FTL-74ET, FTL-74ETS, FTL-74ETX, FTL-76ET, FTL-76ETS, FTL-78ET, FTL-78ETS, FTL-78ETX, FTLR-712ET, FTLR-712ETS, FTLR-712ETX, FTLR-76ET, FTLR-76ETS, FTLR-78ET, FTLR-78ETS, FTLR-78ETX, FTR-712ET, FTR-712ETS, FTR-712ETX, FTR-74ET, FTR-74ETS, FTR-74ETX, FTR-76ET, FTR-76ETS, FTR-78ET, FTR-78ETS, FTR-78ETX, FTTL-712ET, FTTL-74ET, FTTL-74ETS, FTTL-76ET, FTTL-76ETS, FTTL-78ET, FTTL-78ETS, FTTLR-712ET, FTTLR-76ET, FTTLR-76ETS, FTTLR-78ET, FTTLR-78ETS, FTTR-712ET, FTTR-74ET, FTTR-74ETS, FTTR-76ET, FTTR-76ETS, FTTR-78ET, FTTR-78ETS | | |

| | | | |
|--------------------|---|-----------------|-----------|
| | | | |
| 1 | | | |
| Part No. | 416519 | Ref. No. | 537014700 |
| description | heating element 1900W 230V heating circuits 3 tube \varnothing 11mm L 397mm W 220mm H 20mm connection male faston 6.3mm dry heating element griddle | | |
| For models: | FTC-61EM, FTC-61ET, FTC-62EM, FTC-62ET | | |



1 

| | | | |
|--------------------|--|-----------------|-----------|
| Part No. | 418069 | Ref. No. | 537025200 |
| description | heating element 2000W 230V heating circuits 1 L 660mm W 85mm H 60mm tube ø 6.3mm W2 75mm connection male faston 6.3mm griddle connection distance 45mm dry heating element | | |
| For models: | FTL-94ET, FTL-94ETS, FTL-94ETX, FTL-98ET, FTL-98ETS, FTL-98ETX, FTLR94ET, FTLR94ETS, FTLR-98ET, FTLR-98ETS, FTLR-98ETX, FTR-94ET, FTR-94ETX, FTR-98ET, FTR-98ETS, FTR-98ETX, FTTL-94ET, FTTL-94ETS, FTTL-98ET, FTTL-98ETS, FTTLR-98ET, FTTLR-98ETS, FTTR-94ET, FTTR-94ETS, FTTR-98ET, FTTR-98ETS | | |

2 

| | | | |
|--------------------|---|-----------------|-----------|
| Part No. | 415702 | Ref. No. | 537004100 |
| description | heating element 2400W 230V heating circuits 1 L 342mm W 227mm H 53mm tube ø 6.3mm W1 30mm W2 165mm connection male faston 6.3mm griddle connection distance 158mm dry heating element | | |

1 

| | | | |
|--------------------|--|-----------------|-----------|
| Part No. | 419225 | Ref. No. | 537025201 |
| description | heating element 2500W 230V heating circuits 1 L 600mm W 85mm H 60mm tube ø 6mm | | |
| For models: | FTL-94ET, FTL-94ETX, FTL-98ET, FTL-98ETX, FTLR-98ET, FTLR-98ETX, FTR-94ET, FTR-94ETX, FTR-98ET, FTR-98ETX, FTTL-94ET, FTTL-94ETX, FTTLR-98ET, FTTLR-98ETX, FTTR-94ET, FTTR-94ETX | | |

1 

| | | | |
|--------------------|--|-----------------|-----------|
| Part No. | 416645 | Ref. No. | 537004100 |
| description | heating element 2653W 230V heating circuits 1 warming plate | | |
| For models: | FTL-61EM, FTL-61EMS, FTL-61ET, FTL-61ETS, FTL-62EM, FTL-62EMS, FTL-62ET, FTL-62ETS, FTL-63EM, FTL-63EMS, FTL-64EM, FTL-64EMS, FTLR-62EM, FTLR-62EMS, FTLR-62ET, FTLR-62ETS, FTLR-63EM, FTLR-63EMS, FTLR-64EM, FTLR-64EMS, FTR-61EM, FTR-61EMS, FTR-61ET, FTR-61ETS, FTR-62EM, FTR-62EMS, FTR-62ET, FTR-62ETS, WP | | |

1 

| | | | |
|--------------------|---|-----------------|-----------|
| Part No. | 415373 | Ref. No. | 537013100 |
| description | heating element 3240W 230V heating circuits 3 tube ø 11mm L 390mm W 265mm H 30mm connection male faston 6.3mm dry heating element | | |
| For models: | FTC-4EM, FTC-4EMX, FTC-4ET, FTC-8EMX, FTC-8ET | | |





heating elements for tilting bratt pan

1 



| | | | |
|--------------------|--|-----------------|----------|
| Part No. | 416692 | Ref. No. | 40400082 |
| description | heating element tilting bratt pan 2900W 230V L 312mm W 200mm H 82mm connection M5 dry heating element heating circuits 1 tube ø 8.5mm W1 66mm W2 68mm connection distance 61mm | | |



heating elements for pasta cookers





1 



| | | | | |
|---|--|-----------------|-----------------|---|
| Part No. | 415700 | Ref. No. | N/A | |
| description | heating element 1300W 230V heating circuits 1 L 280mm W 110mm connection male faston 6.3mm tube ø 6.3mm 2 hole fixing thread M10x1 immersion heater/dry heating element bain marie/pasta cooker L1 135mm L2 145mm H 20mm mounting distance 104mm | | | |
| accessories for | 415700 | | | |
|  | Part No. | 510416 | Ref. No. | — |
| | flat gasket fibre ED ø 19mm ID ø 10.5mm thickness 1.5mm for thread M10 Qty 1 pcs | | | |
|  | Part No. | 510893 | Ref. No. | — |
| | O-ring EPDM thickness 2.62mm ID ø 9.92mm Qty 1 pcs | | | |
|  | Part No. | 520231 | Ref. No. | — |
| | nut thread M10x1 H 6mm WS 14 zinc-coated steel Qty 1 pcs | | | |
|  | Part No. | 521129 | Ref. No. | — |
| | nut thread M10 H 6mm SS WS 17 Qty 1 pcs DIN/ISO DIN 439 | | | |





| | | | |
|---|--|-----------------|---------------------------|
|  | | | |
| Part No. | 416521 | Ref. No. | 537021100 |
| description | heating element 2000W 230V heating circuits 1 L 300mm ϕ 30mm thread 1" flange ϕ 55mm cable length 180mm connection cable immersion heater pasta cooker flange width 48mm | | |
| For models: | CP-74ET, CP-74ETX, CP-78ET, CP-78ETX, CPD-64ET | | |
| accessories for | 416521 | | |
|  | Part No. | 520233 | Ref. No. — |
| | nut thread 1" H 6mm brass WS 47 Qty 1 pcs | | |
|  | Part No. | 532484 | Ref. No. 536009700 |
| | O-ring silicone thickness 2.62mm ID ϕ 37.77mm Qty 1 pcs | | |

| | | | |
|---|---|-----------------|---------------------------|
|  | | | |
| Part No. | 416522 | Ref. No. | 537021200 |
| description | heating element 2000W 230V heating circuits 1 L 300mm W 55mm connection cable thread 1" ϕ 30mm flange ϕ 55mm flange width 48mm thermostat sleeves ϕ 6mm length thermostat sleeves 196mm cable length 210mm number of thermostat sleeves 1 pasta cooker thermostat sleeve not clinging immersion heater | | |
| For models: | CP-74ET, CP-74ETX, CP-78ET, CP-78ETX, CPD-64ET | | |
| spare parts for | 416522 | | |
|  | Part No. | 532484 | Ref. No. 536009700 |
| | O-ring silicone thickness 2.62mm ID ϕ 37.77mm Qty 1 pcs | | |
| accessories for | 416522 | | |
|  | Part No. | 520233 | Ref. No. — |
| | nut thread 1" H 6mm brass WS 47 Qty 1 pcs | | |

| | | | |
|---|---|-----------------|-------------------|
|  | | | |
| Part No. | 415701 | Ref. No. | 537004900 |
| description | heating element 2000W 230V L 276mm W 140mm H 20mm 2 hole fixing connection male faston 6.3mm thread M10x1 tube ϕ 6.5mm W1 140mm mounting distance 133mm immersion heater | | |
| For models: | CP-4ET, CP-61EM, CP-62ET, CP-6ET | | |
| accessories for | 415701 | | |
|  | Part No. | 510416 | Ref. No. — |
| | flat gasket fibre ED ϕ 19mm ID ϕ 10.5mm thickness 1.5mm for thread M10 Qty 1 pcs | | |
|  | Part No. | 510893 | Ref. No. — |
| | O-ring EPDM thickness 2.62mm ID ϕ 9.92mm Qty 1 pcs | | |
|  | Part No. | 520231 | Ref. No. — |
| | nut thread M10x1 H 6mm WS 14 zinc-coated steel Qty 1 pcs | | |
|  | Part No. | 521129 | Ref. No. — |
| | nut thread M10 H 6mm SS WS 17 Qty 1 pcs DIN/ISO DIN 439 | | |

| | | | |
|--|---|-----------------|-------------------|
|  | | | |
| Part No. | 418073 | Ref. No. | 537024200 |
| description | heating element 3500W 230V heating circuits 1 L 475mm flange with thread thread 1" ϕ 30mm flange ϕ 55mm flange width 48mm cable length 300mm immersion heater | | |
| For models: | CP-94ET, CP-94ETX, CP-98ET, CP-98ETX, CPB-98ET | | |
| accessories for | 418073 | | |
|  | Part No. | 510404 | Ref. No. — |
| | flat gasket fibre ED ϕ 44mm ID ϕ 34mm thickness 2mm Qty 1 pcs | | |
|  | Part No. | 528018 | Ref. No. — |
| | flat gasket PTFE ED ϕ 41mm ID ϕ 33mm thickness 3mm size 1" Qty 1 pcs | | |

| | | | |
|--|---|-----------------|-----------|
|  | | | |
| Part No. | 418074 | Ref. No. | 537024300 |
| description | heating element 3500W 230V heating circuits 1 L 475mm screw mounting connection cable thread 1" ϕ 30mm flange ϕ 55mm flange width 48mm thermostat sleeves ϕ 6.5mm length thermostat sleeves 215mm cable length 300mm number of thermostat sleeves 1 thermostat sleeve eccentric, non clinging immersion heater | | |
| For models: | CP-94ET, CP-94ETX, CP-98ET, CP-98ETX, CPB-98ET | | |

| | | | |
|---|---|-----------------|-----------|
|  | | | |
| Part No. | 415772 | Ref. No. | 537004200 |
| description | heating element 823W 230V L 276mm W 108mm H 20mm 2 hole fixing connection male faston 6.3mm thread M10x1 tube ϕ 6.3mm connection length 22mm dry heating element | | |
| For models: | BM-61EM, BM-62EM, BM-62ET, BS-4EM, BS-4EMX, BS-61EM, BS-62EM, BS-74EM, BS-94EM, BSD-64EM, BST-64EM, BST-74EM, BST-94EM, CP-61EM, CP-62ET, SV-11, SV-113, SV-12, SV-123, SV-13 | | |

heating elements for pizza ovens

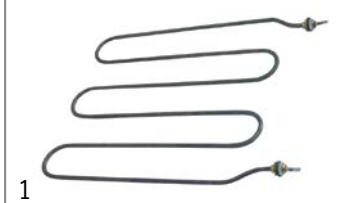



| | | | |
|--|---|-----------------|-----------|
|  | | | |
| Part No. | 416644 | Ref. No. | 537003200 |
| description | heating element 750W 230V L 373mm W 327mm L1 25mm L2 35mm L3 310mm W1 25mm W2 282mm thread M12x1 mounting distance 275mm connection length 30mm connection male faston 6.3mm tube ϕ 6.3mm heating circuits 1 dry heating element 2 hole fixing | | |
| For models: | RV, RV-IPERLOTUS, TS-1 | | |



heating elements for rechauds







1

| | | | |
|---|--|-----------------|-------------------|
| Part No. | 415708 | Ref. No. | 537004700 |
| description | heating element 1400W 230V heating circuits 1 L 338mm W 215mm H 85mm L2 338mm mounting distance 209mm thread 1/4" tube ø 6.3mm connection male faston 6.3mm 2 hole fixing dry heating element connection length 34mm | | |
| accessories for | 415708 | | |
|  | Part No. | 361182 | Ref. No. — |
| | nut thread 1/4" H 5mm nickel-plated brass WS 17 Qty 1 pcs | | |
|  | Part No. | 510417 | Ref. No. — |
| | flat gasket fibre ED ø 20mm ID ø 14mm thickness 2mm Qty 1 pcs | | |
|  | Part No. | 520228 | Ref. No. — |
| | tooth lock washer ID ø 15.3mm ED ø 24mm steel Qty 1 pcs for thread M14 | | |
|  | Part No. | 550262 | Ref. No. — |
| | flat gasket copper ED ø 20mm ID ø 14mm thickness 2mm | | |





1

| | | | |
|---|---|-----------------|-------------------|
| Part No. | 415707 | Ref. No. | 537004600 |
| description | heating element 700W 230V L 135mm W 208mm H 88mm L1 5mm L2 140mm mounting distance 205mm thread M12x1 tube ø 6.3mm connection male faston 6.3mm 2 hole fixing dry heating element | | |
| accessories for | 415707 | | |
|  | Part No. | 520229 | Ref. No. — |
| | nut thread M12x1 H 4mm WS 16 zinc-coated steel Qty 1 pcs | | |
|  | Part No. | 521110 | Ref. No. — |
| | flat gasket fibre ED ø 20mm ID ø 13mm thickness 2mm Qty 1 pcs | | |
|  | Part No. | 521131 | Ref. No. — |
| | nut thread M12x1 H 3.5mm WS 17 SS Qty 1 pcs | | |
|  | Part No. | 528110 | Ref. No. — |
| | O-ring EPDM thickness 2.62mm ID ø 12.37mm Qty 1 pcs | | |

heating elements for chargrills



1

| | | | |
|---|--|-----------------|-------------------|
| Part No. | 415770 | Ref. No. | 537010700 |
| description | heating element 2000W 230V L 420mm W 90mm H 8.5mm 2 hole fixing thread M12x1 mounting distance 71mm connection male faston 6.3mm dry heating element tube ø 8.5mm heating circuits 1 | | |
| For models: | CW-4ET, CW-61ET, CW-62ET, CW-6ET | | |
| spare parts for | 415770 | | |
|  | Part No. | 520229 | Ref. No. — |
| | nut thread M12x1 H 4mm WS 16 zinc-coated steel Qty 1 pcs | | |
|  | Part No. | 521110 | Ref. No. — |
| | flat gasket fibre ED ø 20mm ID ø 13mm thickness 2mm Qty 1 pcs | | |
|  | Part No. | 521131 | Ref. No. — |
| | nut thread M12x1 H 3.5mm WS 17 SS Qty 1 pcs | | |







1

| | | | |
|--------------------|--|-----------------|-----------|
| Part No. | 416520 | Ref. No. | 537022000 |
| description | heating element 2000W 230V L 450mm W 95mm H 8.5mm thread M12x1 mounting distance 86.5mm connection male faston 6.3mm dry heating element tube ø 8.5mm heating circuits 1 connection length 24mm connection distance 97mm | | |
| For models: | CW-74ET, CW-74ETX, CW-78ET, CW-78ETX, CWT-74ET, CWT-74ETX, CWT-78ET, CWT-78ETX | | |



1

| | | | |
|---|--|-----------------|-------------------|
| Part No. | 418070 | Ref. No. | 537029801 |
| description | heating element 2600W 230V L 615mm W 85mm chargrill 2 hole fixing thread M12x1 mounting distance 80mm connection male faston 6.3mm dry heating element tube ø 8.5mm heating circuits 1 | | |
| For models: | CW-94ET, CW-98ET, CWT-94ET, CWT-98ET | | |
| accessories for | 418070 | | |
|  | Part No. | 520229 | Ref. No. — |
| | nut thread M12x1 H 4mm WS 16 zinc-coated steel Qty 1 pcs | | |
|  | Part No. | 521110 | Ref. No. — |
| | flat gasket fibre ED ø 20mm ID ø 13mm thickness 2mm Qty 1 pcs | | |
|  | Part No. | 521131 | Ref. No. — |
| | nut thread M12x1 H 3.5mm WS 17 SS Qty 1 pcs | | |
|  | Part No. | 528110 | Ref. No. — |
| | O-ring EPDM thickness 2.62mm ID ø 12.37mm Qty 1 pcs | | |



heating elements for salamanders/toast-





| | | | |
|--------------------|--|-----------------|-----------|
| Part No. | 416647 | Ref. No. | 537020500 |
| description | heating element 2000W 230V L 225mm W 208mm 2 hole fixing thread 1/4" mounting distance 198mm connection M4 dry heating element tube ø 8.5mm heating circuits 1 H 8.5mm | | |

| | |
|------------------------|---|
| For models: | SL-600, SL-600EM, SL-600EMX, SL-600ET, SL-600ETX, SL-600X |
| spare parts for | 416647 |





| | | | |
|--------------------|---|-----------------|---|
| Part No. | 510417 | Ref. No. | — |
| description | flat gasket fibre ED ø 20mm ID ø 14mm thickness 2mm Qty 1 pcs | | |

| | | | | |
|--|--|--------|-----------------|---|
| accessories for | 416647 | | | |
|  | Part No. | 361182 | Ref. No. | — |
| description | nut thread 1/4" H 5mm nickel-plated brass WS 17 Qty 1 pcs | | | |
|  | Part No. | 520228 | Ref. No. | — |
| description | tooth lock washer ID ø 15.3mm ED ø 24mm steel Qty 1 pcs for thread M14 | | | |
|  | Part No. | 550262 | Ref. No. | — |
| description | flat gasket copper ED ø 20mm ID ø 14mm thickness 2mm | | | |



| | | | |
|--------------------|---|-----------------|-----------|
| Part No. | 416646 | Ref. No. | 537020600 |
| description | heating element 2000W 230V L 290mm W 216mm 2 hole fixing thread M12x1 mounting distance 195mm connection male faston 6.3mm dry heating element tube ø 8.5mm heating circuits 1 connection length 35mm H 8.5mm | | |
| For models: | SA-400EM, SA-400EMX, SA-600EM, SA-600EMX, SA-600ET, SA-600ETX | | |



| | | | | |
|---|--|-----------------|-----------------|---|
| Part No. | 416643 | Ref. No. | 537004500 | |
| description | heating element 850W 230V L 310mm W 90mm thread 1/4" mounting distance 84mm connection male faston 6.3mm tube ø 6.3mm heating circuits 1 dry heating element 2 hole fixing | | | |
| For models: | TS-3, TS-6 | | | |
| accessories for | 416643 | | | |
|  | Part No. | 361182 | Ref. No. | — |
| description | nut thread 1/4" H 5mm nickel-plated brass WS 17 Qty 1 pcs | | | |
|  | Part No. | 510417 | Ref. No. | — |
| description | flat gasket fibre ED ø 20mm ID ø 14mm thickness 2mm Qty 1 pcs | | | |
|  | Part No. | 520228 | Ref. No. | — |
| description | tooth lock washer ID ø 15.3mm ED ø 24mm steel Qty 1 pcs for thread M14 | | | |

| | | | | |
|---|--|--------|-----------------|---|
| accessories for | 416643 | | | |
|  | Part No. | 550262 | Ref. No. | — |
| description | flat gasket copper ED ø 20mm ID ø 14mm thickness 2mm | | | |



heating elements for heating bridges





| | | | |
|--------------------|---|-----------------|-----------|
| Part No. | 416523 | Ref. No. | 537004400 |
| description | heating element 320W 230V L 316mm W 96mm connection male faston 6.3mm tube ø 6.3mm 2 hole fixing thread M12x1.5 dry heating element heated bridge mounting distance 90mm chip scuttle | | |
| For models: | RI-4EM, RI-4EMX, RI-62EM | | |

heating cartridges





| | | | | |
|---|--|-----------------|-----------------|-----------|
| Part No. | 416521 | Ref. No. | 537021100 | |
| description | heating element 2000W 230V heating circuits 1 L 300mm ø 30mm thread 1" flange ø 55mm cable length 180mm connection cable immersion heater pasta cooker flange width 48mm | | | |
| For models: | CP-74ET, CP-74ETX, CP-78ET, CP-78ETX, CPD-64ET | | | |
| accessories for | 416521 | | | |
|  | Part No. | 520233 | Ref. No. | — |
| description | nut thread 1" H 6mm brass WS 47 Qty 1 pcs | | | |
|  | Part No. | 532484 | Ref. No. | 536009700 |
| description | O-ring silicone thickness 2.62mm ID ø 37.77mm Qty 1 pcs | | | |



| | | | | |
|---|--|-----------------|-----------------|-----------|
| Part No. | 416522 | Ref. No. | 537021200 | |
| description | heating element 2000W 230V heating circuits 1 L 300mm W 55mm connection cable thread 1" ø 30mm flange ø 55mm flange width 48mm thermostat sleeves ø 6mm length thermostat sleeves 196mm cable length 210mm number of thermostat sleeves 1 pasta cooker thermostat sleeve not clinging immersion heater | | | |
| For models: | CP-74ET, CP-74ETX, CP-78ET, CP-78ETX, CPD-64ET | | | |
| spare parts for | 416522 | | | |
|  | Part No. | 532484 | Ref. No. | 536009700 |
| description | O-ring silicone thickness 2.62mm ID ø 37.77mm Qty 1 pcs | | | |
| accessories for | 416522 | | | |
|  | Part No. | 520233 | Ref. No. | — |
| description | nut thread 1" H 6mm brass WS 47 Qty 1 pcs | | | |



1 

| | | | |
|---|---|-----------------|-------------------|
| Part No. | 418073 | Ref. No. | 537024200 |
| description | heating element 3500W 230V heating circuits 1 L 475mm flange with thread thread 1" ø 30mm flange ø 55mm flange width 48mm cable length 300mm immersion heater | | |
| For models: | CP-94ET, CP-94ETX, CP-98ET, CP-98ETX, CPB-98ET | | |
| accessories for | 418073 | | |
|  | Part No. | 510404 | Ref. No. — |
| | flat gasket fibre ED ø 44mm ID ø 34mm thickness 2mm Qty 1 pcs | | |
|  | Part No. | 528018 | Ref. No. — |
| | flat gasket PTFE ED ø 41mm ID ø 33mm thickness 3mm size 1" Qty 1 pcs | | |

1 

| | | | |
|--------------------|--|-----------------|-----------|
| Part No. | 418074 | Ref. No. | 537024300 |
| description | heating element 3500W 230V heating circuits 1 L 475mm screw mounting connection cable thread 1" ø 30mm flange ø 55mm flange width 48mm thermostat sleeves ø 6.5mm length thermostat sleeves 215mm cable length 300mm number of thermostat sleeves 1 thermostat sleeve eccentric, non clinging immersion heater | | |
| For models: | CP-94ET, CP-94ETX, CP-98ET, CP-98ETX, CPB-98ET | | |

ceramic heaters

245x60mm

1 

| | | | |
|---|---|-----------------|-------------------|
| Part No. | 415103 | Ref. No. | 537015200 |
| description | ceramic emitter 650W 230V cable beaded cord L 245mm W 60mm H 35mm | | |
| For models: | BS-74EM, BS-94EM, BSD-64EM, BST-64EM, BST-74EM, BST-94EM | | |
| spare parts for | 415103 | | |
|  | Part No. | 415109 | Ref. No. — |
| | spring clip | | |
| accessories for | 415103 | | |
|  | Part No. | 415110 | Ref. No. — |
| | reflector L 245mm W 95mm H 31mm thickness 0.75mm hole ø 15x40mm | | |



immersion heating elements

with round flange ø57.5mm

1 

| | | | |
|---|---|-----------------|-------------------|
| Part No. | 418040 | Ref. No. | 10062 |
| description | heating element 6000W 230V heating circuits 3 L 385mm W 32mm H 42mm tube ø 6.3mm thermostat sleeves ø 7mm length thermostat sleeves 275mm number of thermostat sleeves 1 thermostat sleeve clinging connection male faston 6.3mm connection length 27mm immersion heater round flange mounting ø 57.5mm | | |
| accessories for | 418040 | | |
|  | Part No. | 550002 | Ref. No. — |
| | tension strap H 10mm L 21mm W 10mm hole ø 6.5mm for heating element | | |

1 

| | | | |
|---|---|-----------------|-------------------|
| Part No. | 418041 | Ref. No. | 16600 |
| description | heating element 8000W 230V heating circuits 3 L 470mm W 42mm H 31mm tube ø 6.4mm thermostat sleeves ø 7mm length thermostat sleeves 278mm number of thermostat sleeves 1 thermostat sleeve clinging connection male faston 6.3mm connection length 27mm immersion heater round flange mounting ø 57.5mm | | |
| spare parts for | 418041 | | |
|  | Part No. | 510409 | Ref. No. — |
| | O-ring EPDM thickness 5.34mm ID ø 56.52mm Qty 1 pcs | | |
| accessories for | 418041 | | |
|  | Part No. | 550002 | Ref. No. — |
| | tension strap H 10mm L 21mm W 10mm hole ø 6.5mm for heating element | | |

heating elements for convection

1 

| | | | |
|---|---|-----------------|-------------------|
| Part No. | 415777 | Ref. No. | 537006500 |
| description | heating element 2000W 230V heating circuits 1 ID ø 178mm ED ø 190mm L 245mm H 32mm L1 50mm W1 31mm H1 3mm H2 25mm flange length 70mm flange width 22mm hole distance 56mm connection male faston 6.3mm connection length 39mm tube ø 6.3mm convection heating element hole ø 5mm rectangular flange | | |
| For models: | CF-62EM, CF-62EM-A, CF-62ET, CF-62ET-A, CF-62GEM, CF-62GEM-A, CFC-62EM, CFC-62ET | | |
| spare parts for | 415777 | | |
|  | Part No. | 510368 | Ref. No. — |
| | gasket L 70mm W 23.5mm hole ø 5mm hole distance 56mm FIBER thickness 2mm for heating element | | |





| | | | |
|---|--|-----------------|------------------------|
|  | | | |
| 1 | | | |
| Part No. | 420532 | Ref. No. | 040001201 537019000 |
| description | heating element 3000W 230V heating circuits 1 ID ø 186mm ED ø 199mm L 250mm H 45mm L1 42mm W1 30mm H1 10mm H2 30mm flange length 70mm flange width 22mm hole distance 56mm connection 6.3x0.8 connection length 22mm tube ø 6.5mm convection heating element hole ø 5mm rectangular flange | | |
| For models: | CF4-8ET, CF4-8GEM, CF-62EM, CF-62EM-A, CF-62ET, CF-62ET-A, CF-62GEM, CF-62GEM-A, CFC4-8ET, CFC-62EM, CFC-62ET, CFM-10EM, CFM-10EM-6, CFM-10EM-A, CFM-10ET, CFM-10ET-6, CFM-10ET-A, CFM-10GEM, CFM-10GEM-6, CFM-10GEM6-A, CFM-10GEM-A, CFM2-68GEM, CFM3-612GEMV, CFM4-66ET, CFM4-66GEM, CFM4-68ET, CFM4-68GEM, CFM6-610ET, CFM6-610GEM, CFM-8EM, CFM-8EM-A, CFM-8ET, CFM-8ET-A, CFM-8GEM, CFM-8GEM-A, CFMC4-66ET, MFM-610EM, MFM-68EM, TPFM4-610GEM | | |

| | | | |
|---|---|-----------------|----------|
|  | | | |
| 1 | | | |
| Part No. | 418019 | Ref. No. | C3616-00 |
| description | heating element 3900W 230V heating circuits 3 ID ø 206mm ED ø 218mm L 275mm H 40mm L1 48mm W1 104mm H1 10mm H2 24mm flange length 142mm flange width 25mm hole distance 62.5mm connection M4 connection length 62mm tube ø 6mm convection heating element hole ø 6.5mm rectangular flange | | |

| | | | |
|---|--|-----------------|------------|
|  | | | |
| 1 | | | |
| Part No. | 418020 | Ref. No. | RRC3090-00 |
| description | heating element 7800W 230V heating circuits 3 ID ø 264mm ED ø 277mm L 315mm H 100mm L1 35mm W1 101mm H1 29mm H2 67mm flange length 142mm flange width 23mm hole distance 63mm connection M4 connection length 75mm tube ø 6.3mm convection heating element mounting thread M4 rectangular flange | | |

radiation heaters

| | | | |
|---|--|-----------------|-----------|
|  | | | |
| 1 | | | |
| Part No. | 490153 | Ref. No. | 537026400 |
| description | radiation heater octagonal 3400W 230V L 300mm W 300mm heating circuits 2 H 30mm with heating coil energy regulation with temperature signalization connections 4+2 connection type cable cable length 900mm AD | | |
| For models: | CFC4-98ET, PCC-94ET, PCC-98ET | | |

| | | | |
|--|---|-----------------|-----------|
| 1-circuit | | | |
|  | | | |
| 1 | | | |
| Part No. | 490024 | Ref. No. | 537014500 |
| description | radiation heater ø 165mm 1200W 230V heating circuits 1 energy regulation with temperature signalization with heating coil connections 2+2 connection type male faston 6.3mm EGO | | |
| For models: | CFC-62EM, CFC-62ET, PCC-61EM, PCC-62EM, PCC-62ET | | |

| | | | |
|--|--|-----------------|-----------|
|  | | | |
| 1 | | | |
| Part No. | 490116 | Ref. No. | 537014501 |
| description | radiation heater ø 165mm 1200W 230V heating circuits 1 H 33mm 7-position control with temperature signalization with ribbon heater connections 2+2 connection type male faston 6.3mm CERAMASPEED | | |
| For models: | CFC-62EM, CFC-62ET, CFMC4-66ET, PCC-61EM, PCC-62EM, PCC-62ET, PCCT-63ET, PCCT-63ETX, PCCT-66ET, PCCT-66ETX | | |

| | | | |
|--|--|-----------------|-----------|
|  | | | |
| 1 | | | |
| Part No. | 490042 | Ref. No. | 537012900 |
| description | radiation heater ø 200mm 1800W 230V heating circuits 1 energy regulation with temperature signalization with ribbon heater connections 2+2 connection type male faston 6.3mm EGO | | |
| For models: | CFC4-8ET, PCC-4EM, PCC-4EMX, PCC-4ET, PCC-6EM, PCC-6EMX, PCC-6ET, PCC-8EMX, PCC-8ET | | |

| | | | |
|--|---|-----------------|------------------------|
| 2-circuit | | | |
|  | | | |
| 1 | | | |
| Part No. | 490119 | Ref. No. | 537013000 537014600 |
| description | radiation heater ø 200mm 1700W 230V heating circuits 2 energy regulation with temperature signalization partial power 600W with ribbon heater connections 3+2 connection type male faston 6.3mm EGO | | |
| For models: | CFC-62EM, CFC-62ET, PCC-4EM, PCC-4EMX, PCC-4ET, PCC-61EM, PCC-62EM, PCC-62ET, PCC-6EM, PCC-6EMX, PCC-6ET | | |

1

| | | | |
|--------------------|---|-----------------|-----------|
| Part No. | 490114 | Ref. No. | 537015301 |
| description | radiation heater ø 230mm 2200W 230V heating circuits 2 energy regulation with temperature signalization partial power 750W with ribbon heater connections 2+2 connection type male faston 6.3mm CERAMASPEED | | |
| For models: | CFC-62EM, CFC-62ET, PCC-4EM, PCC-4EMX, PCC-4ET, PCC-61EM, PCC-62EM, PCC-62ET, PCC-6EM, PCC-6EMX, PCC-6ET | | |



1

| | | | |
|--------------------|---|-----------------|-----------|
| Part No. | 490044 | Ref. No. | 537015300 |
| description | radiation heater ø 230mm 2200W 230V heating circuits 2 energy regulation with temperature signalization partial power 750W with ribbon heater connections 3+2 connection type male faston 6.3mm EGO | | |
| For models: | CFC4-8ET, PCC-8EMX, PCC-8ET | | |



1

| | | | |
|--------------------|--|-----------------|-----------|
| Part No. | 490118 | Ref. No. | 537019400 |
| description | radiation heater ø 250mm 2500W heating circuits 2 partial power 1000W | | |
| For models: | CFC4-78ET, CFC4-78ETX, CFC4-8ET, CFVC4-78ET, PCC-74ET, PCC-78ET, PCC-8EMX, PCC-8ET, PCCD-64ET, PCCD-68ET, PCCT-74ET, PCCT-78ET | | |

foil heating elements



1

| | | | |
|--------------------|--|-----------------|-----------|
| Part No. | 415980 | Ref. No. | 537011900 |
| description | foil heating element L 375mm W 275mm 650W 230V t.max. 175°C without temperature limiter silicone cable length 250mm thickness 1mm | | |
| For models: | BM-10EM, BM-10EMX, BM-4EM, BM-4EMX, BM-74EM, BM-74ET, BM-78EM, BM-78ET, BM-8EM, BM-8EMX, BMD-64EM, BMT-74EM, BMT-78EM, BS-4EM, BS-4EMX | | |



1

| | | | |
|--------------------|---|-----------------|-----------|
| Part No. | 415981 | Ref. No. | 537012000 |
| description | foil heating element L 460mm W 375mm 1100W 230V t.max. 175°C silicone cable length 500mm thickness 1mm heating circuits 1 | | |
| For models: | BM-6EM, BM-6EMX | | |



1

| | | | |
|--------------------|---|-----------------|-----------|
| Part No. | 418075 | Ref. No. | 537026000 |
| description | foil heating element L 570mm W 230mm 1500W 230V probe ø 6mm without temperature limiter silicone cable length 600mm thickness 1mm | | |
| For models: | BM-94EM, BM-98EM, BMD-84EM, BMT-94EM, BMT-98EM | | |

hot plates

square & rectangular

with radiused edge





1

| | | | |
|--------------------|---|-----------------|------------------------|
| Part No. | 490066 ¹ | Ref. No. | 537017000 537017700 |
| description | hot plate dimensions 220x220mm 2600W 230V with spill ring connection 4 screw clamps protector yes square | | |
| For models: | BR-6ET, BR-6ETX, CF4-68ET, CF4-68ETX, CF4-78ET, CF4-78ETX, CF6-610ET, CF6-610ETX, CF6-712ET, CF6-712ETV, CF6-712ETVX, CF6-712ETX, CFM4-66ET, CFM4-68ET, CFM6-610ET, CFQ4-78ET, CFQ4-78ETX, CFQ6-712ET, CFQ6-712ETV, CFQ6-712ETVX, CFQ6-712ETX, CFV4-78ET, CFV6-712ETV, CFVQ4-78ET, CFVQ6-712ETV, CP-4ETX, CP-6ETX, CW-4ETX, CW-6ETX, FQ-4ETX, FQ-6ETX, FTL-4ETX, FTL-6ETX, FTL-8ETX, FTLR-6ETX, FTLR-8ETX, FTR-4ETX, FTR-6ETX, PC-10ETX, PC-4ETX, PC-6ETX, PC-712ET, PC-712ETX, PC-74ET, PC-74ETX, PC-78ET, PC-78ETX, PC-8ETX, PCD-64ET, PCD-68ET...(Other models you can see in the webshop) | | |

¹incl. protector



| | | | |
|---|--|-----------------|-----------|
|  | | | |
|  | | | |
| 1 | | | |
| Part No. | 490068 ¹ | Ref. No. | 537022700 |
| description | hot plate dimensions 220x220mm 2600W 400V with spill ring connection 4 screw clamps protector yes square | | |
| For models: | CF4-68ET, CF4-68ETX, CF4-78ET, CF4-78ETX, CF6-610ET, CF6-610ETX, CF6-712ET, CF6-712ETV, CF6-712ETVX, CF6-712ETX, CFM4-66ET, CFM4-68ET, CFM6-610ET, CFQ4-78ET, CFQ4-78ETX, CFQ6-712ET, CFQ6-712ETV, CFQ6-712ETVX, CFQ6-712ETX, CFV4-78ET, CFV6-712ETV, CFVQ4-78ET, CFVQ6-712ETV, PC-712ET, PC-712ETX, PC-74ET, PC-74ETX, PC-78ET, PC-78ETX, PCQ-712ET, PCQ-712ETX, PCQ-74ET, PCQ-74ETX, PCQ-78ET, PCQ-78ETX, PCQT-712ET, PCQT-712ETX, PCQT-74ET, PCQT-78ET, PCT-63ET, PCT-66ET, PCT-712ET, PCT-712ETX, PCT-74ET, PCT-74ETX, PCT-78ET, PCT-78ETX | | |

¹incl. protector

| | | | |
|---|--|-----------------|-----------|
|  | | | |
|  | | | |
| 1 | | | |
| Part No. | 490071 ¹ | Ref. No. | 537017100 |
| description | hot plate dimensions 300x300mm 4000W 230V with spill ring connection 4 screw clamps protector yes square | | |
| For models: | CF4-98ET, CF4-98ETX, CF6-912ET, CF6-912ETV, CF6-912ETVX, CF8-916ET, CF8-916ETV, CFQ4-98ET, CFQ4-98ETX, CFQ6-912ET, CFQ6-912ETV, CFQ6-912ETVX, CFQ8-916ET, CFQ8-916ETV, CFQ9-916ET, CFV4-98ET, CFV6-912ET, CFV6-912ETV, CFVQ4-98ET, CFVQ6-912ET, CFVQ6-912ETV, PC-912ET, PC-912ETX, PC-916ET, PC-916ETX, PC-94ET, PC-94ETX, PC-98ET, PC-98ETX, PCQ-912ET, PCQ-916ET, PCQ-94ET, PCQ-98ET, PCQD-84ET, PCQD-88ET, PCQT-912ET, PCQT-916ET, PCQT-94ET, PCQT-94ETX, PCQT-98ET, PCQT-98ETX, PCT-912ET, PCT-912ETX, PCT-916ET, PCT-916ETX, PCT-94ET, PCT-94ETX, PCT-98ET, PCT-98ETX | | |

¹incl. protector



round



with radiused edge



for domestic and commercial kitchens

| | | | |
|---|--|-----------------|-----------|
|  | | | |
|  | | | |
| 1 | | | |
| Part No. | 490010 | Ref. No. | 537002100 |
| description | hot plate ø 145mm 1000W 230V connection 4 screw clamps with 8mm spill ring | | |
| For models: | CF-10EM, CF-10EM-6, CF-10EM-A, CF-10ET, CF-10ET-6, CF-10ET-A, CF4-68ET, CF-62EM, CF-62EM-A, CF-62ET, CF-62ET-A, CF6-610ET, CF-8EM, CF-8EM-A, CF-8ET, CF-8ET-A, CFM-10EM, CFM-10EM-6, CFM-10EM-A, CFM-10ET, CFM-10ET-6, CFM-10ET-A, CFM4-66ET, CFM4-68ET, CFM6-610ET, CFM-8EM, CFM-8EM-A, CFM-8ET, CFM-8ET-A, PC-61EM, PC-62EM, PC-62ET, PCT-63ET, PCT-66ET | | |

| | | | |
|--|--|-----------------|-----------|
|  | | | |
|  | | | |
| 1 | | | |
| Part No. | 490014 | Ref. No. | 537002200 |
| description | hot plate ø 180mm 1500W 230V connection 4 screw clamps with 8mm spill ring | | |
| For models: | CF-10EM, CF-10EM-6, CF-10EM-A, CF-10ET, CF-10ET-6, CF-10ET-A, CF-62EM, CF-62EM-A, CF-62ET, CF-62ET-A, CF-8EM, CF-8EM-A, CF-8ET, CF-8ET-A, CFM-10EM, CFM-10EM-6, CFM-10EM-A, CFM-10ET, CFM-10ET-6, CFM-10ET-A, CFM-8EM, CFM-8EM-A, CFM-8ET, CFM-8ET-A, PC-10ET, PC-61EM, PC-62EM, PC-62ET, PC-6EM, PC-6ET | | |

| | | | |
|--|--|-----------------|-----------|
|  | | | |
|  | | | |
| 1 | | | |
| Part No. | 490016 | Ref. No. | 537019800 |
| description | hot plate ø 180mm 2000W 230V connection 4 screw clamps with 8mm spill ring | | |
| For models: | CF4-68ET, CF4-68ETX, CF6-610ET, CF6-610ETX, CFM4-66ET, CFM4-68ET, CFM6-610ET, PCT-63ET, PCT-66ET | | |

| | | | |
|---|---|-----------------|-----------|
|  | | | |
|  | | | |
| 1 | | | |
| Part No. | 490018 | Ref. No. | 537002300 |
| description | hot plate ø 220mm 2000W 230V connection 4 screw clamps with 8mm spill ring | | |
| For models: | CF-10EM, CF-10EM-A, CF-10ET, CF-10ET-A, CF4-8ET, CF4-8ETS, CF-8EM, CF-8EM-A, CF-8ET, CF-8ET-A, CFM-10EM, CFM-10EM-A, CFM-10ET, CFM-10ET-A, CFM-8EM, CFM-8EM-A, CFM-8ET, CFM-8ET-A, CFPB6-79G, PC-10ET, PC-4EM, PC-4ET, PC-6EM, PC-6ET, PC-8ET | | |

| | | | |
|--|---|-----------------|-------------------|
|  | | | |
|  | | | |
| 1 | | | |
| Part No. | 490020 | Ref. No. | 537019900 |
| description | hot plate ø 220mm 2600W 230V connection 4 screw clamps with 8mm spill ring | | |
| For models: | CF4-68ET, CF4-68ETX, CF4-78ET, CF4-78ETX, CF6-610ET, CF6-610ETX, CF6-712ET, CF6-712ETV, CF6-712ETVX, CF6-712ETX, CFM4-66ET, CFM4-68ET, CFM6-610ET, CFQ4-78ET, CFQ4-78ETX, CFQ6-712ET, CFQ6-712ETV, CFQ6-712ETVX, CFQ6-712ETX, CFV4-78ET, CFV6-712ETV, CFVQ4-78ET, CFVQ6-712ETV, PC-712ET, PC-712ETX, PC-74ET, PC-74ETX, PC-78ET, PC-78ETX, PCD-64ET, PCD-68ET, PCQ-712ET, PCQ-712ETX, PCQ-74ET, PCQ-74ETX, PCQ-78ET, PCQ-78ETX, PCQD-64ET, PCQD-68ET, PCQT-712ET, PCQT-712ETX, PCQT-74ET, PCQT-78ET, PCT-63ET, PCT-66ET, PCT-712ET, PCT-712ETX, PCT-74ET, PCT-74ETX, PCT-78ET...(Other models you can see in the webshop) | | |
| accessories for | 490020 | | |
|  | Part No. | 550796 | Ref. No. — |
| | fixing plate for hot plate ø220mm | | |





| | | | |
|---|--|-----------------|-----------|
|  | | | |
| 1 | | | |
| Part No. | 490062 | Ref. No. | 537017400 |
| description | hot plate ø 300mm 3500W 220V connection 4 screw clamps with 8mm spill ring | | |
| For models: | CF4-98ET, CF4-98ETX, CF6-912ET, CF6-912ETV, CF6-912ETVX, CF8-916ET, CF8-916ETV, CFQ4-98ET, CFQ4-98ETX, CFQ6-912ET, CFQ6-912ETV, CFQ6-912ETVX, CFQ8-916ET, CFQ8-916ETV, CFQ9-916ET, CFV4-98ET, CFV6-912ET, CFV6-912ETV, CFVQ4-98ET, CFVQ6-912ET, CFVQ6-912ETV, PC-912ET, PC-912ETX, PC-916ET, PC-916ETX, PC-94ET, PC-94ETX, PC-98ET, PC-98ETX, PCQ-912ET, PCQ-916ET, PCQ-94ET, PCQ-98ET, PCQT-912ET, PCQT-916ET, PCQT-94ET, PCQT-94ETX, PCQT-98ET, PCQT-98ETX, PCT-912ET, PCT-912ETX, PCT-916ET, PCT-916ETX, PCT-94ET, PCT-94ETX, PCT-98ET, PCT-98ETX | | |

| | | | |
|--|---|-----------------|-----------|
| 2-circuit | | | |
|  | | | |
| 1 | | | |
| Part No. | 380027 | Ref. No. | 537021500 |
| description | energy regulator EGO 230V 13A dual circuit turn direction right shaft ø 6x4.6mm shaft L 23mm mounting thread M4 power release 6-70% no. 50.55021.100 | | |
| For models: | CFC4-78ET, CFC4-78ETX, CFC4-8ET, CFC4-98ET, CFC-62EM, CFC-62ET, CFMC4-66ET, CFVC4-78ET, CFVC4-98ET, PCC-4EM, PCC-4EMX, PCC-4ET, PCC-61EM, PCC-62EM, PCC-62ET, PCC-6EM, PCC-6EMX, PCC-6ET, PCC-74ET, PCC-78ET, PCC-8EMX, PCC-8ET, PCC-94ET, PCC-98ET, PCCD-64ET, PCCD-68ET, PCCT-63ET, PCCT-66ET, PCCT-74ET, PCCT-78ET, PCCT-94ET, PCCT-98ET | | |

energy regulators

EGO

| | | | |
|---|--|-----------------|-----------|
| 1-circuit | | | |
|  | | | |
| 1 | | | |
| Part No. | 380016 | Ref. No. | 537013400 |
| description | energy regulator 230V 12A dual circuit turn direction right with operation switch 1-pole | | |
| For models: | CFC4-8ET, PCC-4EM, PCC-4EMX, PCC-4ET, PCC-6EM, PCC-6EMX, PCC-6ET, PCC-8EMX, PCC-8ET | | |

| | | | |
|---|---|-----------------|---------------------------------|
|  | | | |
| 1 | | | |
| Part No. | 380015 | Ref. No. | 07931 537013300 537020100 |
| description | energy regulator 230V 13A single-circuit turn direction right shaft ø 6x4.6mm shaft L 23mm mounting thread M4 power release 6-100% no. 50.57021.010 | | |
| For models: | CFC4-8ET, CFC-62EM, CFC-62ET, CFMC4-66ET, CWK-74ET, CWK-78ET, CWK-94ET, CWK-98ET, CWKT-64ET, CWKT-68ET, CWKT-74ET, CWKT-78ET, CWKT-94ET, CWKT-98ET, FTC-4EM, FTC-4EMX, FTC-61EM, FTC-61ET, FTC-62EM, FTC-62ET, FTC-6EM, FTC-6EMX, FTC-6ET, FTC-74ET, FTC-78ET, FTC-8EMX, FTC-8ET, FTC-94ET, FTC-98ET, FTCD-64EM, FTCD-66ET, FTCT-64ET, FTCT-66ET, FTCT-74ET, FTCT-78ET, FTCT-94ET, FTCT-98ET, PCC-4EM, PCC-4EMX, PCC-4ET, PCC-61EM, PCC-62EM, PCC-62ET, PCC-6EM, PCC-6EMX, PCC-6ET, PCC-8EMX, PCC-8ET, PC CT-63ET, SA-400EM...(Other models you can see in the webshop) | | |

thermostats

bi-metal thermostats

| | | | |
|---|---|-----------------|-----------|
| safety bi-metal thermostats | | | |
|  | | | |
| 1 | | | |
| Part No. | 390235 | Ref. No. | 537012100 |
| description | bi-metal safety thermostat hole distance 23.8mm switch-off temp. 165°C 1NC 1-pole 16A connection F6.3 2 hole fixing | | |
| For models: | BM-10EM, BM-10EMX, BM-4EM, BM-4EMX, BM-6EM, BM-6EMX, BM-74EM, BM-74ET, BM-78EM, BM-78ET, BM-8EM, BM-8EMX, BM-94EM, BM-98EM, BMD-64EM, BMD-84EM, BMT-63EM, BMT-64EM, BMT-66EM, BMT-74EM, BMT-78EM, BMT-94EM, BMT-98EM, BS-4EM, BS-4EMX, CF4-68ET, CF4-68ETX, CF6-610ET, CF6-610ETX | | |

control and safety thermostats

EGO

control thermostats

55.10/19_ series

| | | | |
|--|--|-----------------|-----------|
|  | | | |
| 1 | | | |
| Part No. | 375001 | Ref. No. | 537012200 |
| description | thermostat t.max. 112°C temperature range 30-110°C 1-pole 1N0 16A probe ø 6mm probe L 130mm capillary pipe 900mm capillary pipe isolated gland nut M9x1 shaft L 23mm shaft position upper rotation 270° | | |
| For models: | BM-10EM, BM-4EM, BM-6EM, BM-74EM, BM-78EM, BM-8EM, BM-94EM, BM-98EM, BMD-64EM, BMD-84EM, BMT-63EM, BMT-64EM, BMT-66EM, BMT-74EM, BMT-78EM, BMT-94EM, BMT-98EM, BS-74EM, BS-94EM, BSD-64EM, BST-64EM, BST-74EM, BST-94EM, CP-61EM, CP-94ET, CP-94ETX, CP-98ET, CP-98ETX, CPB-98ET, FTL-94G, FTL-98G, FTLR-98G, FTR-94G, FTR-98G | | |



| | | | |
|---|--|-----------------|-----------|
|  | | | |
| Part No. | 375198 | Ref. No. | 537037700 |
| description | thermostat t.max. 190°C temperature range 100-190°C 1-pole 1NO 16A probe ø 6mm probe L 130mm capillary pipe 3000mm capillary pipe isolated 2650mm gland nut M9x1 shaft L 23mm shaft position upper rotation 270° probe material SS | | |
| For models: | F18-94G, F2-18-98G, F2-25-98G, F25-94G, F45-78G, F45-78G-AUS, FMPE-20, FMPE-25, FMPE-30, FPE-20, FPE-25 | | |

| | | | |
|--|---|-----------------|-----------|
|  | | | |
| Part No. | 375314 | Ref. No. | 537019100 |
| description | thermostat t.max. 320°C temperature range 50-320°C 1-pole 1NO 16A probe ø 3mm probe L 120mm capillary pipe 1200mm capillary pipe isolatedmm gland nut shaft ø 6x4.6mm shaft L 23mm shaft position upper rotation 270° with 2 probes | | |
| For models: | CF4-8ET, CF4-8GEM, CFC4-8ET, CFM-10EM, CFM-10EM-6, CFM-10EM-A, CFM-10ET, CFM-10ET-6, CFM-10ET-A, CFM-10GEM, CFM-10GEM-6, CFM-10GEM6-A, CFM-10GEM-A, CFM-8EM, CFM-8EM-A, CFM-8ET, CFM-8ET-A, CFM-8GEM, CFM-8GEM-A | | |

| | | | |
|---|--|-----------------|------------------------|
|  | | | |
| Part No. | 390046 | Ref. No. | 537000600 537014300 |
| description | thermostat t.max. 190°C temperature range 104-190°C 1-pole 1NO 16A probe ø 6mm probe L 133mm capillary pipe 870mm capillary pipe isolatedmm gland nut M9x1 shaft ø 6x4.6mm shaft L 23mm shaft position lower rotation 270° probe material SS | | |
| For models: | F10D-64ET, F10D-64ETX, F10T-63EM, F10T-63ET, F10T-63ETX, F13-64EM, F13-64ET, F13-74ET, F13-74ETX, F13T-74E, F13T-74ET, F13T-74ETX, F13T-94ET, F18-74ET, F18-74ETX, F18-94ET, F18-94ETX, F18-94G, F18D-64ET, F2-10D-66ET, F2-10D-66ETX, F2-10T-66EM, F2-10T-66ET, F2-10T-66ETX, F2-13-78ET, F2-13-78ETX, F2-13-98ET, F2-13T-78E, F2-13T-78ET, F2-18-74ET, F2-18-74ETX, F2-18-78ET, F2-18-78ETX, F2-18-98ET, F2-18-98ETX, F2-18-98G, F2-25-98ET, F2-25-98ETX, F2-25-98G, F25-94ET, F25-94G, F2-8-74ET, F2-8-94ET, F2-8D-64ET, F2-8T-74ET, F2-8T-74ETX, F2-8T-94ET, F45-78ET, FE-10...(Other models you can see in the webshop) | | |

| | | | |
|---|--|-----------------|-----------|
|  | | | |
| Part No. | 375232 | Ref. No. | 537001600 |
| description | thermostat t.max. 320°C temperature range 55-320°C 1-pole capillary pipe isolatedmm gland nut | | |
| For models: | BRF-64ET, BRF-74ET, BRF-78ET, BRF-94ET, BRF-98ET, BRFD-64ET, BRT-66ET, BRT-66ETX, CF-10EM, CF-10EM-6, CF-10EM-A, CF-10ET, CF-10ET-6, CF-10ET-A, CF-10GEM, CF-10GEM-6, CF-10GEM6-A, CF-10GEM-A, CF2-58GE, CF2-68GEM, CF3-512GEV, CF3-612GEMV, CF4-8ETS, CF4-GEMS, CF-8EM, CF-8EM-A, CF-8ET, CF-8ET-A, CF-8GEM, CF-8GEM-A, CFPB6-79GEM, CW-74ET, CW-74ETX, CW-78ET, CW-78ETX, CW-94ET, CW-98ET, CWT-64ET, CWT-64ETX, CWT-66ET, CWT-66ETX, CWT-68ET, CWT-68ETX, CWT-74ET, CWT-74ETX, CWT-78ET, CWT-78ETX, CWT-94ET, CWT-98ET, FTL-4EM...(Other models you can see in the webshop) | | |

| | | | |
|---|--|-----------------|----------|
|  | | | |
| Part No. | 375270 | Ref. No. | 40100042 |
| description | thermostat t.max. 295°C temperature range 45-295°C 1-pole 1NO 16A probe ø 4mm probe L 100mm capillary pipe 900mm capillary pipe isolated 350mm gland nut shaft L 23mm shaft position upper rotation 270° | | |

| | | | |
|--|---|-----------------|-----------|
|  | | | |
| Part No. | 375231 | Ref. No. | 537001500 |
| description | thermostat t.max. 90°C temperature range 30-90°C 1-pole 1NO 16A probe ø 6mm probe L 130mm capillary pipe 900mm capillary pipe isolated 600mm gland nut M9x1 shaft L 18mm shaft position upper rotation 270° | | |
| For models: | BM-10EM, BM-4EM, BM-61EM, BM-62EM, BM-62ET, BM-6EM, BM-74EM, BM-74ET, BM-78EM, BM-78ET, BM-8EM, BM-94EM, BM-98EM, BMD-64EM, BMD-84EM, BMT-63EM, BMT-64EM, BMT-66EM, BMT-74EM, BMT-78EM, BMT-94EM, BMT-98EM, BS-4EM, BS-4EMX, BS-61EM, BS-62EM, BS-74EM, BS-94EM, BSD-64EM, BST-64EM, BST-74EM, BST-94EM, CP-61EM, CP-62ET, MP-62, MP-62EM, SV-11, SV-113, SV-12, SV-123, SV-13, SV-23 | | |



55.13_ series



| | | | |
|--------------------|---|-----------------|------------|
| Part No. | 375954 | Ref. No. | RRC2218-00 |
| description | thermostat t.max. 109°C 1-pole 1CO 16A probe ø 3.03mm probe L 198mm capillary pipe 900mm capillary pipe isolated 610mm gland nut M9x1 shaft ømm shaft Lmm shaft position° shaft position rotation ° | | |
| For models: | RDA-5E, RDA-5EM | | |



| | | | |
|--------------------|--|-----------------|-----------|
| Part No. | 375412 | Ref. No. | 537013500 |
| description | thermostat t.max. 320°C temperature range 50-320°C 3-pole 3NO 16A probe ø 3.1mm probe L 226mm capillary pipe 1480mm capillary pipe isolated 1400mm gland nut shaft ø 6x4.6mm shaft L 23mm shaft position upper rotation 318° | | |
| For models: | FTC-4EM, FTC-4EMX, FTC-4ET, FTC-61EM, FTC-61ET, FTC-62EM, FTC-62ET, FTC-6EM, FTC-6EMX, FTC-6ET, FTC-8EMX, FTC-8ET | | |



| | | | |
|--------------------|--|-----------------|-----------|
| Part No. | 375505 | Ref. No. | 537006100 |
| description | thermostat t.max. 320°C temperature range 50-320°C 1-pole 1NO 16A probe ø 3mm probe L 160mm capillary pipe 870mm capillary pipe isolatedmm gland nut shaft ø 6x4.6mm shaft L 23mm shaft position upper rotation 270° | | |
| For models: | CF-10EM, CF-10EM-6, CF-10EM-A, CF-10ET, CF-10ET-6, CF-10ET-A, CF-10GEM, CF-10GEM-6, CF-10GEM-A, CF-10GEM-6, CF-4-8ETS, CF-4-GEMS, CF-62EM, CF-62EM-A, CF-62ET, CF-62ET-A, CF-62GEM, CF-62GEM-A, CF-8EM, CF-8EM-A, CF-8ET, CF-8ET-A, CF-8GEM, CF-8GEM-A, CFC-62EM, CFC-62ET | | |

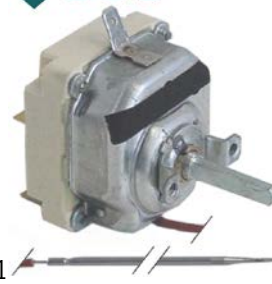

| | | | |
|--------------------|---|-----------------|-----------|
| Part No. | 375621 | Ref. No. | 537000900 |
| description | thermostat t.max. 320°C temperature range 50-320°C 3-pole 3NO 16A probe ø 3mm probe L 219mm capillary pipe 1200mm capillary pipe isolated 1200mm gland nut shaft ø 6x4.6mm shaft L 23mm shaft position upper rotation 318° | | |
| For models: | BR-62ET, BR-6ET, BR-6ETX, BRF-64ET, BRF-74ET, BRF-78ET, BRF-94ET, BRF-98ET, BRFD-64ET, BRT-66ET, BRT-66ETX, CF4-78ET, CF4-78ETX, CF4-78GE, CF4-78GPE, CF4-98ET, CF4-98ETX, CF4-98GE, CF6-712ET, CF6-712ETV, CF6-712ETVX, CF6-712ETX, CF6-712GEV, CF6-712GPE, CF6-712GPEV, CF6-912ET, CF6-912ETV, CF6-912ETVX, CF6-912GE, CF6-912GEV, CF-712GE, CF-712GPE, CF8-916ET, CF8-916ETV, CF8-916GE, CF8-916GEV, CFC4-78ET, CFC4-78ETX, CFC4-98ET, CFC4-78ET, CFC4-78ETX, CFQ4-98ET, CFQ4-98ETX, CFQ6-712ET, CFQ6-712ETV, CFQ6-712ETVX, CFQ6-712ETX, CFQ6-912ET, CFQ6-912ETV, CFQ6-912ETVX...(Other models you can see in the webshop) | | |

55.34_ series

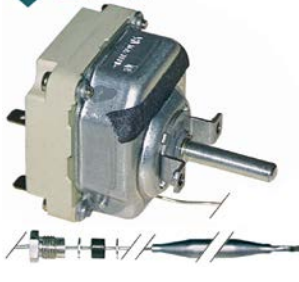

| | | | |
|--------------------|---|-----------------|-----------|
| Part No. | 375143 | Ref. No. | 537012300 |
| description | thermostat t.max. 110°C temperature range 32-110°C 3-pole 3NO 16A probe ø 6mm probe L 138mm capillary pipe 1480mm capillary pipe isolated 1100mm gland nut M9x1 shaft ø 6x4.6mm shaft L 23mm shaft position upper rotation 270° | | |
| For models: | BM-10EMX, BM-4EMX, BM-6EMX, BM-8EMX, CP-4ET, CP-4ETX, CP-62ET, CP-6ET, CP-6ETX, CP-74ET, CP-74ETX, CP-78ET, CP-78ETX, CP-94ET, CP-94ETX, CP-98ET, CP-98ETX, CPD-64ET | | |

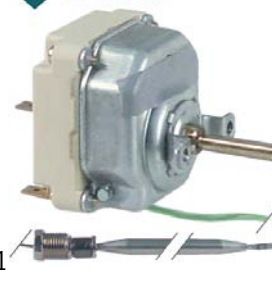

| | | | |
|--------------------|--|-----------------|-----------|
| Part No. | 375411 | Ref. No. | 537000800 |
| description | thermostat t.max. 93°C temperature range 30-93°C 3-pole 3NO 16A probe ø 6mm probe L 129mm capillary pipe 1480mm capillary pipe isolated 1100mm gland nut M10x1 shaft ø 6x4.6mm shaft L 23mm shaft position upper rotation 270° | | |
| For models: | BM-10EMX, BM-4EMX, BM-61EM, BM-62EM, BM-62ET, BM-6EMX, BM-8EMX, BS-4EMX, CP-61EM, CP-62ET | | |



safety thermostats

55.10/19_series

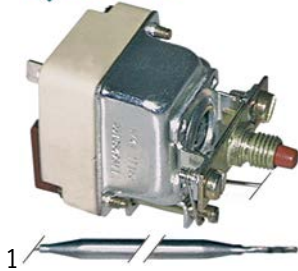

| | | | |
|-----------------|--------|-----------------|-----------|
| Part No. | 375233 | Ref. No. | 537001300 |
|-----------------|--------|-----------------|-----------|

description safety thermostat switch-off temp. 235°C 1-pole 16A probe ø 6mm probe L 133mm capillary pipe 870mm capillary pipe isolated 830mm gland nut probe SS

For models: F10T-63EM, F10T-63ET, F10T-63ETX, F13-64EM, F13-64ET, F13-74ET, F13-74ETX, F13T-74E, F13T-74ET, F13T-74ETX, F18-74ET, F18-74ETX, F18-94ET, F18-94ETX, F2-10T-66EM, F2-10T-66ET, F2-10T-66ETX, F2-13-78ET, F2-13-78ETX, F2-13T-78E, F2-13T-78ET, F2-18-74ET, F2-18-74ETX, F2-18-78ET, F2-18-78ETX, F2-18-98ET, F2-18-98ETX, F2-25-98ET, F2-25-98ETX, F25-94ET, F25-94ETX, FEM-2-6, FEM-6, FMPE-25, FMPE-30, FPE-25, FQ-4EM, FQ-61EM, FQ-61ET, FQ-62EM, FQ-62ET, FQ-6EM

accessories for 375233



| | | | |
|-----------------|--------|-----------------|-----------|
| Part No. | 102067 | Ref. No. | 533009800 |
|-----------------|--------|-----------------|-----------|

nut thread M8x1 H 3mm brass Qty 1 pcs type SEF 1



| | | | |
|-----------------|--------|-----------------|---|
| Part No. | 551083 | Ref. No. | — |
|-----------------|--------|-----------------|---|

cap for safety thermostat thread M8x1



| | | | |
|-----------------|--------|-----------------|-----------|
| Part No. | 375352 | Ref. No. | 537010000 |
|-----------------|--------|-----------------|-----------|

description safety thermostat switch-off temp. 245°C 1-pole 1NC 16A probe ø 6mm probe L 130mm capillary pipe 1200mm capillary pipe isolated 1200mm gland nut probe

55.32_series



| | | | |
|-----------------|--------|-----------------|-------|
| Part No. | 375622 | Ref. No. | 10064 |
|-----------------|--------|-----------------|-------|

description safety thermostat switch-off temp. 147°C 1-pole 20A probe ø 6mm probe L 89mm capillary pipe 900mm capillary pipe isolated 800mm gland nut probe

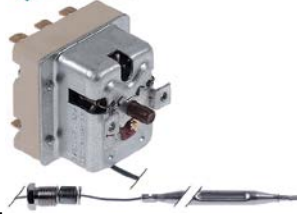

| | | | |
|-----------------|--------|-----------------|-----------|
| Part No. | 375393 | Ref. No. | 537001400 |
|-----------------|--------|-----------------|-----------|

description safety thermostat switch-off temp. 235°C 3-pole 1CO/2NC 20A probe ø 6mm probe L 87mm capillary pipe 1790mm capillary pipe isolated 1710mm gland nut M9x1 probe SS

For models: F10D-64ET, F10D-64ETX, F10T-63EM, F10T-63ET, F10T-63ETX, F13-64EM, F13-64ET, F13-74ET, F13-74ETX, F13T-74E, F13T-74ET, F13T-74ETX, F18-74ET, F18-74ETX, F18-94ET, F18-94ETX, F18D-64ET, F2-10D-66ET, F2-10D-66ETX, F2-10T-66EM, F2-10T-66ET, F2-10T-66ETX, F2-13-78ET, F2-13-78ETX, F2-13-98ET, F2-13T-78E, F2-13T-78ET, F2-18-74ET, F2-18-74ETX, F2-18-78ET, F2-18-78ETX, F2-18-98ET, F2-18-98ETX, F2-25-98ET, F2-25-98ETX, F25-94ET, F25-94ETX, F2-8-74ET, F2-8-94ET, F2-8D-64ET, F2-8T-74ET, F2-8T-74ETX, F2-8T-94ET, FE-10, FE2-10, FE-2-8, FE-8, FME-10, FME-15...(Other models you can see in the webshop)

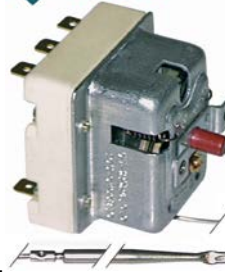

| | | | |
|-----------------|--------|-----------------|----------|
| Part No. | 375350 | Ref. No. | 40100062 |
|-----------------|--------|-----------------|----------|

description safety thermostat switch-off temp. 360°C 3-pole 20A probe ø 4mm probe L 120mm capillary pipe 1800mm capillary pipe isolated 1800mm gland nut probe SS





| | | | |
|--------------------|---|-----------------|----------|
| Part No. | 390227 | Ref. No. | 40100062 |
| description | safety thermostat switch-off temp. 360°C 3-pole 20A probe ø 4mm probe L 120mm capillary pipe 1800mm capillary pipe isolated 1800mm gland nut probe SS | | |



| | | | |
|--------------------|---|-----------------|------------------------|
| Part No. | 390181 | Ref. No. | 537012700 537012800 |
| description | safety thermostat switch-off temp. 420°C 3-pole 20A probe ø 3.9mm probe L 306mm capillary pipe 870mm capillary pipe isolated 850mm gland nut probe SS | | |
| For models: | BR-62ET, BR-6ET, BR-6ETX, BRF-64ET, BRF-74ET, BRF-78ET, BRF-94ET, BRF-98ET, BRFD-64ET, BRT-66ET, BRT-66ETX, CF4-78ET, CF4-78ETX, CF4-78GE, CF4-78GPE, CF4-98ET, CF4-98ETX, CF4-98GE, CF6-712ET, CF6-712ETV, CF6-712ETVX, CF6-712ETX, CF6-712GEV, CF6-712GPE, CF6-712GPEV, CF6-912ET, CF6-912ETV, CF6-912ETVX, CF6-912GE, CF6-912GEV, CF-712GE, CF-712GPE, CF8-916ET, CF8-916ETV, CF8-916GE, CF8-916GEV, CFC4-78ET, CFC4-78ETX, CFC4-98ET, CFC4-98ETX, CFQ4-78ET, CFQ4-78ETX, CFQ4-98ET, CFQ4-98ETX, CFQ6-712ET, CFQ6-712ETV, CFQ6-712ETVX, CFQ6-712ETX, CFQ6-912ET, CFQ6-912ETV, CFQ6-912ETVX...(Other models you can see in the webshop) | | |

various

safety thermostats



| | | | |
|--------------------|---|-----------------|-----------|
| Part No. | 390184 | Ref. No. | 537012700 |
| description | safety thermostat switch-off temp. 420°C 1-pole | | |
| For models: | FTL-4EM, FTL-4EMS, FTL-61EM, FTL-61EMS, FTL-6EM, FTL-6EMS, FTL-8EM, FTL-8EMS, FTLR-6EM, FTLR-6EMS, FTLR-8EM, FTLR-8EMS, FTR-4EM, FTR-4EMS, FTR-61EM, FTR-61EMS, FTR-6EM, FTR-6EMS | | |

accessories

gland nut accessories

ducts



| | | | |
|------------------------|---|-----------------|---------------------|
| Part No. | 550336 | Ref. No. | 533008500+533010900 |
| description | gland duct ET M14x1 IT M10x1 with gasket and nut | | |
| spare parts for | 550336 | | |
| Part No. | 510417 | Ref. No. | — |
| description | flat gasket fibre ED ø 20mm ID ø 14mm thickness 2mm Qty 1 pcs | | |



| | | | |
|--------------------|--|-----------------|-----------|
| Part No. | 550335 | Ref. No. | 533008400 |
| description | gland duct ET M14x1 IT M9x1 chrome-plated brass | | |
| For models: | BM-10EM, BM-4EM, BM-61EM, BM-62EM, BM-6EM, BM-74EM, BM-74ET, BM-78EM, BM-78ET, BM-8EM, BS-4EM, BS-61EM, BS-62EM, BS-74EM, BS-94EM, BSD-64EM, BST-64EM, BST-74EM, BST-94EM, FP-62ET, FP-62ETL, FP-6ET, FQ-4EM, FQ-4ET, FQ-4ETX, FQ-61EM, FQ-61ET, FQ-62EM, FQ-62ET, FQ-6EM, FQ-6ET, FQ-6ETX, MP-62, MP-62EM, SV-11, SV-113, SV-12, SV-123, SV-13, SV-23 | | |



| | | | |
|--------------------|--|-----------------|-----------|
| Part No. | 100820 | Ref. No. | 533018400 |
| description | gland duct ET M14x1.5 IT M10x0.75 probe ø max. 6.5mm WS 22 | | |

gaskets





| | | | |
|--------------------|--|-----------------|-----------|
| Part No. | 550982 | Ref. No. | 536005100 |
| description | gasket graphite ø 7.5mm L 7mm Qty 1 pcs for gland nut | | |
| For models: | BM-10EM, BM-10EMX, BM-4EM, BM-4EMX, BM-4G, BM-61EM, BM-61GF, BM-62EM, BM-62ET, BM-62GF, BM-6EM, BM-6EMX, BM-6G, BM-74EM, BM-74ET, BM-74G, BM-78EM, BM-78ET, BM-78G, BM-8EM, BM-8EMX, BM-8G, BM-94G, BM-98G, BMT-64G, BMT-66G, BMT-74G, BMT-78G, BMT-94G, BMT-98G, BS-4EM, BS-4EMX, BS-61EM, BS-62EM, BS-74EM, BSD-64EM, CP-6G, F11-54G, F13-64G, F13-74G, F13T-74G, F13T-94G, F18-74G, F18-94G, F2-13-78G, F2-13T-78G, F2-13T-98G, F2-18-78G, F2-18-98G, F2-25-98G...(Other models you can see in the webshop) | | |

1 electric components



bolts with slot



| | | | |
|---|--|-----------------|-------------------|
| Part No. | 520243 | Ref. No. | 533008600 |
| description | bolt with slot thread M9x1 Qty 10 pcs nickel-plated brass | | |
| For models: | BM-74EM, BM-74ET, BM-78EM, BM-78ET, BS-74EM, BSD-64EM, CP-6G, F11-54G, F13-64G, F13-74G, F13T-74G, F13T-94G, F18-74G, F18-94G, F2-13-78G, F2-13T-78G, F2-13T-98G, F2-18-78G, F2-18-98G, F2-25-98G, F25-94G, F2-8-74G, F2-8-94G, F2-8T-66G, F2-8T-74G, F2-8T-94G, F45-78G, F8T-63G, FP-6G, FQ-4G, FQ-6G, FQM-4G, SV-11, SV-113, SV-12, SV-123, SV-13, SV-23 | | |
| accessories for | 520243 | | |
|  | Part No. | 510591 | Ref. No. — |
| | washer with slot ED ø 8.8mm slit width 1.2mm Qty 10 | | |
|  | Part No. | 510592 | Ref. No. — |
| | gasket ø 8x8.7mm Qty 10 pcs slotted silicone | | |

connecting bows



| | | | |
|--------------------|--|-----------------|-----------|
| Part No. | 550060 | Ref. No. | 537001200 |
| description | connecting bow long for thermostat Qty 1 pcs | | |
| For models: | BM-10EM, BM-10EMX, BM-4EM, BM-4EMX, BM-61EM, BM-62EM, BM-62ET, BM-6EM, BM-6EMX, BM-74EM, BM-74ET, BM-78EM, BM-78ET, BM-8EM, BM-8EMX, BM-94EM, BM-98EM, BMD-64EM, BMD-84EM, BMT-63EM, BMT-64EM, BMT-66EM, BMT-74EM, BMT-78EM, BMT-94EM, BMT-98EM, BR-62ET, BR-6ET, BR-6ETX, BRF-64ET, BRF-74ET, BRF-78ET, BRF-94ET, BRF-98ET, BRFD-64ET, BRT-66ET, BRT-66ETX, BS-4EM, BS-4EMX, BS-61EM, BS-62EM, BS-74EM, BS-94EM, BSD-64EM, BST-64EM, BST-74EM, BST-94EM, CF4-78ET, CF4-78GE, CF4-98ET...(Other models you can see in the webshop) | | |

switches and momentary switches

rocker/momentary rocker switches

30x11mm



| | | | |
|--------------------|--|-----------------|-----------|
| Part No. | 301014 | Ref. No. | 537015600 |
| description | momentary rocker switch mounting measurements 30x11mm black 1NO 250V 16A connection male faston 6.3mm ambient temperature max. 85/125°C protection IP40 mounting ømm male faston 6.3mm | | |

30x22mm



| | | | |
|---|---|-----------------|-------------------|
| Part No. | 301003 | Ref. No. | 537001700 |
| description | rocker switch mounting measurements 30x22mm green 2NO 250V 16A illuminated 0-I connection male faston 6.3mm ambient temperature max. 125/55°C protection IP65 | | |
| accessories for | 301003 | | |
|  | Part No. | 301036 | Ref. No. — |
| | protective cover internal size 30x22mm for rocker switch mounting measurementsmm | | |



| | | | |
|---|---|-----------------|-------------------|
| Part No. | 345189 | Ref. No. | 537015600 |
| description | momentary rocker switch mounting measurements 30x22mm black 2NO 250V 16A ignition connection male faston 6.3mm ambient temperature max. 125/55°C protection IP40 mounting ømm | | |
| For models: | CF-10EM, CF-10EM-6, CF-10EM-A, CF-10ET, CF-10ET-6, CF-10ET-A, CF-10G6-A, CF-10G-6F, CF-10G-A, CF-10GEM, CF-10GEM-6, CF-10GEM6-A, CF-10GEM-A, CF-10GF, CF4-68G, CF4-68GEM, CF4-78G, CF4-78GE, CF4-8G, CF4-8GEM, CF4-GEMS, CF-62GEM, CF-62GEM-A, CF6-610G, CF6-610GEM, CF6-712G, CF6-712GEV, CF6-712GV, CF-712GE, CF-8EM, CF-8EM-A, CF-8ET, CF-8ET-A, CF-8G-A, CF-8GEM, CF-8GEM-A, CF-8GF, CFM-10GEM, CFM-10GEM-6, CFM-10GEM6-A, CFM-10GEM-A, CFM4-66GEM, CFM4-68GEM, CFM6-610GEM, CFM-8GEM, CFM-8GEM-A, F18-94G, F2-18-98G, F2-25-98G, F25-94G...(Other models you can see in the webshop) | | |
| accessories for | 345189 | | |
|  | Part No. | 301036 | Ref. No. — |
| | protective cover internal size 30x22mm for rocker switch mounting measurementsmm | | |





| | | | |
|--------------------|---|-----------------|-----------|
| Part No. | 301098 | Ref. No. | 537015900 |
| description | momentary rocker switch mounting measurements 30x22mm black 2NO 250V 16A water connection male faston 6.3mm ambient temperature max. 125/55°C protection IP40 | | |
| For models: | BM-74EM, BM-74ET, BM-74G, BM-78EM, BM-78ET, BM-78G, BS-74EM, CP-74ET, CP-74G, CP-78ET, CP-78G, FTL-94ETX, FTL-98ETX, FTLR-98ETX, FTR-94ETX, FTR-98ETX | | |



| | | | |
|--------------------|---|-----------------|-----------|
| Part No. | 345188 | Ref. No. | 537015500 |
| description | rocker switch mounting measurements 30x22mm red 2NO 250V 16A illuminated lighting connection male faston 6.3mm ambient temperature max. 150°C protection IP40 | | |
| For models: | CF-10EM, CF-10EM-6, CF-10EM-A, CF-10ET, CF-10ET-6, CF-10ET-A, CF-10G6-A, CF-10G-6F, CF-10G-A, CF-10GEM, CF-10GEM-6, CF-10GEM6-A, CF-10GEM-A, CF-10GF, CF4-8ETS, CF4-8G, CF4-8GEM, CF4-GEMS, CF-8EM, CF-8EM-A, CF-8ET, CF-8ET-A, CF-8G-A, CF-8GEM, CF-8GEM-A, CF-8GF | | |







| blank | | | |
|--|--|-----------------|-----------------|
|  <p>1</p> | | | |
| Part No. | 345982 | Ref. No. | 537001700 |
| description | rocker switch mounting measurements 30x22mm green 2CO 250V 16A illuminated connection male faston 6.3mm ambient temperature max. 125/55°C protection IP65 with cover cap | | |
| For models: | BS-74EM, BS-94EM, BSD-64EM, BST-64EM, BST-74EM, BST-94EM, CF-10G6-A, CF-10G-6F, CF-10G-A, CF-10GF, CF4-68G, CF4-8G, CF6-610G, CF-8G-A, CF-8GF, IP-EM, K-10, K-10S, K-12, K-12S, K-14, K-14S, K-15, K-15S, K-16, K-16S, K-18, K-18S, K-20, K-20S, K-22, K-22S, K-24, K-24S, K-26, K-26S, K-28, K-28S, K-30, K-30S, K-6, K-6S, K-8, K-8S, K-9, K-9S, KE-10, KE-10S, KE-12, KE-12S... (Other models you can see in the webshop) | | |
| accessories for | 345982 | | |
| | Part No. | 301036 | Ref. No. |
| | | | — |
| |  <p>protective cover internal size 30x22mm for rocker switch mounting measurementsmm</p> | | |

| pin-plunger actuated | | | |
|--|---|-----------------|-----------|
| M10 | | | |
|  <p>1</p> | | | |
| Part No. | 345032 | Ref. No. | 537011500 |
| description | microswitch with plunger thread M10x1 thread L 12mm 250V 16A 1CO connection male faston 6.3mm stroke 7mm mounting distance 22mm L 28mm ambient temperature max. 125°C type SP9603 actuating force: 180g | | |
| For models: | F10D-64ET, F10D-64ETX, F10T-63EM, F10T-63ET, F10T-63ETX, F13-64EM, F13-64ET, F13-74ET, F13-74ETX, F13T-74E, F13T-74ET, F13T-74ETX, F13T-94ET, F18-74ET, F18-74ETX, F18-94ET, F18-94ETX, F18D-64ET, F2-10D-66ET, F2-10D-66ETX, F2-10T-66EM, F2-10T-66ETX, F2-10T-66ETX, F2-13-78ET, F2-13-78ETX, F2-13-98ET, F2-13T-78E, F2-13T-78ET, F2-18-74ET, F2-18-74ETX, F2-18-78ET, F2-18-78ETX, F2-18-98ET, F2-18-98ETX, F2-25-98ET, F2-25-98ETX, F25-94ET, F25-94ETX, F2-8-74ET, F2-8-94ET, F2-8D-64ET, F2-8T-74ET, F2-8T-74ETX, F2-8T-94ET, F45-78ET, FP-62ET, FP-62ETL, FP-6ET, FQ-4EM, FQ-4ET... (Other models you can see in the webshop) | | |

push/momentary push switches

| 28.5x28.5mm | | | |
|--|--|-----------------|-----------|
|  <p>1</p> | | | |
| Part No. | 345769 | Ref. No. | 537012500 |
| description | momentary push switch mounting measurements 28.5x28.5mm black 1NO 250V 16A connection male faston 6.3mm ambient temperature max. 150°C protection IP40 | | |
| For models: | CP-4ET, CP-4ETX, CP-6ET, CP-6ETX | | |

cam switches

| 7-position | | | |
|--|--|-----------------|-----------------|
|  <p>1</p> | | | |
| Part No. | 300025 | Ref. No. | 537000300 |
| description | cam switch 7 operating positions 1NO/2CO sequence 0-1-2-3-4-5-6 16A shaft ø 6x4.6mm shaft L 23mm connection screw 7-position ceramic | | |
| For models: | CF-10EM, CF-10EM-6, CF-10EM-A, CF-10ET, CF-10ET-6, CF-10ET-A, CF4-68ET, CF4-68ETX, CF4-78ET, CF4-78ETX, CF4-8ET, CF4-8ETS, CF-62EM, CF-62EM-A, CF-62ET, CF-62ET-A, CF6-610ET, CF6-610ETX, CF6-712ET, CF6-712ETV, CF6-712ETVX, CF6-712ETX, CF-8EM, CF-8EM-A, CF-8ET, CF-8ET-A, CFM-10EM, CFM-10EM-6, CFM-10EM-A, CFM-10ET, CFM-10ET-6, CFM-10ET-A, CFM4-66ET, CFM4-68ET, CFM6-610ET, CFM-8EM, CFM-8EM-A, CFM-8ET, CFM-8ET-A, CFQ4-78ET, CFQ4-78ETX, CFQ6-712ET, CFQ6-712ETV, CFQ6-712ETVX, CFQ6-712ETX, CFV4-78ET, CFV6-712ETV, CFVQ4-78ET, CFVQ6-712ETV, PC-10ET...(Other models you can see in the webshop) | | |
| accessories for | 300025 | | |
| | Part No. | 112172 | Ref. No. |
| | | | — |
| |  <p>knob universal ø 70mm black without adaptor/dial plate</p> | | |
| | Part No. | 112213 | Ref. No. |
| | | | — |
| |  <p>knob dial plate silver switch 7-position t.max.°C ED ø 63mm ID ø 45.5mm</p> | | |
| | Part No. | 112311 | Ref. No. |
| | | | — |
| |  <p>knob adapter shaft ø 6x4.6mm L 0mm with spring</p> | | |

microswitches

| lever actuated | | | |
|--|---|-----------------|-----------|
|  <p>1</p> | | | |
| Part No. | 346333 | Ref. No. | 537025300 |
| description | microswitch with lever 250V 16A 1NC connection male faston 6.3mm ambient temperature max. 85°C mounting distance 22mm | | |
| For models: | CF-10G6-A, CF-10G-6F, CF-10G-A, CF-10GF, CF-8G-A, CF-8GF | | |

| | | | |
|--|--|-----------------|----------|
|  <p>1</p> | | | |
| Part No. | 345044 | Ref. No. | 40100007 |
| description | microswitch with lever 250V 16A 1CO connection male faston 6.3mm ambient temperature max. 85°C mounting distance 25mm type C99ZP3 actuating force: 25g lever length 71mm | | |



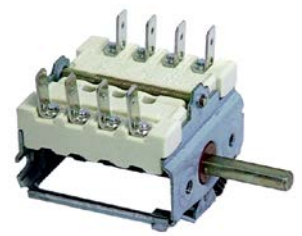

| | | | |
|---|--|-----------------|-----------|
|  | | | |
| 1 | | | |
| Part No. | 300106 | Ref. No. | 537027700 |
| description | cam switch 7 operating positions 1NO/2CO sequence 0-1-2-3-4-5-6 32A shaft ø 6x4.6mm shaft L 23mm connection screw 7-position shaft flat upper | | |
| For models: | CF4-98ET, CF4-98ETX, CF6-912ET, CF6-912ETV, CF6-912ETVX, CF8-916ET, CF8-916ETV, CFQ4-98ET, CFQ4-98ETX, CFQ6-912ET, CFQ6-912ETV, CFQ6-912ETVX, CFQ8-916ET, CFQ8-916ETV, CFQ9-916ET, CFV4-98ET, CFV6-912ET, CFV6-912ETV, CFVQ4-98ET, CFVQ6-912ET, CFVQ6-912ETV, PC-912ET, PC-912ETX, PC-916ET, PC-916ETX, PC-94ET, PC-94ETX, PC-98ET, PC-98ETX, PCQ-912ET, PCQ-916ET, PCQ-94ET, PCQ-98ET, PCQD-84ET, PCQD-88ET, PCQT-912ET, PCQT-916ET, PCQT-94ET, PCQT-94ETX, PCQT-98ET, PCQT-98ETX, PCT-912ET, PCT-912ETX, PCT-916ET, PCT-916ETX, PCT-94ET, PCT-94ETX, PCT-98ET, PCT-98ETX | | |

| | | | |
|--|---|-----------------|-----------|
| 4 operating positions | | | |
|  | | | |
| 1 | | | |
| Part No. | 300184 | Ref. No. | 537034001 |
| description | cam switch 4 operating positions sequence 0-3-2-1 shaft ø 6x4.6mm connection male faston 4-pole | | |
| For models: | CF4-78ET, CF4-78ETX, CF4-78GPE, CF4-98ET, CF4-98ETX, CF4-98GE, CF6-712ET, CF6-712ETV, CF6-712ETVX, CF6-712ETX, CF6-712GPE, CF6-712GPEV, CF6-912ETV, CF6-912ETVX, CF6-912GE, CF6-912GEV, CF8-916ET, CF8-916ETV, CF8-916GE, CF8-916GEV, CFC4-78ET, CFC4-78ETX, CFC4-98ET, CFC4-98ETX, CFC4-78ETX, CFC4-98ET, CFC4-98ETX, CFQ4-98ET, CFQ4-98ETX, CFQ6-712ET, CFQ6-712ETV, CFQ6-712ETVX, CFQ6-712ETX, CFQ6-912ETV, CFQ6-912ETVX, CFQ8-916ET, CFQ8-916ETV, CFV6-912ET, CFV6-912GEV, CFVC4-98ET, CFVQ6-912ET, MF-710ET, TPF2-712GPE, TPF2-712GPEV, TPF2-78GPE, TPF2-912GEV, TPF2-98GE, TPF4-712GPE, TPF4-712GPEV, TPF4-912GE, TPF4-912GEV, TPF-78ET...(Other models you can see in the webshop) | | |

| | | | |
|---|--|-----------------|-----------|
| 10 operating positions | | | |
|  | | | |
| 1 | | | |
| Part No. | 300135 | Ref. No. | 537019200 |
| description | cam switch 10 operating positions 10NO sequence 0-1-2-3-4-5-6-7-8-9 16A shaft ø 6x4.6mm shaft L 23mm connection male faston 6.3mm plastic | | |
| For models: | CF4-8ET, CF4-8GEM, CF-62EM, CF-62EM-A, CF-62ET, CF-62ET-A, CF-62GEM, CF-62GEM-A, CFC4-8ET, CFC-62EM, CFC-62ET, CFM-10EM, CFM-10EM-6, CFM-10EM-A, CFM-10ET, CFM-10ET-6, CFM-10ET-A, CFM-10GEM, CFM-10GEM-6, CFM-10GEM6-A, CFM-10GEM-A, CFM-8EM, CFM-8EM-A, CFM-8ET, CFM-8ET-A, CFM-8GEM, CFM-8GEM-A | | |

| | | | |
|--|--|-----------------|-----------|
|  | | | |
| 1 | | | |
| Part No. | 301205 | Ref. No. | 537019201 |
| description | cam switch 10 operating positions 5NO/1CO sequence 0-1-2-3-4-5-6-7-8-9 16A shaft ø 6x4.6mm shaft L 23mm connection male faston 6.3mm ceramic | | |
| For models: | CF4-8ET, CF4-8GEM, CF-62EM, CF-62EM-A, CF-62ET, CF-62ET-A, CF-62GEM, CF-62GEM-A, CFC4-8ET, CFC-62EM, CFC-62ET, CFM-10EM, CFM-10EM-6, CFM-10EM-A, CFM-10ET, CFM-10ET-6, CFM-10ET-A, CFM-10GEM, CFM-10GEM-6, CFM-10GEM6-A, CFM-10GEM-A, CFM2-68GEM, CFM3-612GEMV, CFM4-66ET, CFM4-66GEM, CFM4-68ET, CFM4-68GEM, CFM6-610ET, CFM6-610GEM, CFM-8EM, CFM-8EM-A, CFM-8ET, CFM-8ET-A, CFM-8GEM, CFM-8GEM-A, CFMC4-66ET, MFM-610EM, MFM-68EM, TPFM4-610GEM | | |

| | | | |
|---|---|-----------------|-----------------------|
| operation switches | | | |
|  | | | |
| 1 | | | |
| Part No. | 300080 | Ref. No. | 40100006 537000200 |
| description | cam switch 2 operating positions 4NO 16A sequence 0-1 shaft ø 6x4.6mm shaft L 23mm connection screw operation switch ceramic ambient temperature max. 150°C | | |
| For models: | BM-10EMX, BM-4EMX, BM-61EM, BM-62EM, BM-62ET, BM-6EMX, BM-8EMX, BR-62ET, BR-6ET, BR-6ETX, BRF-64ET, BRF-74ET, BRF-78ET, BRF-94ET, BRF-98ET, BRFD-64ET, BRT-66ET, BRT-66ETX, BS-4EMX, CF4-78ET, CF4-78GE, CF4-98ET, CF4-98GE, CF6-712ET, CF6-712ETV, CF6-712ETVX, CF6-712GEV, CF6-912ETV, CF6-912ETVX, CF6-912GEV, CF-712GE, CF8-916ET, CF8-916GE, CFC4-78ET, CFC4-98ET, CFQ4-78ET, CFQ4-98ET, CFQ6-712ET, CFQ6-712ETV, CFQ6-712ETVX, CFQ6-912ETV, CFQ6-912ETVX, CFQ9-916ET, CFV4-78ET, CFV4-78GPE, CFV4-98ET, CFV4-98GE, CFV6-712ETV, CFV6-712GPEV, CFV6-912ETV...(Other models you can see in the webshop) | | |
| accessories for | 300080 | | |
|  | Part No. | 551456 | Ref. No. — |
| gasket for switch ED ø 14mm ID ø 2.5mm thickness 3.5mm white | | | |

| | | | |
|--|--|-----------------|-----------|
|  | | | |
| 1 | | | |
| Part No. | 300119 | Ref. No. | 537005700 |
| description | operation switch 6 operating positions 5NO 16A sequence 0-1-2-3-4-5 shaft ø 6x4.6mm shaft L 23mm connection male faston 6.3mm plastic ambient temperature max. 318°C | | |
| For models: | CF-10EM, CF-10EM-6, CF-10EM-A, CF-10ET, CF-10ET-6, CF-10ET-A, CF-10GEM, CF-10GEM-6, CF-10GEM6-A, CF-10GEM-A, CF2-58GE, CF2-68GEM, CF3-512GEV, CF3-612GEMV, CF4-8ETS, CF4-GEMS, CF-8EM, CF-8EM-A, CF-8ET, CF-8ET-A, CF-8GEM, CF-8GEM-A, CFPB6-79GEM | | |





1

| | | | |
|--------------------|---|-----------------|-----------|
| Part No. | 300091 | Ref. No. | 537000400 |
| description | operation switch EGO 2 operating positions 2NO 16A sequence 0-1 shaft \varnothing 6x4.6mm shaft L 23mm connection screw ceramic | | |
| For models: | BM-10EM, BM-4EM, BM-61EM, BM-62EM, BM-62ET, BM-6EM, BM-74EM, BM-74ET, BM-78EM, BM-78ET, BM-8EM, BM-94EM, BM-98EM, BMD-64EM, BMD-84EM, BMT-63EM, BMT-64EM, BMT-66EM, BMT-74EM, BMT-78EM, BMT-94EM, BMT-98EM, BRF-64ET, BRF-74ET, BRF-78ET, BRF-94ET, BRF-98ET, BRFD-64ET, BRT-66ET, BRT-66ETX, BS-4EM, BS-4EMX, BS-61EM, BS-62EM, BS-74EM, BS-94EM, BSD-64EM, BST-64EM, BST-74EM, BST-94EM, CP-61EM, CP-62ET, CP-66ET, CP-74ET, CP-74ET-USA, CP-76ET, CP-78ET, CP-78ET-USA, CP-94ET, CP-94ET USA...(Other models you can see in the webshop) | | |

accessories

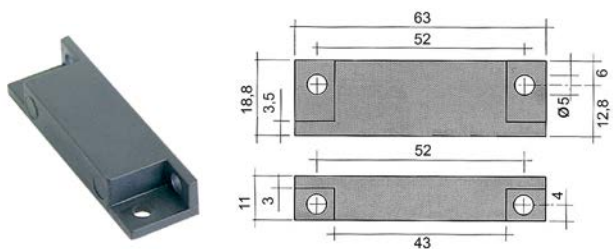
magnets



1

| | | | |
|--------------------|--|-----------------|-----------|
| Part No. | 345336 | Ref. No. | 537015800 |
| description | magnet \varnothing 4.8mm L 63mm H 11mm W 18.8mm hole distance 51mm M4 | | |
| For models: | FE-10, FE2-10, FE-2-8, FE-8, FEM-2-6, FEM-6, FME-10, FME-15, FME-2-10, FME-2-15, FMPE-20, FMPE-25, FMPE-30, FPE-20, FPE-25 | | |

magnetic switches

65x20mm



1

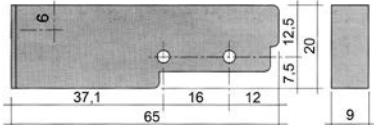

| | | | | |
|---|--|-----------------|-----------------|---|
| Part No. | 345116 | Ref. No. | 537015700 | |
| description | magnetic switch L 65mm W 20mm 1NO 250V 0.4A P max. 100W connection cable cable length 3000mm | | | |
| For models: | FE-10, FE2-10, FE-2-8, FE-8, FEM-2-6, FEM-6, FME-10, FME-15, FME-2-10, FME-2-15, FMPE-20, FMPE-25, FMPE-30, FPE-20, FPE-25 | | | |
| accessories for | 345116 | | | |
| | Part No. | 345399 | Ref. No. | — |
|  | magnet \varnothing 3.3mm L 40mm H 8mm W 13mm hole distance 30mm M3 | | | |

lamps

indicator lights

indicator lamps for socket type SRZ / SDK / SDY / SFK



1

| | | | |
|--------------------|--|-----------------|----------|
| Part No. | 359133 | Ref. No. | 40200154 |
| description | indicator lamp 400V green connection male faston 6.3mm | | |

indicator lights (complete)

\varnothing 10mm

with screw socket



1

| | | | |
|--------------------|---|-----------------|-----------|
| Part No. | 360725 | Ref. No. | 537031901 |
| description | indicator light \varnothing 12mm red 12V connection 2.8x0.8 cable length 150mm temp.-resist. 150°C plastic screw base | | |
| For models: | CP-66ET, CP-66G, CP-74ET, CP-74ET-USA, CP-74G, CP-76ET, CP-76G, CP-78, CP-78ET, CP-78ET-USA, CP-94ET, CP-94ET-USA, CP-94G, CP-98ET, CP-98ET-USA, CP-98G, CPA-66ET, CPA-66G, CPA-74ET, CPA-74G, CPA-76ET, CPA-76G, CPA-78ET, CPA-78G, CPA-94ET, CPA-94G, CPA-98ET, CPA-98G, CPB-98ET, CPB-98G, CPBA-98ET, CPBA-98G, CPP-94G, CPP-94G-USA, CPT-64EM-USA, CPT-64ET, CPT-66ET, CPT-74ET, CPT-76ET, PCI-74ET, PCI-74ETD, PCI-78ET, PCI-78ETD, PCI-94ET, PCI-94ETD, PCI-98ET, PCI-98ETD, PCID-64ET, PCID-64ETD, PCID-68ET...(Other models you can see in the webshop) | | |



with plug-in socket



1

| | | | |
|--------------------|---|-----------------|------------------------|
| Part No. | 359036 | Ref. No. | 537014100 537017600 |
| description | indicator light ø 10mm clear 230V connection male faston 6.3mm Qty 1 pcs | | |
| For models: | BM-10EM, BM-10EMX, BM-4EM, BM-4EMX, BM-61EM, BM-62EM, BM-62ET, BM-6EM, BM-6EMX, BM-74EM, BM-74ET, BM-78EM, BM-78ET, BM-8EM, BM-8EMX, BM-94EM, BM-98EM, BMD-64EM, BMD-84EM, BMT-63EM, BMT-64EM, BMT-66EM, BMT-74EM, BMT-78EM, BMT-94EM, BMT-98EM, BR-62ET, BR-6ET, BR-6ETX, BRF-64ET, BRF-74ET, BRF-78ET, BRF-94ET, BRF-98ET, BRFD-64ET, BRT-66ET, BRT-66ETX, BS-4EM, BS-4EMX, BS-61EM, BS-62EM, BS-74EM, BS-94EM, BSD-64EM, BST-64EM, BST-74EM, BST-94EM, CF-10EM, CF-10EM-6, CF-10EM-A...(Other models you can see in the webshop) | | |



2

| | | | |
|--------------------|---|-----------------|------------------------|
| Part No. | 359139 | Ref. No. | 537014200 537017500 |
| description | indicator light ø 10mm green 230V connection male faston 6.3mm Qty 1 pcs | | |
| For models: | BM-10EM, BM-10EMX, BM-4EM, BM-4EMX, BM-61EM, BM-62EM, BM-62ET, BM-6EM, BM-6EMX, BM-74EM, BM-74ET, BM-78EM, BM-78ET, BM-8EM, BM-8EMX, BM-94EM, BM-98EM, BMD-64EM, BMD-84EM, BMT-63EM, BMT-64EM, BMT-66EM, BMT-74EM, BMT-78EM, BMT-94EM, BMT-98EM, BR-62ET, BR-6ET, BR-6ETX, BRF-64ET, BRF-74ET, BRF-78ET, BRF-94ET, BRF-98ET, BRFD-64ET, BRT-66ET, BRT-66ETX, BS-4EM, BS-4EMX, BS-61EM, BS-62EM, BS-74EM, BS-94EM, BSD-64EM, BST-64EM, BST-74EM, BST-94EM, CF-10EM, CF-10EM-6, CF-10EM-A...(Other models you can see in the webshop) | | |



1

| | | | |
|--------------------|-----------------------------------|-----------------|-----------|
| Part No. | 359089 | Ref. No. | 537001800 |
| description | indicator light ø 10mm 230V clear | | |
| For models: | TS-1 | | |

ø12mm

with screw socket



1

| | | | |
|--------------------|--|-----------------|----------|
| Part No. | 359291 | Ref. No. | 40200152 |
| description | indicator light ø 12mm 400V green connection male faston 6.3mm | | |



1

| | | | |
|--------------------|---|-----------------|----------|
| Part No. | 359290 | Ref. No. | 40200150 |
| description | indicator light ø 12mm 400V yellow connection male faston 6.3mm | | |

screw-on/push-on fit

light bulbs

for ovens



1

| | | | |
|--------------------|---|-----------------|-----------|
| Part No. | 359610 | Ref. No. | 537005400 |
| description | light bulb t.max. 300°C socket E14 15W 230V ø 22mm L 47mm lens L 20mm for oven lamp type Philips | | |
| For models: | CF-10EM, CF-10EM-6, CF-10EM-A, CF-10ET, CF-10ET-6, CF-10ET-A, CF-10G6-A, CF-10G-6F, CF-10G-A, CF-10GEM, CF-10GEM-6, CF-10GEM6-A, CF-10GEM-A, CF-10GF, CF-4-68ET, CF-4-68G, CF-4-68GEM, CF-4-8ET, CF-4-8ETS, CF-4-8G, CF-4-8GEM, CF-4-GEMS, CF-62EM, CF-62EM-A, CF-62ET, CF-62ET-A, CF-62GEM, CF-62GEM-A, CF-6-610ET, CF-6-610G, CF-6-610GEM, CF-8EM, CF-8EM-A, CF-8ET, CF-8ET-A, CF-8G-A, CF-8GEM, CF-8GEM-A, CF-8GF, CFC-4-8ET, CFC-62EM, CFC-62ET, CFM-10EM, CFM-10EM-6, CFM-10EM-A, CFM-10ET, CFM-10ET-6, CFM-10ET-A, CFM-10GEM, CFM-10GEM-6...(Other models you can see in the webshop) | | |



1

| | | | |
|--------------------|--|-----------------|----------|
| Part No. | 359612 | Ref. No. | LAMPA001 |
| description | light bulb t.max. 300°C socket E14 25W 230V ø 25mm L 56mm lens L 30mm for oven lamp type Philips | | |

halogen lamp

for socket G4 / G6.35 / G9



1

| | | | |
|--------------------|---|-----------------|----------|
| Part No. | 359074 | Ref. No. | C5252-00 |
| description | halogen lamp socket G6.35 12V 35W temp.-resist. 500°C | | |





oven lamps

universal oven lamps

mounting diameter 35.5mm



| | | | |
|---|--|-----------------|-------------------|
| Part No. | 359718 | Ref. No. | 537007900 |
| description | oven lamp mounting ø 35.5mm 230V 15W socket E14 temp.-resist. 300°C connection male faston 6.3mm hard glas | | |
| For models: | CF-10EM, CF-10EM-6, CF-10EM-A, CF-10ET, CF-10ET-6, CF-10ET-A, CF-10G6-A, CF-10G-6F, CF-10G-A, CF-10GEM, CF-10GEM-6, CF-10GEM6-A, CF-10GEM-A, CF-10GF, CF4-68ET, CF4-68ETX, CF4-68G, CF4-68GEM, CF4-8ET, CF4-8ETS, CF4-8G, CF4-8GEM, CF4-GEMS, CF-62EM, CF-62EM-A, CF-62ET, CF-62ET-A, CF-62GEM, CF-62GEM-A, CF6-610ET, CF6-610ETX, CF6-610G, CF6-610GEM, CF-8EM, CF-8EM-A, CF-8ET, CF-8ET-A, CF-8G-A, CF-8GEM, CF-8GEM-A, CF-8GF, CFC4-8ET, CFC-62EM, CFC-62ET, CFM-10EM, CFM-10EM-6, CFM-10EM-A, CFM-10ET, CFM-10ET-6, CFM-10ET-A...(Other models you can see in the webshop) | | |
| spare parts for | 359718 | | |
|  | Part No. | 359701 | Ref. No. — |
| | lamp socket socket E14 220-230V mounting ø 35.5mm connection male faston 6.3mm 15W | | |
|  | Part No. | 359740 | Ref. No. — |
| | light bulb t.max. 300°C socket E14 15W 230V ø 22mm L 48mm lens L 20mm for oven lamp IMPORT | | |

lamps

light bulbs



| | | | |
|--------------------|---|-----------------|-----------|
| Part No. | 359610 | Ref. No. | 537005400 |
| description | light bulb t.max. 300°C socket E14 15W 230V ø 22mm L 47mm lens L 20mm for oven lamp type Philips | | |
| For models: | CF-10EM, CF-10EM-6, CF-10EM-A, CF-10ET, CF-10ET-6, CF-10ET-A, CF-10G6-A, CF-10G-6F, CF-10G-A, CF-10GEM, CF-10GEM-6, CF-10GEM6-A, CF-10GEM-A, CF-10GF, CF4-68ET, CF4-68G, CF4-68GEM, CF4-8ET, CF4-8ETS, CF4-8G, CF4-8GEM, CF4-GEMS, CF-62EM, CF-62EM-A, CF-62ET, CF-62ET-A, CF-62GEM, CF-62GEM-A, CF6-610ET, CF6-610G, CF6-610GEM, CF-8EM, CF-8EM-A, CF-8ET, CF-8ET-A, CF-8G-A, CF-8GEM, CF-8GEM-A, CF-8GF, CFC4-8ET, CFC-62EM, CFC-62ET, CFM-10EM, CFM-10EM-6, CFM-10EM-A, CFM-10ET, CFM-10ET-6, CFM-10ET-A, CFM-10GEM, CFM-10GEM-6...(Other models you can see in the webshop) | | |

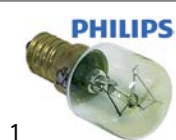

| | | | |
|--------------------|--|-----------------|----------|
| Part No. | 359612 | Ref. No. | LAMPA001 |
| description | light bulb t.max. 300°C socket E14 25W 230V ø 25mm L 56mm lens L 30mm for oven lamp type Philips | | |

halogen lamps

for socket G4 / G6.35 / G9



| | | | |
|--------------------|---|-----------------|----------|
| Part No. | 359074 | Ref. No. | C5252-00 |
| description | halogen lamp socket G6.35 12V 35W temp.-resist. 500°C | | |

residual heat indicators



| | | | |
|--------------------|---|-----------------|-----------|
| Part No. | 359269 | Ref. No. | 537020000 |
| description | residual heat indicator 4-fold | | |
| For models: | CFC4-8ET, CFC-62EM, CFC-62ET, PCC-62EM, PCC-62ET, PCC-6EM, PCC-6EMX, PCC-6ET, PCC-8EMX, PCC-8ET | | |



| | | | |
|--------------------|--|-----------------|-----------|
| Part No. | 359326 | Ref. No. | 537020001 |
| description | residual heat indicator 4-fold | | |
| For models: | CFC4-78ET, CFC4-78ETX, CFC4-8ET, CFC4-98ET, CFC-62EM, CFC-62ET, CFMCA-66ET, CFVCA-78ET, CFVCA-98ET, PCC-62EM, PCC-62ET, PCC-6EM, PCC-6EMX, PCC-6ET, PCC-78ET, PCC-8EMX, PCC-8ET, PCC-98ET, PCCT-66ET, PCCT-66ETX, PCCT-78ET, PCCT-98ET | | |



| | | | |
|--------------------|---|-----------------|------------------------|
| Part No. | 359327 | Ref. No. | 537013600 537013601 |
| description | residual heat indicator single | | |
| For models: | PCC-4EM, PCC-4EMX, PCC-4ET, PCC-61EM, PCC-74ET, PCC-94ET, PCCD-64ET, PCCD-68ET, PCCT-63ET, PCCT-63ETX, PCCT-74ET, PCCT-94ET | | |



| | | | |
|--------------------|--------------------------------------|-----------------|-----------|
| Part No. | 359436 | Ref. No. | 537013600 |
| description | residual heat indicator single | | |
| For models: | PCC-4EM, PCC-4EMX, PCC-4ET, PCC-61EM | | |



timers

electric timers



| | | | |
|--------------------|---|-----------------|-----------|
| Part No. | 362006 | Ref. No. | 537019301 |
| description | timer ITS operation time 120min 2NO at 250V 16A permanent position no shaft ø 6x4.6mm shaft L 24mm mounting distance 25mm mounting thread M4 connection 6.3x0.8 ambient temperature max. 125°C | | |
| For models: | CF-10EM, CF-10EM-6, CF-10EM-A, CF-10ET, CF-10ET-6, CF-10ET-A, CF-10GEM, CF-10GEM-6, CF-10GEM6-A, CF-10GEM-A, CF4-68ET, CF4-68ETX, CF4-68GEM, CF4-8ET, CF4-8ETS, CF4-8GEM, CF4-GEMS, CF-62EM, CF-62EM-A, CF-62ET, CF-62ET-A, CF-62GEM, CF-62GEM-A, CF6-610ET, CF6-610ETX, CF6-610GEM, CF-8EM, CF-8EM-A, CF-8ET, CF-8ET-A, CF-8GEM, CF-8GEM-A, CFC4-8ET, CFC-62EM, CFC-62ET, CFM-10EM, CFM-10EM-6, CFM-10EM-A, CFM-10ET, CFM-10ET-6, CFM-10ET-A, CFM-10GEM, CFM-10GEM-6, CFM-10GEM6-A, CFM-10GEM-A, CFM2-68GEM, CFM3-612GEMV, CFM4-66ET, CFM4-66GEM, CFM4-68ET... (Other models you can see in the webshop) | | |

mechanical timers



| | | | |
|---|---|-----------------|-------------------|
| Part No. | 350044 | Ref. No. | 537000500 |
| description | timer C20 2-pole operation time 15min impulse mechanical 2NO at 250V 16A permanent position no shaft ø 6x4.6mm shaft 6x4.6mm shaft L 20mm mounting distance 28mm connection lateral for toaster | | |
| For models: | TS-1 | | |
| accessories for | 350044 | | |
|  | Part No. | 110285 | Ref. No. — |



| | | | |
|--------------------|---|-----------------|-----------|
| Part No. | 350061 | Ref. No. | 537019300 |
| description | timer DTJ with bell 2-pole operation time 120min impulse mechanical 2NO at 250V 16A permanent position yes shaft ø 6x4.6mm shaft 6x4.6mm shaft L 24mm mounting distance 28mm connection lateral | | |
| For models: | CF-10EM, CF-10EM-6, CF-10EM-A, CF-10ET, CF-10ET-6, CF-10ET-A, CF-10GEM, CF-10GEM-6, CF-10GEM6-A, CF-10GEM-A, CF4-8ET, CF4-8ETS, CF4-8GEM, CF4-GEMS, CF-62EM, CF-62EM-A, CF-62ET, CF-62ET-A, CF-62GEM, CF-62GEM-A, CF-8EM, CF-8EM-A, CF-8ET, CF-8ET-A, CF-8GEM, CF-8GEM-A, CFC4-8ET, CFC-62EM, CFC-62ET, CFM-10EM, CFM-10EM-6, CFM-10EM-A, CFM-10ET, CFM-10ET-6, CFM-10ET-A, CFM-10GEM, CFM-10GEM-6, CFM-10GEM6-A, CFM-10GEM-A, CFM-8EM, CFM-8EM-A, CFM-8ET, CFM-8ET-A, CFM-8GEM, CFM-8GEM-A | | |



| | | | |
|--------------------|--|-----------------|-----------|
| Part No. | 350013 | Ref. No. | 537001100 |
| description | timer G 2-pole operation time 15min impulse mechanical 2NO at 250V 16A permanent position no shaft ø 5x3.5mm shaft L 9mm mounting thread M8 connection lateral | | |
| For models: | TS-3, TS-6 | | |

audible timers



| | | | |
|--------------------|--|-----------------|-----------|
| Part No. | 350075 | Ref. No. | 531024800 |
| description | audible timer operation time 120min ø 58mm shaft ø 6x4.6mm shaft L 23mm mounting distance 28mm | | |
| For models: | CF2-58G, CF2-58GE, CF2-68G, CF2-68GEM, CF3-512GEV, CF3-512GV, CF3-612GEMV, CF3-612GV, CF4-68G, CF4-78ET, CF4-78G, CF4-78GE, CF4-78GP, CF4-78GP-AUS, CF4-78GP-USA, CF4-8G, CF4-8GEM, CF4-98G, CF6-610G, CF6-712ET, CF6-712ETV, CF6-712G, CF6-712GEV, CF6-712GP, CF6-712GPV, CF6-712GPV-USA, CF6-712GV, CF6-912G, CF6-912GV, CF-712GE, CF8-916G, CF8-916GV, CFA4-78G, CFA4-98G, CFA6-712GV, CFA6-912GV, CFC4-78ET, CFPB6-79G, CFPB6-79GEM, CFQ4-78ET, CFQ6-712ET, CFQ6-712ETV, CFV4-78ET, CFV4-78GPE, CFV4-98ET, CFV4-98GE, CFV6-712ETV, CFV6-712GPEV, CFV6-912ETV, CFCV4-78ET...(Other models you can see in the webshop) | | |

contactors

ISKRA (FANAL)

power contactors



| | | | |
|--------------------|---|-----------------|---------------------------|
| Part No. | 380213 | Ref. No. | 53.7.0080.00 537010100 |
| description | power contactor resistive load 20A 230VAC (AC3/400V) 8.5A/5.5kW main contacts 3NO auxiliary contacts 1NO connection screw connection type Fanal DSL7 10 type ISKRA K07M 10 | | |
| For models: | BRF-78ET, CP-74ET, CP-74ET-USA, CP-76ET, CP-78ET, CP-78ET-USA, CPA-66ET, CPA-74ET, CPA-76ET, CPA-78ET, CPT-64EM-USA, CPT-64ET, CPT-66ET, CPT-74ET, CPT-76ET, CWK-74ET, CWK-78ET, CWK-94ET, CWK-98ET, CWKT-64ET, CWKT-68ET, CWKT-74ET, CWKT-78ET, CWKT-94ET, CWKT-98ET, F10D-64ET, F10D-64ETX, F10T-63EM, F10T-63ET, F10T-63ETX, F13-64EM, F13-64ET, F13-74ET, F13-74ETX, F13T-74E, F13T-74ET, F13T-94ET, F18-74ET, F2-10D-66ET, F2-10D-66ETX, F2-10T-66EM, F2-10T-66ET, F2-10T-66ETX, F2-13-78ET, F2-13-78ETX, F2-13-98ET, F2-13T-78E, F2-13T-78ET, F2-18-78ET, F2-8-74ET...(Other models you can see in the webshop) | | |



SIEMENS

power contactors



| | | | |
|--------------------|---|-----------------|-----------|
| 1 | | | |
| Part No. | 380383 | Ref. No. | 537009500 |
| description | power contactor resistive load 40A 230VAC (AC3/400V) 9A/4kW main contacts 3NO auxiliary contacts connection screw connection type 3RT10-23-1AL20 | | |
| For models: | BRF-94ET, BRF-98ET, CP-94ET, CP-94ET-USA, CP-94ETX, CP-98ET, CP-98ET-USA, CP-98ETX, CPA-94ET, CPA-98ET, CPB-98ET, CPBA-98ET, F13-64EM, F13-64ET, F13-74ET, F13-74ETX, F13T-74E, F13T-74ETX, F18-74ET, F18-74ETX, F18-94ET, F18-94ETX, F18D-64ET, F2-13-78ET, F2-13-78ETX, F2-13T-78E, F2-18-74ET, F2-18-74ETX, F2-18-78ET, F2-18-78ETX, F2-18-98ET, F2-18-98ETX, F2-25-98ET, F2-25-98ETX, F25-94ET, F25-94ETX, F45-78ET, FMPE-25, FMPE-30, FP-62ETL, FPE-25, FQ-4EM, FQ-4ET, FQ-61EM, FQ-61ET, FQ-62EM, FQ-62ET, FQ-6EM, FQ-6ET | | |

probes

accessories

screw connections



| | | | |
|--------------------|---|-----------------|-----------|
| 1 | | | |
| Part No. | 550339 | Ref. No. | 533018400 |
| description | screw connection for probe | | |
| For models: | BM-4G, BM-61GF, BM-62GF, BM-6G, BM-74G, BM-78G, BM-8G, BM-94G, BM-98G, BMT-64G, BMT-66G, BMT-74G, BMT-78G, BMT-94G, BMT-98G | | |

electronics

PCBs



| | | | |
|--------------------|---|-----------------|------------------------|
| 1 | | | |
| Part No. | 402297 | Ref. No. | 537031600 537031700 |
| description | PCB L 70mm W 40mm | | |
| For models: | CFC4-98ET, CFVC4-98ET, FTC-74ET, FTC-78ET, FTC-94ET, FTC-98ET, FTCT-64ET, FTCT-66ET, FTCT-74ET, FTCT-78ET, FTCT-94ET, FTCT-98ET, PCC-94ET, PCC-98ET, PCCT-94ET, PCCT-98ET | | |

solenoid valves

solenoid valves (water)

RPE



| | | | |
|--------------------|--|-----------------|-----------|
| 1 | | | |
| Part No. | 370123 | Ref. No. | 537011600 |
| description | solenoid valve single straight 230VAC inlet 1/2" outlet 1/2" DN10 | | |
| For models: | BM-74EM, BM-74ET, BM-74G, BM-78EM, BM-78ET, BM-78G, CP-74ET, CP-74G, CP-78ET, CP-78G | | |

TP



| | | | |
|--------------------|--|-----------------|-----------|
| 1 | | | |
| Part No. | 370017 | Ref. No. | 537012600 |
| description | solenoid valve single straight 230VAC inlet 3/4" outlet 11.5mm DN10 TP p max 10bar | | |
| For models: | CP-4ET, CP-6ET | | |

| | | | |
|------------------------|-----------------|--------|-----------------|
| spare parts for | | 370017 | |
| | Part No. | 371013 | Ref. No. |
| | | | — |
| accessories for | | 370017 | |
| | Part No. | 371220 | Ref. No. |
| | | | — |
| | Part No. | 371221 | Ref. No. |
| | | | — |
| | Part No. | 371222 | Ref. No. |
| | | | — |
| | Part No. | 371223 | Ref. No. |
| | | | — |
| | Part No. | 371224 | Ref. No. |
| | | | — |
| | Part No. | 371225 | Ref. No. |
| | | | — |
| | Part No. | 371226 | Ref. No. |
| | | | — |
| | Part No. | 371230 | Ref. No. |
| | | | — |

Table continues overleaf



| accessories for | | 370017 | | |
|---|--|--------|----------|---|
|  | Part No. | 371231 | Ref. No. | — |
| | reducer TP flow rate 0.35l/min violet tolerance $\pm 25\%$ | | | |
|  | Part No. | 371232 | Ref. No. | — |
| | reducer TP flow rate 0.5l/min orange tolerance $\pm 25\%$ | | | |
|  | Part No. | 371233 | Ref. No. | — |
| | reducer TP flow rate 0.8l/min white tolerance $\pm 25\%$ | | | |
|  | Part No. | 371234 | Ref. No. | — |
| | reducer TP flow rate 1l/min light blue tolerance $\pm 25\%$ | | | |
|  | Part No. | 371235 | Ref. No. | — |
| | reducer TP flow rate 1.2l/min brown tolerance $\pm 25\%$ | | | |
|  | Part No. | 371236 | Ref. No. | — |
| | reducer TP flow rate 1.5l/min light brown tolerance $\pm 25\%$ | | | |
|  | Part No. | 371237 | Ref. No. | — |
| | reducer TP flow rate 2.5l/min yellow tolerance $\pm 25\%$ | | | |
|  | Part No. | 371238 | Ref. No. | — |
| | reducer TP flow rate 3.4l/min dark green tolerance $\pm 25\%$ | | | |
|  | Part No. | 371239 | Ref. No. | — |
| | reducer TP flow rate 5l/min black tolerance $\pm 25\%$ | | | |
|  | Part No. | 371240 | Ref. No. | — |
| | reducer TP flow rate 8l/min blue tolerance $\pm 20\%$ | | | |

fans

hot air motors

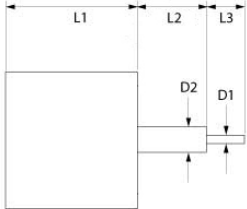
| | | | |
|--|--|-----------------|------------|
|  |  | | |
| 1 | | | |
| Part No. | 500629 | Ref. No. | RRC3610-00 |
| description | fan motor 220-240V 1 phase 50/60Hz 0.045/0.0765kW 2800/3400rpm speeds 1 L1 95mm L2 33mm L3 19mm D1 \varnothing 8mm D2 \varnothing 10mm 0.35A suitable capacitor 2.5 μ F/400V type 1048 | | |
| For models: | RDA-5E, RDA-5EM, RDE-5E, RDE-5EM, SUTA-4E, SUTA-5E | | |

| | | | |
|--|---|-----------------|----------|
|  | | | |
| 1 | | | |
| Part No. | 602179 | Ref. No. | C9012-00 |
| description | fan wheel blades 55 D1 \varnothing 240mm D2 \varnothing 9mm D3 \varnothing 11mm H1 60mm H2 24mm | | |

pressure switches

for steam control

| | | | |
|---|--|-----------------|-------|
|  | | | |
| 1 | | | |
| Part No. | 541346 | Ref. No. | 16994 |
| description | pressure control pressure range 0.3-0.8bar | | |

| | | | |
|---|--|-----------------|-------|
|  | | | |
| 1 | | | |
| Part No. | 541350 | Ref. No. | 16994 |
| description | pressure control pressure range adjustable 0.3-0.8bar connection 1/4" CO 250V 10A ambient temperature max. 60°C pressure connection 1/4" | | |



hot air fans

miscellaneous



1

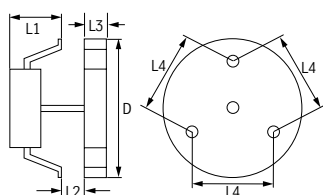

| | | | |
|--------------------|---|-----------------|--|
| Part No. | 601184 | Ref. No. | 537006800 537044700+533136500+533136600 |
| description | hot air fan 230V L1 82mm L2 15mm L3 25mm L4 87mm fan wheel ø 150mm Emmevi type 260306X | | |
| For models: | CF4-8ET, CF4-8GEM, CF-62EM, CF-62EM-A, CF-62ET, CF-62ET-A, CF-62GEM, CF-62GEM-A, CFC4-8ET, CFC-62EM, CFC-62ET, CFM-10EM, CFM-10EM-6, CFM-10EM-A, CFM-10ET, CFM-10ET-6, CFM-10ET-A, CFM-10GEM, CFM-10GEM-6, CFM-10GEM6-A, CFM-10GEM-A, CFM2-68GEM, CFM3-612GEMV, CFM4-66ET, CFM4-66GEM, CFM4-68ET, CFM4-68GEM, CFM6-610ET, CFM6-610GEM, CFM-8EM, CFM-8EM-A, CFM-8ET, CFM-8ET-A, CFM-8GEM, CFM-8GEM-A, CFMC4-66ET | | |

electric accessories

terminals

connection terminals with screw/faston connections



1

| | | | |
|--------------------|---|-----------------|-----------|
| Part No. | 550278 | Ref. No. | 537007600 |
| description | power terminal block 3-pole max. 40A max 400V connection ø6mm ² / F6.3 temp.-resist. 150°C cross section 6mm ² | | |
| For models: | BM-10EM, BM-10EMX, BM-4EM, BM-4EMX, BM-61EM, BM-62EM, BM-62ET, BM-6EM, BM-6EMX, BM-74EM, BM-74ET, BM-74G, BM-78EM, BM-78ET, BM-78G, BM-8EM, BM-8EMX, BM-94EM, BM-98EM, BMT-74EM, BMT-78EM, BMT-94EM, BMT-98EM, BS-4EM, BS-4EMX, BS-61EM, BS-62EM, BS-74EM, BS-94EM, BST-74EM, BST-94EM, CF-10EM, CF-10EM-6, CF-10EM-A, CF-10ET, CF-10ET-A, CF-10G6-A, CF-10G-6F, CF-10G-A, CF-10GEM, CF-10GEM-6, CF-10GEM6-A, CF-10GEM-A, CF-10GF, CF2-58GE, CF3-512GEV, CF4-78G, CF4-8G, CF4-8GEM, CF4-GEMS... (Other models you can see in the webshop) | | |



1

| | | | |
|--------------------|--|-----------------|------------------------|
| Part No. | 550411 | Ref. No. | 537007700 FX0144-00 |
| description | power terminal block 6-pole max. 40A max 450V connection ø6mm ² / F6.3 temp.-resist. 150°C cross section 6mm ² | | |
| For models: | BM-61EM, BM-62EM, BM-62ET, BR-62ET, BR-6ET, BR-6ETX, BRF-74ET, BRF-78ET, BRF-94ET, BRF-98ET, CF-10EM, CF-10EM-A, CF-10ET, CF-10ET-6, CF-10ET-A, CF4-78ET, CF4-78GE, CF4-8ET, CF4-8ETS, CF-62EM, CF-62EM-A, CF-62ET, CF-62ET-A, CF6-712ET, CF6-712ETV, CF6-712ETVX, CF6-712GEV, CF-712GE, CF-8EM, CF-8EM-A, CF-8ET, CF-8ET-A, CFC4-78ET, CFC4-8ET, CFC-62ET, CFM-10EM, CFM-10ET-6, CFM-8ET, CFM-8ET-A, CFQ4-78ET, CFQ6-712ET, CFQ6-712ETV, CFQ6-712ETVX, CP-4ET, CP-4ETX, CP-61EM, CP-62ET, CP-6ET, CP-6ETX, CP-74ET... (Other models you can see in the webshop) | | |

gas taps

PEL

20S series



1











| | | | |
|---|---|-----------------|---------------------------|
| Part No. | 101094 | Ref. No. | 531025800 531025900 |
| description | gas tap PEL type 20S gas inlet M16x1.5 (tube ø 10mm) bypass nozzle ø 0.35mm gas outlet M16x1.5 (tube ø 10/8mm) thermocouple connection M8x1 pilot connection shaft ø 8x6.5mm shaft L 22/15mm shaft flat lower | | |
| spare parts for | 101094 | | |
|  | Part No. | 100408 | Ref. No. — |
| | bypass nozzle type PEL20/21 bore ø 0.35mm thread M5x0.5 | | |
|  | Part No. | 101060 | Ref. No. — |
| | magnet unit standard L 39mm D1 ø 15.4mm D2 ø 11mm suitable for PEL20-21/JUNKERS/EGA | | |
|  | Part No. | 101205 | Ref. No. — |
| | gas tap front part shaft ø 8x6.5mm shaft L 22/15mm shaft flat upper/lower suitable for PEL20 | | |
|  | Part No. | 101230 | Ref. No. — |
| | thermocouple nut T1: M8x1 T2: M18x1 aluminium | | |
| accessories for | 101094 | | |
|  | Part No. | 101278 | Ref. No. 533039300 |
| | olive for pipe ø 10mm Qty 1 pcs | | |
|  | Part No. | 101300 | Ref. No. 533010800 |
| | union nut thread M16x1.5 tube ø 10mm | | |
|  | Part No. | 101450 | Ref. No. — |
| | olive for pipe ø 8mm L 12.7mm Qty 1 pcs ED ø 10mm | | |
|  | Part No. | 101451 | Ref. No. — |
| | union nut thread M16x1.5 tube ø 8mm | | |

Table continues overleaf



| | | | |
|---|---|--------|--------------------|
| accessories for | 101094 | | |
|  | Part No. | 110081 | Ref. No. 536017100 |
| | knob ø 70mm shaft ø 8x6.5mm shaft flat universal | | |
|  | Part No. | 110083 | Ref. No. — |
| | knob dial plate gas tap without ignition flame silver | | |





| | | | |
|--------------------|---|-----------------|-----------|
| Part No. | 101491 | Ref. No. | 531021600 |
| description | gas tap PEL type 20S gas inlet M16x1.5 (tube ø 10mm) bypass nozzle ø 0.35mm gas outlet M16x1.5 (tube ø 10/8mm) thermocouple connection M9x1 pilot connection shaft ø 8x6.5mm shaft L 22/15mm shaft flat lower | | |
| For models: | F-1G, FB-1G | | |

| | | | |
|---|---|--------|------------|
| spare parts for | 101491 | | |
|  | Part No. | 100408 | Ref. No. — |
| | bypass nozzle type PEL20/21 bore ø 0.35mm thread M5x0.5 | | |

| | | | |
|---|---|--------|------------|
|  | Part No. | 101060 | Ref. No. — |
| | magnet unit standard L 39mm D1 ø 15.4mm D2 ø 11mm suitable for PEL20-21/JUNKERS/EGA | | |

| | | | |
|---|--|--------|------------|
|  | Part No. | 101205 | Ref. No. — |
| | gas tap front part shaft ø 8x6.5mm shaft L 22/15mm shaft flat upper/lower suitable for PEL20 | | |

| | | | |
|---|-------------------------------------|--------|------------|
|  | Part No. | 101231 | Ref. No. — |
| | thermocouple nut T1: M9x1 T2: M18x1 | | |

| | | | |
|---|--------------------------------|--------|------------|
| accessories for | 101491 | | |
|  | Part No. | 101287 | Ref. No. — |
| | olive for pipe ø 6mm Qty 1 pcs | | |

| | | | |
|---|--------------------------------------|--------|--------------------|
|  | Part No. | 101300 | Ref. No. 533010800 |
| | union nut thread M16x1.5 tube ø 10mm | | |

| | | | |
|---|---|--------|------------|
|  | Part No. | 101450 | Ref. No. — |
| | olive for pipe ø 8mm L 12.7mm Qty 1 pcs ED ø 10mm | | |

| | | | |
|---|-------------------------------------|--------|------------|
|  | Part No. | 101451 | Ref. No. — |
| | union nut thread M16x1.5 tube ø 8mm | | |

| | | | |
|---|--|--------|--------------------|
|  | Part No. | 110081 | Ref. No. 536017100 |
| | knob ø 70mm shaft ø 8x6.5mm shaft flat universal | | |

| | | | |
|---|---|--------|------------|
|  | Part No. | 110083 | Ref. No. — |
| | knob dial plate gas tap without ignition flame silver | | |

21S series



| | | | |
|-----------------|--------|-----------------|------------------------|
| Part No. | 101095 | Ref. No. | 531025800 531025900 |
|-----------------|--------|-----------------|------------------------|

| | | | |
|--------------------|---|--|--|
| description | gas tap PEL type 21S gas inlet M16x1.5 (tube ø 10mm) bypass nozzle ø 0.35mm gas outlet M16x1.5 (tube ø 10/8mm) thermocouple connection M8x1 pilot connection M10x1 shaft ø 8x6.5mm shaft L 22/15mm shaft flat lower | | |
|--------------------|---|--|--|

| | | | |
|--------------------|--|--|--|
| For models: | CF4-68G, CF4-68GEM, CF4-78G, CF4-78GE, CF4-8G, CF4-8GEM, CF4-GEMS, CF6-610G, CF6-610GEM, CF6-712G, CF6-712GEV, CF6-712GV, CF-712GE, CFM4-66GEM, CFM4-68GEM, CFM6-610GEM, FO-1G, FO-2G, FO-3G, FOS-1G, FOS-2G, FOS-3G, PC-12G, PC-4G, PC-712G, PC-716G, PC-74G, PC-78G, PC-8G, PCT-63G, PCT-66G, TP2-712G, TP4T-610G, TPF2-712G, TPF2-712GV, TPF4-610G, TPF4-610GEM | | |
|--------------------|--|--|--|

| | | | |
|---|---|--------|------------|
| spare parts for | 101095 | | |
|  | Part No. | 100408 | Ref. No. — |
| | bypass nozzle type PEL20/21 bore ø 0.35mm thread M5x0.5 | | |

| | | | |
|---|---|--------|------------|
|  | Part No. | 101060 | Ref. No. — |
| | magnet unit standard L 39mm D1 ø 15.4mm D2 ø 11mm suitable for PEL20-21/JUNKERS/EGA | | |

| | | | |
|---|--|--------|------------|
|  | Part No. | 101206 | Ref. No. — |
| | gas tap front part shaft ø 8x6.5mm shaft L 22/15mm shaft flat upper/lower suitable for PEL21 | | |

| | | | |
|---|---|--------|------------|
|  | Part No. | 101230 | Ref. No. — |
| | thermocouple nut T1: M8x1 T2: M18x1 aluminium | | |

| | | | |
|---|---|--------|------------|
| accessories for | 101095 | | |
|  | Part No. | 100908 | Ref. No. — |
| | union screw thread M10x1 for pipe ø 4mm Qty 1 pcs | | |

| | | | |
|---|---|--------|--------------------|
|  | Part No. | 100909 | Ref. No. 533018500 |
| | union screw thread M10x1 for pipe ø 6mm Qty 1 pcs | | |

| | | | |
|---|--------------------------------|--------|------------|
|  | Part No. | 101246 | Ref. No. — |
| | olive for pipe ø 4mm Qty 1 pcs | | |

| | | | |
|---|---------------------------------|--------|--------------------|
|  | Part No. | 101278 | Ref. No. 533039300 |
| | olive for pipe ø 10mm Qty 1 pcs | | |

| | | | |
|---|--------------------------|--------|------------|
|  | Part No. | 101286 | Ref. No. — |
| | olive ID ø 6mm Qty 1 pcs | | |

| | | | |
|---|--------------------------------------|--------|--------------------|
|  | Part No. | 101300 | Ref. No. 533010800 |
| | union nut thread M16x1.5 tube ø 10mm | | |

| | | | |
|---|---|--------|------------|
|  | Part No. | 101450 | Ref. No. — |
| | olive for pipe ø 8mm L 12.7mm Qty 1 pcs ED ø 10mm | | |

| | | | |
|---|-------------------------------------|--------|------------|
|  | Part No. | 101451 | Ref. No. — |
| | union nut thread M16x1.5 tube ø 8mm | | |



| | | | |
|---|--|--------|--------------------|
|  | Part No. | 110081 | Ref. No. 536017100 |
| | knob ø 70mm shaft ø 8x6.5mm shaft flat universal | | |





Table continues overleaf





| | | | | |
|---|---|--------|----------|---|
| accessories for | 101095 | | | |
|  | Part No. | 112206 | Ref. No. | — |
| | knob dial plate silver gas tap PEL21/22/23 t.max.°C ED ø 63mm ID ø 45.5mm | | | |



| | | | |
|--------------------|---|-----------------|-----------|
| Part No. | 101397 | Ref. No. | 531025500 |
| description | gas tap PEL type 21S gas inlet M16x1.5 (tube ø 10mm) bypass nozzle ø 0.35mm gas outlet M16x1.5 (tube ø 10/8mm) thermocouple connection M9x1 pilot connection M10x1 shaft ø 8x6.5mm shaft L 22/15mm shaft flat lower | | |
| For models: | CP-66G, CP-76G, CPA-66G, CPA-76G, TP2-712G, TP2-712GP, TP2-78GP, TP2-912G, TP2-98G, TP2T-712GP, TP2T-78GP, TP2T-912G, TP2T-98G, TP4-712GP, TP4-912G, TP4T-712GP, TP4T-912G, TP-74G, TP-78G, TP-94G, TP-98G, TPF2-712G, TPF2-712GP, TPF2-712GPE, TPF2-712GPEV, TPF2-712GPV, TPF2-712GV, TPF2-78GP, TPF2-78GPE, TPF2-912G, TPF2-912GE, TPF2-912GEV, TPF2-912GV, TPF2-98G, TPF2-98GE, TPF4-712GP, TPF4-712GPE, TPF4-712GPEV, TPF4-712GPV, TPF4-912G, TPF4-912GE, TPF4-912GEV, TPF4-912GV, TPF-78G, TPF-78GE, TPF-98G, TPF-98GE, TPFV2-712GPEV, TPFV2-78GPE, TPFV2-912GEV...(Other models you can see in the webshop) | | |





| | | | | |
|---|--|--------|----------|---|
| spare parts for | 101397 | | | |
|  | Part No. | 100408 | Ref. No. | — |
| | bypass nozzle type PEL20/21 bore ø 0.35mm thread M5x0.5 | | | |
|  | Part No. | 101060 | Ref. No. | — |
| | magnet unit standard L 39mm D1 ø 15.4mm D2 ø 11mm suitable for PEL20-21/JUNKERS/EGA | | | |
|  | Part No. | 101206 | Ref. No. | — |
| | gas tap front part shaft ø 8x6.5mm shaft L 22/15mm shaft flat upper/lower suitable for PEL21 | | | |
|  | Part No. | 101231 | Ref. No. | — |
| | thermocouple nut T1: M9x1 T2: M18x1 | | | |

| | | | | |
|---|---|--------|----------|-----------|
| accessories for | 101397 | | | |
|  | Part No. | 100908 | Ref. No. | — |
| | union screw thread M10x1 for pipe ø 4mm Qty 1 pcs | | | |
|  | Part No. | 100909 | Ref. No. | 533018500 |
| | union screw thread M10x1 for pipe ø 6mm Qty 1 pcs | | | |
|  | Part No. | 101246 | Ref. No. | — |
| | olive for pipe ø 4mm Qty 1 pcs | | | |
|  | Part No. | 101278 | Ref. No. | 533039300 |
| | olive for pipe ø 10mm Qty 1 pcs | | | |
|  | Part No. | 101286 | Ref. No. | — |
| | olive ID ø 6mm Qty 1 pcs | | | |
|  | Part No. | 101300 | Ref. No. | 533010800 |
| | union nut thread M16x1.5 tube ø 10mm | | | |
|  | Part No. | 101450 | Ref. No. | — |
| | olive for pipe ø 8mm L 12.7mm Qty 1 pcs ED ø 10mm | | | |
|  | Part No. | 101451 | Ref. No. | — |
| | union nut thread M16x1.5 tube ø 8mm | | | |

| | | | | |
|---|---|--------|----------|-----------|
| accessories for | 101397 | | | |
|  | Part No. | 110081 | Ref. No. | 536017100 |
| | knob ø 70mm shaft ø 8x6.5mm shaft flat universal | | | |
|  | Part No. | 112206 | Ref. No. | — |
| | knob dial plate silver gas tap PEL21/22/23 t.max.°C ED ø 63mm ID ø 45.5mm | | | |





| | | | |
|--------------------|--|-----------------|-----------|
| Part No. | 101918 | Ref. No. | 531043000 |
| description | gas tap PEL type 21S gas inlet M16x1.5 (tube ø 10mm) bypass nozzle ø 0.65mm gas outlet M16x1.5 (tube ø 10/8mm) thermocouple connection M9x1 pilot connection M10x1 shaft ø 8x6.5mm shaft L 22/15mm shaft flat right | | |
| For models: | CF2-58G, CF2-58GE, CF2-68G, CF2-68GEM, CF3-512GEV, CF3-512GV, CF3-612GEMV, CF3-612GV, CF4-98G, CF4-98GE, CF6-912G, CF6-912GEV, CF6-912GV, CF8-916G, CF8-916GE, CF8-916GEV, CF8-916GV, CFM2-68GEM, CFM3-612GEMV, CFV4-98GE, CFV6-912GEV, PC1T-64G, PC2T-68G, PC3-612G, PC3T-612G, PC-912G, PC-916G, PC-94G, PC-98G, PCT-912G, PCT-916G, PCT-94G, PCT-98G, TP2-912G, TP2-98G, TP2T-912G, TP2T-98G, TP4-912G, TP4T-912G, TPF2-912G, TPF2-912GE, TPF2-912GEV, TPF2-912GV, TPF2-98G, TPF2-98GE, TPF4-610G, TPF4-912G, TPF4-912GE, TPF4-912GEV...(Other models you can see in the webshop) | | |

| | | | | |
|---|---|--------|----------|---|
| spare parts for | 101918 | | | |
|  | Part No. | 100548 | Ref. No. | — |
| | bypass nozzle type PEL20/21 bore ø 0.65mm thread M5x0.5 | | | |
|  | Part No. | 101060 | Ref. No. | — |
| | magnet unit standard L 39mm D1 ø 15.4mm D2 ø 11mm suitable for PEL20-21/JUNKERS/EGA | | | |
|  | Part No. | 101231 | Ref. No. | — |
| | thermocouple nut T1: M9x1 T2: M18x1 | | | |
|  | Part No. | 101874 | Ref. No. | — |
| | gas tap front part shaft ø 8x6.5mm shaft L 22/15mm shaft flat right/left type PEL21 | | | |

| | | | | |
|---|---|--------|----------|-----------|
| accessories for | 101918 | | | |
|  | Part No. | 100908 | Ref. No. | — |
| | union screw thread M10x1 for pipe ø 4mm Qty 1 pcs | | | |
|  | Part No. | 100909 | Ref. No. | 533018500 |
| | union screw thread M10x1 for pipe ø 6mm Qty 1 pcs | | | |
|  | Part No. | 101246 | Ref. No. | — |
| | olive for pipe ø 4mm Qty 1 pcs | | | |
|  | Part No. | 101278 | Ref. No. | 533039300 |
| | olive for pipe ø 10mm Qty 1 pcs | | | |
|  | Part No. | 101286 | Ref. No. | — |
| | olive ID ø 6mm Qty 1 pcs | | | |
|  | Part No. | 101300 | Ref. No. | 533010800 |
| | union nut thread M16x1.5 tube ø 10mm | | | |
|  | Part No. | 101450 | Ref. No. | — |
| | olive for pipe ø 8mm L 12.7mm Qty 1 pcs ED ø 10mm | | | |





Table continues overleaf





| accessories for | | 101918 | | |
|---|--|--------|----------|-----------|
|  | Part No. | 101451 | Ref. No. | — |
| | union nut thread M16x1.5 tube ø 8mm | | | |
|  | Part No. | 110081 | Ref. No. | 536017100 |
| | knob ø 70mm shaft ø 8x6.5mm shaft flat universal | | | |
|  | Part No. | 112206 | Ref. No. | — |
| | knob dial plate silver gas tap PEL21/22/23 t.max. °C ED ø 63mm ID ø 45.5mm | | | |



| Part No. | 101917 | Ref. No. | 531042900 |
|--------------------|---|----------|-----------|
| description | gas tap PEL type 21S gas inlet M16x1.5 (tube ø 10mm) bypass nozzle ø 0.6mm gas outlet M16x1.5 (tube ø 10/8mm) thermocouple connection M9x1 pilot connection M10x1 shaft ø 8x6.5mm shaft L 22/15mm shaft flat right | | |
| For models: | CF4-78GP, CF4-78GP-AUS, CF4-78GPE, CF4-78GP-USA, CF4-98G, CF4-98GE, CF6-712GP, CF6-712GPE, CF6-712GPEV, CF6-712GPV, CF6-712GPV-USA, CF6-912G, CF6-912GE, CF6-912GEV, CF6-912GV, CF-712GPE, CF8-916G, CF8-916GE, CF8-916GEV, CF8-916GV, CFA4-78G, CFA4-98G, CFA6-712GV, CFA6-912GV, CFV4-78GPE, CFV4-98GE, CFV6-712GPEV, CFV6-912GEV, PC-712GP, PC-712GP-USA, PC-716GP, PC-716GP-USA, PC-74GP, PC-74GP-USA, PC-78GP, PC-78GP-USA, PC-912G, PC-916G, PC-94G, PC-98G, PCA-712G, PCA-74G, PCA-78G, PCA-912G, PCA-94G, PCA-98G, PCD-64G, PCD-68G, PCT-712GP, PCT-712GP-USA...(Other models you can see in the webshop) | | |





| spare parts for | | 101917 | | |
|---|---|--------|----------|---|
|  | Part No. | 100551 | Ref. No. | — |
| | bypass nozzle type PEL20/21 bore ø 0.6mm thread M5x0.5 | | | |
|  | Part No. | 101060 | Ref. No. | — |
| | magnet unit standard L 39mm D1 ø 15.4mm D2 ø 11mm suitable for PEL20-21/JUNKERS/EGA | | | |
|  | Part No. | 101231 | Ref. No. | — |
| | thermocouple nut T1: M9x1 T2: M18x1 | | | |
|  | Part No. | 101874 | Ref. No. | — |
| | gas tap front part shaft ø 8x6.5mm shaft L 22/15mm shaft flat right/left type PEL21 | | | |

| accessories for | | 101917 | | |
|---|---|--------|----------|-----------|
|  | Part No. | 100908 | Ref. No. | — |
| | union screw thread M10x1 for pipe ø 4mm Qty 1 pcs | | | |
|  | Part No. | 100909 | Ref. No. | 533018500 |
| | union screw thread M10x1 for pipe ø 6mm Qty 1 pcs | | | |
|  | Part No. | 101246 | Ref. No. | — |
| | olive for pipe ø 4mm Qty 1 pcs | | | |
|  | Part No. | 101278 | Ref. No. | 533039300 |
| | olive for pipe ø 10mm Qty 1 pcs | | | |
|  | Part No. | 101286 | Ref. No. | — |
| | olive ID ø 6mm Qty 1 pcs | | | |
|  | Part No. | 101300 | Ref. No. | 533010800 |
| | union nut thread M16x1.5 tube ø 10mm | | | |
|  | Part No. | 101450 | Ref. No. | — |
| | olive for pipe ø 8mm L 12.7mm Qty 1 pcs ED ø 10mm | | | |

| accessories for | | 101917 | | |
|---|--|--------|----------|-----------|
|  | Part No. | 101451 | Ref. No. | — |
| | union nut thread M16x1.5 tube ø 8mm | | | |
|  | Part No. | 110081 | Ref. No. | 536017100 |
| | knob ø 70mm shaft ø 8x6.5mm shaft flat universal | | | |
|  | Part No. | 112206 | Ref. No. | — |
| | knob dial plate silver gas tap PEL21/22/23 t.max. °C ED ø 63mm ID ø 45.5mm | | | |



| Part No. | 101919 | Ref. No. | 531032000 |
|--------------------|--|----------|-----------|
| description | gas tap PEL type 21S gas inlet M16x1.5 (tube ø 10mm) bypass nozzle ø 0.75mm gas outlet M16x1.5 (tube ø 10/8mm) thermocouple connection M9x1 pilot connection M10x1 shaft ø 8x6.5mm shaft L 22/15mm shaft flat right | | |
| For models: | BR-6G, BRT-66G, CF2-58G, CF2-58GE, CF2-68G, CF2-68GEM, CF3-512GEV, CF3-512GV, CF3-612GEMV, CF3-612GV, CF4-78GP, CF4-78GP-AUS, CF4-78GPE, CF4-78GP-USA, CF4-98G, CF4-98GE, CF6-712GP, CF6-712GPE, CF6-712GPEV, CF6-712GPV, CF6-712GPVUSA, CF6-912G, CF6-912GE, CF6-912GEV, CF6-912GV, CF-712GPE, CF8-916G, CF8-916GE, CF8-916GEV, CF8-916GV, CFA4-78G, CFA4-98G, CFA6-712GV, CFA6-912GV, CFM2-68GEM, CFM3-612GEMV, CFV4-78GPE, CFV4-98GE, CFV6-712GPEV, CFV6-912GEV, CPT-64G, CPT-74G, CPT-76G, PC1T-64G, PC2T-68G, PC3-612G, PC3T-612G, PC-712GP, PC-712GP-USA, PC-716GP...(Other models you can see in the webshop) | | |

| spare parts for | | 101919 | | |
|---|---|--------|----------|---|
|  | Part No. | 100278 | Ref. No. | — |
| | bypass nozzle type PEL20/21 bore ø 0.75mm thread M5x0.5 | | | |
|  | Part No. | 101060 | Ref. No. | — |
| | magnet unit standard L 39mm D1 ø 15.4mm D2 ø 11mm suitable for PEL20-21/JUNKERS/EGA | | | |
|  | Part No. | 101231 | Ref. No. | — |
| | thermocouple nut T1: M9x1 T2: M18x1 | | | |
|  | Part No. | 101874 | Ref. No. | — |
| | gas tap front part shaft ø 8x6.5mm shaft L 22/15mm shaft flat right/left type PEL21 | | | |







| accessories for | | 101919 | | |
|---|---|--------|----------|-----------|
|  | Part No. | 100908 | Ref. No. | — |
| | union screw thread M10x1 for pipe ø 4mm Qty 1 pcs | | | |
|  | Part No. | 100909 | Ref. No. | 533018500 |
| | union screw thread M10x1 for pipe ø 6mm Qty 1 pcs | | | |
|  | Part No. | 101246 | Ref. No. | — |
| | olive for pipe ø 4mm Qty 1 pcs | | | |
|  | Part No. | 101278 | Ref. No. | 533039300 |
| | olive for pipe ø 10mm Qty 1 pcs | | | |
|  | Part No. | 101286 | Ref. No. | — |
| | olive ID ø 6mm Qty 1 pcs | | | |
|  | Part No. | 101300 | Ref. No. | 533010800 |
| | union nut thread M16x1.5 tube ø 10mm | | | |

Table continues overleaf



| accessories for | | 101919 | | |
|-----------------|---|----------|-----------|--|
| Part No. | 101450 | Ref. No. | — | |
| | olive for pipe ø 8mm L 12.7mm Qty 1 pcs ED ø 10mm | | | |
| Part No. | 101451 | Ref. No. | — | |
| | union nut thread M16x1.5 tube ø 8mm | | | |
| Part No. | 110081 | Ref. No. | 536017100 | |
| | knob ø 70mm shaft ø 8x6.5mm shaft flat universal | | | |
| Part No. | 112206 | Ref. No. | — | |
| | knob dial plate silver gas tap PEL21/22/23 t.max.°C ED ø 63mm ID ø 45.5mm | | | |

|  | | | | |
|---|--|----------|-----------|-----------|
| 1 | | | | |
| Part No. | 107830 | Ref. No. | 531018900 | |
| description | gas tap PEL type 21S gas inlet M16x1.5 (tube ø 10mm) bypass nozzle ø 0.7mm gas outlet M16x1.5 (tube ø 10/8mm) thermocouple connection M9x1 pilot connection M10x1 shaft ø 8x6.5mm shaft L 22/15mm shaft flat upper | | | |
| For models: | BR-62G, CW-61G, CW-62G | | | |
| spare parts for | 107830 | | | |
| | Part No. | 100552 | Ref. No. | — |
| bypass nozzle type PEL20/21 bore ø 0.7mm thread M5x0.5 | | | | |
| | Part No. | 101060 | Ref. No. | — |
| magnet unit standard L 39mm D1 ø 15.4mm D2 ø 11mm suitable for PEL20-21/JUNKERS/EGA | | | | |
| | Part No. | 101230 | Ref. No. | — |
| thermocouple nut T1: M8x1 T2: M18x1 aluminium | | | | |
| | Part No. | 101877 | Ref. No. | — |
| gas tap front part shaft ø 6x4.6mm type PEL21 | | | | |
| accessories for | 107830 | | | |
| | Part No. | 100908 | Ref. No. | — |
| union screw thread M10x1 for pipe ø 4mm Qty 1 pcs | | | | |
| | Part No. | 100909 | Ref. No. | 533018500 |
| union screw thread M10x1 for pipe ø 6mm Qty 1 pcs | | | | |
| | Part No. | 101246 | Ref. No. | — |
| olive for pipe ø 4mm Qty 1 pcs | | | | |
| | Part No. | 101278 | Ref. No. | 533039300 |
| olive for pipe ø 10mm Qty 1 pcs | | | | |
| | Part No. | 101286 | Ref. No. | — |
| olive ID ø 6mm Qty 1 pcs | | | | |
| | Part No. | 101300 | Ref. No. | 533010800 |
| union nut thread M16x1.5 tube ø 10mm | | | | |
| | Part No. | 101450 | Ref. No. | — |
| olive for pipe ø 8mm L 12.7mm Qty 1 pcs ED ø 10mm | | | | |

| accessories for | | 107830 | | |
|-----------------|-------------------------------------|----------|---|--|
| Part No. | 101451 | Ref. No. | — | |
| | union nut thread M16x1.5 tube ø 8mm | | | |

|  | | | | |
|--|---|----------|-----------|-----------|
| 1 | | | | |
| Part No. | 101220 | Ref. No. | 531032100 | |
| description | gas tap PEL type 21S gas inlet M16x1.5 (tube ø 10mm) bypass nozzle ø 1mm gas outlet M16x1.5 (tube ø 10/8mm) thermocouple connection M9x1 pilot connection M10x1 shaft ø 8x6.5mm shaft L 22/15mm shaft flat right | | | |
| For models: | CP-74G, CP-74G-USA, CP-78, CP-78G, CP-78G-USA, CP-94G, CP-98G, CPA-74G, CPA-78G, CPA-94G, CPA-98G, CPM-6G, CWT-66G, TP2-712GP, TP2-78GP, TP2-912G, TP2-98G, TP2T-712GP, TP2T-78GP, TP2T-912G, TP2T-98G, TP4-712GP, TP4-912G, TP4T-610G, TP4T-712GP, TP4T-912G, TP-74G, TP-78G, TP-94G, TP-98G, TPF2-712GP, TPF2-712GPEV, TPF2-712GPV, TPF2-78GP, TPF2-78GPE, TPF2-912G, TPF2-912GE, TPF2-912GEV, TPF2-912GV, TPF2-98G, TPF2-98GE, TPF4-610G, TPF4-610GEM, TPF4-712GP, TPF4-712GPE, TPF4-712GPEV, TPF4-712GPV, TPF4-912G, TPF4-912GE, TPF4-912GEV..(Other models you can see in the webshop) | | | |
| spare parts for | 101220 | | | |
| | Part No. | 100529 | Ref. No. | — |
| bypass nozzle type PEL20/21 bore ø 1mm thread M5x0.5 | | | | |
| | Part No. | 101231 | Ref. No. | — |
| thermocouple nut T1: M9x1 T2: M18x1 | | | | |
| accessories for | 101220 | | | |
| | Part No. | 101277 | Ref. No. | — |
| olive ID ø 8mm Qty 1 pcs | | | | |
| | Part No. | 101278 | Ref. No. | 533039300 |
| olive for pipe ø 10mm Qty 1 pcs | | | | |
| | Part No. | 101300 | Ref. No. | 533010800 |
| union nut thread M16x1.5 tube ø 10mm | | | | |
| | Part No. | 101451 | Ref. No. | — |
| union nut thread M16x1.5 tube ø 8mm | | | | |





23S/O series



1







| Part No. | 101091 | Ref. No. | 10038 |
|---|--|----------|--------------------|
| description | gas tap PEL type 23S/O gas inlet M28x1.5 (tube ø 20mm) bypass nozzle ø 0.35mm gas outlet M24x1.5 (tube ø 16mm) thermocouple connection M9x1 pilot connection M10x1 shaft ø 10x8mm shaft L 35/19mm shaft flat upper | | |
| spare parts for | 101091 | | |
|  | Part No. | 100455 | Ref. No. — |
| | bypass nozzle type PEL23/24 bore ø 0.35mm thread M8x0.5 | | |
|  | Part No. | 101045 | Ref. No. — |
| | magnet unit T1: M9x1 T2: M22x1 L 46mm ø 18mm suitable for PEL23S M9x1 | | |
|  | Part No. | 101244 | Ref. No. — |
| | gas connection thread M24x1.5 tube ø 12/16mm horizontal for PEL gas taps | | |
|  | Part No. | 101336 | Ref. No. — |
| | gas tap front part shaft ø 10x8mm shaft L 35/17mm shaft flat upper/lower suitable for PEL23S | | |
|  | Part No. | 101463 | Ref. No. — |
| | screw suitable for PEL23S Qty 4 pcs | | |
|  | Part No. | 528455 | Ref. No. — |
| | O-ring Viton thickness 2.62mm ID ø 18.72mm Qty 1 pcs | | |
| accessories for | 101091 | | |
|  | Part No. | 100908 | Ref. No. — |
| | union screw thread M10x1 for pipe ø 4mm Qty 1 pcs | | |
|  | Part No. | 100909 | Ref. No. 533018500 |
| | union screw thread M10x1 for pipe ø 6mm Qty 1 pcs | | |
|  | Part No. | 101246 | Ref. No. — |
| | olive for pipe ø 4mm Qty 1 pcs | | |
|  | Part No. | 101252 | Ref. No. — |
| | union nut thread M24x1.5 for pipe ø 12mm | | |
|  | Part No. | 101253 | Ref. No. — |
| | union nut thread M24x1.5 PEL for pipe ø 16mm | | |
|  | Part No. | 101254 | Ref. No. — |
| | union nut thread M28x1.5 tube ø 20mm | | |
|  | Part No. | 101255 | Ref. No. — |
| | olive for pipe ø 12mm Qty 1 pcs | | |
|  | Part No. | 101256 | Ref. No. — |
| | olive for pipe ø 16mm Qty 1 pcs | | |
|  | Part No. | 101257 | Ref. No. — |
| | olive for pipe ø 20mm Qty 1 pcs | | |

| accessories for | | 101091 | |
|---|---|--------|------------|
|  | Part No. | 101286 | Ref. No. — |
| | olive ID ø 6mm Qty 1 pcs | | |
|  | Part No. | 110080 | Ref. No. — |
| | knob ø 70mm shaft ø 10x8mm shaft flat universal | | |
|  | Part No. | 112206 | Ref. No. — |
| | knob dial plate silver gas tap PEL21/22/23 t.max.°C ED ø 63mm ID ø 45.5mm | | |

SKG



1

| Part No. | 101825 | Ref. No. | 531034500 |
|---|--|----------|---------------------------------|
| description | gas tap SKG gas inlet pipe flange bypass nozzle ø 0.4mm gas outlet M13x1 IT (tube ø 8mm) thermocouple connection M8x1 shaft ø 6x4.6mm shaft L 30/12mm shaft flat upper | | |
| spare parts for | 101825 | | |
|  | Part No. | 101051 | Ref. No. — |
| | magnet unit L 27mm D1 ø 12.5mm D2 ø 8.5mm suitable for JUNKERS/EGA/MADEC/SABAF standard | | |
| accessories for | 101825 | | |
|  | Part No. | 101038 | Ref. No. 537023600 |
| | ignition switch 1NO mounting ømm connection F2.8x0.8 | | |
|  | Part No. | 101277 | Ref. No. — |
| | olive ID ø 8mm Qty 1 pcs | | |
|  | Part No. | 101477 | Ref. No. 533016200 533026400 |
| | union screw thread M13x1 tube ø 8mm Qty 1 pcs | | |
|  | Part No. | 101827 | Ref. No. 536020100 |
| | gasket | | |
|  | Part No. | 101828 | Ref. No. 533076900 |
| | bracket for pipe flange | | |







1

| | | | |
|---|--|-----------------|--|
| Part No. | 101829 | Ref. No. | 531034600 |
| description | gas tap SKG gas inlet pipe flange \varnothing 16mm bypass nozzle \varnothing 0.32/0.57mm gas outlet 2x M13x1 (tube \varnothing 8mm) thermocouple connection M8x1 pilot connection shaft \varnothing 6x4.6mm shaft L 30/13mm shaft flat upper | | |
| For models: | CF-10G6-A, CF-10G-6F, CF-10G-A, CF-10GEM, CF-10GEM-6, CF-10GEM6-A, CF-10GEM-A, CF-10GF, CF-62GEM, CF-62GEM-A, CF-8G-A, CF-8GEM, CF-8GEM-A, CF-8GF, CFM-10GEM, CFM-10GEM-6, CFM-10GEM6-A, CFM-10GEM-A, CFM-8GEM, CFM-8GEM-A, PC-61GF, PC-62GF | | |
| spare parts for | 101829 | | |
|  | Part No. | 101051 | Ref. No. — |
| | magnet unit L 27mm D1 \varnothing 12.5mm D2 \varnothing 8.5mm suitable for JUNKERS/EGA/MADEC/SABAF standard | | |
| accessories for | 101829 | | |
|  | Part No. | 101038 | Ref. No. 537023600 |
| | ignition switch 1NO mounting \varnothing mm connection F2.8x0.8 | | |
|  | Part No. | 101277 | Ref. No. — |
| | olive ID \varnothing 8mm Qty 1 pcs | | |
|  | Part No. | 101477 | Ref. No. 533016200 533026400 |
| | union screw thread M13x1 tube \varnothing 8mm Qty 1 pcs | | |
|  | Part No. | 101827 | Ref. No. 536020100 |
| | gasket | | |
|  | Part No. | 101828 | Ref. No. 533076900 |
| | bracket for pipe flange | | |



1

| | | | |
|---|--|-----------------|---------------------------|
| Part No. | 101154 | Ref. No. | 531002100 531002300 |
| description | gas tap SKG without ignition flame connection | | |
| For models: | CF-10G6-A, CF-10G-6F, CF-10G-A, CF-10GEM, CF-10GEM-6, CF-10GEM6-A, CF-10GEM-A, CF-10GF, CF-62GEM, CF-62GEM-A, CF-8G-A, CF-8GEM, CF-8GEM-A, CF-8GF, CFM-10GEM, CFM-10GEM-6, CFM-10GEM6-A, CFM-10GEM-A, CFM-8GEM, CFM-8GEM-A, PC-61GF, PC-62GF | | |
| spare parts for | 101154 | | |
|  | Part No. | 101060 | Ref. No. — |
| | magnet unit standard L 39mm D1 \varnothing 15.4mm D2 \varnothing 11mm suitable for PEL20-21/JUNKERS/EGA | | |
| accessories for | 101154 | | |
|  | Part No. | 101060 | Ref. No. — |
| | magnet unit standard L 39mm D1 \varnothing 15.4mm D2 \varnothing 11mm suitable for PEL20-21/JUNKERS/EGA | | |
|  | Part No. | 101351 | Ref. No. 533018100 |
| | mounting strap for gas tap | | |

| | | | |
|---|---|--------|---------------------------|
| accessories for | 101154 | | |
|  | Part No. | 101376 | Ref. No. 536000801 |
| | gasket ID \varnothing 8mm ED \varnothing 12mm H 3/5mm | | |



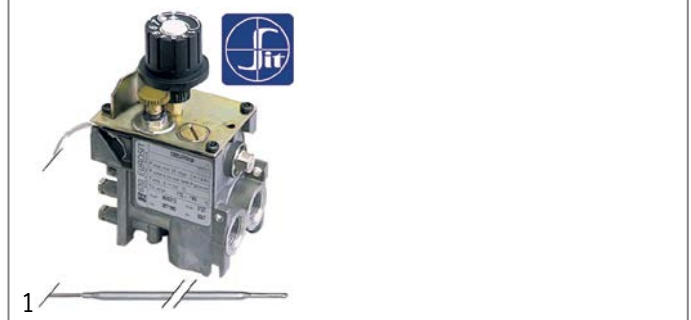

gas thermostats

SIT





630 Eurosit series

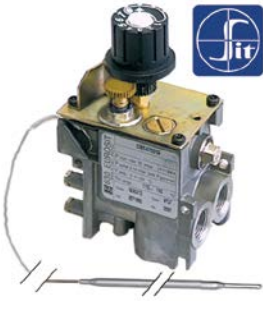

1

| | | | |
|---|---|-----------------|---------------------------|
| Part No. | 101413 | Ref. No. | 531025100 531025400 |
| description | gas thermostat type 630 Eurosit series t.max. 100°C 30-100°C gas inlet 3/8" gas outlet 3/8" thermocouple connection M9x1 pilot connection M10x1 probe \varnothing 5mm probe L 122mm capillary pipe 1050mm SIT | | |
| For models: | BM-4G, BM-6G, BM-74G, BM-78G, BM-8G, BM-94G, BM-98G, BMT-64G, BMT-66G, BMT-94G, BMT-98G, CP-6G | | |
| accessories for | 101413 | | |
|  | Part No. | 100904 | Ref. No. — |
| | locking screw M10x1 for pipe \varnothing 4mm Qty 1 pcs | | |
|  | Part No. | 100905 | Ref. No. — |
| | locking screw M10x1 for pipe \varnothing 6mm Qty 1 pcs | | |
|  | Part No. | 101273 | Ref. No. 533017900 |
| | olive for pipe \varnothing 12mm L 9.5mm brass Qty 1 pcs suitable for universal | | |
|  | Part No. | 101276 | Ref. No. 533018000 |
| | union screw thread 3/8" tube \varnothing 12mm Qty 1 pcs | | |
|  | Part No. | 101333 | Ref. No. 533053600 |
| | plug thread 3/8" with O-ring | | |















| | | | |
|---|--|-----------------|---------------------------|
| Part No. | 101188 | Ref. No. | 531025200 |
| description | gas thermostat type 630 Eurosit series t.max. 190°C 110-190°C gas inlet 3/8" gas outlet 3/8" thermocouple connection M9x1 pilot connection M10x1 probe ø 4mm probe L 202mm capillary pipe 1050mm SIT | | |
| For models: | F11-54G, F13-64G, F13-74G, F13T-74G, F13T-94G, F18-74G, F2-13-78G, F2-13T-78G, F2-13T-98G, F2-18-78G, F2-8-74G, F2-8-94G, F2-8T-66G, F2-8T-74G, F2-8T-94G, F8T-63G, FP-6G, FQ-4G, FQ-6G, FQM-4G | | |
| accessories for | 101188 | | |
|  | Part No. | 100904 | Ref. No. — |
| | locking screw M10x1 for pipe ø 4mm Qty 1 pcs | | |
|  | Part No. | 100905 | Ref. No. — |
| | locking screw M10x1 for pipe ø 6mm Qty 1 pcs | | |
|  | Part No. | 101273 | Ref. No. 533017900 |
| | olive for pipe ø 12mm L 9.5mm brass Qty 1 pcs suitable for universal | | |
|  | Part No. | 101276 | Ref. No. 533018000 |
| | union screw thread 3/8" tube ø 12mm Qty 1 pcs | | |
|  | Part No. | 101333 | Ref. No. 533053600 |
| | plug thread 3/8" with O-ring | | |



| | | | |
|--------------------|---|-----------------|-----------|
| Part No. | 107781 | Ref. No. | 531025201 |
| description | gas thermostat type 630 Eurosit series t.max. 190°C 110-190°C gas inlet 3/8" gas outlet 3/8" thermocouple connection M9x1 pilot connection M10x1 probe ø 4mm probe L 208mm capillary pipe 1000mm SIT operable temperature range 110-190 | | |
| For models: | F13-64G, F13-74G, F13T-74G, F13T-94G, F18-74G, F2-13-78G, F2-13T-78G, F2-13T-98G, F2-18-78G, F2-8-74G, F2-8-94G, F2-8T-66G, F2-8T-74G, F2-8T-94G, F8T-63G, FP-6G, FQ-4G, FQ-6G, FQM-4G | | |



| | | | |
|---|---|-----------------|---------------------------|
| Part No. | 101125 | Ref. No. | 530100080 531025300 |
| description | gas thermostat type 630 Eurosit series t.max. 340°C 100-340°C gas inlet 3/8" gas outlet 3/8" thermocouple connection M9x1 pilot connection M10x1 probe ø 4mm probe L 72mm capillary pipe 1050mm SIT | | |
| For models: | FTL-4G, FTL-4GS, FTL-54G, FTL-56G, FTL-6G, FTL-6GS, FTL-712G, FTL-712GS, FTL-74G, FTL-74GS, FTL-76G, FTL-78G, FTL-78GS, FTL-8G, FTL-8GS, FTL-916G, FTL-94G, FTL-94GS, FTL-98G, FTL-98GS, FTLR-56G, FTLR-6G, FTLR-6GS, FTLR-712G, FTLR-712GS, FTLR-76G, FTLR-78G, FTLR-78GS, FTLR-8G, FTLR-8GS, FTLR-8GS, FTLR-98G, FTLR-98GS, FTR-4G, FTR-4GS, FTR-54G, FTR-56G, FTR-6G, FTR-6GS, FTR-712G, FTR-712GS, FTR-74G, FTR-74GS, FTR-76G, FTR-78G, FTR-78GS, FTR-8G, FTR-8GS, FTR-94G, FTR-94GS, FTR-98G...(Other models you can see in the webshop) | | |
| accessories for | 101125 | | |
|  | Part No. | 100825 | Ref. No. — |
| | gas tap spindle shaft ø 8x6.5mm shaft L 22/14mm suitable for EUROSIT | | |
|  | Part No. | 100904 | Ref. No. — |
| | locking screw M10x1 for pipe ø 4mm Qty 1 pcs | | |
|  | Part No. | 100905 | Ref. No. — |
| | locking screw M10x1 for pipe ø 6mm Qty 1 pcs | | |
|  | Part No. | 100949 | Ref. No. — |
| | gasket suitable for 630 Eurosit series | | |
|  | Part No. | 101273 | Ref. No. 533017900 |
| | olive for pipe ø 12mm L 9.5mm brass Qty 1 pcs suitable for universal | | |
|  | Part No. | 101276 | Ref. No. 533018000 |
| | union screw thread 3/8" tube ø 12mm Qty 1 pcs | | |
|  | Part No. | 101333 | Ref. No. 533053600 |
| | plug thread 3/8" with O-ring | | |
|  | Part No. | 101390 | Ref. No. — |
| | gas tap spindle shaft ø 6x4.6mm shaft L 32/15mm gas tap with ignition flame suitable for ZANUSSI, MARENO for gas thermostat EUROSIT | | |
|  | Part No. | 101392 | Ref. No. 536017200 |
| | adapter suitable for 630 Eurosit series | | |
|  | Part No. | 110357 | Ref. No. — |
| | gas tap spindle shaft ø 8x6.5mm shaft L 36/12mm suitable for 630 Eurosit series | | |
|  | Part No. | 110358 | Ref. No. — |
| | adapter shaft ø 10x8mm shaft L 29/18mm suitable for 630 Eurosit series | | |



710 Minisit series

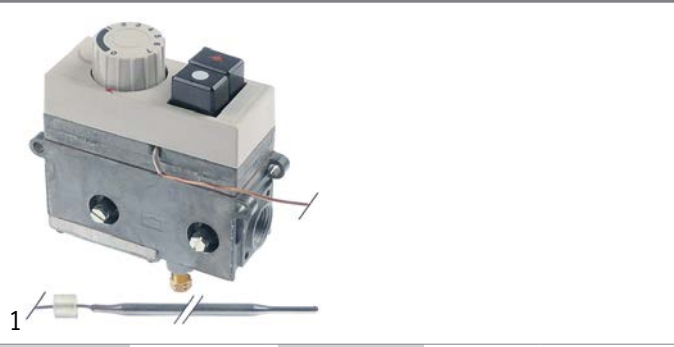

| | | | |
|------------------------|--|-----------------|--------------------|
| Part No. | 101689 | Ref. No. | 531001900 |
| description | gas thermostat SIT type MINISIT 710 t.max. 110°C 40-110°C gas inlet 1/2" gas outlet 3/8" thermocouple connection M9x1 pilot connection M10x1 probe ø 5mm probe L 125mm capillary pipe 1050mm probe type type A1 pressure controller no pressure regulator mbar gland nut | | |
| For models: | CP-62G | | |
| spare parts for | 101689 | | |
| | Part No. | 101053 | Ref. No. 531001200 |
| | magnet unit T1: M9x1 T2: M24x1 L 45mm ø 17mm suitable for Minisit | | |
| | Part No. | 102100 | Ref. No. 531014200 |
| | probe 30-100°C probe ø 5mm probe L 122mm capillary pipe 1050mm t.max. 100°C bain marie probe type type A1 suitable for MINISIT 710 | | |
| accessories for | 101689 | | |
| | Part No. | 100809 | Ref. No. 536000500 |
| | O-ring EPDM thickness 2mm ID ø 21mm Qty 1 pcs | | |
| | Part No. | 100820 | Ref. No. 533018400 |
| | gland duct ET M14x1.5 IT M10x0.75 probe ø max. 6.5mm WS 22 | | |
| | Part No. | 100904 | Ref. No. — |
| | locking screw M10x1 for pipe ø 4mm Qty 1 pcs | | |
| | Part No. | 100905 | Ref. No. — |
| | locking screw M10x1 for pipe ø 6mm Qty 1 pcs | | |
| | Part No. | 101054 | Ref. No. — |
| | magnet unit T1: M10x1 T2: M24x1 L 45mm ø 17mm suitable for Minisit | | |
| | Part No. | 101136 | Ref. No. — |
| | piezoelectric igniter suitable for Minisit with cover cap ømm connection F6.3x0.8 | | |
| | Part No. | 101137 | Ref. No. 536000700 |
| | cover cap without piezoelectric igniter | | |
| | Part No. | 101267 | Ref. No. — |
| | reducer IT 3/8" ET 1/2" L 21mm | | |
| | Part No. | 101268 | Ref. No. 533018200 |
| | gas connection thread 3/8" angled with O-ring MINISIT 710 | | |
| | Part No. | 101269 | Ref. No. — |
| | gas connection thread 1/2" angled with O-ring MINISIT 710 | | |
| | Part No. | 101270 | Ref. No. — |
| | screw connection IT 3/8" ET 3/8" L 28mm | | |

| | | | |
|------------------------|--|--------|--------------------|
| accessories for | 101689 | | |
| | Part No. | 101272 | Ref. No. — |
| | screw connection IT 1/2" ET 3/8" L 57mm | | |
| | Part No. | 101273 | Ref. No. 533017900 |
| | olive for pipe ø 12mm L 9.5mm brass Qty 1 pcs suitable for universal | | |
| | Part No. | 101274 | Ref. No. — |
| | olive for pipe ø 16mm Qty 1 pcs | | |
| | Part No. | 101275 | Ref. No. — |
| | union screw thread 1/2" for pipe ø 16mm Qty 1 pcs | | |
| | Part No. | 101276 | Ref. No. 533018000 |
| | union screw thread 3/8" tube ø 12mm Qty 1 pcs | | |
| | Part No. | 110068 | Ref. No. 536000600 |
| | knob suitable for Minisit ø 37mm | | |

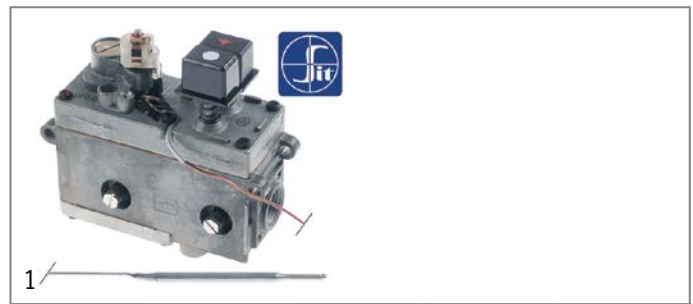



| | | | |
|------------------------|---|-----------------|--------------------|
| Part No. | 101135 | Ref. No. | 531002700 |
| description | gas thermostat SIT type MINISIT 710 t.max. 190°C 110-190°C gas inlet 1/2" gas outlet 3/8" thermocouple connection M9x1 pilot connection M10x1 probe ø 6mm probe L 102mm capillary pipe 1050mm probe type type A3 pressure controller no pressure regulator mbar gland nut | | |
| For models: | FG-10, FG-2-10, FMG-10, FMG-15, FMG-2-10, FMG-2-15, FMPG-20, FMPG-30, FP-62G, FPG-20, FPG-30, FQ-61GF, FQ-62GF, FQM-4G | | |
| spare parts for | 101135 | | |
| | Part No. | 101053 | Ref. No. 531001200 |
| | magnet unit T1: M9x1 T2: M24x1 L 45mm ø 17mm suitable for Minisit | | |
| | Part No. | 102118 | Ref. No. 531014100 |
| | probe 110-190°C probe ø 6mm probe L 102mm capillary pipe 1050mm t.max. 190°C fryer probe type type A3 suitable for MINISIT 710 | | |
| accessories for | 101135 | | |
| | Part No. | 100809 | Ref. No. 536000500 |
| | O-ring EPDM thickness 2mm ID ø 21mm Qty 1 pcs | | |
| | Part No. | 100820 | Ref. No. 533018400 |
| | gland duct ET M14x1.5 IT M10x0.75 probe ø max. 6.5mm WS 22 | | |
| | Part No. | 100904 | Ref. No. — |
| | locking screw M10x1 for pipe ø 4mm Qty 1 pcs | | |
| | Part No. | 100905 | Ref. No. — |
| | locking screw M10x1 for pipe ø 6mm Qty 1 pcs | | |
| | Part No. | 101054 | Ref. No. — |
| | magnet unit T1: M10x1 T2: M24x1 L 45mm ø 17mm suitable for Minisit | | |





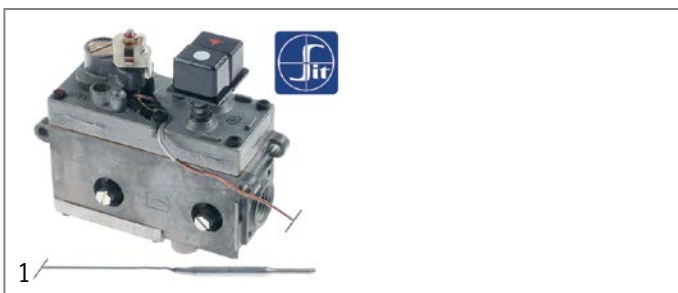











Table continues overleaf



| accessories for | | 101135 | |
|---|---|--------|--------------------|
|  | Part No. | 101136 | Ref. No. — |
| | piezoelectric igniter suitable for Minisit with cover cap ømm connection F6.3x0.8 | | |
|  | Part No. | 101137 | Ref. No. 536000700 |
| | cover cap without piezoelectric igniter | | |
|  | Part No. | 101267 | Ref. No. — |
| | reducer IT 3/8" ET 1/2" L 21mm | | |
|  | Part No. | 101268 | Ref. No. 533018200 |
| | gas connection thread 3/8" angled with O-ring MINISIT 710 | | |
|  | Part No. | 101269 | Ref. No. — |
| | gas connection thread 1/2" angled with O-ring MINISIT 710 | | |
|  | Part No. | 101270 | Ref. No. — |
| | screw connection IT 3/8" ET 3/8" L 28mm | | |
|  | Part No. | 101272 | Ref. No. — |
| | screw connection IT 1/2" ET 3/8" L 57mm | | |
|  | Part No. | 101273 | Ref. No. 533017900 |
| | olive for pipe ø 12mm L 9.5mm brass Qty 1 pcs suitable for universal | | |
|  | Part No. | 101274 | Ref. No. — |
| | olive for pipe ø 16mm Qty 1 pcs | | |
|  | Part No. | 101275 | Ref. No. — |
| | union screw thread 1/2" for pipe ø 16mm Qty 1 pcs | | |
|  | Part No. | 101276 | Ref. No. 533018000 |
| | union screw thread 3/8" tube ø 12mm Qty 1 pcs | | |
|  | Part No. | 110068 | Ref. No. 536000600 |
| | knob suitable for Minisit ø 37mm | | |







| | | | |
|---|--|-----------------|--------------------|
| Part No. | 101132 | Ref. No. | 531002600 |
| description | gas thermostat SIT type MINISIT 710 t.max. 340°C 100-340°C gas inlet 1/2" gas outlet 3/8" thermocouple connection M9x1 pilot connection M10x1 probe ø 5mm probe L 68mm capillary pipe 1050mm probe type type B1 pressure controller no pressure regulator mbar gland nut ignition gas no | | |
| For models: | FTL-61G, FTL-61GF, FTL-61GS, FTL-61GSF, FTL-62G, FTL-62GF, FTL-62GS, FTL-62GSF, FTL-63G, FTL-63GS, FTL-64G, FTL-64GS, FTLR-62G, FTLR-62GF, FTLR-62GS, FTLR-62GSF, FTLR-63G, FTLR-63GS, FTLR-64G, FTLR-64GS, FTR-61G, FTR-61GF, FTR-61GS, FTR-61GSF, FTR-62G, FTR-62GF, FTR-62GS, FTR-62GSF | | |
| spare parts for | 101132 | | |
|  | Part No. | 101053 | Ref. No. 531001200 |
| | magnet unit T1: M9x1 T2: M24x1 L 45mm ø 17mm suitable for Minisit | | |

| spare parts for | | 101132 | |
|---|--|--------|--------------------|
|  | Part No. | 102102 | Ref. No. 531014000 |
| | probe 100-340°C probe ø 5mm probe L 68mm capillary pipe 1750mm t.max. 340°C oven/grill probe type type B1 suitable for MINISIT 710 | | |
| accessories for | | 101132 | |
|  | Part No. | 100809 | Ref. No. 536000500 |
| | O-ring EPDM thickness 2mm ID ø 21mm Qty 1 pcs | | |
|  | Part No. | 100904 | Ref. No. — |
| | locking screw M10x1 for pipe ø 4mm Qty 1 pcs | | |
|  | Part No. | 100905 | Ref. No. — |
| | locking screw M10x1 for pipe ø 6mm Qty 1 pcs | | |
|  | Part No. | 101054 | Ref. No. — |
| | magnet unit T1: M10x1 T2: M24x1 L 45mm ø 17mm suitable for Minisit | | |
|  | Part No. | 101136 | Ref. No. — |
| | piezoelectric igniter suitable for Minisit with cover cap ømm connection F6.3x0.8 | | |
|  | Part No. | 101137 | Ref. No. 536000700 |
| | cover cap without piezoelectric igniter | | |
|  | Part No. | 101267 | Ref. No. — |
| | reducer IT 3/8" ET 1/2" L 21mm | | |
|  | Part No. | 101268 | Ref. No. 533018200 |
| | gas connection thread 3/8" angled with O-ring MINISIT 710 | | |
|  | Part No. | 101269 | Ref. No. — |
| | gas connection thread 1/2" angled with O-ring MINISIT 710 | | |
|  | Part No. | 101270 | Ref. No. — |
| | screw connection IT 3/8" ET 3/8" L 28mm | | |
|  | Part No. | 101272 | Ref. No. — |
| | screw connection IT 1/2" ET 3/8" L 57mm | | |
|  | Part No. | 101273 | Ref. No. 533017900 |
| | olive for pipe ø 12mm L 9.5mm brass Qty 1 pcs suitable for universal | | |
|  | Part No. | 101274 | Ref. No. — |
| | olive for pipe ø 16mm Qty 1 pcs | | |
|  | Part No. | 101275 | Ref. No. — |
| | union screw thread 1/2" for pipe ø 16mm Qty 1 pcs | | |
|  | Part No. | 101276 | Ref. No. 533018000 |
| | union screw thread 3/8" tube ø 12mm Qty 1 pcs | | |
|  | Part No. | 110068 | Ref. No. 536000600 |
| | knob suitable for Minisit ø 37mm | | |



| | | | |
|---|--|-----------------|---------------------------|
|  | | | |
| Part No. | 101130 | Ref. No. | 531001900 531002800 |
| description | gas thermostat without cap, button and angle SIT type MINISIT 710 t.max. 100°C 30-100°C gas inlet 1/2" gas outlet 3/8" thermocouple connection M9x1 pilot connection M10x1 probe ø 5mm probe L 122mm capillary pipe 1050mm t.max. 100°C bain marie probe type type A1 pressure controller no pressure regulator mbar gland nut | | |
| For models: | BM-61GF, BM-62GF | | |
| spare parts for | 101130 | | |
|  | Part No. | 101053 | Ref. No. 531001200 |
| | magnet unit T1: M9x1 T2: M24x1 L 45mm ø 17mm suitable for Minisit | | |
|  | Part No. | 102100 | Ref. No. 531014200 |
| | probe 30-100°C probe ø 5mm probe L 122mm capillary pipe 1050mm t.max. 100°C bain marie probe type type A1 suitable for MINISIT 710 | | |
| accessories for | 101130 | | |
|  | Part No. | 100809 | Ref. No. 536000500 |
| | O-ring EPDM thickness 2mm ID ø 21mm Qty 1 pcs | | |
|  | Part No. | 100820 | Ref. No. 533018400 |
| | gland duct ET M14x1.5 IT M10x0.75 probe ø max. 6.5mm WS 22 | | |
|  | Part No. | 100904 | Ref. No. — |
| | locking screw M10x1 for pipe ø 4mm Qty 1 pcs | | |
|  | Part No. | 100905 | Ref. No. — |
| | locking screw M10x1 for pipe ø 6mm Qty 1 pcs | | |
|  | Part No. | 101054 | Ref. No. — |
| | magnet unit T1: M10x1 T2: M24x1 L 45mm ø 17mm suitable for Minisit | | |
|  | Part No. | 101136 | Ref. No. — |
| | piezoelectric igniter suitable for Minisit with cover cap ømm connection F6.3x0.8 | | |
|  | Part No. | 101137 | Ref. No. 536000700 |
| | cover cap without piezoelectric igniter | | |
|  | Part No. | 101267 | Ref. No. — |
| | reducer IT 3/8" ET 1/2" L 21mm | | |
|  | Part No. | 101268 | Ref. No. 533018200 |
| | gas connection thread 3/8" angled with O-ring MINISIT 710 | | |
|  | Part No. | 101269 | Ref. No. — |
| | gas connection thread 1/2" angled with O-ring MINISIT 710 | | |
|  | Part No. | 101270 | Ref. No. — |
| | screw connection IT 3/8" ET 3/8" L 28mm | | |
|  | Part No. | 101272 | Ref. No. — |
| | screw connection IT 1/2" ET 3/8" L 57mm | | |

| | | | |
|---|--|--------|---------------------------|
| accessories for | 101130 | | |
|  | Part No. | 101273 | Ref. No. 533017900 |
| | olive for pipe ø 12mm L 9.5mm brass Qty 1 pcs suitable for universal | | |
|  | Part No. | 101274 | Ref. No. — |
| | olive for pipe ø 16mm Qty 1 pcs | | |
|  | Part No. | 101275 | Ref. No. — |
| | union screw thread 1/2" for pipe ø 16mm Qty 1 pcs | | |
|  | Part No. | 101276 | Ref. No. 533018000 |
| | union screw thread 3/8" tube ø 12mm Qty 1 pcs | | |
|  | Part No. | 110068 | Ref. No. 536000600 |
| | knob suitable for Minisit ø 37mm | | |







| | | | |
|---|---|-----------------|---------------------------|
|  | | | |
| Part No. | 101131 | Ref. No. | 531002700 |
| description | gas thermostat without cap, button and angle SIT type MINISIT 710 t.max. 190°C 50-190°C gas inlet 1/2" gas outlet 3/8" thermocouple connection M9x1 pilot connection M10x1 probe ø 5mm probe L 98mm capillary pipe 1200mm probe type type A2 pressure controller no pressure regulator mbar gland nut | | |
| spare parts for | 101131 | | |
|  | Part No. | 101053 | Ref. No. 531001200 |
| | magnet unit T1: M9x1 T2: M24x1 L 45mm ø 17mm suitable for Minisit | | |
|  | Part No. | 102103 | Ref. No. 531014100 |
| | probe 60-200°C probe ø 5mm probe L 98mm capillary pipe 1050mm t.max. 200°C fryer probe type type A2 suitable for MINISIT 710 | | |
| accessories for | 101131 | | |
|  | Part No. | 100809 | Ref. No. 536000500 |
| | O-ring EPDM thickness 2mm ID ø 21mm Qty 1 pcs | | |
|  | Part No. | 100820 | Ref. No. 533018400 |
| | gland duct ET M14x1.5 IT M10x0.75 probe ø max. 6.5mm WS 22 | | |
|  | Part No. | 100904 | Ref. No. — |
| | locking screw M10x1 for pipe ø 4mm Qty 1 pcs | | |
|  | Part No. | 100905 | Ref. No. — |
| | locking screw M10x1 for pipe ø 6mm Qty 1 pcs | | |
|  | Part No. | 101054 | Ref. No. — |
| | magnet unit T1: M10x1 T2: M24x1 L 45mm ø 17mm suitable for Minisit | | |
|  | Part No. | 101136 | Ref. No. — |
| | piezoelectric igniter suitable for Minisit with cover cap ømm connection F6.3x0.8 | | |
|  | Part No. | 101137 | Ref. No. 536000700 |
| | cover cap without piezoelectric igniter | | |

Table continues overleaf



| accessories for 101131 | |
|---|--|
|  | Part No. 101267 Ref. No. — reducer IT 3/8" ET 1/2" L 21mm |
|  | Part No. 101268 Ref. No. 533018200 gas connection thread 3/8" angled with O-ring MINISIT 710 |
|  | Part No. 101269 Ref. No. — gas connection thread 1/2" angled with O-ring MINISIT 710 |
|  | Part No. 101270 Ref. No. — screw connection IT 3/8" ET 3/8" L 28mm |
|  | Part No. 101272 Ref. No. — screw connection IT 1/2" ET 3/8" L 57mm |
|  | Part No. 101273 Ref. No. 533017900 olive for pipe ø 12mm L 9.5mm brass Qty 1 pcs suitable for universal |
|  | Part No. 101274 Ref. No. — olive for pipe ø 16mm Qty 1 pcs |
|  | Part No. 101275 Ref. No. — union screw thread 1/2" for pipe ø 16mm Qty 1 pcs |
|  | Part No. 101276 Ref. No. 533018000 union screw thread 3/8" tube ø 12mm Qty 1 pcs |
|  | Part No. 110068 Ref. No. 536000600 knob suitable for Minisit ø 37mm |

accessories

probes



| | | | |
|--------------------|---|-----------------|-----------|
| Part No. | 102102 | Ref. No. | 531014000 |
| description | probe 100-340°C probe ø 5mm probe L 68mm capillary pipe 1750mm t.max. 340°C oven/grill probe type type B1 suitable for MINISIT 710 | | |
| For models: | FTL-61G, FTL-61GS, FTL-62G, FTL-62GS, FTL-63G, FTL-63GS, FTL-64G, FTL-64GS, FTLR-62G, FTLR-62GS, FTLR-63G, FTLR-63GS, FTLR-64G, FTLR-64GS, FTR-61G, FTR-61GS, FTR-62G, FTR-62GS | | |

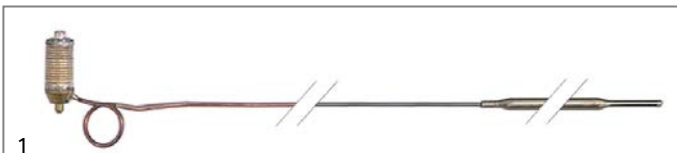

| | | | |
|--------------------|--|-----------------|-----------|
| Part No. | 102101 | Ref. No. | 531014000 |
| description | probe 100-340°C probe ø 5mm probe L 70mm capillary pipe 1000mm t.max. 340°C suitable for MINISIT 710 | | |



| | | | |
|---|--|--------------------|-----------|
| Part No. | 102118 | Ref. No. | 531014100 |
| description | probe 110-190°C probe ø 6mm probe L 102mm capillary pipe 1050mm t.max. 190°C fryer probe type type A3 suitable for MINISIT 710 | | |
| For models: | FG-10, FG-2-10, FMG-10, FMG-15, FMG-2-10, FMG-2-15, FMPG-20, FMPG-30, FP-62G, FPG-20, FPG-30, FQ-61GF, FQ-62GF, FQM-4G | | |
| accessories for | 102118 | | |
|  | Part No. 100820 | Ref. No. 533018400 | |
| | gland duct ET M14x1.5 IT M10x0.75 probe ø max. 6.5mm WS 22 | | |

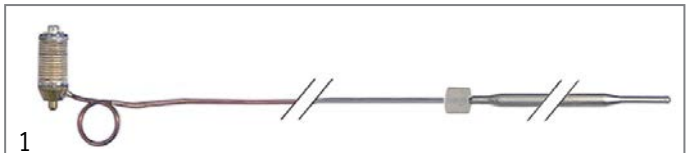

| | | | |
|--------------------|--|-----------------|-----------|
| Part No. | 102100 | Ref. No. | 531014200 |
| description | probe 30-100°C probe ø 5mm probe L 122mm capillary pipe 1050mm t.max. 100°C bain marie probe type type A1 suitable for MINISIT 710 | | |
| For models: | BM-61GF, BM-62GF, CP-62G, F18-94G | | |

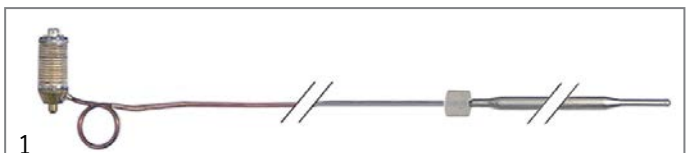

| | | | |
|--------------------|--|-----------------|-----------|
| Part No. | 102103 | Ref. No. | 531014100 |
| description | probe 60-200°C probe ø 5mm probe L 98mm capillary pipe 1050mm t.max. 200°C fryer probe type type A2 suitable for MINISIT 710 | | |

PEL

24ST series



| | | | |
|--------------------|--|-----------------|------------------------|
| Part No. | 101759 | Ref. No. | 531045700 531045800 |
| description | gas thermostat PEL type 24ST 100-300°C gas inlet M20x1.5 (tube ø 12mm) bypass nozzle ø 1.5mm gas outlet M20x1.5 (tube ø 12/10mm) thermocouple connection M9x1 pilot connection M10x1 capillary pipe 1200mm probe ø 6mm probe L 100mm shaft ø 10x8mm shaft L 27/17mm shaft flat upper | | |
| For models: | BRF-94G, BRF-98G | | |

| | | | |
|-----------------|--------|-----------------|---|
| Part No. | 101759 | Ref. No. | — |
|-----------------|--------|-----------------|---|

| | | | |
|---|--|------------|--|
|  | Part No. 100679 | Ref. No. — | |
| | bypass nozzle type PEL23/24 bore ø 1.5mm thread M8x0.5 | | |

| | | | |
|---|--|------------|--|
|  | Part No. 101058 | Ref. No. — | |
| | magnet unit L 39mm D1 ø 15.4mm D2 ø 13.5mm suitable for PEL22/ EGA24197 standard | | |











| | | | |
|---|---|------------|--|
|  | Part No. 106200 | Ref. No. — | |
| | nut thread M9x1 suitable for PEL 24/25S | | |

Table continues overleaf



| accessories for | | 101759 | | |
|---|---|--------|----------|-----------|
|  | Part No. | 100908 | Ref. No. | — |
| | union screw thread M10x1 for pipe ø 4mm Qty 1 pcs | | | |
|  | Part No. | 100909 | Ref. No. | 533018500 |
| | union screw thread M10x1 for pipe ø 6mm Qty 1 pcs | | | |
|  | Part No. | 101246 | Ref. No. | — |
| | olive for pipe ø 4mm Qty 1 pcs | | | |
|  | Part No. | 101248 | Ref. No. | — |
| | olive for pipe ø 12mm Qty 1 pcs suitable for PEL | | | |
|  | Part No. | 101249 | Ref. No. | — |
| | olive for pipe ø 10mm Qty 1 pcs | | | |
|  | Part No. | 101250 | Ref. No. | — |
| | union nut thread M20x1.5 for pipe ø 10mm | | | |
|  | Part No. | 101251 | Ref. No. | — |
| | union nut thread M20x1.5 for pipe ø 12mm | | | |
|  | Part No. | 101286 | Ref. No. | — |
| | olive ID ø 6mm Qty 1 pcs | | | |
|  | Part No. | 110079 | Ref. No. | — |
| | knob dial plate gas thermostat 1-8 silver | | | |
|  | Part No. | 110080 | Ref. No. | — |
| | knob ø 70mm shaft ø 10x8mm shaft flat universal | | | |

| accessories for | | 101172 | | |
|---|---|--------|----------|-----------|
|  | Part No. | 100908 | Ref. No. | — |
| | union screw thread M10x1 for pipe ø 4mm Qty 1 pcs | | | |
|  | Part No. | 100909 | Ref. No. | 533018500 |
| | union screw thread M10x1 for pipe ø 6mm Qty 1 pcs | | | |
|  | Part No. | 101246 | Ref. No. | — |
| | olive for pipe ø 4mm Qty 1 pcs | | | |
|  | Part No. | 101278 | Ref. No. | 533039300 |
| | olive for pipe ø 10mm Qty 1 pcs | | | |
|  | Part No. | 101286 | Ref. No. | — |
| | olive ID ø 6mm Qty 1 pcs | | | |
|  | Part No. | 101300 | Ref. No. | 533010800 |
| | union nut thread M16x1.5 tube ø 10mm | | | |
|  | Part No. | 101450 | Ref. No. | — |
| | olive for pipe ø 8mm L 12.7mm Qty 1 pcs ED ø 10mm | | | |
|  | Part No. | 101451 | Ref. No. | — |
| | union nut thread M16x1.5 tube ø 8mm | | | |
|  | Part No. | 110079 | Ref. No. | — |
| | knob dial plate gas thermostat 1-8 silver | | | |
|  | Part No. | 110081 | Ref. No. | 536017100 |
| | knob ø 70mm shaft ø 8x6.5mm shaft flat universal | | | |

| 25ST series | | | | |
|---|--|----------|--|---|
|  | | | | |
| 1 | | | | |
| Part No. | 101172 | Ref. No. | 531031600 531033800 531033900 531034000 531044300 531044400 | |
| description | gas thermostat PEL type 25ST 100-300°C gas inlet M16x1.5 (tube ø 10mm) bypass nozzle ø 0.35mm gas outlet M16x1.5 (tube ø 10/8mm) thermocouple connection M9x1 pilot connection M10x1 capillary pipe 1200mm probe ø 6mm probe L 100mm shaft ø 8x6.5mm shaft L 21/15mm shaft flat upper | | | |
| For models: | BRF-64G, BRF-74G, BRF-78G, BRF-94G, BRF-98G, CF4-78G, CF4-78GP, CF4-78GP-AUS, CF4-78GP-USA, CF4-98G, CF6-712G, CF6-712GP, CF6-712GPV, CF6-712GPV-USA, CF6-712GV, CF6-912G, CF6-912GV, CF8-916G, CF8-916GV, CFA4-78G, CFA4-98G, CFA6-712GV, CFA6-912GV, CFPB6-79G, PAF-78G, PAF-98G, TPF2-712G, TPF2-712GPV, TPF2-712GV, TPF2-78GP, TPF2-912G, TPF2-912GE, TPF2-912GV, TPF2-98G, TPF4-712GP, TPF4-712GPV, TPF4-912G, TPF4-912GV, TPF-78G, TPF-98G | | | |
| spare parts for | 101172 | | | |
|  | Part No. | 100259 | Ref. No. | — |
| | bypass nozzle type PEL22 bore ø 0.35mm thread M6x0.5 | | | |
|  | Part No. | 101060 | Ref. No. | — |
| | magnet unit standard L 39mm D1 ø 15.4mm D2 ø 11mm suitable for PEL20-21/JUNKERS/EGA | | | |
|  | Part No. | 106200 | Ref. No. | — |
| | nut thread M9x1 suitable for PEL 24/25S | | | |







| SABAF | | | | |
|--|--|----------|-----------|------------------------|
|  | | | | |
| 1 | | | | |
| Part No. | 101679 | Ref. No. | 531031800 | |
| description | gas thermostat SABAF t.max. 300°C gas inlet pipe flange bypass nozzle ø 0.35mm gas outlet 3/8" ET (tube ø 10mm) gas outlet 2 M13x1 IT (tube ø 8mm) thermocouple connection M8x1 (2x) capillary pipe 850mm probe ø 4mm probe L 150mm shaft ø 8x6.5mm shaft left L1 34mm L2 14mm | | | |
| For models: | CF4-8G, CF4-8GEM | | | |
| accessories for | 101679 | | | |
|  | Part No. | 101277 | Ref. No. | — |
| | olive ID ø 8mm Qty 1 pcs | | | |
|  | Part No. | 101278 | Ref. No. | 533039300 |
| | olive for pipe ø 10mm Qty 1 pcs | | | |
|  | Part No. | 101351 | Ref. No. | 533018100 |
| | mounting strap for gas tap | | | |
|  | Part No. | 101376 | Ref. No. | 536000801 |
| | gasket ID ø 8mm ED ø 12mm H 3/5mm | | | |
|  | Part No. | 101477 | Ref. No. | 533016200 533026400 |
| | union screw thread M13x1 tube ø 8mm Qty 1 pcs | | | |

Table continues overleaf



| | | | |
|---|---------------------------------------|--------|------------|
| accessories for | 101679 | | |
|  | Part No. | 101478 | Ref. No. — |
| | union nut thread 3/8" for pipe ø 10mm | | |



| | | | |
|-----------------|--------|-----------------|------------------------|
| Part No. | 101175 | Ref. No. | 531008301 531031700 |
|-----------------|--------|-----------------|------------------------|

description
gas thermostat SABAF t.max. 300°C gas inlet pipe flange bypass nozzle ø 0.35mm gas outlet 3/8" ET (tube ø 10mm) gas outlet 2 M13x1 IT (tube ø 8mm) thermocouple connection M8x1 (2x) capillary pipe 850mm probe ø 4mm probe L 150mm shaft ø 8x6.5mm shaft L 27/13mm shaft flat upper

For models: CF-10G6-A, CF-10G-6F, CF-10G-A, CF-10GF, CF4-8G, CF4-8GEM, CF-8G-A, CF-8GF

spare parts for 101175

| | | | |
|---|---|--------|------------|
|  | Part No. | 101060 | Ref. No. — |
| | magnet unit standard L 39mm D1 ø 15.4mm D2 ø 11mm suitable for PEL20-21/JUNKERS/EGA | | |

accessories for 101175

| | | | |
|---|--------------------------|--------|------------|
|  | Part No. | 101277 | Ref. No. — |
| | olive ID ø 8mm Qty 1 pcs | | |

| | | | |
|---|---------------------------------|--------|--------------------|
|  | Part No. | 101278 | Ref. No. 533039300 |
| | olive for pipe ø 10mm Qty 1 pcs | | |

| | | | |
|---|--------------------|--------|--------------------|
|  | Part No. | 101375 | Ref. No. 533016701 |
| | flange for gas tap | | |

| | | | |
|---|-----------------------------------|--------|--------------------|
|  | Part No. | 101376 | Ref. No. 536000801 |
| | gasket ID ø 8mm ED ø 12mm H 3/5mm | | |

| | | | |
|---|---|--------|---------------------------------|
|  | Part No. | 101477 | Ref. No. 533016200 533026400 |
| | union screw thread M13x1 tube ø 8mm Qty 1 pcs | | |

| | | | |
|---|---------------------------------------|--------|------------|
|  | Part No. | 101478 | Ref. No. — |
| | union nut thread 3/8" for pipe ø 10mm | | |

| | | | |
|---|---|--------|--------------------|
|  | Part No. | 110328 | Ref. No. 536003100 |
| | knob gas thermostat 1-10 ø 44mm shaft ø 8x6.5mm shaft flat lower silver | | |

| | | | |
|---|----------|--------|--------------------|
|  | Part No. | 693074 | Ref. No. 533016800 |
| | pipe | | |

| | | | |
|---|---|--------|--------------------|
|  | Part No. | 346333 | Ref. No. 537025300 |
| | microswitch with lever 250V 16A 1NC connection male faston 6.3mm ambient temperature max. 85°C mounting distance 22mm | | |

accessories for 101836

| | | | |
|---|--------------------------|--------|------------|
|  | Part No. | 101277 | Ref. No. — |
| | olive ID ø 8mm Qty 1 pcs | | |

| | | | |
|---|---------------------------------|--------|--------------------|
|  | Part No. | 101278 | Ref. No. 533039300 |
| | olive for pipe ø 10mm Qty 1 pcs | | |

| | | | |
|---|----------------------------|--------|--------------------|
|  | Part No. | 101351 | Ref. No. 533018100 |
| | mounting strap for gas tap | | |

| | | | |
|---|-----------------------------------|--------|--------------------|
|  | Part No. | 101376 | Ref. No. 536000801 |
| | gasket ID ø 8mm ED ø 12mm H 3/5mm | | |

| | | | |
|---|---|--------|---------------------------------|
|  | Part No. | 101477 | Ref. No. 533016200 533026400 |
| | union screw thread M13x1 tube ø 8mm Qty 1 pcs | | |

| | | | |
|---|---------------------------------------|--------|------------|
|  | Part No. | 101478 | Ref. No. — |
| | union nut thread 3/8" for pipe ø 10mm | | |



| | | | |
|-----------------|--------|-----------------|-----------|
| Part No. | 101837 | Ref. No. | 531031801 |
|-----------------|--------|-----------------|-----------|

description
gas thermostat SABAF t.max. 300°C gas inlet pipe flange bypass nozzle ø 0.45mm gas outlet 3/8" ET (tube ø 10mm) gas outlet 2 M13x1 IT (tube ø 8mm) thermocouple connection M8x1 (2x) capillary pipe 850mm probe ø 4mm probe L 140mm shaft ø 8x6.5mm shaft L 34/14mm shaft flat left

For models: CF4-8G

accessories for 101837

| | | | |
|---|--------------------------|--------|------------|
|  | Part No. | 101277 | Ref. No. — |
| | olive ID ø 8mm Qty 1 pcs | | |

| | | | |
|---|---------------------------------|--------|--------------------|
| accessories for | 101837 | | |
|  | Part No. | 101278 | Ref. No. 533039300 |
| | olive for pipe ø 10mm Qty 1 pcs | | |

| | | | |
|---|----------------------------|--------|--------------------|
|  | Part No. | 101351 | Ref. No. 533018100 |
| | mounting strap for gas tap | | |

| | | | |
|---|-----------------------------------|--------|--------------------|
|  | Part No. | 101376 | Ref. No. 536000801 |
| | gasket ID ø 8mm ED ø 12mm H 3/5mm | | |

| | | | |
|---|---|--------|---------------------------------|
|  | Part No. | 101477 | Ref. No. 533016200 533026400 |
| | union screw thread M13x1 tube ø 8mm Qty 1 pcs | | |

| | | | |
|---|---------------------------------------|--------|------------|
|  | Part No. | 101478 | Ref. No. — |
| | union nut thread 3/8" for pipe ø 10mm | | |

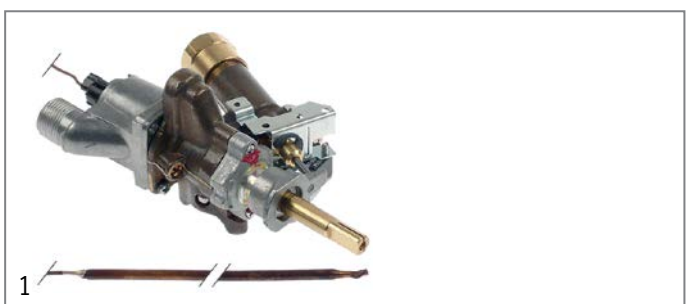

| | | | |
|-----------------|--------|-----------------|-----------|
| Part No. | 101836 | Ref. No. | 531031702 |
|-----------------|--------|-----------------|-----------|

description
gas thermostat t.max. 300°C gas inlet pipe flange ø21mm bypass nozzle ø 0.45mm gas outlet 3/8" ET (tube ø 10mm) gas outlet 2 M13x1 IT (tube ø 8mm) thermocouple connection 2x M8x1 capillary pipe 850mm probe ø 4mm probe L 140mm shaft ø 8x6.5mm shaft L 35/14mm shaft flat left with microswitch

For models: CF-10G6-A, CF-10G-6F, CF-10G-A, CF-10GF, CF-8G-A, CF-8GF

spare parts for 101836

| | | | |
|---|---|--------|--------------------|
|  | Part No. | 346333 | Ref. No. 537025300 |
| | microswitch with lever 250V 16A 1NC connection male faston 6.3mm ambient temperature max. 85°C mounting distance 22mm | | |

accessories for 101836

| | | | |
|---|--------------------------|--------|------------|
|  | Part No. | 101277 | Ref. No. — |
| | olive ID ø 8mm Qty 1 pcs | | |

| | | | |
|---|---------------------------------|--------|--------------------|
|  | Part No. | 101278 | Ref. No. 533039300 |
| | olive for pipe ø 10mm Qty 1 pcs | | |

| | | | |
|---|----------------------------|--------|--------------------|
|  | Part No. | 101351 | Ref. No. 533018100 |
| | mounting strap for gas tap | | |

| | | | |
|---|-----------------------------------|--------|--------------------|
|  | Part No. | 101376 | Ref. No. 536000801 |
| | gasket ID ø 8mm ED ø 12mm H 3/5mm | | |

| | | | |
|---|---|--------|---------------------------------|
|  | Part No. | 101477 | Ref. No. 533016200 533026400 |
| | union screw thread M13x1 tube ø 8mm Qty 1 pcs | | |

| | | | |
|---|---------------------------------------|--------|------------|
|  | Part No. | 101478 | Ref. No. — |
| | union nut thread 3/8" for pipe ø 10mm | | |

| | | | |
|--------------------|---|-----------------|-----------|
| Part No. | 107150 ¹ | Ref. No. | 531008303 |
| description | gas thermostat t.max. 300°C gas inlet pipe flange ø21mm bypass nozzle ø 0.5mm gas outlet 3/8" ET (tube ø 10mm)mm gas outlet 2 M13x1 IT (tube ø 8mm) thermocouple connection 2x M8x1 capillary pipe 850mm probe ø 4mm probe L 140mm shaft ø 8x6.5mm shaft L 35/14mm shaft flat left with microswitch | | |
| For models: | CF-10G6-A, CF-10G-6F, CF-10G-A, CF-10GF, CF-8G-A, CF-8GF | | |

¹with microswitch and additional gas outlet M13x1 IT (tube ø 8mm)

gas valves and ignition boxes





gas control valves

SIT

MINISIT



| | | | |
|------------------------|--|-----------------|------------------------|
| Part No. | 101106 | Ref. No. | 531011000 531032200 |
| description | gas valve gas inlet 3/8" gas outlet 3/8" operable temperature range manual thermocouple connection M9x1 pilot connection M10x1 Minisit SIT | | |
| For models: | CPM-62G | | |
| spare parts for | 101106 | | |

| | | | | |
|---|-----------------|---|-----------------|-----------|
|  | Part No. | 100809 | Ref. No. | 536000500 |
| | | O-ring EPDM thickness 2mm ID ø 21mm Qty 1 pcs | | |
|  | Part No. | 101053 | Ref. No. | 531001200 |
| | | magnet unit T1: M9x1 T2: M24x1 L 45mm ø 17mm suitable for Minisit | | |
|  | Part No. | 101054 | Ref. No. | — |
| | | magnet unit T1: M10x1 T2: M24x1 L 45mm ø 17mm suitable for Minisit | | |
|  | Part No. | 101136 | Ref. No. | — |
| | | piezoelectric igniter suitable for Minisit with cover cap ømm connection F6.3x0.8 | | |
|  | Part No. | 101137 | Ref. No. | 536000700 |
| | | cover cap without piezoelectric igniter | | |
|  | Part No. | 110068 | Ref. No. | 536000600 |
| | | knob suitable for Minisit ø 37mm | | |

| | | | | |
|---|-----------------|--|-----------------|-----------|
| accessories for | 101106 | | | |
|  | Part No. | 100904 | Ref. No. | — |
| | | locking screw M10x1 for pipe ø 4mm Qty 1 pcs | | |
|  | Part No. | 100905 | Ref. No. | — |
| | | locking screw M10x1 for pipe ø 6mm Qty 1 pcs | | |
|  | Part No. | 101267 | Ref. No. | — |
| | | reducer IT 3/8" ET 1/2" L 21mm | | |
|  | Part No. | 101268 | Ref. No. | 533018200 |
| | | gas connection thread 3/8" angled with O-ring MINISIT 710 | | |
|  | Part No. | 101269 | Ref. No. | — |
| | | gas connection thread 1/2" angled with O-ring MINISIT 710 | | |
|  | Part No. | 101270 | Ref. No. | — |
| | | screw connection IT 3/8" ET 3/8" L 28mm | | |
|  | Part No. | 101272 | Ref. No. | — |
| | | screw connection IT 1/2" ET 3/8" L 57mm | | |
|  | Part No. | 101273 | Ref. No. | 533017900 |
| | | olive for pipe ø 12mm L 9.5mm brass Qty 1 pcs suitable for universal | | |
|  | Part No. | 101274 | Ref. No. | — |
| | | olive for pipe ø 16mm Qty 1 pcs | | |
|  | Part No. | 101275 | Ref. No. | — |
| | | union screw thread 1/2" for pipe ø 16mm Qty 1 pcs | | |
|  | Part No. | 101276 | Ref. No. | 533018000 |
| | | union screw thread 3/8" tube ø 12mm Qty 1 pcs | | |

NOVASIT





| | | | | |
|---|---|--|-----------------|---|
| Part No. | 101187 | Ref. No. | 531042100 | |
| description | gas valve SIT series Novasit 820 0.17VHz gas inlet 1/2" gas outlet 1/2" thermocouple connection M9x1 pilot connection M10x1 ignition pressurebar pressure range 5-50mbar pressure regulator connection blind equiv. no. 0.820.301 supply Operator millivolt | | | |
| spare parts for | 101187 | | | |
|  | Part No. | 101065 | Ref. No. | — |
| | | magnet unit with cable L 44mm D1 ø 30mm D2 ø 20mm suitable for NOVASIT | | |
| accessories for | 101187 | | | |
|  | Part No. | 100110 | Ref. No. | — |
| | | pilot burner SIT type 190 series 3 flames nozzle ømm gas connectionmm | | |

Table continues overleaf



| accessories for | | 101187 | |
|-----------------|---|----------|-----------|
| Part No. | 101305 | Ref. No. | — |
| | gas connection straight 1/2" flange 45x45mm ELETTROSIT/V4400/4600/4605 suitable for SIT/HONEYWELL hole distance 36x36mm | | |
| Part No. | 101306 | Ref. No. | — |
| | gas connection angled flange 45x45mm hole distance 36x36mm 1/2" ELETTROSIT/V4400/4600/4605 screw with O-ring suitable for SIT/HONEYWELL | | |
| Part No. | 101307 | Ref. No. | 531043300 |
| | gas connection straight flange 45x45mm hole distance 36x36mm 3/4" ELETTROSIT/V4400/4600/4605 screw with O-ring suitable for SIT/HONEYWELL | | |
| Part No. | 101308 | Ref. No. | — |
| | gas connection angled flange 45x45mm hole distance 36x36mm 3/4" ELETTROSIT/V4400/4600/4605 screw with O-ring suitable for SIT/HONEYWELL | | |
| Part No. | 102116 | Ref. No. | 537033000 |
| | thermopile ROBERTSHAW L 900mm probe ø 9mm probe L 57mm 250-750mV screw connection 7/16" | | |



1

| Part No. | 101956 | Ref. No. | 531042000 |
|------------------------|---|----------|--------------------|
| description | gas valve SIT series Novasit 820 230V 50Hz gas inlet 1/2" gas outlet 1/2" thermocouple connection M9x1 pilot connection M10x1 ignition pressurebar pressure range 5-50mbar pressure regulator connection blind equiv. no. 0.820.031 | | |
| For models: | F18-94G, F2-18-98G, F2-25-98G, F25-94G, F45-78G | | |
| spare parts for | 101956 | | |
| | Part No. | 101065 | Ref. No. — |
| | magnet unit with cable L 44mm D1 ø 30mm D2 ø 20mm suitable for NOVASIT | | |
| | Part No. | 101313 | Ref. No. 537027200 |
| | solenoid coil 230V 50Hz | | |
| accessories for | 101956 | | |
| | Part No. | 100006 | Ref. No. — |
| | piezoelectric igniter suitable for ELETTROSIT body plastic blowing connection ø2.4mm ø 14mm | | |
| | Part No. | 101305 | Ref. No. — |
| | gas connection straight 1/2" flange 45x45mm ELETTROSIT/V4400/4600/4605 suitable for SIT/HONEYWELL hole distance 36x36mm | | |
| | Part No. | 101306 | Ref. No. — |
| | gas connection angled flange 45x45mm hole distance 36x36mm 1/2" ELETTROSIT/V4400/4600/4605 screw with O-ring suitable for SIT/HONEYWELL | | |
| | Part No. | 101307 | Ref. No. 531043300 |
| | gas connection straight flange 45x45mm hole distance 36x36mm 3/4" ELETTROSIT/V4400/4600/4605 screw with O-ring suitable for SIT/HONEYWELL | | |
| | Part No. | 101308 | Ref. No. — |
| | gas connection angled flange 45x45mm hole distance 36x36mm 3/4" ELETTROSIT/V4400/4600/4605 screw with O-ring suitable for SIT/HONEYWELL | | |

| accessories for | | 101956 | |
|-----------------|--|----------|-----------|
| Part No. | 101312 | Ref. No. | — |
| | microswitch | | |
| Part No. | 101314 | Ref. No. | — |
| | solenoid coil 24V 50Hz | | |
| Part No. | 101317 | Ref. No. | — |
| | plug with cable L 1000mm suitable for NOVASIT | | |
| Part No. | 101318 | Ref. No. | 536022600 |
| | cover cap for solenoid coil suitable for NOVASIT | | |

ignition parts

pilot burners

SIT

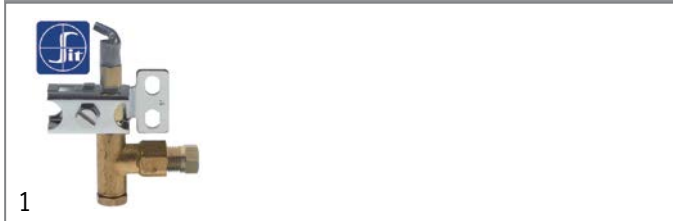

100 series





















| Part No. | 106901 | Ref. No. | 533091400 533091500 |
|------------------------|--|----------|------------------------|
| description | pilot burner SIT type 100 series 1 flame nozzle ø 0.2mm gas connection 6mm | | |
| For models: | CF2-58G, CF2-58GE, CF2-68G, CF2-68GEM, CF3-512GEV, CF3-512GV, CF3-612GEMV, CF3-612GV, CF4-78GP, CF4-78GP-AUS, CF4-78GPE, CF4-78GP-USA, CF4-98G, CF4-98GE, CF6-712GP, CF6-712GPE, CF6-712GPEV, CF6-712GPV, CF6-712GPV-USA, CF6-912G, CF6-912GE, CF6-912GEV, CF6-912GV, CF-712GPE, CF8-916G, CF8-916GE, CF8-916GEV, CF8-916GV, CFM2-68GEM, CFM3-612GEMV, CFV4-78GPE, CFV4-98GE, CFV6-712GPEV, CFV6-912GEV, PC1T-64G, PC2T-68G, PC3-612G, PC3T-612G, PC-712GP, PC-712GP-USA, PC-716GP, PC-716GP-USA, PC-74GP, PC-74GP-USA, PC-78GP, PC-78GP-USA, PC-912G, PC-916G, PC-94G, PC-98G...(Other models you can see in the webshop) | | |
| spare parts for | 106901 | | |
| | Part No. | 100854 | Ref. No. — |
| | pilot burner bracket double | | |
| | Part No. | 100916 | Ref. No. — |
| | compression spring for pilot burner Qty 1 pcs | | |
| | Part No. | 100917 | Ref. No. — |
| | gasket for pilot burner Qty 1 pcs aluminium | | |
| | Part No. | 100918 | Ref. No. — |
| | screw for pilot burner | | |
| accessories for | 106901 | | |
| | Part No. | 100904 | Ref. No. — |
| | locking screw M10x1 for pipe ø 4mm Qty 1 pcs | | |
| | Part No. | 100905 | Ref. No. — |
| | locking screw M10x1 for pipe ø 6mm Qty 1 pcs | | |

Table continues overleaf





| | | | | |
|---|---|--------|----------|---|
| accessories for 106901 | | | | |
|  | Part No. | 102110 | Ref. No. | — |
| | pilot tube copper pipe ø 4mm thickness 1mm L 3000mm | | | |
|  | Part No. | 102111 | Ref. No. | — |
| | pilot tube copper pipe ø 6mm thickness 1mm L 3000mm | | | |
|  | Part No. | 102742 | Ref. No. | — |
| | pilot burner nozzle LPG code 25 bore ø 0.25mm Qty 1 pcs | | | |

| | | | | |
|--|---|-----------------|-----------------------|-----------|
|  <p>1</p> | | | | |
| Part No. | 106906 | Ref. No. | 30100005 530100005 | |
| description | pilot burner SIT type 100 series 3 flames nozzle ø 0.2mm gas connection 6mm | | | |
| spare parts for 106906 | | | | |
|  | Part No. | 100245 | Ref. No. | 533091000 |
| | pilot burner nozzle LPG code 20 bore ø 0.2mm Qty 1 pcs thread M8x0.75 | | | |
|  | Part No. | 100855 | Ref. No. | — |
| | pilot burner bracket triple | | | |
|  | Part No. | 100885 | Ref. No. | — |
| | air mixing sleeve for pilot burner Qty 1 pcs | | | |
|  | Part No. | 100916 | Ref. No. | — |
| | compression spring for pilot burner Qty 1 pcs | | | |
|  | Part No. | 100917 | Ref. No. | — |
| | gasket for pilot burner Qty 1 pcs aluminium | | | |
|  | Part No. | 100918 | Ref. No. | — |
| | screw for pilot burner | | | |
|  | Part No. | 107162 | Ref. No. | — |
| | pilot burner cap SIT 3 flames Hmm Lmm Qty 1 pcs | | | |
|  | Part No. | 107701 | Ref. No. | — |
| | pilot burner bottom part SIT 100 series nozzle ø 0.2mm | | | |
| accessories for 106906 | | | | |
|  | Part No. | 100245 | Ref. No. | 533091000 |
| | pilot burner nozzle LPG code 20 bore ø 0.2mm Qty 1 pcs thread M8x0.75 | | | |
|  | Part No. | 100246 | Ref. No. | 533091200 |
| | pilot burner nozzle natural gas bore ø 0.35mm Qty 1 pcs thread M8x0.75 | | | |
|  | Part No. | 100904 | Ref. No. | — |
| | locking screw M10x1 for pipe ø 4mm Qty 1 pcs | | | |
|  | Part No. | 100905 | Ref. No. | — |
| | locking screw M10x1 for pipe ø 6mm Qty 1 pcs | | | |
|  | Part No. | 102110 | Ref. No. | — |
| | pilot tube copper pipe ø 4mm thickness 1mm L 3000mm | | | |

| | | | | |
|---|--|--------|----------|---|
| accessories for 106906 | | | | |
|  | Part No. | 102111 | Ref. No. | — |
| | pilot tube copper pipe ø 6mm thickness 1mm L 3000mm | | | |
|  | Part No. | 107171 | Ref. No. | — |
| | pilot burner nozzle SIT natural/liquid gas bore ø 0.25mm Qty 1 pcs | | | |
|  | Part No. | 107700 | Ref. No. | — |
| | pilot burner bottom part SIT 100 series nozzle ø 0.25mm | | | |
|  | Part No. | 107702 | Ref. No. | — |
| | pilot burner bottom part SIT 100 series nozzle ø 0.35mm | | | |

| | | | | |
|---|---|-----------------|-----------|--|
| accessories | | | | |
| pilot burner nozzles | | | | |
|  <p>1</p> | | | | |
| Part No. | 100245 | Ref. No. | 533091000 | |
| description | pilot burner nozzle LPG code 20 bore ø 0.2mm Qty 1 pcs thread M8x0.75 | | | |
| For models: | CF2-58G, CF2-58GE, CF2-68G, CF2-68GEM, CF3-512GEV, CF3-512GV, CF3-612GEMV, CF3-612GV, CF4-78GP, CF4-78GP-AUS, CF4-78GPE, CF4-78GP-USA, CF4-98G, CF4-98GE, CF6-712GP, CF6-712GPE, CF6-712GPEV, CF6-712GPV, CF6-712GPV-USA, CF6-912G, CF6-912GE, CF6-912GEV, CF6-912GV, CF-712GPE, CF8-916G, CF8-916GE, CF8-916GEV, CF8-916GV, CFA4-78G, CFA4-98G, CFA6-712GV, CFA6-912GV, CFM2-68GEM, CFM3-612GEMV, CFV4-78GPE, CFV4-98GE, CFV6-712GPEV, CFV6-912GEV, PA-78G, PA-98G, PAF-78G, PAF-98G, PAT-78G, PAT-98G, PC1T-64G, PC2T-68G, PC3-612G, PC3T-612G, PC-712GP, PC-712GPUSA...(Other models you can see in the webshop) | | | |















| | | | | |
|---|---|-----------------|-----------|--|
|  <p>1</p> | | | | |
| Part No. | 100246 | Ref. No. | 533091200 | |
| description | pilot burner nozzle natural gas bore ø 0.35mm Qty 1 pcs thread M8x0.75 | | | |
| For models: | CF2-58G, CF2-58GE, CF2-68G, CF2-68GEM, CF3-512GEV, CF3-512GV, CF3-612GEMV, CF3-612GV, CF4-78GP, CF4-78GP-AUS, CF4-78GPE, CF4-78GP-USA, CF4-98G, CF4-98GE, CF6-712GP, CF6-712GPE, CF6-712GPEV, CF6-712GPV, CF6-712GPV-USA, CF6-912G, CF6-912GE, CF6-912GEV, CF6-912GV, CF-712GPE, CF8-916G, CF8-916GE, CF8-916GEV, CF8-916GV, CFA4-78G, CFA4-98G, CFA6-712GV, CFA6-912GV, CFM2-68GEM, CFM3-612GEMV, CFV4-78GPE, CFV4-98GE, CFV6-712GPEV, CFV6-912GEV, PA-78G, PA-98G, PAF-78G, PAF-98G, PAT-78G, PAT-98G, PC1T-64G, PC2T-68G, PC3-612G, PC3T-612G, PC-712GP, PC-712GPUSA...(Other models you can see in the webshop) | | | |

| | | | | |
|--|--|-----------------|----------|--|
| ignition electrodes | | | | |
|  <p>1</p> | | | | |
| Part No. | 100706 | Ref. No. | 30100054 | |
| description | ignition electrode connection M4 Qty 1 pcs | | | |



140 - 145 -150 series



| | | | |
|---|--|-----------------|---------------------------|
| Part No. | 107133 | Ref. No. | 533023200 |
| description | pilot burner SIT type 140 series 1 flame nozzle \varnothing mm gas connectionmm | | |
| For models: | CF4-78G, CF4-78GP, CF4-78GP-AUS, CF4-78GP-USA, CF4-98G, CF6-712G, CF6-712GP, CF6-712GPV, CF6-712GPV-USA, CF6-912G, CF6-912GP, CF6-912GV, CF8-916G, CF8-916GV, CFA4-78G, CFA4-98G, CFA6-712GV, CFA6-912GV, CFPB6-79G, PAF-78G, PAF-98G, TP2-712G, TP2-712GP, TP2-78GP, TP2-912G, TP2-98G, TP2T-712GP, TP2T-78GP, TP2T-912G, TP2T-98G, TP4-712GP, TP4-912G, TP4T-610G, TP4T-712GP, TP4T-912G, TP-74G, TP-78G, TP-94G, TP-98G, TPF2-712G, TPF2-712GP, TPF2-712GPE, TPF2-712GPEV, TPF2-712GPV, TPF2-712GV, TPF2-78GP, TPF2-78GPE, TPF2-912G, TPF2-912GE, TPF2-912GEV...(Other models you can see in the webshop) | | |
| accessories for | 107133 | | |
|  | Part No. | 100204 | Ref. No. — |
| | pilot burner nozzle SIT LPG code 14 bore \varnothing 0.18/0.20mm Qty 1 pcs suitable for 140 series | | |
|  | Part No. | 100205 | Ref. No. 533020500 |
| | pilot burner nozzle SIT LPG code 19 bore \varnothing 0.23/0.26mm Qty 1 pcs suitable for SIT 150 series | | |
|  | Part No. | 100206 | Ref. No. — |
| | pilot burner nozzle SIT natural gas code 36 bore \varnothing 0.60/0.55mm Qty 1 pcs suitable for SIT 150 series | | |
|  | Part No. | 100207 | Ref. No. 533020600 |
| | pilot burner nozzle SIT natural gas code 27 bore \varnothing 0.40/0.38mm suitable for SIT 140 series | | |
|  | Part No. | 100216 | Ref. No. — |
| | pilot burner nozzle SIT natural gas code 38 bore \varnothing 0.45mm Qty 1 pcs suitable for SIT 150 series | | |
|  | Part No. | 100701 | Ref. No. 537003000 |
| | ignition electrode connection M4 Qty 1 pcs | | |
|  | Part No. | 100897 | Ref. No. — |
| | olive for pipe \varnothing 4mm Qty 1 pcs for pilot burner | | |
|  | Part No. | 100898 | Ref. No. 533023300 |
| | olive for pipe \varnothing 6mm Qty 1 pcs for pilot burner | | |
|  | Part No. | 100906 | Ref. No. 533018600 |
| | screw connection thread M10x1 for ignition electrode brass Qty 1 pcs WS 10 | | |
|  | Part No. | 100907 | Ref. No. — |
| | screw connection thread M10x1 Qty 1 pcs type SEF 1 \varnothing mm for thermocouple | | |
|  | Part No. | 100908 | Ref. No. — |
| | union screw thread M10x1 for pipe \varnothing 4mm Qty 1 pcs | | |
|  | Part No. | 100909 | Ref. No. 533018500 |
| | union screw thread M10x1 for pipe \varnothing 6mm Qty 1 pcs | | |
|  | Part No. | 102110 | Ref. No. — |
| | pilot tube copper pipe \varnothing 4mm thickness 1mm L 3000mm | | |
|  | Part No. | 102111 | Ref. No. — |
| | pilot tube copper pipe \varnothing 6mm thickness 1mm L 3000mm | | |



| | | | |
|---|---|-----------------|---------------------------|
| Part No. | 107114 ¹ | Ref. No. | 533023400 |
| description | pilot burner SIT type 140 series 2 flames nozzle \varnothing mm gas connectionmm | | |
| For models: | BRT-66G, CPT-64G, CPT-66G, CPT-74G, CPT-76G, FTL-54G, FTL-56G, FTL-712G, FTL-712GS, FTL-712G-USA, FTL-74G, FTL-74GS, FTL-74GUSA, FTL-76G, FTL-76GS, FTL-76G-USA, FTL-78G, FTL-78G-AUS, FTL-78GS, FTL-78G-USA, FTL-916G, FTL-94G, FTL-94GS, FTL-98G, FTL-98GS, FTLR-56G, FTLR-712G, FTLR-712GS, FTLR-712G-USA, FTLR-76G, FTLR-76GS, FTLR-76G-USA, FTLR-78G, FTLR-78G-AUS, FTLR-78GS, FTLR-78G-USA, FTLR-98G, FTLR-98GS, FTR-54G, FTR-56G, FTR-712G, FTR-712GS, FTR-712G-USA, FTR-74G, FTR-74GS, FTR-74G-USA, FTR-76G, FTR-76GS, FTR-76G-USA, FTR-78G...(Other models you can see in the webshop) | | |
| spare parts for | 107114 | | |
|  | Part No. | 100907 | Ref. No. — |
| | screw connection thread M10x1 Qty 1 pcs type SEF 1 \varnothing mm for thermocouple | | |
| accessories for | 107114 | | |
|  | Part No. | 100204 | Ref. No. — |
| | pilot burner nozzle SIT LPG code 14 bore \varnothing 0.18/0.20mm Qty 1 pcs suitable for 140 series | | |
|  | Part No. | 100205 | Ref. No. 533020500 |
| | pilot burner nozzle SIT LPG code 19 bore \varnothing 0.23/0.26mm Qty 1 pcs suitable for SIT 150 series | | |
|  | Part No. | 100206 | Ref. No. — |
| | pilot burner nozzle SIT natural gas code 36 bore \varnothing 0.60/0.55mm Qty 1 pcs suitable for SIT 150 series | | |
|  | Part No. | 100207 | Ref. No. 533020600 |
| | pilot burner nozzle SIT natural gas code 27 bore \varnothing 0.40/0.38mm suitable for SIT 140 series | | |
|  | Part No. | 100216 | Ref. No. — |
| | pilot burner nozzle SIT natural gas code 38 bore \varnothing 0.45mm Qty 1 pcs suitable for SIT 150 series | | |
|  | Part No. | 100701 | Ref. No. 537003000 |
| | ignition electrode connection M4 Qty 1 pcs | | |
|  | Part No. | 100801 | Ref. No. — |
| | gasket for pilot burner Qty 1 pcs | | |
|  | Part No. | 100897 | Ref. No. — |
| | olive for pipe \varnothing 4mm Qty 1 pcs for pilot burner | | |
|  | Part No. | 100898 | Ref. No. 533023300 |
| | olive for pipe \varnothing 6mm Qty 1 pcs for pilot burner | | |
|  | Part No. | 100906 | Ref. No. 533018600 |
| | screw connection thread M10x1 for ignition electrode brass Qty 1 pcs WS 10 | | |
|  | Part No. | 100907 | Ref. No. — |
| | screw connection thread M10x1 Qty 1 pcs type SEF 1 \varnothing mm for thermocouple | | |
|  | Part No. | 100908 | Ref. No. — |
| | union screw thread M10x1 for pipe \varnothing 4mm Qty 1 pcs | | |
|  | Part No. | 100909 | Ref. No. 533018500 |
| | union screw thread M10x1 for pipe \varnothing 6mm Qty 1 pcs | | |
|  | Part No. | 102110 | Ref. No. — |
| | pilot tube copper pipe \varnothing 4mm thickness 1mm L 3000mm | | |















¹incl. thermocouple fitting
Table continues overleaf



| | | | |
|---|--------|----------|---|
| accessories for | 107114 | | |
| Part No. | 102111 | Ref. No. | — |
|  pilot tube copper pipe ø 6mm thickness 1mm L 3000mm | | | |

















| | | | |
|---|--|----------|-----------|
| Part No. | 107132 | Ref. No. | 533023200 |
| description | pilot burner SIT type 140 series 2 flames nozzle ømm gas connectionmm | | |
| accessories for | 107132 | | |
| Part No. | 100204 | Ref. No. | — |
|  | pilot burner nozzle SIT LPG code 14 bore ø 0.18/0.20mm Qty 1 pcs suitable for 140 series | | |
| Part No. | 100205 | Ref. No. | 533020500 |
|  | pilot burner nozzle SIT LPG code 19 bore ø 0.23/0.26mm Qty 1 pcs suitable for SIT 150 series | | |
| Part No. | 100206 | Ref. No. | — |
|  | pilot burner nozzle SIT natural gas code 36 bore ø 0.60/0.55mm Qty 1 pcs suitable for SIT 150 series | | |
| Part No. | 100207 | Ref. No. | 533020600 |
|  | pilot burner nozzle SIT natural gas code 27 bore ø 0.40/0.38mm suitable for SIT 140 series | | |
| Part No. | 100216 | Ref. No. | — |
|  | pilot burner nozzle SIT natural gas code 38 bore ø 0.45mm Qty 1 pcs suitable for SIT 150 series | | |
| Part No. | 100701 | Ref. No. | 537003000 |
|  | ignition electrode connection M4 Qty 1 pcs | | |
| Part No. | 100897 | Ref. No. | — |
|  | olive for pipe ø 4mm Qty 1 pcs for pilot burner | | |
| Part No. | 100898 | Ref. No. | 533023300 |
|  | olive for pipe ø 6mm Qty 1 pcs for pilot burner | | |
| Part No. | 100906 | Ref. No. | 533018600 |
|  | screw connection thread M10x1 for ignition electrode brass Qty 1 pcs WS 10 | | |
| Part No. | 100907 | Ref. No. | — |
|  | screw connection thread M10x1 Qty 1 pcs type SEF 1 ømm for thermocouple | | |
| Part No. | 100908 | Ref. No. | — |
|  | union screw thread M10x1 for pipe ø 4mm Qty 1 pcs | | |
| Part No. | 100909 | Ref. No. | 533018500 |
|  | union screw thread M10x1 for pipe ø 6mm Qty 1 pcs | | |
| Part No. | 102110 | Ref. No. | — |
|  | pilot tube copper pipe ø 4mm thickness 1mm L 3000mm | | |
| Part No. | 102111 | Ref. No. | — |
|  | pilot tube copper pipe ø 6mm thickness 1mm L 3000mm | | |

| 160 series | | | |
|---|---|----------|-----------|
|  | | | |
| 1 | | | |
| Part No. | 100053 | Ref. No. | 533011500 |
| description | pilot burner SIT type 160 series 2 flames nozzle ømm gas connectionmm | | |
| spare parts for | 100053 | | |
| Part No. | 100907 | Ref. No. | — |
|  | screw connection thread M10x1 Qty 1 pcs type SEF 1 ømm for thermocouple | | |
| accessories for | 100053 | | |
| Part No. | 100202 | Ref. No. | — |
|  | pilot burner nozzle natural gas code 41 Qty 1 pcs nozzle ø 0.41mm | | |
| Part No. | 100203 | Ref. No. | — |
|  | pilot burner nozzle LPG code 25 Qty 1 pcs nozzle ø 0.25mm | | |
| Part No. | 100701 | Ref. No. | 537003000 |
|  | ignition electrode connection M4 Qty 1 pcs | | |
| Part No. | 100801 | Ref. No. | — |
|  | gasket for pilot burner Qty 1 pcs | | |
| Part No. | 100869 | Ref. No. | — |
|  | pilot burner nozzle natural gas code 51 Qty 1 pcs suitable for 160 series nozzle ø 0.51mm | | |
| Part No. | 100906 | Ref. No. | 533018600 |
|  | screw connection thread M10x1 for ignition electrode brass Qty 1 pcs WS 10 | | |
| Part No. | 100908 | Ref. No. | — |
|  | union screw thread M10x1 for pipe ø 4mm Qty 1 pcs | | |
| Part No. | 100909 | Ref. No. | 533018500 |
|  | union screw thread M10x1 for pipe ø 6mm Qty 1 pcs | | |
| Part No. | 101282 | Ref. No. | — |
|  | olive for pipe ø 4mm L 7.4mm Qty 1 pcs | | |
| Part No. | 101287 | Ref. No. | — |
|  | olive for pipe ø 6mm Qty 1 pcs | | |
| Part No. | 102110 | Ref. No. | — |
|  | pilot tube copper pipe ø 4mm thickness 1mm L 3000mm | | |
| Part No. | 102111 | Ref. No. | — |
|  | pilot tube copper pipe ø 6mm thickness 1mm L 3000mm | | |
| Part No. | 107650 | Ref. No. | 533020200 |
|  | pilot burner nozzle SIT LPG code 30 Qty 1 pcs | | |



| | | | |
|---|---|-----------------|---------------------------|
|  | | | |
| 1 | | | |
| Part No. | 100054 | Ref. No. | 533011500 |
| description | pilot burner SIT type 160 series 2 flames nozzle \varnothing mm gas connectionmm | | |
| For models: | BM-74G, BM-78G, BM-94G, BM-98G, BMT-64G, BMT-66G, BMT-74G, BMT-78G, BMT-94G, BMT-98G, BRF-64G, BRF-74G, BRF-78G, BRF-94G, BRF-98G, CP-66G, CP-74G, CP-74G-USA, CP-76G, CP-78, CP-78G, CP-78G-USA, CP-94G, CP-94G-USA, CP-98G, CP-98G-USA, CPA-66G, CPA-74G, CPA-76G, CPA-78G, CPA-94G, CPA-98G, CPB-98G, CPBA-98G, CPM-62G, CPM-6G, CPP-94G, CPP-94G-USA, CPT-64G, CPT-66G, CW-4G, CW-61G, CW-62G, CW-6G, FTL-61G, FTL-61GF, FTL-61GS, FTL-61GSF, FTL-62G, FTL-62GF...(Other models you can see in the webshop) | | |
| spare parts for | 100054 | | |
|  | Part No. | 100907 | Ref. No. — |
| | screw connection thread M10x1 Qty 1 pcs type SEF 1 \varnothing mm for thermocouple | | |
| accessories for | 100054 | | |
|  | Part No. | 100202 | Ref. No. — |
| | pilot burner nozzle natural gas code 41 Qty 1 pcs nozzle \varnothing 0.41mm | | |
|  | Part No. | 100203 | Ref. No. — |
| | pilot burner nozzle LPG code 25 Qty 1 pcs nozzle \varnothing 0.25mm | | |
|  | Part No. | 100701 | Ref. No. 537003000 |
| | ignition electrode connection M4 Qty 1 pcs | | |
|  | Part No. | 100801 | Ref. No. — |
| | gasket for pilot burner Qty 1 pcs | | |
|  | Part No. | 100869 | Ref. No. — |
| | pilot burner nozzle natural gas code 51 Qty 1 pcs suitable for 160 series nozzle \varnothing 0.51mm | | |
|  | Part No. | 100906 | Ref. No. 533018600 |
| | screw connection thread M10x1 for ignition electrode brass Qty 1 pcs WS 10 | | |
|  | Part No. | 100908 | Ref. No. — |
| | union screw thread M10x1 for pipe \varnothing 4mm Qty 1 pcs | | |
|  | Part No. | 100909 | Ref. No. 533018500 |
| | union screw thread M10x1 for pipe \varnothing 6mm Qty 1 pcs | | |
|  | Part No. | 101282 | Ref. No. — |
| | olive for pipe \varnothing 4mm L 7.4mm Qty 1 pcs | | |
|  | Part No. | 101287 | Ref. No. — |
| | olive for pipe \varnothing 6mm Qty 1 pcs | | |
|  | Part No. | 102110 | Ref. No. — |
| | pilot tube copper pipe \varnothing 4mm thickness 1mm L 3000mm | | |
|  | Part No. | 102111 | Ref. No. — |
| | pilot tube copper pipe \varnothing 6mm thickness 1mm L 3000mm | | |
|  | Part No. | 107650 | Ref. No. 533020200 |
| | pilot burner nozzle SIT LPG code 30 Qty 1 pcs | | |





| | | | |
|---|---|-----------------|---------------------------|
|  | | | |
| 1 | | | |
| Part No. | 100056 | Ref. No. | 533011000 |
| description | pilot burner SIT type 160 series 3 flames nozzle \varnothing mm gas connectionmm | | |
| For models: | BM-4G, BM-61GF, BM-62GF, BM-6G, BM-8G, BR-62G, BR-6G, CP-62G, CP-6G, CP-74G, CP-74G-USA, CP-78G, CP-78G-USA, CP-94G, CP-94GUSA, CP-98G, CP-98G-USA, CPA-94G, CW-74G, CW-74G-USA, CW-78G, CW-78G-USA, CW-94G, CW-98G, CWT-64G, CWT-66G, CWT-68G, CWT-74G, CWT-74G-USA, CWT-78G, CWT-78G-USA, CWT-94G, CWT-98G, F11-54G, F13-64G, F13-74G, F13T-74G, F13T-94G, F18-74G, F2-13-78G, F2-13T-78G, F2-13T-98G, F2-18-78G, F2-8-74G, F2-8-94G, F2-8T-66G, F2-8T-74G, F2-8T-94G, F45-78G, F8T-63G...(Other models you can see in the webshop) | | |
| spare parts for | 100056 | | |
|  | Part No. | 100907 | Ref. No. — |
| | screw connection thread M10x1 Qty 1 pcs type SEF 1 \varnothing mm for thermocouple | | |
| accessories for | 100056 | | |
|  | Part No. | 100202 | Ref. No. — |
| | pilot burner nozzle natural gas code 41 Qty 1 pcs nozzle \varnothing 0.41mm | | |
|  | Part No. | 100203 | Ref. No. — |
| | pilot burner nozzle LPG code 25 Qty 1 pcs nozzle \varnothing 0.25mm | | |
|  | Part No. | 100701 | Ref. No. 537003000 |
| | ignition electrode connection M4 Qty 1 pcs | | |
|  | Part No. | 100801 | Ref. No. — |
| | gasket for pilot burner Qty 1 pcs | | |
|  | Part No. | 100869 | Ref. No. — |
| | pilot burner nozzle natural gas code 51 Qty 1 pcs suitable for 160 series nozzle \varnothing 0.51mm | | |
|  | Part No. | 100870 | Ref. No. — |
| | olive for pipe \varnothing 4mm Qty 1 pcs suitable for 160 series for pilot burner | | |
|  | Part No. | 100906 | Ref. No. 533018600 |
| | screw connection thread M10x1 for ignition electrode brass Qty 1 pcs WS 10 | | |
|  | Part No. | 100908 | Ref. No. — |
| | union screw thread M10x1 for pipe \varnothing 4mm Qty 1 pcs | | |
|  | Part No. | 100909 | Ref. No. 533018500 |
| | union screw thread M10x1 for pipe \varnothing 6mm Qty 1 pcs | | |
|  | Part No. | 101287 | Ref. No. — |
| | olive for pipe \varnothing 6mm Qty 1 pcs | | |
|  | Part No. | 102110 | Ref. No. — |
| | pilot tube copper pipe \varnothing 4mm thickness 1mm L 3000mm | | |
|  | Part No. | 102111 | Ref. No. — |
| | pilot tube copper pipe \varnothing 6mm thickness 1mm L 3000mm | | |
|  | Part No. | 107650 | Ref. No. 533020200 |
| | pilot burner nozzle SIT LPG code 30 Qty 1 pcs | | |



POLIDORO

pilot burners













| | | | |
|---|--|-----------------|---------------------------|
| Part No. | 102800 | Ref. No. | 08122 |
| description | pilot burner POLIDORO 3 flames code gas connection 6mm | | |
| spare parts for | 102800 | | |
|  | Part No. | 100906 | Ref. No. 533018600 |
| | screw connection thread M10x1 for ignition electrode brass Qty 1 pcs WS 10 | | |
|  | Part No. | 100907 | Ref. No. — |
| | screw connection thread M10x1 Qty 1 pcs type SEF 1 0mm for thermocouple | | |
|  | Part No. | 100909 | Ref. No. 533018500 |
| | union screw thread M10x1 for pipe 0 6mm Qty 1 pcs | | |
|  | Part No. | 101287 | Ref. No. — |
| | olive for pipe 0 6mm Qty 1 pcs | | |
| accessories for | 102800 | | |
|  | Part No. | 100208 | Ref. No. — |
| | pilot burner nozzle POLIDORO LPG code 20 bore 0 2mm Qty 1 pcs | | |
|  | Part No. | 100209 | Ref. No. — |
| | pilot burner nozzle POLIDORO natural gas code 40 bore 0 4mm Qty 1 pcs | | |
|  | Part No. | 100701 | Ref. No. 537003000 |
| | ignition electrode connection M4 Qty 1 pcs | | |
|  | Part No. | 100908 | Ref. No. — |
| | union screw thread M10x1 for pipe 0 4mm Qty 1 pcs | | |
|  | Part No. | 101280 | Ref. No. — |
| | olive for pipe 0 4mm Qty 1 pcs | | |

producer-specific pilot burners

LOTUS



| | | | |
|---|---|-----------------|-------------------|
| Part No. | 102805 | Ref. No. | 533091900 |
| description | pilot burner SIT type 160 series 3 flames nozzle 0mm gas connectionmm | | |
| For models: | F18-94G, F2-18-98G, F2-25-98G, F25-94G | | |
| spare parts for | 102805 | | |
|  | Part No. | 100907 | Ref. No. — |
| | screw connection thread M10x1 Qty 1 pcs type SEF 1 0mm for thermocouple | | |

| | | | |
|---|---|--------|---------------------------|
| accessories for | 102805 | | |
|  | Part No. | 100202 | Ref. No. — |
| | pilot burner nozzle natural gas code 41 Qty 1 pcs nozzle 0 0.41mm | | |
|  | Part No. | 100203 | Ref. No. — |
| | pilot burner nozzle LPG code 25 Qty 1 pcs nozzle 0 0.25mm | | |
|  | Part No. | 100701 | Ref. No. 537003000 |
| | ignition electrode connection M4 Qty 1 pcs | | |
|  | Part No. | 100801 | Ref. No. — |
| | gasket for pilot burner Qty 1 pcs | | |
|  | Part No. | 100869 | Ref. No. — |
| | pilot burner nozzle natural gas code 51 Qty 1 pcs suitable for 160 series nozzle 0 0.51mm | | |
|  | Part No. | 100906 | Ref. No. 533018600 |
| | screw connection thread M10x1 for ignition electrode brass Qty 1 pcs WS 10 | | |
|  | Part No. | 100908 | Ref. No. — |
| | union screw thread M10x1 for pipe 0 4mm Qty 1 pcs | | |
|  | Part No. | 100909 | Ref. No. 533018500 |
| | union screw thread M10x1 for pipe 0 6mm Qty 1 pcs | | |
|  | Part No. | 101282 | Ref. No. — |
| | olive for pipe 0 4mm L 7.4mm Qty 1 pcs | | |
|  | Part No. | 101287 | Ref. No. — |
| | olive for pipe 0 6mm Qty 1 pcs | | |
|  | Part No. | 107650 | Ref. No. 533020200 |
| | pilot burner nozzle SIT LPG code 30 Qty 1 pcs | | |

electrodes

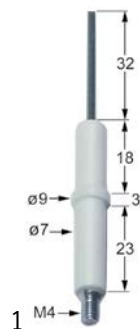

| | | | |
|---|--|-----------------|---------------------------|
| Part No. | 100701 | Ref. No. | 537003000 |
| description | ignition electrode connection M4 Qty 1 pcs | | |
| accessories for | 100701 | | |
|  | Part No. | 100906 | Ref. No. 533018600 |
| | screw connection thread M10x1 for ignition electrode brass Qty 1 pcs WS 10 | | |



| | | | |
|--------------------|--|-----------------|----------|
| Part No. | 100706 | Ref. No. | 30100054 |
| description | ignition electrode connection M4 Qty 1 pcs | | |

| | | | |
|--------------------|--|-----------------|--|
| Part No. | 100728 | Ref. No. | 837002000+537011700 837002000+547010500 |
| description | ignition electrode D1 ø 10mm cable length 1420mm to clip | | |

| | | | |
|--------------------|--|-----------------|-----------|
| Part No. | 100799 | Ref. No. | 537002000 |
| description | ignition electrode D1 ø 10mm D2 ø 7mm connection F 2.8x0.8mm L1 21mm BL1 12mm BL2 18mm to clip | | |
| For models: | CF-10G6-A, CF-10G-6F, CF-10G-A, CF-10GF, CF4-8G, CF4-8GEM, CF-8G-A, CF-8GF | | |

| | | | |
|--------------------|--|-----------------|-----------|
| Part No. | 102328 | Ref. No. | 537024400 |
| description | ignition electrode D1 ø 6mm cable length 1380mm connection F 2.8x0.8mm D2 ø 10mm L1 17mm BL1 20mm BL2 23mm to clip | | |
| For models: | CF-10G6-A, CF-10G-6F, CF-10G-A, CF-10GF, CF2-58G, CF2-58GE, CF2-68G, CF3-512GEV, CF3-512GV, CF3-612GV, CF4-68G, CF4-8G, CF6-610G, CF-8G-A, CF-8GF, TPF4-610G | | |

| | | | |
|--------------------|--|-----------------|-----------|
| Part No. | 102329 | Ref. No. | 537024500 |
| description | ignition electrode D1 ø 6mm cable length 700mm connection F 2.8x0.8mm D2 ø 10mm L1 23mm BL1 20mm BL2 23mm to clip | | |
| For models: | CF-10G6-A, CF-10G-6F, CF-10G-A, CF-10GF, CF2-58G, CF2-58GE, CF2-68G, CF3-512GEV, CF3-512GV, CF3-612GV, CF4-68G, CF4-8G, CF6-610G, CF-8G-A, CF-8GF, TPF4-610G | | |

| | | | |
|--------------------|---|-----------------|-----------|
| Part No. | 100871 | Ref. No. | 537003000 |
| description | ignition electrode D1 ø 7mm connection M4 to clip | | |
| For models: | BM-4G, BM-61GF, BM-62GF, BM-6G, BM-74G, BM-78G, BM-8G, BR-62G, BR-6G, CP-62G, CP-6G, CP-74G, CP-78G, CPM-62G, CPM-6G, CW-4G, CW-61G, CW-62G, CW-6G, CW-74G, CW-78G, F13-74G, F18-74G, F2-13-78G, F2-18-78G, FG-10, FG-2-10, FMG-10, FMG-15, FMG-2-10, FMG-2-15, FMPG-20, FMPG-30, FP-62G, FP-6G, FPG-20, FPG-30, FQ-4G, FQ-61GF, FQ-62GF, FQ-6G, FQM-4G, FTL-4G, FTL-4GS, FTL-61G, FTL-61GF, FTL-61GS, FTL-61GSF, FTL-62G, FTL-62GF...(Other models you can see in the webshop) | | |

| | | | |
|--------------------|---|-----------------|-----------------------|
| Part No. | 102330 | Ref. No. | 30100052 537008300 |
| description | ignition electrode D1 ø 7mm D2 ø 9mm L1 16mm BL1 18mm BL2 3mm BL3 23mm to clip connection ø 2.4mm | | |
| For models: | BM-74G, BM-78G, BM-94G, BM-98G, BMT-64G, BMT-66G, BMT-74G, BMT-78G, BMT-94G, BMT-98G, BRF-64G, BRF-74G, BRF-78G, BRF-94G, BRF-98G, CF4-78G, CF4-78GP, CF4-78GP-AUS, CF4-78GP-USA, CF4-98G, CF6-712G, CF6-712GP, CF6-712GPV, CF6-712GPV-USA, CF6-712GV, CF6-912G, CF6-912GV, CF8-916G, CF8-916GV, CFA4-78G, CFA4-98G, CFA6-712GV, CFA6-912GV, CFPP6-79G, CP-62G, CP-66G, CP-74G, CP-74G-USA, CP-76G, CP-78, CP-78G, CP-78G-USA, CP-94G, CP-94G-USA, CP-98G, CP-98G-USA, CPA-66G, CPA-74G, CPA-76G, CPA-78G...(Other models you can see in the webshop) | | |

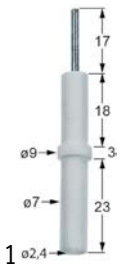

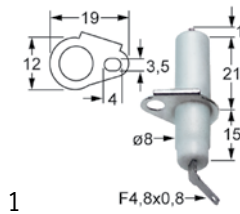

| | | | |
|--------------------|--|-----------------|-----------|
| Part No. | 106619 | Ref. No. | 537010200 |
| description | ignition electrode D1 ø 7mm D2 ø 9mm L1 17mm BL1 18mm BL2 3mm BL3 23mm to clip connection ø 2.4mm | | |
| For models: | BRT-66G, CP-74G, CP-74G-USA, CP-78G, CP-78G-USA, CP-94G-USA, CP-98G-USA, CPP-94G-USA, CPT-64G, CPT-66G, CPT-74G, CPT-76G, CW-74G, CW-74G-USA, CW-78G, CW-78G-USA, CWT-74G-USA, CWT-78G-USA, FTL-54G, FTL-56G, FTL-712G, FTL-712GS, FTL-712G-USA, FTL-74G, FTL-74GS, FTL-74G-USA, FTL-76G, FTL-76GS, FTL-76G-USA, FTL-78G, FTL-78G-AUS, FTL-78GS, FTL-78G-USA, FTL-916G, FTL-94G, FTL-94GS, FTL-98G, FTL-98GS, FTLR-56G, FTLR-712G, FTLR-712GS, FTLR-712G-USA, FTLR-76G, FTLR-76GS, FTLR-76G-USA, FTLR-78G, FTLR-78G-AUS, FTLR-78GS, FTLR-78G-USA, FTLR-98G...(Other models you can see in the webshop) | | |

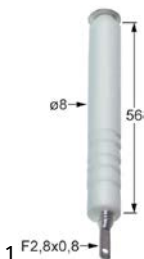

| | | | |
|--------------------|--|-----------------|-----------|
| Part No. | 102327 | Ref. No. | 537021800 |
| description | ignition electrode flange length 19mm flange width 12mm D1 ø 8mm L1 1mm BL1 21mm BL2 15mm connection F 4.8x0.8mm fixing dimensions ø4x3.5mm with flange | | |
| For models: | CF-10G6-A, CF-10G-6F, CF-10G-A, CF-10GEM, CF-10GEM-6, CF-10GEM6-A, CF-10GEM-A, CF-10GF, CF-62GEM, CF-62GEM-A, CF-8G-A, CF-8GEM, CF-8GEM-A, CF-8GF, CFM-10GEM, CFM-10GEM-6, CFM-10GEM6-A, CFM-10GEM-A, CFM-8GEM, CFM-8GEM-A, PC-61GF, PC-62GF | | |



| | | | |
|---|--|-----------------|-------------------|
| Part No. | 100800 | Ref. No. | 537010300 |
| description | ignition electrode D1 ø 8mm BL1 56mm connection F 2.8x0.8mm to clip with spring | | |
| For models: | CF4-68G, CF4-68GEM, CF4-78G, CF4-78GE, CF4-8G, CF4-8GEM, CF4-GEMS, CF6-610G, CF6-610GEM, CF6-712G, CF6-712GEV, CF6-712GV, CF-712GE, CFM4-66GEM, CFM4-68GEM, CFM6-610GEM, FO-1G, FO-2G, FO-3G, PC-12G, PC-4G, PC-712G, PC-716G, PC-74G, PC-78G, PC-8G, PCT-63G, PCT-66G, TP2-712G, TP4T-610G, TPF2-712G, TPF2-712GV, TPF4-610G, TPF4-610GEM | | |
| spare parts for | 100800 | | |
|  | Part No. | 516198 | Ref. No. — |
| | retaining ring E D1 ø 6mm D2 ø 12mm SS DIN 6799 thickness 0.7mm for shaft ø 7-9mm | | |
|  | Part No. | 526087 | Ref. No. — |
| | compression spring ø 10.7mm L 14.5mm wire gauge ø 0.7mm | | |



| | | | |
|--------------------|--|-----------------|-----------|
| Part No. | 100729 | Ref. No. | 537002700 |
| description | ignition electrode L1 5mm D1 ø 8mm D2 ø 10mm BL1 41mm BL2 14mm connection F 2.8x0.8mm to clip with spring | | |
| For models: | CF-10G6-A, CF-10G-6F, CF-10G-A, CF-10GEM, CF-10GEM-6, CF-10GEM6-A, CF-10GEM-A, CF-10GF, CF-62GEM, CF-62GEM-A, CF-8G-A, CF-8GEM, CF-8GEM-A, CF-8GF, CFM-10GEM, CFM-10GEM-6, CFM-10GEM6-A, CFM-10GEM-A, CFM-8GEM, CFM-8GEM-A, PC-61GF, PC-62GF | | |



| | | | |
|--------------------|--|-----------------|-----------|
| Part No. | 100906 | Ref. No. | 533018600 |
| description | screw connection thread M10x1 for ignition electrode brass Qty 1 pcs WS 10 | | |
| For models: | BM-4G, BM-61GF, BM-62GF, BM-6G, BM-74G, BM-78G, BM-8G, BM-94G, BM-98G, BMT-64G, BMT-66G, BMT-74G, BMT-78G, BMT-94G, BMT-98G, BR-62G, BR-6G, BRF-64G, BRF-74G, BRF-78G, BRF-94G, BRF-98G, BRT-66G, CF4-78G, CF4-78GP, CF4-78GP-AUS, CF4-78GPUSA, CF4-98G, CF6-712G, CF6-712GP, CF6-712GPV, CF6-712GPV-USA, CF6-712GV, CF6-912G, CF6-912GV, CF8-916G, CF8-916GV, CFA4-78G, CFA4-98G, CFA6-712GV, CFA6-912GV, CFPB6-79G, CP-62G, CP-66G, CP-6G, CP-74G, CP-74G-USA, CP-76G, CP-78, CP-78G...(Other models you can see in the webshop) | | |

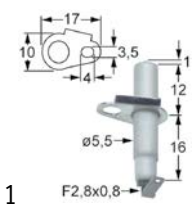

| | | | |
|--------------------|--|-----------------|-----------|
| Part No. | 102326 | Ref. No. | 537021700 |
| description | ignition electrode flange length 17mm flange width 10mm D1 ø 5.5mm L1 1mm BL1 12mm BL2 16mm connection F2.8x0.8 fixing dimensions ø4x3.5mm with flange | | |
| For models: | CF-10G6-A, CF-10G-6F, CF-10G-A, CF-10GEM, CF-10GEM-6, CF-10GEM6-A, CF-10GEM-A, CF-10GF, CF-62GEM, CF-62GEM-A, CF-8G-A, CF-8GEM, CF-8GEM-A, CF-8GF, CFM-10GEM, CFM-10GEM-6, CFM-10GEM6-A, CFM-10GEM-A, CFM-8GEM, CFM-8GEM-A, PC-61GF, PC-62GF | | |



| | | | |
|--------------------|--|-----------------|-----------|
| Part No. | 102264 | Ref. No. | 533084100 |
| description | spring clip for igniter/thermocouple | | |
| For models: | CF-10G6-A, CF-10G-6F, CF-10G-A, CF-10GF, CF2-58G, CF2-58GE, CF2-68G, CF3-512GEV, CF3-512GV, CF3-612GV, CF4-68G, CF4-8G, CF6-610G, CF-8G-A, CF-8GF, TPF4-610G | | |



ignition cables

pre-assembled cables



| | | | |
|--------------------|--|-----------------|-----------|
| Part No. | 100190 | Ref. No. | 547010500 |
| description | ignition cable cable length 1200mm connection F2.8mm / F2.8mm | | |
| For models: | CF-10G6-A, CF-10G-6F, CF-10G-A, CF-10GF, CF4-8G, CF4-8GEM, CF-8G-A, CF-8GF | | |



| | | | |
|--------------------|---|-----------------|-----------|
| Part No. | 100191 | Ref. No. | 547002300 |
| description | ignition cable cable length 2000mm connection F2.8mm / ø2.4mm | | |
| For models: | CF4-78G, CF4-78GP, CF4-78GP-AUS, CF4-78GP-USA, CF6-712G, CF6-712GP, CF6-712GPV, CF6-712GPV-USA, CF6-712GV, CFA4-78G, CFA6-712GV, PAF-78G, TP2-712G, TPF2-712G, TPF2-712GPV, TPF2-712GV, TPF2-78GP, TPF4-712GP, TPF4-712GPV, TPF-78G | | |



| | | | |
|--------------------|---|-----------------|-----------|
| Part No. | 100036 | Ref. No. | 537002500 |
| description | ignition cable cable length 500mm connection F2.8mm / F2.8mm | | |
| For models: | CF-10EM, CF-10EM-A, CF-10ET, CF-10ET-A, CF-62EM, CF-62EM-A, CF-62ET, CF-62ET-A, CF-8EM, CF-8EM-A, CF-8ET, CF-8ET-A, PC-61EM, PC-62EM, PC-62ET | | |



| | | | |
|--------------------|---|-----------------|-----------|
| Part No. | 100166 | Ref. No. | 547002700 |
| description | ignition cable cable length 500mm connection ø2.4mm / lug M4 | | |
| For models: | BM-4G, BM-61GF, BM-62GF, BM-6G, BM-74G, BM-78G, BM-8G, BR-62G, BR-6G, CP-62G, CP-6G, CP-74G, CP-78G, CW-4G, CW-61G, CW-62G, CW-6G, CW-74G, CW-78G, F13-74G, F18-74G, F2-13-78G, F2-18-78G, FG-10, FG-2-10, FMG-10, FMG-15, FMG-2-10, FMG-2-15, FMG-20, FMG-30, FP-62G, FP-6G, FPG-20, FPG-30, FQ-4G, FQ-61GF, FQ-62GF, FQ-6G, FQM-4G, FTL-4G, FTL-4GS, FTL-61G, FTL-61GF, FTL-61GS, FTL-61GSF, FTL-62G, FTL-62GF, FTL-62GS, FTL-62GSF...(Other models you can see in the webshop) | | |



| | | | |
|--------------------|---|-----------------|-----------|
| Part No. | 100197 | Ref. No. | 547002600 |
| description | ignition cable cable length 600mm connection F2.8mm / ø2.4mm | | |
| For models: | CF-10G6-A, CF-10G-6F, CF-10G-A, CF-10GEM, CF-10GEM-6, CF-10GEM6-A, CF-10GEM-A, CF-10GF, CF-62GEM, CF-62GEM-A, CF-8G-A, CF-8GEM, CF-8GEM-A, CF-8GF, CFM-10GEM, CFM-10GEM-6, CFM-10GEM6-A, CFM-10GEM-A, CFM-8GEM, CFM-8GEM-A, CP-66G, CP-74G, CP-76G, CP-78, CP-94G, CP-98G, CPA-66G, CPA-74G, CPA-76G, CPA-78G, CPA-94G, CPA-98G, CPB-98G, CPBA-98G, F2-18-98G, F25-94G, FO-1G, FO-2G, FO-3G, PC-4G, PC-61GF, PC-62GF, PC-8G | | |



| | | | |
|--------------------|---|-----------------|-----------|
| Part No. | 100015 | Ref. No. | 547003200 |
| description | ignition cable cable length 600mm connection ø2.4mm / ø2.4mm | | |
| For models: | BM-74G, BM-78G, BM-94G, BM-98G, BMT-64G, BMT-66G, BMT-74G, BMT-78G, BMT-94G, BMT-98G, BR-64G, BR-74G, BR-78G, BR-94G, BR-98G, BRT-66G, CP-62G, CP-66G, CP-74G, CP-74G-USA, CP-76G, CP-78G, CP-78G-USA, CP-94G, CP-94G-USA, CP-98G, CP-98G-USA, CPA-94G, CPP-94G, CPP-94G-USA, CPT-64G, CPT-66G, CW-74G, CW-74G-USA, CW-78G, CW-78G-USA, CW-94G, CW-98G, CWT-64G, CWT-66G, CWT-68G, CWT-74G, CWT-74G-USA, CWT-78G, CWT-78GUSA, CWT-94G, CWT-98G, F11-54G, F13-64G, F13-74G...(Other models you can see in the webshop) | | |



| | | | |
|--------------------|--|-----------------|-----------|
| Part No. | 100018 | Ref. No. | 547013900 |
| description | ignition cable cable length 600mm connection ø2.4mm / ø4mm permanent temperature 200°C | | |
| For models: | CF4-98G, CF6-912G, CF6-912GV, CF8-916G, CF8-916GV, CFA4-98G, CFA6-912GV, CPB-98G, F45-78G, PAF-98G, TP-78G, TPF2-912G, TPF2-912GE, TPF2-912GV, TPF2-98G, TPF4-912G, TPF4-912GV, TPF-78G, TPF-78GE, TPF-98G | | |



| | | | |
|--------------------|--|-----------------|-----------|
| Part No. | 100178 | Ref. No. | 547014600 |
| description | ignition cable cable length 900mm connection F2.8mm / ø2.4mm | | |
| For models: | CF4-8G, CF4-8GEM, CF4-GEMS, PC-12G, PC-4G, PC-8G | | |



| | | | |
|--------------------|--|-----------------|-----------|
| Part No. | 100146 | Ref. No. | 547006800 |
| description | ignition cable cable length 900mm connection ø2.4mm / lug M4 | | |
| For models: | CPM-62G, CPM-6G, FTL-61G, FTL-61GS, FTL-62G, FTL-62GS, FTL-63G, FTL-63GS, FTL-64G, FTL-64GS, FTLR-62G, FTLR-62GS, FTLR-63G, FTLR-63GS, FTLR-64G, FTLR-64GS, FTR-61G, FTR-61GS, FTR-62G, FTR-62GS | | |

piezoelectric igniters

mounting diameter 18mm



| | | | |
|--------------------|---|-----------------|-----------|
| Part No. | 100009 | Ref. No. | 537002800 |
| description | piezoelectric igniter body plastic blowing mounting ø 18mm connection ø2.4mm front measurements 26mm M18x1.5 | | |
| For models: | BM-4G, BM-61GF, BM-62GF, BM-6G, BM-74G, BM-78G, BM-8G, BM-94G, BM-98G, BMT-64G, BMT-66G, BMT-74G, BMT-78G, BMT-94G, BMT-98G, BR-62G, BR-6G, BR-64G, BR-74G, BR-78G, BR-94G, BR-98G, BRT-66G, CF-10G6-A, CF-10G-6F, CF-10G-A, CF-10GF, CF2-58G, CF2-58GE, CF2-68G, CF3-512GEV, CF3-512GV, CF3-612GV, CF4-78GP, CF4-78GP-AUS, CF4-78GP-USA, CF4-98G, CF-62GEM, CF-62GEM-A, CF6-712GP, CF6-712GPV, CF6-712GPV-USA, CF6-912G, CF6-912GV, CF8-916G, CF8-916GV, CF-8G-A, CF-8GF, CFA4-78G, CFA4-98G...(Other models you can see in the webshop) | | |

| | | | |
|------------------------|--|--------|-------------------|
| accessories for | 100009 | | |
| | Part No. | 101339 | Ref. No. — |
| | cover cap for piezoelectric igniter | | |
| | Part No. | 106869 | Ref. No. — |
| | cover cap for piezoelectric igniter ID ø 22mm ED ø 35mm H 25mm | | |
| | Part No. | 107931 | Ref. No. — |
| | cover cap for piezoelectric igniter ID ø 21mm ED ø 36mm | | |



mounting diameter 22mm

1



| | | | |
|---|---|-----------------|-----------|
| Part No. | 100013 | Ref. No. | 537008500 |
| description | piezoelectric igniter body plastic blowing mounting ø 22mm connection ø2.4mm cable lengthmm | | |
| For models: | CW-4G, CW-61G, CW-62G, CW-6G | | |
| accessories for | 100013 | | |
| | Part No. | Ref. No. | — |
|  | 100023 | | |
| | female bullet size 2.3mm 0.5-1.5mm ² CuZn t.max. 125°C Qty 20 pcs | | |

ignition units

1



| | | | |
|--------------------|--|-----------------|-----------|
| Part No. | 101002 | Ref. No. | 537060300 |
| description | ignition unit outputs 2 230VAC dimensions 88x23x34mm mounting distance 73mm inlet F6.3x0.8 outlet F2.8x0.8 0.6VA 50/60Hz | | |
| For models: | CP-66G, CP-74G, CP-76G, CP-78, CP-94G, CP-98G, CPA-66G, CPA-74G, CPA-76G, CPA-78G, CPA-94G, CPA-98G, CPB-98G, CPBA-98G, CPP-94G, CPP-94G-USA, F18-94G, F2-18-98G, F2-25-98G, F25-94G | | |

1



| | | | |
|--------------------|--|-----------------|-------------------------|
| Part No. | 107226 | Ref. No. | 2 x 537006601+547002400 |
| description | ignition unit outputs 2x4 220VAC with cable harness conversion kit for LOTUS | | |

1



| | | | |
|--------------------|--|-----------------|------------------------|
| Part No. | 101003 | Ref. No. | 537006600 547006600 |
| description | ignition unit outputs 4 230VAC 50Hz | | |
| For models: | CF4-68GEM, CF4-78GE, CF4-8GEM, CF4-GEMS, CF-62GEM, CF-62GEM-A, CF-8GEM, CF-8GEM-A, CFM4-66GEM, CFM4-68GEM, CFM-8GEM, CFM-8GEM-A, PC-61GF, PC-62GF, PC-74G, PC-78G, TP2-712G, TPF2-712G, TPF2-712GV | | |

1



| | | | |
|--------------------|--|-----------------|-----------|
| Part No. | 102388 | Ref. No. | 537006601 |
| description | ignition unit outputs 4 230VAC dimensions 111x23x34mm mounting distance 100mm inlet F6.3x0.8 outlet F2.8x0.8 type WAC-T4 0.6VA 50/60Hz | | |
| For models: | CF4-68GEM, CF4-8GEM, CF4-GEMS, CF6-610G, CFM4-66GEM, CFM4-68GEM, TPF4-610G | | |

1



| | | | |
|--------------------|--|-----------------|-----------|
| Part No. | 101004 | Ref. No. | 537005600 |
| description | ignition unit outputs 6 230VAC inlet F6.3x0.8 outlet F2.8x0.8 50Hz mounting ø 88mm | | |
| For models: | CF-10G-A, CF-10GEM, CF-10GEM-6, CF-10GEM6-A, CF-10GEM-A, CF-10GF, CF4-68G, CF4-78G, CF4-8G, CF4-8GEM, CF-62GEM, CF-62GEM-A, CF6-610GEM, CF6-712GEV, CF-712GE, CF-8G-A, CF-8GEM, CF-8GEM-A, CF-8GF, CFM-10GEM, CFM-10GEM-6, CFM-10GEM6-A, CFM-10GEM-A, CFM6-610GEM, CFM-8GEM, CFM-8GEM-A, PC-712G | | |

1



| | | | |
|--------------------|---|-----------------|-----------|
| Part No. | 101008 | Ref. No. | 537008400 |
| description | ignition unit outputs 8 230VAC inlet F6.3x0.8 outlet F2.8x0.8 50Hz mounting ø 103mm | | |
| For models: | CF-10G6-A, CF-10G-6F, CF-10G-A, CF-10GEM, CF-10GEM-6, CF-10GEM-A, CF-10GF, CF6-610G, CF6-712G, CF6-712GV, CFM-10GEM, CFM-10GEM-6, CFM-10GEM-A, PC-716G, TPF4-610G | | |

ignition switches

1



| | | | |
|--------------------|--|-----------------|-----------|
| Part No. | 101038 | Ref. No. | 537023600 |
| description | ignition switch 1NO mounting ømm connection F2.8x0.8 | | |
| For models: | CF-10G6-A, CF-10G-6F, CF-10G-A, CF-10GEM, CF-10GEM-6, CF-10GEM6-A, CF-10GEM-A, CF-10GF, CF-62GEM, CF-62GEM-A, CF-8G-A, CF-8GEM, CF-8GEM-A, CF-8GF, CFM-10GEM, CFM-10GEM-6, CFM-10GEM6-A, CFM-10GEM-A, CFM-8GEM, CFM-8GEM-A, PC-61GF, PC-62GF | | |



1

| | | | |
|--------------------|--|-----------------|-----------|
| Part No. | 301014 | Ref. No. | 537015600 |
| description | momentary rocker switch mounting measurements 30x11mm black 1NO 250V 16A connection male faston 6.3mm ambient temperature max. 85/125°C protection IP40 mounting ømm male faston 6.3mm | | |



1

| | | | |
|--------------------|---|-----------------|-----------|
| Part No. | 345189 | Ref. No. | 537015600 |
| description | momentary rocker switch mounting measurements 30x22mm black 2NO 250V 16A ignition connection male faston 6.3mm ambient temperature max. 125/55°C protection IP40 mounting ømm | | |

| | | | |
|--------------------|---|--|--|
| For models: | CF-10EM, CF-10EM-6, CF-10EM-A, CF-10ET, CF-10ET-6, CF-10ET-A, CF-10G6-A, CF-10G6-F, CF-10G-A, CF-10GEM, CF-10GEM-6, CF-10GEM6-A, CF-10GEM-A, CF-10GF, CF4-68G, CF4-68GEM, CF4-78G, CF4-78GE, CF4-8G, CF4-8GEM, CF4-GEMS, CF-62GEM, CF-62GEM-A, CF6-610G, CF6-610GEM, CF6-712G, CF6-712GEV, CF6-712GV, CF-712GE, CF-8EM, CF-8EM-A, CF-8ET, CF-8ET-A, CF-8G-A, CF-8GEM, CF-8GEM-A, CF-8GF, CFM-10GEM, CFM-10GEM-6, CFM-10GEM6-A, CFM-10GEM-A, CFM4-66GEM, CFM4-68GEM, CFM6-610GEM, CFM-8GEM, CFM-8GEM-A, F18-94G, F2-18-98G, F2-25-98G, F25-94G...(Other models you can see in the webshop) | | |
|--------------------|---|--|--|

| | | | | | |
|---|--|-----------------|--------|-----------------|---|
| accessories for | 345189 | Part No. | 301036 | Ref. No. | — |
|  | protective cover internal size 30x22mm for rocker switch mounting measurementsmm | | | | |

thermocouples

plug-in thermocouples

plug-in thermocouples standard

with barrel socket ø6(6.5)mm

thermocouples SIT

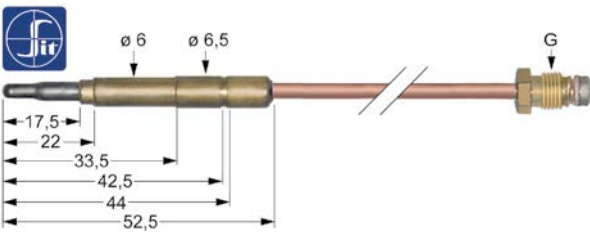

1

| | | | |
|--------------------|---|-----------------|-------|
| Part No. | 107621 | Ref. No. | 10070 |
| description | thermocouple SIT M10x1 L 1500mm plug connection ø6.0(6.5)mm | | |

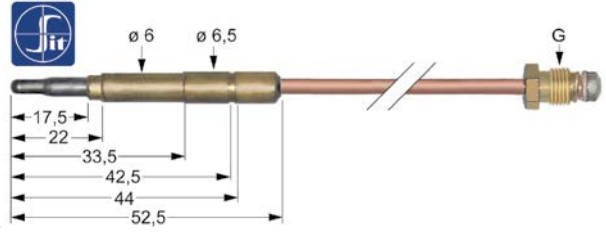

1

| | | | |
|--------------------|---|-----------------|-----------|
| Part No. | 107614 | Ref. No. | 533041800 |
| description | thermocouple SIT M9x1 L 1500mm plug connection ø6.0(6.5)mm | | |
| For models: | CF4-78G, CF4-78GP, CF4-78GP-AUS, CF4-78GP-USA, CF4-98G, CF6-712G, CF6-712GP, CF6-712GPV, CF6-712GPV-USA, CF6-712GV, CF6-912G, CF6-912GV, CF8-916G, CF8-916GV, CFA4-78G, CFA4-98G, CFA6-712GV, CFA6-912GV, CFPB6-79G, PAF-78G, PAF-98G, TPF2-712G, TPF2-712GPV, TPF2-712GV, TPF2-78GP, TPF2-912G, TPF2-912GE, TPF2-912GV, TPF2-98G, TPF4-712GP, TPF4-712GPV, TPF4-912G, TPF4-912GV, TPF-78G, TPF-98G | | |

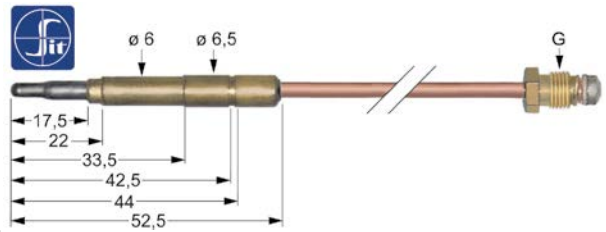

1

| | | | |
|--------------------|---|-----------------|------------------------|
| Part No. | 107608 | Ref. No. | 533045700 533053200 |
| description | thermocouple SIT M9x1 L 500mm plug connection ø6.0(6.5)mm | | |
| For models: | BM-4G, BM-61GF, BM-62GF, BM-6G, BM-74G, BM-78G, BM-8G, BM-94G, BM-98G, BMT-64G, BMT-66G, BMT-74G, BMT-78G, BMT-94G, BMT-98G, BR-62G, BR-6G, BRF-64G, BRF-74G, BRF-78G, BRF-94G, BRF-98G, BRT-66G, CF4-78GP, CF4-78GP-AUS, CF4-78GPE, CF4-78GP-USA, CF4-98G, CF4-98GE, CF6-712GP, CF6-712GPE, CF6-712GPV, CF6-712GPV-USA, CF6-912G, CF6-912GE, CF6-912GEV, CF6-912GV, CF-712GPE, CF8-916G, CF8-916GE, CF8-916GEV, CF8-916GV, CFV4-78GPE, CFV4-98GE, CFV6-712GPEV, CFV6-912GEV, CP-62G, CP-6G, CP-74G...(Other models you can see in the webshop) | | |

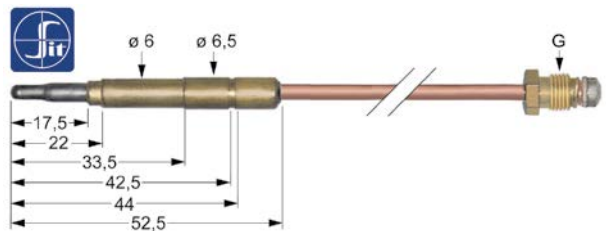

1

| | | | |
|--------------------|--|-----------------|-----------|
| Part No. | 107611 | Ref. No. | 533039400 |
| description | thermocouple SIT M9x1 L 850mm plug connection ø6.0(6.5)mm | | |
| For models: | CF2-58G, CF2-58GE, CF2-68G, CF2-68GEM, CF3-512GEV, CF3-512GV, CF3-612GEMV, CF3-612GV, CF4-78GP, CF4-78GP-AUS, CF4-78GPE, CF4-78GP-USA, CF4-98G, CF4-98GE, CF6-712GP, CF6-712GPE, CF6-712GPV, CF6-712GPV-USA, CF6-912G, CF6-912GE, CF6-912GEV, CF6-912GV, CF8-916G, CF8-916GE, CF8-916GEV, CF8-916GV, CFM2-68GEM, CFM3-612GEMV, CFV4-78GPE, CFV4-98GE, CFV6-712GPEV, CFV6-912GEV, CP-66G, CP-76G, CPA-66G, CPA-76G, CPB-98G, CPBA-98G, CPM-62G, CPM-6G, PC1T-64G, PC2T-68G, PC3-612G, PC3T-612G, PC-712GP, PC-712GP-USA, PC-716GP, PC-716GPUSA, PC-74GP...(Other models you can see in the webshop) | | |



threaded thermocouples (miscellaneous)

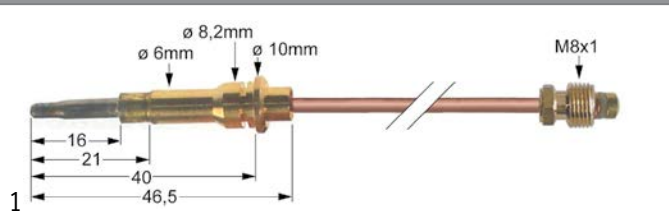

| | | | |
|--------------------|--|-----------------|-----------|
| Part No. | 102262 | Ref. No. | 533083900 |
| description | thermocouple M8x1 L 1200mm plug connection ø6.0mm | | |
| For models: | CF-10G6-A, CF-10G-6F, CF-10G-A, CF-10GF, CF2-58G, CF2-58GE, CF2-68G, CF3-512GEV, CF3-512GV, CF3-612GV, CF4-68G, CF4-8G, CF6-610G, CF-8G-A, CF-8GF, TPF4-610G | | |

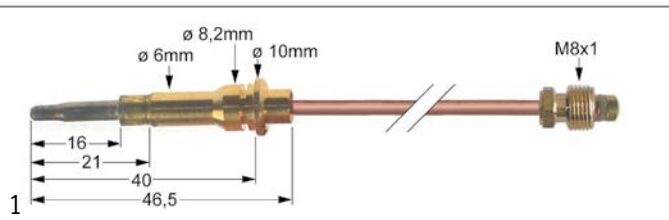

| | | | |
|--------------------|--|-----------------|-----------|
| Part No. | 102263 | Ref. No. | 533083800 |
| description | thermocouple M8x1 L 1400mm plug connection ø6.0mm | | |
| For models: | CF-10G6-A, CF-10G-6F, CF-10G-A, CF-10GF, CF2-58G, CF2-58GE, CF2-68G, CF3-512GEV, CF3-512GV, CF3-612GV, CF4-68G, CF4-8G, CF6-610G, CF-8G-A, CF-8GF, TPF4-610G | | |

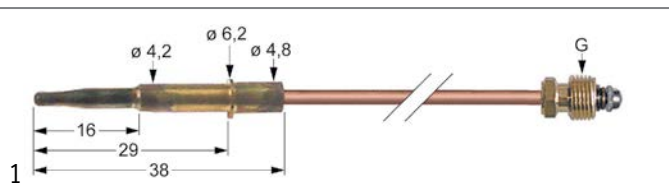

| | | | |
|--------------------|--|-----------------|-----------|
| Part No. | 102261 | Ref. No. | 533077200 |
| description | thermocouple M8x1 L 600mm plug connection ø6.0mm | | |
| For models: | CF-10G6-A, CF-10G-6F, CF-10G-A, CF-10GEM, CF-10GEM-6, CF-10GEM6-A, CF-10GEM-A, CF-10GF, CF-62GEM, CF-62GEM-A, CF-8G-A, CF-8GEM, CF-8GEM-A, CF-8GF, CFM-10GEM, CFM-10GEM-6, CFM-10GEM6-A, CFM-10GEM-A, CFM-8GEM, CFM-8GEM-A, PC-61GF, PC-62GF | | |

plug-in thermocouples with cable link

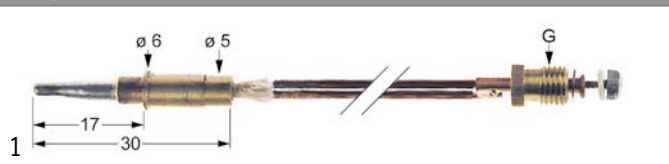

| | | | |
|--------------------|--|-----------------|-----------|
| Part No. | 102260 | Ref. No. | 533077100 |
| description | thermocouple with two-conductors L 600mm plug connection ø6.0mm M8x1 | | |
| For models: | CF-10G6-A, CF-10G-6F, CF-10G-A, CF-10GEM, CF-10GEM-6, CF-10GEM6-A, CF-10GEM-A, CF-10GF, CF-62GEM, CF-62GEM-A, CF-8G-A, CF-8GEM, CF-8GEM-A, CF-8GF, CFM-10GEM, CFM-10GEM-6, CFM-10GEM6-A, CFM-10GEM-A, CFM-8GEM, CFM-8GEM-A, PC-61GF, PC-62GF | | |

plug-in thermocouples with interruption

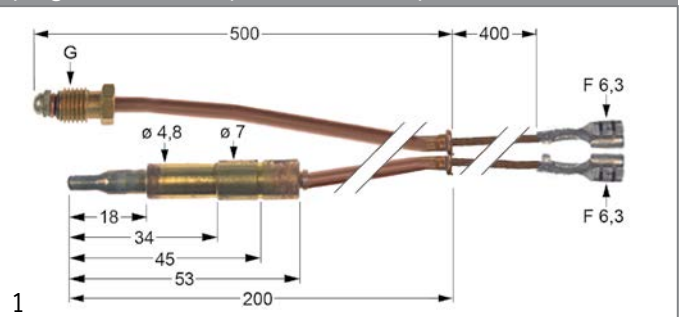

| | | | |
|--------------------|--|-----------------|-----------|
| Part No. | 102115 | Ref. No. | 533067200 |
| description | thermocouple with interrupter M9x1 L 500mm plug connection ø4.8mm F 6.3mm | | |
| For models: | CPT-74G, CPT-76G, F11-54G, F13-64G, F13-74G, F13T-74G, F13T-94G, F18-74G, F18-94G, F2-13-78G, F2-13T-78G, F2-13T-98G, F2-18-78G, F2-18-98G, F2-25-98G, F25-94G, F2-8-74G, F2-8-94G, F2-8T-66G, F2-8T-74G, F2-8T-94G, F45-78G, F8T-63G, FG-10, FG-2-10, FMG-10, FMG-15, FMG-2-10, FMG-2-15, FMPG-20, FMPG-30, FP-62G, FP-6G, FPG-20, FPG-30, FQ-4G, FQ-61GF, FQ-62GF, FQ-6G, FQM-4G | | |

threaded thermocouples

threaded thermocouples standard

with socket with thread M8x1

SIT

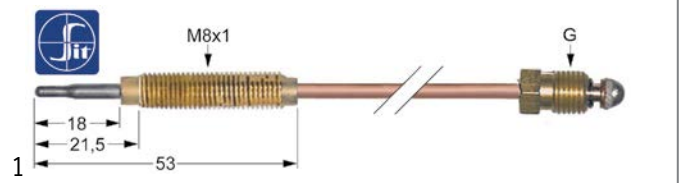

| | | | |
|--------------------|--|-----------------|-----------|
| Part No. | 107633 | Ref. No. | 533011800 |
| description | thermocouple SIT M8x1 L 1200mm M8x1 | | |
| For models: | CF-10G6-A, CF-10G-6F, CF-10G-A, CF-10GF, CF4-8G, CF4-8GEM, CF-8G-A, CF-8GF | | |

| | | | |
|---|--|--------|-----------------|
| accessories for | 107633 | | |
|  | Part No. | 102067 | Ref. No. |
| | | | 533009800 |
| | nut thread M8x1 H 3mm brass Qty 1 pcs type SEF 1 | | |

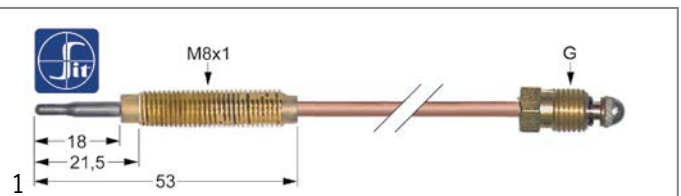

| | | | |
|--------------------|-------------------------------------|-----------------|-----------|
| Part No. | 107634 | Ref. No. | 533053700 |
| description | thermocouple SIT M8x1 L 1500mm M8x1 | | |
| For models: | CF4-8G, CF4-8GEM | | |

| | | | |
|---|--|--------|-----------------|
| accessories for | 107634 | | |
|  | Part No. | 102067 | Ref. No. |
| | | | 533009800 |
| | nut thread M8x1 H 3mm brass Qty 1 pcs type SEF 1 | | |



| | | | |
|--|------------------------------------|-----------------|---------------------------|
| Part No. | 107630 | Ref. No. | 53301100 |
| description | thermocouple SIT M8x1 L 600mm M8x1 | | |
| accessories for | 107630 | | |
| | Part No. | 102067 | Ref. No. 533009800 |
| nut thread M8x1 H 3mm brass Qty 1 pcs type SEF 1 | | | |

thermopiles

| | | | |
|--------------------|---|-----------------|-----------|
| Part No. | 102116 | Ref. No. | 537033000 |
| description | thermopile ROBERTSHAW L 900mm probe ø 9mm probe L 57mm 250-750mV screw connection 7/16" | | |

extensions

| | | | |
|--|--|-----------------|-------------------|
| Part No. | 102013 | Ref. No. | 533053300 |
| description | thermocouple extension thread M9x1 L 500mm | | |
| For models: | BM-4G, BM-6G, BM-74G, BM-78G, BM-8G, BM-94G, BM-98G, BMT-64G, BMT-66G, BMT-74G, BMT-78G, BMT-94G, BMT-98G, CP-62G, CP-6G, F13T-74G, F-1G, F2-13T-78G, F2-8T-66G, F45-78G, F8T-63G, FP-62G, FP-6G, FQ-4G, FQ-61GF, FQ-62GF, FQ-6G, FQM-4G, FTL-54G, FTL-56G, FTL-712G, FTL-712GS, FTL-712G-USA, FTL-74G, FTL-74GS, FTL-74GUSA, FTL-76G, FTL-76G-USA, FTL-78G, FTL-78G-AUS, FTL-78GS, FTL-78G-USA, FTL-916G, FTL-94G, FTL-94GS, FTL-98G, FTL-98GS, FTLR-56G, FTLR-712G, FTLR-712GS...(Other models you can see in the webshop) | | |
| accessories for | 102013 | | |
| | Part No. | 101261 | Ref. No. — |
| thermocouple fitting thread M9x1 Qty 1 pcs | | | |

accessories

nuts

| | | | |
|--------------------|---|-----------------|-----------|
| Part No. | 102067 | Ref. No. | 533009800 |
| description | nut thread M8x1 H 3mm brass Qty 1 pcs type SEF 1 | | |
| For models: | CF-10G6-A, CF-10G-6F, CF-10G-A, CF-10GEM, CF-10GEM-6, CF-10GEM6-A, CF-10GEM-A, CF-10GF, CF4-78G, CF4-78GE, CF4-8G, CF4-8GEM, CF4-GEMS, CF-62GEM, CF-62GEM-A, CF6-712G, CF6-712GEV, CF6-712GV, CF-712GE, CF-8G-A, CF-8GEM, CF-8GEM-A, CF-8GF, CFM-10GEM, CFM-10GEM-6, CFM-10GEM6-A, CFM-10GEM-A, CFM-8GEM, CFM-8GEM-A, F-1G, FB-1G, FO-1G, FO-2G, FO-3G, FOS-1G, FOS-2G, FOS-3G, PC-12G, PC-4G, PC-61GF, PC-62GF, PC-712G, PC-716G, PC-74G, PC-78G, PC-8G, TP2-712G, TPF2-712G, TPF2-712GV | | |

interrupters

| | | | |
|--------------------|---|-----------------|-----------|
| Part No. | 101265 | Ref. No. | 533011600 |
| description | interrupter thread M9x1 | | |
| For models: | FG-10, FG-2-10, FMG-10, FMG-15, FMG-2-10, FMG-2-15, FMPG-20, FMPG-30, FP-62G, FP-6G, FPG-20, FPG-30, FQ-4G, FQ-61GF, FQ-62GF, FQ-6G, FQM-4G | | |

gas burners

hob burners

universal hob burners

GEV



| | | | |
|--------------------|--|-----------------|-----|
| Part No. | 106379 | Ref. No. | N/A |
| description | air mixing tube for burner cap ø 80mm L 23mm D1 ø 20mm D2 ø 15.6mm D3 ø 14mm | | |

| | | | |
|---|--|-----------------|---------------------------|
| Part No. | 103068 | Ref. No. | 532001200 |
| description | burner cap ø 100mm | | |
| For models: | CF-10G6-A, CF-10G-6F, CF-10G-A, CF-10GEM, CF-10GEM-6, CF-10GEM6-A, CF-10GEM-A, CF-10GF, CF-62GEM, CF-62GEM-A, CF-8G-A, CF-8GEM, CF-8GEM-A, CF-8GF, CFM-10GEM, CFM-10GEM-6, CFM-10GEM6-A, CFM-10GEM-A, CFM-8GEM, CFM-8GEM-A, PC-61GF, PC-62GF | | |
| accessories for | 103068 | | |
| | Part No. | 103067 | Ref. No. 532000900 |
| burner ring for burner cap ø 100mm | | | |
| | Part No. | 104102 | Ref. No. 532000600 |
| burner head for burner cap ø 100mm ext. ø 130 | | | |
| | Part No. | 104103 | Ref. No. 532000300 |
| burner holder suitable for burner ø100mm with nozzle holder | | | |

| | | | |
|-----------------------------------|--|-----------------|---------------------------|
| Part No. | 103066 | Ref. No. | 532001100 |
| description | burner cap ø 80mm | | |
| For models: | CF-10G6-A, CF-10G-6F, CF-10G-A, CF-10GEM, CF-10GEM-6, CF-10GEM6-A, CF-10GEM-A, CF-10GF, CF-62GEM, CF-62GEM-A, CF-8G-A, CF-8GEM, CF-8GEM-A, CF-8GF, CFM-10GEM, CFM-10GEM-6, CFM-10GEM6-A, CFM-10GEM-A, CFM-8GEM, CFM-8GEM-A, PC-61GF, PC-62GF | | |
| accessories for | 103066 | | |
| | Part No. | 103065 | Ref. No. 532000800 |
| burner ring for burner cap ø 80mm | | | |

Table continues overleaf



| | | | |
|---|---|--------|---------------------------|
| accessories for | 103066 | | |
|  | Part No. | 104100 | Ref. No. 532000500 |
| | burner head for burner cap ø 80mm | | |
|  | Part No. | 104101 | Ref. No. 532000200 |
| | burner holder for burner cap ø 80mm with nozzle holder with mixing sleeve | | |

| | | | |
|---|--|-----------------|-----------|
|  | 1 | | |
| Part No. | 104102 | Ref. No. | 532000600 |
| description | burner head for burner cap ø 100mm ext. ø 130 | | |
| For models: | CF-10G6-A, CF-10G-6F, CF-10G-A, CF-10GEM, CF-10GEM-6, CF-10GEM6-A, CF-10GEM-A, CF-10GF, CF-62GEM, CF-62GEM-A, CF-8G-A, CF-8GEM, CF-8GEM-A, CF-8GF, CFM-10GEM, CFM-10GEM-6, CFM-10GEM6-A, CFM-10GEM-A, CFM-8GEM, CFM-8GEM-A, PC-61GF, PC-62GF | | |

| | | | |
|---|--|-----------------|---------------------------|
|  | 1 | | |
| Part No. | 104100 | Ref. No. | 532000500 |
| description | burner head for burner cap ø 80mm | | |
| For models: | CF-10G6-A, CF-10G-6F, CF-10G-A, CF-10GEM, CF-10GEM-6, CF-10GEM6-A, CF-10GEM-A, CF-10GF, CF-62GEM, CF-62GEM-A, CF-8G-A, CF-8GEM, CF-8GEM-A, CF-8GF, CFM-10GEM, CFM-10GEM-6, CFM-10GEM6-A, CFM-10GEM-A, CFM-8GEM, CFM-8GEM-A, PC-61GF, PC-62GF | | |
| accessories for | 104100 | | |
|  | Part No. | 103065 | Ref. No. 532000800 |
| | burner ring for burner cap ø 80mm | | |
|  | Part No. | 103066 | Ref. No. 532001100 |
| | burner cap ø 80mm | | |
|  | Part No. | 104103 | Ref. No. 532000300 |
| | burner holder suitable for burner ø100mm with nozzle holder | | |

| | | | |
|---|--|-----------------|---------------------------|
|  | 1 | | |
| Part No. | 104101 | Ref. No. | 532000200 |
| description | burner holder for burner cap ø 80mm with nozzle holder with mixing sleeve | | |
| For models: | CF-10G6-A, CF-10G-6F, CF-10G-A, CF-10GEM, CF-10GEM-6, CF-10GEM6-A, CF-10GEM-A, CF-10GF, CF-62GEM, CF-62GEM-A, CF-8G-A, CF-8GEM, CF-8GEM-A, CF-8GF, CFM-10GEM, CFM-10GEM-6, CFM-10GEM6-A, CFM-10GEM-A, CFM-8GEM, CFM-8GEM-A, PC-61GF, PC-62GF | | |
| accessories for | 104101 | | |
|  | Part No. | 103065 | Ref. No. 532000800 |
| | burner ring for burner cap ø 80mm | | |
|  | Part No. | 103066 | Ref. No. 532001100 |
| | burner cap ø 80mm | | |
|  | Part No. | 104100 | Ref. No. 532000500 |
| | burner head for burner cap ø 80mm | | |

| | | | |
|---|--|-----------------|---------------------------|
|  | 1 | | |
| Part No. | 104103 | Ref. No. | 532000300 |
| description | burner holder suitable for burner ø100mm with nozzle holder | | |
| For models: | CF-10G6-A, CF-10G-6F, CF-10G-A, CF-10GEM, CF-10GEM-6, CF-10GEM6-A, CF-10GEM-A, CF-10GF, CF-62GEM, CF-62GEM-A, CF-8G-A, CF-8GEM, CF-8GEM-A, CF-8GF, CFM-10GEM, CFM-10GEM-6, CFM-10GEM6-A, CFM-10GEM-A, CFM-8GEM, CFM-8GEM-A, PC-61GF, PC-62GF | | |
| accessories for | 104103 | | |
|  | Part No. | 103067 | Ref. No. 532000900 |
| | burner ring for burner cap ø 100mm | | |
|  | Part No. | 103068 | Ref. No. 532001200 |
| | burner cap ø 100mm | | |
|  | Part No. | 104102 | Ref. No. 532000600 |
| | burner head for burner cap ø 100mm ext. ø 130 | | |

| | | | |
|---|--|-----------------|---------------------------|
|  | 1 | | |
| Part No. | 103067 | Ref. No. | 532000900 |
| description | burner ring for burner cap ø 100mm | | |
| For models: | CF-10G6-A, CF-10G-6F, CF-10G-A, CF-10GEM, CF-10GEM-6, CF-10GEM6-A, CF-10GEM-A, CF-10GF, CF-62GEM, CF-62GEM-A, CF-8G-A, CF-8GEM, CF-8GEM-A, CF-8GF, CFM-10GEM, CFM-10GEM-6, CFM-10GEM6-A, CFM-10GEM-A, CFM-8GEM, CFM-8GEM-A, PC-61GF, PC-62GF | | |
| accessories for | 103067 | | |
|  | Part No. | 103068 | Ref. No. 532001200 |
| | burner cap ø 100mm | | |
|  | Part No. | 104102 | Ref. No. 532000600 |
| | burner head for burner cap ø 100mm ext. ø 130 | | |
|  | Part No. | 104103 | Ref. No. 532000300 |
| | burner holder suitable for burner ø100mm with nozzle holder | | |

| | | | |
|---|--|-----------------|---------------------------|
|  | 1 | | |
| Part No. | 103065 | Ref. No. | 532000800 |
| description | burner ring for burner cap ø 80mm | | |
| For models: | CF-10G6-A, CF-10G-6F, CF-10G-A, CF-10GEM, CF-10GEM-6, CF-10GEM6-A, CF-10GEM-A, CF-10GF, CF-62GEM, CF-62GEM-A, CF-8G-A, CF-8GEM, CF-8GEM-A, CF-8GF, CFM-10GEM, CFM-10GEM-6, CFM-10GEM6-A, CFM-10GEM-A, CFM-8GEM, CFM-8GEM-A, PC-61GF, PC-62GF | | |
| accessories for | 103065 | | |
|  | Part No. | 103066 | Ref. No. 532001100 |
| | burner cap ø 80mm | | |
|  | Part No. | 104100 | Ref. No. 532000500 |
| | burner head for burner cap ø 80mm | | |
|  | Part No. | 104101 | Ref. No. 532000200 |
| | burner holder for burner cap ø 80mm with nozzle holder with mixing sleeve | | |





| ARC | | | |
|---|---|-----------------|-----------|
| 65 series | | | |
|  | | | |
| 1 | | | |
| Part No. | 104332 | Ref. No. | 532004800 |
| description | angle piece horizontal 3kW for Venturi | | |
| For models: | CF4-78GP, CF4-78GP-AUS, CF4-78GPE, CF4-78GP-USA, CF6-712GP, CF6-712GPE, CF6-712GPEV, CF6-712GPV, CF6-712GPV-USA, CF-712GPE, CFV4-78GPE, CFV6-712GPEV, PC-712GP, PC-712GP-USA, PC-716GP, PC-716GP-USA, PC-74GP, PC-74GP-USA, PC-78GP, PC-78GPUSA, PCD-64G, PCD-68G, PCT-712GP, PCT-712GP-USA, PCT-716GP, PCT-716GP-USA, PCT-74GP, PCT-78GP, PCT-78GP-USA, TP4-712GP, TP4T-712GP, TPF4-712GP, TPF4-712GPE, TPF4-712GPEV, TPF4-712GPV, TPFV4-712GPEV | | |

| | | | |
|---|---|-----------------|-----------|
|  | | | |
| 1 | | | |
| Part No. | 104334 | Ref. No. | 532005000 |
| description | angle piece horizontal 7.5kW for Venturi | | |
| For models: | CF4-78GP, CF4-78GP-AUS, CF4-78GPE, CF4-78GP-USA, CF6-712GP, CF6-712GPE, CF6-712GPEV, CF6-712GPV, CF6-712GPV-USA, CF-712GPE, CFV4-78GPE, CFV6-712GPEV, PC-712GP, PC-712GP-USA, PC-716GP, PC-716GP-USA, PC-74GP, PC-74GP-USA, PC-78GP, PC-78GPUSA, PCD-64G, PCD-68G, PCT-712GP, PCT-712GP-USA, PCT-716GP, PCT-74GP, PCT-78GP, PCT-78GP-USA, TP2-712GP, TP2-78GP, TP2T-712GP, TP2T-78GP, TP4-712GP, TP4T-712GP, TPF2-712GP, TPF2-712GPE, TPF2-712GPEV, TPF2-712GPV, TPF2-78GP, TPF2-78GPE, TPF4-712GP, TPF4-712GPE, TPF4-712GPEV, TPF4-712GPV, TPFV2-712GPEV, TPFV2-78GPE, TPFV4-712GPEV | | |

| | | | |
|---|---|-----------------|-----------|
|  | | | |
| 1 | | | |
| Part No. | 104310 | Ref. No. | 532007400 |
| description | burner cap 3kW ED ø 73mm seat ø 67mm chrome-plated | | |
| For models: | CF4-78GP, CF4-78GP-AUS, CF4-78GPE, CF4-78GP-USA, CF6-712GP, CF6-712GPE, CF6-712GPEV, CF6-712GPV, CF6-712GPV-USA, CF-712GPE, CFV4-78GPE, CFV6-712GPEV, PC-712GP, PC-712GP-USA, PC-716GP, PC-716GP-USA, PC-74GP, PC-74GP-USA, PC-78GP, PC-78GPUSA, PCD-64G, PCD-68G, PCT-712GP, PCT-712GP-USA, PCT-716GP, PCT-716GP-USA, PCT-74GP, PCT-78GP, PCT-78GP-USA, TP4-712GP, TP4T-712GP, TPF4-712GP, TPF4-712GPE, TPF4-712GPEV, TPF4-712GPV, TPFV4-712GPEV | | |

| | | | |
|---|---|-----------------|-----------|
|  | | | |
| 1 | | | |
| Part No. | 104320 | Ref. No. | 532004700 |
| description | burner cap 7.5kW ED ø 128mm ID ø 70mm seat ø 119.6mm chrome-plated | | |
| For models: | CF4-78GP, CF4-78GP-AUS, CF4-78GPE, CF4-78GP-USA, CF6-712GP, CF6-712GPE, CF6-712GPEV, CF6-712GPV, CF6-712GPV-USA, CF-712GPE, CFA4-78G, CFA4-98G, CFA6-712GV, CFA6-912GV, CFV4-78GPE, CFV6-712GPEV, PC-712GP, PC-712GP-USA, PC-716GP, PC-716GP-USA, PC-74GP, PC-74GP-USA, PC-78GP, PC-78GP-USA, PCA-712G, PCA-74G, PCA-78G, PCA-912G, PCA-94G, PCA-98G, PCD-64G, PCD-68G, PCT-712GP, PCT-712GP-USA, PCT-716GP, PCT-74GP, PCT-78GP, PCT-78GP-USA, TP2-712GP, TP2-78GP, TP2T-712GP, TP2T-78GP, TP4-712GP, TP4T-712GP, TPF2-712GP, TPF2-712GPE, TPF2-712GPEV, TPF2-712GPV, TPF2-78GP, TPF2-78GPE...(Other models you can see in the webshop) | | |

| | | | |
|---|---|-----------------|-----------------|
|  | | | |
| 1 | | | |
| Part No. | 104311 | Ref. No. | 532004200 |
| description | burner head 3kW for burner cap ø 73mm seat ø 67mm chrome-plated | | |
| For models: | CF4-78GP, CF4-78GP-AUS, CF4-78GPE, CF4-78GP-USA, CF6-712GP, CF6-712GPE, CF6-712GPEV, CF6-712GPV, CF6-712GPV-USA, CF-712GPE, CFV4-78GPE, CFV6-712GPEV, PC-712GP, PC-712GP-USA, PC-716GP, PC-716GP-USA, PC-74GP, PC-74GP-USA, PC-78GP, PC-78GPUSA, PCD-64G, PCD-68G, PCT-712GP, PCT-712GP-USA, PCT-716GP, PCT-716GP-USA, PCT-74GP, PCT-78GP, PCT-78GP-USA, TP4-712GP, TP4T-712GP, TPF4-712GP, TPF4-712GPE, TPF4-712GPEV, TPF4-712GPV, TPFV4-712GPEV | | |
| accessories for | 104311 | | |
| | Part No. | 104310 | Ref. No. |
| | | | 532007400 |
| |  | | |
| | burner cap 3kW ED ø 73mm seat ø 67mm chrome-plated | | |

| | | | |
|---|---|-----------------|-----------|
|  | | | |
| 1 | | | |
| Part No. | 104321 | Ref. No. | 532004400 |
| description | burner head 7.5kW for burner cap ø 128mm ED ø 151mm seat ø 120mm chrome-plated | | |
| For models: | CF4-78GP, CF4-78GP-AUS, CF4-78GPE, CF4-78GP-USA, CF6-712GP, CF6-712GPE, CF6-712GPEV, CF6-712GPV, CF6-712GPV-USA, CF-712GPE, CFA4-78G, CFA4-98G, CFA6-712GV, CFA6-912GV, CFV4-78GPE, CFV6-712GPEV, PC-712GP, PC-712GP-USA, PC-716GP, PC-716GP-USA, PC-74GP, PC-74GP-USA, PC-78GP, PC-78GP-USA, PCA-712G, PCA-74G, PCA-78G, PCA-912G, PCA-94G, PCA-98G, PCD-64G, PCD-68G, PCT-712GP, PCT-712GP-USA, PCT-716GP, PCT-74GP, PCT-78GP, PCT-78GP-USA, TP2-712GP, TP2-78GP, TP2T-712GP, TP2T-78GP, TP4-712GP, TP4T-712GP, TPF2-712GP, TPF2-712GPE, TPF2-712GPEV, TPF2-712GPV, TPF2-78GP, TPF2-78GPE...(Other models you can see in the webshop) | | |

| | | | |
|---|---|-----------------|-----------|
|  | | | |
| 1 | | | |
| Part No. | 104327 | Ref. No. | 533101000 |
| description | burner pipe 3kW L 93mm total length 108mm air mixer ø 14mm ED ø 26.6mm ID ø 20.7mm | | |
| For models: | CF4-78GP, CF4-78GP-AUS, CF4-78GPE, CF4-78GP-USA, CF6-712GP, CF6-712GPE, CF6-712GPEV, CF6-712GPV, CF6-712GPV-USA, CF-712GPE, CFV4-78GPE, CFV6-712GPEV, PC-712GP, PC-712GP-USA, PC-716GP, PC-716GP-USA, PC-74GP, PC-74GP-USA, PC-78GP, PC-78GPUSA, PCD-64G, PCD-68G, PCT-712GP, PCT-712GP-USA, PCT-716GP, PCT-716GP-USA, PCT-74GP, PCT-78GP, PCT-78GP-USA, TP4-712GP, TP4T-712GP, TPF4-712GP, TPF4-712GPE, TPF4-712GPEV, TPF4-712GPV, TPFV4-712GPEV | | |

| | | | |
|---|---|-----------------|-----------|
|  | | | |
| 1 | | | |
| Part No. | 104329 | Ref. No. | 533101200 |
| description | burner pipe 7.5kW L 93mm total length 108mm air mixer ø 29.7mm ED ø 33.8mm ID ø 27.6mm | | |
| For models: | CF4-78GP, CF4-78GP-AUS, CF4-78GPE, CF4-78GP-USA, CF6-712GP, CF6-712GPE, CF6-712GPEV, CF6-712GPV, CF6-712GPV-USA, CF-712GPE, CFV4-78GPE, CFV6-712GPEV, PC-712GP, PC-712GP-USA, PC-716GP, PC-716GP-USA, PC-74GP, PC-74GP-USA, PC-78GP, PC-78GPUSA, PCD-64G, PCD-68G, PCT-712GP, PCT-712GP-USA, PCT-716GP, PCT-74GP, PCT-78GP, PCT-78GP-USA, TP2-712GP, TP2-78GP, TP2T-712GP, TP2T-78GP, TP4-712GP, TP4T-712GP, TPF2-712GP, TPF2-712GPE, TPF2-712GPEV, TPF2-712GPV, TPF2-78GP, TPF2-78GPE, TPF4-712GP, TPF4-712GPE, TPF4-712GPEV, TPF4-712GPV, TPFV2-712GPEV, TPFV2-78GPE, TPFV4-712GPEV | | |







SABAF

DUAL tripple ring burner series - flat skirt version



| | | | |
|---|--|-----------------|---------------------------|
| Part No. | 105742 | Ref. No. | 532003600 |
| description | burner cap 4.5kW ø 128mm mounting pos. outer bright finish | | |
| For models: | CF-10G6-A, CF-10G-6F, CF-10G-A, CF-10GEM, CF-10GEM-6, CF-10GEM6-A, CF-10GEM-A, CF-10GF, CF-62GEM, CF-62GEM-A, CF-8G-A, CF-8GEM, CF-8GEM-A, CF-8GF, CFM-10GEM, CFM-10GEM-6, CFM-10GEM6-A, CFM-10GEM-A, CFM-8GEM, CFM-8GEM-A, PC-61GF, PC-62GF | | |
| accessories for | 105742 | | |
|  | Part No. | 105740 | Ref. No. 532003500 |
| | burner cap 4.5kW ø 48mm mounting pos. inner bright finish | | |
|  | Part No. | 105741 | Ref. No. 532003200 |
| | burner head 4.5kW mounting pos. inner for burner cap ø 55mm | | |
|  | Part No. | 105743 | Ref. No. 532003300 |
| | burner head 4.5kW mounting pos. outer for burner cap ø 128mm | | |
|  | Part No. | 105745 | Ref. No. 532003000 |
| | burner lower part 4.5kW | | |

| | | | |
|---|--|--------|---------------------------|
|  | Part No. | 105740 | Ref. No. 532003500 |
| | burner cap 4.5kW ø 48mm mounting pos. inner bright finish | | |
| For models: | CF-10G6-A, CF-10G-6F, CF-10G-A, CF-10GEM, CF-10GEM-6, CF-10GEM6-A, CF-10GEM-A, CF-10GF, CF-62GEM, CF-62GEM-A, CF-8G-A, CF-8GEM, CF-8GEM-A, CF-8GF, CFM-10GEM, CFM-10GEM-6, CFM-10GEM6-A, CFM-10GEM-A, CFM-8GEM, CFM-8GEM-A, PC-61GF, PC-62GF | | |
| accessories for | 105740 | | |
|  | Part No. | 105741 | Ref. No. 532003200 |
| | burner head 4.5kW mounting pos. inner for burner cap ø 55mm | | |
|  | Part No. | 105742 | Ref. No. 532003600 |
| | burner cap 4.5kW ø 128mm mounting pos. outer bright finish | | |
|  | Part No. | 105743 | Ref. No. 532003300 |
| | burner head 4.5kW mounting pos. outer for burner cap ø 128mm | | |
|  | Part No. | 105745 | Ref. No. 532003000 |
| | burner lower part 4.5kW | | |

| | | | |
|---|--|--------|---------------------------|
|  | Part No. | 105741 | Ref. No. 532003200 |
| | burner head 4.5kW mounting pos. inner for burner cap ø 55mm | | |
| For models: | CF-10G6-A, CF-10G-6F, CF-10G-A, CF-10GEM, CF-10GEM-6, CF-10GEM6-A, CF-10GEM-A, CF-10GF, CF-62GEM, CF-62GEM-A, CF-8G-A, CF-8GEM, CF-8GEM-A, CF-8GF, CFM-10GEM, CFM-10GEM-6, CFM-10GEM6-A, CFM-10GEM-A, CFM-8GEM, CFM-8GEM-A, PC-61GF, PC-62GF | | |
| accessories for | 105741 | | |
|  | Part No. | 105740 | Ref. No. 532003500 |
| | burner cap 4.5kW ø 48mm mounting pos. inner bright finish | | |
|  | Part No. | 105742 | Ref. No. 532003600 |
| | burner cap 4.5kW ø 128mm mounting pos. outer bright finish | | |
|  | Part No. | 105743 | Ref. No. 532003300 |
| | burner head 4.5kW mounting pos. outer for burner cap ø 128mm | | |
|  | Part No. | 105745 | Ref. No. 532003000 |
| | burner lower part 4.5kW | | |





| | | | |
|---|--|--------|---------------------------|
|  | Part No. | 105743 | Ref. No. 532003300 |
| | burner head 4.5kW mounting pos. outer for burner cap ø 128mm | | |
| For models: | CF-10G6-A, CF-10G-6F, CF-10G-A, CF-10GEM, CF-10GEM-6, CF-10GEM6-A, CF-10GEM-A, CF-10GF, CF-62GEM, CF-62GEM-A, CF-8G-A, CF-8GEM, CF-8GEM-A, CF-8GF, CFM-10GEM, CFM-10GEM-6, CFM-10GEM6-A, CFM-10GEM-A, CFM-8GEM, CFM-8GEM-A, PC-61GF, PC-62GF | | |
| accessories for | 105743 | | |
|  | Part No. | 105740 | Ref. No. 532003500 |
| | burner cap 4.5kW ø 48mm mounting pos. inner bright finish | | |
|  | Part No. | 105741 | Ref. No. 532003200 |
| | burner head 4.5kW mounting pos. inner for burner cap ø 55mm | | |
|  | Part No. | 105742 | Ref. No. 532003600 |
| | burner cap 4.5kW ø 128mm mounting pos. outer bright finish | | |
|  | Part No. | 105745 | Ref. No. 532003000 |
| | burner lower part 4.5kW | | |







| | | | |
|---|--|-----------------|---------------------------|
|  | | | |
| 1 | | | |
| Part No. | 105745 | Ref. No. | 532003000 |
| description | burner lower part 4.5kW | | |
| For models: | CF-10G6-A, CF-10G-6F, CF-10G-A, CF-10GEM, CF-10GEM-6, CF-10GEM6-A, CF-10GEM-A, CF-10GF, CF-62GEM, CF-62GEM-A, CF-8G-A, CF-8GEM, CF-8GEM-A, CF-8GF, CFM-10GEM, CFM-10GEM-6, CFM-10GEM6-A, CFM-10GEM-A, CFM-8GEM, CFM-8GEM-A, PC-61GF, PC-62GF | | |
| accessories for | 105745 | | |
|  | Part No. | 105740 | Ref. No. 532003500 |
| | burner cap 4.5kW ø 48mm mounting pos. inner bright finish | | |
|  | Part No. | 105741 | Ref. No. 532003200 |
| | burner head 4.5kW mounting pos. inner for burner cap ø 55mm | | |
|  | Part No. | 105742 | Ref. No. 532003600 |
| | burner cap 4.5kW ø 128mm mounting pos. outer bright finish | | |
|  | Part No. | 105743 | Ref. No. 532003300 |
| | burner head 4.5kW mounting pos. outer for burner cap ø 128mm | | |

FLAM GAS





SF series





| | | | |
|---|---|-----------------|---------------------------|
|  | | | |
| 1 | | | |
| Part No. | 105749 | Ref. No. | 544424100 |
| description | air mixer | | |
| For models: | CF2-58G, CF2-58GE, CF2-68G, CF2-68GEM, CF3-512GEV, CF3-512GV, CF3-612GEMV, CF3-612GV, CF4-98G, CF4-98GE, CF6-912G, CF6-912GE, CF6-912GEV, CF6-912GV, CF8-916G, CF8-916GE, CF8-916GEV, CF8-916GV, CFM2-68GEM, CFM3-612GEMV, CFV4-98GE, CFV6-912GEV, PC1T-64G, PC2T-68G, PC3-612G, PC3T-612G, PC-912G, PC-916G, PC-94G, PC-98G, PCD-44G, PCT-912G, PCT-916G, PCT-94G, PCT-98G, TP2-912G, TP2-98G, TP2T-912G, TP2T-98G, TP4-912G, TP4T-912G, TPF2-912G, TPF2-912GE, TPF2-912GEV, TPF2-912GV, TPF2-98G, TPF2-98GE, TPF4-610G, TPF4-912G, TPF4-912GE...(Other models you can see in the webshop) | | |
| accessories for | 105749 | | |
|  | Part No. | 105748 | Ref. No. 531034900 |
| | burner lower part for burner cap ø 60mm 4kW | | |
|  | Part No. | 105752 | Ref. No. 531035000 |
| | burner lower part for burner cap ø 80mm 7kW | | |
|  | Part No. | 105755 | Ref. No. 531035100 |
| | burner lower part for burner cap ø 110mm 10kW | | |

| | | | |
|---|---|-----------------|---------------------------|
|  | | | |
| 1 | | | |
| Part No. | 105753 | Ref. No. | 532003900 |
| description | burner cap ø 100mm 10kW | | |
| For models: | CF2-58G, CF2-58GE, CF2-68G, CF2-68GEM, CF3-512GEV, CF3-512GV, CF3-612GEMV, CF3-612GV, CF4-98G, CF4-98GE, CF6-912G, CF6-912GE, CF6-912GEV, CF6-912GV, CF8-916G, CF8-916GE, CF8-916GEV, CF8-916GV, CFM2-68GEM, CFM3-612GEMV, CFV4-98GE, CFV6-912GEV, PC1T-64G, PC2T-68G, PC3-612G, PC3T-612G, PC-912G, PC-916G, PC-94G, PC-98G, PCD-44G, PCT-912G, PCT-916G, PCT-94G, PCT-98G, TP2-912G, TP2-98G, TP2T-912G, TP2T-98G, TP4-912G, TP4T-912G, TPF2-912G, TPF2-912GE, TPF2-912GEV, TPF2-912GV, TPF2-98G, TPF2-98GE, TPF4-912G, TPF4-912GE, TPF4-912GEV...(Other models you can see in the webshop) | | |
| accessories for | 105753 | | |
|  | Part No. | 105749 | Ref. No. 544424100 |
| | air mixer | | |
|  | Part No. | 105754 | Ref. No. 531035400 |
| | burner head for burner cap ø 110mm 10kW | | |
|  | Part No. | 105755 | Ref. No. 531035100 |
| | burner lower part for burner cap ø 110mm 10kW | | |

| | | | |
|---|--|-----------------|---------------------------|
|  | | | |
| 1 | | | |
| Part No. | 105746 | Ref. No. | 532003700 |
| description | burner cap ø 60mm 4kW | | |
| For models: | CF4-98G, CF4-98GE, CF6-912G, CF6-912GE, CF6-912GEV, CF6-912GV, CF8-916G, CF8-916GE, CF8-916GEV, CF8-916GV, CFV4-98GE, CFV6-912GEV, PC-912G, PC-916G, PC-94G, PC-98G, PCT-912G, PCT-916G, PCT-94G, PCT-98G, TP4-912G, TP4T-912G, TPF2-912GE, TPF4-912G, TPF4-912GE, TPF4-912GEV, TPF4-912GV, TPFV4-912GEV | | |
| accessories for | 105746 | | |
|  | Part No. | 105747 | Ref. No. 531035200 |
| | burner head for burner cap ø 60mm 4kW | | |
|  | Part No. | 105748 | Ref. No. 531034900 |
| | burner lower part for burner cap ø 60mm 4kW | | |
|  | Part No. | 105749 | Ref. No. 544424100 |
| | air mixer | | |



| | | | |
|---|---|-----------------|---------------------------|
|  | | | |
| 1 | | | |
| Part No. | 105750 | Ref. No. | 532003800 |
| description | burner cap ø 80mm 7kW | | |
| For models: | CF2-58G, CF2-58GE, CF2-68G, CF2-68GEM, CF3-512GEV, CF3-512GV, CF3-612GEMV, CF3-612GV, CF4-98G, CF4-98GE, CF6-912G, CF6-912GE, CF6-912GEV, CF6-912GV, CF8-916G, CF8-916GE, CF8-916GEV, CF8-916GV, CFM2-68GEM, CFM3-612GEMV, CFV4-98GE, CFV6-912GEV, PC1T-64G, PC2T-68G, PC3-612G, PC3T-612G, PC-912G, PC-916G, PC-94G, PC-98G, PCT-912G, PCT-916G, PCT-94G, PCT-98G, TP2-912G, TP2-98G, TP2T-912G, TP2T-98G, TP4-912G, TP4T-912G, TPF2-912G, TPF2-912GE, TPF2-912GEV, TPF2-912GV, TPF2-98G, TPF2-98GE, TPF4-610G, TPF4-912G, TPF4-912GE, TPF4-912GEV...(Other models you can see in the webshop) | | |
| accessories for | 105750 | | |
|  | Part No. | 105749 | Ref. No. 544424100 |
| air mixer | | | |
|  | Part No. | 105751 | Ref. No. 531035300 |
| burner head for burner cap ø 80mm 7kW | | | |
|  | Part No. | 105752 | Ref. No. 531035000 |
| burner lower part for burner cap ø 80mm 7kW | | | |

| | | | |
|--|--|-----------------|---------------------------|
|  | | | |
| 1 | | | |
| Part No. | 105747 | Ref. No. | 531035200 |
| description | burner head for burner cap ø 60mm 4kW | | |
| For models: | CF4-98G, CF4-98GE, CF6-912G, CF6-912GE, CF6-912GEV, CF6-912GV, CF8-916G, CF8-916GE, CF8-916GEV, CF8-916GV, CFV4-98GE, CFV6-912GEV, PC-912G, PC-916G, PC-94G, PC-98G, PCT-912G, PCT-916G, PCT-94G, PCT-98G, TP4-912G, TP4T-912G, TPF2-912GE, TPF4-912G, TPF4-912GE, TPF4-912GEV, TPF4-912GV, TPFV4-912GEV | | |
| accessories for | 105747 | | |
|  | Part No. | 105746 | Ref. No. 532003700 |
| burner cap ø 60mm 4kW | | | |
|  | Part No. | 105748 | Ref. No. 531034900 |
| burner lower part for burner cap ø 60mm 4kW | | | |
|  | Part No. | 105749 | Ref. No. 544424100 |
| air mixer | | | |

| | | | |
|---|---|-----------------|---------------------------|
|  | | | |
| 1 | | | |
| Part No. | 105754 | Ref. No. | 531035400 |
| description | burner head for burner cap ø 110mm 10kW | | |
| For models: | CF2-58G, CF2-58GE, CF2-68G, CF2-68GEM, CF3-512GEV, CF3-512GV, CF3-612GEMV, CF3-612GV, CF4-98G, CF4-98GE, CF6-912G, CF6-912GE, CF6-912GEV, CF6-912GV, CF8-916G, CF8-916GE, CF8-916GEV, CF8-916GV, CFM2-68GEM, CFM3-612GEMV, CFV4-98GE, CFV6-912GEV, PC1T-64G, PC2T-68G, PC3-612G, PC3T-612G, PC-912G, PC-916G, PC-94G, PC-98G, PCD-44G, PCT-912G, PCT-916G, PCT-94G, PCT-98G, PCW-74G, PCWT-74G, TP2-912G, TP2-98G, TP2T-912G, TP2T-98G, TP4-912G, TP4T-912G, TPF2-912G, TPF2-912GE, TPF2-912GEV, TPF2-912GV, TPF2-98G, TPF2-98GE, TPF4-912G...(Other models you can see in the webshop) | | |
| accessories for | 105754 | | |
|  | Part No. | 105749 | Ref. No. 544424100 |
| air mixer | | | |
|  | Part No. | 105753 | Ref. No. 532003900 |
| burner cap ø 100mm 10kW | | | |
|  | Part No. | 105755 | Ref. No. 531035100 |
| burner lower part for burner cap ø 110mm 10kW | | | |





| | | | |
|---|---|-----------------|---------------------------|
|  | | | |
| 1 | | | |
| Part No. | 105751 | Ref. No. | 531035300 |
| description | burner head for burner cap ø 80mm 7kW | | |
| For models: | CF2-58G, CF2-58GE, CF2-68G, CF2-68GEM, CF3-512GEV, CF3-512GV, CF3-612GEMV, CF3-612GV, CF4-98G, CF4-98GE, CF6-912G, CF6-912GE, CF6-912GEV, CF6-912GV, CF8-916G, CF8-916GE, CF8-916GEV, CF8-916GV, CFM2-68GEM, CFM3-612GEMV, CFV4-98GE, CFV6-912GEV, PC1T-64G, PC2T-68G, PC3-612G, PC3T-612G, PC-912G, PC-916G, PC-94G, PC-98G, PCT-912G, PCT-916G, PCT-94G, PCT-98G, TP2-912G, TP2-98G, TP2T-912G, TP2T-98G, TP4-912G, TP4T-912G, TPF2-912G, TPF2-912GE, TPF2-912GEV, TPF2-912GV, TPF2-98G, TPF2-98GE, TPF4-610G, TPF4-912G, TPF4-912GE, TPF4-912GEV...(Other models you can see in the webshop) | | |
| accessories for | 105751 | | |
|  | Part No. | 105749 | Ref. No. 544424100 |
| air mixer | | | |
|  | Part No. | 105750 | Ref. No. 532003800 |
| burner cap ø 80mm 7kW | | | |
|  | Part No. | 105752 | Ref. No. 531035000 |
| burner lower part for burner cap ø 80mm 7kW | | | |



| | | | |
|---|---|-----------------|---------------------------|
|  | | | |
| Part No. | 105755 | Ref. No. | 531035100 |
| description | burner lower part for burner cap ø 110mm 10kW | | |
| For models: | CF2-58G, CF2-58GE, CF2-68G, CF2-68GEM, CF3-512GEV, CF3-512GV, CF3-612GEMV, CF3-612GV, CF4-98G, CF4-98GE, CF6-912G, CF6-912GE, CF6-912GEV, CF6-912GV, CF8-916G, CF8-916GE, CF8-916GEV, CF8-916GV, CFM2-68GEM, CFM3-612GEMV, CFV4-98GE, CFV6-912GEV, PC1T-64G, PC2T-68G, PC3-612G, PC3T-612G, PC-912G, PC-916G, PC-94G, PC-98G, PCD-44G, PCT-912G, PCT-916G, PCT-94G, PCT-98G, PCW-74G, PCWT-74G, TP2-912G, TP2-98G, TP2T-912G, TP2T-98G, TP4-912G, TP4T-912G, TPF2-912G, TPF2-912GE, TPF2-912GEV, TPF2-912GV, TPF2-98G, TPF2-98GE, TPF4-912G...(Other models you can see in the webshop) | | |
| accessories for | 105755 | | |
|  | Part No. | 105749 | Ref. No. 544424100 |
| | air mixer | | |
|  | Part No. | 105753 | Ref. No. 532003900 |
| | burner cap ø 100mm 10kW | | |
|  | Part No. | 105754 | Ref. No. 531035400 |
| | burner head for burner cap ø 110mm 10kW | | |





| | | | |
|--|---|-----------------|---------------------------|
|  | | | |
| Part No. | 105752 | Ref. No. | 531035000 |
| description | burner lower part for burner cap ø 80mm 7kW | | |
| For models: | CF2-58G, CF2-58GE, CF2-68G, CF2-68GEM, CF3-512GEV, CF3-512GV, CF3-612GEMV, CF3-612GV, CF4-98G, CF4-98GE, CF6-912G, CF6-912GE, CF6-912GEV, CF6-912GV, CF8-916G, CF8-916GE, CF8-916GEV, CF8-916GV, CFM2-68GEM, CFM3-612GEMV, CFV4-98GE, CFV6-912GEV, PC1T-64G, PC2T-68G, PC3-612G, PC3T-612G, PC-912G, PC-916G, PC-94G, PC-98G, PCT-912G, PCT-916G, PCT-94G, PCT-98G, TP2-912G, TP2-98G, TP2T-912G, TP2T-98G, TP4-912G, TP4T-912G, TPF2-912G, TPF2-912GE, TPF2-912GEV, TPF2-912GV, TPF2-98G, TPF2-98GE, TPF4-610G, TPF4-912G, TPF4-912GE, TPF4-912GEV...(Other models you can see in the webshop) | | |
| accessories for | 105752 | | |
|  | Part No. | 105749 | Ref. No. 544424100 |
| | air mixer | | |
|  | Part No. | 105750 | Ref. No. 532003800 |
| | burner cap ø 80mm 7kW | | |
|  | Part No. | 105751 | Ref. No. 531035300 |
| | burner head for burner cap ø 80mm 7kW | | |



| | | | |
|---|--|-----------------|---------------------------|
|  | | | |
| Part No. | 105748 | Ref. No. | 531034900 |
| description | burner lower part for burner cap ø 60mm 4kW | | |
| For models: | CF4-98G, CF4-98GE, CF6-912G, CF6-912GE, CF6-912GEV, CF6-912GV, CF8-916G, CF8-916GE, CF8-916GEV, CF8-916GV, CFV4-98GE, CFV6-912GEV, PC-912G, PC-916G, PC-94G, PC-98G, PCT-912G, PCT-916G, PCT-94G, PCT-98G, TP4-912G, TP4T-912G, TPF2-912GE, TPF4-912G, TPF4-912GE, TPF4-912GEV, TPF4-912GV, TPFV4-912GEV | | |
| accessories for | 105748 | | |
|  | Part No. | 105746 | Ref. No. 532003700 |
| | burner cap ø 60mm 4kW | | |
|  | Part No. | 105747 | Ref. No. 531035200 |
| | burner head for burner cap ø 60mm 4kW | | |
|  | Part No. | 105749 | Ref. No. 544424100 |
| | air mixer | | |

| | | | |
|---|---|-----------------|---------------------------|
| producer-specific hob burners | | | |
| LOTUS | | | |
| 55, 90 series | | | |
|  | | | |
| Part No. | 105749 | Ref. No. | 544424100 |
| description | air mixer | | |
| For models: | CF2-58G, CF2-58GE, CF2-68G, CF2-68GEM, CF3-512GEV, CF3-512GV, CF3-612GEMV, CF3-612GV, CF4-98G, CF4-98GE, CF6-912G, CF6-912GE, CF6-912GEV, CF6-912GV, CF8-916G, CF8-916GE, CF8-916GEV, CF8-916GV, CFM2-68GEM, CFM3-612GEMV, CFV4-98GE, CFV6-912GEV, PC1T-64G, PC2T-68G, PC3-612G, PC3T-612G, PC-912G, PC-916G, PC-94G, PC-98G, PCD-44G, PCT-912G, PCT-916G, PCT-94G, PCT-98G, TP2-912G, TP2-98G, TP2T-912G, TP2T-98G, TP4-912G, TP4T-912G, TPF2-912G, TPF2-912GE, TPF2-912GEV, TPF2-912GV, TPF2-98G, TPF2-98GE, TPF4-610G, TPF4-912G, TPF4-912GE...(Other models you can see in the webshop) | | |
| accessories for | 105749 | | |
|  | Part No. | 105748 | Ref. No. 531034900 |
| | burner lower part for burner cap ø 60mm 4kW | | |
|  | Part No. | 105752 | Ref. No. 531035000 |
| | burner lower part for burner cap ø 80mm 7kW | | |
|  | Part No. | 105755 | Ref. No. 531035100 |
| | burner lower part for burner cap ø 110mm 10kW | | |



| | | | |
|---|---|-----------------|---------------------------|
|  | | | |
| 1 | | | |
| Part No. | 105753 | Ref. No. | 532003900 |
| description | burner cap ø 100mm 10kW | | |
| For models: | CF2-58G, CF2-58GE, CF2-68G, CF2-68GEM, CF3-512GEV, CF3-512GV, CF3-612GEMV, CF3-612GV, CF4-98G, CF4-98GE, CF6-912G, CF6-912GE, CF6-912GEV, CF6-912GV, CF8-916G, CF8-916GE, CF8-916GEV, CF8-916GV, CFM2-68GEM, CFM3-612GEMV, CFV4-98GE, CFV6-912GEV, PC1T-64G, PC2T-68G, PC3-612G, PC3T-612G, PC-912G, PC-916G, PC-94G, PC-98G, PCD-44G, PCT-912G, PCT-916G, PCT-94G, PCT-98G, TP2-912G, TP2-98G, TP2T-912G, TP2T-98G, TP4-912G, TP4T-912G, TPF2-912G, TPF2-912GE, TPF2-912GEV, TPF2-912GV, TPF2-98G, TPF2-98GE, TPF4-912G, TPF4-912GE, TPF4-912GEV...(Other models you can see in the webshop) | | |
| accessories for | 105753 | | |
|  | Part No. | 105749 | Ref. No. 544424100 |
| | air mixer | | |
|  | Part No. | 105754 | Ref. No. 531035400 |
| | burner head for burner cap ø 110mm 10kW | | |
|  | Part No. | 105755 | Ref. No. 531035100 |
| | burner lower part for burner cap ø 110mm 10kW | | |

| | | | |
|---|---|-----------------|---------------------------|
|  | | | |
| 1 | | | |
| Part No. | 105750 | Ref. No. | 532003800 |
| description | burner cap ø 80mm 7kW | | |
| For models: | CF2-58G, CF2-58GE, CF2-68G, CF2-68GEM, CF3-512GEV, CF3-512GV, CF3-612GEMV, CF3-612GV, CF4-98G, CF4-98GE, CF6-912G, CF6-912GE, CF6-912GEV, CF6-912GV, CF8-916G, CF8-916GE, CF8-916GEV, CF8-916GV, CFM2-68GEM, CFM3-612GEMV, CFV4-98GE, CFV6-912GEV, PC1T-64G, PC2T-68G, PC3-612G, PC3T-612G, PC-912G, PC-916G, PC-94G, PC-98G, PCT-912G, PCT-916G, PCT-94G, PCT-98G, TP2-912G, TP2-98G, TP2T-912G, TP2T-98G, TP4-912G, TP4T-912G, TPF2-912G, TPF2-912GE, TPF2-912GEV, TPF2-912GV, TPF2-98G, TPF2-98GE, TPF4-610G, TPF4-912G, TPF4-912GE, TPF4-912GEV...(Other models you can see in the webshop) | | |
| accessories for | 105750 | | |
|  | Part No. | 105749 | Ref. No. 544424100 |
| | air mixer | | |
|  | Part No. | 105751 | Ref. No. 531035300 |
| | burner head for burner cap ø 80mm 7kW | | |
|  | Part No. | 105752 | Ref. No. 531035000 |
| | burner lower part for burner cap ø 80mm 7kW | | |

| | | | |
|---|--|-----------------|---------------------------|
|  | | | |
| 1 | | | |
| Part No. | 105746 | Ref. No. | 532003700 |
| description | burner cap ø 60mm 4kW | | |
| For models: | CF4-98G, CF4-98GE, CF6-912G, CF6-912GE, CF6-912GEV, CF6-912GV, CF8-916G, CF8-916GE, CF8-916GEV, CF8-916GV, CFV4-98GE, CFV6-912GEV, PC-912G, PC-916G, PC-94G, PC-98G, PCT-912G, PCT-916G, PCT-94G, PCT-98G, TP4-912G, TP4T-912G, TPF2-912GE, TPF4-912G, TPF4-912GE, TPF4-912GEV, TPF4-912GV, TPFV4-912GEV | | |
| accessories for | 105746 | | |
|  | Part No. | 105747 | Ref. No. 531035200 |
| | burner head for burner cap ø 60mm 4kW | | |
|  | Part No. | 105748 | Ref. No. 531034900 |
| | burner lower part for burner cap ø 60mm 4kW | | |
|  | Part No. | 105749 | Ref. No. 544424100 |
| | air mixer | | |

| | | | |
|---|---|-----------------|---------------------------|
|  | | | |
| 1 | | | |
| Part No. | 105754 | Ref. No. | 531035400 |
| description | burner head for burner cap ø 110mm 10kW | | |
| For models: | CF2-58G, CF2-58GE, CF2-68G, CF2-68GEM, CF3-512GEV, CF3-512GV, CF3-612GEMV, CF3-612GV, CF4-98G, CF4-98GE, CF6-912G, CF6-912GE, CF6-912GEV, CF6-912GV, CF8-916G, CF8-916GE, CF8-916GEV, CF8-916GV, CFM2-68GEM, CFM3-612GEMV, CFV4-98GE, CFV6-912GEV, PC1T-64G, PC2T-68G, PC3-612G, PC3T-612G, PC-912G, PC-916G, PC-94G, PC-98G, PCD-44G, PCT-912G, PCT-916G, PCT-94G, PCT-98G, PCW-74G, PCWT-74G, TP2-912G, TP2-98G, TP2T-912G, TP2T-98G, TP4-912G, TP4T-912G, TPF2-912G, TPF2-912GE, TPF2-912GEV, TPF2-912GV, TPF2-98G, TPF2-98GE, TPF4-912G...(Other models you can see in the webshop) | | |
| accessories for | 105754 | | |
|  | Part No. | 105749 | Ref. No. 544424100 |
| | air mixer | | |
|  | Part No. | 105753 | Ref. No. 532003900 |
| | burner cap ø 100mm 10kW | | |
|  | Part No. | 105755 | Ref. No. 531035100 |
| | burner lower part for burner cap ø 110mm 10kW | | |



| | | | |
|---|--|-----------------|---------------------------|
|  | | | |
| 1 | | | |
| Part No. | 105747 | Ref. No. | 531035200 |
| description | burner head for burner cap ø 60mm 4kW | | |
| For models: | CF4-98G, CF4-98GE, CF6-912G, CF6-912GE, CF6-912GEV, CF6-912GV, CF8-916G, CF8-916GE, CF8-916GEV, CF8-916GV, CFV4-98GE, CFV6-912GEV, PC-912G, PC-916G, PC-94G, PC-98G, PCT-912G, PCT-916G, PCT-94G, PCT-98G, TP4-912G, TP4T-912G, TPF2-912GE, TPF4-912G, TPF4-912GE, TPF4-912GEV, TPF4-912GV, TPFV4-912GEV | | |
| accessories for | 105747 | | |
|  | Part No. | 105746 | Ref. No. 532003700 |
| | burner cap ø 60mm 4kW | | |
|  | Part No. | 105748 | Ref. No. 531034900 |
| | burner lower part for burner cap ø 60mm 4kW | | |
|  | Part No. | 105749 | Ref. No. 544424100 |
| | air mixer | | |

| | | | |
|---|---|-----------------|---------------------------|
|  | | | |
| 1 | | | |
| Part No. | 105751 | Ref. No. | 531035300 |
| description | burner head for burner cap ø 80mm 7kW | | |
| For models: | CF2-58G, CF2-58GE, CF2-68G, CF2-68GEM, CF3-512GEV, CF3-512GV, CF3-612GEMV, CF3-612GV, CF4-98G, CF4-98GE, CF6-912G, CF6-912GE, CF6-912GEV, CF6-912GV, CF8-916G, CF8-916GE, CF8-916GEV, CF8-916GV, CFM2-68GEM, CFM3-612GEMV, CFV4-98GE, CFV6-912GEV, PC1T-64G, PC2T-68G, PC3-612G, PC3T-612G, PC-912G, PC-916G, PC-94G, PC-98G, PCT-912G, PCT-916G, PCT-94G, PCT-98G, TP2-912G, TP2-98G, TP2T-912G, TP2T-98G, TP4-912G, TP4T-912G, TPF2-912G, TPF2-912GE, TPF2-912GEV, TPF2-912GV, TPF2-98G, TPF2-98GE, TPF4-610G, TPF4-912G, TPF4-912GE, TPF4-912GEV...(Other models you can see in the webshop) | | |
| accessories for | 105751 | | |
|  | Part No. | 105749 | Ref. No. 544424100 |
| | air mixer | | |
|  | Part No. | 105750 | Ref. No. 532003800 |
| | burner cap ø 80mm 7kW | | |
|  | Part No. | 105752 | Ref. No. 531035000 |
| | burner lower part for burner cap ø 80mm 7kW | | |

| | | | |
|--|---|-----------------|---------------------------|
|  | | | |
| 1 | | | |
| Part No. | 105755 | Ref. No. | 531035100 |
| description | burner lower part for burner cap ø 110mm 10kW | | |
| For models: | CF2-58G, CF2-58GE, CF2-68G, CF2-68GEM, CF3-512GEV, CF3-512GV, CF3-612GEMV, CF3-612GV, CF4-98G, CF4-98GE, CF6-912G, CF6-912GE, CF6-912GEV, CF6-912GV, CF8-916G, CF8-916GE, CF8-916GEV, CF8-916GV, CFM2-68GEM, CFM3-612GEMV, CFV4-98GE, CFV6-912GEV, PC1T-64G, PC2T-68G, PC3-612G, PC3T-612G, PC-912G, PC-916G, PC-94G, PC-98G, PCD-44G, PCT-912G, PCT-916G, PCT-94G, PCT-98G, PCW-74G, PCWT-74G, TP2-912G, TP2-98G, TP2T-912G, TP2T-98G, TP4-912G, TP4T-912G, TPF2-912G, TPF2-912GE, TPF2-912GEV, TPF2-912GV, TPF2-98G, TPF2-98GE, TPF4-912G...(Other models you can see in the webshop) | | |
| accessories for | 105755 | | |
|  | Part No. | 105749 | Ref. No. 544424100 |
| | air mixer | | |
|  | Part No. | 105753 | Ref. No. 532003900 |
| | burner cap ø 100mm 10kW | | |
|  | Part No. | 105754 | Ref. No. 531035400 |
| | burner head for burner cap ø 110mm 10kW | | |

| | | | |
|--|---|-----------------|---------------------------|
|  | | | |
| 1 | | | |
| Part No. | 105748 | Ref. No. | 531034900 |
| description | burner lower part for burner cap ø 60mm 4kW | | |
| For models: | CF4-98G, CF4-98GE, CF6-912G, CF6-912GE, CF6-912GEV, CF6-912GV, CF8-916G, CF8-916GE, CF8-916GEV, CF8-916GV, CFV4-98GE, CFV6-912GEV, PC-912G, PC-916G, PC-94G, PC-98G, PCT-912G, PCT-916G, PCT-94G, PCT-98G, TPF4-912G, TPF4-912GE, TPF4-912GEV, TPF4-912GV, TPFV4-912GEV | | |
| accessories for | 105748 | | |
|  | Part No. | 105746 | Ref. No. 532003700 |
| | burner cap ø 60mm 4kW | | |
|  | Part No. | 105747 | Ref. No. 531035200 |
| | burner head for burner cap ø 60mm 4kW | | |
|  | Part No. | 105749 | Ref. No. 544424100 |
| | air mixer | | |



| | | | |
|---|--|-----------------|---------------------------|
|  | | | |
| 1 | | | |
| Part No. | 105752 | Ref. No. | 531035000 |
| description | burner lower part for burner cap ø 80mm 7kW | | |
| For models: | CF2-58G, CF2-58GE, CF2-68G, CF2-68GEM, CF3-512GEV, CF3-512GV, CF3-612GEMV, CF3-612GV, CF4-98G, CF4-98GE, CF6-912G, CF6-912GE, CF6-912GEV, CF6-912GV, CF8-916G, CF8-916GE, CF8-916GEV, CF8-916GV, CFM2-68GEM, CFM3-612GEMV, CFV4-98GE, CFV6-912GEV, PC1T-64G, PC2T-68G, PC3-612G, PC3T-612G, PC-912G, PC-916G, PC-94G, PC-98G, PCT-912G, PCT-916G, PCT-94G, PCT-98G, TP2-912G, TP2-98G, TP2T-912G, TP2T-98G, TP4-912G, TP4T-912G, TPF2-912G, TPF2-912GE, TPF2-912GEV, TPF2-912GV, TPF2-98G, TPF2-98GE, TPF4-610G, TPF4-912G, TPF4-912GE, TPF4-912GEV... (Other models you can see in the webshop) | | |
| accessories for | 105752 | | |
|  | Part No. | 105749 | Ref. No. 544424100 |
| | air mixer | | |
|  | Part No. | 105750 | Ref. No. 532003800 |
| | burner cap ø 80mm 7kW | | |
|  | Part No. | 105751 | Ref. No. 531035300 |
| | burner head for burner cap ø 80mm 7kW | | |

60 (1) series

| | | | |
|---|--|-----------------|-----|
|  | | | |
| 1 | | | |
| Part No. | 106379 | Ref. No. | N/A |
| description | air mixing tube for burner cap ø 80mm L 23mm D1 ø 20mm D2 ø 15.6mm D3 ø 14mm | | |

| | | | |
|---|--|-----------------|---------------------------|
|  | | | |
| 1 | | | |
| Part No. | 103068 | Ref. No. | 532001200 |
| description | burner cap ø 100mm | | |
| For models: | CF-10G6-A, CF-10G-6F, CF-10G-A, CF-10GEM, CF-10GEM-6, CF-10GEM6-A, CF-10GEM-A, CF-10GF, CF-62GEM, CF-62GEM-A, CF-8G-A, CF-8GEM, CF-8GEM-A, CF-8GF, CFM-10GEM, CFM-10GEM-6, CFM-10GEM6-A, CFM-10GEM-A, CFM-8GEM, CFM-8GEM-A, PC-61GF, PC-62GF | | |
| accessories for | 103068 | | |
|  | Part No. | 103067 | Ref. No. 532000900 |
| | burner ring for burner cap ø 100mm | | |
|  | Part No. | 104102 | Ref. No. 532000600 |
| | burner head for burner cap ø 100mm ext. ø 130 | | |
|  | Part No. | 104103 | Ref. No. 532000300 |
| | burner holder suitable for burner ø100mm with nozzle holder | | |

| | | | |
|---|--|-----------------|---------------------------|
|  | | | |
| 1 | | | |
| Part No. | 103066 | Ref. No. | 532001100 |
| description | burner cap ø 80mm | | |
| For models: | CF-10G6-A, CF-10G-6F, CF-10G-A, CF-10GEM, CF-10GEM-6, CF-10GEM6-A, CF-10GEM-A, CF-10GF, CF-62GEM, CF-62GEM-A, CF-8G-A, CF-8GEM, CF-8GEM-A, CF-8GF, CFM-10GEM, CFM-10GEM-6, CFM-10GEM6-A, CFM-10GEM-A, CFM-8GEM, CFM-8GEM-A, PC-61GF, PC-62GF | | |
| accessories for | 103066 | | |
|  | Part No. | 103065 | Ref. No. 532000800 |
| | burner ring for burner cap ø 80mm | | |
|  | Part No. | 104100 | Ref. No. 532000500 |
| | burner head for burner cap ø 80mm | | |
|  | Part No. | 104101 | Ref. No. 532000200 |
| | burner holder for burner cap ø 80mm with nozzle holder with mixing sleeve | | |



| | | | |
|--|--|-----------------|-----------|
|  | | | |
| 1 | | | |
| Part No. | 104102 | Ref. No. | 532000600 |
| description | burner head for burner cap ø 100mm ext. ø 130 | | |
| For models: | CF-10G6-A, CF-10G-6F, CF-10G-A, CF-10GEM, CF-10GEM-6, CF-10GEM6-A, CF-10GEM-A, CF-10GF, CF-62GEM, CF-62GEM-A, CF-8G-A, CF-8GEM, CF-8GEM-A, CF-8GF, CFM-10GEM, CFM-10GEM-6, CFM-10GEM6-A, CFM-10GEM-A, CFM-8GEM, CFM-8GEM-A, PC-61GF, PC-62GF | | |

| | | | |
|--|--|-----------------|---------------------------|
|  | | | |
| 1 | | | |
| Part No. | 104100 | Ref. No. | 532000500 |
| description | burner head for burner cap ø 80mm | | |
| For models: | CF-10G6-A, CF-10G-6F, CF-10G-A, CF-10GEM, CF-10GEM-6, CF-10GEM6-A, CF-10GEM-A, CF-10GF, CF-62GEM, CF-62GEM-A, CF-8G-A, CF-8GEM, CF-8GEM-A, CF-8GF, CFM-10GEM, CFM-10GEM-6, CFM-10GEM6-A, CFM-10GEM-A, CFM-8GEM, CFM-8GEM-A, PC-61GF, PC-62GF | | |
| accessories for | 104100 | | |
|  | Part No. | 103065 | Ref. No. 532000800 |
| | burner ring for burner cap ø 80mm | | |
|  | Part No. | 103066 | Ref. No. 532001100 |
| | burner cap ø 80mm | | |
|  | Part No. | 104103 | Ref. No. 532000300 |
| | burner holder suitable for burner ø100mm with nozzle holder | | |



| | | | |
|---|--|-----------------|---------------------------|
|  | | | |
| 1 | | | |
| Part No. | 104101 | Ref. No. | 532000200 |
| description | burner holder for burner cap ø 80mm with nozzle holder with mixing sleeve | | |
| For models: | CF-10G6-A, CF-10G-6F, CF-10G-A, CF-10GEM, CF-10GEM-6, CF-10GEM6-A, CF-10GEM-A, CF-10GF, CF-62GEM, CF-62GEM-A, CF-8G-A, CF-8GEM, CF-8GEM-A, CF-8GF, CFM-10GEM, CFM-10GEM-6, CFM-10GEM6-A, CFM-10GEM-A, CFM-8GEM, CFM-8GEM-A, PC-61GF, PC-62GF | | |
| accessories for | 104101 | | |
|  | Part No. | 103065 | Ref. No. 532000800 |
| | burner ring for burner cap ø 80mm | | |
|  | Part No. | 103066 | Ref. No. 532001100 |
| | burner cap ø 80mm | | |
|  | Part No. | 104100 | Ref. No. 532000500 |
| | burner head for burner cap ø 80mm | | |

| | | | |
|---|--|-----------------|---------------------------|
|  | | | |
| 1 | | | |
| Part No. | 104103 | Ref. No. | 532000300 |
| description | burner holder suitable for burner ø100mm with nozzle holder | | |
| For models: | CF-10G6-A, CF-10G-6F, CF-10G-A, CF-10GEM, CF-10GEM-6, CF-10GEM6-A, CF-10GEM-A, CF-10GF, CF-62GEM, CF-62GEM-A, CF-8G-A, CF-8GEM, CF-8GEM-A, CF-8GF, CFM-10GEM, CFM-10GEM-6, CFM-10GEM6-A, CFM-10GEM-A, CFM-8GEM, CFM-8GEM-A, PC-61GF, PC-62GF | | |
| accessories for | 104103 | | |
|  | Part No. | 103067 | Ref. No. 532000900 |
| | burner ring for burner cap ø 100mm | | |
|  | Part No. | 103068 | Ref. No. 532001200 |
| | burner cap ø 100mm | | |
|  | Part No. | 104102 | Ref. No. 532000600 |
| | burner head for burner cap ø 100mm ext. ø 130 | | |

| | | | |
|---|--|-----------------|---------------------------|
|  | | | |
| 1 | | | |
| Part No. | 103067 | Ref. No. | 532000900 |
| description | burner ring for burner cap ø 100mm | | |
| For models: | CF-10G6-A, CF-10G-6F, CF-10G-A, CF-10GEM, CF-10GEM-6, CF-10GEM6-A, CF-10GEM-A, CF-10GF, CF-62GEM, CF-62GEM-A, CF-8G-A, CF-8GEM, CF-8GEM-A, CF-8GF, CFM-10GEM, CFM-10GEM-6, CFM-10GEM6-A, CFM-10GEM-A, CFM-8GEM, CFM-8GEM-A, PC-61GF, PC-62GF | | |
| accessories for | 103067 | | |
|  | Part No. | 103068 | Ref. No. 532001200 |
| | burner cap ø 100mm | | |
|  | Part No. | 104102 | Ref. No. 532000600 |
| | burner head for burner cap ø 100mm ext. ø 130 | | |

| | | | |
|---|---|--------|---------------------------|
| accessories for | 103067 | | |
|  | Part No. | 104103 | Ref. No. 532000300 |
| | burner holder suitable for burner ø100mm with nozzle holder | | |



| | | | |
|---|--|-----------------|---------------------------|
|  | | | |
| 1 | | | |
| Part No. | 103065 | Ref. No. | 532000800 |
| description | burner ring for burner cap ø 80mm | | |
| For models: | CF-10G6-A, CF-10G-6F, CF-10G-A, CF-10GEM, CF-10GEM-6, CF-10GEM6-A, CF-10GEM-A, CF-10GF, CF-62GEM, CF-62GEM-A, CF-8G-A, CF-8GEM, CF-8GEM-A, CF-8GF, CFM-10GEM, CFM-10GEM-6, CFM-10GEM6-A, CFM-10GEM-A, CFM-8GEM, CFM-8GEM-A, PC-61GF, PC-62GF | | |
| accessories for | 103065 | | |
|  | Part No. | 103066 | Ref. No. 532001100 |
| | burner cap ø 80mm | | |
|  | Part No. | 104100 | Ref. No. 532000500 |
| | burner head for burner cap ø 80mm | | |
|  | Part No. | 104101 | Ref. No. 532000200 |
| | burner holder for burner cap ø 80mm with nozzle holder with mixing sleeve | | |





60 (2) series

| | | | |
|---|--|-----------------|---------------------------|
|  | | | |
| 1 | | | |
| Part No. | 105742 | Ref. No. | 532003600 |
| description | burner cap 4.5kW ø 128mm mounting pos. outer bright finish | | |
| For models: | CF-10G6-A, CF-10G-6F, CF-10G-A, CF-10GEM, CF-10GEM-6, CF-10GEM6-A, CF-10GEM-A, CF-10GF, CF-62GEM, CF-62GEM-A, CF-8G-A, CF-8GEM, CF-8GEM-A, CF-8GF, CFM-10GEM, CFM-10GEM-6, CFM-10GEM6-A, CFM-10GEM-A, CFM-8GEM, CFM-8GEM-A, PC-61GF, PC-62GF | | |
| accessories for | 105742 | | |
|  | Part No. | 105740 | Ref. No. 532003500 |
| | burner cap 4.5kW ø 48mm mounting pos. inner bright finish | | |
|  | Part No. | 105741 | Ref. No. 532003200 |
| | burner head 4.5kW mounting pos. inner for burner cap ø 55mm | | |
|  | Part No. | 105743 | Ref. No. 532003300 |
| | burner head 4.5kW mounting pos. outer for burner cap ø 128mm | | |
|  | Part No. | 105745 | Ref. No. 532003000 |
| | burner lower part 4.5kW | | |



| | | | |
|---|--|-----------------|---------------------------|
|  | | | |
| 1 | | | |
| Part No. | 105740 | Ref. No. | 532003500 |
| description | burner cap 4.5kW ø 48mm mounting pos. inner bright finish | | |
| For models: | CF-10G6-A, CF-10G-6F, CF-10G-A, CF-10GEM, CF-10GEM-6, CF-10GEM6-A, CF-10GEM-A, CF-10GF, CF-62GEM, CF-62GEM-A, CF-8G-A, CF-8GEM, CF-8GEM-A, CF-8GF, CFM-10GEM, CFM-10GEM-6, CFM-10GEM6-A, CFM-10GEM-A, CFM-8GEM, CFM-8GEM-A, PC-61GF, PC-62GF | | |
| accessories for | 105740 | | |
|  | Part No. | 105741 | Ref. No. 532003200 |
| | burner head 4.5kW mounting pos. inner for burner cap ø 55mm | | |
|  | Part No. | 105742 | Ref. No. 532003600 |
| | burner cap 4.5kW ø 128mm mounting pos. outer bright finish | | |
|  | Part No. | 105743 | Ref. No. 532003300 |
| | burner head 4.5kW mounting pos. outer for burner cap ø 128mm | | |
|  | Part No. | 105745 | Ref. No. 532003000 |
| | burner lower part 4.5kW | | |

| | | | |
|---|--|-----------------|--|
|  | | | |
| 1 | | | |
| Part No. | 105738 | Ref. No. | 532003400 |
| description | burner cap ø 100mm | | |
| For models: | CF-10G6-A, CF-10G-6F, CF-10G-A, CF-10GEM, CF-10GEM-6, CF-10GEM6-A, CF-10GEM-A, CF-10GF, CF-62GEM, CF-62GEM-A, CF-8G-A, CF-8GEM, CF-8GEM-A, CF-8GF, CFM-10GEM, CFM-10GEM-6, CFM-10GEM6-A, CFM-10GEM-A, CFM-8GEM, CFM-8GEM-A, PC-61GF, PC-62GF | | |
| accessories for | 105738 | | |
|  | Part No. | 105739 | Ref. No. 532003100 |
| | burner head ø 110mm seat ø 90mm | | |
|  | Part No. | 105744 | Ref. No. 532002900 532002901 |
| | burner lower part for burner cap ø 100mm | | |

| | | | |
|---|--|-----------------|---------------------------|
|  | | | |
| 1 | | | |
| Part No. | 105741 | Ref. No. | 532003200 |
| description | burner head 4.5kW mounting pos. inner for burner cap ø 55mm | | |
| For models: | CF-10G6-A, CF-10G-6F, CF-10G-A, CF-10GEM, CF-10GEM-6, CF-10GEM6-A, CF-10GEM-A, CF-10GF, CF-62GEM, CF-62GEM-A, CF-8G-A, CF-8GEM, CF-8GEM-A, CF-8GF, CFM-10GEM, CFM-10GEM-6, CFM-10GEM6-A, CFM-10GEM-A, CFM-8GEM, CFM-8GEM-A, PC-61GF, PC-62GF | | |
| accessories for | 105741 | | |
|  | Part No. | 105740 | Ref. No. 532003500 |
| | burner cap 4.5kW ø 48mm mounting pos. inner bright finish | | |
|  | Part No. | 105742 | Ref. No. 532003600 |
| | burner cap 4.5kW ø 128mm mounting pos. outer bright finish | | |
|  | Part No. | 105743 | Ref. No. 532003300 |
| | burner head 4.5kW mounting pos. outer for burner cap ø 128mm | | |



| | | | |
|---|-------------------------|--------|---------------------------|
| accessories for | 105741 | | |
|  | Part No. | 105745 | Ref. No. 532003000 |
| | burner lower part 4.5kW | | |



| | | | |
|--|--|-----------------|---------------------------|
|  | | | |
| 1 | | | |
| Part No. | 105743 | Ref. No. | 532003300 |
| description | burner head 4.5kW mounting pos. outer for burner cap ø 128mm | | |
| For models: | CF-10G6-A, CF-10G-6F, CF-10G-A, CF-10GEM, CF-10GEM-6, CF-10GEM6-A, CF-10GEM-A, CF-10GF, CF-62GEM, CF-62GEM-A, CF-8G-A, CF-8GEM, CF-8GEM-A, CF-8GF, CFM-10GEM, CFM-10GEM-6, CFM-10GEM6-A, CFM-10GEM-A, CFM-8GEM, CFM-8GEM-A, PC-61GF, PC-62GF | | |
| accessories for | 105743 | | |
|  | Part No. | 105740 | Ref. No. 532003500 |
| | burner cap 4.5kW ø 48mm mounting pos. inner bright finish | | |
|  | Part No. | 105741 | Ref. No. 532003200 |
| | burner head 4.5kW mounting pos. inner for burner cap ø 55mm | | |
|  | Part No. | 105742 | Ref. No. 532003600 |
| | burner cap 4.5kW ø 128mm mounting pos. outer bright finish | | |
|  | Part No. | 105745 | Ref. No. 532003000 |
| | burner lower part 4.5kW | | |



| | | | |
|--|--|-----------------|--|
|  | | | |
| 1 | | | |
| Part No. | 105739 | Ref. No. | 532003100 |
| description | burner head ø 110mm seat ø 90mm | | |
| For models: | CF-10G6-A, CF-10G-6F, CF-10G-A, CF-10GEM, CF-10GEM-6, CF-10GEM6-A, CF-10GEM-A, CF-10GF, CF-62GEM, CF-62GEM-A, CF-8G-A, CF-8GEM, CF-8GEM-A, CF-8GF, CFM-10GEM, CFM-10GEM-6, CFM-10GEM6-A, CFM-10GEM-A, CFM-8GEM, CFM-8GEM-A, PC-61GF, PC-62GF | | |
| accessories for | 105739 | | |
|  | Part No. | 105738 | Ref. No. 532003400 |
| | burner cap ø 100mm | | |
|  | Part No. | 105744 | Ref. No. 532002900 532002901 |
| | burner lower part for burner cap ø 100mm | | |







| | | | |
|---|--|-----------------|---------------------------|
|  | | | |
| 1 | | | |
| Part No. | 105745 | Ref. No. | 532003000 |
| description | burner lower part 4.5kW | | |
| For models: | CF-10G6-A, CF-10G-6F, CF-10G-A, CF-10GEM, CF-10GEM-6, CF-10GEM6-A, CF-10GEM-A, CF-10GF, CF-62GEM, CF-62GEM-A, CF-8G-A, CF-8GEM, CF-8GEM-A, CF-8GF, CFM-10GEM, CFM-10GEM-6, CFM-10GEM6-A, CFM-10GEM-A, CFM-8GEM, CFM-8GEM-A, PC-61GF, PC-62GF | | |
| accessories for | 105745 | | |
|  | Part No. | 105740 | Ref. No. 532003500 |
| | burner cap 4.5kW ø 48mm mounting pos. inner bright finish | | |
|  | Part No. | 105741 | Ref. No. 532003200 |
| | burner head 4.5kW mounting pos. inner for burner cap ø 55mm | | |
|  | Part No. | 105742 | Ref. No. 532003600 |
| | burner cap 4.5kW ø 128mm mounting pos. outer bright finish | | |
|  | Part No. | 105743 | Ref. No. 532003300 |
| | burner head 4.5kW mounting pos. outer for burner cap ø 128mm | | |

| | | | |
|---|--|-----------------|---------------------------|
|  | | | |
| 1 | | | |
| Part No. | 105744 | Ref. No. | 532002900 532002901 |
| description | burner lower part for burner cap ø 100mm | | |
| For models: | CF-10G6-A, CF-10G-6F, CF-10G-A, CF-10GEM, CF-10GEM-6, CF-10GEM6-A, CF-10GEM-A, CF-10GF, CF-62GEM, CF-62GEM-A, CF-8G-A, CF-8GEM, CF-8GEM-A, CF-8GF, CFM-10GEM, CFM-10GEM-6, CFM-10GEM6-A, CFM-10GEM-A, CFM-8GEM, CFM-8GEM-A, PC-61GF, PC-62GF | | |
| accessories for | 105744 | | |
|  | Part No. | 105738 | Ref. No. 532003400 |
| | burner cap ø 100mm | | |
|  | Part No. | 105739 | Ref. No. 532003100 |
| | burner head ø 110mm seat ø 90mm | | |

| | | | |
|---|---|-----------------|---------------------------|
| 65, 70 series | | | |
|  | | | |
| 1 | | | |
| Part No. | 105043 | Ref. No. | 533053000 |
| description | air mixing tube ø 18mm L 38mm | | |
| For models: | BRF-64G, BRF-74G, BRF-94G, CF4-68G, CF4-68GEM, CF4-78G, CF4-78GE, CF4-78GP, CF4-78GP-AUS, CF4-78GP-USA, CF4-8G, CF4-8GEM, CF4-98G, CF4-GEMS, CF6-610G, CF6-610GEM, CF6-712G, CF6-712GEV, CF6-712GPV, CF6-712GPV-USA, CF6-712GV, CF6-912GV, CF-712GE, CF8-916G, CFA4-78G, CFA4-98G, CFA6-712GV, CFA6-912GV, CFM4-66GEM, CFM4-68GEM, CFM6-610GEM, CFPB6-79G, FO-1G, FO-2G, FO-3G, FOS-1G, FOS-2G, FOS-3G, PAF-78G, PAF-98G, PC-12G, PC-4G, PC-712G, PC-716G, PC-74G, PC-78G, PC-8G, PCT-63G, PCT-66G, TP2-712G... (Other models you can see in the webshop) | | |
| accessories for | 105043 | | |
|  | Part No. | 105415 | Ref. No. 532001300 |
| | venturi for burner cap ø 82mm 3.5kW | | |

| | | | |
|---|---|-----------------|---------------------------|
|  | | | |
| 1 | | | |
| Part No. | 105044 | Ref. No. | 533053100 |
| description | air mixing tube ø 20mm L 38mm | | |
| For models: | BRF-78G, CF4-68G, CF4-68GEM, CF4-78G, CF4-78GE, CF4-8G, CF4-8GEM, CF4-GEMS, CF6-610G, CF6-610GEM, CF6-712G, CF6-712GEV, CF6-712GP, CF6-712GV, CF-712GE, CFM4-66GEM, CFM4-68GEM, CFM6-610GEM, F18-94G, F2-18-98G, F2-25-98G, F25-94G, F45-78G, FO-1G, FO-2G, FO-3G, FOS-1G, FOS-2G, FOS-3G, PC-12G, PC-4G, PC-712G, PC-716G, PC-74G, PC-78G, PC-8G, PCT-63G, PCT-66G, TP2-712G, TP4T-610G, TPF2-712G, TPF2-712GV, TPF4-610G, TPF4-610GEM, TPF4-712GP | | |
| accessories for | 105044 | | |
|  | Part No. | 105418 | Ref. No. 532001400 |
| | venturi for burner cap ø 102mm 5.5kW | | |

| | | | |
|---|---|-----------------|---------------------------|
|  | | | |
| 1 | | | |
| Part No. | 105413 | Ref. No. | 532001700 |
| description | burner cap 3.5kW ø 82mm | | |
| accessories for | 105413 | | |
|  | Part No. | 105043 | Ref. No. 533053000 |
| | air mixing tube ø 18mm L 38mm | | |
|  | Part No. | 105414 | Ref. No. 532001500 |
| | burner head for burner cap ø 82mm 3.5kW without pin | | |
|  | Part No. | 105415 | Ref. No. 532001300 |
| | venturi for burner cap ø 82mm 3.5kW | | |

| | | | |
|---|---|-----------------|-----------|
|  | | | |
| 1 | | | |
| Part No. | 106977 | Ref. No. | 532006400 |
| description | burner cap 3.5kW ø 82mm with notch | | |
| For models: | CF4-68G, CF4-68GEM, CF4-8G, CF4-8GEM, CF4-GEMS, CF6-610G, CF6-610GEM, CFM4-66GEM, CFM4-68GEM, CFM6-610GEM, FO-1G, FO-2G, FO-3G, FOS-1G, FOS-2G, FOS-3G, PC-12G, PC-4G, PC-8G, PCT-63G, PCT-66G, TP4T-610G, TPF4-610G, TPF4-610GEM | | |









| | | | |
|---|--|-----------------|---------------------------|
|  | | | |
| 1 | | | |
| Part No. | 105416 | Ref. No. | 532001800 |
| description | burner cap 5.5kW ø 102mm with central hole | | |
| For models: | CF4-78G, CF4-78GE, CF4-8G, CF4-8GEM, CF4-GEMS, CF6-610G, CF6-610GEM, CF6-712GEV, CF6-712GV, CF-712GE, FO-1G, FO-2G, FO-3G, FOS-1G, FOS-2G, FOS-3G, PC-12G, PC-4G, PC-712G, PC-716G, PC-74G, PC-78G, PC-8G, TP2-712G, TPF2-712G, TPF2-712GV | | |
| accessories for | 105416 | | |
|  | Part No. | 105044 | Ref. No. 533053100 |
| | air mixing tube ø 20mm L 38mm | | |
|  | Part No. | 105417 | Ref. No. 532001600 |
| | burner head for burner cap ø 102mm 5.5kW without pin | | |

Table continues overleaf



| | | | |
|---|--------------------------------------|--------|---------------------------|
| accessories for | 105416 | | |
|  | Part No. | 105418 | Ref. No. 532001400 |
| | venturi for burner cap ø 102mm 5.5kW | | |

| | | | |
|---|---|-----------------|---------------------------|
|  | 1 | | |
| Part No. | 106752 | Ref. No. | 532006500 |
| description | burner cap 5.5kW ø 102mm with notch | | |
| For models: | CF4-68G, CF4-68GEM, CF4-8G, CF4-8GEM, CF4-GEMS, CF6-610G, CF6-610GEM, CFM4-66GEM, CFM4-68GEM, CFM6-610GEM, FO-1G, FO-2G, FO-3G, FOS-1G, FOS-2G, FOS-3G, PC-12G, PC-4G, PC-8G, PCT-63G, PCT-66G, TP4T-610G, TPF4-610G, TPF4-610GEM | | |
| accessories for | 106752 | | |
|  | Part No. | 106753 | Ref. No. 532006700 |
| | burner head for burner cap ø 102mm 5.5kW with roll pin | | |

| | | | |
|---|---|-----------------|---------------------------|
|  | 1 | | |
| Part No. | 106753 | Ref. No. | 532006700 |
| description | burner head for burner cap ø 102mm 5.5kW with roll pin | | |
| For models: | CF4-68G, CF4-68GEM, CF4-8G, CF4-8GEM, CF4-GEMS, CF6-610G, CF6-610GEM, CFM4-66GEM, CFM4-68GEM, CFM6-610GEM, FO-1G, FO-2G, FO-3G, FOS-1G, FOS-2G, FOS-3G, PC-12G, PC-4G, PC-8G, PCT-63G, PCT-66G, TP4T-610G, TPF4-610G, TPF4-610GEM | | |
| accessories for | 106753 | | |
|  | Part No. | 106752 | Ref. No. 532006500 |
| | burner cap 5.5kW ø 102mm with notch | | |

| | | | |
|---|--|-----------------|---------------------------|
|  | 1 | | |
| Part No. | 105417 | Ref. No. | 532001600 |
| description | burner head for burner cap ø 102mm 5.5kW without pin | | |
| For models: | CF4-78G, CF4-78GE, CF4-8G, CF4-8GEM, CF6-712G, CF6-712GEV, CF6-712GV, CF-712GE, FO-1G, FO-2G, FO-3G, PC-4G, PC-712G, PC-716G, PC-74G, PC-78G, PC-8G, TP2-712G, TPF2-712G, TPF2-712GV | | |
| accessories for | 105417 | | |
|  | Part No. | 105044 | Ref. No. 533053100 |
| | air mixing tube ø 20mm L 38mm | | |
|  | Part No. | 105416 | Ref. No. 532001800 |
| | burner cap 5.5kW ø 102mm with central hole | | |
|  | Part No. | 105418 | Ref. No. 532001400 |
| | venturi for burner cap ø 102mm 5.5kW | | |

| | | | |
|--|---|-----------------|-----------|
|  | 1 | | |
| Part No. | 106976 | Ref. No. | 532006600 |
| description | burner head for burner cap ø 82mm 3.5kW with roll pin | | |
| For models: | CF4-68G, CF4-68GEM, CF4-8G, CF4-8GEM, CF4-GEMS, CF6-610G, CF6-610GEM, CFM4-66GEM, CFM4-68GEM, CFM6-610GEM, FO-1G, FO-2G, FO-3G, FOS-1G, FOS-2G, FOS-3G, PC-12G, PC-4G, PC-8G, PCT-63G, PCT-66G, TP4T-610G, TPF4-610G, TPF4-610GEM | | |

| | | | |
|---|--|-----------------|---------------------------|
|  | 1 | | |
| Part No. | 105414 | Ref. No. | 532001500 |
| description | burner head for burner cap ø 82mm 3.5kW without pin | | |
| For models: | CF4-78G, CF4-78GE, CF4-8G, CF4-8GEM, CF6-712G, CF6-712GEV, CF6-712GV, CF-712GE, FO-1G, FO-2G, FO-3G, PC-4G, PC-712G, PC-716G, PC-74G, PC-78G, PC-8G, TP2-712G, TPF2-712G, TPF2-712GV | | |
| accessories for | 105414 | | |
|  | Part No. | 105043 | Ref. No. 533053000 |
| | air mixing tube ø 18mm L 38mm | | |
|  | Part No. | 105413 | Ref. No. 532001700 |
| | burner cap 3.5kW ø 82mm | | |
|  | Part No. | 105415 | Ref. No. 532001300 |
| | venturi for burner cap ø 82mm 3.5kW | | |

| | | | |
|--|--|-----------------|---------------------------|
|  | 1 | | |
| Part No. | 105418 | Ref. No. | 532001400 |
| description | venturi for burner cap ø 102mm 5.5kW | | |
| For models: | CF4-68G, CF4-68GEM, CF4-78G, CF4-78GE, CF4-8G, CF4-8GEM, CF4-GEMS, CF6-610G, CF6-610GEM, CF6-712G, CF6-712GEV, CF6-712GV, CF-712GE, CFM4-66GEM, CFM4-68GEM, CFM6-610GEM, FO-1G, FO-2G, FO-3G, FOS-1G, FOS-2G, FOS-3G, PC-12G, PC-4G, PC-712G, PC-716G, PC-74G, PC-78G, PC-8G, PCT-63G, PCT-66G, TP2-712G, TP4T-610G, TPF2-712G, TPF2-712GV, TPF4-610G, TPF4-610GEM | | |
| accessories for | 105418 | | |
|  | Part No. | 105044 | Ref. No. 533053100 |
| | air mixing tube ø 20mm L 38mm | | |
|  | Part No. | 105416 | Ref. No. 532001800 |
| | burner cap 5.5kW ø 102mm with central hole | | |
|  | Part No. | 105417 | Ref. No. 532001600 |
| | burner head for burner cap ø 102mm 5.5kW without pin | | |



| | | | |
|---|--|-----------------|---------------------------|
|  | | | |
| 1 | | | |
| Part No. | 105415 | Ref. No. | 532001300 |
| description | venturi for burner cap ø 82mm 3.5kW | | |
| For models: | CF4-68G, CF4-68GEM, CF4-78G, CF4-78GE, CF4-8G, CF4-8GEM, CF4-GEMS, CF6-610G, CF6-610GEM, CF6-712G, CF6-712GEV, CF6-712GV, CF-712GE, CFM4-66GEM, CFM4-68GEM, CFM6-610GEM, FO-1G, FO-2G, FO-3G, FOS-1G, FOS-2G, FOS-3G, PC-12G, PC-4G, PC-712G, PC-716G, PC-74G, PC-78G, PC-8G, PCT-63G, PCT-66G, TP2-712G, TP4T-610G, TPF2-712G, TPF2-712GV, TPF4-610G, TPF4-610GEM | | |
| accessories for | 105415 | | |
|  | Part No. | 105043 | Ref. No. 533053000 |
| | air mixing tube ø 18mm L 38mm | | |
|  | Part No. | 105413 | Ref. No. 532001700 |
| | burner cap 3.5kW ø 82mm | | |
|  | Part No. | 105414 | Ref. No. 532001500 |
| | burner head for burner cap ø 82mm 3.5kW without pin | | |

stockpot stoves

| | | | |
|--|----------------------------|-----------------|------------------------|
|  | | | |
| 1 | | | |
| Part No. | 105410 | Ref. No. | 532002600 532002601 |
| description | round burner ø 190mm 9.5kW | | |
| For models: | F-1G, FB-1G | | |

pan supports

| | | | |
|---|--|-----------------|-----------|
|  | | | |
| 1 | | | |
| Part No. | 210032 | Ref. No. | 532005901 |
| description | pan support W 270mm L 340mm H 47mm | | |
| For models: | CF4-8G, CF4-8GEM, CF4-GEMS, PC-12G, PC-4G, PC-8G | | |

| | | | |
|--|---|-----------------|-----------|
|  | | | |
| 1 | | | |
| Part No. | 210172 | Ref. No. | 532002300 |
| description | pan support W 275mm L 345mm | | |
| For models: | CF4-78G, CF4-78GE, CF4-8G, CF4-8GEM, CF4-GEMS, CF6-712G, CF6-712GEV, CF6-712GV, CF-712GE, PC-12G, PC-4G, PC-712G, PC-716G, PC-74G, PC-78G, PC-8G, TP2-712G, TPF2-712G, TPF2-712GV | | |

| | | | |
|--|---|-----------------|-----------|
|  | | | |
| 1 | | | |
| Part No. | 210117 | Ref. No. | 532002200 |
| description | pan support W 290mm L 475mm | | |
| For models: | CF-10G-A, CF-10GEM, CF-10GEM-A, CF-10GF, CFM-10GEM, CFM-10GEM-A | | |

| | | | |
|---|---|-----------------|-----------|
|  | | | |
| 1 | | | |
| Part No. | 210216 | Ref. No. | 532002101 |
| description | pan support W 290mm L 505mm | | |
| For models: | CF-10G6-A, CF-10G6F, CF-10G-A, CF-10GEM, CF-10GEM-6, CF-10GEM6-A, CF-10GEM-A, CF-10GF, CF-62GEM, CF-62GEM-A, CF-8G-A, CF-8GEM, CF-8GEM-A, CF-8GF, CFM-10GEM, CFM-10GEM-6, CFM-10GEM6-A, CFM-10GEM-A, CFM-8GEM, CFM-8GEM-A, PC-61GF, PC-62GF | | |

| | | | |
|--|---|-----------------|-----------|
|  | | | |
| 1 | | | |
| Part No. | 210217 | Ref. No. | 532002201 |
| description | pan support W 290mm L 505mm | | |
| For models: | CF-10G-A, CF-10GEM, CF-10GEM-A, CF-10GF, CFM-10GEM, CFM-10GEM-A | | |





| | | | |
|---|---|-----------------|-----------|
|  | | | |
| 1 | | | |
| Part No. | 210167 | Ref. No. | 532002400 |
| description | pan support W 346mm L 372mm | | |
| For models: | FO-1G, FO-2G, FO-3G, FOS-1G, FOS-2G, FOS-3G | | |

| | | | |
|---|---|-----------------|-----------|
|  | | | |
| 1 | | | |
| Part No. | 210218 | Ref. No. | 532004000 |
| description | pan support W 365mm L 395mm | | |
| For models: | CF2-58G, CF2-58GE, CF2-68G, CF2-68GEM, CF3-512GEV, CF3-512GV, CF3-612GEMV, CF3-612GV, CF4-98G, CF4-98GE, CF6-912G, CF6-912GE, CF6-912GEV, CF6-912GV, CF8-916G, CF8-916GE, CF8-916GEV, CF8-916GV, CFM2-68GEM, CFM3-612GEMV, CFV4-98GE, CFV6-912GEV, PC1T-64G, PC2T-68G, PC3-612G, PC3T-612G, PC-912G, PC-916G, PC-94G, PC-98G, PCD-44G, PCT-912G, PCT-916G, PCT-94G, PCT-98G, PCW-74G, PCWT-74G, TP2-912G, TP2-98G, TP2T-912G, TP2T-98G, TP4-912G, TP4T-912G, TPF2-912G, TPF2-912GE, TPF2-912GEV, TPF2-912GV, TPF2-98G, TPF2-98GE, TPF2-98GEV, TPF4-610G...(Other models you can see in the webshop) | | |

reducers for pan supports

| | | | |
|---|--|-----------------|-----------|
|  | | | |
| 1 | | | |
| Part No. | 210050 | Ref. No. | 533009200 |
| description | reducer for pan support L 260mm W 260mm chrome-plated steel suitable for universal | | |
| For models: | CF2-58G, CF2-58GE, CF2-68G, CF2-68GEM, CF3-512GEV, CF3-512GV, CF3-612GEMV, CF3-612GV, CF4-78G, CF4-78GE, CF4-8G, CF4-8GEM, CF4-98G, CF4-98GE, CF4-GEMS, CF6-712G, CF6-712GEV, CF6-712GV, CF6-912G, CF6-912GE, CF6-912GEV, CF6-912GV, CF-712GE, CF8-916G, CF8-916GE, CF8-916GEV, CF8-916GV, CFM2-68GEM, CFM3-612GEMV, CFV4-98GE, CFV6-912GEV, FO-1G, FO-2G, FO-3G, FOS-1G, FOS-2G, FOS-3G, PC-12G, PC1T-64G, PC2T-68G, PC3-612G, PC3T-612G, PC-4G, PC-712G, PC-716G, PC-74G, PC-78G, PC-8G, PC-912G, PC-916G... (Other models you can see in the webshop) | | |

| | | | |
|---|---|-----------------|-----------|
|  | | | |
| 1 | | | |
| Part No. | 210001 | Ref. No. | 533009200 |
| description | reducer for pan support L 265mm W 265mm SS suitable for universal | | |

| | | | |
|--|--|-----------------|-----------|
|  | | | |
| 1 | | | |
| Part No. | 210018 | Ref. No. | 533009100 |
| description | reducer for pan support ø 160mm | | |
| For models: | CF-10G6-A, CF-10G-6F, CF-10G-A, CF-10GEM, CF-10GEM-6, CF-10GEM6-A, CF-10GEM-A, CF-10GF, CF-62GEM, CF-62GEM-A, CF-8G-A, CF-8GEM, CF-8GEM-A, CF-8GF, CFM-10GEM, CFM-10GEM-6, CFM-10GEM6-A, CFM-10GEM-A, CFM-8GEM, CFM-8GEM-A | | |

spillage trays

| | | | |
|--|---|-----------------|-----------|
|  | | | |
| 1 | | | |
| Part No. | 693076 | Ref. No. | 544301100 |
| description | drain tray L 325mm W 257mm | | |
| For models: | CF4-78G, CF4-78GE, CF6-712G, CF6-712GEV, CF6-712GV, CF-712GE, PC-712G, PC-716G, PC-74G, PC-78G, TP2-712G, TPF2-712G, TPF2-712GV | | |

| | | | |
|---|---|-----------------|------------------------|
|  | | | |
| 1 | | | |
| Part No. | 210168 | Ref. No. | 544330300 544330301 |
| description | drain tray L 355mm W 326mm | | |
| For models: | FO-1G, FO-2G, FO-3G, FOS-1G, FOS-2G, FOS-3G | | |

| | | | |
|--|--|-----------------|------------------------|
|  | | | |
| 1 | | | |
| Part No. | 693075 | Ref. No. | 544300800 544498800 |
| description | drain tray L 530mm W 326mm | | |
| For models: | CF4-8G, CF4-8GEM, CF4-GEMS, PC-12G, PC-4G, PC-8G | | |



accessories

reducers for pan supports

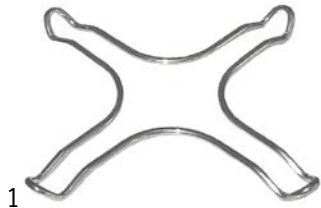

| | | | |
|--------------------|--|-----------------|-----------|
| Part No. | 210050 | Ref. No. | 533009200 |
| description | reducer for pan support L 260mm W 260mm chrome-plated steel suitable for universal | | |
| For models: | CF2-58G, CF2-58GE, CF2-68G, CF2-68GEM, CF3-512GEV, CF3-512GV, CF3-612GEMV, CF3-612GV, CF4-78G, CF4-78GE, CF4-8G, CF4-8GEM, CF4-98G, CF4-98GE, CF4-GEMS, CF6-712G, CF6-712GEV, CF6-712GV, CF6-912G, CF6-912GE, CF6-912GEV, CF6-912GV, CF-712GE, CF8-916G, CF8-916GE, CF8-916GEV, CF8-916GV, CFM2-68GEM, CFM3-612GEMV, CFV4-98GE, CFV6-912GEV, FO-1G, FO-2G, FO-3G, FOS-1G, FOS-2G, FOS-3G, PC-12G, PC1T-64G, PC2T-68G, PC3-612G, PC3T-612G, PC-4G, PC-712G, PC-716G, PC-74G, PC-78G, PC-8G, PC-912G, PC-916G... (Other models you can see in the webshop) | | |

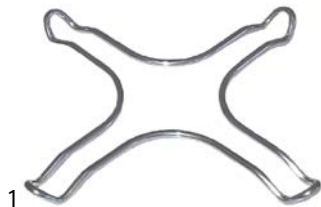

| | | | |
|--------------------|---|-----------------|-----------|
| Part No. | 210001 | Ref. No. | 533009200 |
| description | reducer for pan support L 265mm W 265mm SS suitable for universal | | |



| | | | |
|--------------------|--|-----------------|-----------|
| Part No. | 210018 | Ref. No. | 533009100 |
| description | reducer for pan support ø 160mm | | |
| For models: | CF-10G6-A, CF-10G-6F, CF-10G-A, CF-10GEM, CF-10GEM-6, CF-10GEM6-A, CF-10GEM-A, CF-10GF, CF-62GEM, CF-62GEM-A, CF-8G-A, CF-8GEM, CF-8GEM-A, CF-8GF, CFM-10GEM, CFM-10GEM-6, CFM-10GEM6-A, CFM-10GEM-A, CFM-8GEM, CFM-8GEM-A | | |

pan supports



| | | | |
|--------------------|--|-----------------|-----------|
| Part No. | 210032 | Ref. No. | 532005901 |
| description | pan support W 270mm L 340mm H 47mm | | |
| For models: | CF4-8G, CF4-8GEM, CF4-GEMS, PC-12G, PC-4G, PC-8G | | |



| | | | |
|--------------------|---|-----------------|-----------|
| Part No. | 210172 | Ref. No. | 532002300 |
| description | pan support W 275mm L 345mm | | |
| For models: | CF4-78G, CF4-78GE, CF4-8G, CF4-8GEM, CF4-GEMS, CF6-712G, CF6-712GEV, CF6-712GV, CF-712GE, PC-12G, PC-4G, PC-712G, PC-716G, PC-74G, PC-78G, PC-8G, TP2-712G, TPF2-712G, TPF2-712GV | | |



| | | | |
|--------------------|---|-----------------|-----------|
| Part No. | 210117 | Ref. No. | 532002200 |
| description | pan support W 290mm L 475mm | | |
| For models: | CF-10G-A, CF-10GEM, CF-10GEM-A, CF-10GF, CFM-10GEM, CFM-10GEM-A | | |



| | | | |
|--------------------|--|-----------------|-----------|
| Part No. | 210216 | Ref. No. | 532002101 |
| description | pan support W 290mm L 505mm | | |
| For models: | CF-10G6-A, CF-10G-6F, CF-10G-A, CF-10GEM, CF-10GEM-6, CF-10GEM6-A, CF-10GEM-A, CF-10GF, CF-62GEM, CF-62GEM-A, CF-8G-A, CF-8GEM, CF-8GEM-A, CF-8GF, CFM-10GEM, CFM-10GEM-6, CFM-10GEM6-A, CFM-10GEM-A, CFM-8GEM, CFM-8GEM-A, PC-61GF, PC-62GF | | |



| | | | |
|--------------------|---|-----------------|-----------|
| Part No. | 210217 | Ref. No. | 532002201 |
| description | pan support W 290mm L 505mm | | |
| For models: | CF-10G-A, CF-10GEM, CF-10GEM-A, CF-10GF, CFM-10GEM, CFM-10GEM-A | | |



| | | | |
|---|---|-----------------|-----------|
|  | | | |
| 1 | | | |
| Part No. | 210167 | Ref. No. | 532002400 |
| description | pan support W 346mm L 372mm | | |
| For models: | FO-1G, FO-2G, FO-3G, FOS-1G, FOS-2G, FOS-3G | | |





| | | | |
|---|--|-----------------|-----------|
|  | | | |
| 1 | | | |
| Part No. | 210218 | Ref. No. | 532004000 |
| description | pan support W 365mm L 395mm | | |
| For models: | CF2-58G, CF2-58GE, CF2-68G, CF2-68GEM, CF3-512GV, CF3-512GV, CF3-612GEMV, CF3-612GV, CF4-98G, CF4-98GE, CF6-912G, CF6-912GE, CF6-912GEV, CF6-912GV, CF8-916G, CF8-916GE, CF8-916GEV, CF8-916GV, CFM2-68GEM, CFM3-612GEMV, CFV4-98GE, CFV6-912GEV, PC1T-64G, PC2T-68G, PC3-612G, PC3T-612G, PC-912G, PC-916G, PC-94G, PC-98G, PCD-44G, PCT-912G, PCT-916G, PCT-94G, PCT-98G, PCW-74G, PCWT-74G, TP2-912G, TP2-98G, TP2T-912G, TP2T-98G, TP4-912G, TP4T-912G, TPF2-912G, TPF2-912GE, TPF2-912GEV, TPF2-912GV, TPF2-98G, TPF2-98GE, TPF4-610G...(Other models you can see in the webshop) | | |

spillage trays



| | | | |
|---|---|-----------------|------------------------|
|  | | | |
| 1 | | | |
| Part No. | 210168 | Ref. No. | 544330300 544330301 |
| description | drain tray L 355mm W 326mm | | |
| For models: | FO-1G, FO-2G, FO-3G, FOS-1G, FOS-2G, FOS-3G | | |

air mixers



| | | | |
|---|--|-----------------|-----------|
|  | | | |
| 1 | | | |
| Part No. | 105420 | Ref. No. | 544147400 |
| description | air mixer | | |
| For models: | CP-62G, CP-6G, F13-74G, F18-74G, F2-13-78G, F2-18-78G, FG-10, FG-2-10, FMG-10, FMG-15, FMG-2-10, FMG-2-15, FMGP-20, FMGP-30, FP-62G, FP-6G, FPG-20, FPG-30, FQ-4G, FQ-61GF, FQ-62GF, FQ-6G, FQM-4G | | |

| | | | |
|---|---|-----------------|---------------------------|
|  | | | |
| 1 | | | |
| Part No. | 105749 | Ref. No. | 544424100 |
| description | air mixer | | |
| For models: | CF2-58G, CF2-58GE, CF2-68G, CF2-68GEM, CF3-512GEV, CF3-512GV, CF3-612GEMV, CF3-612GV, CF4-98G, CF4-98GE, CF6-912G, CF6-912GE, CF6-912GEV, CF6-912GV, CF8-916G, CF8-916GE, CF8-916GEV, CF8-916GV, CFM2-68GEM, CFM3-612GEMV, CFV4-98GE, CFV6-912GEV, PC1T-64G, PC2T-68G, PC3-612G, PC3T-612G, PC-912G, PC-916G, PC-94G, PC-98G, PCD-44G, PCT-912G, PCT-916G, PCT-94G, PCT-98G, TP2-912G, TP2-98G, TP2T-912G, TP2T-98G, TP4-912G, TP4T-912G, TPF2-912G, TPF2-912GE, TPF2-912GEV, TPF2-912GV, TPF2-98G, TPF2-98GE, TPF4-610G, TPF4-912G, TPF4-912GE...(Other models you can see in the webshop) | | |
| accessories for | 105749 | | |
|  | Part No. | 105748 | Ref. No. 531034900 |
| | burner lower part for burner cap ø 60mm 4kW | | |
|  | Part No. | 105752 | Ref. No. 531035000 |
| | burner lower part for burner cap ø 80mm 7kW | | |
|  | Part No. | 105755 | Ref. No. 531035100 |
| | burner lower part for burner cap ø 110mm 10kW | | |

| | | | |
|--|-------------------|-----------------|-----------|
|  | | | |
| 1 | | | |
| Part No. | 105412 | Ref. No. | 544012400 |
| description | air mixing sleeve | | |
| For models: | F-1G, FB-1G | | |

| | | | |
|---|--|-----------------|---------------------------|
|  | | | |
| 1 | | | |
| Part No. | 105043 | Ref. No. | 533053000 |
| description | air mixing tube ø 18mm L 38mm | | |
| For models: | BRF-64G, BRF-74G, BRF-94G, CF4-68G, CF4-68GEM, CF4-78G, CF4-78GE, CF4-78GP, CF4-78GP-AUS, CF4-78GP-USA, CF4-8G, CF4-8GEM, CF4-98G, CF4-GEMS, CF6-610G, CF6-610GEM, CF6-712G, CF6-712GEV, CF6-712GPV, CF6-712GPV-USA, CF6-712GV, CF6-912GV, CF-712GE, CF8-916G, CFA4-78G, CFA4-98G, CFA6-712GV, CFA6-912GV, CFM4-66GEM, CFM4-68GEM, CFM6-610GEM, CFPB6-79G, FO-1G, FO-2G, FO-3G, FOS-1G, FOS-2G, FOS-3G, PAF-78G, PAF-98G, PC-12G, PC-4G, PC-712G, PC-716G, PC-74G, PC-78G, PC-8G, PCT-63G, PCT-66G, TP2-712G...(Other models you can see in the webshop) | | |
| accessories for | 105043 | | |
|  | Part No. | 105415 | Ref. No. 532001300 |
| | venturi for burner cap ø 82mm 3.5kW | | |





| | | | |
|---|---|-----------------|---------------------------|
|  | | | |
| 1 | | | |
| Part No. | 105044 | Ref. No. | 533053100 |
| description | air mixing tube ø 20mm L 38mm | | |
| For models: | BRF-78G, CF4-68G, CF4-68GEM, CF4-78G, CF4-78GE, CF4-8G, CF4-8GEM, CF4-GEMS, CF6-610G, CF6-610GEM, CF6-712G, CF6-712GEV, CF6-712GP, CF6-712GV, CF-712GE, CFM4-66GEM, CFM4-68GEM, CFM6-610GEM, F18-94G, F2-18-98G, F2-25-98G, F25-94G, F45-78G, FO-1G, FO-2G, FO-3G, FOS-1G, FOS-2G, FOS-3G, PC-12G, PC-4G, PC-712G, PC-716G, PC-74G, PC-78G, PC-8G, PCT-63G, PCT-66G, TP2-712G, TP4T-610G, TPF2-712G, TPF2-712GV, TPF4-610G, TPF4-610GEM, TPF4-712GP | | |
| accessories for | 105044 | | |
|  | Part No. | 105418 | Ref. No. 532001400 |
| | venturi for burner cap ø 102mm 5.5kW | | |

bar burners

bar burners

| | | | |
|---|--|-----------------|-----------|
|  | | | |
| 1 | | | |
| Part No. | 104143 | Ref. No. | 531019900 |
| description | bar burner 2 row L 400mm W 205mm ømm H 45mm chargrill | | |
| For models: | CW-4G, CW-61G, CW-62G, CW-6G, CW-74G, CW-78G, CWT-74G, CWT-78G | | |

| | | | |
|---|--|-----------------|-----------|
|  | | | |
| 1 | | | |
| Part No. | 105760 | Ref. No. | 531036000 |
| description | bar burner 2 row L 490mm W 200mm ømm H 40mm multi purpose roasting pan | | |
| For models: | BRF-74G | | |

| | | | |
|---|--|-----------------|-----------|
|  | | | |
| 1 | | | |
| Part No. | 105046 | Ref. No. | 531004700 |
| description | bar burner 2 row L 490mm W 380mm ømm H 40mm oven | | |
| For models: | CF4-78G, CF4-78GP, CF4-78GP-AUS, CF4-78GP-USA, CF4-98G, CF6-712GPV, CF6-712GPV-USA, CF6-712GV, CF6-912GV, CF8-916G, CFA4-78G, CFA4-98G, CFA6-712GV, CFA6-912GV, CFPB6-79G, PAF-78G, PAF-98G, TPF2-712GPV, TPF2-712GV, TPF2-78GP, TPF2-912GV, TPF2-98G, TPF4-712GPV, TPF4-912GV, TPF-78G, TPF-98G | | |

| | | | |
|--|--|-----------------|------------------------|
|  | | | |
| 1 | | | |
| Part No. | 105759 | Ref. No. | 531044500 531044501 |
| description | bar burner 2 row L 585mm W 200mm ømm H 45mm chargrill | | |
| For models: | CP-94G, CP-94G-USA, CP-98G, CP-98G-USA, CPA-94G, CPA-98G, CW-94G, CW-98G, CWT-94G, CWT-98G | | |

| | | | |
|--|--------------------------------------|-----------------|-----------|
|  | | | |
| 1 | | | |
| Part No. | 104475 | Ref. No. | 531057200 |
| description | bar burner 3 row L 365mm W 400mm ømm | | |
| For models: | CWT-66G | | |

| | | | |
|--|---|-----------------|-----------|
|  | | | |
| 1 | | | |
| Part No. | 105047 | Ref. No. | 531004800 |
| description | bar burner 3 row L 490mm W 700mm ømm H 40mm oven | | |
| For models: | CF6-712G, CF6-712GP, CF6-912G, CF8-916GV, TPF2-712G, TPF2-912G, TPF2-912GE, TPF4-712GP, TPF4-912G | | |

| | | | |
|--|--|-----------------|-----------|
|  | | | |
| 1 | | | |
| Part No. | 105761 | Ref. No. | 531036100 |
| description | bar burner 4 row L 490mm W 500mm ømm H 40mm multi purpose roasting pan | | |
| For models: | BRF-78G | | |

| | | | |
|---|--|-----------------|-----------|
|  | | | |
| 1 | | | |
| Part No. | 105756 | Ref. No. | 531009901 |
| description | bar burner ø 25mm Wmm Hmm L 500mm oven | | |
| For models: | CF-10G6-A, CF-10G-6F, CF-10G-A, CF-10GF, CF2-58G, CF2-58GE, CF2-68G, CF3-512GEV, CF3-512GV, CF3-612GV, CF4-8G, CF-8G-A, CF-8GF | | |





| | | | |
|---|---|-----------------|-----------|
|  | | | |
| 1 | | | |
| Part No. | 104142 | Ref. No. | 531013800 |
| description | bar burner ø 40mm Wmm Hmm L 260mm flange width 42mm flange length 42mm bain marie | | |
| For models: | BM-61GF, BM-62GF, BR-62G, BR-6G, BRT-66G | | |

| | | | |
|---|--|-----------------|-----------|
|  | | | |
| 1 | | | |
| Part No. | 104141 | Ref. No. | 531005100 |
| description | bar burner ø 40mm Wmm Hmm L 260mm flange width 42mm flange length 42mm griddle | | |
| For models: | FTL-61G, FTL-61GF, FTL-61GS, FTL-61GSF, FTL-62G, FTL-62GF, FTL-62GS, FTL-62GSF, FTL-63G, FTL-63GS, FTL-64G, FTL-64GS, FTLR-62G, FTLR-62GF, FTLR-62GS, FTLR-62GSF, FTLR-63G, FTLR-63GS, FTLR-64G, FTLR-64GS, FTR-61G, FTR-61GF, FTR-61GS, FTR-61GSF, FTR-62G, FTR-62GF, FTR-62GS, FTR-62GSF | | |

| | | | |
|--|---|-----------------|----------|
|  | | | |
| 1 | | | |
| Part No. | 105481 | Ref. No. | 30400060 |
| description | bar burner ø 40mm Wmm Hmm L 325mm flange ø 61mm tilting bratt pan | | |

| | | | |
|---|---|-----------------|-----------|
|  | | | |
| 1 | | | |
| Part No. | 105053 | Ref. No. | 531026100 |
| description | bar burner ø 40mm Wmm Hmm L 383mm flange width 43mm flange length 43mm bain marie | | |
| For models: | BM-6G, BM-78G, BM-8G, BM-98G, BMT-78G, BMT-98G, FTTL-66G, FTTLR-66G, FTTR-66G | | |

| | | | |
|---|---|-----------------|-----------|
|  | | | |
| 1 | | | |
| Part No. | 105048 | Ref. No. | 531026000 |
| description | bar burner ø 40mm Wmm Hmm L 385mm flange width 43mm flange length 43mm griddle | | |
| For models: | BM-4G, BM-74G, BM-94G, BMT-74G, BMT-94G, FTL-4G, FTL-4GS, FTL-6G, FTL-6GS, FTL-712G, FTL-712GS, FTL-712G-USA, FTL-74G, FTL-74GS, FTL-74G-USA, FTL-76G, FTL-76GS, FTL-76G-USA, FTL-78G, FTL-78GAUS, FTL-78GS, FTL-78G-USA, FTL-8G, FTL-8GS, FTLR-6G, FTLR-6GS, FTLR-712G, FTLR-712GS, FTLR-712G-USA, FTLR-76G, FTLR-76GS, FTLR-76G-USA, FTLR-78G, FTLR-78G-AUS, FTLR-78GS, FTLR-78G-USA, FTLR-8G, FTLR-8GS, FTR-4G, FTR-4GS, FTR-6G, FTR-6GS, FTR-712G, FTR-712GS, FTR-712G-USA, FTR-74G, FTR-74GS, FTR-74G-USA, FTR-76G, FTR-76GS...(Other models you can see in the webshop) | | |

| | | | |
|---|---|-----------------|----------|
|  | | | |
| 1 | | | |
| Part No. | 105482 | Ref. No. | 30400050 |
| description | bar burner ø 40mm Wmm Hmm L 396mm flange ø 61mm tilting bratt pan | | |

| | | | |
|---|--|-----------------|-----------|
|  | | | |
| 1 | | | |
| Part No. | 105758 | Ref. No. | 531039100 |
| description | bar burner ø 40mm Wmm Hmm L 565mm with bolt M5x25 flange width 43mm flange length 43mm griddle | | |
| For models: | FTL-916G, FTL-94G, FTL-94GS, FTL-98G, FTL-98GS, FTLR-98G, FTLR-98GS, FTR-94G, FTR-94GS, FTR-98G, FTR-98GS, FTTL-94G, FTTL-94GS, FTTL-98G, FTTL-98GS, FTTLR-98G, FTTLR-98GS, FTTR-94G, FTTR-94GS, FTTR-98G, FTTR-98GS | | |

| | | | |
|---|---|-----------------|-----------|
|  | | | |
| 1 | | | |
| Part No. | 105050 | Ref. No. | 531028600 |
| description | bar burner ø 50mm Wmm Hmm L 299mm 1-row flange width 57mm flange length 57mm pasta cooker | | |
| For models: | CP-74G, CP-74G-AUS, CP-74G-USA, CP-78, CP-78G, CP-78G-AUS, CP-78G-USA, CPA-74G, CPA-78G | | |





| | | | |
|---|---|-----------------|-----------|
|  | | | |
| 1 | | | |
| Part No. | 104144 | Ref. No. | 531017800 |
| description | bar burner ø 50mm Wmm Hmm L 390mm with bolt M5x12 flange width 57mm flange length 57mm pasta cooker | | |
| For models: | CP-94G, CP-94G-USA, CP-98G, CP-98G-USA, CPA-94G, CPA-98G, CPM-62G, CPM-6G | | |

| | | | |
|---|---|-----------------|-------|
|  | | | |
| 1 | | | |
| Part No. | 105920 | Ref. No. | 10053 |
| description | bar burner ø 50mm Wmm Hmm L 450mm flange with bolt M4 flange width 65mm flange length 71mm kettle | | |

| | | | |
|---|--|-----------------|-----------|
|  | | | |
| 1 | | | |
| Part No. | 104146 | Ref. No. | 531010000 |
| description | bar burner ømm W 125mm H 38mm L 500mm grill | | |
| For models: | CF-10G6-A, CF-10G-6F, CF-10G-A, CF-10GF, CF4-8G, CF4-8GEM, CF-8G-A, CF-8GF | | |

| | | | |
|---|--|-----------------|-----------|
|  | | | |
| 1 | | | |
| Part No. | 105757 | Ref. No. | 531010001 |
| description | bar burner ømm W 168mm H 45mm L 485mm grill | | |
| For models: | CF-10G6-A, CF-10G-6F, CF-10G-A, CF-10GF, CF4-8G, CF-8G-A, CF-8GF | | |

| | | | |
|---|-----------------------------------|-----------------|-----------|
|  | | | |
| 1 | | | |
| Part No. | 105782 | Ref. No. | 531044600 |
| description | burner multi purpose roasting pan | | |
| For models: | BRF-94G | | |

| | | | |
|--|-----------------------------------|-----------------|-----------|
|  | | | |
| 1 | | | |
| Part No. | 105783 | Ref. No. | 531044700 |
| description | burner multi purpose roasting pan | | |
| For models: | BRF-98G | | |

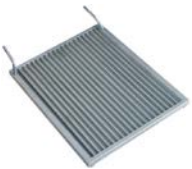
| | | | |
|--|--|-----------------|-----------|
|  | | | |
| 1 | | | |
| Part No. | 211017 | Ref. No. | 541065100 |
| description | chargrill grid L 470mm W 380mm H 15mm suitable for for chargrill | | |
| For models: | CW-4ET, CW-4ETX, CW-4G | | |

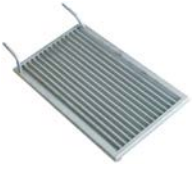
| | | | |
|--|--|-----------------|-----------|
|  | | | |
| 1 | | | |
| Part No. | 211016 | Ref. No. | 541057300 |
| description | chargrill grid L 474mm W 280mm H 10mm for chargrill | | |
| For models: | CW-61ET, CW-61G, CW-62ET, CW-62G, CW-6ET, CW-6ETX, CW-6G | | |

| | | | |
|--|---|-----------------|-----------|
|  | | | |
| 1 | | | |
| Part No. | 211018 | Ref. No. | 541108700 |
| description | chargrill grid L 510mm W 380mm H 50mm stainless steel for chargrill | | |
| For models: | CW-74ET, CW-74ETX, CW-74G, CW-74G-USA, CW-78ET, CW-78ETX, CW-78G, CW-78G-USA, CWT-74ET, CWT-74ETX, CWT-74G, CWT-74GUSA, CWT-78ET, CWT-78ETX, CWT-78G, CWT-78G-USA | | |

| | | | |
|--|--------------------------------|-----------------|-----------|
|  | | | |
| 1 | | | |
| Part No. | 210118 | Ref. No. | 541058201 |
| description | lava rock grid L 400mm W 225mm | | |
| For models: | CW-61G | | |



1 

| | | | |
|--------------------|---------------------------------------|-----------------|-----------|
| Part No. | 211014 | Ref. No. | 541078800 |
| description | lava rock grid L 400mm W 325mm H 35mm | | |
| For models: | CW-4G | | |

1 

| | | | |
|--------------------|---|-----------------|-----------|
| Part No. | 211015 | Ref. No. | 541108800 |
| description | lava rock grid L 440mm W 325mm H 45mm | | |
| For models: | CW-74G, CW-74G-USA, CW-78G, CW-78G-USA, CWT-74G, CWT-74GUSA, CWT-78G, CWT-78G-USA | | |

1 

| | | | |
|--------------------|--------------------------------|-----------------|-----------|
| Part No. | 210119 | Ref. No. | 541058301 |
| description | lava rock grid L 525mm W 400mm | | |
| For models: | CW-62G, CW-6G | | |

1 

| | | | |
|--------------------|--|-----------------|-----------|
| Part No. | 211070 | Ref. No. | 541132901 |
| description | lava rock grid L 605mm W 325mm H 45mm | | |
| For models: | CP-94G, CP-94G-USA, CP-98G, CP-98G-USA, CPA-94G, CPA-98G, CW-94G, CW-98G, CWT-94G, CWT-98G | | |

chargrill grids

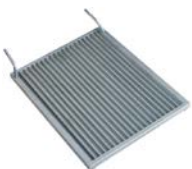
1 

| | | | |
|--------------------|--|-----------------|-----------|
| Part No. | 211017 | Ref. No. | 541065100 |
| description | chargrill grid L 470mm W 380mm H 15mm suitable for for chargrill | | |
| For models: | CW-4ET, CW-4ETX, CW-4G | | |

1 

| | | | |
|--------------------|--|-----------------|-----------|
| Part No. | 211016 | Ref. No. | 541057300 |
| description | chargrill grid L 474mm W 280mm H 10mm for chargrill | | |
| For models: | CW-61ET, CW-61G, CW-62ET, CW-62G, CW-6ET, CW-6ETX, CW-6G | | |

1 

| | | | |
|--------------------|---|-----------------|-----------|
| Part No. | 211018 | Ref. No. | 541108700 |
| description | chargrill grid L 510mm W 380mm H 50mm stainless steel for chargrill | | |
| For models: | CW-74ET, CW-74ETX, CW-74G, CW-74G-USA, CW-78ET, CW-78ETX, CW-78G, CW-78G-USA, CWT-74ET, CWT-74ETX, CWT-74G, CWT-74GUSA, CWT-78ET, CWT-78ETX, CWT-78G, CWT-78G-USA | | |

lava rock grids

1 

| | | | |
|--------------------|--------------------------------|-----------------|-----------|
| Part No. | 210118 | Ref. No. | 541058201 |
| description | lava rock grid L 400mm W 225mm | | |
| For models: | CW-61G | | |

1 

| | | | |
|--------------------|---------------------------------------|-----------------|-----------|
| Part No. | 211014 | Ref. No. | 541078800 |
| description | lava rock grid L 400mm W 325mm H 35mm | | |
| For models: | CW-4G | | |

1 

| | | | |
|--------------------|---|-----------------|-----------|
| Part No. | 211015 | Ref. No. | 541108800 |
| description | lava rock grid L 440mm W 325mm H 45mm | | |
| For models: | CW-74G, CW-74G-USA, CW-78G, CW-78G-USA, CWT-74G, CWT-74GUSA, CWT-78G, CWT-78G-USA | | |

1 

| | | | |
|--------------------|--------------------------------|-----------------|-----------|
| Part No. | 210119 | Ref. No. | 541058301 |
| description | lava rock grid L 525mm W 400mm | | |
| For models: | CW-62G, CW-6G | | |





| | | | |
|---|--|-----------------|-----------|
|  | | | |
| 1 | | | |
| Part No. | 211070 | Ref. No. | 541132901 |
| description | lava rock grid L 605mm W 325mm H 45mm | | |
| For models: | CP-94G, CP-94G-USA, CP-98G, CP-98G-USA, CPA-94G, CPA-98G, CW-94G, CW-98G, CWT-94G, CWT-98G | | |

tube burners

| | | | |
|---|---|-----------------|-----------|
|  | | | |
| 1 | | | |
| Part No. | 105763 | Ref. No. | 531042300 |
| description | tubular burner L 265mm W 52mm H 71mm for fryer oval | | |
| For models: | F18-94G, F2-18-98G, F2-25-98G, F25-94G, F45-78G | | |

| | | | |
|--|--|-----------------|-----------|
|  | | | |
| 1 | | | |
| Part No. | 104140 | Ref. No. | 531006400 |
| description | tubular burner ø 74mm L 165mm H 60mm round for fryer/pasta cooker | | |
| For models: | CP-62G, FMPG-20, FMPG-30, FP-62G, FPG-20, FPG-30, FQ-61GF, FQ-62GF, FQM-4G | | |

| | | | |
|---|--|-----------------|-----------|
|  | | | |
| 1 | | | |
| Part No. | 104198 | Ref. No. | 531013900 |
| description | tubular burner ø 74mm L 180mm H 60mm round for fryer | | |
| For models: | F13-74G, F18-74G, F2-13-78G, F2-18-78G, FG-10, FG-2-10, FMG-10, FMG-15, FMG-2-10, FMG-2-15, FQ-61GF, FQ-62GF, FQM-4G | | |

| | | | |
|--|--|-----------------|------------------------|
|  | | | |
| 1 | | | |
| Part No. | 105049 | Ref. No. | 531030700 531030701 |
| description | tubular burner ø 74mm L 180mm H 60mm round for fryer/pasta cooker | | |
| For models: | CP-6G, F13-74G, F18-74G, F2-13-78G, F2-18-78G, FG-10, FG-2-10, FMG-10, FMG-15, FMG-2-10, FMG-2-15, FP-6G, FQ-4G, FQ-61GF, FQ-62GF, FQ-6G, FQM-4G | | |

solid top burners

| | | | |
|--|---|-----------------|-----------|
|  | | | |
| 1 | | | |
| Part No. | 105045 | Ref. No. | 531033100 |
| description | solid top burner ø 120mm H 102mm L 340mm | | |
| For models: | TP2-712G, TP2-712GP, TP2-78GP, TP2-912G, TP2-98G, TP2T-712GP, TP2T-78GP, TP2T-912G, TP2T-98G, TP4-712GP, TP4-912G, TP4T-712GP, TP4T-912G, TP-74G, TP-78G, TP-94G, TP-98G, TPF2-712G, TPF2-712GP, TPF2-712GPE, TPF2-712GPEV, TPF2-712GPV, TPF2-712GV, TPF2-78GP, TPF2-78GPE, TPF2-912G, TPF2-912GE, TPF2-912GEV, TPF2-912GV, TPF2-98G, TPF2-98GE, TPF4-712GP, TPF4-712GPE, TPF4-712GPEV, TPF4-712GPV, TPF4-912G, TPF4-912GE, TPF4-912GEV, TPF4-912GV, TPF-78G, TPF-78GE, TPF-98G, TPF-98GE, TPFV2-712GPEV, TPFV2-78GPE, TPFV2-912GEV, TPFV2-98GE, TPFV4-712GPEV, TPFV4-912GEV, TPFV-78GE...(Other models you can see in the webshop) | | |

accessories

nozzle holders

| | | | |
|--|---|-----------------|------------------------|
|  | | | |
| 1 | | | |
| Part No. | 105411 | Ref. No. | 533052300 533052301 |
| description | nozzle holder | | |
| For models: | BM-74G, BM-78G, BM-94G, BM-98G, BMT-64G, BMT-66G, BMT-74G, BMT-78G, BMT-94G, BMT-98G, CF2-58G, CF2-58GE, CF2-68G, CF2-68GEM, CF3-512GEV, CF3-512GV, CF3-612GEMV, CF3-612GV, CF4-68G, CF4-68GEM, CF4-78G, CF4-78GE, CF4-78GP, CF4-78GP-AUS, CF4-78GPE, CF4-78GP-USA, CF4-8G, CF4-8GEM, CF4-98G, CF4-98GE, CF4-GEMS, CF6-610G, CF6-610GEM, CF6-712G, CF6-712GEV, CF6-712GP, CF6-712GPE, CF6-712GPEV, CF6-712GPV, CF6-712GPVUSA, CF6-712GV, CF6-912G, CF6-912GE, CF6-912GEV, CF6-912GV, CF-712GE, CF-712GPE, CF8-916G, CF8-916GE, CF8-916GEV...(Other models you can see in the webshop) | | |



| | | | |
|---|---|-----------------|-----------|
|  | | | |
| 1 | | | |
| Part No. | 105419 | Ref. No. | 531025600 |
| description | nozzle holder | | |
| For models: | BM-4G, BM-61GF, BM-62GF, BM-6G, BM-74G, BM-78G, BM-8G, BR-62G, BR-6G, BRF-64G, BRF-74G, BRF-78G, BRF-94G, CF2-58G, CF2-58GE, CF2-68G, CF3-512GEV, CF3-512GV, CF3-612GV, CF4-68G, CF4-78G, CF4-78GP, CF4-78GP-AUS, CF4-78GP-USA, CF4-98G, CF6-610G, CF6-712G, CF6-712GP, CF6-712GPV, CF6-712GPV-USA, CF6-712GV, CF6-912G, CF6-912GV, CF8-916G, CF8-916GV, CFA4-78G, CFA4-98G, CFA6-712GV, CFA6-912GV, CFPB6-79G, CP-62G, CP-74G, CP-74G-USA, CP-78G, CP-78G-USA, CP-94G, CP-94G-USA, CP-98G, CP-98G-USA, CPA-94G...(Other models you can see in the webshop) | | |

| | | | |
|---|--------------------------|-----------------|-----------|
|  | | | |
| 1 | | | |
| Part No. | 101360 | Ref. No. | 531025600 |
| description | nozzle holder angled 90° | | |

| | | | |
|--|---------------------------|-----------------|-----------|
| miscellaneous | | | |
|  | | | |
| 1 | | | |
| Part No. | 101363 | Ref. No. | 544254900 |
| description | bracket for nozzle holder | | |
| For models: | CW-61G, CW-62G | | |

| | | | |
|---|--|-----------------|-----------|
|  | | | |
| 1 | | | |
| Part No. | 101361 | Ref. No. | 541058700 |
| description | connection socket burner | | |
| For models: | CP-94G, CP-94G-USA, CP-98G, CP-98G-USA, CPA-94G, CPA-98G, CW-61G, CW-62G, CW-94G, CW-98G, CWT-74G, CWT-74G-USA, CWT-78G, CWT-78G-USA, CWT-94G, CWT-98G | | |

gas nozzles

main nozzles

| | | | |
|---|--|-----------------|-----------|
| gas nozzles M6x0.75 | | | |
|  | | | |
| 1 | | | |
| Part No. | 104765 | Ref. No. | 533081100 |
| description | gas injector thread M6x0.75 WS 7 bore ø 0.8mm | | |
| For models: | CF-10G6-A, CF-10G-6F, CF-10G-A, CF-10GEM, CF-10GEM-6, CF-10GEM6-A, CF-10GEM-A, CF-10GF, CF-62GEM, CF-62GEM-A, CF-8G-A, CF-8GEM, CF-8GEM-A, CF-8GF, CFM-10GEM, CFM-10GEM-6, CFM-10GEM6-A, CFM-10GEM-A, CFM-8GEM, CFM-8GEM-A, PC-61GF, PC-62GF | | |

| | | | |
|---|--|-----------------|-----------|
|  | | | |
| 1 | | | |
| Part No. | 103321 | Ref. No. | 533080700 |
| description | gas injector thread M6x0.75 WS 7 bore ø 1.34mm | | |
| For models: | CF-10G6-A, CF-10G-6F, CF-10G-A, CF-10GEM, CF-10GEM-6, CF-10GEM6-A, CF-10GEM-A, CF-10GF, CF-62GEM, CF-62GEM-A, CF-8G-A, CF-8GEM, CF-8GEM-A, CF-8GF, CFM-10GEM, CFM-10GEM-6, CFM-10GEM6-A, CFM-10GEM-A, CFM-8GEM, CFM-8GEM-A, PC-61GF, PC-62GF | | |

| | | | |
|---|--|-----------------|-----------|
|  | | | |
| 1 | | | |
| Part No. | 103324 | Ref. No. | 533081200 |
| description | gas injector thread M6x0.75 WS 7 bore ø 1.3mm | | |
| For models: | CF-10G6-A, CF-10G-6F, CF-10G-A, CF-10GEM, CF-10GEM-6, CF-10GEM6-A, CF-10GEM-A, CF-10GF, CF-62GEM, CF-62GEM-A, CF-8G-A, CF-8GEM, CF-8GEM-A, CF-8GF, CFM-10GEM, CFM-10GEM-6, CFM-10GEM6-A, CFM-10GEM-A, CFM-8GEM, CFM-8GEM-A, PC-61GF, PC-62GF | | |

| | | | |
|---|--|-----------------|-----------|
| gas nozzles M7x1 | | | |
|  | | | |
| 1 | | | |
| Part No. | 102549 | Ref. No. | 533049000 |
| description | gas injector thread M7x1 WS 10 bore ø 0.72mm | | |
| For models: | CF-10G6-A, CF-10G-6F, CF-10G-A, CF-10GEM, CF-10GEM-6, CF-10GEM6-A, CF-10GEM-A, CF-10GF, CF-62GEM, CF-62GEM-A, CF-8G-A, CF-8GEM, CF-8GEM-A, CF-8GF, CFM-10GEM, CFM-10GEM-6, CFM-10GEM6-A, CFM-10GEM-A, CFM-8GEM, CFM-8GEM-A, PC-61GF, PC-62GF | | |

| | | | |
|--|--|-----------------|-----------|
|  | | | |
| 1 | | | |
| Part No. | 102554 | Ref. No. | 533032100 |
| description | gas injector thread M7x1 WS 10 bore ø 0.82mm | | |
| For models: | CF-10G6-A, CF-10G-6F, CF-10G-A, CF-10GEM, CF-10GEM-6, CF-10GEM6-A, CF-10GEM-A, CF-10GF, CF-62GEM, CF-62GEM-A, CF-8G-A, CF-8GEM, CF-8GEM-A, CF-8GF, CFM-10GEM, CFM-10GEM-6, CFM-10GEM6-A, CFM-10GEM-A, CFM-8GEM, CFM-8GEM-A, PC-61GF, PC-62GF | | |

| | | | |
|--|--|-----------------|-----------|
|  | | | |
| 1 | | | |
| Part No. | 100520 | Ref. No. | 533049100 |
| description | gas injector thread M7x1 WS 10 bore ø 1.2mm | | |
| For models: | CF-10G6-A, CF-10G-6F, CF-10G-A, CF-10GEM, CF-10GEM-6, CF-10GEM6-A, CF-10GEM-A, CF-10GF, CF-62GEM, CF-62GEM-A, CF-8G-A, CF-8GEM, CF-8GEM-A, CF-8GF, CFM-10GEM, CFM-10GEM-6, CFM-10GEM6-A, CFM-10GEM-A, CFM-8GEM, CFM-8GEM-A, PC-61GF, PC-62GF | | |





| | | | |
|---|--|-----------------|-----------|
|  | | | |
| 1 | | | |
| Part No. | 100522 | Ref. No. | 533032400 |
| description | gas injector thread M7x1 WS 10 bore ø 1.35mm | | |
| For models: | CF-10G6-A, CF-10G-6F, CF-10G-A, CF-10GEM, CF-10GEM-6, CF-10GEM6-A, CF-10GEM-A, CF-10GF, CF-62GEM, CF-62GEM-A, CF-8G-A, CF-8GEM, CF-8GEM-A, CF-8GF, CFM-10GEM, CFM-10GEM-6, CFM-10GEM6-A, CFM-10GEM-A, CFM-8GEM, CFM-8GEM-A, PC-61GF, PC-62GF | | |

| | | | |
|---|--|-----------------|-----------|
|  | | | |
| 1 | | | |
| Part No. | 103322 | Ref. No. | 533032300 |
| description | gas injector thread M7x1 WS 10 bore ø 1.42mm | | |
| For models: | CF-10G6-A, CF-10G-6F, CF-10G-A, CF-10GEM, CF-10GEM-6, CF-10GEM6-A, CF-10GEM-A, CF-10GF, CF-62GEM, CF-62GEM-A, CF-8G-A, CF-8GEM, CF-8GEM-A, CF-8GF, CFM-10GEM, CFM-10GEM-6, CFM-10GEM6-A, CFM-10GEM-A, CFM-8GEM, CFM-8GEM-A, PC-61GF, PC-62GF | | |

| | | | |
|--|--|-----------------|-----------|
|  | | | |
| 1 | | | |
| Part No. | 100525 | Ref. No. | 533012500 |
| description | gas injector thread M7x1 WS 10 bore ø 1.6mm | | |
| For models: | CF-10G6-A, CF-10G-6F, CF-10G-A, CF-10GEM, CF-10GEM-6, CF-10GEM6-A, CF-10GEM-A, CF-10GF, CF-62GEM, CF-62GEM-A, CF-8G-A, CF-8GEM, CF-8GEM-A, CF-8GF, CFM-10GEM, CFM-10GEM-6, CFM-10GEM6-A, CFM-10GEM-A, CFM-8GEM, CFM-8GEM-A, PC-61GF, PC-62GF | | |

gas nozzles M10x1

| | | | |
|---|---|-----------------|-----------|
|  | | | |
| 1 | | | |
| Part No. | 103323 | Ref. No. | 533031100 |
| description | gas injector thread M10x1 WS 11 bore ø 0.6mm inner peaked | | |
| For models: | BM-61GF | | |

| | | | |
|---|---|-----------------|-----------|
|  | | | |
| 1 | | | |
| Part No. | 100640 | Ref. No. | 533031901 |
| description | gas injector thread M10x1 WS 11 bore ø 1.3mm inner peaked | | |
| For models: | BM-74G, BMT-74G, FTL-63G, FTL-63GS, FTL-64G, FTL-64GS, FTLR-62G, FTLR-63G, FTLR-63GS, FTLR-64G, FTLR-64GS, FTR-62G, FTTL-610G, FTTL-610GS, FTTL-64G, FTTL-64GS, FTTL-66G, FTTL-66GS, FTTL-68G, FTTL-68GS, FTTLR-610G, FTTLR-610GS, FTTLR-66G, FTTLR-66GS, FTTLR-68G, FTTLR-68GS, FTTR-610G, FTTR-610GS, FTTR-64G, FTTR-64GS, FTTR-66G, FTTR-66GS, FTTR-68G, FTTR-68GS | | |

| | | | |
|---|--|-----------------|-----------|
|  | | | |
| 1 | | | |
| Part No. | 100653 | Ref. No. | 533057000 |
| description | gas injector thread M10x1 WS 11 bore ø 1.5mm inner flat | | |
| For models: | FTL-4G, FTL-4GS, FTL-6G, FTL-6GS, FTL-712G, FTL-712GS, FTL-712G-USA, FTL-74G, FTL-74GS, FTL-74G-USA, FTL-76G, FTL-76GS, FTL-76G-USA, FTL-78G, FTL-78G-AUS, FTL-78GS, FTL-78G-USA, FTL-8G, FTL-8GS, FTLR-6G, FTLR-6GS, FTLR-712G, FTLR-712GS, FTLR-712GUSA, FTLR-76G, FTLR-76GS, FTLR-76G-USA, FTLR-78G, FTLR-78G-AUS, FTLR-78GS, FTLR-78G-USA, FTLR-8G, FTLR-8GS, FTR-4G, FTR-4GS, FTR-6G, FTR-6GS, FTR-712G, FTR-712GS, FTR-712G-USA, FTR-74G, FTR-74GS, FTR-74G-USA, FTR-76G, FTR-76GS, FTR-76G-USA, FTR-78G, FTR-78G-AUS, FTR-78GS, FTR-78G-USA...(Other models you can see in the webshop) | | |

| | | | |
|---|---|-----------------|-----------|
|  | | | |
| 1 | | | |
| Part No. | 100444 | Ref. No. | 533015100 |
| description | gas injector thread M10x1 WS 12 bore ø 0.8mm | | |
| For models: | BM-94G, BMT-94G, CF4-78GP, CF4-78GP-AUS, CF4-78GPE, CF4-78GP-USA, CF6-712GP, CF6-712GPE, CF6-712GPEV, CF6-712GPV, CF6-712GPV-USA, CF-712GPE, CFV4-78GPE, CFV6-712GPEV, CP-62G, CP-6G, F11-54G, F2-8T-66G, F8T-63G, FP-62G, FQ-61GF, FQ-62GF, FQM-4G, PC-712GP, PC-712GP-USA, PC-716GP, PC-716GP-USA, PC-74GP, PC-74GP-USA, PC-78GP, PC-78GP-USA, PCD-64G, PCD-68G, PCT-712GP, PCT-712GP-USA, PCT-716GP, PCT-716GP-USA, PCT-74GP, PCT-78GP, PCT-78GP-USA, TP4-712GP, TP4T-712GP, TPF4-712GP, TPF4-712GPE, TPF4-712GPEV, TPF4-712GPV, TPFV4-712GPEV | | |

| | | | |
|---|--|-----------------|-----------|
|  | | | |
| 1 | | | |
| Part No. | 100466 | Ref. No. | 533030100 |
| description | gas injector thread M10x1 WS 12 bore ø 0.95mm | | |
| For models: | CF4-98G, CF4-98GE, CF6-912G, CF6-912GE, CF6-912GEV, CF6-912GV, CF8-916G, CF8-916GE, CF8-916GEV, CF8-916GV, CFV4-98GE, CFV6-912GEV, CP-62G, CW-61G, CW-62G, CW-6G, F13-74G, F18-74G, F2-13-78G, F2-18-78G, FMG-10, FMG-15, FMG-2-10, FMG-2-15, FMGP-30, FP-62G, FPG-30, FQM-4G, PC-912G, PC-916G, PC-94G, PC-98G, PCT-912G, PCT-916G, PCT-94G, PCT-98G, TP4-912G, TP4T-912G, TPF2-912GE, TPF4-912G, TPF4-912GE, TPF4-912GEV, TPF4-912GV, TPFV4-912GEV | | |

| | | | |
|---|---|-----------------|-----------|
|  | | | |
| 1 | | | |
| Part No. | 100469 | Ref. No. | 533043900 |
| description | gas injector thread M10x1 WS 12 bore ø 1.15mm | | |





| | | | |
|---|--|-----------------|-----------|
|  | | | |
| 1 | | | |
| Part No. | 100468 | Ref. No. | 533043200 |
| description | gas injector thread M10x1 WS 12 bore ø 1.1mm | | |
| For models: | CF4-78GP, CF4-78GP-AUS, CF4-78GPE, CF4-78GP-USA, CF6-712GP, CF6-712GPE, CF6-712GPEV, CF6-712GPV, CF6-712GPV-USA, CFV4-78GPE, CFV6-712GPEV, CPT-64G, CPT-74G, CPT-76G, CW-61G, CW-62G, CW-6G, CWT-64G, CWT-68G, F13-74G, F18-74G, F2-13-78G, F2-18-78G, F2-8-74G, F2-8-94G, FMG-10, FMG-15, FMG-2-10, FMG-2-15, FQM-4G, PC-712GP, PC-712GP-USA, PC-716GP, PC-716GP-USA, PC-74GP, PC-74GP-USA, PC-78GP, PC-78GP-USA, PCD-64G, PCD-68G, PCT-712GP, PCT-712GP-USA, PCT-716GP, PCT-716GP-USA, PCT-74GP, PCT-78GP, PCT-78GP-USA, TP2-712GP, TP2-78GP, TP2T-712GP...(Other models you can see in the webshop) | | |

| | | | |
|--|---|-----------------|-----------|
|  | | | |
| 1 | | | |
| Part No. | 100479 | Ref. No. | 533019400 |
| description | gas injector thread M10x1 WS 12 bore ø 1.8mm | | |
| For models: | CF2-58G, CF2-58GE, CF2-68G, CF3-512GEV, CF3-512GV, CF3-612GV, CF4-68G, CF4-68GEM, CF4-78G, CF4-78GE, CF4-78GP, CF4-78GP-AUS, CF4-78GPE, CF4-78GP-USA, CF4-8G, CF4-8GEM, CF4-GEMS, CF6-610G, CF6-610GEM, CF6-712G, CF6-712GEV, CF6-712GP, CF6-712GPE, CF6-712GPEV, CF6-712GPV, CF6-712GPV-USA, CF6-712GV, CF6-912G, CF-712GE, CF-712GPE, CF8-916GV, CFA4-78G, CFA4-98G, CFA6-712GV, CFA6-912GV, CFM4-66GEM, CFM4-68GEM, CFM6-610GEM, CFV4-78GPE, CFV6-712GPEV, CP-6G, CWT-64G, CWT-68G, F13-74G, F13T-74G, F13T-94G, F18-74G, F18-94G, F2-13-78G, F2-13T-78G...(Other models you can see in the webshop) | | |

| | | | |
|---|---|-----------------|-----------|
|  | | | |
| 2 | | | |
| Part No. | 100471 | Ref. No. | 533014800 |
| description | gas injector thread M10x1 WS 12 bore ø 1.35mm | | |
| For models: | CF2-58G, CF2-58GE, CF2-68G, CF2-68GEM, CF3-512GEV, CF3-512GV, CF3-612GEMV, CF3-612GV, CF4-78GP, CF4-78GP-AUS, CF4-78GPE, CF4-78GP-USA, CF4-98G, CF4-98GE, CF6-712GP, CF6-712GPE, CF6-712GPEV, CF6-712GPV, CF6-712GPV-USA, CF6-912G, CF6-912GE, CF6-912GEV, CF6-912GV, CF-712GPE, CF8-916G, CF8-916GE, CF8-916GEMV, CF8-916GV, CFM2-68GEM, CFM3-612GEMV, CFV4-78GPE, CFV4-98GE, CFV6-712GPEV, CFV6-912GEV, CP-62G, CP-74G, CP-74G-USA, CP-78, CP-78G, CP-78G-USA, CPA-74G, CPA-78G, CW-74G, CW-74G-USA, CW-78G, CW-78G-USA, CW-94G, CW-98G, CWT-74G, CWT-78G...(Other models you can see in the webshop) | | |

| | | | |
|--|--|-----------------|-----------|
|  | | | |
| 1 | | | |
| Part No. | 102550 | Ref. No. | 533031401 |
| description | gas injector thread M10x1 WS 12 bore ø 1.55mm | | |
| For models: | BM-4G, BM-62GF, BM-6G, BM-8G, BMT-66G, FTL-61G, FTL-61GF, FTL-61GS, FTL-61GSF, FTL-62G, FTL-62GF, FTL-62GS, FTL-62GSF, FTL-63G, FTL-64G, FTL-916G, FTL-94G, FTL-94GS, FTL-98G, FTL-98GS, FTLR-62G, FTLR-62GF, FTLR-62GS, FTLR-62GSF, FTLR-63G, FTLR-64G, FTLR-98G, FTLR-98GS, FTR-61G, FTR-61GF, FTR-61GS, FTR-61GSF, FTR-62G, FTR-62GF, FTR-62GS, FTR-62GSF, FTR-94G, FTR-94GS, FTR-98G, FTR-98GS, FTTL-610G, FTTL-64G, FTTL-66G, FTTL-68G, FTTL-94G, FTTL-94GS, FTTL-98G, FTTL-98GS, FTTLR-610G, FTTLR-66G...(Other models you can see in the webshop) | | |

| | | | |
|---|--|-----------------|-----------|
|  | | | |
| 1 | | | |
| Part No. | 100473 | Ref. No. | 533015200 |
| description | gas injector thread M10x1 WS 12 bore ø 1.45mm | | |
| For models: | CF4-68G, CF4-68GEM, CF4-78G, CF4-78GE, CF4-78GP, CF4-78GP-AUS, CF4-78GPE, CF4-78GP-USA, CF4-8G, CF4-8GEM, CF4-98G, CF4-98GE, CF4-GEMS, CF6-610G, CF6-610GEM, CF6-712G, CF6-712GEV, CF6-712GP, CF6-712GPE, CF6-712GPEV, CF6-712GPV, CF6-712GPV-USA, CF6-712GV, CF6-912G, CF6-912GE, CF6-912GEV, CF6-912GV, CF-712GE, CF-712GPE, CF8-916G, CF8-916GE, CF8-916GEV, CF8-916GV, CFA4-78G, CFA4-98G, CFA6-712GV, CFA6-912GV, CFM4-66GEM, CFM4-68GEM, CFM6-610GEM, CFPB6-79G, CFV4-78GPE, CFV4-98GE, CFV6-712GPEV, CFV6-912GEV, CP-62G, CPB-98G, CPBA-98G, CW-74G, CW-74G-USA...(Other models you can see in the webshop) | | |

| | | | |
|---|--|-----------------|-----------|
|  | | | |
| 1 | | | |
| Part No. | 100474 | Ref. No. | 533014900 |
| description | gas injector thread M10x1 WS 12 bore ø 1.5mm | | |

pilot burner nozzles

pilot burner nozzles SIT

100 series

| | | | |
|--|--|-----------------|-----------|
|  | | | |
| 1 | | | |
| Part No. | 100245 | Ref. No. | 533091000 |
| description | pilot burner nozzle LPG code 20 bore ø 0.2mm Qty 1 pcs thread M8x0.75 | | |
| For models: | CF2-58G, CF2-58GE, CF2-68G, CF2-68GEM, CF3-512GEV, CF3-512GV, CF3-612GEMV, CF3-612GV, CF4-78GP, CF4-78GP-AUS, CF4-78GPE, CF4-78GP-USA, CF4-98G, CF4-98GE, CF6-712GP, CF6-712GPE, CF6-712GPEV, CF6-712GPV, CF6-712GPV-USA, CF6-912G, CF6-912GE, CF6-912GEV, CF6-912GV, CF-712GPE, CF8-916G, CF8-916GE, CF8-916GEMV, CF8-916GV, CFA4-78G, CFA4-98G, CFA6-712GV, CFA6-912GV, CFM2-68GEM, CFM3-612GEMV, CFV4-78GPE, CFV4-98GE, CFV6-712GPEV, CFV6-912GEV, PA-78G, PA-98G, PAF-78G, PAF-98G, PAT-78G, PAT-98G, PC1T-64G, PC2T-68G, PC3-612G, PC3T-612G, PC-712GP, PC-712GPUSA...(Other models you can see in the webshop) | | |

| | | | |
|--|--|-----------------|-----------|
|  | | | |
| 1 | | | |
| Part No. | 100246 | Ref. No. | 533091200 |
| description | pilot burner nozzle natural gas bore ø 0.35mm Qty 1 pcs thread M8x0.75 | | |
| For models: | CF2-58G, CF2-58GE, CF2-68G, CF2-68GEM, CF3-512GEV, CF3-512GV, CF3-612GEMV, CF3-612GV, CF4-78GP, CF4-78GP-AUS, CF4-78GPE, CF4-78GP-USA, CF4-98G, CF4-98GE, CF6-712GP, CF6-712GPE, CF6-712GPEV, CF6-712GPV, CF6-712GPV-USA, CF6-912G, CF6-912GE, CF6-912GEV, CF6-912GV, CF-712GPE, CF8-916G, CF8-916GE, CF8-916GEMV, CF8-916GV, CFA4-78G, CFA4-98G, CFA6-712GV, CFA6-912GV, CFM2-68GEM, CFM3-612GEMV, CFV4-78GPE, CFV4-98GE, CFV6-712GPEV, CFV6-912GEV, PA-78G, PA-98G, PAF-78G, PAF-98G, PAT-78G, PAT-98G, PC1T-64G, PC2T-68G, PC3-612G, PC3T-612G, PC-712GP, PC-712GPUSA...(Other models you can see in the webshop) | | |

1 gas components



140/150 series



| | | | |
|--------------------|--|-----------------|-----------|
| Part No. | 100205 | Ref. No. | 533020500 |
| description | pilot burner nozzle SIT LPG code 19 bore \varnothing 0.23/0.26mm Qty 1 pcs suitable for SIT 150 series | | |
| For models: | BRT-66G, CF4-78G, CF4-78GP, CF4-78GP-AUS, CF4-78GP-USA, CF4-98G, CF6-712G, CF6-712GP, CF6-712GPV, CF6-712GPV-USA, CF6-712GV, CF6-912G, CF6-912GV, CF8-916G, CF8-916GV, CFA4-78G, CFA4-98G, CFA6-712GV, CFA6-912GV, CFPB6-79G, FTL-54G, FTL-56G, FTL-712G, FTL-712GS, FTL-712G-USA, FTL-74G, FTL-74GS, FTL-74GUSA, FTL-76G, FTL-76GS, FTL-76G-USA, FTL-78G, FTL-78G-AUS, FTL-78GS, FTL-78G-USA, FTL-916G, FTL-94G, FTL-94GS, FTL-98G, FTL-98GS, FTLR-56G, FTLR-712G, FTLR-712GS, FTLR-712G-USA, FTLR-76G, FTLR-76GS, FTLR-76G-USA, FTLR-78G, FTLR-78G-AUS, FTLR-78GS... (Other models you can see in the webshop) | | |



| | | | |
|--------------------|--|-----------------|-----------|
| Part No. | 100207 | Ref. No. | 533020600 |
| description | pilot burner nozzle SIT natural gas code 27 bore \varnothing 0.40/0.38mm suitable for SIT 140 series | | |
| For models: | BRT-66G, CF4-78G, CF4-78GP, CF4-78GP-AUS, CF4-78GP-USA, CF4-98G, CF6-712G, CF6-712GP, CF6-712GPV, CF6-712GPV-USA, CF6-712GV, CF6-912G, CF6-912GV, CF8-916G, CF8-916GV, CFA4-78G, CFA4-98G, CFA6-712GV, CFA6-912GV, CFPB6-79G, CPT-64G, CPT-66G, CPT-74G, CPT-76G, FTL-54G, FTL-56G, FTL-712G, FTL-712GS, FTL-712G-USA, FTL-74G, FTL-74GS, FTL-74G-USA, FTL-76G, FTL-76GS, FTL-76G-USA, FTL-78G, FTL-78G-AUS, FTL-78GS, FTL-78G-USA, FTL-916G, FTL-94G, FTL-94GS, FTL-98G, FTL-98GS, FTLR-56G, FTLR-712G, FTLR-712GS, FTLR-712G-USA, FTLR-76G, FTLR-76GS... (Other models you can see in the webshop) | | |

160 series



| | | | |
|--------------------|--|-----------------|-----------|
| Part No. | 107172 | Ref. No. | 533020800 |
| description | pilot burner nozzle SIT LPG code 25 Qty 1 pcs | | |
| For models: | BM-74G, BM-78G, BM-94G, BM-98G, BMT-64G, BMT-66G, BMT-74G, BMT-78G, BMT-94G, BMT-98G, BR-62G, BR-66G, BR-74G, BR-78G, BR-94G, BR-98G, CP-66G, CP-74G, CP-74G-USA, CP-76G, CP-78G, CP-78G-USA, CPA-66G, CPA-74G, CPA-76G, CPA-78G, CPP-94G, CPP-94G-USA, CPT-64G, CPT-66G | | |



| | | | |
|--------------------|--|-----------------|-----------|
| Part No. | 107650 | Ref. No. | 533020200 |
| description | pilot burner nozzle SIT LPG code 30 Qty 1 pcs | | |
| For models: | BM-4G, BM-61GF, BM-62GF, BM-6G, BM-74G, BM-78G, BM-8G, BR-62G, BR-66G, BR-64G, BR-74G, BR-78G, CP-62G, CP-6G, CP-74G, CP-74GUSA, CP-78G, CP-78G-USA, CP-94G, CP-94G-USA, CP-98G, CP-98GUSA, CPA-94G, CPA-98G, CPB-98G, CPBA-98G, CPM-62G, CPM-66G, CW-4G, CW-61G, CW-62G, CW-6G, CW-74G, CW-74G-USA, CW-78G, CW-78G-USA, CW-94G, CW-98G, CWT-64G, CWT-66G, CWT-68G, CWT-74G, CWT-78G, CWT-94G, CWT-98G, F11-54G, F13-64G, F13-74G, F13T-74G, F13T-94G... (Other models you can see in the webshop) | | |



| | | | |
|--------------------|---|-----------------|-----------|
| Part No. | 107174 | Ref. No. | 533020300 |
| description | pilot burner nozzle SIT natural gas code 41 Qty 1 pcs | | |
| For models: | BM-74G, BM-78G, BM-94G, BM-98G, BMT-64G, BMT-66G, BMT-74G, BMT-78G, BMT-94G, BMT-98G, BR-62G, BR-66G, BR-74G, BR-78G, BR-94G, BR-98G, CP-66G, CP-74G, CP-74G-USA, CP-76G, CP-78G, CP-78G-USA, CPA-66G, CPA-74G, CPA-76G, CPA-78G, CPB-98G, CPBA-98G, CPP-94G, CPP-94G-USA, CPT-64G, CPT-66G | | |



| | | | |
|--------------------|---|-----------------|-----------|
| Part No. | 107175 | Ref. No. | 533020400 |
| description | pilot burner nozzle SIT natural gas code 51 Qty 1 pcs suitable for 160 series | | |
| For models: | BM-4G, BM-61GF, BM-62GF, BM-6G, BM-74G, BM-78G, BM-8G, BR-62G, BR-66G, BR-64G, BR-74G, BR-78G, CP-62G, CP-6G, CP-74G, CP-74G-USA, CP-78G, CP-78G-USA, CP-94G, CP-94G-USA, CP-98G, CP-98G-USA, CPA-94G, CPA-98G, CPM-62G, CPM-66G, CW-4G, CW-61G, CW-62G, CW-6G, CW-74G, CW-74G-USA, CW-78G, CW-78G-USA, CW-94G, CW-98G, CWT-64G, CWT-66G, CWT-68G, CWT-74G, CWT-78G, CWT-94G, CWT-98G, F11-54G, F13-64G, F13-74G, F13T-74G, F13T-94G, F18-74G, F18-94G... (Other models you can see in the webshop) | | |

bypass nozzles

bypass nozzles PEL22



| | | | |
|--------------------|---|-----------------|-----------|
| Part No. | 100432 | Ref. No. | 533069700 |
| description | bypass nozzle type PEL22 bore \varnothing 0.75mm thread M6x0.5 | | |
| For models: | BRF-64G, BRF-74G, CF4-78G, CF4-78GP, CF4-78GP-AUS, CF4-78GPUSA, CF4-98G, CF6-712GPV, CF6-712GPV-USA, CF6-712GV, CF6-912GV, CF8-916G, CFA4-78G, CFA4-98G, CFA6-712GV, CFA6-912GV, CFPB6-79G, PAF-78G, PAF-98G, TPF2-712GPV, TPF2-712GV, TPF2-78GP, TPF2-912GV, TPF2-98G, TPF4-712GPV, TPF4-912GV, TPF-78G, TPF-98G | | |

bypass nozzles SABAF



| | | | |
|--------------------|--|-----------------|-----------|
| Part No. | 107151 | Ref. No. | 533045901 |
| description | bypass nozzle bore \varnothing 0.45mm thread M4x0.5 SABAF | | |
| For models: | CF-10G6-A, CF-10G6-F, CF-10G-A, CF-10GF, CF2-58G, CF2-58GE, CF2-68G, CF3-512GEV, CF3-512GV, CF3-612GV, CF4-68G, CF4-8G, CF6-610G, CF-8G-A, CF-8GF, TPF4-610G | | |



auxiliary gas parts

screw connections

olives



1

| | | | |
|--------------------|---|-----------------|-----------|
| Part No. | 101278 | Ref. No. | 533039300 |
| description | olive for pipe ø 10mm Qty 1 pcs | | |
| For models: | BM-4G, BM-61GF, BM-62GF, BM-6G, BM-74EM, BM-74G, BM-78EM, BM-78G, BM-8G, BM-94EM, BM-94G, BM-98EM, BM-98G, BMD-64EM, BMD-84EM, BMT-64G, BMT-66G, BMT-74G, BMT-78G, BMT-94G, BMT-98G, BR-62G, BR-6G, BR-64G, BR-74G, BR-78G, BR-94G, BRT-66G, CF2-58G, CF2-58GE, CF2-68G, CF2-68GEM, CF3-512GEV, CF3-512GV, CF3-612GEMV, CF3-612GV, CF4-68G, CF4-68GEM, CF4-78ET, CF4-78ETX, CF4-78G, CF4-78GE, CF4-78GP, CF4-78GP-AUS, CF4-78GPE, CF4-78GP-USA, CF4-8G, CF4-8GEM, CF4-98ET, CF4-98ETX...(Other models you can see in the webshop) | | |

| | | | | |
|------------------------|---------------------------------------|--------|-----------------|-----------|
| accessories for | 101278 | | | |
| | Part No. | 100943 | Ref. No. | — |
| | union nut thread M17x1 tube ø 10mm | | | |
| | Part No. | 101300 | Ref. No. | 533010800 |
| | union nut thread M16x1.5 tube ø 10mm | | | |
| | Part No. | 101478 | Ref. No. | — |
| | union nut thread 3/8" for pipe ø 10mm | | | |



1

| | | | |
|--------------------|---|-----------------|-----------|
| Part No. | 101273 | Ref. No. | 533017900 |
| description | olive for pipe ø 12mm L 9.5mm brass Qty 1 pcs suitable for universal | | |
| For models: | BM-61GF, BM-62GF, BM-74G, BM-78G, BM-94G, BM-98G, BMT-64G, BMT-66G, BMT-74G, BMT-78G, BMT-94G, BMT-98G, BR-64G, BR-74G, BR-78G, BR-94G, BR-98G, CP-62G, CP-6G, CPM-62G, F11-54G, F13-64G, F13-74G, F13T-74G, F13T-94G, F18-74G, F2-13-78G, F2-13T-78G, F2-13T-98G, F2-18-78G, F2-8-74G, F2-8-94G, F2-8T-66G, F2-8T-74G, F2-8T-94G, F8T-63G, FG-10, FG-2-10, FMG-10, FMG-15, FMG-2-10, FMG-2-15, FMPPG-20, FMPPG-30, FP-62G, FP-6G, FPG-20, FPG-30, FQ-4G, FQ-61GF...(Other models you can see in the webshop) | | |

| | | | | |
|------------------------|---|--------|-----------------|-----------|
| accessories for | 101273 | | | |
| | Part No. | 100944 | Ref. No. | — |
| | union nut thread M18x1.5 for pipe ø 12mm | | | |
| | Part No. | 101276 | Ref. No. | 533018000 |
| | union screw thread 3/8" tube ø 12mm Qty 1 pcs | | | |



1

| | | | |
|--------------------|--|-----------------|-----------|
| Part No. | 106598 | Ref. No. | 533010200 |
| description | olive for pipe ø 18mm Qty 1 pcs ED ø 21mm | | |
| For models: | BM-10EM, BM-10EMX, BM-4EM, BM-4EMX, BM-4G, BM-61EM, BM-61GF, BM-62EM, BM-62ET, BM-62GF, BM-6EM, BM-6EMX, BM-6G, BM-8EM, BM-8EMX, BM-8G, BMT-63EM, BMT-64EM, BMT-64G, BMT-66EM, BMT-66G, BMT-74EM, BMT-74G, BMT-78EM, BMT-78G, BMT-94EM, BMT-94G, BMT-98EM, BMT-98G, BS-4EM, BS-4EMX, CP-61EM, CP-62ET, CP-62G, CP-6G, CPT-64EM-USA, CPT-64ET, CPT-64G, CPT-66ET, CPT-66G, CPT-74ET, CPT-74G, CPT-76ET, CPT-76G, CWK-74ET, CWK-78ET, CWK-94ET, CWK-98ET, CWKT-64ET, CWKT-68ET...(Other models you can see in the webshop) | | |



1

| | | | | |
|------------------------|--|-----------------|-----------------|-----------|
| Part No. | 100898 | Ref. No. | 533023300 | |
| description | olive for pipe ø 6mm Qty 1 pcs for pilot burner | | | |
| For models: | BRT-66G, CF4-78G, CF4-78GP, CF4-78GP-AUS, CF4-78GP-USA, CF4-98G, CF6-712GV, CF6-912G, CF6-912GV, CF8-916G, CF8-916GV, CFA4-78G, CFA4-98G, CFA6-712GV, CFA6-912GV, CFPB6-79G, CPT-64G, CPT-66G, CPT-74G, CPT-76G, FTL-54G, FTL-56G, FTL-712G, FTL-712GS, FTL-712G-USA, FTL-74G, FTL-74GS, FTL-74G-USA, FTL-76G, FTL-76GS, FTL-76G-USA, FTL-78G, FTL-78G-AUS, FTL-78GS, FTL-78G-USA, FTL-916G, FTL-94G, FTL-94GS, FTL-98G, FTL-98GS, FTLR-56G, FTLR-712G, FTLR-712GS, FTLR-712G-USA, FTLR-76G, FTLR-76GS...(Other models you can see in the webshop) | | | |
| accessories for | 100898 | | | |
| | Part No. | 100909 | Ref. No. | 533018500 |
| | union screw thread M10x1 for pipe ø 6mm Qty 1 pcs | | | |



1

| | | | |
|--------------------|---|-----------------|-----------|
| Part No. | 101857 | Ref. No. | 533010400 |
| description | olive for pipe ø 6mm Qty 1 pcs suitable for 160 series for pilot burner | | |
| For models: | BM-4G, BM-61GF, BM-62GF, BM-6G, BM-74G, BM-78G, BM-8G, BM-94G, BM-98G, BMT-64G, BMT-66G, BMT-74G, BMT-78G, BMT-94G, BMT-98G, BR-62G, BR-6G, BR-64G, BR-74G, BR-78G, BR-94G, BR-98G, CP-62G, CP-66G, CP-6G, CP-74G, CP-74G-USA, CP-76G, CP-78, CP-78G, CP-78G-USA, CP-94G, CP-94G-USA, CP-98G, CP-98G-USA, CPA-66G, CPA-74G, CPA-76G, CPA-78G, CPA-94G, CPA-98G, CPB-98G, CPBA-98G, CPM-62G, CPM-6G, CPP-94G, CPP-94G-USA, CPT-64G, CPT-66G, CW-4G...(Other models you can see in the webshop) | | |

union nuts



1

| | | | |
|------------------------|---|-----------------|-----------|
| Part No. | 101300 | Ref. No. | 533010800 |
| description | union nut thread M16x1.5 tube ø 10mm | | |
| For models: | BM-4G, BM-61GF, BM-62GF, BM-6G, BM-74EM, BM-74G, BM-78EM, BM-78G, BM-8G, BM-94EM, BM-94G, BM-98EM, BM-98G, BMD-64EM, BMD-84EM, BMT-64G, BMT-66G, BMT-74G, BMT-78G, BMT-94G, BMT-98G, BR-62G, BR-6G, BR-64G, BR-74G, BR-78G, BR-94G, BRT-66G, CF2-58G, CF2-58GE, CF2-68G, CF2-68GEM, CF3-512GEV, CF3-512GV, CF3-612GEMV, CF3-612GV, CF4-68G, CF4-68GEM, CF4-78ET, CF4-78ETX, CF4-78G, CF4-78GE, CF4-78GP, CF4-78GP-AUS, CF4-78GPE, CF4-78GP-USA, CF4-8G, CF4-8GEM, CF4-98ET, CF4-98ETX...(Other models you can see in the webshop) | | |
| accessories for | 101300 | | |



1

| | | | |
|--------------------|---------------------------------|-----------------|-----------|
| Part No. | 101278 | Ref. No. | 533039300 |
| description | olive for pipe ø 10mm Qty 1 pcs | | |

1 gas components



union screws



| | | | |
|--------------------|--|-----------------|-----------|
| Part No. | 100906 | Ref. No. | 533018600 |
| description | screw connection thread M10x1 for ignition electrode brass Qty 1 pcs WS 10 | | |
| For models: | BM-4G, BM-61GF, BM-62GF, BM-6G, BM-74G, BM-78G, BM-8G, BM-94G, BM-98G, BMT-64G, BMT-66G, BMT-74G, BMT-78G, BMT-94G, BMT-98G, BR-62G, BR-6G, BRF-64G, BRF-74G, BRF-78G, BRF-94G, BRF-98G, BRT-66G, CF4-78G, CF4-78GP, CF4-78GP-AUS, CF4-78GPUSA, CF4-98G, CF6-712G, CF6-712GP, CF6-712GPV, CF6-712GPV-USA, CF6-712GV, CF6-912G, CF6-912GV, CF8-916G, CF8-916GV, CFA4-78G, CFA4-98G, CFA6-712GV, CFA6-912GV, CFPB6-79G, CP-62G, CP-66G, CP-6G, CP-74G, CP-74G-USA, CP-76G, CP-78, CP-78G...(Other models you can see in the webshop) | | |



| | | | |
|--------------------|--|-----------------|-----------|
| Part No. | 106597 | Ref. No. | 533010100 |
| description | union screw thread 3/4" for pipe ø 18mm L 20mm Qty 1 pcs WS 27 | | |
| For models: | BM-10EM, BM-10EMX, BM-4EM, BM-4EMX, BM-4G, BM-61EM, BM-61GF, BM-62EM, BM-62ET, BM-62GF, BM-6EM, BM-6EMX, BM-6G, BM-8EM, BM-8EMX, BM-8G, BMT-63EM, BMT-64EM, BMT-64G, BMT-66EM, BMT-66G, BMT-74EM, BMT-74G, BMT-78EM, BMT-78G, BMT-94EM, BMT-94G, BMT-98EM, BMT-98G, BS-4EM, BS-4EMX, CP-61EM, CP-62ET, CP-62G, CP-6G, CPT-64EM-USA, CPT-64ET, CPT-64G, CPT-66ET, CPT-66G, CPT-74ET, CPT-74G, CPT-76ET, CPT-76G, CWK-74ET, CWK-78ET, CWK-94ET, CWK-98ET, CWKT-64ET, CWKT-68ET...(Other models you can see in the webshop) | | |



| | | | |
|------------------------|---|-----------------|-----------|
| Part No. | 100909 | Ref. No. | 533018500 |
| description | union screw thread M10x1 for pipe ø 6mm Qty 1 pcs | | |
| accessories for | 100909 | | |
| | Part No. | Ref. No. | 533023300 |
| | olive for pipe ø 6mm Qty 1 pcs for pilot burner | | |
| | Part No. | Ref. No. | — |
| | olive ID ø 6mm Qty 1 pcs | | |
| | Part No. | Ref. No. | — |
| | olive for pipe ø 6mm Qty 1 pcs | | |
| | Part No. | Ref. No. | — |
| | olive for pipe ø 6mm L 6mm aluminium Qty 1 pcs ED ø 8.5mm | | |



| | | | |
|--------------------|--|-----------------|------------------------|
| Part No. | 101475 | Ref. No. | 533016900 533026400 |
| description | union screw thread M13x1 for pipe ø 8mm Qty 1 pcs | | |
| For models: | CF-10G6-A, CF-10G-6F, CF-10G-A, CF-10GF, CF4-8G, CF4-8GEM, CF-8G-A, CF-8GF | | |



| | | | |
|--------------------|--|-----------------|------------------------|
| Part No. | 101477 | Ref. No. | 533016200 533026400 |
| description | union screw thread M13x1 tube ø 8mm Qty 1 pcs | | |
| For models: | CF-10G6-A, CF-10G-6F, CF-10G-A, CF-10GEM, CF-10GEM-6, CF-10GEM6-A, CF-10GEM-A, CF-10GF, CF2-58G, CF2-58GE, CF2-68G, CF3-512GEV, CF3-512GV, CF3-612GV, CF4-68G, CF4-8G, CF4-8GEM, CF-62GEM, CF-62GEM-A, CF6-610G, CF-8G-A, CF-8GEM, CF-8GEM-A, CF-8GF, CFM-10GEM, CFM-10GEM-6, CFM-10GEM6-A, CFM-10GEM-A, CFM-8GEM, CFM-8GEM-A, PC-61GF, PC-62GF, TPF4-610G | | |

equipment-specific units

for dough mixers

flange bearings



| | | | |
|--------------------|---|-----------------|----------|
| Part No. | 693112 | Ref. No. | 20400012 |
| description | flange bearing type UCF204 shaft ø 20mm 4 hole flange hole distance 64mm H 33mm flange length 86mm flange width 86mm hole ø 12mm flange F204 ball bearing UC204G2 FH 25.5mm | | |

for convection ovens/combi-steamers

spare parts and accessories



| | | | |
|--------------------|---------------------------------------|-----------------|----------|
| Part No. | 551458 | Ref. No. | C8136-00 |
| description | connecting piece L 45mm W 15mm H 38mm | | |



door mechanics

accessories



1

| | | | |
|--------------------|--|-----------------|----------|
| Part No. | 696845 | Ref. No. | C2094-00 |
| description | base plate W 38mm hole ø 7mm stainless steel L 192mm | | |



1

| | | | |
|--------------------|-------------------------|-----------------|-----------|
| Part No. | 691101 | Ref. No. | 544138400 |
| description | warming plate aluminium | | |

for tilting bratt pans

spindles



1

| | | | |
|--------------------|-----------------------------|-----------------|-----------|
| Part No. | 693110 | Ref. No. | SMB012800 |
| description | threaded rod L 363mm ø 20mm | | |

for toasters

pliers



1

| | | | |
|--------------------|--|-----------------|-----------|
| Part No. | 690010 | Ref. No. | 531004500 |
| description | plier for toaster H 180mm total length 100mm | | |
| For models: | TS-3, TS-6 | | |

miscellaneous



1

| | | | |
|--------------------|---------|-----------------|-----------|
| Part No. | 693111 | Ref. No. | SMB013000 |
| description | spindle | | |



1

| | | | |
|--------------------|---------|-----------------|-----------|
| Part No. | 693114 | Ref. No. | SMB063000 |
| description | spindle | | |

knobs

universal knobs



1

| | | | |
|--------------------|--|-----------------|-----------|
| Part No. | 110242 | Ref. No. | 531000300 |
| description | knob thermostat t.max. 180°C ø 50mm shaft ø 6x4.6mm shaft flat upper black temperature range 100-180°C | | |
| For models: | FEC-4 | | |



1

| | | | |
|--------------------|---|-----------------|---------|
| Part No. | 693109 | Ref. No. | SC02200 |
| description | threaded bush for tilting bratt pan brass thread TR20x4 | | |

for rechauds

warming plates

components



1

| | | | |
|--------------------|---------------------------|-----------------|-----------|
| Part No. | 691100 | Ref. No. | 541013200 |
| description | support for warming plate | | |

producer-specific knobs

LOTUS





1

| | | | |
|--------------------|---|-----------------|-----------|
| Part No. | 110582 | Ref. No. | 536013900 |
| description | knob energy regulator 0-6 1-circuit t.max.°C ø 40mm shaft ø 6x4.6mm shaft flat left black | | |
| For models: | CFC-62EM, CFC-62ET, PCC-61EM, PCC-62EM, PCC-62ET | | |





| | | | |
|---|---|-----------------|-----------|
|  | | | |
| 1 | | | |
| Part No. | 110583 | Ref. No. | 536013500 |
| description | knob energy regulator 0-6 2-circuit t.max.°C°C ø 40mm shaft ø 6x4.6mm shaft flat left black | | |
| For models: | CFC-62EM, CFC-62ET, PCC-61EM, PCC-62EM, PCC-62ET | | |

| | | | |
|---|---|-----------------|-----------|
|  | | | |
| 1 | | | |
| Part No. | 110329 | Ref. No. | 536013600 |
| description | knob gas tap PEL21/22/23 ø 40mm shaft ø 6x4.6mm shaft flat left black | | |
| For models: | BR-62G, CW-61G, CW-62G | | |

| | | | |
|--|--|-----------------|-----------|
|  | | | |
| 1 | | | |
| Part No. | 111819 | Ref. No. | 536020200 |
| description | knob gas tap with ignition flame SKG 2-circuit ø 40mm shaft ø 6x4.6mm shaft flat upper black | | |
| For models: | CF-10G6-A, CF-10G-6F, CF-10G-A, CF-10GEM, CF-10GEM-6, CF-10GEM6-A, CF-10GEM-A, CF-10GF, CF-62GEM, CF-62GEM-A, CF-8G-A, CF-8GEM, CF-8GEM-A, CF-8GF, CFM-10GEM, CFM-10GEM-6, CFM-10GEM6-A, CFM-10GEM-A, CFM-8GEM, CFM-8GEM-A, PC-61GF, PC-62GF | | |

| | | | |
|---|--|-----------------|-----------|
|  | | | |
| 1 | | | |
| Part No. | 111724 | Ref. No. | 536002501 |
| description | knob gas tap with ignition flame SKG ø 40mm shaft ø 6x4.6mm shaft flat upper black | | |
| For models: | CF-10G6-A, CF-10G-6F, CF-10G-A, CF-10GEM, CF-10GEM-6, CF-10GEM6-A, CF-10GEM-A, CF-10GF, CF-62GEM, CF-62GEM-A, CF-8G-A, CF-8GEM, CF-8GEM-A, CF-8GF, CFM-10GEM, CFM-10GEM-6, CFM-10GEM6-A, CFM-10GEM-A, CFM-8GEM, CFM-8GEM-A, PC-61GF, PC-62GF | | |

| | | | |
|--|---|-----------------|-----------|
|  | | | |
| 1 | | | |
| Part No. | 110320 | Ref. No. | 536002100 |
| description | knob switch 7-position t.max.°C°C ø 40mm shaft ø 6x4.6mm shaft flat left black | | |
| For models: | CF-10EM, CF-10EM-6, CF-10EM-A, CF-10ET, CF-10ET-6, CF-10ET-A, CF-62EM, CF-62EM-A, CF-62ET, CF-62ET-A, CF-8EM, CF-8EM-A, CF-8ET, CF-8ET-A, CFM-10EM, CFM-10EM-6, CFM-10EM-A, CFM-10ET, CFM-10ET-6, CFM-10ET-A, CFM-8EM, CFM-8EM-A, CFM-8ET, CFM-8ET-A, PC-61EM, PC-62EM, PC-62ET | | |

| | | | |
|---|---|-----------------|-----------|
|  | | | |
| 1 | | | |
| Part No. | 110877 | Ref. No. | 536011500 |
| description | knob switch zero mark t.max.°C°C ø 40mm shaft ø 6x4.6mm shaft flat left black | | |
| For models: | WP | | |

| | | | |
|---|---|-----------------|-----------|
|  | | | |
| 1 | | | |
| Part No. | 110322 | Ref. No. | 536002400 |
| description | knob thermostat t.max. 180°C ø 40mm shaft ø 6x4.6mm shaft flat left rotation 270° black temperature range 100-180°C | | |
| For models: | FP-62ET, FP-62ETL, FQ-61EM, FQ-61ET, FQ-62EM, FQ-62ET | | |

| | | | |
|---|--|-----------------|-----------|
|  | | | |
| 1 | | | |
| Part No. | 110667 | Ref. No. | 536002300 |
| description | knob thermostat t.max. 300°C ø 40mm shaft ø 6x4.6mm shaft flat left rotation 210° black temperature range 50-300°C | | |
| For models: | BR-62ET, CW-61ET, CW-62ET, FTL-61ET, FTL-61ETS, FTL-62ET, FTL-62ETS, FTL-63ET, FTL-63ETS, FTL-64ET, FTL-64ETS, FTLR-62ET, FTLR-62ETS, FTLR-63ET, FTLR-63ETS, FTLR-64ET, FTLR-64ETS, FTR-61ET, FTR-61ETS, FTR-62ET, FTR-62ETS | | |





1

| | | | |
|--------------------|---|-----------------|-----------|
| Part No. | 110324 | Ref. No. | 536002600 |
| description | knob thermostat t.max. 300°C ø 40mm shaft ø 6x4.6mm shaft flat left rotation 310° black temperature range 50-300°C | | |
| For models: | FTC-61EM, FTC-61ET, FTC-62EM, FTC-62ET, FTL-61EM, FTL-61EMS, FTL-62EM, FTL-62EMS, FTL-63EM, FTL-63EMS, FTL-64EM, FTL-64EMS, FTLR-62EM, FTLR-62EMS, FTLR-63EM, FTLR-63EMS, FTLR-64EM, FTLR-64EMS, FTR-61EM, FTR-61EMS, FTR-62EM, FTR-62EMS | | |



1

| | | | |
|--------------------|---|-----------------|-----------|
| Part No. | 110321 | Ref. No. | 536002200 |
| description | knob thermostat t.max. 90°C 30-90°C ø 40mm shaft ø 6x4.6mm shaft flat left rotation 270° black | | |
| For models: | BM-61EM, BM-62EM, BM-62ET, BS-61EM, BS-62EM, CP-61EM, CP-62ET, MP-62, MP-62EM, SV-11, SV-113, SV-12, SV-123, SV-13, SV-23 | | |



1

| | | | |
|--------------------|--|-----------------|-----------|
| Part No. | 110328 | Ref. No. | 536003100 |
| description | knob gas thermostat 1-10 ø 44mm shaft ø 8x6.5mm shaft flat lower silver | | |
| For models: | CF-10G6-A, CF-10G-6F, CF-10G-A, CF-10GF, CF4-8G, CF4-8GEM, CF-8G-A, CF-8GF | | |



1

| | | | |
|--------------------|---|-----------------|-----------|
| Part No. | 110338 | Ref. No. | 536002800 |
| description | knob oven ø 62mm shaft ø 6x4.6mm shaft flat left black | | |
| For models: | CF-10EM, CF-10EM-6, CF-10EM-A, CF-10ET, CF-10ET-6, CF-10ET-A, CF-10GEM, CF-10GEM-6, CF-10GEM6-A, CF-10GEM-A, CF4-8ETS, CF4-GEMS, CF-8EM, CF-8EM-A, CF-8ET, CF-8ET-A, CF-8GEM, CF-8GEM-A | | |



1

| | | | |
|--------------------|---|-----------------|-----------|
| Part No. | 110327 | Ref. No. | 536002900 |
| description | knob switch zero mark ø 45mm shaft ø 6x4.6mm shaft flat upper black | | |



1

| | | | |
|--------------------|---|-----------------|-----------|
| Part No. | 110090 | Ref. No. | 536003000 |
| description | knob switch zero mark t.max. °C ø 38mm shaft ø 6x4.6mm shaft flat upper white | | |
| For models: | TS-1 | | |



1

| | | | |
|--------------------|--|-----------------|-----------|
| Part No. | 110242 | Ref. No. | 531000300 |
| description | knob thermostat t.max. 180°C ø 50mm shaft ø 6x4.6mm shaft flat upper black temperature range 100-180°C | | |
| For models: | FEC-4 | | |



1

| | | | |
|--------------------|---|-----------------|-----------|
| Part No. | 110743 | Ref. No. | 536002000 |
| description | knob time 15min ø 44mm shaft ø 6x3.5mm shaft flat on both sides black | | |
| For models: | TS-3, TS-6 | | |



1

| | | | |
|---|---|-----------------|---------------------------|
| Part No. | 111730 | Ref. No. | 536019900 |
| description | knob without symbol ø 70mm LOTUS shaft ø 10x8mm | | |
| For models: | BRF-98G, CPB-98G | | |
| accessories for | 111730 | | |
|  | Part No. | 110565 | Ref. No. 539018500 |
| | knob dial plate switch 7-position t.max. °C red | | |

Table continues overleaf



| accessories for | | 111730 | |
|-----------------|--|--------|--------------------|
| | Part No. | 110566 | Ref. No. 539018600 |
| | knob dial plate thermostat t.max. 110°C 30-110°C rotation 270° red | | |
| | Part No. | 110579 | Ref. No. 539022600 |
| | knob dial plate gas tap with ignition flame t.max.°C°C red | | |
| | Part No. | 110584 | Ref. No. 539018500 |
| | knob dial plate energy regulator 1-6 t.max.°C°C turn direction clockwise ED ø 63mm ID ø 45.5mm red | | |
| | Part No. | 110585 | Ref. No. 539016400 |
| | knob dial plate thermostat t.max. 180°C 100-180°C rotation 270° ED ø 63mm ID ø 45.5mm red | | |
| | Part No. | 110586 | Ref. No. 539018200 |
| | knob dial plate thermostat t.max. 90°C 30-90°C rotation 270° ED ø 63mm ID ø 45.5mm red | | |
| | Part No. | 110587 | Ref. No. 539018300 |
| | knob dial plate thermostat t.max. 300°C 50-300°C rotation 270° ED ø 64mm ID ø 45.5mm red | | |
| | Part No. | 110588 | Ref. No. 539018400 |
| | knob dial plate thermostat t.max. 300°C 50-300°C rotation 310° ED ø 63mm ID ø 45.5mm red | | |
| | Part No. | 110589 | Ref. No. 539018000 |
| | knob dial plate energy regulator 0-6 2-circuit t.max.°C°C ED ø 63mm ID ø 45.5mm red | | |
| | Part No. | 110600 | Ref. No. 539008100 |
| | knob dial plate gas thermostat t.max. 300°C 150-300°C ED ø 63mm ID ø 45.5mm silver | | |
| | Part No. | 110646 | Ref. No. 539023400 |
| | knob dial plate time 120min t.max.°C°C ED ø 63mm ID ø 45.5mm silver | | |
| | Part No. | 110647 | Ref. No. 539017900 |
| | knob dial plate silver thermostat t.max. 300°C 50-300°C rotation 310° ED ø 63mm ID ø 45.5mm | | |
| | Part No. | 110648 | Ref. No. 539022900 |
| | knob dial plate gas thermostat t.max. 300°C 60-300°C ED ø 63mm ID ø 45.5mm red | | |
| | Part No. | 110649 | Ref. No. 539023200 |
| | knob dial plate gas thermostat t.max. 250°C ED ø 63mm ID ø 45.5mm silver | | |
| | Part No. | 110668 | Ref. No. 539023000 |
| | knob dial plate gas thermostat tail t.max.°C°C ED ø 63mm ID ø 45.5mm red | | |
| | Part No. | 110669 | Ref. No. 539022800 |
| | knob dial plate gas thermostat t.max. 90°C ED ø 63mm ID ø 45.5mm red | | |
| | Part No. | 110670 | Ref. No. 539022700 |
| | knob dial plate gas thermostat t.max. 190°C ED ø 63mm ID ø 45.5mm red | | |
| | Part No. | 110876 | Ref. No. 539022500 |
| | knob dial plate gas tap without ignition flame t.max.°C°C red | | |
| | Part No. | 111727 | Ref. No. 539023201 |
| | knob dial plate gas thermostat t.max. 275°C silver | | |
| | Part No. | 111728 | Ref. No. 539023600 |
| | knob dial plate time 120min t.max.°C°C silver | | |
| | Part No. | 111729 | Ref. No. 539008200 |
| | knob dial plate gas thermostat t.max. 300°C 150-300°C ED ø 63mm ID ø 45.5mm red | | |

| accessories for | | 111726 | |
|-----------------|--|--------|--------------------|
| | Part No. | 110565 | Ref. No. 539018500 |
| | knob dial plate switch 7-position t.max.°C°C red | | |
| | Part No. | 110566 | Ref. No. 539018600 |
| | knob dial plate thermostat t.max. 110°C 30-110°C rotation 270° red | | |
| | Part No. | 110579 | Ref. No. 539022600 |
| | knob dial plate gas tap with ignition flame t.max.°C°C red | | |
| | Part No. | 110584 | Ref. No. 539018500 |
| | knob dial plate energy regulator 1-6 t.max.°C°C turn direction clockwise ED ø 63mm ID ø 45.5mm red | | |
| | Part No. | 110585 | Ref. No. 539016400 |
| | knob dial plate thermostat t.max. 180°C 100-180°C rotation 270° ED ø 63mm ID ø 45.5mm red | | |
| | Part No. | 110586 | Ref. No. 539018200 |
| | knob dial plate thermostat t.max. 90°C 30-90°C rotation 270° ED ø 63mm ID ø 45.5mm red | | |
| | Part No. | 110587 | Ref. No. 539018300 |
| | knob dial plate thermostat t.max. 300°C 50-300°C rotation 270° ED ø 64mm ID ø 45.5mm red | | |
| | Part No. | 110588 | Ref. No. 539018400 |
| | knob dial plate thermostat t.max. 300°C 50-300°C rotation 310° ED ø 63mm ID ø 45.5mm red | | |
| | Part No. | 110589 | Ref. No. 539018000 |
| | knob dial plate energy regulator 0-6 2-circuit t.max.°C°C ED ø 63mm ID ø 45.5mm red | | |
| | Part No. | 110600 | Ref. No. 539008100 |
| | knob dial plate gas thermostat t.max. 300°C 150-300°C ED ø 63mm ID ø 45.5mm silver | | |
| | Part No. | 110644 | Ref. No. 539023500 |
| | knob dial plate thermostat t.max. 250°C 50-250°C ED ø 63mm ID ø 45.5mm silver | | |
| | Part No. | 110645 | Ref. No. 539023300 |
| | knob dial plate program switch t.max.°C°C ED ø 63mm ID ø 45.5mm silver | | |
| | Part No. | 110646 | Ref. No. 539023400 |
| | knob dial plate time 120min t.max.°C°C ED ø 63mm ID ø 45.5mm silver | | |
| | Part No. | 110647 | Ref. No. 539017900 |
| | knob dial plate silver thermostat t.max. 300°C 50-300°C rotation 310° ED ø 63mm ID ø 45.5mm | | |

Table continues overleaf





| accessories for | | 111726 | |
|-----------------|---|--------|--------------------|
| | Part No. | 110648 | Ref. No. 539022900 |
| | knob dial plate gas thermostat t.max. 300°C ED ø 63mm ID ø 45.5mm red | | |
| | Part No. | 110649 | Ref. No. 539023200 |
| | knob dial plate gas thermostat t.max. 250°C ED ø 63mm ID ø 45.5mm silver | | |
| | Part No. | 110668 | Ref. No. 539023000 |
| | knob dial plate gas thermostat tail t.max.°C ED ø 63mm ID ø 45.5mm red | | |
| | Part No. | 110669 | Ref. No. 539022800 |
| | knob dial plate gas thermostat t.max. 90°C ED ø 63mm ID ø 45.5mm red | | |
| | Part No. | 110670 | Ref. No. 539022700 |
| | knob dial plate gas thermostat t.max. 190°C ED ø 63mm ID ø 45.5mm red | | |
| | Part No. | 110876 | Ref. No. 539022500 |
| | knob dial plate gas tap without ignition flame t.max.°C red | | |
| | Part No. | 111727 | Ref. No. 539023201 |
| | knob dial plate gas thermostat t.max. 275°C silver | | |
| | Part No. | 111728 | Ref. No. 539023600 |
| | knob dial plate time 120min t.max.°C silver | | |
| | Part No. | 111729 | Ref. No. 539008200 |
| | knob dial plate gas thermostat t.max. 300°C 150-300°C ED ø 63mm ID ø 45.5mm red | | |

| | | | |
|---|---|-----------------|--------------------|
|  | | | |
| 1 | | | |
| Part No. | 111725 | Ref. No. | 536019800 |
| description | knob without symbol ø 70mm LOTUS shaft ø 8x6.5mm | | |
| For models: | BM-74G, BM-78G, BM-94G, BM-98G, BMT-94G, BMT-98G, BRF-64G, BRF-74G, BRF-78G, BRF-94G, BRT-66G, CF2-58G, CF2-58GE, CF2-68G, CF2-68GEM, CF3-512GEV, CF3-512GV, CF3-612GEMV, CF3-612GV, CF4-68G, CF4-68GEM, CF4-78G, CF4-78GE, CF4-78GP, CF4-78GPE, CF4-98G, CF4-98GE, CF6-610G, CF6-610GEM, CF6-712G, CF6-712GEV, CF6-712GP, CF6-712GPEV, CF6-712GPV, CF6-712GV, CF6-912G, CF6-912GE, CF6-912GEV, CF6-912GV, CF-712GE, CF-712GPE, CF8-916G, CF8-916GE, CF8-916GEV, CF8-916GV, CFM2-68GEM, CFM3-612GEMV, CFM4-66GEM, CFM4-68GEM, CFM6-610GEM...(Other models you can see in the webshop) | | |
| accessories for | | 111725 | |
| | Part No. | 110565 | Ref. No. 539018500 |
| | knob dial plate switch 7-position t.max.°C red | | |
| | Part No. | 110566 | Ref. No. 539018600 |
| | knob dial plate thermostat t.max. 110°C 30-110°C rotation 270° red | | |
| | Part No. | 110579 | Ref. No. 539022600 |
| | knob dial plate gas tap with ignition flame t.max.°C red | | |
| | Part No. | 110584 | Ref. No. 539018500 |
| | knob dial plate energy regulator 1-6 t.max.°C turn direction clockwise ED ø 63mm ID ø 45.5mm red | | |
| | Part No. | 110585 | Ref. No. 539016400 |
| | knob dial plate thermostat t.max. 180°C 100-180°C rotation 270° ED ø 63mm ID ø 45.5mm red | | |

| accessories for | | 111725 | |
|-----------------|---|--------|--------------------|
| | Part No. | 110586 | Ref. No. 539018200 |
| | knob dial plate thermostat t.max. 90°C 30-90°C rotation 270° ED ø 63mm ID ø 45.5mm red | | |
| | Part No. | 110587 | Ref. No. 539018300 |
| | knob dial plate thermostat t.max. 300°C 50-300°C rotation 270° ED ø 64mm ID ø 45.5mm red | | |
| | Part No. | 110588 | Ref. No. 539018400 |
| | knob dial plate thermostat t.max. 300°C 50-300°C rotation 310° ED ø 63mm ID ø 45.5mm red | | |
| | Part No. | 110589 | Ref. No. 539018000 |
| | knob dial plate energy regulator 0-6 2-circuit t.max.°C ED ø 63mm ID ø 45.5mm red | | |
| | Part No. | 110600 | Ref. No. 539008100 |
| | knob dial plate gas thermostat t.max. 300°C 150-300°C ED ø 63mm ID ø 45.5mm silver | | |
| | Part No. | 110644 | Ref. No. 539023500 |
| | knob dial plate thermostat t.max. 250°C 50-250°C ED ø 63mm ID ø 45.5mm silver | | |
| | Part No. | 110645 | Ref. No. 539023300 |
| | knob dial plate program switch t.max.°C ED ø 63mm ID ø 45.5mm silver | | |
| | Part No. | 110646 | Ref. No. 539023400 |
| | knob dial plate time 120min t.max.°C ED ø 63mm ID ø 45.5mm silver | | |
| | Part No. | 110647 | Ref. No. 539017900 |
| | knob dial plate silver thermostat t.max. 300°C 50-300°C rotation 310° ED ø 63mm ID ø 45.5mm | | |
| | Part No. | 110648 | Ref. No. 539022900 |
| | knob dial plate gas thermostat t.max. 300°C 60-300°C ED ø 63mm ID ø 45.5mm red | | |
| | Part No. | 110649 | Ref. No. 539023200 |
| | knob dial plate gas thermostat t.max. 250°C ED ø 63mm ID ø 45.5mm silver | | |
| | Part No. | 110668 | Ref. No. 539023000 |
| | knob dial plate gas thermostat tail t.max.°C ED ø 63mm ID ø 45.5mm red | | |
| | Part No. | 110669 | Ref. No. 539022800 |
| | knob dial plate gas thermostat t.max. 90°C ED ø 63mm ID ø 45.5mm red | | |
| | Part No. | 110670 | Ref. No. 539022700 |
| | knob dial plate gas thermostat t.max. 190°C ED ø 63mm ID ø 45.5mm red | | |
| | Part No. | 110876 | Ref. No. 539022500 |
| | knob dial plate gas tap without ignition flame t.max.°C red | | |
| | Part No. | 111727 | Ref. No. 539023201 |
| | knob dial plate gas thermostat t.max. 275°C silver | | |
| | Part No. | 111728 | Ref. No. 539023600 |
| | knob dial plate time 120min t.max.°C silver | | |
| | Part No. | 111729 | Ref. No. 539008200 |
| | knob dial plate gas thermostat t.max. 300°C 150-300°C ED ø 63mm ID ø 45.5mm red | | |





| | | | |
|---|---|-----------------|-----------|
|  | | | |
| 1 | | | |
| Part No. | 110589 | Ref. No. | 539018000 |
| description | knob dial plate energy regulator 0-6 2-circuit t.max. °C°C ED ø 63mm ID ø 45.5mm red | | |
| For models: | CFC4-78ET, CFC4-8ET, CFC4-98ET, CFMC4-66ET, PCC-4EM, PCC-4EMX, PCC-4ET, PCC-6EM, PCC-6EMX, PCC-6ET, PCC-74ET, PCC-78ET, PCC-8EMX, PCC-8ET, PCC-94ET, PCC-98ET, PCCT-63ET, PCCT-66ET, PCCT-74ET, PCCT-78ET, PCCT-94ET, PCCT-98ET | | |

| | | | |
|---|--|-----------------|-----------|
|  | | | |
| 1 | | | |
| Part No. | 110584 | Ref. No. | 539018500 |
| description | knob dial plate energy regulator 1-6 t.max. °C°C turn direction clockwise ED ø 63mm ID ø 45.5mm red | | |
| For models: | CFC4-78ET, CFC4-8ET, FTC-74ET, FTC-78ET, FTC-94ET, FTC-98ET, FTCT-64ET, FTCT-66ET, FTCT-74ET, FTCT-78ET, FTCT-94ET, FTCT-98ET, PCC-4EM, PCC-4EMX, PCC-4ET, PCC-6EM, PCC-6EMX, PCC-6ET, PCC-74ET, PCC-78ET, PCC-8EMX, PCC-8ET, PCI-74ET, PCI-78ET, PCI-94ET, PCI-98ET, PCIT-64ET, PCIT-74ET, PCIT-78ET, PCIT-94ET, PCIT-98ET, PCIW-4ET, PCIW-74ET, PCIW-94ET, PCIWT-64ET, PCIWT-74ET, PCIWT-94ET, SA-400EM, SA-400EMX, SA-600EM, SA-600EMX, SA-600ET, SA-600ETX, SL-600, SL-600EM, SL-600EMX, SL-600ET, SL-600ETX, SL-600X, SLC-600EM...(Other models you can see in the webshop) | | |

| | | | |
|---|---|-----------------|-----------|
|  | | | |
| 1 | | | |
| Part No. | 110579 | Ref. No. | 539022600 |
| description | knob dial plate gas tap with ignition flame t.max. °C°C red | | |
| For models: | BR-6G, BRT-66G, CF2-58G, CF2-58GE, CF2-68G, CF2-68GEM, CF3-512GEV, CF3-512GV, CF3-612GEMV, CF3-612GV, CF4-78GP, CF4-78GPE, CF4-98G, CF4-98GE, CF6-712GP, CF6-712GPEV, CF6-712GPV, CF6-912G, CF6-912GE, CF6-912GEV, CF6-912GV, CF-712GPE, CF8-916G, CF8-916GE, CF8-916GEV, CF8-916GV, CFM2-68GEM, CFM3-612GEMV, CP-66G, CP-74G, CP-76G, CP-78G, CP-94G, CP-98G, CPB-98G, CPM-6G, CPT-64G, CPT-66G, CW-4G, CW-6G, CW-74G, CW-78G, CW-94G, CW-98G, CWT-64G, CWT-66G, CWT-68G, CWT-94G, CWT-98G, PC1T-64G...(Other models you can see in the webshop) | | |

| | | | |
|---|---|-----------------|-----------|
|  | | | |
| 1 | | | |
| Part No. | 110876 | Ref. No. | 539022500 |
| description | knob dial plate gas tap without ignition flame t.max. °C°C red | | |
| For models: | CF4-68G, CF4-68GEM, CF4-78ET, CF4-78G, CF4-78GE, CF4-8G, CF4-8GEM, CF4-GEMS, CF6-610G, CF6-610GEM, CF6-712ET, CF6-712ETV, CF6-712G, CF6-712GEV, CF6-712GV, CF-712GE, CFM4-66GEM, CFM4-68GEM, CFM6-610GEM, CFQ4-78ET, CFQ6-712ET, CFQ6-712ETV, F-1G, FB-1G, FO-1G, FO-2G, FO-3G, FOS-1G, FOS-2G, FOS-3G, PC-12G, PC-4G, PC-712ET, PC-712G, PC-716G, PC-74ET, PC-74G, PC-78ET, PC-78G, PC-8G, PCQ-712ET, PCQ-74ET, PCQ-78ET, PCT-63G, PCT-66G, TP2-712G, TPF2-712G, TPF2-712GV, TPF4-610G | | |

| | | | |
|--|---|-----------------|-----------|
|  | | | |
| 1 | | | |
| Part No. | 110670 | Ref. No. | 539022700 |
| description | knob dial plate gas thermostat t.max. 190°C ED ø 63mm ID ø 45.5mm red | | |
| For models: | F11-54G, F13-64G, F13-74G, F13T-74G, F13T-94G, F18-74G, F2-13-78G, F2-13T-78G, F2-13T-98G, F2-18-78G, F2-8-74G, F2-8-94G, F2-8T-66G, F2-8T-94G, F8T-63G, FP-6G, FQ-4G, FQ-6G, FQM-4G, FTL-712G, FTL-712GS, FTL-74G, FTL-74GS, FTL-76G, FTL-76GS, FTL-78G, FTL-78GS, FTLR-712G, FTLR-712GS, FTLR-76G, FTLR-76GS, FTLR-78G, FTLR-78GS, FTR-712G, FTR-712GS, FTR-74G, FTR-74GS, FTR-76G, FTR-76GS, FTR-78G, FTR-78GS | | |

| | | | |
|--|--|-----------------|-----------|
|  | | | |
| 1 | | | |
| Part No. | 110649 | Ref. No. | 539023200 |
| description | knob dial plate gas thermostat t.max. 250°C ED ø 63mm ID ø 45.5mm silver | | |
| For models: | CF4-8G, CF4-8GEM | | |

| | | | |
|---|--|-----------------|-----------|
|  | | | |
| 1 | | | |
| Part No. | 111727 | Ref. No. | 539023201 |
| description | knob dial plate gas thermostat t.max. 275°C silver | | |
| For models: | CF-10G6-A, CF-10G-6F, CF-10G-A, CF-10GF, CF2-58G, CF2-68G, CF3-512GV, CF3-612GV, CF4-68G, CF4-8G, CF6-610G, CF-8G-A, CF-8GF, TPF4-610G | | |

| | | | |
|--|---|-----------------|-----------|
|  | | | |
| 1 | | | |
| Part No. | 111729 | Ref. No. | 539008200 |
| description | knob dial plate gas thermostat t.max. 300°C 150-300°C ED ø 63mm ID ø 45.5mm red | | |
| For models: | BRF-64G, BRF-74G, BRF-78G, BRF-94G, BRF-98G | | |

1

| | | | |
|--------------------|---|-----------------|-----------|
| Part No. | 110600 | Ref. No. | 539008100 |
| description | knob dial plate gas thermostat t.max. 300°C 150-300°C ED ø 63mm ID ø 45.5mm silver | | |
| For models: | CF4-78G, CF4-78GP, CF4-98G, CF6-712G, CF6-712GP, CF6-712GPV, CF6-712GV, CF6-912G, CF6-912GV, CF8-916G, CF8-916GV, TPF2-712G, TPF2-712GPV, TPF2-712GV, TPF2-912G, TPF2-912GE, TPF2-912GV, TPF2-98G, TPF4-712GP, TPF4-712GPV, TPF4-912G, TPF4-912GV, TPF-78G, TPF-98G | | |



1

| | | | |
|--------------------|--|-----------------|-----------|
| Part No. | 110645 | Ref. No. | 539023300 |
| description | knob dial plate program switch t.max.°C°C ED ø 63mm ID ø 45.5mm silver | | |
| For models: | CF4-8ET, CF4-8GEM, CF-62EM, CF-62EM-A, CF-62ET, CF-62ET-A, CF-62GEM, CF-62GEM-A, CFC4-8ET, CFC-62EM, CFC-62ET, CFM-10EM, CFM-10EM-6, CFM-10EM-A, CFM-10ET, CFM-10ET-6, CFM-10ET-A, CFM-10GEM, CFM-10GEM-6, CFM-10GEM6-A, CFM-10GEM-A, CFM-8EM, CFM-8EM-A, CFM-8ET, CFM-8ET-A, CFM-8GEM, CFM-8GEM-A | | |



1

| | | | |
|--------------------|---|-----------------|-----------|
| Part No. | 110648 | Ref. No. | 539022900 |
| description | knob dial plate gas thermostat t.max. 300°C 60-300°C ED ø 63mm ID ø 45.5mm red | | |
| For models: | FTL-4G, FTL-4GS, FTL-6G, FTL-6GS, FTL-712G, FTL-712GS, FTL-74G, FTL-74GS, FTL-78G, FTL-78GS, FTL-8G, FTL-8GS, FTL-94G, FTL-94GS, FTL-98G, FTL-98GS, FTLR-6G, FTLR-6GS, FTLR-712G, FTLR-712GS, FTLR-78G, FTLR-78GS, FTLR-8G, FTLR-8GS, FTLR-98G, FTLR-98GS, FTR-4G, FTR-4GS, FTR-54G, FTR-6G, FTR-6GS, FTR-712G, FTR-712GS, FTR-74G, FTR-74GS, FTR-78G, FTR-78GS, FTR-8G, FTR-8GS, FTR-94G, FTR-94GS, FTR-98G, FTR-98GS, FTTL-610G, FTTL-610GS, FTTL-64G, FTTL-64GS, FTTL-66G, FTTL-66GS, FTTL-68G...(Other models you can see in the webshop) | | |



1

| | | | |
|--------------------|---|-----------------|-----------|
| Part No. | 110647 | Ref. No. | 539017900 |
| description | knob dial plate silver thermostat t.max. 300°C 50-300°C rotation 310° ED ø 63mm ID ø 45.5mm | | |
| For models: | CF4-78ET, CF4-78GE, CF4-78GPE, CF4-98ET, CF4-98GE, CF6-712ET, CF6-712ETV, CF6-712ETVX, CF6-712GEV, CF6-712GPEV, CF6-912ET, CF6-912ETV, CF6-912ETVX, CF6-912GE, CF6-912GEV, CF-712GE, CF-712GPE, CF8-916ET, CF8-916ETV, CF8-916GE, CF8-916GEV, CFC4-78ET, CFC4-98ET, CFQ4-78ET, CFQ4-98ET, CFQ6-712ET, CFQ6-712ETV, CFQ6-712ETVX, CFQ6-912ET, CFQ6-912ETV, CFQ6-912ETVX, CFQ8-916ETV, CFQ9-916ET, TPF2-712GP, TPF2-712GPE, TPF2-712GPEV, TPF2-78GP, TPF2-78GPE, TPF2-912GEV, TPF2-98GE, TPF4-712GPE, TPF4-712GPEV, TPF4-912GE, TPF4-912GEV, TPF-78ET, TPF-78GE, TPF-98ET, TPF-98GE | | |



1

| | | | |
|--------------------|---|-----------------|-----------|
| Part No. | 110669 | Ref. No. | 539022800 |
| description | knob dial plate gas thermostat t.max. 90°C ED ø 63mm ID ø 45.5mm red | | |
| For models: | BM-4G, BM-6G, BM-74G, BM-78G, BM-8G, BM-94G, BM-98G, BMT-64G, BMT-66G, BMT-94G, BMT-98G | | |



1

| | | | |
|--------------------|---|-----------------|-----------|
| Part No. | 110561 | Ref. No. | 539018100 |
| description | knob dial plate switch 7-position t.max.°C°C red | | |
| For models: | CF4-68ET, CF4-78ET, CF4-8ET, CF4-8ETS, CF4-98ET, CF6-610ET, CF6-712ET, CF6-712ETV, CF6-712ETVX, CF6-912ET, CF6-912ETV, CF6-912ETVX, CF8-916ET, CF8-916ETV, CFM4-66ET, CFM4-68ET, CFM6-610ET, CFQ4-78ET, CFQ4-98ET, CFQ6-712ET, CFQ6-712ETV, CFQ6-712ETVX, CFQ6-912ET, CFQ6-912ETV, CFQ6-912ETVX, CFQ8-916ETV, CFQ9-916ET, PC-10ET, PC-10ETX, PC-4EM, PC-4ET, PC-4ETX, PC-6EM, PC-6ET, PC-6ETX, PC-712ET, PC-74ET, PC-78ET, PC-8ET, PC-8ETX, PC-912ET, PC-916ET, PC-94ET, PC-98ET, PCQ-712ET, PCQ-74ET, PCQ-78ET, PCQ-912ET, PCQ-916ET, PCQ-94ET...(Other models you can see in the webshop) | | |



1

| | | | |
|--------------------|--|-----------------|-----------|
| Part No. | 110668 | Ref. No. | 539023000 |
| description | knob dial plate gas thermostat tail t.max.°C°C ED ø 63mm ID ø 45.5mm red | | |
| For models: | CP-6G | | |

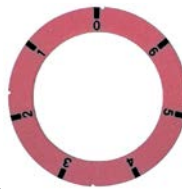

1

| | | | |
|--------------------|--|-----------------|-----------|
| Part No. | 110565 | Ref. No. | 539018500 |
| description | knob dial plate switch 7-position t.max.°C°C red | | |

1

| | | | |
|--------------------|--|-----------------|-----------|
| Part No. | 110566 | Ref. No. | 539018600 |
| description | knob dial plate thermostat t.max. 110°C 30-110°C rotation 270° red | | |
| For models: | CP-4ET, CP-4ETX, CP-6ET, CP-6ETX, CP-74ET, CP-78ET, CP-94ET, CP-98ET | | |



1

| | | | |
|--------------------|---|-----------------|-----------|
| Part No. | 110585 | Ref. No. | 539016400 |
| description | knob dial plate thermostat t.max. 180°C 100-180°C rotation 270° ED ø 63mm ID ø 45.5mm red | | |
| For models: | F10T-63EM, F10T-63ET, F13-64ET, F13-74ET, F13T-74E, F13T-94ET, F18-74ET, F18-94ET, F18-94ETX, F18-94G, F2-10T-66EM, F2-10T-66ET, F2-13-78ET, F2-13-98ET, F2-13T-78E, F2-18-78ET, F2-18-98ET, F2-18-98ETX, F2-18-98G, F2-25-98ET, F2-25-98ETX, F2-25-98G, F25-94ET, F25-94ETX, F25-94G, F2-8-74ET, F2-8-94ET, F2-8T-74ET, F2-8T-94ET, F45-78ET, F45-78G, FE-10, FE2-10, FE-2-8, FE-8, FEM-2-6, FEM-6, FME-10, FME-15, FME-2-10, FME-2-15, FMPE-20, FMPE-25, FMPE-30, FP-6ET, FPE-20, FPE-25, FQ-4EM, FQ-4ET, FQ-4ETX...(Other models you can see in the webshop) | | |



1

| | | | |
|--------------------|--|-----------------|-----------|
| Part No. | 110644 | Ref. No. | 539023500 |
| description | knob dial plate thermostat t.max. 250°C 50-250°C ED ø 63mm ID ø 45.5mm silver | | |
| For models: | CF4-8ET, CF4-8GEM, CF-62EM, CF-62EM-A, CF-62ET, CF-62ET-A, CF-62GEM, CF-62GEM-A, CFC4-8ET, CFC-62EM, CFC-62ET, CFM-10EM, CFM-10EM-6, CFM-10EM-A, CFM-10ET, CFM-10ET-6, CFM-10ET-A, CFM-10GEM, CFM-10GEM-6, CFM-10GEM6-A, CFM-10GEM-A, CFM-8EM, CFM-8EM-A, CFM-8ET, CFM-8ET-A, CFM-8GEM, CFM-8GEM-A | | |



1

| | | | |
|--------------------|--|-----------------|-----------|
| Part No. | 110587 | Ref. No. | 539018300 |
| description | knob dial plate thermostat t.max. 300°C 50-300°C rotation 270° ED ø 64mm ID ø 45.5mm red | | |
| For models: | BRF-78ET, BRF-98ET, FTC-4EM, FTC-4EMX, FTC-4ET, FTC-6EM, FTC-6EMX, FTC-6ET, FTC-8EMX, FTC-8ET, FTL-4EM, FTL-4EMS, FTL-6EM, FTL-6EMS, FTL-8EM, FTL-8EMS, FTLR-6EM, FTLR-6EMS, FTLR-8EM, FTLR-8EMS, FTR-4EM, FTR-4EMS, FTR-6EM, FTR-6EMS | | |



1

| | | | |
|--------------------|--|-----------------|-----------|
| Part No. | 110588 | Ref. No. | 539018400 |
| description | knob dial plate thermostat t.max. 300°C 50-300°C rotation 310° ED ø 63mm ID ø 45.5mm red | | |
| For models: | BR-6ET, BR-6ETX, BRF-64ET, BRF-74ET, BRF-94ET, BRT-66ET, CW-4ET, CW-4ETX, CW-6ET, CW-6ETX, CW-74ET, CW-78ET, CW-94ET, CW-98ET, CWT-64ET, CWT-66ET, CWT-68ET, CWT-74ET, CWT-78ET, CWT-94ET, CWT-98ET, FTL-4ET, FTL-4ETS, FTL-4ETX, FTL-6ET, FTL-6ETS, FTL-6ETX, FTL-712ET, FTL-712ETS, FTL-74ET, FTL-74ETS, FTL-76ET, FTL-76ETS, FTL-78ET, FTL-78ETS, FTL-8ET, FTL-8ETS, FTL-8ETX, FTL-94ET, FTL-94ETS, FTL-94ETX, FTL-98ET, FTL-98ETS, FTL-98ETX, FTLR-6ET, FTLR-6ETS, FTLR-6ETX, FTLR-712ET, FTLR-712ETS, FTLR-76ET...(Other models you can see in the webshop) | | |



1

| | | | |
|--------------------|---|-----------------|-----------|
| Part No. | 110586 | Ref. No. | 539018200 |
| description | knob dial plate thermostat t.max. 90°C 30-90°C rotation 270° ED ø 63mm ID ø 45.5mm red | | |
| For models: | BM-10EM, BM-10EMX, BM-4EM, BM-4EMX, BM-6EM, BM-6EMX, BM-74EM, BM-74ET, BM-78EM, BM-78ET, BM-8EM, BM-8EMX, BM-94EM, BM-98EM, BMT-63EM, BMT-64EM, BMT-66EM, BMT-74EM, BMT-78EM, BMT-94EM, BMT-98EM, BS-4EM, BS-4EMX, BS-74EM, BS-94EM, BST-64EM, BST-74EM, BST-94EM | | |



1

| | | | |
|--------------------|---|-----------------|-----------|
| Part No. | 110646 | Ref. No. | 539023400 |
| description | knob dial plate time 120min t.max. °C ED ø 63mm ID ø 45.5mm silver | | |
| For models: | CF-10EM, CF-10EM-6, CF-10EM-A, CF-10ET, CF-10ET-6, CF-10ET-A, CF-10GEM, CF-10GEM-6, CF-10GEM6-A, CF-10GEM-A, CF4-68ET, CF4-68GEM, CF4-8ET, CF4-8ETS, CF4-8GEM, CF4-GEMS, CF-62EM, CF-62EM-A, CF-62ET, CF-62ET-A, CF-62GEM, CF-62GEM-A, CF6-610ET, CF6-610GEM, CF-8EM, CF-8EM-A, CF-8ET, CF-8ET-A, CF-8GEM, CF-8GEM-A, CFC4-8ET, CFC-62EM, CFC-62ET, CFM-10EM, CFM-10EM-6, CFM-10EM-A, CFM-10ET, CFM-10ET-6, CFM-10ET-A, CFM-10GEM, CFM-10GEM-6, CFM-10GEM6-A, CFM-10GEM-A, CFM2-68GEM, CFM3-612GEMV, CFM4-66ET, CFM4-66GEM, CFM4-68ET, CFM4-68GEM, CFM6-610ET...(Other models you can see in the webshop) | | |



1

| | | | |
|--------------------|--|-----------------|-----------|
| Part No. | 111728 | Ref. No. | 539023600 |
| description | knob dial plate time 120min t.max.°C silver | | |
| For models: | CF2-58G, CF2-58GE, CF2-68G, CF2-68GEM, CF3-512GEV, CF3-512GV, CF3-612GEMV, CF3-612GV, CF4-68G, CF4-78ET, CF4-78G, CF4-78GE, CF4-78GP, CF4-8G, CF4-8GEM, CF4-98G, CF6-610G, CF6-712ET, CF6-712ETV, CF6-712ETVX, CF6-712G, CF6-712GEV, CF6-712GP, CF6-712GPV, CF6-712GV, CF6-912G, CF6-912GV, CF-712GE, CF8-916G, CF8-916GV, CFC4-78ET, CFQ4-78ET, CFQ6-712ET, CFQ6-712ETV, CFQ6-712ETVX, TPF2-712G, TPF2-712GPV, TPF2-712GV, TPF2-912G, TPF2-912GE, TPF2-912GV, TPF2-98G, TPF4-610G, TPF4-712GP, TPF4-712GPV, TPF4-912G, TPF4-912GV, TPF-78G, TPF-78GE, TPF-98G | | |

2

| | | | |
|--------------------|---|-----------------|-----------|
| Part No. | 110072 | Ref. No. | 539016400 |
| description | symbol thermostat t.max. 190°C 110-190°C LOTUS rotation 270° turn direction right ED ø 64mm ID ø 45.5mm red | | |

handles and hand wheels

hand wheels

hand wheels

1

| | | | |
|--------------------|--|-----------------|-----------|
| Part No. | 692443 | Ref. No. | SMB013600 |
| description | hand wheel ø 150mm D1 ø 38mm bore ø 14mm thread groove width 6mm groove depth 13mm mounting distance 18mm L1 40mm L2 43mm handle length 65mm with folding handle | | |

1

| | | | |
|--------------------|--|-----------------|-----------|
| Part No. | 692430 | Ref. No. | SMB063600 |
| description | hand wheel ø 200mm D1 ø 50mm bore ø 20mm thread groove width 6mm groove depth 13mm mounting distance 30mm L1 47mm L2 50mm handle length 90mm with folding handle | | |

cone handles

1

| | | | |
|--------------------|---|-----------------|-----------|
| Part No. | 110704 | Ref. No. | 536000300 |
| description | cone handle thread M6 ø 16mm L 25mm plastic black | | |

hinges

oven hinges

1

| | | | |
|--------------------|--|-----------------|-----------|
| Part No. | 700001 | Ref. No. | 531022900 |
| description | opposite support L 118mm W 17mm mounting distance 94mm | | |
| For models: | CF2-58G, CF2-58GE, CF2-68G, CF2-68GEM, CF3-512GEV, CF3-512GV, CF3-612GEMV, CF3-612GV, CF4-78ET, CF4-78ETX, CF4-78G, CF4-78GE, CF4-78GP, CF4-78GP-AUS, CF4-78GPE, CF4-78GP-USA, CF4-98ET, CF4-98ETX, CF4-98G, CF4-98GE, CF6-712ET, CF6-712ETV, CF6-712ETVX, CF6-712ETX, CF6-712G, CF6-712GEV, CF6-712GP, CF6-712GPE, CF6-712GPEV, CF6-712GPV, CF6-712GPV-USA, CF6-712GV, CF6-912ET, CF6-912ETV, CF6-912ETVX, CF6-912G, CF6-912GE, CF6-912GEV, CF6-912GV, CF-712GE, CF-712GPE, CF8-916ET, CF8-916ETV, CF8-916G, CF8-916GE, CF8-916GEV, CF8-916GV, CFA4-78G, CFA4-98G, CFA6-712GV...(Other models you can see in the webshop) | | |

1

| | | | |
|--------------------|--|-----------------|-----------|
| Part No. | 690031 | Ref. No. | 531007200 |
| description | opposite support oven hinge | | |
| For models: | CF-62EM, CF-62EM-A, CF-62ET, CF-62ET-A, CF-62GEM, CF-62GEM-A, CFC-62EM, CFC-62ET | | |



1

| | | | |
|--------------------|-----------------------------|-----------------|-----------|
| Part No. | 690036 | Ref. No. | 531008000 |
| description | opposite support oven hinge | | |



1

| | | | |
|--------------------|---|-----------------|-----------|
| Part No. | 701574 | Ref. No. | 531007301 |
| description | oven hinge mounting distance 112mm groove distance 9mm spring thickness 3.7mm spring length 75mm L 215mm W 22mm | | |
| For models: | CF-10EM, CF-10EM-6, CF-10EM-A, CF-10ET, CF-10ET-6, CF-10ET-A, CF-10G6-A, CF-10G-6F, CF-10G-A, CF-10GEM, CF-10GEM-6, CF-10GEM6-A, CF-10GEM-A, CF-10GF, CF4-8ET, CF4-8ETS, CF4-8G, CF4-8GEM, CF4-GEMS, CF-8EM, CF-8EM-A, CF-8ET, CF-8ET-A, CF-8G-A, CF-8GEM, CF-8GEM-A, CF-8GF, CFC4-8ET, CFM-10EM, CFM-10EM-6, CFM-10EM-A, CFM-10ET, CFM-10ET-6, CFM-10ET-A, CFM-10GEM, CFM-10GEM-6, CFM-10GEM6-A, CFM-10GEM-A, CFM-8EM, CFM-8EM-A, CFM-8ET, CFM-8ET-A, CFM-8GEM, CFM-8GEM-A | | |

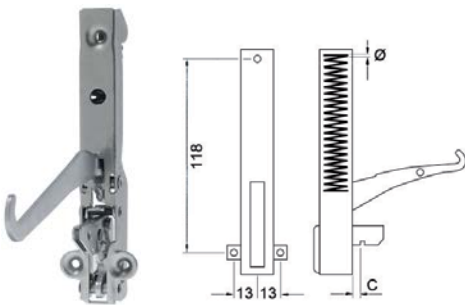

1

| | | | |
|------------------------|--|-----------------|-------------------|
| Part No. | 690030 | Ref. No. | 531007100 |
| description | oven hinge mounting distance 118mm lug mounting 13mm lever length 117mm groove distance 10mm spring thickness 3.5mm mounting ear position left/right spring length 60mm L 155mm W 21mm | | |
| For models: | CF-62EM, CF-62EM-A, CF-62ET, CF-62ET-A, CF-62GEM, CF-62GEM-A, CFC-62EM, CFC-62ET | | |
| accessories for | 690030 | | |
| | Part No. | 700003 | Ref. No. — |
| | opposite support L 110mm W 12mm mounting distance 94mm | | |

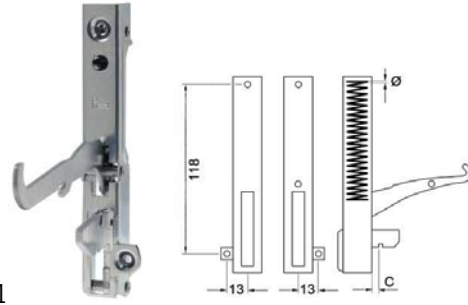

1

| | | | |
|------------------------|--|-----------------|-------------------|
| Part No. | 690034 | Ref. No. | 531007400 |
| description | oven hinge mounting distance 120mm lever length 130mm spring thickness 3mm L 155mm | | |
| accessories for | 690034 | | |
| | Part No. | 693045 | Ref. No. — |
| | opposite support L 110mm W 12mm mounting distance 94mm | | |
| | Part No. | 700003 | Ref. No. — |
| | opposite support L 110mm W 12mm mounting distance 94mm | | |

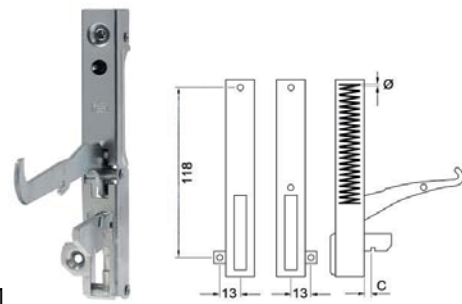

1

| | | | |
|------------------------|---|-----------------|-------------------|
| Part No. | 690035 | Ref. No. | 531005300 |
| description | oven hinge mounting distance 120mm lever length 130mm spring thickness 3mm L 155mm left | | |
| accessories for | 690035 | | |
| | Part No. | 693045 | Ref. No. — |
| | opposite support L 110mm W 12mm mounting distance 94mm | | |
| | Part No. | 700003 | Ref. No. — |
| | opposite support L 110mm W 12mm mounting distance 94mm | | |



| | | | |
|--------------------|---|-----------------|-----------|
| Part No. | 690032 | Ref. No. | 531007300 |
| description | oven hinge mounting distance 134mm lug mounting 12mm lever length 138mm groove distance 6mm spring thickness 3.5mm mounting ear position left/right spring length 64mm L 162mm W 20mm for glass door | | |
| For models: | CF-10EM, CF-10EM-6, CF-10EM-A, CF-10ET, CF-10ET-6, CF-10ET-A, CF-10G6-A, CF-10G-6F, CF-10G-A, CF-10GEM, CF-10GEM-6, CF-10GEM6-A, CF-10GEM-A, CF-10GF, CF4-8ET, CF4-8ETS, CF4-8G, CF4-8GEM, CF4-GEMS, CF-8EM, CF-8EM-A, CF-8ET, CF-8ET-A, CF-8G-A, CF-8GEM, CF-8GEM-A, CF-8GF, CFC4-8ET, CFM-10EM, CFM-10EM-6, CFM-10EM-A, CFM-10ET, CFM-10ET-6, CFM-10ET-A, CFM-10GEM, CFM-10GEM-6, CFM-10GEM6-A, CFM-10GEM-A, CFM-8EM, CFM-8EM-A, CFM-8ET, CFM-8ET-A, CFM-8GEM, CFM-8GEM-A | | |

| | | | | |
|------------------------|--|-----------------|-----------------|---|
| Part No. | 701573 | Ref. No. | 531059700 | |
| description | oven hinge mounting distance 142mm mounting distance 2mm lug mountingmm lever lengthmm groove distance 12mm spring thickness 3.3mm mounting ear position spring length 116mm L 170mm mounting pos. left/right W 22mm | | | |
| For models: | CF4-68ET, CF4-68ETX, CF4-68G, CF4-68GEM, CF6-610ET, CF6-610ETX, CF6-610G, CF6-610GEM, CFM2-68GEM, CFM3-612GEMV, CFM4-68ET, CFM4-68GEM, CFM6-610ET, CFM6-610GEM, MFM-610EM, TPF4-610G, TPF4-610GEM, TPFM4-610GEM | | | |
| accessories for | 701573 | | | |
| | Part No. | 701631 | Ref. No. | — |
| | opposite support mounting distance 119mm L 135mm W 12mm | | | |

| | | | |
|--------------------|--|-----------------|-----------|
| Part No. | 700390 | Ref. No. | 531007302 |
| description | oven hinge mounting distance 142mm mounting distance 2mm lug mountingmm lever lengthmm groove distance 12mm spring thickness 3mm mounting ear position spring length 116mm L 170mm mounting pos. left/right W 22mm | | |

| | | | | |
|------------------------|--|-----------------|-----------------|-----------|
| Part No. | 700006 | Ref. No. | 531022800 | |
| description | oven hinge mounting distance 173mm mounting distance 2 105mm lug mounting 14mm lever length 120mm groove distance 11mm spring thickness 3.5mm mounting ear position left spring length 112mm W 25mm | | | |
| For models: | CF2-58G, CF2-58GE, CF2-68G, CF2-68GEM, CF3-512GEV, CF3-512GV, CF3-612GEMV, CF3-612GV, CF4-78ET, CF4-78ETX, CF4-78G, CF4-78GE, CF4-78GP, CF4-78GP-AUS, CF4-78GPE, CF4-78GP-USA, CF4-98ET, CF4-98ETX, CF4-98G, CF4-98GE, CF6-712ET, CF6-712ETV, CF6-712ETVX, CF6-712ETX, CF6-712G, CF6-712GEV, CF6-712GP, CF6-712GPE, CF6-712GPEV, CF6-712GPV, CF6-712GPV-USA, CF6-712GV, CF6-912ET, CF6-912ETV, CF6-912ETVX, CF6-912G, CF6-912GE, CF6-912GEV, CF6-912GV, CF-712GE, CF-712GPE, CF8-916ET, CF8-916ETV, CF8-916G, CF8-916GE, CF8-916GEV, CF8-916GV, CFA4-78G, CFA4-98G, CFA6-712GV...(Other models you can see in the webshop) | | | |
| accessories for | 700006 | | | |
| | Part No. | 700001 | Ref. No. | 531022900 |
| | opposite support L 118mm W 17mm mounting distance 94mm | | | |
| | Part No. | 700007 | Ref. No. | 531022700 |
| | oven hinge mounting distance 173mm mounting distance 2 105mm lug mounting 14mm lever length 120mm groove distance 11mm spring thickness 3.5mm mounting ear position right spring length 112mm W 25mm | | | |

| | | | | |
|------------------------|--|-----------------|-----------------|-----------|
| Part No. | 700007 | Ref. No. | 531022700 | |
| description | oven hinge mounting distance 173mm mounting distance 2 105mm lug mounting 14mm lever length 120mm groove distance 11mm spring thickness 3.5mm mounting ear position right spring length 112mm W 25mm | | | |
| For models: | CF2-58G, CF2-58GE, CF2-68G, CF2-68GEM, CF3-512GEV, CF3-512GV, CF3-612GEMV, CF3-612GV, CF4-78ET, CF4-78ETX, CF4-78G, CF4-78GE, CF4-78GP, CF4-78GP-AUS, CF4-78GPE, CF4-78GP-USA, CF4-98ET, CF4-98ETX, CF4-98G, CF4-98GE, CF6-712ET, CF6-712ETV, CF6-712ETVX, CF6-712ETX, CF6-712G, CF6-712GEV, CF6-712GP, CF6-712GPE, CF6-712GPEV, CF6-712GPV, CF6-712GPV-USA, CF6-712GV, CF6-912ET, CF6-912ETV, CF6-912ETVX, CF6-912G, CF6-912GE, CF6-912GEV, CF6-912GV, CF-712GE, CF-712GPE, CF8-916ET, CF8-916ETV, CF8-916G, CF8-916GE, CF8-916GEV, CF8-916GV, CFA4-78G, CFA4-98G, CFA6-712GV...(Other models you can see in the webshop) | | | |
| accessories for | 700007 | | | |
| | Part No. | 700001 | Ref. No. | 531022900 |
| | opposite support L 118mm W 17mm mounting distance 94mm | | | |



| | | | |
|--------------------|---|-----------------|------------------|
| | | | |
| 1 | Part No. | Ref. No. | 531008200 |
| 690037 | | | |
| description | oven hinge mounting distance 205mm mounting distance 2mm lug mountingmm lever length 119mm groove distance 13mm spring thickness 4.3mm mounting ear position spring length 103mm L 214mm | | |
| For models: | CF-10EM, CF-10EM-6, CF-10EM-A, CF-10ET, CF-10ET-6, CF-10ET-A, CF-10G6-A, CF-10G6-F, CF-10G-A, CF-10GEM, CF-10GEM-6, CF-10GEM6-A, CF-10GEM-A, CF-10GF, CF4-8ET, CF4-8ETS, CF4-8G, CF4-8GEM, CF4-GEMS, CF-8EM, CF-8EM-A, CF-8ET, CF-8ET-A, CF-8G-A, CF-8GEM, CF-8GEM-A, CF-8GF, CFC4-8ET, CFM-10EM, CFM-10EM-6, CFM-10EM-A, CFM-10ET, CFM-10ET-6, CFM-10ET-A, CFM-10GEM, CFM-10GEM-6, CFM-10GEM6-A, CFM-10GEM-A, CFM-8EM, CFM-8EM-A, CFM-8ET, CFM-8ET-A, CFM-8GEM, CFM-8GEM-A | | |

| | | | |
|--------------------|---|-----------------|------------------|
| | | | |
| 1 | Part No. | Ref. No. | 533009600 |
| 691355 | | | |
| description | lever L 64mm for outlet tap thread M6 ET - M6 ET | | |
| For models: | BM-61EM, BM-61GF, BM-62EM, BM-62ET, BM-62GF, BMT-63EM, BMT-64EM, BMT-64G, BMT-66EM, BMT-66G, BMT-74EM, BMT-74G, BMT-78EM, BMT-78G, BMT-94EM, BMT-94G, BMT-98EM, BMT-98G, CFA4-78G, CFA6-712GV, CP-61EM, CP-62ET, CP-62G, CPT-64EM-USA, CPT-64ET, CPT-64G, CPT-66ET, CPT-66G, CPT-74ET, CPT-74G, CPT-76ET, CPT-76G, CWK-74ET, CWK-78ET, CWK-94ET, CWK-98ET, CWKT-64ET, CWKT-68ET, CWKT-74ET, CWKT-78ET, CWKT-94ET, CWKT-98ET, F10T-63EM, F10T-63ET, F10T-63ETX, F13T-74E, F13T-74ET, F13T-74ETX, F13T-74G, F13T-94ET...(Other models you can see in the webshop) | | |

| | | | |
|------------------------|---|-----------------|------------------|
| | | | |
| 1 | Part No. | Ref. No. | 533027200 |
| 540748 | | | |
| description | lever L 70mm for outlet tap thread M6 ET - M6 ET thread L 28/11mm | | |
| For models: | BM-10EM, BM-10EMX, BM-4EM, BM-4EMX, BM-4G, BM-6EM, BM-6EMX, BM-6G, BM-8EM, BM-8EMX, BM-8G, BS-4EM, BS-4EMX, CP-6G, FE-10, FE2-10, FE-2-8, FE-8, FEM-2-6, FEM-6, FG-10, FG-2-10, FP-6ET, FP-6G, FPE-20, FPE-25, FPG-20, FPG-30, FQ-4EM, FQ-4ET, FQ-4ETX, FQ-4G, FQ-6EM, FQ-6ET, FQ-6ETX, FQ-6G | | |
| accessories for | 540748 | | |
| | | | |
| | Part No. | Ref. No. | 536000300 |
| | 540749 | | |
| description | cone handle plastic black for outlet tap | | |

| | | | |
|--------------------|--|-----------------|------------------|
| | | | |
| 1 | Part No. | Ref. No. | 533010200 |
| 106598 | | | |
| description | olive for pipe ø 18mm Qty 1 pcs ED ø 21mm | | |
| For models: | BM-10EM, BM-10EMX, BM-4EM, BM-4EMX, BM-4G, BM-61EM, BM-61GF, BM-62EM, BM-62ET, BM-62GF, BM-6EM, BM-6EMX, BM-6G, BM-8EM, BM-8EMX, BM-8G, BMT-63EM, BMT-64EM, BMT-64G, BMT-66EM, BMT-66G, BMT-74EM, BMT-74G, BMT-78EM, BMT-78G, BMT-94EM, BMT-94G, BMT-98EM, BMT-98G, BS-4EM, BS-4EMX, CP-61EM, CP-62ET, CP-62G, CP-6G, CPT-64EM-USA, CPT-64ET, CPT-64G, CPT-66ET, CPT-66G, CPT-74ET, CPT-74G, CPT-76ET, CPT-76G, CWK-74ET, CWK-78ET, CWK-94ET, CWK-98ET, CWKT-64ET, CWKT-68ET...(Other models you can see in the webshop) | | |

fittings for catering equipment

outlet taps

producer-specific





LOTUS

| | | | |
|--------------------|---|-----------------|------------------|
| | | | |
| 1 | Part No. | Ref. No. | 536000300 |
| 110704 | | | |
| description | cone handle thread M6 ø 16mm L 25mm plastic black | | |

| | | | |
|--------------------|--|-----------------|------------------|
| | | | |
| 1 | Part No. | Ref. No. | 544120300 |
| 514006 | | | |
| description | drain pipe L 200mm thread ø 22mm | | |
| For models: | BM-10EM, BM-10EMX, BM-4EM, BM-4EMX, BM-4G, BM-61EM, BM-61GF, BM-62EM, BM-62ET, BM-62GF, BM-6EM, BM-6EMX, BM-6G, BM-8EM, BM-8EMX, BM-8G, BMT-63EM, BMT-64EM, BMT-64G, BMT-66EM, BMT-66G, BMT-74EM, BMT-74G, BMT-78EM, BMT-78G, BMT-94EM, BMT-94G, BMT-98EM, BMT-98G, BS-4EM, BS-4EMX, CP-61EM, CP-62ET, CP-62G, CP-6G, CPT-64EM-USA, CPT-64ET, CPT-64G, CPT-66ET, CPT-66G, CPT-74ET, CPT-74G, CPT-76ET, CPT-76G, CWK-74ET, CWK-78ET, CWK-94ET, CWK-98ET, CWKT-64ET, CWKT-68ET...(Other models you can see in the webshop) | | |

1

| | | | |
|---|--|-----------------|---------------------------|
| Part No. | 540259 | Ref. No. | 531000100 |
| description | outlet tap without handle thread 3/4" IT | | |
| For models: | BM-10EM, BM-10EMX, BM-4EM, BM-4EMX, BM-4G, BM-61EM, BM-61GF, BM-62EM, BM-62ET, BM-62GF, BM-6EM, BM-6EMX, BM-6G, BM-8EM, BM-8EMX, BM-8G, BMT-63EM, BMT-64EM, BMT-64G, BMT-66EM, BMT-66G, BMT-74EM, BMT-74G, BMT-78EM, BMT-78G, BMT-94EM, BMT-94G, BMT-98EM, BMT-98G, BS-4EM, BS-4EMX, CP-61EM, CP-62ET, CP-62G, CP-6G, CPT-64EM-USA, CPT-64ET, CPT-64G, CPT-66ET, CPT-66G, CPT-74ET, CPT-74G, CPT-76ET, CPT-76G, CWK-74ET, CWK-78ET, CWK-94ET, CWK-98ET, CWKT-64ET, CWKT-68ET...(Other models you can see in the webshop) | | |
| accessories for | 540259 | | |
|  | Part No. | 514006 | Ref. No. 544120300 |
| | drain pipe L 200mm thread \varnothing 22mm | | |
|  | Part No. | 540748 | Ref. No. 533027200 |
| | lever L 70mm for outlet tap thread M6 ET - M6 ET thread L 28/11mm | | |
|  | Part No. | 540749 | Ref. No. 536000300 |
| | cone handle plastic black for outlet tap | | |
|  | Part No. | 540755 | Ref. No. — |
| | lever for outlet tap | | |
|  | Part No. | 691355 | Ref. No. 533009600 |
| | lever L 64mm for outlet tap thread M6 ET - M6 ET | | |



1

| | | | |
|--------------------|--|-----------------|-----------|
| Part No. | 106597 | Ref. No. | 533010100 |
| description | union screw thread 3/4" for pipe \varnothing 18mm L 20mm Qty 1 pcs WS 27 | | |
| For models: | BM-10EM, BM-10EMX, BM-4EM, BM-4EMX, BM-4G, BM-61EM, BM-61GF, BM-62EM, BM-62ET, BM-62GF, BM-6EM, BM-6EMX, BM-6G, BM-8EM, BM-8EMX, BM-8G, BMT-63EM, BMT-64EM, BMT-64G, BMT-66EM, BMT-66G, BMT-74EM, BMT-74G, BMT-78EM, BMT-78G, BMT-94EM, BMT-94G, BMT-98EM, BMT-98G, BS-4EM, BS-4EMX, CP-61EM, CP-62ET, CP-62G, CP-6G, CPT-64EM-USA, CPT-64ET, CPT-64G, CPT-66ET, CPT-66G, CPT-74ET, CPT-74G, CPT-76ET, CPT-76G, CWK-74ET, CWK-78ET, CWK-94ET, CWK-98ET, CWKT-64ET, CWKT-68ET...(Other models you can see in the webshop) | | |

aerators and air bleeders



1

| | | | |
|--------------------|---|-----------------|-------|
| Part No. | 540825 | Ref. No. | 14945 |
| description | aerator and air bleeder thread 3/8" ET WS 24 chrome-plated L 37mm | | |

inlet taps



1

| | | | |
|---|--|-----------------|-------------------|
| Part No. | 514048 | Ref. No. | 531018500 |
| description | ball valve connection 1/2" complete total length 55mm mounting pos. any brass H 30mm L 55mm rosette \varnothing 70mm rosette thread G2 M22x1 | | |
| For models: | CP-6G, CPM-62G, CPM-6G | | |
| spare parts for | 514048 | | |
|  | Part No. | 540871 | Ref. No. — |
| | lever handle cold water suitable for intake tap | | |



1

| | | | |
|--------------------|--|-----------------|-----------|
| Part No. | 514049 | Ref. No. | 531020800 |
| description | ball valve connection 3/4" complete total length 66mm mounting pos. brass equiv. no. 531020800 | | |
| For models: | CP-4ET, CP-4ETX, CP-6ET, CP-6ETX | | |





drain taps

brass

drain taps



| | | | |
|--|---|-----------------|-------------------|
| Part No. | 540275 | Ref. No. | 10027 |
| description | drain tap 2" IT with union nut A 90mm B 151mm B1 80mm chrome-plated brass | | |
| spare parts for | 540275 | | |
|  | Part No. | 540214 | Ref. No. — |
| | handle ID ø 6mm L 145mm | | |
| accessories for | 540275 | | |
|  | Part No. | 529484 | Ref. No. — |
| | flat gasket fibre ED ø 58mm ID ø 50mm thickness 2mm Qty 1 pcs | | |
|  | Part No. | 542448 | Ref. No. — |
| | gasket silicone 60x49x2 for drain tap 2" | | |

test taps

test taps

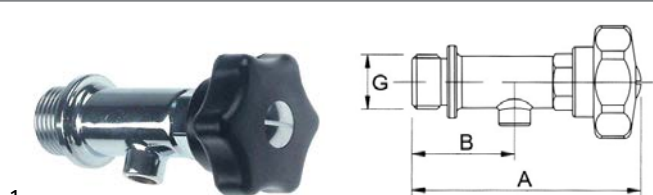

| | | | |
|--------------------|--|-----------------|-------|
| Part No. | 540818 | Ref. No. | 10044 |
| description | test tap thread 1/2" ET W 88mm W1 38mm | | |

safety fittings

safety fittings



| | | | |
|---|---|-----------------|-----------------------|
| Part No. | 514276 | Ref. No. | 11032 |
| description | safety fitting thread 3/4" 0.45bar H 165mm ø 65mm | | |
| spare parts for | 514276 | | |
|  | Part No. | 514094 | Ref. No. — |
| | angle piece thread 3/8" | | |
|  | Part No. | 514276 | Ref. No. 11032 |
| | safety fitting thread 3/4" 0.45bar H 165mm ø 65mm | | |
|  | Part No. | 540825 | Ref. No. 14945 |
| | aerator and air bleeder thread 3/8" ET WS 24 chrome-plated L 37mm | | |
|  | Part No. | 540828 | Ref. No. 10023 |
| | manometer siphon thread 3/8" | | |
|  | Part No. | 541579 | Ref. No. 10022 |
| | manometer ø 52mm pressure range 0 up to 1bar connection marking 0.5 thread 1/4" | | |











| | | | |
|---|---|-----------------|-----------------------|
| Part No. | 514275 | Ref. No. | 17054 |
| description | safety fitting thread 3/4" 0.45bar with manometer and aerator/air bleeder 3.3kg H 200mm W 150mm | | |
| spare parts for | 514275 | | |
|  | Part No. | 514094 | Ref. No. — |
| | angle piece thread 3/8" | | |
|  | Part No. | 514276 | Ref. No. 11032 |
| | safety fitting thread 3/4" 0.45bar H 165mm ø 65mm | | |
|  | Part No. | 540825 | Ref. No. 14945 |
| | aerator and air bleeder thread 3/8" ET WS 24 chrome-plated L 37mm | | |
|  | Part No. | 540828 | Ref. No. 10023 |
| | manometer siphon thread 3/8" | | |

Table continues overleaf



| | | | |
|---|----------|--------|----------------|
| spare parts for 514275 | | | |
|  | Part No. | 541579 | Ref. No. 10022 |
| manometer ø 52mm pressure range 0 up to 1bar connection marking 0.5 thread 1/4" | | | |

| accessories | | | |
|---|--------|----------|-------|
|  | 1 | | |
| Part No. | 540817 | Ref. No. | 10014 |
| description fitting support thread 1/2" ET suitable for manometer | | | |

| | | | |
|---|----------|----------|------------|
|  | 1 | | |
| Part No. | 540835 | Ref. No. | 10013 |
| description screw cap thread 3/4" | | | |
| spare parts for 540835 | | | |
|  | Part No. | 513016 | Ref. No. — |
| O-ring EPDM thickness 3.53mm ID ø 26.58mm Qty 1 pcs | | | |
| accessories for 540835 | | | |
|  | Part No. | 513016 | Ref. No. — |
| O-ring EPDM thickness 3.53mm ID ø 26.58mm Qty 1 pcs | | | |

| | | | |
|---|--------|----------|-------|
|  | 1 | | |
| Part No. | 540828 | Ref. No. | 10023 |
| description manometer siphon thread 3/8" | | | |

equipment feet and end caps

| equipment feet | | | |
|--|--------|----------|-----------|
| with screw mounting | | | |
|  | 1 | | |
| Part No. | 690038 | Ref. No. | 531008100 |
| description equipment foot tube ø 42mm thread M10 thread L 14mm H 85-140mm chrome-plated steel size 1 1/2" Qty 1 pcs | | | |
| For models: A-60, A-90, AF-1, AF-2, AF-3, BA-62, BA-80, BAL-62, BAL-80, BC1-45, BC2-45, BC-30, BC3-45, BC-45, BP-120, BP-135, BP-30DX, BP-30SX, BP-45DX, BP-45SX, BP-60, BP-90, BPL-120, BPL-135, BPL-45DX, BPL-45SX, BPL-60, BPL-90, CF-10EM, CF-10EM-6, CF-10EM-A, CF-10ET, CF-10ET-6, CF-10ET-A, CF-10G6-A, CF-10G-6F, CF-10G-A, CF-10GEM, CF-10GEM-6, CF-10GEM6-A, CF-10GEM-A, CF-10GF, CF-62EM, CF-62EM-A, CF-62ET, CF-62ET-A, CF-62GEM, CF-62GEM-A, CF-8EM, CF-8EM-A...(Other models you can see in the webshop) | | | |

baskets

fryer baskets

| LOTUS | | | |
|---|--------|----------|-----------|
|  | 1 | | |
| Part No. | 970165 | Ref. No. | 531000600 |
| description fryer basket L1 230mm W1 130mm H1 110mm | | | |
| For models: FEC-4 | | | |

| | | | |
|---|--------|----------|-----------|
|  | 1 | | |
| Part No. | 970199 | Ref. No. | 531005700 |
| description fryer basket L1 250mm W1 200mm H1 96mm L2 350mm H2 132mm H3 195mm chrome-plated steel plastic | | | |
| For models: FQ-61GF, FQ-62GF | | | |

| | | | |
|---|--------|----------|-----------|
|  | 1 | | |
| Part No. | 970166 | Ref. No. | 531000700 |
| description fryer basket L1 270mm W1 200mm H1 110mm chrome-plated steel | | | |
| For models: FE-2-8, FE-8, FEM-2-6, FEM-6, FQ-61EM, FQ-61ET, FQ-62EM, FQ-62ET | | | |

| | | | |
|---|--------|----------|-----------|
|  | 1 | | |
| Part No. | 970327 | Ref. No. | 531020000 |
| description fryer basket L1 270mm W1 200mm H1 95mm | | | |
| For models: FQ-4EM, FQ-4ET, FQ-4ETX, FQ-6EM, FQ-6ET, FQ-6ETX | | | |

| | | | |
|---|--------|----------|-----------|
|  | 1 | | |
| Part No. | 970167 | Ref. No. | 531000800 |
| description fryer basket L1 270mm W1 260mm H1 110mm | | | |
| For models: FE-10, FE2-10, FME-10, FME-2-10 | | | |

| | | | |
|--|--------|----------|-----------|
|  | 1 | | |
| Part No. | 970417 | Ref. No. | 531041300 |
| description fryer basket L1 290mm W1 280mm H1 150mm | | | |
| For models: F18-74ET, F18-74ETX, F18-94ET, F18-94ETX, F18D-64ET, F2-18-74ET, F2-18-74ETX, F2-18-78ET, F2-18-78ETX, F2-18-98ET, F2-18-98ETX, F2-25-98ET, F2-25-98ETX, F25-94ET, F25-94ETX | | | |

1 mechanical components, equipment accessories



1

| | | | |
|--------------------|--|-----------------|-----------|
| Part No. | 970329 | Ref. No. | 531024100 |
| description | fryer basket L1 300mm W1 200mm H1 100mm L2 375mm H2 162mm H3 240mm chrome-plated steel | | |
| For models: | F10D-64ET, F10D-64ETX, F10T-63EM, F10T-63ET, F10T-63ETX, F2-10D-66ET, F2-10D-66ETX, F2-10T-66EM, F2-10T-66ET, F2-10T-66ETX, FQ-4EM, FQ-4ET, FQ-4ETX, FQ-4G, FQ-61EM, FQ-61ET, FQ-62EM, FQ-62ET, FQ-6EM, FQ-6ET, FQ-6ETX, FQ-6G | | |



1

| | | | |
|--------------------|---|-----------------|-----------|
| Part No. | 970169 | Ref. No. | 531013300 |
| description | fryer basket L1 300mm W1 210mm H1 120mm | | |
| For models: | F13-64EM, F13-64ET, F13-74ET, F13-74ETX, F13-74G, F18-74G, F2-13-78ET, F2-13-78ETX, F2-13-78G, FG-10, FG-2-10, FMG-10, FMG-2-10 | | |



1

| | | | |
|--------------------|--|-----------------|-----------|
| Part No. | 970273 | Ref. No. | 531013400 |
| description | fryer basket L1 330mm W1 300mm H1 120mm chrome-plated steel | | |
| For models: | F18-74ET, F18-74G, F2-18-78ET, F2-18-78G, FME-15, FME-2-15, FMG-15, FMG-2-15, FQM-4G | | |



1

| | | | |
|--------------------|--|-----------------|-----------|
| Part No. | 970418 | Ref. No. | 531041700 |
| description | fryer basket L1 450mm W1 135mm H1 150mm | | |
| For models: | F18-94ET, F18-94ETX, F2-18-98ET, F2-18-98ETX, F2-25-98ET, F2-25-98ETX, F2-25-98G, F25-94ET, F25-94ETX, F25-94G | | |



1

| | | | |
|--------------------|--|-----------------|-----------|
| Part No. | 970630 | Ref. No. | 531017500 |
| description | fryer basket L1 470mm W1 350mm H1 80mm L2 95mm H2 135mm H3 223mm | | |
| For models: | FMPE-20, FMGP-20, FPE-20, FPG-20 | | |



1

| | | | |
|--------------------|---|-----------------|-----------|
| Part No. | 971161 | Ref. No. | 531049300 |
| description | fryer basket W1 197mm L1 235mm H1 90mm L2 460mm H2 115mm H3 180mm holder length 100mm | | |
| For models: | F2-8T-66G, F8T-63G | | |

pasta baskets

LOTUS



1

| | | | |
|--------------------|---|-----------------|-----------|
| Part No. | 970847 | Ref. No. | 531032600 |
| description | pasta basket H1 200mm W1 100mm L1 140mm size 1/6 L2 190mm H2 220mm H3 420mm stainless steel | | |



1

| | | | |
|--------------------|--|-----------------|---------------|
| Part No. | 970259 | Ref. No. | 531032600 old |
| description | pasta basket L1 105mm W1 145mm H1 200mm H3 410mm stainless steel | | |



1

| | | | |
|--------------------|--|-----------------|-----------|
| Part No. | 970203 | Ref. No. | 531001600 |
| description | pasta basket L1 140mm W1 100mm H1 140mm H3 253mm stainless steel | | |
| For models: | CP-61EM, CP-62ET | | |





1

| | | | |
|--------------------|--|-----------------|-----------|
| Part No. | 970907 | Ref. No. | 531048000 |
| description | pasta basket L1 160mm W1 135mm H1 215mm H3 385mm stainless steel | | |



1

| | | | |
|--------------------|--|-----------------|-----------|
| Part No. | 970789 | Ref. No. | 531032500 |
| description | pasta basket L1 160mm W1 140mm H1 200mm H3 410mm stainless steel | | |



1

| | | | |
|--------------------|--|-----------------|-----------|
| Part No. | 970209 | Ref. No. | 531032500 |
| description | pasta basket L1 160mm W1 145mm H1 200mm H3 410mm stainless steel | | |



1

| | | | |
|--------------------|--|-----------------|-----------|
| Part No. | 970585 | Ref. No. | 531004000 |
| description | pasta basket L1 280mm W1 100mm H1 135mm L2 470mm H2 160mm H3 200mm stainless steel | | |
| For models: | CP-61EM, CP-62ET | | |



1

| | | | |
|--------------------|---|-----------------|-----------|
| Part No. | 970586 | Ref. No. | 531003900 |
| description | pasta basket L1 280mm W1 200mm H1 135mm stainless steel | | |
| For models: | CP-61EM, CP-62ET | | |



1

| | | | |
|--------------------|--|-----------------|-----------|
| Part No. | 970258 | Ref. No. | 531024500 |
| description | pasta basket L1 290mm W1 145mm H1 110mm H3 210mm stainless steel | | |
| For models: | CP-6G | | |



1

| | | | |
|--------------------|---|-----------------|-----------|
| Part No. | 970201 | Ref. No. | 531018800 |
| description | pasta basket L1 290mm W1 150mm H1 150mm stainless steel | | |
| For models: | CP-4ET, CP-4ETX, CP-6ET, CP-6ETX | | |



1

| | | | |
|--------------------|---|-----------------|-----------|
| Part No. | 970200 | Ref. No. | 531017900 |
| description | pasta basket L1 290mm W1 160mm H1 200mm stainless steel | | |
| For models: | CPM-62G, CPM-6G | | |

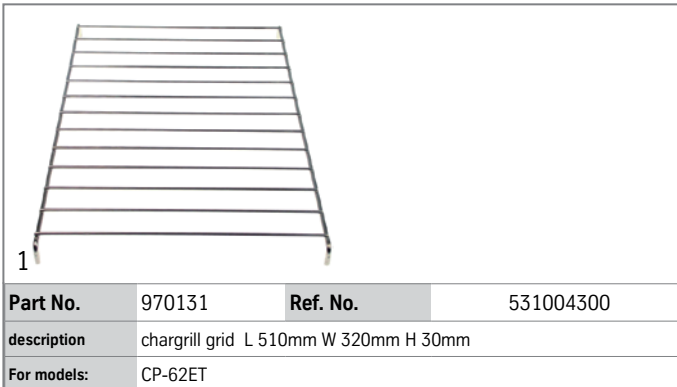
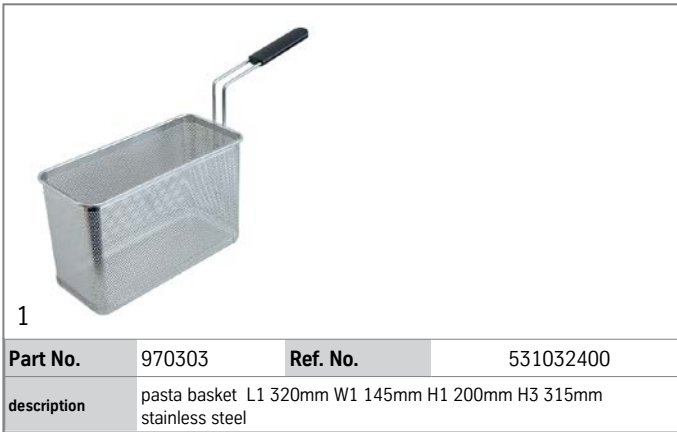

crumb screens

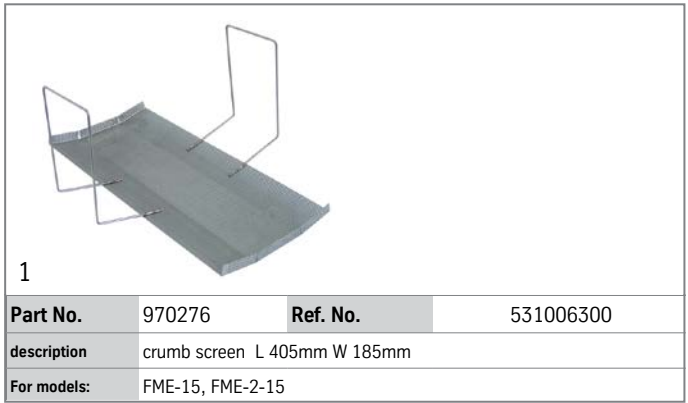
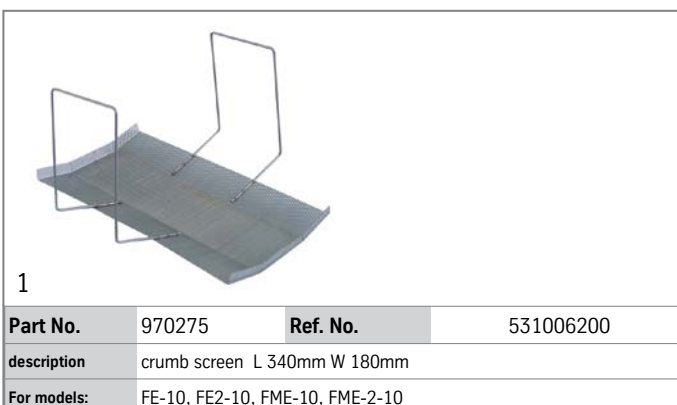
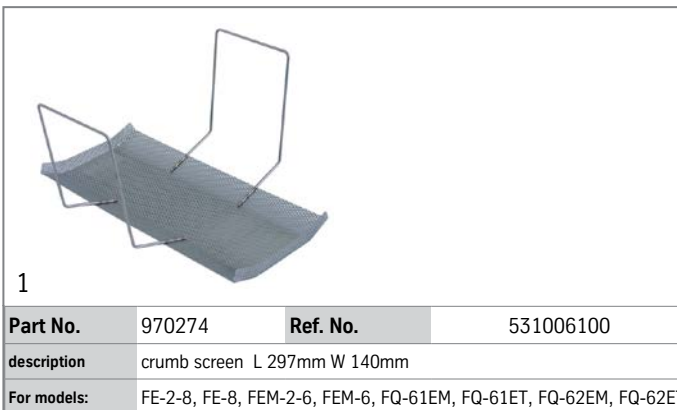

gaskets

gaskets for heated units

door seals

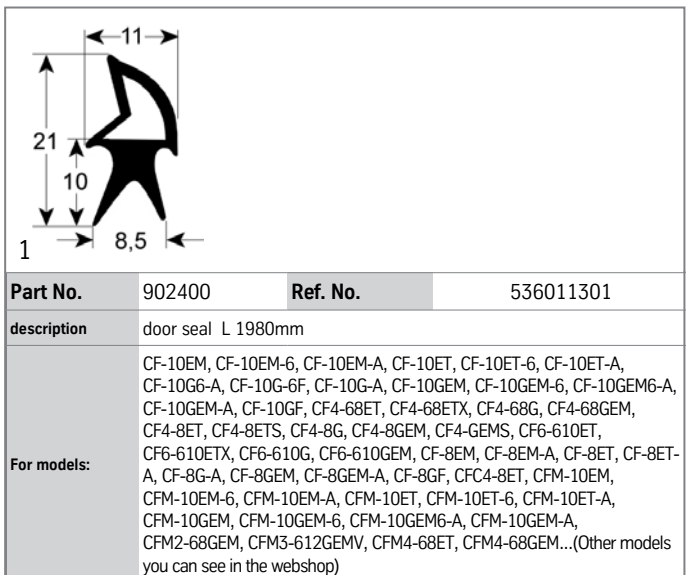
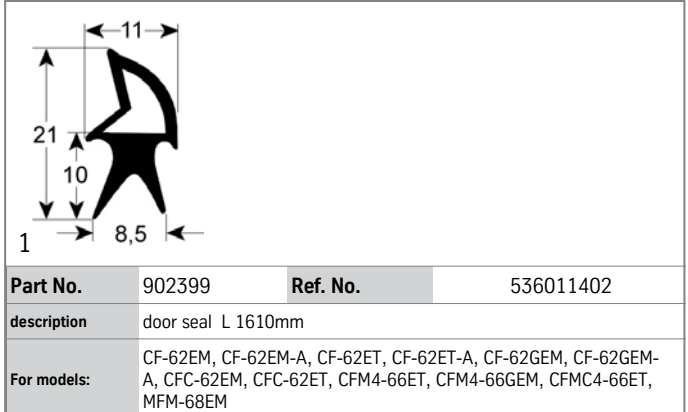



| | | | |
|--------------------|---|-----------------|-----------|
| Part No. | 900066 | Ref. No. | 536011300 |
| description | door seal profile 2910 W 340mm L 530mm Qty 1 | | |
| For models: | CF-10EM, CF-10EM-6, CF-10EM-A, CF-10ET, CF-10ET-6, CF-10ET-A, CF-10G6-A, CF-10G-6F, CF-10G-A, CF-10GEM, CF-10GEM-6, CF-10GEM6-A, CF-10GEM-A, CF-10GF, CF4-8ET, CF4-8ETS, CF4-8G, CF4-8GEM, CF4-GEMS, CF-8EM, CF-8EM-A, CF-8ET, CF-8ET-A, CF-8G-A, CF-8GEM, CF-8GEM-A, CF-8GF, CFC4-8ET, CFM-10EM, CFM-10EM-6, CFM-10EM-A, CFM-10ET, CFM-10ET-6, CFM-10ET-A, CFM-10GEM, CFM-10GEM-6, CFM-10GEM6-A, CFM-10GEM-A, CFM-8EM, CFM-8EM-A, CFM-8ET, CFM-8ET-A, CFM-8GEM, CFM-8GEM-A | | |

door seals with fixing hook

| | | | |
|--------------------|--|-----------------|------------------------|
| Part No. | 900238 | Ref. No. | 536010800 536010801 |
| description | door seal L 650mm W 340mm with 6 mounting clips 3-sided (long side open) | | |
| For models: | CF2-58G, CF2-58GE, CF2-68G, CF2-68GEM, CF3-512GEV, CF3-512GV, CF3-612GEMV, CF3-612GV, CF4-78ET, CF4-78ETX, CF4-78G, CF4-78GE, CF4-78GP, CF4-78GP-AUS, CF4-78GPE, CF4-78GP-USA, CF4-98ET, CF4-98ETX, CF4-98G, CF4-98GE, CF6-712ETV, CF6-712ETVX, CF6-712GEV, CF6-712GPEV, CF6-712GPV, CF6-712GPV-USA, CF6-712GV, CF6-912ETV, CF6-912ETVX, CF6-912GEV, CF6-912GV, CF8-916ET, CF8-916G, CF8-916GE, CFA4-78G, CFA4-98G, CFA6-912GV, CFC4-78ET, CFC4-78ETX, CFC4-98ET, CFPB6-79G, CFPB6-79GEM, CFQ4-78ET, CFQ4-78ETX, CFQ4-98ET, CFQ4-98ETX, CFQ6-712ETV, CFQ6-712ETVX, CFQ6-912ETV, CFQ6-912ETVX...(Other models you can see in the webshop) | | |



| | | | |
|--------------------|---|-----------------|---------|
| Part No. | 902401 | Ref. No. | 75R0003 |
| description | oven gasket L 470mm W 380mm 4-sided with 8 mounting clips | | |



| | | | |
|--------------------|---|-----------------|-----------|
| Part No. | 902402 | Ref. No. | 536035600 |
| description | oven gasket L 680mm W 360mm 4-sided with 8 mounting clips | | |
| For models: | CFQ8-916ETV, CFV4-78ET, CFV4-78GPE, CFV4-98ET, CFV4-98GE, CFV6-712ETV, CFV6-712GPEV, CFV6-912ETV, CFV4-78ET, CFVC4-98ET, CFVVPB6-79GEM, CFVQ4-78ET, CFVQ4-98ET, CFVQ6-712ETV, CFVQ6-912ETV, TPFV2-712GPEV, TPFV2-78GPE, TPFV2-912GEV, TPFV2-98GE, TPFV4-712GPEV, TPFV4-912GEV, TPFV-78ET, TPFV-78GE, TPFV-98ET, TPFV-98GE | | |



| | | | |
|--------------------|--|-----------------|------------------------|
| Part No. | 900245 | Ref. No. | 536010900 536010901 |
| description | oven gasket profile 2915 L 1010mm W 325mm with 8 mounting clips 3-sided (long side open) Qty 1 external size | | |
| For models: | CF6-712ET, CF6-712ETX, CF6-712G, CF6-712GP, CF6-712GPE, CF6-912ET, CF6-912G, CF6-912GE, CF-712GE, CF-712GPE, CF8-916ETV, CF8-916GEV, CF8-916GV, CFQ6-712ET, CFQ6-712ETX, CFQ6-912ET, CFQ8-916ETV, CFV6-912ET, CFVQ6-912ET, TPF2-712G, TPF2-712GP, TPF2-712GPE, TPF2-912G, TPF2-912GE, TPF4-712GP, TPF4-712GPE, TPF4-912G, TPF4-912GE | | |

O-rings

EPDM

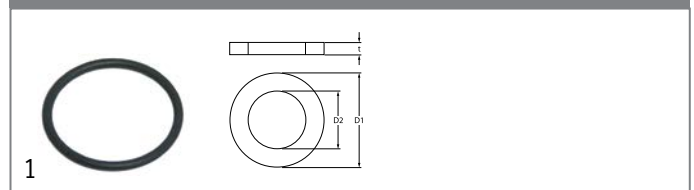

| | | | |
|--------------------|---|-----------------|-----------|
| Part No. | 100809 | Ref. No. | 536000500 |
| description | O-ring EPDM thickness 2mm ID ø 21mm Qty 1 pcs | | |
| For models: | BM-61GF, BM-62GF, CP-62G, CPM-62G, FG-10, FG-2-10, FMG-10, FMG-15, FMG-2-10, FMG-2-15, FMPG-20, FMPG-30, FP-62G, FPG-20, FPG-30, FQ-61GF, FQ-62GF, FQM-4G, FTL-61G, FTL-61GS, FTL-62G, FTL-62GS, FTL-63G, FTL-63GS, FTL-64G, FTL-64GS, FTLR-62G, FTLR-62GS, FTLR-63G, FTLR-63GS, FTLR-64G, FTLR-64GS, FTR-61G, FTR-61GS, FTR-62G, FTR-62GS, K-10, K-10S, K-12, K-12S, K-14, K-14S, K-15, K-15S, K-16, K-16S, K-18, K-18S, K-20, K-20S...(Other models you can see in the webshop) | | |

silicone

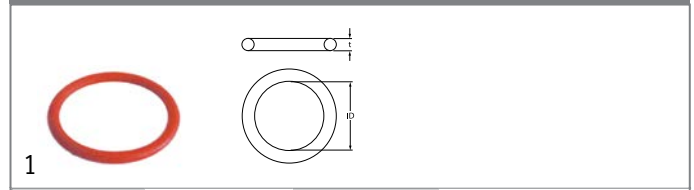

| | | | |
|--------------------|--|-----------------|-----------|
| Part No. | 532484 | Ref. No. | 536009700 |
| description | O-ring silicone thickness 2.62mm ID ø 37.77mm Qty 1 pcs | | |
| For models: | CP-74ET, CP-74ETX, CP-78ET, CP-78ETX, CP-94ET, CP-94ETX, CP-98ET, CP-98ETX, CPB-98ET, CPD-64ET | | |

mechanical components,
equipment accessories
1



Viton

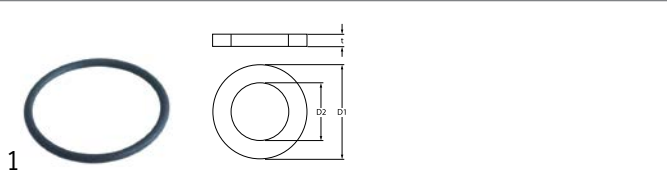

| | | | |
|--------------------|--|-----------------|-----------|
| Part No. | 550494 | Ref. No. | 536009800 |
| description | O-ring Viton thickness 3.53mm ID ø 47.22mm Qty 1 pcs | | |
| For models: | CP-66ET, CP-74ET, CP-76ET, CP-78ET, CP-94ET, CP-98ET, CPD-64ET, F10D-64ET, F10D-64ETX, F10T-63EM, F10T-63ETX, F10T-63ETX, F13-64EM, F13-64ET, F13-74ET, F13-74ETX, F13T-74E, F13T-74ET, F13T-74ETX, F18-74ETX, F18-74ET, F18-74ETX, F18-94ET, F18-94ETX, F18D-64ET, F2-10D-66ET, F2-10D-66ETX, F2-10T-66EM, F2-10T-66ETX, F2-10T-66ETX, F2-13-78ET, F2-13-78ETX, F2-13-98ET, F2-13T-78E, F2-13T-78ET, F2-18-74ET, F2-18-74ETX, F2-18-78ET, F2-18-78ETX, F2-18-98ET, F2-18-98ETX, F2-25-98ET, F2-25-98ETX, F25-94ET, F25-94ETX, F2-8-74ET, F2-8-94ET, F2-8D-64ET, F2-8T-74ET, F2-8T-74ETX...(Other models you can see in the webshop) | | |

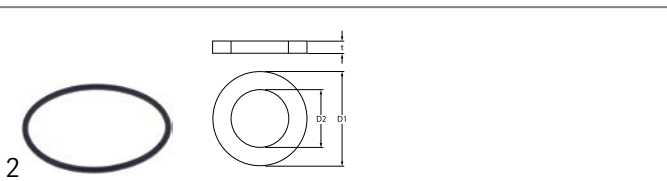

| | | | |
|--------------------|---|-----------------|-----------|
| Part No. | 532725 | Ref. No. | 536026700 |
| description | O-ring Viton thickness 3.53mm ID ø 74.61mm Qty 1 pcs | | |
| For models: | CP-66ET, CP-74ET, CP-76ET, CP-78ET, CP-94ET, CP-98ET, F10D-64ET, F10D-64ETX, F10T-63EM, F10T-63ET, F10T-63ETX, F13-64EM, F13-64ET, F13-74ET, F13-74ETX, F13T-74E, F13T-74ET, F13T-74ETX, F13T-94ET, F18-74ET, F18-74ETX, F18-94ET, F18-94ETX, F18D-64ET, F2-10D-66ET, F2-10D-66ETX, F2-10T-66EM, F2-10T-66ETX, F2-10T-66ETX, F2-13-78ET, F2-13-78ETX, F2-13-98ET, F2-13T-78E, F2-13T-78ET, F2-18-74ET, F2-18-74ETX, F2-18-78ET, F2-18-78ETX, F2-18-98ET, F2-18-98ETX, F2-25-98ET, F2-25-98ETX, F25-94ET, F25-94ETX, F2-8-74ET, F2-8-94ET, F2-8D-64ET, F2-8T-74ET, F2-8T-74ETX, F2-8T-94ET...(Other models you can see in the webshop) | | |

sealing washers

fibre gaskets



| | | | |
|--------------------|---|-----------------|-----------|
| Part No. | 693077 | Ref. No. | 536012600 |
| description | flat gasket FIBER ED ø 24mm ID ø 17mm thickness 1.5mm Qty 1 pcs | | |
| For models: | BM-74EM, BM-74ET, BM-74G, BM-78EM, BM-78ET, BM-78G, BM-94EM, BM-94G, BM-98EM, BM-98G, CP-66ET, CP-66G, CP-74ET, CP-74G, CP-76ET, CP-76G, CP-78ET, CP-78G, CP-94ET, CP-94G, CP-98ET, CP-98G, CPB-98ET, CPB-98G | | |

manometers



| | | | |
|--------------------|---|-----------------|-------|
| Part No. | 541579 | Ref. No. | 10022 |
| description | manometer ø 52mm pressure range 0 up to 1bar connection marking 0.5 thread 1/4" | | |

fittings, hose and pipe connectors

fittings

miscellaneous



| | | | |
|--------------------|---|-----------------|-----------|
| Part No. | 693078 | Ref. No. | 533070700 |
| description | connecting fitting | | |
| For models: | BM-74EM, BM-74ET, BM-74G, BM-78EM, BM-78ET, BM-78G, BM-94EM, BM-94G, BM-98EM, BM-98G, CP-66ET, CP-66G, CP-74ET, CP-74G, CP-76ET, CP-76G, CP-78ET, CP-78G, CP-94ET, CP-94G, CP-98ET, CP-98G, CPB-98ET, CPB-98G | | |

valves and tank inlets

ball valves

universal

ball valves with lever handle











| | | | |
|--------------------|--|-----------------|-----------|
| Part No. | 520285 | Ref. No. | 531018600 |
| description | ball valve connection 1" IT - 1" ET DN25 total length 74mm with lever handle handle length 105mm | | |
| For models: | BM-74EM, BM-74G, BM-78EM, BM-78G, BM-94EM, BM-94G, BM-98EM, BM-98G, BMD-64EM, BMD-84EM, CP-66ET, CP-66G, CP-74ET, CP-74ETUSA, CP-74ETX, CP-74G, CP-74G-AUS, CP-74G-USA, CP-76ET, CP-76G, CP-78, CP-78ET, CP-78ET-USA, CP-78ETX, CP-78G, CP-78G-AUS, CP-78G-USA, CP-94ET, CP-94ET-USA, CP-94ETX, CP-94G, CP-94G-USA, CP-98ET, CP-98ET-USA, CP-98ETX, CP-98G, CP-98G-USA, CPA-66ET, CPA-66G, CPA-74ET, CPA-74G, CPA-76ET, CPA-76G, CPA-78ET, CPA-78G, CPA-94ET, CPA-94G, CPA-98ET, CPA-98G, CPB-98ET...(Other models you can see in the webshop) | | |



| | | | |
|---|---|-----------------|-----------|
|  | | | |
| 1 | | | |
| Part No. | 540750 | Ref. No. | 531001000 |
| description | ball valve connection 3/4" IT - hose ø22mm with lever handle handle length 95mm | | |
| For models: | BM-74EM, BM-74ET, BM-74G, BM-78EM, BM-78ET, BM-78G, F10D-64ET, F10D-64ETX, F13-74ET, F13-74G, F18-74ET, F18-74G, F2-10D-66ET, F2-10D-66ETX, F2-13-78ET, F2-13-78G, F2-18-78ET, F2-18-78G, FME-10, FME-15, FME-2-10, FME-2-15, FMG-10, FMG-15, FMG-2-10, FMG-2-15, FMPE-20, FMPE-25, FMPE-30, FMPG-20, FMPG-30, FQM-4G | | |

shut-off valves

universal

| | | | | |
|---|---|--|-----------------|---|
|  | | | | |
| 1 | | | | |
| Part No. | 693107 | Ref. No. | 30200008 | |
| description | shut-off valve connection 1/2" 1/2" cold total length 54mm L1 27mm L2 30mm marking blue rosette thread G2 26x19G connection ø M4x0.7 ITmm | | | |
| spare parts for | 693107 | | | |
|  | Part No. | 514085 | Ref. No. | — |
| | | rosette connection 26x19G chrome-plated total lengthmm mounting pos. | | |
|  | Part No. | 514086 | Ref. No. | — |
| | | hexagonal nut connection 26x19G brass total lengthmm mounting pos. H 6mm WS 34 Qty 1 pcs | | |
|  | Part No. | 540672 | Ref. No. | — |
| | | gasket suitable for tap head | | |
|  | Part No. | 547711 | Ref. No. | — |
| | | hood handle shaft intake ø 8mm marking blue metal H2 21mm D1 ø 33mm type D suitable for MONOLITH shaft length H1 8mm | | |
|  | Part No. | 548168 | Ref. No. | — |
| | | star handle connection hot total lengthmm mounting pos. ø 57mm marking red | | |
|  | Part No. | 548169 | Ref. No. | — |
| | | star handle connection cold total lengthmm mounting pos. chrome-plated ø 57mm | | |
| accessories for | 693107 | | | |
|  | Part No. | 514086 | Ref. No. | — |
| | | hexagonal nut connection 26x19G brass total lengthmm mounting pos. H 6mm WS 34 Qty 1 pcs | | |

| | | | |
|---|--|-----------------|-----------|
| producer-specific | | | |
| LOTUS | | | |
|  | | | |
| 1 | | | |
| Part No. | 541770 | Ref. No. | 531037600 |
| description | shut-off valve connection 1/2" 1/2" cold total length 50mm mounting pos. left rosette thread G2 26x18G | | |
| For models: | BM-74EM, BM-74G, BM-78EM, BM-78G, BM-94EM, BM-94G, BM-98EM, BM-98G, CP-66ET, CP-66G, CP-74ET, CP-74ET-USA, CP-74ETX, CP-74G, CP-74G-AUS, CP-74G-USA, CP-76ET, CP-76G, CP-78, CP-78ET, CP-78ETUSA, CP-78ETX, CP-78G, CP-78G-AUS, CP-78G-USA, CP-94ET, CP-94ETUSA, CP-94ETX, CP-94G, CP-98ET, CP-98ET-USA, CP-98ETX, CP-98G, CPA-74ET, CPA-74G, CPA-76ET, CPA-76G, CPA-78ET, CPA-78G, CPA-94ET, CPA-94G, CPA-98ET, CPA-98G, CPB-98ET, CPB-98G, CPBA-98ET, CPBA-98G, CPP-94G, CPP-94G-USA, CPT-74ET...(Other models you can see in the webshop) | | |

fastening material

| | | | |
|---|---|-----------------|-----------|
| nuts | | | |
| hexagonal nuts | | | |
| hexagonal nuts metric (without norm) | | | |
|  | | | |
| 1 | | | |
| Part No. | 102067 | Ref. No. | 533009800 |
| description | nut thread M8x1 H 3mm brass Qty 1 pcs type SEF 1 | | |
| For models: | CF-10G6-A, CF-10G-6F, CF-10G-A, CF-10GEM, CF-10GEM-6, CF-10GEM6-A, CF-10GEM-A, CF-10GF, CF4-78G, CF4-78GE, CF4-8G, CF4-8GEM, CF4-GEMS, CF-62GEM, CF-62GEM-A, CF6-712G, CF6-712GEV, CF6-712GV, CF-712GE, CF-8G-A, CF-8GEM, CF-8GEM-A, CF-8GF, CFM-10GEM, CFM-10GEM-6, CFM-10GEM6-A, CFM-10GEM-A, CFM-8GEM, CFM-8GEM-A, F-1G, FB-1G, FO-1G, FO-2G, FO-3G, FOS-1G, FOS-2G, FOS-3G, PC-12G, PC-4G, PC-61GF, PC-62GF, PC-712G, PC-716G, PC-74G, PC-78G, PC-8G, TP2-712G, TPF2-712G, TPF2-712GV | | |

GASTROPARTS.COM

