



**GASTROPARTS**

# Lohberger

**[EN]** Equipment

**[DE]** Geräte

**[ES]** Aparatos

**[FR]** Équipement

**[IT]** Attrezzature

**[PL]** Urządzenia

**[RU]** Оборудование

✉ [gastroparts@gastroparts.com](mailto:gastroparts@gastroparts.com)

☎ +48 56 657 00 66

📘 [fb.com/gastroparts.global](https://fb.com/gastroparts.global)

**GASTROPARTS.COM**





## heating elements

### heating elements for ovens

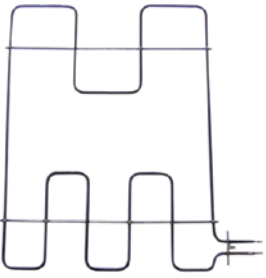

1

<b>Part No.</b>	415223	<b>Ref. No.</b>	51440360
<b>description</b>	heating element 2500W 400V L 450mm W 570mm L1 20mm L2 430mm W1 500mm W2 30mm flange length 70mm flange width 18mm hole distance 56mm hole $\varnothing$ 3mm tube $\varnothing$ 6.5mm connection length 23mm connection male faston 6.3mm heating circuits 1 rectangular flange dry heating element		
<b>accessories for</b>	415223		
	<b>Part No.</b>	510368	<b>Ref. No.</b> —
	gasket L 70mm W 23.5mm hole $\varnothing$ 5mm hole distance 56mm FIBER thickness 2mm for heating element		

### heating elements for bain maries



1

<b>Part No.</b>	415224	<b>Ref. No.</b>	51440350
<b>description</b>	heating element 1200W 400V heating circuits 1 L 280mm W 96mm flange length 45mm flange width 17mm hole distance 35mm tube $\varnothing$ 6.3mm cable length 250mm rectangular flange hole $\varnothing$ 5mm dry heating element L1 15mm L2 265mm W1 71mm W2 25mm		

### heating elements for fryers



1

<b>Part No.</b>	417621	<b>Ref. No.</b>	FF211060
<b>description</b>	heating element 7500W 230V heating circuits 3 L 345mm W 126mm H 320mm rectangular flange fryer cable lengthmm tube $\varnothing$ 8.5mm		

### heating elements for large hobs

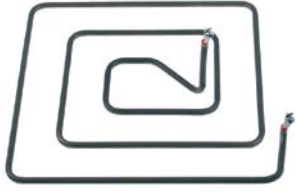

1

<b>Part No.</b>	418704	<b>Ref. No.</b>	N/A
<b>description</b>	heating element 1160W 400V L 255mm W 240mm H 75mm tube $\varnothing$ 6.5mm mounting pos. inner connection screw INCOLOY		

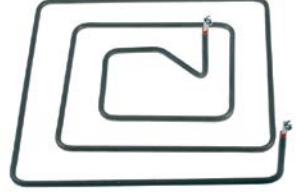

1

<b>Part No.</b>	418705	<b>Ref. No.</b>	N/A
<b>description</b>	heating element 1335W 400V L 270mm W 270mm H 75mm tube $\varnothing$ 6.5mm mounting pos. centre connection screw INCOLOY		

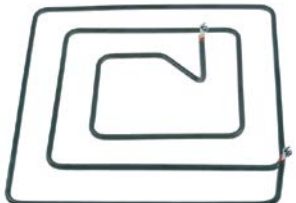

1

<b>Part No.</b>	418706	<b>Ref. No.</b>	—
<b>description</b>	heating element 1505W 400V L 300mm W 300mm H 75mm tube $\varnothing$ 6.5mm mounting pos. outer connection screw INCOLOY		

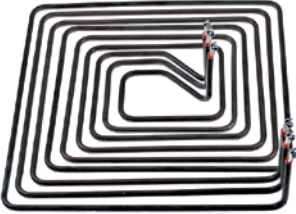

1

<b>Part No.</b>	418703	<b>Ref. No.</b>	51440405
<b>description</b>	heating element 4000W 400V L 300mm W 300mm H 75mm heating circuits 3 tube $\varnothing$ 6.5mm connection screw		

### heating elements for refrigeration

#### heating elements for defrosting



1

<b>Part No.</b>	419208	<b>Ref. No.</b>	1666250 PO1666250
<b>description</b>	heating element 250W 230V L 420mm W 50mm Hmm cable length 360mm tube $\varnothing$ 6mm refrigerator connection F6.3		



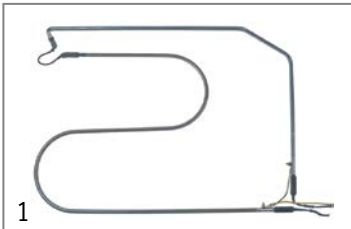

<b>Part No.</b>	416376	<b>Ref. No.</b>	1666320 PO1666320
<b>description</b>	heating element 300W 230V L 430mm W 85mm connection male faston 6.3mm cable length 400mm tube ø 6.3mm defrosting H 70mm		



<b>Part No.</b>	419207	<b>Ref. No.</b>	1666352 PO1666352
<b>description</b>	heating element 350W 230V L 510mm W 340mm connection F 2.8 cable length 1000mm tube ø 8.5mm refrigerator		

## heating elements for condensate evaporation



<b>Part No.</b>	420095	<b>Ref. No.</b>	1666095 PO1666095
<b>description</b>	heating element 95W 230V L 445mm W 60mm H 25mm cable length 4000mm tube ø 6.2mm		

## heating elements for tilting bratt pan



<b>Part No.</b>	415208	<b>Ref. No.</b>	F2001128
<b>description</b>	heating element tilting bratt pan 2000W 230V L 641mm W 87mm H 43mm dry heating element heating circuits 1 tube ø 6.3mm L1 10mm cable length 235mm		

## heating cartridges



<b>Part No.</b>	417227	<b>Ref. No.</b>	1666090 PO1666090
<b>description</b>	heating cartridge 90W 230V ø 12mm L 124mm thread 3/8" cable length 4000mm H mm W mm condensate evaporation		

## pilot heating elements



<b>Part No.</b>	415793	<b>Ref. No.</b>	F7U47107
<b>description</b>	heating element 450W 230V heating circuits 1 L 194mm W 42mm rectangular flange hole distance 62mm hole ø 6.5mm connection M4 tube ø 6.5mm flange length 74mm flange width 63mm immersion heater		
<b>accessories for</b>	415793		
	<b>Part No.</b>	<b>Ref. No.</b>	F7I07004
	gasket silicone L 73mm W 62mm thickness 3mm hole ø 4mm hole distance 62/55mm for heating element		

## immersion heating elements

with expansion flange 70 x 18mm



<b>Part No.</b>	415465	<b>Ref. No.</b>	F7U47139
<b>description</b>	heating element 3000W 230V heating circuits 2 flange 70x18mm L 365mm W 65mm connection male faston 6.3mm tube ø 8.5mm immersion heater expansion flange		
<b>accessories for</b>	415465		
	<b>Part No.</b>	<b>Ref. No.</b>	—
	temperature probe thermocouple K (NiCr-Ni) cable silicone probe -50 up to 1150°C cable -50 up to +180°C connection 2-wire thread probe ø1.5x100mm cable length 1.8m		

## miscellaneous



<b>Part No.</b>	415794	<b>Ref. No.</b>	F7U47101
<b>description</b>	heating element 6000W 230V heating circuits 3 L 360mm W 35mm H 43mm tube ø 8.5mm connection M4 immersion heater rectangular flange hole distance 44mm flange length 74mm flange width 63mm hole ø 6mm		
<b>accessories for</b>	415794		
	<b>Part No.</b>	<b>Ref. No.</b>	F7I07004
	gasket silicone L 73mm W 62mm thickness 3mm hole ø 4mm hole distance 62/55mm for heating element		

## accessories

## sealing washers

## O-rings

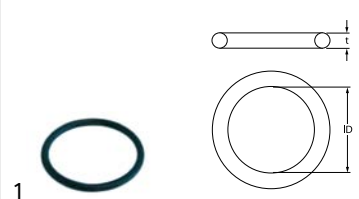

<b>Part No.</b>	510409	<b>Ref. No.</b>	H67500-118
<b>description</b>	O-ring EPDM thickness 5.34mm ID ø 56.52mm Qty 1 pcs		

## flange gaskets

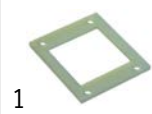

<b>Part No.</b>	510745	<b>Ref. No.</b>	F7I07004
<b>description</b>	gasket silicone L 73mm W 62mm thickness 3mm hole ø 4mm hole distance 62/55mm for heating element		



energy regulators

EGO

1-circuit



<b>Part No.</b>	380015	<b>Ref. No.</b>	51440126
<b>description</b>	energy regulator 230V 13A single-circuit turn direction right shaft ø 6x4.6mm shaft L 23mm mounting thread M4 power release 6-100% no. 50.57021.010		

thermostats

bi-metal thermostats

safety bi-metal thermostats



<b>Part No.</b>	390954	<b>Ref. No.</b>	51440146
<b>description</b>	bi-metal safety thermostat hole distance 23.5mm switch-off temp. 120°C 1NC 1-pole 10A 250V connection F6.3 threaded mounting ø 15mm with reset function		

control and safety thermostats

EGO

control thermostats

55.13\_ series



<b>Part No.</b>	375925	<b>Ref. No.</b>	F2072039
<b>description</b>	thermostat t.max. 190°C 1-pole 1NO probe ø 6mm probe L 79mm capillary pipe 1830mm shaft ø 6x4.6mm shaft L 28mm		

safety thermostats

55.32\_ series



<b>Part No.</b>	375418	<b>Ref. No.</b>	51440160
<b>description</b>	safety thermostat switch-off temp. 340°C 3-pole 20A probe ø 4mm probe L 128mm capillary pipe 1190mm capillary pipe isolatedmm gland nut probe SS		

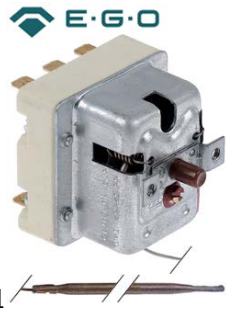

<b>Part No.</b>	375878	<b>Ref. No.</b>	51440167
<b>description</b>	safety thermostat switch-off temp. 570°C 3-pole probe ø 3.9mm probe L 228mm capillary pipe 890mm capillary pipe isolatedmm gland nut starting temperature 530°C		

55.33\_ series



<b>Part No.</b>	375516	<b>Ref. No.</b>	F2072038
<b>description</b>	safety thermostat switch-off temp. 250°C 3-pole 20A probe ø 6mm probe L 107mm capillary pipe 1470mm capillary pipe isolated 1100mm gland nut M9x1 probe SS		



control thermostats with operation switch

55.13\_ series

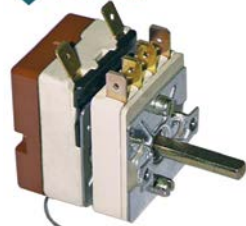

<b>Part No.</b>	375073	<b>Ref. No.</b>	51440140
<b>description</b>	thermostat t.max. 320°C temperature range 50-320°C 1-pole capillary pipe isolated gland nut		

55.34\_ series

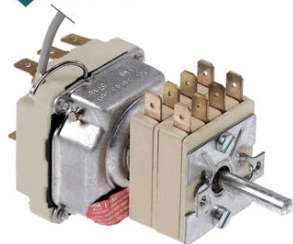

<b>Part No.</b>	375879	<b>Ref. No.</b>	51440191
<b>description</b>	thermostat t.max. 440°C temperature range 100-440°C 3-pole 3NO probe ø 3.9mm probe L 228mm capillary pipe 1110mm capillary pipe isolated 600mm gland nut rotation 270° outer switch 2NO/2NO		



<b>Part No.</b>	375246	<b>Ref. No.</b>	51440169
<b>description</b>	thermostat t.max. 645°C temperature range 100-615/645°C 2-pole 2NO 16A probe ø 4mm probe L 230mm capillary pipe 1100mm capillary pipe isolated 600mm gland nut shaft ø 6x4.6mm shaft L 25mm shaft position lower rotation 270° outer switch 2NO probe material copper		

switches and momentary switches

rocker/momentary rocker switches

27.8x25mm



1

<b>Part No.</b>	348221	<b>Ref. No.</b>	1635110 PO1635110
<b>description</b>	rocker switch mounting measurements 27.8x25mm black/green 1NO/indicator light 250V 16A ON-OFF connection F6.3x0.8 ambient temperature max. 100/55°C protection IP40		

30x22mm



1

<b>Part No.</b>	301314	<b>Ref. No.</b>	1635103 PO1635103
<b>description</b>	rocker switch mounting measurements 30x22mm white 2NO 250V 16A ON-OFF connection male faston 6.3mm ambient temperature max. 100/55°C protection IP40		

cam switches

on/off

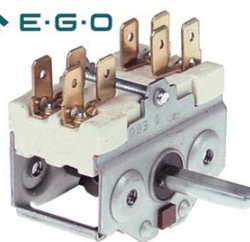

1

<b>Part No.</b>	300074	<b>Ref. No.</b>	51450150
<b>description</b>	cam switch 4 operating positions 2NO sequence 0-1-0-1 16A shaft ø 6x4.6mm shaft L 23mm connection male faston 6.3mm ceramic		



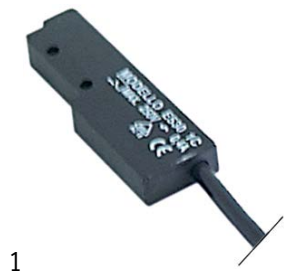

magnetic switches

65x20mm

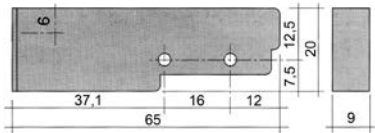

1



<b>Part No.</b>	345116	<b>Ref. No.</b>	161801 PO161801
<b>description</b>	magnetic switch L 65mm W 20mm 1NO 250V 0.4A P max. 100W connection cable cable length 3000mm		
<b>accessories for</b>	345116		
	<b>Part No.</b>	345399	<b>Ref. No.</b> —
	magnet ø 3.3mm L 40mm H 8mm W 13mm hole distance 30mm M3		

lamps

LED

indicator lamps

mounting diameter 24mm



1

<b>Part No.</b>	360603	<b>Ref. No.</b>	51460224
<b>description</b>	indicator light LED mounting ø 24mm 230VAC green connection male faston 2.8mm 0.4W mounting thread M24 L 59mm		



1

<b>Part No.</b>	360602	<b>Ref. No.</b>	51460223
<b>description</b>	indicator light LED mounting ø 24mm 230VAC yellow connection male faston 2.8mm 0.4W mounting thread M24 L 59mm		

relays

power relays

with DIN rail mounting

lateral



1

<b>Part No.</b>	380313	<b>Ref. No.</b>	166550972 PO166550972
<b>description</b>	power relays FINDER 230VAC 16A 3CO connection male faston DIN rail manuf. no. 62.83.8.230.0008		

electronic controllers





ELIWELL

refrigeration controllers

built-in version







1

<b>Part No.</b>	379570	<b>Ref. No.</b>	16811201 PO16811201
<b>description</b>	electronic controller ELIWELL type ID961 mounting measurements 71x29mm 12V voltage AC/DC NTC/PTC relay outputs 1 relay -50 up to +150°C display 3½ digits RoomTempIN yes compressor relay 8A		
<b>accessories for</b>	379570		
	<b>Part No.</b>	379053	<b>Ref. No.</b> —
	temperature probe PTC 1kOhm cable PVC probe -50 up to +150°C cable -10 up to 100°C probe ø6x30mm cable length 3m without screw connection 2-wire		
	<b>Part No.</b>	379064	<b>Ref. No.</b> —
	temperature probe PTC 1kOhm cable silicone probe -50 up to +150°C cable -50 up to +180°C probe ø6x40mm cable length 3m without screw connection 2-wire		
	<b>Part No.</b>	379161	<b>Ref. No.</b> —
	temperature probe NTC 10kOhm cable thermoplastic probe -40 up to +110°C cable -40 up to +110°C probe ø6x14mm cable length 3m without screw connection 2-wire		
	<b>Part No.</b>	379782	<b>Ref. No.</b> —
	temperature probe PTC 1kOhm cable thermoplastic probe -50 up to +150°C cable -40 up to +110°C probe ø6x14mm cable length 3m 2-wire resistor 1kOhm		





			
1			
<b>Part No.</b>	379577	<b>Ref. No.</b>	1681108 PO1681108
<b>description</b>	electronic controller ELIWELL type ID974 mounting measurements 71x29mm 230V voltage AC NTC/PTC relay outputs 3 relays -50 up to +150°C display 3½ digits RoomTempIN yes DEF Probe yes DEF Relay 8A fan relay 5A compressor relay 8A		
<b>accessories for</b>	379577		
	<b>Part No.</b>	<b>Ref. No.</b>	—
	379053		temperature probe PTC 1kOhm cable PVC probe -50 up to +150°C cable -10 up to 100°C probe ø6x30mm cable length 3m without screw connection 2-wire
	379064		temperature probe PTC 1kOhm cable silicone probe -50 up to +150°C cable -50 up to +180°C probe ø6x40mm cable length 3m without screw connection 2-wire
	379161		temperature probe NTC 10kOhm cable thermoplastic probe -40 up to +110°C cable -40 up to +110°C probe ø6x14mm cable length 3m without screw connection 2-wire
	379782		temperature probe PTC 1kOhm cable thermoplastic probe -50 up to +150°C cable -40 up to +110°C probe ø6x14mm cable length 3m 2-wire resistor 1kOhm

## EVCO - EVERY CONTROL

## refrigeration controllers

## built-in version

			
1			
<b>Part No.</b>	378506	<b>Ref. No.</b>	32140974 PO32140974
<b>description</b>	electronic controller EVCO type EVKB23N7PXXSX01 mounting measurements 71x29mm 230V PTC/NTC -40 up to +105°C preprogrammed		

## probes

## universal probes

## temperature probes

			
1			
<b>Part No.</b>	379160	<b>Ref. No.</b>	167212 PO167212
<b>description</b>	temperature probe NTC 10kOhm cable thermoplastic probe -40 up to +110°C cable -40 up to +110°C probe ø6x14mm cable length 1.5m without screw connection 2-wire		

			
1			
<b>Part No.</b>	379052	<b>Ref. No.</b>	167201 PO167201
<b>description</b>	temperature probe PTC 1kOhm cable silicone probe -50 up to +150°C cable -50 up to +180°C probe ø6x40mm cable length 1.5m without screw connection 2-wire		

## producer-specific probes

## core probes

			
1			
<b>Part No.</b>	401756	<b>Ref. No.</b>	167230 PO167230
<b>description</b>	core temperature probe PTC 1kOhm cable silicone probe -40 up to +120°C cable -50 up to +180°C connection 2-wire probe ø4.5x100mm thread cable length 4.5m handle ø 10mm handle length 120mm L1 150mm L2 50mm		

## keypads

## front foils

			
1			
<b>Part No.</b>	401772	<b>Ref. No.</b>	14261050 PO14261050
<b>description</b>	keypad foil blast chiller L 212mm W 102mm buttons 9 POLARIS		



compressors

ACC/ZEL

R134A

HMBP monophase

High/Medium evaporation temperature above -20/-15 °C



1

<b>Part No.</b>	605008	<b>Ref. No.</b>	141565100030 PO141565100030
<b>description</b>	compressor coolant R134a type GL80TB 220-240V 50Hz HMBP fully hermetic 9.5kg 1/5HP power input 554W cylinder capacity 7.6cm <sup>3</sup> CSIR H 175.5mm 165W 215W 290W 390W 500W 615W 727W 840W test method ASHRAE ambient temperature max. 43°C		

L'UNITE HERMETIQUE / TECUMSEH

R404A

HMBP monophase

High/Medium evaporation temperature above -20/-15 °C



1

<b>Part No.</b>	605023	<b>Ref. No.</b>	141565100040 PO141565100040
<b>description</b>	compressor coolant R404A type AE4450Z 220-240V 50Hz HMBP fully hermetic 12.5kg 3/8HP cylinder capacity 8.85cm <sup>3</sup> CSIR H 207mmWW 434W 567W 734W 927W 1270W 1367W test method EN 12900 1729W		

SECOP DANFOSS

R134A

HMBP monophase

High/Medium evaporation temperature above -20/-15 °C



1

<b>Part No.</b>	605089	<b>Ref. No.</b>	141514208850 PO141514208850
<b>description</b>	compressor coolant R134a type NL8.4MF 220-240V 50Hz HMBP fully hermetic 10.5kg 1/4HP cylinder capacity 8.35cm <sup>3</sup> RSIR/CSIR H 197mmW 235W 305W 390W 491W 610W 749W 912W test method ASHRAE		
<b>spare parts for</b>	605089		
	<b>Part No.</b>	381528	<b>Ref. No.</b> —
	start relay DANFOSS 117U6016 HST		

evaporation and condensing trays

condensing trays heated

universal

heating cartridges



1

<b>Part No.</b>	417227	<b>Ref. No.</b>	1666090 PO1666090
<b>description</b>	heating cartridge 90W 230V ø 12mm L 124mm thread 3/8" cable length 4000mm Hmm Wmm condensate evaporation		







## fans

## axial fans

## import





1

<b>Part No.</b>	601080 <sup>1</sup>	<b>Ref. No.</b>	1648110155 PO1648110155
<b>description</b>	axial fan L 119mm W 119mm H 38mm 230VAC 50/60Hz 23/20W bearing ball bearing connection male faston 2.8mm metal ADDA fan wheel ø 110mm temp.-resist. 70°C		
<b>accessories for</b>	601080		
	<b>Part No.</b>	550898	<b>Ref. No.</b> —
	connecting cable cable length 2000mm connection F 2.8 connection distance 7.9mm for axial flow fan		
	<b>Part No.</b>	692519	<b>Ref. No.</b> —
	guard L 120mm W 120mm plastic		

<sup>1</sup>with ball bearings

1

<b>Part No.</b>	601055 <sup>1</sup>	<b>Ref. No.</b>	1648110150 PO1648110150
<b>description</b>	axial fan L 92mm W 92mm H 25mm 230VAC 50/60Hz 14.5/14W bearing ball bearing connection male faston 2.8mm metal ADDA fan wheel ø 85mm temp.-resist. 70°C		
<b>accessories for</b>	601055		
	<b>Part No.</b>	550898	<b>Ref. No.</b> —
	connecting cable cable length 2000mm connection F 2.8 connection distance 7.9mm for axial flow fan		
	<b>Part No.</b>	691103	<b>Ref. No.</b> —
	guard ø 90mm mounting distance 83mm for axial fan 92mm		

<sup>1</sup>with ball bearings

## refrigeration fans

## refrigeration motors universal

## IMPORT

## multi fit fan motors



1

<b>Part No.</b>	601022	<b>Ref. No.</b>	1648001015 PO1648001015
<b>description</b>	fan motor 10W 230V 50-60Hz L1 44mm L2 54mm L3 85mm W 84mm cable length 500mm 1300rpm YZF10-20-18/26 5 mounting options bearing slide bearing		

## cross flow fans

## ebm-papst



1

<b>Part No.</b>	601000	<b>Ref. No.</b>	1648106045 PO1648106045
<b>description</b>	cross flow fan ebm-papst QLK45/0006-2513 roller ø 45mm roller length 60mm laminated core thickness 13mm motor position left 230V/50Hz 15W refrigeration bearing rubber connection male faston 6.3mm airflow 36m³/h 0 up to +60°C		



1









<b>Part No.</b>	601505	<b>Ref. No.</b>	51470402
<b>description</b>	cross flow fan QLN65/2400A17-3030L roller ø 65mm roller length 240mm laminated core thickness 29mm motor position right 230V/50Hz 22W refrigeration bearing silicone connection F 6.3 0 up to +60°C 230V throughput 200m³/h 50Hz		









EMMEVI - FERGAS			
with moulded coils			
			
1			
Part No.	601110	Ref. No.	1648106018 PO1648106018
description	cross flow fan TGO 60/1-180/20 roller ø 60mm roller length 180mm laminated core thickness 20mm motor position left 230V/50Hz 28W refrigeration bearing rubber connection male faston 6.3mm -30 up to +100°C 230V cable length 1800mm		

## gas taps

### alternatives to EGA

GPEL21 series				
with nozzle outlet				
				
1				
Part No.	101615	Ref. No.	52110220	
description	gas tap alternatives to EGA type GPEL21D with nozzle outlet (without nozzle) gas inlet M15x1 (tube ø 10mm) external nozzle ømm internal nozzle ømm bypass nozzle ø 0.35mm mixing pipe connection M17x1 thermocouple connection M8x1 pilot connection M10x1 shaft ø 8x6.5mm shaft L 31/15mm shaft flat upper and bottom			
spare parts for	101615			
	Part No.	100408	Ref. No.	—
bypass nozzle type PEL20/21 bore ø 0.35mm thread M5x0.5				
	Part No.	101060	Ref. No.	—
magnet unit standard L 39mm D1 ø 15.4mm D2 ø 11mm suitable for PEL20-21/JUNKERS/EGA				
	Part No.	101230	Ref. No.	—
thermocouple nut T1: M8x1 T2: M18x1 aluminium				
	Part No.	101808	Ref. No.	—
gas tap front part shaft ø 8x6.5mm shaft L 31/15mm shaft flat upper and bottom suitable for PEL21				
accessories for	101615			
	Part No.	100908	Ref. No.	—
union screw thread M10x1 for pipe ø 4mm Qty 1 pcs				
	Part No.	100909	Ref. No.	—
union screw thread M10x1 for pipe ø 6mm Qty 1 pcs				
	Part No.	100926	Ref. No.	—
centring piece thread M17x1				
	Part No.	100927	Ref. No.	—
torsion spring L 2.8-8.0mm for internal nozzle ø 3mm bore ømm				

accessories for	101615			
	Part No.	100942	Ref. No.	—
union nut thread M15x1 for pipe ø 10mm				
	Part No.	100943	Ref. No.	52150025
union nut thread M17x1 tube ø 10mm				
	Part No.	101246	Ref. No.	—
olive for pipe ø 4mm Qty 1 pcs				
	Part No.	101278	Ref. No.	52150320
olive for pipe ø 10mm Qty 1 pcs				
	Part No.	101286	Ref. No.	—
olive ID ø 6mm Qty 1 pcs				
	Part No.	110217	Ref. No.	—
knob gas tap with ignition flame ø 64mm shaft ø 9x7mm shaft flat horizontal black				

## STN3R

			
1			
Part No.	107335	Ref. No.	52113010 52113035
description	gas tap STN3R gas inlet pipe flange ø21mm gas outlet M17x1 (tube ø 10mm) thermocouple connection M8x1 shaft ø 6x4.6mm shaft L 25/15mm shaft flat lower with pipe outlet suitable for LOHBERGER		

## ignition parts

### pilot burners















JUNKERS				
CB 503 series				
pilot burners				
				
1				
Part No.	100058	Ref. No.	F2119021	
description	pilot burner JUNKERS type CB503006 natural gas nozzle no.26 gas connection 4mm			
spare parts for	100058			
	Part No.	100224	Ref. No.	—
pilot burner nozzle natural gas gas pressure 25mbar code 26 Qty 1 pcs suitable for JUNKERS CB503_				
	Part No.	101281	Ref. No.	—
olive for pipe ø 4mm L 8.7mm Qty 1 pcs suitable for CB 502/503				

Table continues overleaf



<b>spare parts for</b> 100058	
	Part No. 101283 Ref. No. — union screw thread M10x1 for pipe ø 4mm Qty 1 pcs
<b>accessories for</b> 100058	
	Part No. 100220 Ref. No. — pilot burner nozzle LPG gas pressure 50mbar code 2 Qty 1 pcs suitable for JUNKERS CB503_
	Part No. 100221 Ref. No. — pilot burner nozzle LPG gas pressure 30mbar code 29 Qty 1 pcs suitable for JUNKERS CB50203_
	Part No. 100222 Ref. No. — pilot burner nozzle LPG gas pressure 50mbar code 5 Qty 1 pcs suitable for JUNKERS CB50203_
	Part No. 100223 Ref. No. — pilot burner nozzle natural gas gas pressure 20mbar code 3 Qty 1 pcs suitable for JUNKERS CB503_
	Part No. 100226 Ref. No. — pilot burner nozzle LPG gas pressure 50mbar code 15 suitable for JUNKERS
	Part No. 100227 Ref. No. — pilot burner nozzle natural gas gas pressure 25mbar code 6 Qty 1 pcs suitable for JUNKERS CB50203_
	Part No. 100228 Ref. No. — pilot burner nozzle town gas gas pressure 8mbar code 4 Qty 1 pcs suitable for JUNKERS CB50203_
	Part No. 100909 Ref. No. — union screw thread M10x1 for pipe ø 6mm Qty 1 pcs
	Part No. 101287 Ref. No. — olive for pipe ø 6mm Qty 1 pcs
	Part No. 102110 Ref. No. — pilot tube copper pipe ø 4mm thickness 1mm L 3000mm
	Part No. 102111 Ref. No. — pilot tube copper pipe ø 6mm thickness 1mm L 3000mm

producer-specific pilot burners

LOHBERGER

old version



1	<b>Part No.</b> 102956	<b>Ref. No.</b> —	—
<b>description</b> pilot burner type C without nozzle			

1	
<b>Part No.</b> 102957	<b>Ref. No.</b> —
<b>description</b> pilot burner type D without nozzle	

1	
<b>Part No.</b> 102958	<b>Ref. No.</b> —
<b>description</b> pilot burner type E without nozzle	

electrodes

1	
<b>Part No.</b> 102965	<b>Ref. No.</b> 52165040
<b>description</b> ignition electrode connection F 2.8x0.8mm	

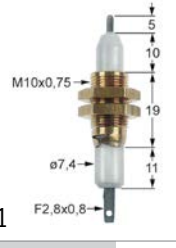
1	
<b>Part No.</b> 103247	<b>Ref. No.</b> 52152050
<b>description</b> ignition electrode D1 ø 7.4mm L1 5mm BL1 10mm BL2 19mm BL3 11mm connection F 2.8x0.8mm M10x0.75	

piezoelectric igniters

mounting diameter 22mm

1	
<b>Part No.</b> 100008	<b>Ref. No.</b> F2119024
<b>description</b> piezoelectric igniter body plastic blowing mounting ø 22mm connection ø2mm cable lengthmm	



thermocouples

threaded thermocouples

threaded thermocouples standard

with socket with thread M8x1

SIT

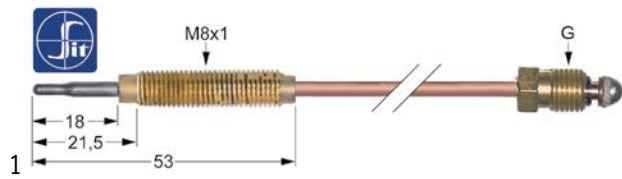

<b>Part No.</b>	107632	<b>Ref. No.</b>	52120050
<b>description</b>	thermocouple SIT M8x1 L 1000mm M8x1		
<b>accessories for</b>	107632		
	<b>Part No.</b>	102067	<b>Ref. No.</b> 52150110
	nut thread M8x1 H 3mm brass Qty 1 pcs type SEF 1		

accessories

nuts



<b>Part No.</b>	102067	<b>Ref. No.</b>	52150110
<b>description</b>	nut thread M8x1 H 3mm brass Qty 1 pcs type SEF 1		

gas burners

accessories

nozzle holders



<b>Part No.</b>	104522	<b>Ref. No.</b>	52165016
<b>description</b>	nozzle holder ID ø 10mm ET M17x1		

gas nozzles

pilot burner nozzles

pilot burner nozzles EGA





<b>Part No.</b>	100214	<b>Ref. No.</b>	52140300
<b>description</b>	pilot burner nozzle LPG bore ø 0.16mm Qty 1 pcs		

auxiliary gas parts



screw connections

olives



<b>Part No.</b>	101278	<b>Ref. No.</b>	52150320
<b>description</b>	olive for pipe ø 10mm Qty 1 pcs		
<b>accessories for</b>	101278		
	<b>Part No.</b>	100943	<b>Ref. No.</b> 52150025
	union nut thread M17x1 tube ø 10mm		
	<b>Part No.</b>	101300	<b>Ref. No.</b> —
	union nut thread M16x1.5 tube ø 10mm		
	<b>Part No.</b>	101478	<b>Ref. No.</b> —
	union nut thread 3/8" for pipe ø 10mm		



<b>Part No.</b>	101284	<b>Ref. No.</b>	52150310
<b>description</b>	olive for pipe ø 4mm Qty 1 pcs		
<b>accessories for</b>	101284		
	<b>Part No.</b>	101259	<b>Ref. No.</b> —
	union nut thread M8x1 for pipe ø 4mm		
	<b>Part No.</b>	101285	<b>Ref. No.</b> 52150210
	union screw thread M8x1 for pipe ø 4mm Qty 1 pcs JUNKERS		
	<b>Part No.</b>	101294	<b>Ref. No.</b> —
	union nut thread M10x1 for pipe ø 4mm WS 14 L 12mm Qty 1 pcs		

union nuts



<b>Part No.</b>	100943	<b>Ref. No.</b>	52150025
<b>description</b>	union nut thread M17x1 tube ø 10mm		
<b>accessories for</b>	100943		
	<b>Part No.</b>	101278	<b>Ref. No.</b> 52150320
	olive for pipe ø 10mm Qty 1 pcs		



union screws



1

<b>Part No.</b>	101285	<b>Ref. No.</b>	52150210
<b>description</b>	union screw thread M8x1 for pipe ø 4mm Qty 1 pcs JUNKERS		
<b>accessories for</b>	101285		
	<b>Part No.</b>	101284	<b>Ref. No.</b> 52150310
	olive for pipe ø 4mm Qty 1 pcs		

equipment-specific units

for espresso machines

brewing units

filter holder gaskets

O-rings



1

<b>Part No.</b>	510409	<b>Ref. No.</b>	H67500-118
<b>description</b>	O-ring EPDM thickness 5.34mm ID ø 56.52mm Qty 1 pcs		

locks

locking devices

producer-specific

LOHBERGER



1

<b>Part No.</b>	690462	<b>Ref. No.</b>	1483001 1483003 PO1483001 PO1483003
<b>description</b>	key cylinder ø 23mm thread M19x1 mounting measurements 16.5x19mm hub 38-45mm shaft ø 11mm thread L 12mm		
<b>spare parts for</b>	690462		
	<b>Part No.</b>	691589	<b>Ref. No.</b> —
	spare keys for key cylinder 690462 key number 9233		



1

<b>Part No.</b>	690637	<b>Ref. No.</b>	14830061 PO14830061
<b>description</b>	key cylinder with slide latch ø 23mm thread M19x1 mounting measurements 16.5x19mm hub 38-45mm shaft ø 11mm thread L 24mm		

hinges

spring assisted hinges

universal

CAFF/FERMOD

group 2



1

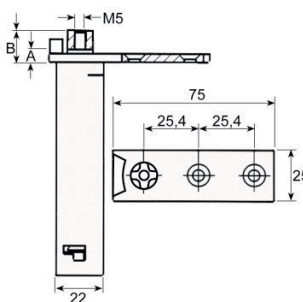

<b>Part No.</b>	690494	<b>Ref. No.</b>	1412001 PO1412001
<b>description</b>	spring assisted hinge series 175 mounting pos. left/right torx L 75mm W 25.6mm H 100mm A 4mm B 11mm mounting measurements 22x22mm intake torx refrigeration units mounting distance 25mm		



## INTERKLIMAT

### hinges



1

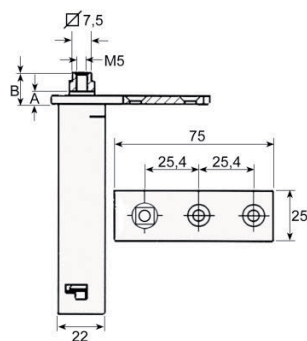

<b>Part No.</b>	690622	<b>Ref. No.</b>	1412050 PO1412050
<b>description</b>	spring assisted hinge series 28L mounting pos. left/right L 75mm W 25mm H 103mm A 13mm B 18mm mounting measurements 22x22mm intake 7.5x7.5 refrigeration units		

## shelves and shelf rails

### grates

#### universal

#### with upstand



1

<b>Part No.</b>	970807	<b>Ref. No.</b>	1440050530 PO1440050530
<b>description</b>	grate W 530mm D 500mm H 40mm plastic-coated steel wire gauge frame 8.8mm lengthwise wires gauge 4.8mm crossing wires 1 grey		

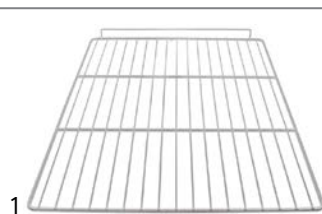

1

<b>Part No.</b>	970556	<b>Ref. No.</b>	1440065530 PO1440065530
<b>description</b>	grate W 530mm D 650mm GN 2/1 plastic-coated steel with hinge camp wire gauge frame 9mm lengthwise wires gauge 5mm crossing wires 2 white suitable for refrigerator		
<b>accessories for</b>	970556		
	<b>Part No.</b>	690330	<b>Ref. No.</b> —
	rack L 1000mm W 22mm H 4mm aperture 3x8mm hole distance 12.5mm stainless steel		

<b>accessories for</b>	970556		
	<b>Part No.</b>	690332	<b>Ref. No.</b> —
	shelf support L 31/28mm W 22mm H 17mm SS with hook Qty 1 pcs		
	<b>Part No.</b>	694700	<b>Ref. No.</b> —
	shelf support L 31/28mm W 22mm H 18mm SS Qty 12 pcs		
	<b>Part No.</b>	694701	<b>Ref. No.</b> —
	shelf support L 31/28mm W 22mm H 17mm SS with hook Qty 12 pcs		

### producer-specific



1

<b>Part No.</b>	970662	<b>Ref. No.</b>	1440055535 PO1440055535
<b>description</b>	grate W 530mm D 550mm with layer RILSAN		

### grid attachments



1

<b>Part No.</b>	970661	<b>Ref. No.</b>	33510070 PO33510070
<b>description</b>	bearing rail L 600mm H 34.2mm W 17mm		

### shelf rails and supports

#### producer-specific

1

<b>Part No.</b>	700846	<b>Ref. No.</b>	3351300030 PO3351300030
<b>description</b>	pair of setting bar U-shape L 540mm W 30mm		



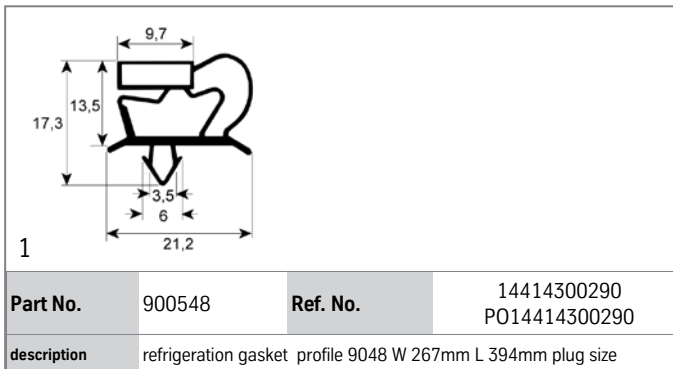
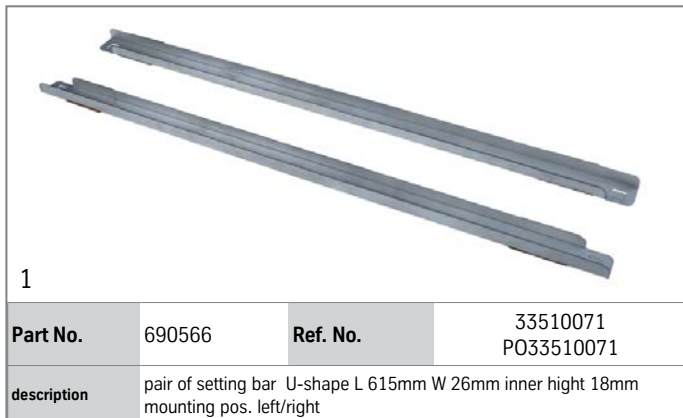

## gaskets

### refrigeration gaskets

#### plug-in gaskets

#### profile 9048

We offer custom-made gaskets for this profile

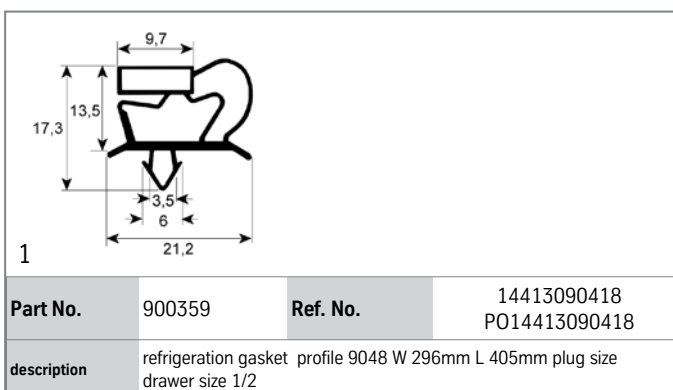
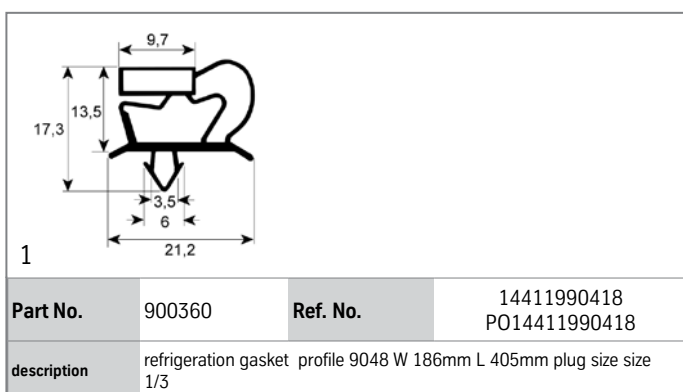
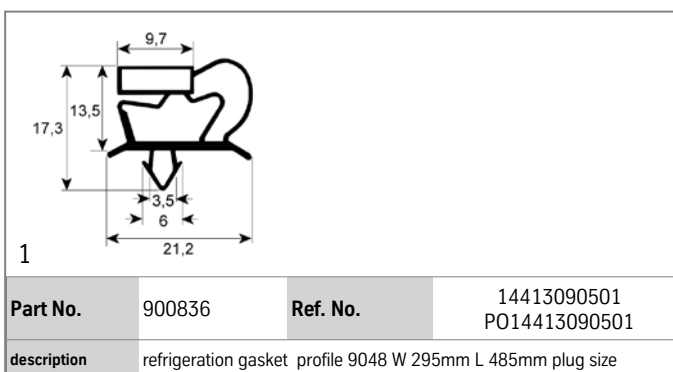
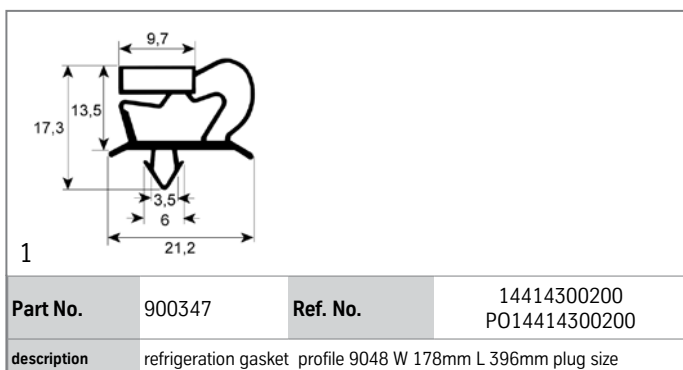
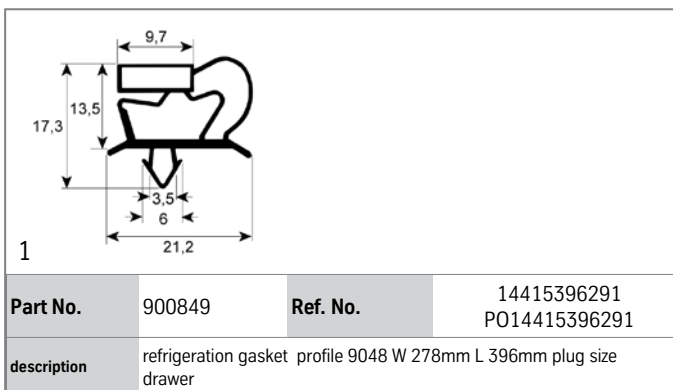
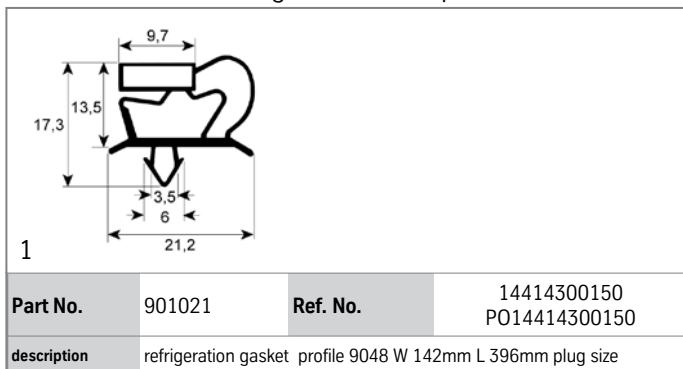



1

<b>Part No.</b>	901778	<b>Ref. No.</b>	14412950408 PO14412950408
<b>description</b>	refrigeration gasket profile 9048 W 300mm L 410mm plug size		

1

<b>Part No.</b>	901020	<b>Ref. No.</b>	14414020516 PO14414020516
<b>description</b>	refrigeration gasket profile 9048 W 402mm L 516mm plug size		

1

<b>Part No.</b>	900831	<b>Ref. No.</b>	14414300390 PO14414300390
<b>description</b>	refrigeration gasket profile 9048 W 354mm L 396mm plug size drawer size 2/3		

1

<b>Part No.</b>	900358	<b>Ref. No.</b>	14414180418 PO14414180418
<b>description</b>	refrigeration gasket profile 9048 W 405mm L 405mm plug size drawer size 2/3		

1

<b>Part No.</b>	901234	<b>Ref. No.</b>	14416600390 PO14416600390
<b>description</b>	refrigeration gasket profile 9048 W 390mm L 660mm plug size for blast chiller		

1

<b>Part No.</b>	900830	<b>Ref. No.</b>	14414080540 PO14414080540
<b>description</b>	refrigeration gasket profile 9048 W 405mm L 535mm plug size door		

1

<b>Part No.</b>	900731	<b>Ref. No.</b>	14414300620 PO14414300620
<b>description</b>	refrigeration gasket profile 9048 W 396mm L 566mm plug size		

1

<b>Part No.</b>	900357	<b>Ref. No.</b>	14414180640 PO14414180640
<b>description</b>	refrigeration gasket profile 9048 W 405mm L 627mm plug size door for refrigerated counter size 1/1		

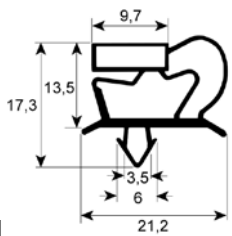
1

<b>Part No.</b>	901015	<b>Ref. No.</b>	14415601460 PO14415601460
<b>description</b>	refrigeration gasket profile 9048 W 560mm L 1460mm plug size		

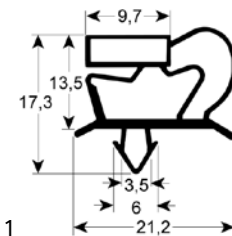

1

<b>Part No.</b>	900355	<b>Ref. No.</b>	14416760784 PO14416760784
<b>description</b>	refrigeration gasket profile 9048 W 663mm L 767mm plug size		

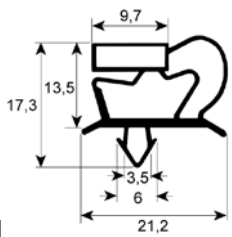

1

<b>Part No.</b>	900838	<b>Ref. No.</b>	14416451606 PO14416451606
<b>description</b>	refrigeration gasket profile 9048 W 606mm L 1566mm plug size		

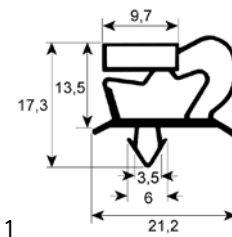

1

<b>Part No.</b>	900732	<b>Ref. No.</b>	14416801580 PO14416801580
<b>description</b>	refrigeration gasket profile 9048 W 684mm L 1584mm plug size		

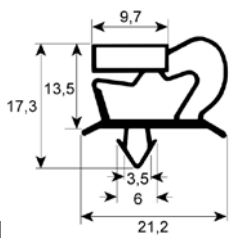

1

<b>Part No.</b>	900839	<b>Ref. No.</b>	14415990738 PO14415990738
<b>description</b>	refrigeration gasket profile 9048 W 606mm L 744mm plug size door		

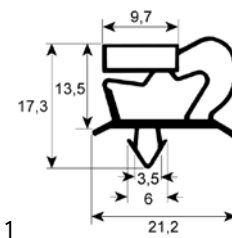

1

<b>Part No.</b>	900733	<b>Ref. No.</b>	14416800759 PO14416800759
<b>description</b>	refrigeration gasket profile 9048 W 684mm L 762mm plug size		

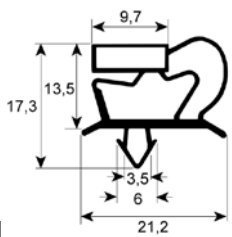

1

<b>Part No.</b>	900795	<b>Ref. No.</b>	14416451605 PO14416451605
<b>description</b>	refrigeration gasket profile 9048 W 645mm L 1605mm plug size door		

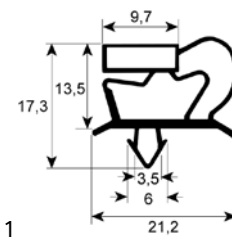

1

<b>Part No.</b>	900841	<b>Ref. No.</b>	14417000780 PO14417000780
<b>description</b>	refrigeration gasket profile 9048 W 700mm L 780mm plug size		

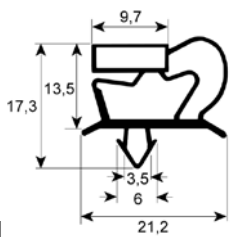

1

<b>Part No.</b>	900356	<b>Ref. No.</b>	14416761594 PO14416761594
<b>description</b>	refrigeration gasket profile 9048 W 660mm L 1580mm plug size		

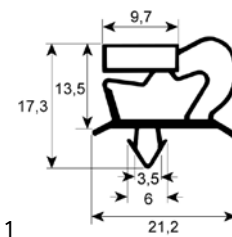

1

<b>Part No.</b>	900837	<b>Ref. No.</b>	14417321850 PO14417321850
<b>description</b>	refrigeration gasket profile 9048 W 732mm L 1848mm plug size		



profile 9703

We offer custom-made gaskets for this profile

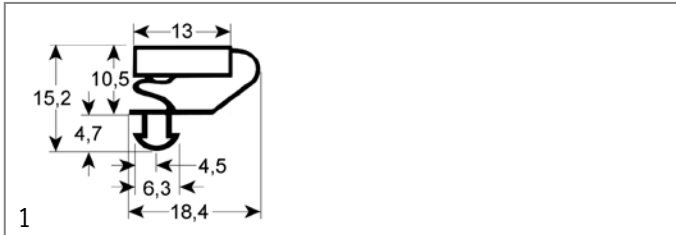

<b>Part No.</b>	900843	<b>Ref. No.</b>	14426761595 PO14426761595
<b>description</b>	refrigeration gasket profile 9703 W 712mm L 1610mm plug size door		

profile 9794

We offer custom-made gaskets for this profile

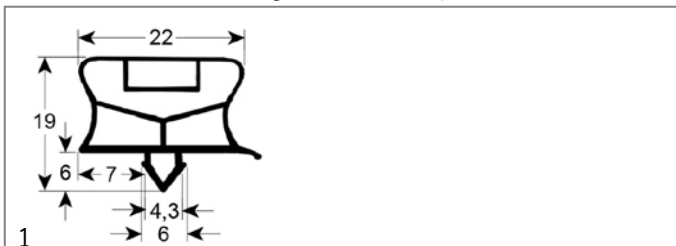

<b>Part No.</b>	901413	<b>Ref. No.</b>	14415010640 PO14415010640
<b>description</b>	refrigeration gasket profile 9794 W 480mm L 625mm plug size		

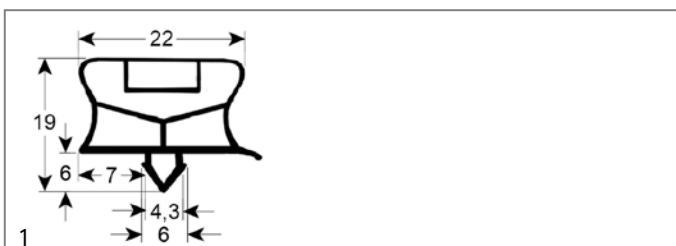

<b>Part No.</b>	900344	<b>Ref. No.</b>	14415991559 PO14415991559
<b>description</b>	refrigeration gasket profile 9794 W 595mm L 1565mm plug size		

gaskets for heated units

door seals

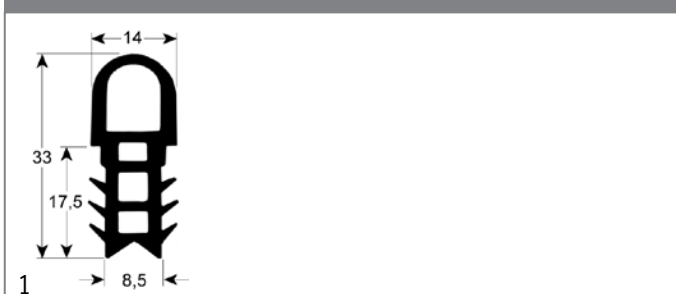

<b>Part No.</b>	900064	<b>Ref. No.</b>	F5070120
<b>description</b>	door seal profile 2060 W 705mm L 1080mm outer plug size Qty 1 suitable for CONVOTHERM short side open		

O-rings

EPDM

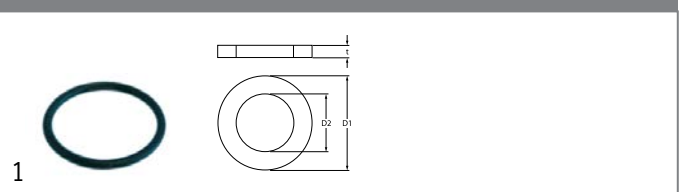

<b>Part No.</b>	510409	<b>Ref. No.</b>	H67500-118
<b>description</b>	O-ring EPDM thickness 5.34mm ID ø 56.52mm Qty 1 pcs		

evaporators

for fridges

producer-specific

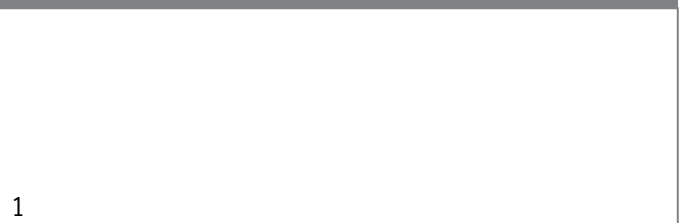

<b>Part No.</b>	750267	<b>Ref. No.</b>	14330309240 PO14330309240
<b>description</b>	evaporator		

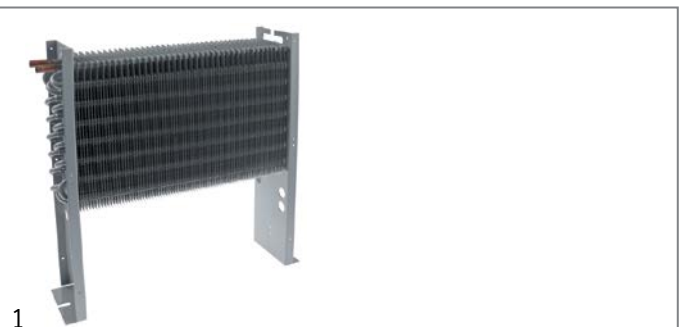

<b>Part No.</b>	750386	<b>Ref. No.</b>	14330210187 PO14330210187
<b>description</b>	evaporator L 350mm W 90mm H 375mm Dmm overall width 395mm connection 3/8"mm mounting distance 1 350mm		



<b>Part No.</b>	750269	<b>Ref. No.</b>	14330210186 PO14330210186
<b>description</b>	evaporator L 350mm W 90mm H 375mm overall width 400mm connection 3/8"mm mounting distance 1 350mm with boiler		



1

<b>Part No.</b>	750306	<b>Ref. No.</b>	14330210175 PO14330210175
<b>description</b>	evaporator L 380mm W 75mm H 270mm		



1

<b>Part No.</b>	750292	<b>Ref. No.</b>	14330210167 14330210168 PO14330210167 PO14330210168
<b>description</b>	evaporator L 400mm W 70mm H 390mm		



1

<b>Part No.</b>	750362	<b>Ref. No.</b>	1433110401 PO1433110401
<b>description</b>	evaporator L 435mm W 405mm H 120mm complete with fan		



1

<b>Part No.</b>	750268	<b>Ref. No.</b>	14330312410 PO14330312410
<b>description</b>	evaporator L 500mm W 70mm H 160mm		

## hose reels and spray guns

### spray guns



1

<b>Part No.</b>	540302	<b>Ref. No.</b>	20601006 VO-2060.1006	
<b>description</b>	spray gun for appliances 1/2" ET L 135mm type RATIONAL			
<b>spare parts for</b>	540302			
	<b>Part No.</b>	517056	<b>Ref. No.</b>	—
	O-ring EPDM thickness 2mm ID ø 6.5mm Qty 1 pcs			
	<b>Part No.</b>	532535	<b>Ref. No.</b>	—
	O-ring EPDM thickness 5mm ID ø 10mm Qty 1 pcs			
	<b>Part No.</b>	548016	<b>Ref. No.</b>	—
	compression spring ø 10mm L 17mm wire gauge ø 0.9mm for hand spray			
	<b>Part No.</b>	548017	<b>Ref. No.</b>	—
	pressure bolt for hand spray			

## valves and tank inlets

### tank inlets

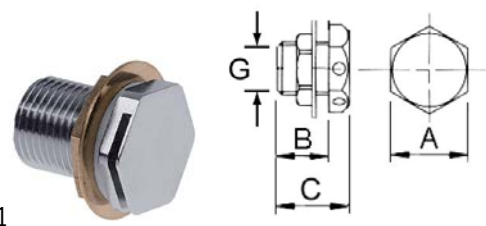

1

<b>Part No.</b>	691605	<b>Ref. No.</b>	519.10300
<b>description</b>	tank inlet connection 1/2" WS 27 L1 26mm L2 32mm with non-return valve		

## fastening material

### screws

#### hexagonal screws



1

<b>Part No.</b>	560084	<b>Ref. No.</b>	51272162
<b>description</b>	hexagonal screw thread M5 thread L 16mm SS WS 8 Qty 20 pcs DIN 933 / ISO 4017		



nuts

hexagonal nuts

hexagonal nuts metric (without norm)



1

<b>Part No.</b>	102067	<b>Ref. No.</b>	52150110
-----------------	--------	-----------------	----------

<b>description</b>	nut thread M8x1 H 3mm brass Qty 1 pcs type SEF 1		
--------------------	--	--	--

fasteners

slot nuts



1

<b>Part No.</b>	697784	<b>Ref. No.</b>	52423002
-----------------	--------	-----------------	----------

<b>description</b>	slot nut W 8mm H 7mm L 20mm		
--------------------	-----------------------------	--	--



1

<b>Part No.</b>	560288	<b>Ref. No.</b>	52423004
-----------------	--------	-----------------	----------

<b>description</b>	slot nut W 8mm H 7mm L 25mm		
--------------------	-----------------------------	--	--



**GASTRO**PARTS.COM

