



**GASTROPARTS**

# Lincar

- [EN]** Equipment
- [DE]** Geräte
- [ES]** Aparatos
- [FR]** Équipement
- [IT]** Attrezzature
- [PL]** Urządzenia
- [RU]** Оборудование

✉ [gastroparts@gastroparts.com](mailto:gastroparts@gastroparts.com)

☎ +48 56 657 00 66

📘 [fb.com/gastroparts.global](https://fb.com/gastroparts.global)

**GASTROPARTS.COM**





## heating elements

### heating elements for ovens

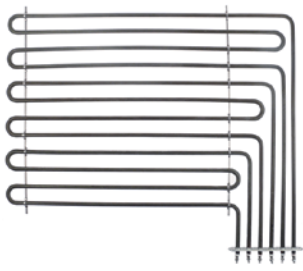

1

<b>Part No.</b>	420483	<b>Ref. No.</b>	38000205
<b>description</b>	heating element 2700W 230V L 496mm W 615mm L1 90mm L2 405mm W1 480mm W2 125mm flange length 158mm flange width 22mm hole distance 145mm hole ø 4mm tube ø 8.5mm connection screw heating circuits 3 mounting thread M4 oven		
<b>For models:</b>	G0009, G0010, G0104, G0107, G0114, G0117, G0122, G0704, G0705, G0776, G0777		

### heating elements for fryers

off-center connection

with thread





1

<b>Part No.</b>	420482	<b>Ref. No.</b>	38000230
<b>description</b>	heating element 12000W 230V heating circuits 3 L 315mm W 175mm H 32mm flange length 26mm flange ø1 62mm sensor screw connection M10x1 number of thermostat sleeves 2 thermostat sleeve upper/lower L1 15mm L2 300mm W1 30mm W2 33mm for o-ring ø 51/56mm tube ø 8.5mm cable length 515mm connection cable		
<b>For models:</b>	G1110, G1112		

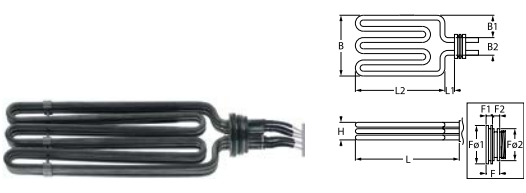
center connection



1

<b>Part No.</b>	416824	<b>Ref. No.</b>	3800229
<b>description</b>	heating element 7000W 230/400V heating circuits 3 L 325mm W 110mm H 33mm flange length 19.5mm flange length 1 9.5mm flange length 2 9.8mm flange ø1 62mm flange ø2 57mm thermostat sleeves ø 8mm sensor screw connection 2x M10x1 thermostat sleeve upper/lower L1 18mm L2 307mm W1 40mm W2 35mm thread M54x1.5 tube ø 8.5mm cable length 520mm rotation flange immersion heater fryer connection length 50mm 2		
<b>spare parts for</b>	416824		
	<b>Part No.</b>	510243	<b>Ref. No.</b> —
	O-ring Viton thickness 3.53mm ID ø 55.56mm Qty 1 pcs		
	<b>Part No.</b>	550496	<b>Ref. No.</b> —
	O-ring Viton thickness 3.53mm ID ø 50.39mm Qty 1 pcs		

<b>accessories for</b>	416824		
	<b>Part No.</b>	550447	<b>Ref. No.</b> —
	ring nut thread M54x1.5		

### heating elements for griddles



1

<b>Part No.</b>	420478	<b>Ref. No.</b>	38000211
<b>description</b>	heating element 1800W 230V heating circuits 1 L 425mm W 84mm H 76mm tube ø 8.5mm		
<b>For models:</b>	G1025, G1026, G1029, G1030, G1035, G1036, G1039, G1040, G1043, G1044		

### heating elements for tilting bratt pan



1

<b>Part No.</b>	415250	<b>Ref. No.</b>	38000218
<b>description</b>	heating element gril 1650W 230V L 490mm W 42mm H 45mm connection M4 dry heating element heating circuits 1 tube ø 8.5mm 2 hole fixing thread 1/4" mounting distance 37mm		



1

<b>Part No.</b>	416692	<b>Ref. No.</b>	38000248
<b>description</b>	heating element tilting bratt pan 2900W 230V L 312mm W 200mm H 82mm connection M5 dry heating element heating circuits 1 tube ø 8.5mm W1 66mm W2 68mm connection distance 61mm		
<b>For models:</b>	G1701, G1705		

### heating elements for pasta cookers



1

<b>Part No.</b>	419214	<b>Ref. No.</b>	38000207
<b>description</b>	heating element 1840W 230V heating circuits 1 L 277mm W 60mm connection M4 thread M12x1 tube ø 8.5mm		
<b>For models:</b>	G1210, G1211		



1





<b>Part No.</b>	418032	<b>Ref. No.</b>	38000234
<b>description</b>	heating element 2000W 240V heating circuits 1 L 280mm W 75mm Hmm 2 hole fixing connection M4 thread 1/4" tube ø 8.5mm mounting distance 67mm pasta cooker		
<b>accessories for</b>	418032		
	<b>Part No.</b>	361182	<b>Ref. No.</b> —
	nut thread 1/4" H 5mm nickel-plated brass WS 17 Qty 1 pcs		
	<b>Part No.</b>	510417	<b>Ref. No.</b> —
	flat gasket fibre ED ø 20mm ID ø 14mm thickness 2mm Qty 1 pcs		

Table continues overleaf



<b>accessories for</b>	418032		
	Part No.	520228	Ref. No. —
	tooth lock washer ID $\varnothing$ 15.3mm ED $\varnothing$ 24mm steel Qty 1 pcs for thread M14		
	Part No.	550262	Ref. No. —
	flat gasket copper ED $\varnothing$ 20mm ID $\varnothing$ 14mm thickness 2mm		



<b>Part No.</b>	416077	<b>Ref. No.</b>	38000235
<b>description</b>	heating element 2520/3000W 220/240V heating circuits 1 L 445mm W 66mm Hmm 2 hole fixing connection M4 thread 1/4" tube $\varnothing$ 8.5mm mounting distance 58mm connection length 34mm pasta cooker immersion heater		

<b>accessories for</b>	416077		
	Part No.	361182	Ref. No. —
	nut thread 1/4" H 5mm nickel-plated brass WS 17 Qty 1 pcs		
	Part No.	510417	Ref. No. —
	flat gasket fibre ED $\varnothing$ 20mm ID $\varnothing$ 14mm thickness 2mm Qty 1 pcs		
	Part No.	520228	Ref. No. —
	tooth lock washer ID $\varnothing$ 15.3mm ED $\varnothing$ 24mm steel Qty 1 pcs for thread M14		
	Part No.	521103	Ref. No. —
	nut thread M4 H 3mm WS 7 brass Qty 20 pcs		
	Part No.	521104	Ref. No. —
	washer ID $\varnothing$ 4.3mm ED $\varnothing$ 8mm thickness 0.5mm brass Qty 20 pcs for thread M4		
	Part No.	550262	Ref. No. —
	flat gasket copper ED $\varnothing$ 20mm ID $\varnothing$ 14mm thickness 2mm		
	Part No.	560111	Ref. No. —
	plain washer ID $\varnothing$ 4.3mm ED $\varnothing$ 9mm thickness 0.8mm SS Qty 20 pcs DIN 125A for thread M4		
	Part No.	560131	Ref. No. —
	hexagonal nut thread M4 H 3.2mm WS 7 SS DIN/ISO DIN 934 / ISO 4032/8673 Qty 20 pcs		

## heating elements for chargrills



<b>Part No.</b>	415250	<b>Ref. No.</b>	38000218
<b>description</b>	heating element gril 1650W 230V L 490mm W 42mm H 45mm connection M4 dry heating element heating circuits 1 tube $\varnothing$ 8.5mm 2 hole fixing thread 1/4" mounting distance 37mm		

## immersion heating elements

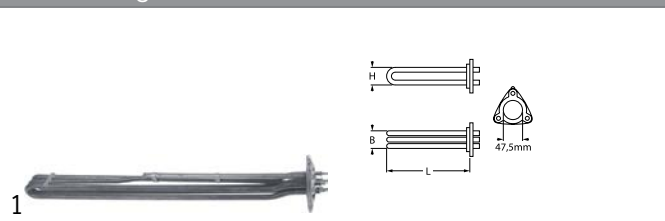
3 hole flange  $\varnothing$ 47.5mm

<b>Part No.</b>	419113	<b>Ref. No.</b>	38000267
<b>description</b>	heating element 9000W 230V mounting $\varnothing$ 47.5mm heating circuits 3 L 550mm W 38mm H 45mm number of thermostat sleeves 1 thermostat sleeves $\varnothing$ 7.3mm length thermostat sleeves 260mm tube $\varnothing$ 8.5mm connection M4 3 hole flange immersion heater L1 55mm H1 33mm H2 34mm		

<b>accessories for</b>	419113		
	Part No.	510408	Ref. No. —
	O-ring EPDM thickness 5.34mm ID $\varnothing$ 47mm Qty 1 pcs		

## heating elements for convection



<b>Part No.</b>	418087	<b>Ref. No.</b>	38000227
<b>description</b>	heating element 15000W 230/400V heating circuits 3 ID $\varnothing$ 398mm ED $\varnothing$ 415mm L 452mm H 121mm L1 32mm W1 105mm H1 80mm H2 25mm flange length 142mm flange width 25mm hole distance 126mm connection M4 tube $\varnothing$ 8.5mm convection heating element hole $\varnothing$ 6mm rectangular flange		

<b>accessories for</b>	418087		
	Part No.	550548	Ref. No. —
	gasket L 144mm W 25.5mm thickness 2.2mm for heating element suitable for GIORIK equiv. no. 2005173		

## hot plates

## square &amp; rectangular

## with radiused edge



<b>Part No.</b>	490068 <sup>1</sup>	<b>Ref. No.</b>	40000010
<b>description</b>	hot plate dimensions 220x220mm 2600W 400V with spill ring connection 4 screw clamps protector yes square		
<b>For models:</b>	G0110, G0112, G0114, G0115, G0117		

<sup>1</sup>incl. protector

1

<b>Part No.</b>	490176 <sup>1</sup>	<b>Ref. No.</b>	40000021
<b>description</b>	hot plate dimensions 220x220mm 2600W 440V with spill ring connection 4 screw clamps protector yes		

<sup>1</sup>incl. protector



1

<b>Part No.</b>	490057 <sup>1</sup>	<b>Ref. No.</b>	40000002 40000022
<b>description</b>	hot plate dimensions 300x300mm 3000W 400V with spill ring connection 4 screw clamps protector yes square		

<sup>1</sup>incl. protector

round

with radiused edge

for domestic and commercial kitchens



1

<b>Part No.</b>	490021	<b>Ref. No.</b>	40000015
<b>description</b>	hot plate ø 220mm 2600W 400V connection 4 screw clamps with 8mm spill ring		
<b>For models:</b>	G0100, G0102, G0104, G0105, G0107, G0700, G0702, G0703, G0704, G0705		



1

<b>Part No.</b>	490175	<b>Ref. No.</b>	40000020
<b>description</b>	hot plate ø 220mm 2600W 440V connection 4 screw clamps with 8mm spill ring		

replace set



1

<b>Part No.</b>	417661	<b>Ref. No.</b>	40000025
<b>description</b>	hot plate ø 90mm 2000W 230V connection 3 screw clamps with 8mm spill ring M6 equiv. no. 12.184.74.040 1 pair		

thermostats

control and safety thermostats

EGO

control thermostats

55.10/19\_ series



1

<b>Part No.</b>	375363	<b>Ref. No.</b>	40010010
<b>description</b>	thermostat t.max. 161°C temperature range 73-161°C 1-pole 1NO 16A probe ø 3mm probe L 144mm capillary pipe 1600mm capillary pipe isolated 1600mm gland nut shaft ø 6x4.6mm shaft L 23mm shaft position upper rotation 270°		
<b>For models:</b>	G1700, G1702, G1704, G1706		



1

<b>Part No.</b>	375270	<b>Ref. No.</b>	40000906
<b>description</b>	thermostat t.max. 295°C temperature range 45-295°C 1-pole 1NO 16A probe ø 4mm probe L 100mm capillary pipe 900mm capillary pipe isolated 350mm gland nut shaft L 23mm shaft position upper rotation 270°		
<b>For models:</b>	G1701, G1705		



## 55.13\_ series



<b>Part No.</b>	375007	<b>Ref. No.</b>	40000901
<b>description</b>	thermostat t.max. 110°C temperature range 30-110°C 1-pole 1NO 16A probe ø 6mm probe L 113mm capillary pipe 870mm capillary pipe isolated gland nut M9x1 shaft L 25mm shaft position upper rotation 270°		

accessories for 375007



<b>Part No.</b>	110119	<b>Ref. No.</b>	—
<b>description</b>	knob thermostat t.max. 110°C ø 50mm shaft ø 6x4.6mm shaft flat upper black temperature range 30-110°C rotation 270°		



<b>Part No.</b>	110241	<b>Ref. No.</b>	—
<b>description</b>	knob thermostat t.max. 110°C ø 50mm shaft ø 6x4.6mm shaft flat upper black temperature range 30-110°C		



<b>Part No.</b>	375492	<b>Ref. No.</b>	40000907 40000955 40001027
<b>description</b>	thermostat t.max. 190°C temperature range 94-190°C 1-pole 1NO 16A probe ø 6mm probe L 94mm capillary pipe 1090mm capillary pipe isolated 960mm gland nut M10x1 shaft ø 6x4.6mm shaft L 23mm shaft position upper rotation 310° probe material SS		
<b>For models:</b>	G1100, G1101, G1102, G1103, G1110, G1112, G1113		

## 55.34\_ series



<b>Part No.</b>	375602	<b>Ref. No.</b>	40000908
<b>description</b>	thermostat t.max. 120°C temperature range 45-120°C 3-pole 3CO 16A probe ø 6mm probe L 140mm capillary pipe 900mm capillary pipe isolated 870mm gland nut shaft ø 6x4.6mm shaft L 23mm shaft position upper rotation 270°		
<b>For models:</b>	G1210, G1211		

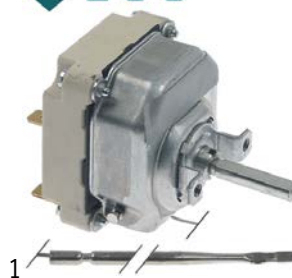

<b>Part No.</b>	375192	<b>Ref. No.</b>	40000905
<b>description</b>	thermostat t.max. 300°C temperature range 50-300°C 3-pole 3NO 16A probe ø 3mm probe L 219mm capillary pipe 900mm capillary pipe isolated gland nut shaft ø 6x4.6mm shaft L 23mm shaft position upper rotation 270°		
<b>For models:</b>	G0009, G0010, G0104, G0107, G0114, G0117, G0122, G0704, G0705, G0776, G0777, G1025, G1026, G1029, G1030, G1035, G1036, G1039, G1040, G1043, G1044		

## safety thermostats

## 55.10/19\_ series



<b>Part No.</b>	375651	<b>Ref. No.</b>	40000917
<b>description</b>	safety thermostat capillary pipe 670mm probe ø 6mm 1-pole probe L 77mm 16A capillary pipe isolated 650mm gland nut M10x1 switchoff temp. 350°C probe		

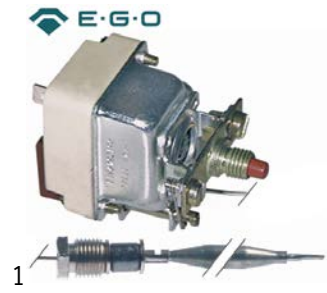

<b>Part No.</b>	375391	<b>Ref. No.</b>	40000924
<b>description</b>	safety thermostat switch-off temp. 224°C 1-pole 0.5A probe ø 6mm probe L 133mm capillary pipe 870mm capillary pipe isolated gland nut M10x1 probe		
<b>For models:</b>	G1100, G1101, G1102, G1103		

<b>Part No.</b>	375968	<b>Ref. No.</b>	40000914
<b>description</b>	safety thermostat switch-off temp. 360°C 1-pole 1NC 16A probe ø 6mm probe L 77mm capillary pipe 870mm capillary pipe isolated 660mm gland nut M10x1 probe material SS M8x1		



<b>Part No.</b>	375375	<b>Ref. No.</b>	40000919
<b>description</b>	safety thermostat switch-off temp. 230°C 3-pole 20A probe ø 6mm probe L 94mm capillary pipe 900mm capillary pipe isolated 670mm gland nut M10x1 probe SS		
<b>For models:</b>	G1111		

55.32\_series



<b>Part No.</b>	375364	<b>Ref. No.</b>	40000926
<b>description</b>	safety thermostat switch-off temp. 190°C 3-pole 20A probe ø 4mm probe L 120mm capillary pipe 3000mm capillary pipe isolated 3000mm gland nut probe		



<b>Part No.</b>	375228	<b>Ref. No.</b>	40000920
<b>description</b>	safety thermostat switch-off temp. 350°C 3-pole 20A probe ø 3mm probe L 188mm capillary pipe 900mm capillary pipe isolated 900mm gland nut probe SS		
<b>For models:</b>	G1025, G1026, G1029, G1030, G1035, G1036, G1039, G1040, G1043, G1044		



<b>Part No.</b>	375984	<b>Ref. No.</b>	40000922
<b>description</b>	safety thermostat switch-off temp. 225°C 3-pole 3NC 20A probe ø 6mm probe L 94mm capillary pipe 900mm capillary pipe isolated 670mm gland nut M10x1 probe SS		
<b>For models:</b>	G1110, G1112, G1113		



<b>Part No.</b>	375628	<b>Ref. No.</b>	40000923
<b>description</b>	safety thermostat switch-off temp. 350°C 3-pole 20A probe ø 4mm probe L 120mm capillary pipe 900mm capillary pipe isolated 670mm gland nut M10x1 probe SS		



1

<b>Part No.</b>	375350	<b>Ref. No.</b>	40000921
<b>description</b>	safety thermostat switch-off temp. 360°C 3-pole 20A probe ø 4mm probe L 120mm capillary pipe 1800mm capillary pipe isolated 1800mm gland nut probe SS		
<b>For models:</b>	G1701, G1705		

## 56.\_ series



1

<b>Part No.</b>	375783	<b>Ref. No.</b>	40000902
<b>description</b>	safety thermostat switch-off temp. 240°C 1-pole 0.5A probe ø 6mm probe L 77mm capillary pipe 860mm capillary pipe isolated 750mm gland nut M10x1 probe SS		

## accessories

## connecting bows



1

<b>Part No.</b>	550059	<b>Ref. No.</b>	40003020
<b>description</b>	connecting bow short for switch Qty 1 pcs		
<b>For models:</b>	G1210, G1211		

## switches and momentary switches

## rocker/momentary rocker switches

## 30x22mm



1

<b>Part No.</b>	301004	<b>Ref. No.</b>	40001032
<b>description</b>	rocker switch mounting measurements 30x22mm black 2CO 250V 16A connection male faston 6.3mm ambient temperature max. 125/55°C protection IP40		
<b>accessories for</b>	301004		
	<b>Part No.</b>	301036	<b>Ref. No.</b> —
	protective cover internal size 30x22mm for rocker switch mounting measurementsmm		

## push/momentary push switches

## ø16mm



1

<b>Part No.</b>	346346	<b>Ref. No.</b>	40000803
<b>description</b>	momentary push switch mounting ø 16mm red 1NO/indicator light 250V 3A connection male faston 2.8mm ambient temperature max. 125/55°C protection IP40		

## accessories

## protective covers



1

<b>Part No.</b>	346343	<b>Ref. No.</b>	40000801
<b>description</b>	protective cover		
<b>accessories for</b>	346343		
	<b>Part No.</b>	346344	<b>Ref. No.</b> 40000802
	ring for protecting cover		



1

<b>Part No.</b>	346344	<b>Ref. No.</b>	40000802
<b>description</b>	ring for protecting cover		
<b>accessories for</b>	346344		
	<b>Part No.</b>	346343	<b>Ref. No.</b> 40000801
	protective cover		

## microswitches

## pin-plunger actuated

## M10



1

<b>Part No.</b>	346347	<b>Ref. No.</b>	40001610
<b>description</b>	microswitch with plunger thread M10x0.75 thread L 14mm 250V 6A 2NO connection male faston 6.3mm stroke 4mm mounting distance 22mm ambient temperature max. 85°C actuating force: 100g		



cam switches

on/off



1

<b>Part No.</b>	300129	<b>Ref. No.</b>	40001025
<b>description</b>	cam switch 2 operating positions 2NO sequence 0-1 16A shaft $\varnothing$ 6x4.6mm shaft L 23mm connection male faston 6.3mm ceramic		
<b>For models:</b>	G1300, G1301		

7-position



1

<b>Part No.</b>	300106	<b>Ref. No.</b>	40001005
<b>description</b>	cam switch 7 operating positions 1NO/2CO sequence 0-1-2-3-4-5-6 32A shaft $\varnothing$ 6x4.6mm shaft L 23mm connection screw 7-position shaft flat upper		
<b>For models:</b>	G0100, G0102, G0104, G0105, G0107, G0110, G0112, G0114, G0115, G0117, G0700, G0702, G0703, G0704, G0705		

3 operating positions



1

<b>Part No.</b>	300167	<b>Ref. No.</b>	40001026
<b>description</b>	cam switch 3 operating positions 2NO/1CO sequence 0-1-2 16A shaft $\varnothing$ 6x4.6mm shaft L 23mm connection screw		

with potentiometer

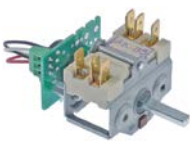

1

<b>Part No.</b>	300249	<b>Ref. No.</b>	40001045 40001701
<b>description</b>	cam switch 2 operating positions 2NO sequence 0-1 16A shaft $\varnothing$ 6x4.6mm shaft L 23mm connection screw 10K/J cable lengthmm 10kOhm ceramic		
<b>For models:</b>	G0120, G0121, G0122, G0125, G0126, G0127		

operation switches



1

<b>Part No.</b>	300002	<b>Ref. No.</b>	40001010
<b>description</b>	cam switch 2 operating positions 4NO 16A sequence 0-1 shaft $\varnothing$ 6x4.6mm shaft L 23mm connection male faston 6.3mm ceramic		
<b>For models:</b>	G0009, G0010, G0104, G0107, G0114, G0117, G0122, G0704, G0705, G0776, G0777, G1025, G1026, G1029, G1030, G1035, G1036, G1039, G1040, G1043, G1044		



1

<b>Part No.</b>	300166	<b>Ref. No.</b>	40001024
<b>description</b>	cam switch 2 operating positions 4NO 16A sequence 0-1 shaft $\varnothing$ 6x4.6mm shaft L 23mm connection male faston 6.3mm ceramic 4-pole ambient temperature max. 318°C		
<b>For models:</b>	G1111, G1210, G1211		



1

<b>Part No.</b>	300080	<b>Ref. No.</b>	40001018
<b>description</b>	cam switch 2 operating positions 4NO 16A sequence 0-1 shaft $\varnothing$ 6x4.6mm shaft L 23mm connection screw operation switch ceramic ambient temperature max. 150°C		
<b>accessories for</b>	300080		
	<b>Part No.</b>	551456	<b>Ref. No.</b> —
	gasket for switch ED $\varnothing$ 14mm ID $\varnothing$ 2.5mm thickness 3.5mm white		





**rotary switches**

**BREMAS**

**A3200 series**



1			
<b>Part No.</b>	345817	<b>Ref. No.</b>	40001021
<b>description</b>	rotary switch 2 0-1 sets of contacts 4 type CS0327690 600V 32A shaft ø 5x5mm shaft L 26mm shaft square connection screw		
<b>For models:</b>	G1110, G1112, G1113		

<b>accessories for</b>	357227		
	<b>Part No.</b>	359833	<b>Ref. No.</b> —
	indicator light lens red Qty 1 pcs ø 8mm		
	<b>Part No.</b>	359948	<b>Ref. No.</b> 40001510
	indicator light lens clear Qty 1 pcs ø 8mm		

1			
<b>Part No.</b>	357228	<b>Ref. No.</b>	40001506 40001515
<b>description</b>	indicator light 230V green connection cable 250mm		
<b>For models:</b>	G0009, G0010, G0104, G0107, G0114, G0117, G0122, G0704, G0705, G0776, G0777, G1025, G1026, G1029, G1030, G1035, G1036, G1039, G1040, G1043, G1044, G1100, G1101, G1102, G1103, G1104, G1110, G1111, G1112, G1113, G1210, G1211, G1300, G1301		

<b>accessories for</b>	357228		
	<b>Part No.</b>	359819	<b>Ref. No.</b> —
	indicator light lens green Qty 1 pcs ø 8mm		

**encoders and potentiometers**

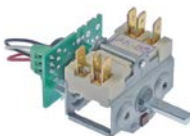

1			
<b>Part No.</b>	300249	<b>Ref. No.</b>	40001045 40001701
<b>description</b>	cam switch 2 operating positions 2NO sequence 0-1 16A shaft ø 6x4.6mm shaft L 23mm connection screw 10K/J cable lengthmm 10kOhm ceramic		
<b>For models:</b>	G0120, G0121, G0122, G0125, G0126, G0127		

**indicator lights (complete)**  
ø12mm  
with screw socket

1			
			
<b>Part No.</b>	359291	<b>Ref. No.</b>	40001521 40001527
<b>description</b>	indicator light ø 12mm 400V green connection male faston 6.3mm		
<b>For models:</b>	G1701, G1705		

**lamps**

**indicator lights**

**indicator light lenses**

ø 8mm (type RL-2)





1			
<b>Part No.</b>	359948	<b>Ref. No.</b>	40001510
<b>description</b>	indicator light lens clear Qty 1 pcs ø 8mm		
<b>For models:</b>	G0122, G0700, G0702, G0703, G0704, G0705, G1110, G1111, G1112, G1113, G1210, G1211, G1300, G1301		

1			
			
<b>Part No.</b>	359290	<b>Ref. No.</b>	40001520
<b>description</b>	indicator light ø 12mm 400V yellow connection male faston 6.3mm		
<b>For models:</b>	G1701, G1705		

**indicator lamps for socket type RL**



1			
<b>Part No.</b>	357227	<b>Ref. No.</b>	40001505 40001514
<b>description</b>	indicator light 230V clear connection cable 250mm		
<b>For models:</b>	G0009, G0010, G0100, G0102, G0104, G0105, G0107, G0110, G0112, G0114, G0115, G0117, G0122, G0700, G0702, G0703, G0704, G0705, G0776, G0777, G1025, G1026, G1029, G1030, G1035, G1036, G1039, G1040, G1043, G1044, G1100, G1101, G1102, G1103, G1104, G1110, G1111, G1112, G1113, G1210, G1211, G1300, G1301		
<b>accessories for</b>	357227		
	<b>Part No.</b>	359820	<b>Ref. No.</b> —
	indicator light lens yellow Qty 1 pcs ø 8mm		

1			
			
<b>Part No.</b>	357240	<b>Ref. No.</b>	40001519
<b>description</b>	indicator light ø 12mm red 400V connection F6.3 temp.-resist. 120°C Qty 1 pcs		



screw-on/push-on fit

halogen lamp

for socket G4 / G6.35 / G9



<b>Part No.</b>	359599	<b>Ref. No.</b>	40002000
<b>description</b>	halogen lamp socket G4 12V 20W temp.-resist. 500°C		

oven lamps

lamps

halogen lamps

for socket G4 / G6.35 / G9



<b>Part No.</b>	359599	<b>Ref. No.</b>	40002000
<b>description</b>	halogen lamp socket G4 12V 20W temp.-resist. 500°C		

relays

level relays

GICAR



<b>Part No.</b>	401173	<b>Ref. No.</b>	40004000
<b>description</b>	level relay 230V connection F6.3 type RL30/3ES/F		

electronic controllers

DIXELL

universal controllers



<b>Part No.</b>	378220	<b>Ref. No.</b>	40000933
<b>description</b>	electronic controller DIXELL type XT110C-5C0TU mounting measurements 71x29mm 230V voltage AC NTC/PTC/Pt100/TC(J,K) relay outputs 1 CO-BA(3) NTC/PTC/Pt100/TC(J,K) DI defr. funct. no dependent on probe°C display 3½ digits		
<b>accessories for</b>	378220		
	<b>Part No.</b>	<b>Ref. No.</b>	—
	temperature probe thermocouple J (Fe-CuNi) cable Vetrotex probe -50 up to +750°C cable -50 up to +350°C probe ø3x100mm cable length 3m without screw connection 2-wire		
	<b>Part No.</b>	<b>Ref. No.</b>	—
	temperature probe thermocouple K (NiCr-Ni) cable Vetrotex probe -50 up to 1150°C cable -50 up to +350°C probe ø4.5x150mm cable length 3m without screw connection 2-wire		
	<b>Part No.</b>	<b>Ref. No.</b>	—
	temperature probe thermocouple J (Fe-CuNi) cable Vetrotex probe -50 up to +750°C cable -50 up to +350°C probe ø6x50mm cable length 3m without screw connection 2-wire		
	<b>Part No.</b>	<b>Ref. No.</b>	—
	temperature probe Pt100 cable Vetrotex probe -200 up to +600°C cable -50 up to +350°C probe ø6x100mm cable length 1.4m without screw connection 3-wire resistance at 0°C 1000hm		
	<b>Part No.</b>	<b>Ref. No.</b>	—
	temperature probe Pt100 cable Vetrotex probe -200 up to +600°C cable -50 up to +350°C probe ø6x85mm cable length 3m without screw connection 3-wire resistance at 0°C 1000hm		
	<b>Part No.</b>	<b>Ref. No.</b>	—
	temperature probe thermocouple J (Fe-CuNi) cable Vetrotex probe 0 up to +350°C cable°C probe ø6x100mm cable length 1.35m without screw connection cable colours red/blue 2-wire		
	<b>Part No.</b>	<b>Ref. No.</b>	—
	temperature probe thermocouple K (NiCr-Ni) cable silicone probe -50 up to 1150°C cable -50 up to +180°C connection 2-wire thread probe ø1.5x35mm cable length 2.8m		

fuses

fine fuses



<b>Part No.</b>	358605	<b>Ref. No.</b>	40000500 40000503
<b>description</b>	fine fuse size ø5x20mm 3.15A slow-acting rated 250V Qty 10 pcs		
<b>For models:</b>	G1701, G1702, G1705, G1706		



## electric accessories

## terminals

## connection terminals with screw connection



1

<b>Part No.</b>	550355	<b>Ref. No.</b>	205,007
<b>description</b>	power terminal block 6-pole max. 40A max 400V connection M6/M6 temp.-resist. 150°C cross section 6mm <sup>2</sup> hole distance 122mm		
<b>For models:</b>	G0009, G0010, G0100, G0102, G0104, G0105, G0107, G0110, G0112, G0114, G0115, G0117, G0120, G0121, G0122, G0125, G0126, G0127, G0700, G0702, G0703, G0704, G0705, G0776, G0777, G1025, G1026, G1029, G1030, G1035, G1036, G1039, G1040, G1043, G1044, G1210, G1211		

## gas taps

## PEL

## 21S series



1

<b>Part No.</b>	107682	<b>Ref. No.</b>	40020032
<b>description</b>	gas tap PEL type 21S gas inlet M16x1.5 (tube ø 10mm) bypass nozzle ø 0.4mm gas outlet M16x1.5 (tube ø 10/8mm) thermocouple connection M9x1 pilot connection M10x1 shaft ø 8x6.5mm shaft L 22/15mm shaft flat upper		
<b>For models:</b>	G0000, G0002, G0004, G0005, G0007, G0008, G0009, G0010, G0030, G0031, G0032, G0033, G0034, G0035, G0664, G0665, G0666, G0667, G0669, G0776, G0777		



1

<b>Part No.</b>	107681	<b>Ref. No.</b>	40020031
<b>description</b>	gas tap PEL type 21S gas inlet M16x1.5 (tube ø 10mm) bypass nozzle ø 0.6mm gas outlet M16x1.5 (tube ø 10/8mm) thermocouple connection M9x1 pilot connection M10x1 shaft ø 8x6.5mm shaft L 22/15mm shaft flat upper		
<b>For models:</b>	G0002, G0004, G0005, G0007, G0008, G0009, G0010, G0016, G0017, G0030, G0031, G0034, G0035, G0665, G0666, G0667, G0669, G0776, G0777, G1000, G1001, G1010, G1011, G1018		







1

<b>Part No.</b>	107680	<b>Ref. No.</b>	40020030
<b>description</b>	gas tap PEL type 21S gas inlet M16x1.5 (tube ø 10mm) bypass nozzle ø 0.75mm gas outlet M16x1.5 (tube ø 10/8mm) thermocouple connection M9x1 pilot connection M10x1 shaft ø 8x6.5mm shaft L 22/15mm shaft flat upper		
<b>For models:</b>	G0000, G0002, G0004, G0005, G0007, G0008, G0009, G0010, G0030, G0031, G0032, G0033, G0034, G0035, G0664, G0665, G0666, G0667, G0669, G0776, G0777		



1

<b>Part No.</b>	107592	<b>Ref. No.</b>	40020029
<b>description</b>	gas tap PEL type 21S gas inlet M16x1.5 (tube ø 10mm) bypass nozzle ø 1mm gas outlet M16x1.5 (tube ø 10/8mm) thermocouple connection M9x1 pilot connection M10x1 shaft ø 8x6.5mm shaft L 22/15mm shaft flat upper		
<b>For models:</b>	G1200, G1201		
<b>spare parts for</b>	107592		
	<b>Part No.</b>	<b>Ref. No.</b>	—
	100529		
	bypass nozzle type PEL20/21 bore ø 1mm thread M5x0.5		
	<b>Part No.</b>	<b>Ref. No.</b>	—
	101231		
	thermocouple nut T1: M9x1 T2: M18x1		
<b>accessories for</b>	107592		
	<b>Part No.</b>	<b>Ref. No.</b>	—
	101277		
	olive ID ø 8mm Qty 1 pcs		
	<b>Part No.</b>	<b>Ref. No.</b>	—
	101278		
	olive for pipe ø 10mm Qty 1 pcs		
	<b>Part No.</b>	<b>Ref. No.</b>	—
	101300		
	union nut thread M16x1.5 tube ø 10mm		
	<b>Part No.</b>	<b>Ref. No.</b>	—
	101451		
	union nut thread M16x1.5 tube ø 8mm		



22S/O series



1

<b>Part No.</b>	103269	<b>Ref. No.</b>	40020003
<b>description</b>	gas tap PEL type 22S/O gas inlet M20x1.5 (tube ø 12mm) bypass nozzle ø 1mm gas outlet M20x1.5 (tube ø 12/10mm) thermocouple connection M9x1 pilot connection M10x1 shaft ø 10x8mm shaft L 25/17mm shaft flat lower		
<b>For models:</b>	G1500, G1501		

23S/O series



1

<b>Part No.</b>	101893	<b>Ref. No.</b>	40020006
<b>description</b>	gas tap PEL type 23S/O gas inlet M28x1.5 (tube ø 20mm) bypass nozzle ø 0.35mm gas outlet M24x1.5 (tube ø 16mm) thermocouple connection M9x1 pilot connection M10x1 shaft ø 10x8mm shaft L 25/17mm shaft flat lower		

<b>spare parts for</b>	101893
	Part No. 101045 Ref. No. — magnet unit T1: M9x1 T2: M22x1 L 46mm ø 18mm suitable for PEL23S M9x1
	Part No. 101204 Ref. No. — gas tap front part shaft ø 10x8mm shaft L 25/17mm shaft flat upper/lower suitable for PEL23S
	Part No. 101244 Ref. No. — gas connection thread M24x1.5 tube ø 12/16mm horizontal for PEL gas taps
	Part No. 101463 Ref. No. — screw suitable for PEL23S Qty 4 pcs
	Part No. 528455 Ref. No. — O-ring Viton thickness 2.62mm ID ø 18.72mm Qty 1 pcs

<b>accessories for</b>	101893
	Part No. 100908 Ref. No. 105076 union screw thread M10x1 for pipe ø 4mm Qty 1 pcs
	Part No. 100909 Ref. No. 40021603 union screw thread M10x1 for pipe ø 6mm Qty 1 pcs
	Part No. 101246 Ref. No. — olive for pipe ø 4mm Qty 1 pcs
	Part No. 101252 Ref. No. — union nut thread M24x1.5 for pipe ø 12mm
	Part No. 101253 Ref. No. — union nut thread M24x1.5 PEL for pipe ø 16mm

<b>accessories for</b>	101893
	Part No. 101254 Ref. No. — union nut thread M28x1.5 tube ø 20mm
	Part No. 101255 Ref. No. — olive for pipe ø 12mm Qty 1 pcs
	Part No. 101256 Ref. No. — olive for pipe ø 16mm Qty 1 pcs
	Part No. 101257 Ref. No. — olive for pipe ø 20mm Qty 1 pcs
	Part No. 101286 Ref. No. — olive ID ø 6mm Qty 1 pcs
	Part No. 110080 Ref. No. — knob ø 70mm shaft ø 10x8mm shaft flat universal
	Part No. 112206 Ref. No. — knob dial plate silver gas tap PEL21/22/23 t.max.°C ED ø 63mm ID ø 45.5mm

gas thermostats

SIT

630 Eurosit series



1

<b>Part No.</b>	101992	<b>Ref. No.</b>	40020133
<b>description</b>	gas thermostat type 630 Eurosit series t.max. 190°C 110-190°C gas inlet 3/8" gas outlet 3/8" thermocouple connection M9x1 pilot connection M10x1 probe ø 4mm probe L 202mm capillary pipe 1050mm SIT		

<b>accessories for</b>	101992
	Part No. 100904 Ref. No. — locking screw M10x1 for pipe ø 4mm Qty 1 pcs
	Part No. 100905 Ref. No. — locking screw M10x1 for pipe ø 6mm Qty 1 pcs
	Part No. 101273 Ref. No. — olive for pipe ø 12mm L 9.5mm brass Qty 1 pcs suitable for universal
	Part No. 101276 Ref. No. — union screw thread 3/8" tube ø 12mm Qty 1 pcs
	Part No. 101333 Ref. No. — plug thread 3/8" with O-ring
	Part No. 510655 Ref. No. — gasket silicone ø 7.8mm L 5mm blue Shore 55° Qty 10 pcs











1

<b>Part No.</b>	107221	<b>Ref. No.</b>	40020113
<b>description</b>	gas thermostat type 630 Eurosit series t.max. 250°C 40-250°C gas inlet 3/8" gas outlet 3/8" thermocouple connection M9x1 pilot connection M10x1 probe ø 4mm probe L 72mm capillary pipe 1050mm SIT		



1

<b>Part No.</b>	101125	<b>Ref. No.</b>	40020105 40020110
<b>description</b>	gas thermostat type 630 Eurosit series t.max. 340°C 100-340°C gas inlet 3/8" gas outlet 3/8" thermocouple connection M9x1 pilot connection M10x1 probe ø 4mm probe L 72mm capillary pipe 1050mm SIT		
<b>For models:</b>	G0008, G0031, G0033, G0035, G1700, G1702, G1704, G1706		

<b>accessories for</b>	101125		
	<b>Part No.</b>	100825	<b>Ref. No.</b> —
	gas tap spindle shaft ø 8x6.5mm shaft L 22/14mm suitable for EUROSIT		
	<b>Part No.</b>	100904	<b>Ref. No.</b> —
	locking screw M10x1 for pipe ø 4mm Qty 1 pcs		
	<b>Part No.</b>	100905	<b>Ref. No.</b> —
	locking screw M10x1 for pipe ø 6mm Qty 1 pcs		
	<b>Part No.</b>	100949	<b>Ref. No.</b> —
	gasket suitable for 630 Eurosit series		
	<b>Part No.</b>	101273	<b>Ref. No.</b> —
	olive for pipe ø 12mm L 9.5mm brass Qty 1 pcs suitable for universal		
	<b>Part No.</b>	101276	<b>Ref. No.</b> —
	union screw thread 3/8" tube ø 12mm Qty 1 pcs		
	<b>Part No.</b>	101333	<b>Ref. No.</b> —
	plug thread 3/8" with O-ring		
	<b>Part No.</b>	101390	<b>Ref. No.</b> —
	gas tap spindle shaft ø 6x4.6mm shaft L 32/15mm gas tap with ignition flame suitable for ZANUSSI, MARENO for gas thermostat EUROSIT		
	<b>Part No.</b>	101392	<b>Ref. No.</b> —
	adapter suitable for 630 Eurosit series		
	<b>Part No.</b>	110357	<b>Ref. No.</b> —
	gas tap spindle shaft ø 8x6.5mm shaft L 36/12mm suitable for 630 Eurosit series		

<b>accessories for</b>	101125		
	<b>Part No.</b>	110358	<b>Ref. No.</b> —
	adapter shaft ø 10x8mm shaft L 29/18mm suitable for 630 Eurosit series		

PEL

25ST series



1

<b>Part No.</b>	107593	<b>Ref. No.</b>	40020010
<b>description</b>	gas thermostat PEL type 25ST 100-300°C gas inlet M16x1.5 (tube ø 10mm) bypass nozzle ø 0.9mm gas outlet M16x1.5 (tube ø 10mm) thermocouple connection M9x1 pilot connection M10x1 capillary pipe 1200mm probe ø 6mm probe L 100mm shaft ø 8x6.5mm shaft L 21/15mm shaft flat upper ignition gas M10x1		
<b>For models:</b>	G0004, G0007, G0017, G0666, G0667, G1004, G1005, G1014, G1015, G1019		

gas valves and ignition boxes

gas control valves

SIT

NOVASIT

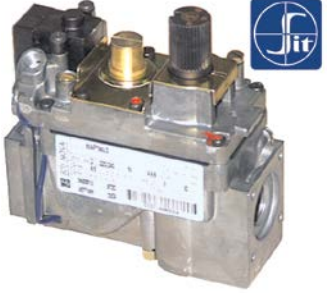

1





<b>Part No.</b>	101162	<b>Ref. No.</b>	40020115
<b>description</b>	gas valve SIT series Novasit 820 230V 50Hz gas inlet 1/2" gas outlet 1/2" thermocouple connection M9x1 pilot connection M10x1 ignition pressure 3-5mbar pressure range 3-30mbar pressure regulator connection blind equiv. no. 0.820.010		
<b>For models:</b>	G1100, G1101, G1102, G1103, G1104		
<b>spare parts for</b>	101162		
	<b>Part No.</b>	101065	<b>Ref. No.</b> —
	magnet unit with cable L 44mm D1 ø 30mm D2 ø 20mm suitable for NOVASIT		
	<b>Part No.</b>	101313	<b>Ref. No.</b> —
	solenoid coil 230V 50Hz		
<b>accessories for</b>	101162		
	<b>Part No.</b>	100006	<b>Ref. No.</b> —
	piezoelectric igniter suitable for ELETTRISIT body plastic blowing connection ø2.4mm ø 14mm		
	<b>Part No.</b>	101305	<b>Ref. No.</b> —
	gas connection straight 1/2" flange 45x45mm ELETTRISIT/V4400/4600/4605 suitable for SIT/HONEYWELL hole distance 36x36mm		

Table continues overleaf



accessories for 101162			
Part No.	101306	Ref. No.	—
	gas connection angled flange 45x45mm hole distance 36x36mm 1/2"	ELETTROSIT/V4400/4600/4605 screw with O-ring suitable for SIT/ HONEYWELL	
	Part No. 101307	Ref. No.	—
	gas connection straight flange 45x45mm hole distance 36x36mm 3/4"	ELETTROSIT/V4400/4600/4605 screw with O-ring suitable for SIT/ HONEYWELL	
	Part No. 101308	Ref. No.	—
	gas connection angled flange 45x45mm hole distance 36x36mm 3/4"	ELETTROSIT/V4400/4600/4605 screw with O-ring suitable for SIT/ HONEYWELL	
	Part No. 101312	Ref. No.	—
	microswitch		
	Part No. 101314	Ref. No.	—
	solenoid coil 24V 50Hz		
	Part No. 101317	Ref. No.	—
	plug with cable L 1000mm suitable for NOVASIT		
	Part No. 101318	Ref. No.	—
	cover cap for solenoid coil suitable for NOVASIT		

accessories			
	1		
<b>Part No.</b>	100110	<b>Ref. No.</b>	40021132
<b>description</b>	pilot burner SIT type 190 series 3 flames nozzle 6mm gas connectionmm		
<b>accessories for</b>	100110		
	Part No. 100202	Ref. No.	—
	pilot burner nozzle natural gas code 41 Qty 1 pcs nozzle ø 0.41mm		
	Part No. 100203	Ref. No.	—
	pilot burner nozzle LPG code 25 Qty 1 pcs nozzle ø 0.25mm		
	Part No. 100701	Ref. No.	40020907
	ignition electrode connection M4 Qty 1 pcs		
	Part No. 100906	Ref. No.	—
	screw connection thread M10x1 for ignition electrode brass Qty 1 pcs WS 10		
	Part No. 100907	Ref. No.	—
	screw connection thread M10x1 Qty 1 pcs type SEF 1 ømm for thermocouple		
	Part No. 100908	Ref. No.	105076
	union screw thread M10x1 for pipe ø 4mm Qty 1 pcs		
	Part No. 100909	Ref. No.	40021603
	union screw thread M10x1 for pipe ø 6mm Qty 1 pcs		
	Part No. 101282	Ref. No.	—
	olive for pipe ø 4mm L 7.4mm Qty 1 pcs		
	Part No. 101287	Ref. No.	—
	olive for pipe ø 6mm Qty 1 pcs		

accessories for 100110			
Part No.	102110	Ref. No.	—
	pilot tube copper pipe ø 4mm thickness 1mm L 3000mm		
	Part No. 102111	Ref. No.	—
	pilot tube copper pipe ø 6mm thickness 1mm L 3000mm		
	Part No. 107650	Ref. No.	38023085
	pilot burner nozzle SIT LPG code 30 Qty 1 pcs		

## ignition parts

### pilot burners

#### SIT









#### 100 series



<b>Part No.</b>	106906	<b>Ref. No.</b>	309,004 40022510
<b>description</b>	pilot burner SIT type 100 series 3 flames nozzle ø 0.2mm gas connection 6mm		
<b>For models:</b>	G0004, G0007, G0008, G0016, G0017, G0030, G0031, G0033, G0035, G0666, G0667, G1000, G1001, G1004, G1005, G1010, G1011, G1014, G1015, G1018, G1019, G1100, G1101, G1102, G1103, G1104, G1700, G1702, G1704, G1706		
<b>spare parts for</b>	106906		
	Part No. 100245	Ref. No.	38023032
	pilot burner nozzle LPG code 20 bore ø 0.2mm Qty 1 pcs thread M8x0.75		
	Part No. 100855	Ref. No.	—
	pilot burner bracket triple		
	Part No. 100885	Ref. No.	—
	air mixing sleeve for pilot burner Qty 1 pcs		
	Part No. 100916	Ref. No.	—
	compression spring for pilot burner Qty 1 pcs		
	Part No. 100917	Ref. No.	—
	gasket for pilot burner Qty 1 pcs aluminium		
	Part No. 100918	Ref. No.	—
	screw for pilot burner		
	Part No. 107162	Ref. No.	—
	pilot burner cap SIT 3 flames Hmm Lmm Qty 1 pcs		
	Part No. 107701	Ref. No.	—
	pilot burner bottom part SIT 100 series nozzle ø 0.2mm		
<b>accessories for</b>	106906		
	Part No. 100245	Ref. No.	38023032
	pilot burner nozzle LPG code 20 bore ø 0.2mm Qty 1 pcs thread M8x0.75		

Table continues overleaf



accessories for		106906	
	Part No.	100246	Ref. No. —
	pilot burner nozzle natural gas bore $\varnothing$ 0.35mm Qty 1 pcs thread M8x0.75		
	Part No.	100904	Ref. No. —
	locking screw M10x1 for pipe $\varnothing$ 4mm Qty 1 pcs		
	Part No.	100905	Ref. No. —
	locking screw M10x1 for pipe $\varnothing$ 6mm Qty 1 pcs		
	Part No.	102110	Ref. No. —
	pilot tube copper pipe $\varnothing$ 4mm thickness 1mm L 3000mm		
	Part No.	102111	Ref. No. —
	pilot tube copper pipe $\varnothing$ 6mm thickness 1mm L 3000mm		
	Part No.	107171	Ref. No. —
	pilot burner nozzle SIT natural/liquid gas bore $\varnothing$ 0.25mm Qty 1 pcs		
	Part No.	107700	Ref. No. —
	pilot burner bottom part SIT 100 series nozzle $\varnothing$ 0.25mm		
	Part No.	107702	Ref. No. —
	pilot burner bottom part SIT 100 series nozzle $\varnothing$ 0.35mm		

accessories

pilot burner caps

	1		
Part No.	107166	Ref. No.	40021120
description	pilot burner head SIT 1 flame Hmm Lmm Qty 1 pcs		
For models:	G0000, G0002, G0004, G0005, G0007, G0008, G0009, G0010, G0030, G0031, G0032, G0033, G0034, G0035, G0664, G0665, G0666, G0667, G0669, G0776, G0777		

pilot burner nozzles

	1		
Part No.	100245	Ref. No.	38023032
description	pilot burner nozzle LPG code 20 bore $\varnothing$ 0.2mm Qty 1 pcs thread M8x0.75		
For models:	G0004, G0005, G0007, G0008, G0009, G0010, G0035		

	1		
Part No.	102972	Ref. No.	38023040 38023082
description	pilot burner nozzle natural gas code 40 bore $\varnothing$ 0.4mm Qty 1 pcs		
For models:	G0004, G0005, G0007, G0008, G0009, G0010, G0035		

ignition electrodes

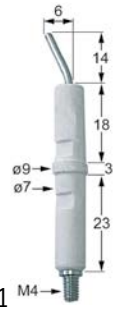
	1		
Part No.	100706	Ref. No.	40020902
description	ignition electrode connection M4 Qty 1 pcs		

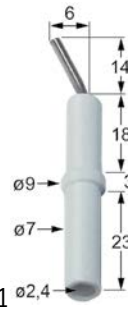



	1		
Part No.	100707	Ref. No.	009,008
description	ignition electrode D1 $\varnothing$ 7mm D2 $\varnothing$ 9mm connection $\varnothing$ 2.4mm L1 14mm L2 6mm BL1 18mm BL2 3mm BL3 23mm to clip Qty 1 pcs		

140 - 145 -150 series

	1		
Part No.	107114 <sup>1</sup>	Ref. No.	40021131
description	pilot burner SIT type 140 series 2 flames nozzle $\varnothing$ mm gas connectionmm		
For models:	G1500, G1501		
spare parts for	107114		
	Part No.	100907	Ref. No. —
	screw connection thread M10x1 Qty 1 pcs type SEF 1 $\varnothing$ mm for thermocouple		
accessories for	107114		
	Part No.	100204	Ref. No. —
	pilot burner nozzle SIT LPG code 14 bore $\varnothing$ 0.18/0.20mm Qty 1 pcs suitable for 140 series		
	Part No.	100205	Ref. No. —
	pilot burner nozzle SIT LPG code 19 bore $\varnothing$ 0.23/0.26mm Qty 1 pcs suitable for SIT 150 series		
	Part No.	100206	Ref. No. —
	pilot burner nozzle SIT natural gas code 36 bore $\varnothing$ 0.60/0.55mm Qty 1 pcs suitable for SIT 150 series		
	Part No.	100207	Ref. No. —
	pilot burner nozzle SIT natural gas code 27 bore $\varnothing$ 0.40/0.38mm suitable for SIT 140 series		
	Part No.	100216	Ref. No. —
	pilot burner nozzle SIT natural gas code 38 bore $\varnothing$ 0.45mm Qty 1 pcs suitable for SIT 150 series		

<sup>1</sup>incl. thermocouple fitting  
Table continues overleaf



accessories for		107114		
	Part No.	100701	Ref. No.	40020907
	ignition electrode connection M4 Qty 1 pcs			
	Part No.	100801	Ref. No.	—
	gasket for pilot burner Qty 1 pcs			
	Part No.	100897	Ref. No.	—
	olive for pipe ø 4mm Qty 1 pcs for pilot burner			
	Part No.	100898	Ref. No.	—
	olive for pipe ø 6mm Qty 1 pcs for pilot burner			
	Part No.	100906	Ref. No.	—
	screw connection thread M10x1 for ignition electrode brass Qty 1 pcs WS 10			
	Part No.	100908	Ref. No.	105076
	union screw thread M10x1 for pipe ø 4mm Qty 1 pcs			
	Part No.	100909	Ref. No.	40021603
	union screw thread M10x1 for pipe ø 6mm Qty 1 pcs			
	Part No.	102110	Ref. No.	—
	pilot tube copper pipe ø 4mm thickness 1mm L 3000mm			
	Part No.	102111	Ref. No.	—
	pilot tube copper pipe ø 6mm thickness 1mm L 3000mm			

accessories for		100110		
	Part No.	100906	Ref. No.	—
	screw connection thread M10x1 for ignition electrode brass Qty 1 pcs WS 10			
	Part No.	100907	Ref. No.	—
	screw connection thread M10x1 Qty 1 pcs type SEF 1 ømm for thermocouple			
	Part No.	100908	Ref. No.	105076
	union screw thread M10x1 for pipe ø 4mm Qty 1 pcs			
	Part No.	100909	Ref. No.	40021603
	union screw thread M10x1 for pipe ø 6mm Qty 1 pcs			
	Part No.	101282	Ref. No.	—
	olive for pipe ø 4mm L 7.4mm Qty 1 pcs			
	Part No.	101287	Ref. No.	—
	olive for pipe ø 6mm Qty 1 pcs			
	Part No.	102110	Ref. No.	—
	pilot tube copper pipe ø 4mm thickness 1mm L 3000mm			
	Part No.	102111	Ref. No.	—
	pilot tube copper pipe ø 6mm thickness 1mm L 3000mm			
	Part No.	107650	Ref. No.	38023085
	pilot burner nozzle SIT LPG code 30 Qty 1 pcs			

160 series





				
1				
Part No.	106243	Ref. No.	40021140	
description	pilot burner SIT type 160 series 2 flames nozzle ø 0.41mm gas connection 6mm nozzle no.41			

190 series

				
1				
Part No.	100110	Ref. No.	40021132	
description	pilot burner SIT type 190 series 3 flames nozzle ømm gas connectionmm			
accessories for		100110		
	Part No.	100202	Ref. No.	—
	pilot burner nozzle natural gas code 41 Qty 1 pcs nozzle ø 0.41mm			
	Part No.	100203	Ref. No.	—
	pilot burner nozzle LPG code 25 Qty 1 pcs nozzle ø 0.25mm			
	Part No.	100701	Ref. No.	40020907
	ignition electrode connection M4 Qty 1 pcs			

POLIDORO

pilot burners

				
1				
Part No.	103264	Ref. No.	40021130	
description	pilot burner POLIDORO 3 flames natural/liquid gas code 22/27-2 gas connection 6mm			
For models:	G0032, G0033, G0034, G0035, G1200, G1201			
spare parts for		103264		
	Part No.	100000	Ref. No.	—
	pilot burner nozzle POLIDORO LPG code 22 bore ø 0.22mm Qty 1 pcs			
	Part No.	106703	Ref. No.	—
	pilot burner nozzle POLIDORO natural gas code 27.2 bore ø 2x0.27mm Qty 1 pcs			
accessories for		103264		
	Part No.	100701	Ref. No.	40020907
	ignition electrode connection M4 Qty 1 pcs			





electrodes

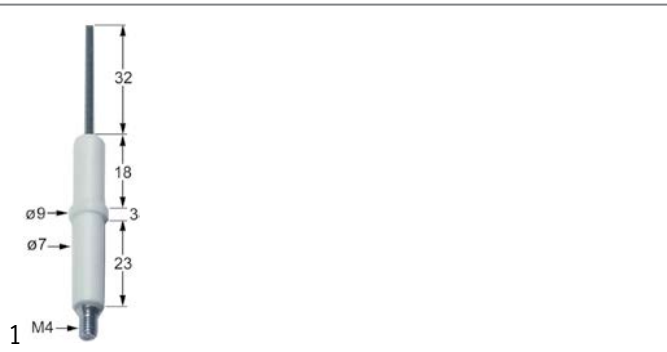

<b>Part No.</b>	100701	<b>Ref. No.</b>	40020907
<b>description</b>	ignition electrode connection M4 Qty 1 pcs		
<b>For models:</b>	G1500, G1501		
<b>accessories for</b>	100701		
	<b>Part No.</b>	100906	<b>Ref. No.</b> —
	screw connection thread M10x1 for ignition electrode brass Qty 1 pcs WS 10		

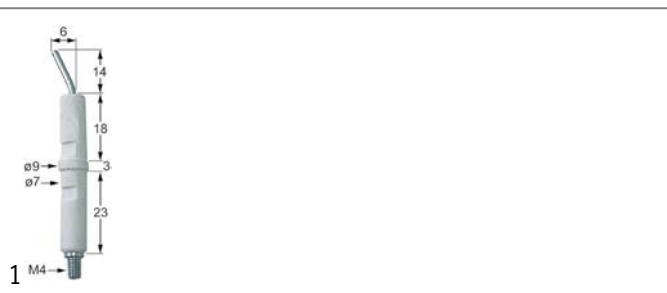

<b>Part No.</b>	100706	<b>Ref. No.</b>	40020902
<b>description</b>	ignition electrode connection M4 Qty 1 pcs		

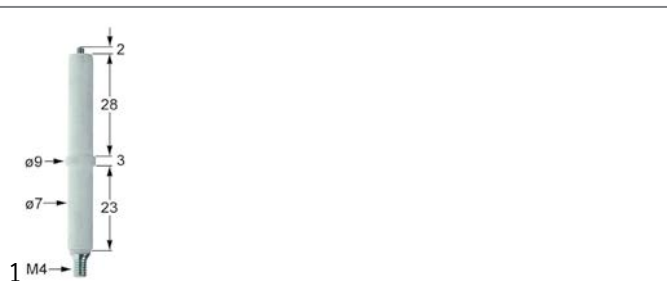

<b>Part No.</b>	102314	<b>Ref. No.</b>	40020906
<b>description</b>	ignition electrode D1 ø 7mm D2 ø 9mm connection M4 L1 28mm BL1 18mm BL2 3mm BL3 23mm to clip		
<b>For models:</b>	G0032, G0033, G0034, G0035, G1200, G1201		

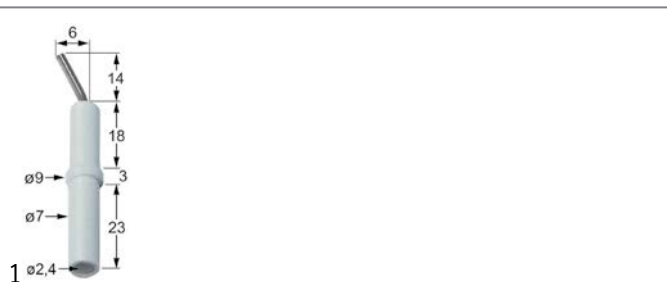

<b>Part No.</b>	100707	<b>Ref. No.</b>	009,008
<b>description</b>	ignition electrode D1 ø 7mm D2 ø 9mm connection ø2.4mm L1 14mm L2 6mm BL1 18mm BL2 3mm BL3 23mm to clip Qty 1 pcs		



<b>Part No.</b>	102330	<b>Ref. No.</b>	40020900
<b>description</b>	ignition electrode D1 ø 7mm D2 ø 9mm L1 16mm BL1 18mm BL2 3mm BL3 23mm to clip connection ø 2.4mm		
<b>For models:</b>	G1700, G1702, G1704, G1706		

piezoelectric igniters

mounting diameter 22mm



<b>Part No.</b>	100013	<b>Ref. No.</b>	40010011
<b>description</b>	piezoelectric igniter body plastic blowing mounting ø 22mm connection ø2.4mm cable lengthmm		
<b>accessories for</b>	100013		
	<b>Part No.</b>	100023	<b>Ref. No.</b> —
	female bullet size 2.3mm 0.5-1.5mm <sup>2</sup> CuZn t.max. 125°C Qty 20 pcs		



<b>Part No.</b>	100005	<b>Ref. No.</b>	40010000
<b>description</b>	piezoelectric igniter body plastic blowing mounting ø 22mm connection ø2.4mm cable lengthmm SIT		
<b>For models:</b>	G0004, G0007, G0008, G0016, G0017, G0030, G0031, G0032, G0033, G0034, G0035, G0666, G0667, G1000, G1001, G1004, G1005, G1010, G1011, G1014, G1015, G1018, G1019		

ignition units



<b>Part No.</b>	101002	<b>Ref. No.</b>	40002100
<b>description</b>	ignition unit outputs 2 230VAC dimensions 88x23x34mm mounting distance 73mm inlet F6.3x0.8 outlet F2.8x0.8 0.6VA 50/60Hz		
<b>For models:</b>	G1100, G1101, G1102, G1103, G1104		



ignition switches

			
1			
<b>Part No.</b>	107783	<b>Ref. No.</b>	40002105
<b>description</b>	ignition switch for battery type AA 1.5V mounting $\varnothing$ 22mm built-in depth 68mm connection F 2.8 mounting distance mm dimensions 98x58x35mm outputs 1		
<b>For models:</b>	G1014, G1015, G1019, G1200, G1201, G1500		

thermocouples

plug-in thermocouples

plug-in thermocouples standard

with barrel socket  $\varnothing$ 6(6.5)mm

thermocouples SIT

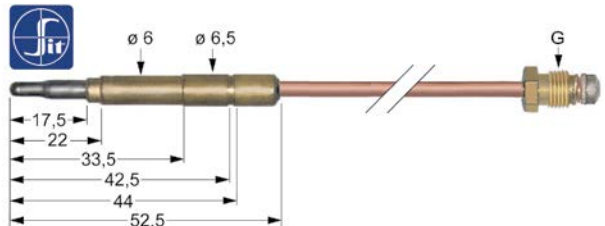
			
1			
<b>Part No.</b>	107613	<b>Ref. No.</b>	40021010
<b>description</b>	thermocouple SIT M9x1 L 1200mm plug connection $\varnothing$ 6.0(6.5)mm		
<b>For models:</b>	G0004, G0007, G0008, G0017, G0031, G0033, G0035, G0666, G0667		

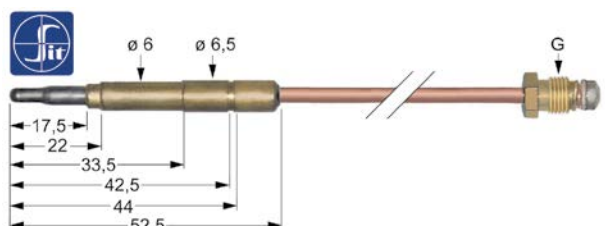
			
1			
<b>Part No.</b>	107607	<b>Ref. No.</b>	40021005
<b>description</b>	thermocouple SIT M9x1 L 400mm plug connection $\varnothing$ 6.0(6.5)mm		
<b>For models:</b>	G0000, G0002, G0004, G0005, G0007, G0008, G0009, G0010, G0030, G0031, G0032, G0033, G0034, G0035, G0664, G0665, G0666, G0667, G0669, G0776, G0777, G1000, G1001, G1004, G1005, G1010, G1011, G1014, G1015, G1018, G1019		

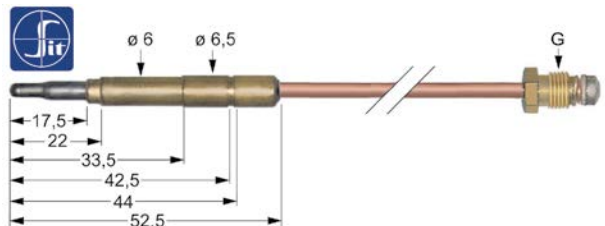
			
1			
<b>Part No.</b>	107609	<b>Ref. No.</b>	40021032
<b>description</b>	thermocouple SIT M9x1 L 600mm plug connection $\varnothing$ 6.0(6.5)mm		
<b>For models:</b>	G1500, G1501		

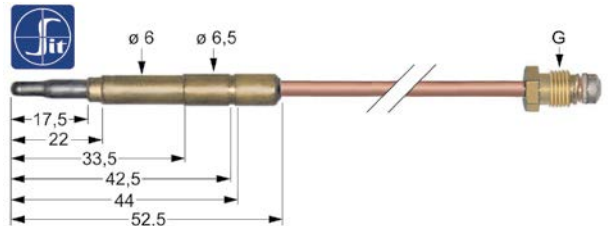
			
1			
<b>Part No.</b>	107610	<b>Ref. No.</b>	40021007
<b>description</b>	thermocouple SIT M9x1 L 750mm plug connection $\varnothing$ 6.0(6.5)mm		
<b>For models:</b>	G0000, G0002, G0004, G0005, G0008, G0009, G0016, G0017, G0030, G0031, G0032, G0033, G0034, G0035, G0664, G0665, G0666, G0667, G0669, G0776, G0777		

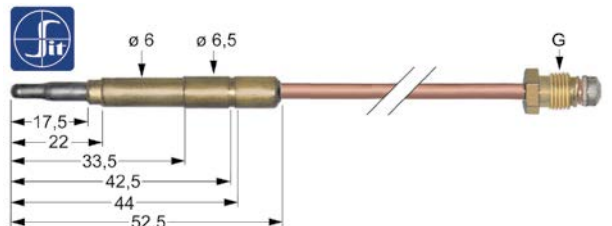
			
1			
<b>Part No.</b>	107611	<b>Ref. No.</b>	40021008 40021012
<b>description</b>	thermocouple SIT M9x1 L 850mm plug connection $\varnothing$ 6.0(6.5)mm		
<b>For models:</b>	G0007, G0010, G0030, G0031, G0034, G0035, G1700, G1702, G1704, G1706		

plug-in thermocouples with interruption

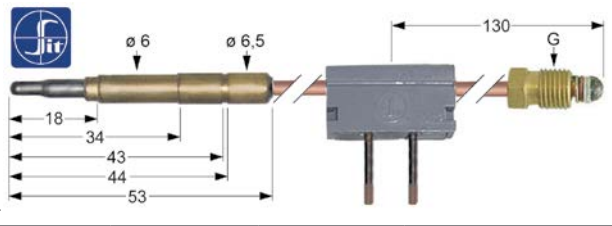
			
1			
<b>Part No.</b>	107164	<b>Ref. No.</b>	40021042
<b>description</b>	thermocouple SIT with interrupter M9x1 L 1000mm plug connection $\varnothing$ 6.0(6.5)mm soldering connection		

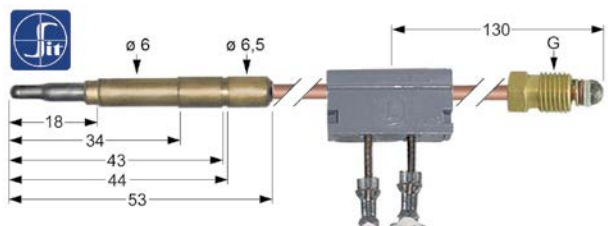
			
1			
<b>Part No.</b>	107177	<b>Ref. No.</b>	40021028
<b>description</b>	thermocouple SIT with interrupter M9x1 L 600mm plug connection $\varnothing$ 6.0mm F 6.3mm		
<b>For models:</b>	G1100, G1101, G1102, G1103, G1104		





accessories

screws



<b>Part No.</b>	102464	<b>Ref. No.</b>	38024012
<b>description</b>	thermocouple fitting thread M10x1 brass Qty 1 pcs		
<b>For models:</b>	G0032, G0033, G0034, G0035, G1200, G1201		

			
<b>Part No.</b>	103216	<b>Ref. No.</b>	38020211
<b>description</b>	burner head 4.5kW for burner cap ø 104mm ED ø 136mm seat ø 98mm enamelled		
<b>For models:</b>	G0002, G0004, G0005, G0007, G0008, G0009, G0010, G0034, G0035, G0665, G0666, G0667, G0669, G0776, G0777		
<b>accessories for</b>	103216		
		<b>Part No.</b>	103215 <b>Ref. No.</b> 38020221
	burner cap 4.5kW ED ø 104mm seat ø 98mm enamelled		

gas burners

hob burners



universal hob burners

ARC

65 series



<b>Part No.</b>	103213	<b>Ref. No.</b>	38020220
<b>description</b>	burner cap 3kW ED ø 73mm seat ø 67mm enamelled		
<b>For models:</b>	G0000, G0002, G0004, G0005, G0007, G0008, G0009, G0010, G0030, G0031, G0032, G0033, G0034, G0035, G0664, G0665, G0666, G0667, G0669, G0776, G0777		

			
<b>Part No.</b>	103218	<b>Ref. No.</b>	38020212
<b>description</b>	burner head 7.5kW for burner cap ø 128mm ED ø 151mm seat ø 120mm enamelled		
<b>For models:</b>	G0000, G0002, G0004, G0005, G0007, G0008, G0009, G0010, G0030, G0031, G0032, G0033, G0034, G0035, G0664, G0665, G0666, G0667, G0669, G0776, G0777		
<b>accessories for</b>	103218		
		<b>Part No.</b>	103217 <b>Ref. No.</b> 38020222
	burner cap 7.5kW ED ø 128mm ID ø 70mm seat ø 119.6mm enamelled		



<b>Part No.</b>	103215	<b>Ref. No.</b>	38020221
<b>description</b>	burner cap 4.5kW ED ø 104mm seat ø 98mm enamelled		
<b>For models:</b>	G0002, G0004, G0005, G0007, G0008, G0009, G0010, G0034, G0035, G0665, G0666, G0667, G0669, G0776, G0777		

bar burners

bar burners



<b>Part No.</b>	105475	<b>Ref. No.</b>	38020140
<b>description</b>	bar burner 2 row L 575mm W 225mm ømm H 45mm 11kW chargrill		



<b>Part No.</b>	103217	<b>Ref. No.</b>	38020222
<b>description</b>	burner cap 7.5kW ED ø 128mm ID ø 70mm seat ø 119.6mm enamelled		
<b>For models:</b>	G0000, G0002, G0004, G0005, G0007, G0008, G0009, G0010, G0030, G0031, G0032, G0033, G0034, G0035, G0664, G0665, G0666, G0667, G0669, G0776, G0777		





<b>Part No.</b>	107789	<b>Ref. No.</b>	38020111
<b>description</b>	bar burner L 475mm W 155mm ø 25mm H 50mm flange width 65mm flange length 50mm 5.5kW griddle		
<b>For models:</b>	G1000, G1001, G1004, G1005, G1010, G1011, G1014, G1015, G1018, G1019		



<b>Part No.</b>	103214	<b>Ref. No.</b>	38020210
<b>description</b>	burner head 3kW for burner cap ø 73mm seat ø 67mm enamelled		
<b>For models:</b>	G0000, G0002, G0004, G0005, G0007, G0008, G0009, G0010, G0030, G0031, G0032, G0033, G0034, G0035, G0664, G0665, G0666, G0667, G0669, G0776, G0777		
<b>accessories for</b>	103214		
		<b>Part No.</b>	103213 <b>Ref. No.</b> 38020220
	burner cap 3kW ED ø 73mm seat ø 67mm enamelled		



			
1			
<b>Part No.</b>	105481	<b>Ref. No.</b>	38020123
<b>description</b>	bar burner ø 40mm Wmm Hmm L 325mm flange ø 61mm tilting bratt pan		
<b>For models:</b>	G1700, G1702, G1704, G1706		

			
1			
<b>Part No.</b>	105482	<b>Ref. No.</b>	38020124
<b>description</b>	bar burner ø 40mm Wmm Hmm L 396mm flange ø 61mm tilting bratt pan		

			
1			
<b>Part No.</b>	105690	<b>Ref. No.</b>	20121700
<b>description</b>	bar burner ø 60mm Wmm Hmm L 258mm flange width 67mm flange length 67mm pasta cooker		
<b>For models:</b>	G1200, G1201		
<b>accessories for</b>	105690		
	<b>Part No.</b>	100508	<b>Ref. No.</b> —
	gas injector thread M9x1 WS 10 bore ø 1.45mm		
	<b>Part No.</b>	100513	<b>Ref. No.</b> —
	gas injector thread M9x1 WS 10 bore ø 2.15mm		

tube burners

			
1			
<b>Part No.</b>	105532	<b>Ref. No.</b>	38020129
<b>description</b>	tubular burner L 295mm W 55mm H 70mm mounting pos. centre for fryer oval		
<b>For models:</b>	G1101, G1104		

			
1			
<b>Part No.</b>	105530	<b>Ref. No.</b>	38020128
<b>description</b>	tubular burner L 295mm W 55mm H 70mm mounting pos. left for fryer oval		
<b>For models:</b>	G1100, G1101, G1103, G1104		

			
1			
<b>Part No.</b>	105531	<b>Ref. No.</b>	38020130
<b>description</b>	tubular burner L 295mm W 55mm H 70mm mounting pos. right for fryer oval		
<b>For models:</b>	G1100, G1101, G1103, G1104		

gas nozzles

main nozzles

<b>gas nozzles M9x1</b>			
			
1			
<b>Part No.</b>	100505	<b>Ref. No.</b>	40021420
<b>description</b>	gas injector thread M9x1 WS 10 bore ø 1.2mm		
<b>For models:</b>	G1100, G1101, G1102, G1103, G1104		

			
1			
<b>Part No.</b>	107596	<b>Ref. No.</b>	40021423
<b>description</b>	gas injector thread M9x1 WS 10 bore ø 1.45mm		

			
1			
<b>Part No.</b>	107595	<b>Ref. No.</b>	40021430
<b>description</b>	gas injector thread M9x1 WS 10 bore ø 1.5mm		





			
1			
<b>Part No.</b>	107597	<b>Ref. No.</b>	38023052
<b>description</b>	gas injector thread M9x1 WS 10 bore ø 1.6mm		

gas nozzles M10x1

			
1			
<b>Part No.</b>	100466	<b>Ref. No.</b>	38023000
<b>description</b>	gas injector thread M10x1 WS 12 bore ø 0.95mm		
<b>For models:</b>	G0000, G0002, G0004, G0005, G0007, G0008, G0009, G0010, G0016, G0017, G0030, G0031, G0032, G0033, G0034, G0035, G0664, G0665, G0666, G0667, G0669, G0776, G0777, G1014, G1015, G1019		

			
1			
<b>Part No.</b>	100469	<b>Ref. No.</b>	38023006
<b>description</b>	gas injector thread M10x1 WS 12 bore ø 1.15mm		
<b>For models:</b>	G0000, G0002, G0004, G0005, G0007, G0008, G0010, G0016, G0017, G0030, G0031, G0032, G0033, G0034, G0035, G0664, G0665, G0666, G0667, G0669, G0776, G0777, G1014, G1015, G1019		

			
1			
<b>Part No.</b>	103211	<b>Ref. No.</b>	38023001
<b>description</b>	gas injector thread M10x1 WS 12 bore ø 1.25mm		

			
1			
<b>Part No.</b>	103212	<b>Ref. No.</b>	38023007
<b>description</b>	gas injector thread M10x1 WS 12 bore ø 1.32mm		
<b>For models:</b>	G0000, G0002, G0004, G0005, G0007, G0008, G0009, G0010, G0016, G0017, G0030, G0031, G0032, G0033, G0034, G0035, G0664, G0665, G0666, G0667, G0669, G0776, G0777, G1014, G1015, G1019		

			
1			
<b>Part No.</b>	100446	<b>Ref. No.</b>	38023010
<b>description</b>	gas injector thread M10x1 WS 12 bore ø 1.3mm		

			
1			
<b>Part No.</b>	100473	<b>Ref. No.</b>	38023003
<b>description</b>	gas injector thread M10x1 WS 12 bore ø 1.45mm		
<b>For models:</b>	G0000, G0002, G0004, G0005, G0007, G0008, G0010, G0016, G0017, G0030, G0031, G0032, G0033, G0034, G0035, G0664, G0665, G0666, G0667, G0669, G0776, G0777, G1014, G1015, G1019		

			
1			
<b>Part No.</b>	100472	<b>Ref. No.</b>	38023002
<b>description</b>	gas injector thread M10x1 WS 12 bore ø 1.4mm		
<b>For models:</b>	G0008		

			
1			
<b>Part No.</b>	100478	<b>Ref. No.</b>	38023008
<b>description</b>	gas injector thread M10x1 WS 12 bore ø 1.75mm		
<b>For models:</b>	G0000, G0002, G0004, G0005, G0007, G0008, G0010, G0016, G0017, G0030, G0031, G0032, G0033, G0034, G0035, G0664, G0665, G0666, G0667, G0669, G0776, G0777, G1014, G1015, G1019		

			
1			
<b>Part No.</b>	100480	<b>Ref. No.</b>	38023012
<b>description</b>	gas injector thread M10x1 WS 12 bore ø 1.85mm		

			
1			
<b>Part No.</b>	100479	<b>Ref. No.</b>	38023004
<b>description</b>	gas injector thread M10x1 WS 12 bore ø 1.8mm		

			
1			
<b>Part No.</b>	100482	<b>Ref. No.</b>	38023011
<b>description</b>	gas injector thread M10x1 WS 12 bore ø 1.95mm		

1

<b>Part No.</b>	100485	<b>Ref. No.</b>	38023005
<b>description</b>	gas injector thread M10x1 WS 12 bore ø 2.2mm		
<b>For models:</b>	G0008		



1

<b>Part No.</b>	100483	<b>Ref. No.</b>	38023009
<b>description</b>	gas injector thread M10x1 WS 12 bore ø 2mm		
<b>For models:</b>	G0000, G0002, G0004, G0005, G0007, G0008, G0009, G0010, G0016, G0017, G0030, G0031, G0032, G0033, G0034, G0035, G0664, G0665, G0666, G0667, G0669, G0776, G0777, G1014, G1015, G1019		



1

<b>Part No.</b>	100491	<b>Ref. No.</b>	38023013
<b>description</b>	gas injector thread M10x1 WS 12 bore ø 3mm		



1

<b>Part No.</b>	107650	<b>Ref. No.</b>	38023085
<b>description</b>	pilot burner nozzle SIT LPG code 30 Qty 1 pcs		



1

<b>Part No.</b>	107173	<b>Ref. No.</b>	38023031
<b>description</b>	pilot burner nozzle SIT natural gas code 35 Qty 1 pcs suitable for 160 series nozzle ø 0.35mm		
<b>For models:</b>	G0000, G0002, G0004, G0005, G0007, G0008, G0009, G0010, G0030, G0031, G0032, G0033, G0034, G0035, G0664, G0665, G0666, G0667, G0669, G0776, G0777		



1

<b>Part No.</b>	107174	<b>Ref. No.</b>	38023104
<b>description</b>	pilot burner nozzle SIT natural gas code 41 Qty 1 pcs		

pilot burner nozzles

pilot burner nozzles SIT

100 series



1

<b>Part No.</b>	100245	<b>Ref. No.</b>	38023032
<b>description</b>	pilot burner nozzle LPG code 20 bore ø 0.2mm Qty 1 pcs thread M8x0.75		
<b>For models:</b>	G0004, G0005, G0007, G0008, G0009, G0010, G0035		



1

<b>Part No.</b>	102972	<b>Ref. No.</b>	38023040 38023082
<b>description</b>	pilot burner nozzle natural gas code 40 bore ø 0.4mm Qty 1 pcs		
<b>For models:</b>	G0004, G0005, G0007, G0008, G0009, G0010, G0035		

160 series



1

<b>Part No.</b>	107649	<b>Ref. No.</b>	38023030
<b>description</b>	pilot burner nozzle SIT LPG code 20 Qty 1 pcs		
<b>For models:</b>	G0000, G0002, G0004, G0005, G0007, G0008, G0009, G0010, G0030, G0031, G0032, G0033, G0034, G0035, G0664, G0665, G0666, G0667, G0669, G0776, G0777		

bypass nozzles

bypass nozzles PEL20/21



1

<b>Part No.</b>	100527	<b>Ref. No.</b>	40020202
<b>description</b>	bypass nozzle type PEL20/21 bore ø 0.85mm thread M5x0.5		



1

<b>Part No.</b>	100557	<b>Ref. No.</b>	40020200
<b>description</b>	bypass nozzle type PEL20/21 bore ø 1.05mm thread M5x0.5		



1

<b>Part No.</b>	100530	<b>Ref. No.</b>	40020203
<b>description</b>	bypass nozzle type PEL20/21 bore ø 1.1mm thread M5x0.5		

bypass nozzles PEL22





1

<b>Part No.</b>	100391	<b>Ref. No.</b>	40020210
<b>description</b>	bypass nozzle type PEL22 bore ø 0.55mm thread M6x0.5		
<b>For models:</b>	G0004, G0005, G0007, G0009, G0010		





			
1			
<b>Part No.</b>	100428	<b>Ref. No.</b>	40020216
<b>description</b>	bypass nozzle type PEL22 bore ø 0.65mm thread M6x0.5		

			
1			
<b>Part No.</b>	100392	<b>Ref. No.</b>	40020215
<b>description</b>	bypass nozzle type PEL22 bore ø 0.6mm thread M6x0.5		

			
1			
<b>Part No.</b>	100432	<b>Ref. No.</b>	40020218
<b>description</b>	bypass nozzle type PEL22 bore ø 0.75mm thread M6x0.5		

			
1			
<b>Part No.</b>	100429	<b>Ref. No.</b>	40020217
<b>description</b>	bypass nozzle type PEL22 bore ø 0.7mm thread M6x0.5		

			
1			
<b>Part No.</b>	100410	<b>Ref. No.</b>	40020211
<b>description</b>	bypass nozzle type PEL22 bore ø 0.85mm thread M6x0.5		
<b>For models:</b>	G0004, G0005, G0007, G0009, G0010		

			
1			
<b>Part No.</b>	100409	<b>Ref. No.</b>	40020219
<b>description</b>	bypass nozzle type PEL22 bore ø 0.8mm thread M6x0.5		

			
1			
<b>Part No.</b>	100435	<b>Ref. No.</b>	40020212
<b>description</b>	bypass nozzle type PEL22 bore ø 1.05mm thread M6x0.5		

			
1			
<b>Part No.</b>	100436	<b>Ref. No.</b>	40020214
<b>description</b>	bypass nozzle type PEL22 bore ø 1.1mm thread M6x0.5		

## auxiliary gas parts

## screw connections

## olives

			
1			
<b>Part No.</b>	101857	<b>Ref. No.</b>	40021125
<b>description</b>	olive for pipe ø 6mm Qty 1 pcs suitable for 160 series for pilot burner		
<b>For models:</b>	G0000, G0002, G0004, G0005, G0007, G0008, G0009, G0010, G0030, G0031, G0032, G0033, G0034, G0035, G0664, G0665, G0666, G0667, G0669, G0776, G0777		

## union screws

			
1			
<b>Part No.</b>	100908	<b>Ref. No.</b>	105076
<b>description</b>	union screw thread M10x1 for pipe ø 4mm Qty 1 pcs		
<b>For models:</b>	G1500, G1501		
<b>accessories for</b>	100908		
	<b>Part No.</b>	100897	<b>Ref. No.</b> —
olive for pipe ø 4mm Qty 1 pcs for pilot burner			
	<b>Part No.</b>	101246	<b>Ref. No.</b> —
olive for pipe ø 4mm Qty 1 pcs			
	<b>Part No.</b>	101280	<b>Ref. No.</b> —
olive for pipe ø 4mm Qty 1 pcs			
	<b>Part No.</b>	101282	<b>Ref. No.</b> —
olive for pipe ø 4mm L 7.4mm Qty 1 pcs			

			
1			
<b>Part No.</b>	100909	<b>Ref. No.</b>	40021603
<b>description</b>	union screw thread M10x1 for pipe ø 6mm Qty 1 pcs		
<b>For models:</b>	G1500, G1501		
<b>accessories for</b>	100909		
	<b>Part No.</b>	100898	<b>Ref. No.</b> —
olive for pipe ø 6mm Qty 1 pcs for pilot burner			
	<b>Part No.</b>	101286	<b>Ref. No.</b> —
olive ID ø 6mm Qty 1 pcs			
	<b>Part No.</b>	101287	<b>Ref. No.</b> —
olive for pipe ø 6mm Qty 1 pcs			
	<b>Part No.</b>	101288	<b>Ref. No.</b> —
olive for pipe ø 6mm L 6mm aluminium Qty 1 pcs ED ø 8.5mm			



## equipment-specific units

### for tilting bratt pans

#### miscellaneous



1			
<b>Part No.</b>	693111	<b>Ref. No.</b>	38040401
<b>description</b>	spindle		
<b>For models:</b>	G1700, G1701, G1704, G1705		

### for pasta cookers



1			
<b>Part No.</b>	698999	<b>Ref. No.</b>	40041002
<b>description</b>	lever with bezel		
<b>For models:</b>	G1200, G1201, G1210, G1211, G1300, G1301		

## handles and hand wheels

### hand wheels

#### hand wheels



1			
<b>Part No.</b>	692443	<b>Ref. No.</b>	40040220
<b>description</b>	hand wheel $\varnothing$ 150mm D1 $\varnothing$ 38mm bore $\varnothing$ 14mm thread groove width 6mm groove depth 13mm mounting distance 18mm L1 40mm L2 43mm handle length 65mm with folding handle		
<b>For models:</b>	G1700, G1701, G1704, G1705		



1			
<b>Part No.</b>	692430	<b>Ref. No.</b>	40040221
<b>description</b>	hand wheel $\varnothing$ 200mm D1 $\varnothing$ 50mm bore $\varnothing$ 20mm thread groove width 6mm groove depth 13mm mounting distance 30mm L1 47mm L2 50mm handle length 90mm with folding handle		

### ball handles



1			
<b>Part No.</b>	540323	<b>Ref. No.</b>	40041009
<b>description</b>	ball handle thread M10 $\varnothing$ 40mm with metal bush black		

## hinges

### oven hinges

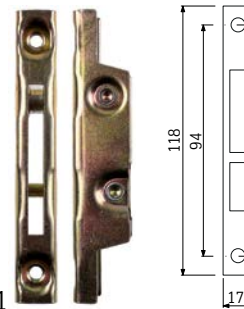



1			
<b>Part No.</b>	700001	<b>Ref. No.</b>	40040210
<b>description</b>	opposite support L 118mm W 17mm mounting distance 94mm		
<b>For models:</b>	G0004, G0007, G0008, G0009, G0010, G0017, G0031, G0033, G0035, G0104, G0107, G0114, G0117, G0122, G0666, G0667, G0704, G0705, G0776, G0777		





1

<b>Part No.</b>	700006	<b>Ref. No.</b>	40040201
<b>description</b>	oven hinge mounting distance 173mm mounting distance 2 105mm lug mounting 14mm lever length 120mm groove distance 11mm spring thickness 3.5mm mounting ear position left spring length 112mm W 25mm		
<b>For models:</b>	G0004, G0007, G0008, G0009, G0010, G0017, G0031, G0033, G0035, G0104, G0107, G0114, G0117, G0122, G0666, G0667, G0704, G0705, G0776, G0777		
<b>accessories for</b>	700006		
	<b>Part No.</b>	700001	<b>Ref. No.</b> 40040210
	opposite support L 118mm W 17mm mounting distance 94mm		
	<b>Part No.</b>	700007	<b>Ref. No.</b> 40040200
	oven hinge mounting distance 173mm mounting distance 2 105mm lug mounting 14mm lever length 120mm groove distance 11mm spring thickness 3.5mm mounting ear position right spring length 112mm W 25mm		

## fittings for catering equipment



### lid hinges

#### FIREX

#### lid hinges



1

<b>Part No.</b>	514412	<b>Ref. No.</b>	40040224
<b>description</b>	lid hinge L 230mm mounting distance 1 150mm flange radius 320mm spring thickness 4mm for circular lids		
<b>spare parts for</b>	514412		
	<b>Part No.</b>	540846	<b>Ref. No.</b> —
	torsion spring $\varnothing$ 42.5mm wire gauge $\varnothing$ 4.1mm L1 93mm L2 26mm L3 26mm mounting pos. left		
	<b>Part No.</b>	540847	<b>Ref. No.</b> —
	torsion spring $\varnothing$ 42.5mm wire gauge $\varnothing$ 4.1mm L1 93mm L2 26mm L3 26mm mounting pos. right		

### drain taps

#### brass

#### drain taps





1

<b>Part No.</b>	540275	<b>Ref. No.</b>	40050025
<b>description</b>	drain tap 2" IT with union nut A 90mm B 151mm B1 80mm chrome-plated brass		
<b>spare parts for</b>	540275		
	<b>Part No.</b>	540214	<b>Ref. No.</b> —
	handle ID $\varnothing$ 6mm L 145mm		
<b>accessories for</b>	540275		
	<b>Part No.</b>	529484	<b>Ref. No.</b> —
	flat gasket fibre ED $\varnothing$ 58mm ID $\varnothing$ 50mm thickness 2mm Qty 1 pcs		
	<b>Part No.</b>	542448	<b>Ref. No.</b> —
	gasket silicone 60x49x2 for drain tap 2"		

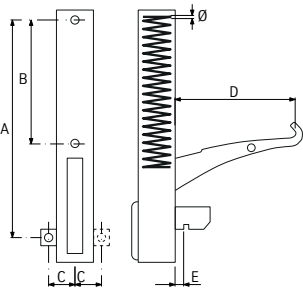

1



<b>Part No.</b>	700007	<b>Ref. No.</b>	40040200
<b>description</b>	oven hinge mounting distance 173mm mounting distance 2 105mm lug mounting 14mm lever length 120mm groove distance 11mm spring thickness 3.5mm mounting ear position right spring length 112mm W 25mm		
<b>For models:</b>	G0004, G0007, G0008, G0009, G0010, G0017, G0031, G0033, G0035, G0104, G0107, G0114, G0117, G0122, G0666, G0667, G0704, G0705, G0776, G0777		
<b>accessories for</b>	700007		
	<b>Part No.</b>	700001	<b>Ref. No.</b> 40040210
	opposite support L 118mm W 17mm mounting distance 94mm		



accessories



1			
<b>Part No.</b>	540958	<b>Ref. No.</b>	40050026
<b>description</b>	rosette for drain tap hose ext. ø 120mm ID ø 60mm H 13mm		

**gaskets**

gaskets for heated units

door seals with fixing hook

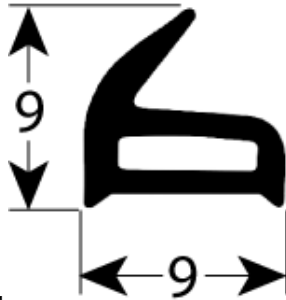

1			
<b>Part No.</b>	901947	<b>Ref. No.</b>	38040300
<b>description</b>	door seal L 720mm with 5 mounting clips		
<b>For models:</b>	G0004, G0007, G0008, G0009, G0010, G0017, G0031, G0033, G0035, G0104, G0107, G0114, G0117, G0122, G0666, G0667, G0704, G0705, G0776, G0777		





1			
<b>Part No.</b>	902142	<b>Ref. No.</b>	38040301
<b>description</b>	gasket L 315mm 3 Qty 1 pcs		
<b>For models:</b>	G0004, G0007, G0008, G0009, G0010, G0017, G0031, G0033, G0035, G0104, G0107, G0114, G0117, G0122, G0666, G0667, G0704, G0705, G0776, G0777		

**valves and tank inlets**

shut-off valves

universal



1			
<b>Part No.</b>	693107	<b>Ref. No.</b>	40050000
<b>description</b>	shut-off valve connection 1/2" 1/2" cold total length 54mm L1 27mm L2 30mm marking blue rosette thread G2 26x19G connection ø M4x0.7 ITmm		
<b>For models:</b>	G1700, G1701, G1702, G1704, G1705, G1706		
<b>spare parts for</b>	693107		
	<b>Part No.</b>	514085	<b>Ref. No.</b> —
	rosette connection 26x19G chrome-plated total lengthmm mounting pos.		
	<b>Part No.</b>	514086	<b>Ref. No.</b> —
	hexagonal nut connection 26x19G brass total lengthmm mounting pos. H 6mm WS 34 Qty 1 pcs		
	<b>Part No.</b>	540672	<b>Ref. No.</b> —
	gasket suitable for tap head		
	<b>Part No.</b>	547711	<b>Ref. No.</b> —
	hood handle shaft intake ø 8mm marking blue metal H2 21mm D1 ø 33mm type D suitable for MONOLITH shaft length H1 8mm		
	<b>Part No.</b>	548168	<b>Ref. No.</b> —
	star handle connection hot total lengthmm mounting pos. ø 57mm marking red		
	<b>Part No.</b>	548169	<b>Ref. No.</b> —
	star handle connection cold total lengthmm mounting pos. chrome-plated ø 57mm		
<b>accessories for</b>	693107		
	<b>Part No.</b>	514086	<b>Ref. No.</b> —
	hexagonal nut connection 26x19G brass total lengthmm mounting pos. H 6mm WS 34 Qty 1 pcs		

**consumables**

fuses

fine fuses



1			
<b>Part No.</b>	358605	<b>Ref. No.</b>	40000500 40000503
<b>description</b>	fine fuse size ø5x20mm 3.15A slow-acting rated 250V Qty 10 pcs		
<b>For models:</b>	G1701, G1702, G1705, G1706		

mechanical components,  
equipment accessories  
1

**GASTRO**PARTS.COM

