



GASTROPARTS

Liebherr

- [EN]** Equipment
- [DE]** Geräte
- [ES]** Aparatos
- [FR]** Équipement
- [IT]** Attrezzature
- [PL]** Urządzenia
- [RU]** Оборудование

✉ gastroparts@gastroparts.com

☎ +48 56 657 00 66

📘 fb.com/gastroparts.global

GASTROPARTS.COM





thermostats

refrigeration thermostats

RANCO

K50 series

RANCO



1

Part No.	390619	Ref. No.	6151995
description	thermostat RANCO type K50P6073/001 probe ømm probe Lmm capillary pipe 2000mm		
For models:	FKS 5000-20E		
accessories for	390619		
	Part No.	112945	Ref. No. 7422505
	knob ø 22mm shaft ø 6x4.6mm shaft flat vertical white		

K57 series

RANCO



1

Part No.	390618	Ref. No.	6151761
description	thermostat RANCO type K57L2865 capillary pipe 1950mm temperature range -40 up to +40°C probe ø9.5x107mm		
accessories for	390618		
	Part No.	112945	Ref. No. 7422505
	knob ø 22mm shaft ø 6x4.6mm shaft flat vertical white		

RANCO



1

Part No.	390617	Ref. No.	6151753
description	thermostat RANCO type K57-L2866 probe ø 2mm probe Lmm capillary pipe 2000mm temperature range -40 up to +40°C		

switches and momentary switches

microswitches

with push button

switches with snap-fit



1

Part No.	347018	Ref. No.	6060995
description	microswitch with push button 250V 1A 1CO connection male faston 2.8mm L 28x12mm ambient temperature max. 85°C actuating force: 60g		

magnetic switches

accessories

magnets



1

Part No.	691490	Ref. No.	7424266
description	magnet ømm L 29.5mm H 7mm W 28.5mm hole distance 13mm		

probes

producer-specific probes

probes



1

Part No.	379753	Ref. No.	6942216 6942236 9590088 9590142-00
description	probe NTC cable PVC probe -40 up to +110°C cable -10 up to 100°C connection 2-wire thread M15x1.75 probe ø8x29mm cable length 3.1m		



1

Part No.	381418	Ref. No.	9590 206-00
description	probe repair set NTC cable PVC probe -40 up to +110°C cable -10 up to 100°C connection 2-wire thread M15x1.75 probe ø8x29mm cable length 3.1m		



electronics

PCBs

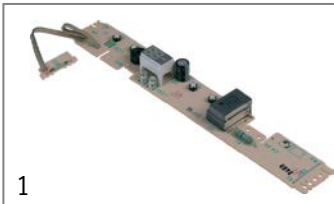

1

Part No.	402069	Ref. No.	6113321 6114289-00 6114431-00 6114489-00 6114667-00
description	keypad PCB refrigerator GKV5710		

compressors

EMBRACO / ASPERA



R600A

LBP monophase

Lower evaporation temperature below -20°C



1

Part No.	605085	Ref. No.	6119659
description	compressor coolant R600a type EMT45CDP 220-240V 50Hz HBP fully hermetic 7.7kg 1/8HP power input 152W cylinder capacity 6.78cm ³ RSIRWW 164W 209W 262W 322W 392W 477W test method ASHRAE		
For models:	FKS 5000-20E		
spare parts for	605085		
	Part No.	381088	Ref. No. 6940650
	start relay		
	Part No.	390620	Ref. No. 6940609
	overload protector for engine protective curcuit breaker T0357/07 t.max. 150°C reset automatic		



HBP monophase

High evaporation temperature above -15°C

R600a



1

Part No.	605083	Ref. No.	6119717
description	compressor coolant R600a type EMT30CDP 220-240V 50Hz HBP fully hermetic 7.2kg 1/8HP cylinder capacity 4.5cm ³ RSIR H 158mmWW 112W 142W 180W 222W 268W 320W test method ASHRAE		
spare parts for	605083		
	Part No.	381088	Ref. No. 6940650
	start relay		
	Part No.	390621	Ref. No. 6941014
	overload protector for engine protective curcuit breaker T0224/07 t.max. 150°C reset automatic		

accessories

starting relays

miscellaneous



1

Part No.	381087	Ref. No.	6940863
description	start relay		



1

Part No.	381088	Ref. No.	6940650
description	start relay		
For models:	FKS 5000-20E		



overload protector (klixon)



1

Part No.	390621	Ref. No.	6941014
description	overload protector for engine protective curcuit breaker T0224/07 t.max. 150°C reset automatic		



1

Part No.	390620	Ref. No.	6940609
description	overload protector for engine protective curcuit breaker T0357/07 t.max. 150°C reset automatic		
For models:	FKS 5000-20E		

fans

refrigeration fans

cold air circulating fans

cold air circulating fans



1

Part No.	601477	Ref. No.	6118671 6118791
description	fan motor 230V 50-60Hz shaft L 22mm shaft ø 3mm type F61-10		
accessories for	601477		
	Part No.	601480	Ref. No. 6299905
	fan wheel blowing ø 164mm W 27mm shaft intake ø 3mm plastic blades 3		



1

Part No.	601479	Ref. No.	6108993 6118787 6118795
description	fan motor 230V 50-60Hz shaft L 22mm shaft ø 3mm type F61-10G		
accessories for	601479		
	Part No.	601480	Ref. No. 6299905
	fan wheel blowing ø 164mm W 27mm shaft intake ø 3mm plastic blades 3		



1

Part No.	601478	Ref. No.	6118751
description	fan motor 230V 50-60Hz shaft L 22mm shaft ø 3mm type F61-10G with plug		
accessories for	601478		
	Part No.	601480	Ref. No. 6299905
	fan wheel blowing ø 164mm W 27mm shaft intake ø 3mm plastic blades 3		

accessories

fan wheels for cold air circulating fans



1

Part No.	601480	Ref. No.	6299905
description	fan wheel blowing ø 164mm W 27mm shaft intake ø 3mm plastic blades 3		

brackets for cold air circulating fans



1

Part No.	691504	Ref. No.	7427581
description	bracket		



1

Part No.	691478	Ref. No.	7422558
description	bracket for fan		



1

Part No.	691479	Ref. No.	7427579 7430145 7430145-00
description	bracket for fan		



equipment-specific units

for fridges

housing and bezels

holders



1

Part No.	691491	Ref. No.	7424773
description	bracket		

knobs

producer-specific knobs

LIEBHERR



1

Part No.	112945	Ref. No.	7422505
description	knob ø 22mm shaft ø 6x4.6mm shaft flat vertical white		
For models:	FKS 5000-20E		

handles and hand wheels

miscellaneous



1

Part No.	691492	Ref. No.	7042411 7042411-01
description	door handle L 190mm W 83mm hole distance 155mm refrigerator white H 25mm		
For models:	FKS 5000-20E		

locks

locking devices

producer-specific

LIEBHERR



1

Part No.	691481	Ref. No.	7043513
-----------------	--------	-----------------	---------

description key cylinder**accessories for** 691481

	Part No.	691482	Ref. No.	7042814
---	-----------------	--------	-----------------	---------

spare keys for key cylinder 691481



1

Part No.	691483	Ref. No.	7041775 7041789
-----------------	--------	-----------------	--------------------

description key cylinder**accessories for** 691483

	Part No.	691484	Ref. No.	7042837
---	-----------------	--------	-----------------	---------

spare keys for key cylinder 691483



1



Part No.	691489	Ref. No.	7043075-00 7043075-00 + 9190305-00 /020 7043075-00 9190305-00 /020 7043195-00 7043343 9190345-00
-----------------	--------	-----------------	--

description key cylinder**accessories for** 691489

	Part No.	691486	Ref. No.	7042196 7043341
---	-----------------	--------	-----------------	--------------------

spare keys for key cylinder 691485, 691489



 <p>1</p>			
Part No.	691485	Ref. No.	7042356 7042846 7042846-00
description	key cylinder closer		
For models:	FKS 5000-20E		
accessories for	691485		
	Part No.	691486	Ref. No. 7042196 7043341
spare keys for key cylinder 691485, 691489			

 <p>1</p>			
Part No.	691482	Ref. No.	7042814
description	spare keys for key cylinder 691481		

 <p>1</p>			
Part No.	691484	Ref. No.	7042837
description	spare keys for key cylinder 691483		

 <p>1</p>			
Part No.	691486	Ref. No.	7042196 7043341
description	spare keys for key cylinder 691485, 691489		
For models:	FKS 5000-20E		

hinges

door bearing

 <p>1</p>			
Part No.	700758	Ref. No.	
description	bearing block L 42mm W 38mm H 48mm mounting distance 28mm bolt 51mm bolt ø 8mm		

 <p>1</p>			
Part No.	700756	Ref. No.	7113077
description	bolt L 21mm thread M6 ø 6mm for hinge		
For models:	FKS 5000-20E		

 <p>1</p>			
Part No.	700750	Ref. No.	7113761
description	bolt L 48mm thread M6 ø 8mm for hinge		

 <p>1</p>			
Part No.	700755	Ref. No.	7043029 7043461
description	bolt L 50mm ø 8mm		

 <p>1</p>			
Part No.	700754	Ref. No.	7422079
description	bush L 30mm ø 9mm white for hinge		
For models:	FKS 5000-20E		

 <p>1</p>			
Part No.	700752	Ref. No.	7429351
description	bush L 46mm mounting pos. left ø 14mm white for hinge		

 <p>1</p>			
Part No.	700753	Ref. No.	7429349
description	bush L 46mm mounting pos. right ø 14mm white for hinge		





1

Part No.	700751	Ref. No.	7429517
description	bush L 49mm ø 11mm white for hinge		



1

Part No.	700757	Ref. No.	9450057
description	hinge refrigerator		
For models:	FKS 5000-20E		
spare parts for	700757		
	Part No.	700756	Ref. No. 7113077
	bolt L 21mm thread M6 ø 6mm for hinge		

screw-in feet



1

Part No.	701207	Ref. No.	7042301
description	equipment foot thread M10 WS 22 L 20mm		
For models:	FKS 5000-20E		

equipment feet with stem



1

Part No.	701206	Ref. No.	7402121
description	equipment foot ø 32mm H 14mm mounting ø 10mm overall height 25.5mm plastic Qty 1 pcs		
For models:	FKS 5000-20E		

filters

device filters



1

Part No.	694678	Ref. No.	7429177
description	air filter L 315mm W 265mm ømm H 120mm LKPV/LGPV 1420,652 suitable for LIEBHERR		

equipment feet and end caps

equipment feet

with screw mounting



1

Part No.	701205	Ref. No.	7043485
description	equipment foot tube ø 67mm thread M10 thread L 15mm H 150-210mm SS size 2 1/2" Qty 1 pcs		

gaskets

refrigeration gaskets

miscellaneous

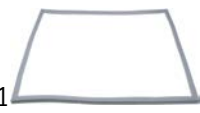

1

Part No.	901339	Ref. No.	7108528-00 7108528-00+7108528-00 7111062-00 7111062-00+9096042-00
description	refrigeration gasket conversion kit W 580mm L 675mm external size		



1

Part No.	901338	Ref. No.	7108136 7111004-00 7111004-00+9096042-00
description	refrigeration gasket conversion kit W 585mm L 765mm external size		



1

Part No.	901337	Ref. No.	7108154+9086532+7081554 7108154-00
description	refrigeration gasket conversion kit W 747mm L 1400mm external size FKS 5000/5010, UKS 5000		



plug-in gaskets

profile 9952

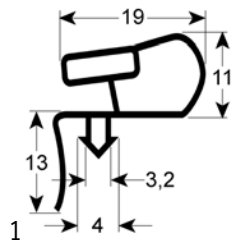

Part No.	901275	Ref. No.	7108383
description	refrigeration gasket profile 9952 W 572mm L 733mm plug size		

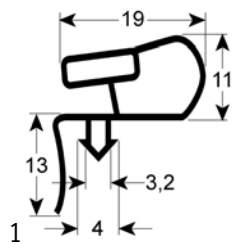

Part No.	900801	Ref. No.	7108357
description	refrigeration gasket profile 9952 W 580mm L 1650mm plug size		

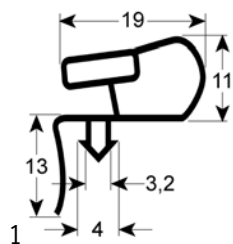

Part No.	900798	Ref. No.	7108393
description	refrigeration gasket profile 9952 W 580mm L 760mm plug size		

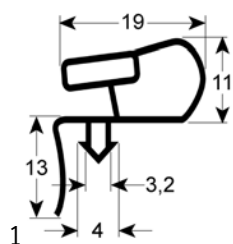

Part No.	901340	Ref. No.	7109677-00 7109677-00+7080419-00
description	refrigeration gasket profile 9952 W 585mm L 1665mm plug size service kit		

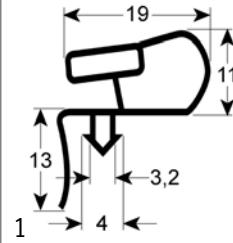

Part No.	900800	Ref. No.	7109407
description	refrigeration gasket profile 9952 W 710mm L 1565mm plug size		

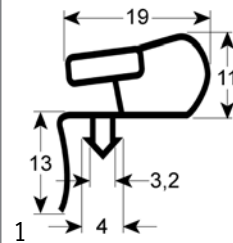

Part No.	900799	Ref. No.	7108401
description	refrigeration gasket profile 9952 W 730mm L 1380mm plug size		
For models:	FKS 5000-20E		

profile 9505

We offer custom-made gaskets for this profile

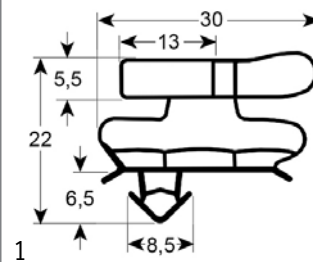

Part No.	902039	Ref. No.	N/A
description	refrigeration gasket profile 9505 Wmm L 2500mm		

screw-in gaskets

profile 9515

We offer custom-made gaskets for this profile

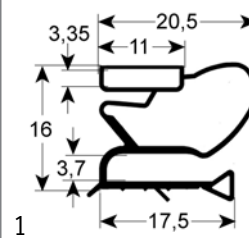

Part No.	902287	Ref. No.	N/A
description	refrigeration gasket profile 9515 Wmm L 2500mm		



refrigeration cycle components

filter driers

miscellaneous



1

Part No.	750165	Ref. No.	5942032 5942034 5942036
description	dryer size 10g ø 16mm L 125mm connection 2,1/4,9mm		
For models:	FKS 5000-20E		

evaporators

for fridges

producer-specific



1

Part No.	750147	Ref. No.	5940997
description	evaporator for fridge FKS 5000 L 850mm W 575mm type FKS5000/02 LIEBHERR		
For models:	FKS 5000-20E		



1

Part No.	750146	Ref. No.	5940757
description	evaporator for fridge FKV 4310 L 1000mm W 460mm type FKDV 3712-20 A LIEBHERR		



1

Part No.	750148	Ref. No.	5940995
description	evaporator for fridge UKS 1800 L 430mm W 460mm LIEBHERR		

measuring equipment

thermometers

built-in thermometers



1

Part No.	541929	Ref. No.	6111959
description	thermometer mounting measurements 58x25.5mm -40 up to +40°C capillary pipe 700mm probe ø 6mm probe L 85mm		

battery powered



1

Part No.	379752	Ref. No.	6111963 6111997
description	thermometer mounting measurements 58x25.5mm front measurements 29x62mm battery comp. front up to +100°C cable length 2200mm		

GASTROPARTS.COM

