



**GASTROPARTS**

# Lamber

**[EN]** Equipment

**[DE]** Geräte

**[ES]** Aparatos

**[FR]** Équipement

**[IT]** Attrezzature

**[PL]** Urządzenia

**[RU]** Оборудование

✉ [gastroparts@gastroparts.com](mailto:gastroparts@gastroparts.com)

☎ +48 56 657 00 66

📘 [fb.com/gastroparts.global](https://fb.com/gastroparts.global)

**GASTROPARTS.COM**





# heating elements



## coil heating elements



1 			
<b>Part No.</b>	418823	<b>Ref. No.</b>	0303100
<b>description</b>	heating element 1000W 230V L 405mm W 50mm H 25mm tube ø 8.5mm thread M14x1.5 connection M5 heating circuits 1		

## immersion heating elements



### 3 hole flange ø57.5mm

1 			
<b>Part No.</b>	416229	<b>Ref. No.</b>	0303001
<b>description</b>	heating element 2400W 230V mounting ø 57.5mm heating circuits 2 L 235mm W 37mm H 35mm number of thermostat sleeves 1 thermostat sleeves ø 7mm length thermostat sleeves 225mm thermostat sleeve not clinging tube ø 8mm hole distance 75mm hole ø 7.8mm connection length 29mm connection M5 3 hole flange immersion heater		
<b>For models:</b>	DSP1, DSP2, S200, S280, S280Dep, Super-QS, Super-QS-Dep		

1 			
<b>Part No.</b>	416230	<b>Ref. No.</b>	0300011
<b>description</b>	heating element 3000W 230V mounting ø 57.5mm heating circuits 3 L 235mm W 34mm H 48mm number of thermostat sleeves 1 thermostat sleeves ø 7mm length thermostat sleeves 215mm thermostat sleeve upper tube ø 8.5mm hole distance 72mm hole ø 10mm connection length 20mm connection M5 3 hole flange immersion heater		
<b>For models:</b>	015-24L, 050F, 050F-Dep, DSP5, MATIC20, P550		
<b>spare parts for</b>	416230		
		<b>Part No.</b>	510409 <b>Ref. No.</b> 0200041
	O-ring EPDM thickness 5.34mm ID ø 56.52mm Qty 1 pcs		

1 			
<b>Part No.</b>	416231	<b>Ref. No.</b>	0300002
<b>description</b>	heating element 4500W 230V mounting ø 57.5mm heating circuits 3 L 307mm W 45mm H 36mm number of thermostat sleeves 1 thermostat sleeves ø 7mm length thermostat sleeves 210mm thermostat sleeve eccentric, non clinging tube ø 8.5mm hole distance 74mm hole ø 8/10mm connection M5 3 hole flange immersion heater		
<b>For models:</b>	DSP4, DSP5, F85, F85-Dep, MATIC20		
<b>spare parts for</b>	416231		
		<b>Part No.</b>	510409 <b>Ref. No.</b> 0200041
	O-ring EPDM thickness 5.34mm ID ø 56.52mm Qty 1 pcs		

<b>accessories for</b>	416231		
	<b>Part No.</b>	520258	<b>Ref. No.</b> 0301112
	protection cap		

1 			
<b>Part No.</b>	416232	<b>Ref. No.</b>	0300012
<b>description</b>	heating element 6000W 230V mounting ø 57.5mm heating circuits 3 L 293mm W 40mm H 36mm number of thermostat sleeves 1 thermostat sleeves ø 7mm length thermostat sleeves 280mm thermostat sleeve eccentric, non clinging tube ø 8.5mm hole distance 74mm hole ø 8x10mm connection M5 3 hole flange immersion heater		
<b>For models:</b>	015-24L, F85, F85-Dep, L20, L21, LP31L, LP6L, M115, M150, MATIC20, P550		
<b>spare parts for</b>	416232		
		<b>Part No.</b>	510409 <b>Ref. No.</b> 0200041
	O-ring EPDM thickness 5.34mm ID ø 56.52mm Qty 1 pcs		

1 			
<b>Part No.</b>	416233	<b>Ref. No.</b>	0300299
<b>description</b>	heating element 9000W 230V mounting ø 57.5mm heating circuits 3 L 440mm W 42mm H 38mm number of thermostat sleeves 1 thermostat sleeves ø 7.5mm length thermostat sleeves 290mm thermostat sleeve eccentric, non clinging tube ø 8.5mm hole distance 73mm hole ø 8/10mm connection M5 3 hole flange immersion heater		
<b>For models:</b>	015-24L, LP31L, LP6, LP6L, M115, M150, MATIC20		
<b>accessories for</b>	416233		
	<b>Part No.</b>	520258	<b>Ref. No.</b> 0301112
	protection cap		





1 			
<b>Part No.</b>	416225	<b>Ref. No.</b>	0303042
<b>description</b>	heating element 2400W 230V heating circuits 3 thread 1 1/4" L 275mm W 90mm H 40mm L1 25mm L2 50mm L3 200mm W1 31mm W2 28mm H1 20mm H2 20mm connection M4 immersion heater tube ø 6.3mm flange with thread connection length 40mm WS 32		
<b>For models:</b>	DSP5		
<b>spare parts for</b>	416225		
		<b>Part No.</b>	519179 <b>Ref. No.</b> —
	O-ring EPDM thickness 3.53mm ID ø 41.28mm Qty 1 pcs		
<b>accessories for</b>	416225		
		<b>Part No.</b>	510405 <b>Ref. No.</b> —
	flat gasket fibre ED ø 56mm ID ø 42mm thickness 2mm for thread 1 1/4" Qty 1 pcs		



Table continues overleaf



<b>accessories for</b>	416225			
	Part No.	520232	Ref. No.	—
	nut thread 1/4" H 5mm nickel-plated brass WS 47 Qty 1 pcs			
	Part No.	528021	Ref. No.	—
	flat gasket PTFE ED ø 53mm ID ø 42.5mm thickness 3mm Qty 1 pcs equiv. no. 12001/02286 suitable for Astoria/Aurora/Brasilia/Wega			





<b>Part No.</b>	416226	<b>Ref. No.</b>	0300022
<b>description</b>	heating element 4500W 230V heating circuits 3 thread 1/4" L 260mm W 90mm H 35mm L1 60mm L2 50mm L3 150mm W1 31mm W2 28mm H1 15mm H2 20mm connection M4 immersion heater tube ø 6.3mm flange with thread connection length 42mm		

<b>accessories for</b>	416226			
	Part No.	510405	Ref. No.	—
	flat gasket fibre ED ø 56mm ID ø 42mm thickness 2mm for thread 1/4" Qty 1 pcs			
	Part No.	520232	Ref. No.	—
	nut thread 1/4" H 5mm nickel-plated brass WS 47 Qty 1 pcs			
	Part No.	528021	Ref. No.	—
	flat gasket PTFE ED ø 53mm ID ø 42.5mm thickness 3mm Qty 1 pcs equiv. no. 12001/02286 suitable for Astoria/Aurora/Brasilia/Wega			



<b>Part No.</b>	420358	<b>Ref. No.</b>	0303045	
<b>description</b>	heating element 1000W 230V heating circuits 1 L 125mm W 40mm H 35mm thread 1/4" mounting distance 32mm tube ø 8mm connection male faston 6.3mm immersion heater 2 hole fixing			
<b>accessories for</b>	420358			
	Part No.	501362	Ref. No.	—
	flat gasket fibre ED ø 22mm ID ø 13.5mm thickness 2mm Qty 1 pcs			







<b>Part No.</b>	416227	<b>Ref. No.</b>	0303044	
<b>description</b>	heating element 1000W 230V heating circuits 1 L 195mm W 40mm thread 1/4" mounting distance 32mm tube ø 8mm 2 hole fixing immersion heater connection male faston 6.3mm			
<b>For models:</b>	S200			
<b>accessories for</b>	416227			
	Part No.	361182	Ref. No.	—
	nut thread 1/4" H 5mm nickel-plated brass WS 17 Qty 1 pcs			
	Part No.	510417	Ref. No.	—
	flat gasket fibre ED ø 20mm ID ø 14mm thickness 2mm Qty 1 pcs			
	Part No.	520228	Ref. No.	—
	tooth lock washer ID ø 15.3mm ED ø 24mm steel Qty 1 pcs for thread M14			

<b>accessories for</b>	416227			
	Part No.	550262	Ref. No.	—
	flat gasket copper ED ø 20mm ID ø 14mm thickness 2mm			



<b>Part No.</b>	416228	<b>Ref. No.</b>	0300067
<b>description</b>	heating element 2000W 230V heating circuits 1 L 197mm W 46mm H 33mm thread 1/4" mounting distance 38mm tube ø 8.5mm connection male faston 6.3mm immersion heater 2 hole fixing		
<b>For models:</b>	050F, 050F-Dep, DSP1, DSP2, DSP4, F85, F85-Dep, L20, L21, S280, S280Dep, Super-QS, Super-QS-Dep		

<b>accessories for</b>	416228			
	Part No.	361182	Ref. No.	—
	nut thread 1/4" H 5mm nickel-plated brass WS 17 Qty 1 pcs			
	Part No.	510417	Ref. No.	—
	flat gasket fibre ED ø 20mm ID ø 14mm thickness 2mm Qty 1 pcs			
	Part No.	520228	Ref. No.	—
	tooth lock washer ID ø 15.3mm ED ø 24mm steel Qty 1 pcs for thread M14			
	Part No.	550262	Ref. No.	—
	flat gasket copper ED ø 20mm ID ø 14mm thickness 2mm			



<b>Part No.</b>	420220	<b>Ref. No.</b>	0303050
<b>description</b>	heating element 3000W 230V heating circuits 1 L 270mm W 39mm H 18mm thread 1/4" mounting distance 31mm tube ø 8mm connection screw 2 hole fixing immersion heater		

## thermostats

### bi-metal thermostats

#### safety bi-metal thermostats



<b>Part No.</b>	375913	<b>Ref. No.</b>	0300302
<b>description</b>	bi-metal safety thermostat hole distance 23.8mm switch-off temp. 105°C 1NC 1-pole 16A connection F6.3 2 hole fixing mounting ø 18mm		
<b>For models:</b>	015-24L, DSP4, DSP5, F85-Dep, L20, L21		





 <p>1</p>			
<b>Part No.</b>	390681	<b>Ref. No.</b>	0300301
<b>description</b>	bi-metal safety thermostat hole distance 40mm switch-off temp. 105°C 2NC 2-pole 16A 250V connection F6.3		
<b>For models:</b>	050F, 050F-Dep, DSP1, DSP2		

bi-metal thermostats			
 <p>1</p>			
<b>Part No.</b>	390680	<b>Ref. No.</b>	0300303
<b>description</b>	bi-metal thermostat hole distance 23.8mm switch-off temp. 65°C 1NC 1-pole 16A connection F6.3 2 hole fixing		
<b>For models:</b>	DSP1, DSP2, DSP4, DSP5		

control and safety thermostats

IMIT / TEMPOMATIC / ARTHERMO

control thermostats			
 <p>1</p>			
<b>Part No.</b>	390460	<b>Ref. No.</b>	0300005
<b>description</b>	thermostat t.max. 90°C temperature range 30-90°C 1-pole 1C0 16A probe ø 6.5mm probe L 95mm capillary pipe 2000mm capillary pipe isolated 1950mm gland nut shaft ømm shaft Lmm shaft position rotation 270° probe material copper		
<b>For models:</b>	015-24L, 050F, 050F-Dep, DSP1, DSP2, DSP4, DSP5, F85, F85-Dep, L20, L21, LP31L, LP6, LP6L, P550, S200, S280, S280Dep, Super-QS, Super-QS-Dep		

safety thermostats			
 <p>1</p>			
<b>Part No.</b>	390751	<b>Ref. No.</b>	0300305
<b>description</b>	safety thermostat switch-off temp. 80°C 1-pole 1C0 probe ø 5mm probe L 131mm capillary pipe 1000mm capillary pipe isolated 930mm gland nut probe		
<b>For models:</b>	M115, M150, MATIC20		

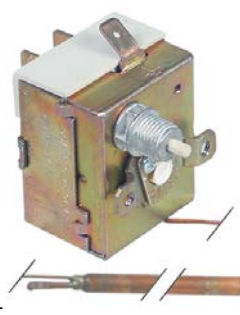
 <p>1</p>			
<b>Part No.</b>	390458	<b>Ref. No.</b>	0300004 0300196
<b>description</b>	safety thermostat switch-off temp. 90-110°C 1-pole 16A probe ø 6.5mm probe L 90mm capillary pipe 2000mm capillary pipe isolated 1950mm gland nut probe		
<b>For models:</b>	F85, LP31L, LP6, LP6L, P550, S200, S280, S280Dep, Super-QS, Super-QS-Dep		

PRODIGY / FIRT

control thermostats			
 <p>1</p>			
<b>Part No.</b>	390733	<b>Ref. No.</b>	0300270
<b>description</b>	thermostat t.max. 90°C temperature range 30-90°C 1-pole 16A probe ø 6.5mm probe L 85mm capillary pipe 1350mm capillary pipe isolated 1325mm shaft ø 6x4.6mm shaft L 5mm rotation 270° 230V with knob		
<b>For models:</b>	M115, M150, MATIC20		

accessories

plunger sockets			
 <p>1</p>			
<b>Part No.</b>	506059	<b>Ref. No.</b>	0200270
<b>description</b>	thermowell double		
<b>For models:</b>	015-24L, F85, LP31L, LP6, LP6L, M115, M150, MATIC20, P550		



			
1			
<b>Part No.</b>	506130	<b>Ref. No.</b>	0300006
<b>description</b>	thermowell thread 1/2" L 107mm SS single ø 6.5mm		
<b>For models:</b>	015-24L, 050F, 050F-Dep, F85, F85-Dep, L20, L21, S200, S280, S280Dep, Super-QS, Super-QS-Dep		

			
1			
<b>Part No.</b>	345565	<b>Ref. No.</b>	0301000
<b>description</b>	push switch mounting measurements 28.5x28.5mm green 2NO 250V 16A connection male faston 6.3mm ambient temperature max. 150°C protection IP40		
<b>For models:</b>	015-24L, 050F, 050F-Dep, DSP5, F85, L20, LP31L, LP6, LP6L, P550, S200, S280, S280Dep, Super-QS, Super-QS-Dep		

## switches and momentary switches

### push/momentary push switches

19x13mm

			
1			
<b>Part No.</b>	347167	<b>Ref. No.</b>	0301009 0301018
<b>description</b>	momentary push switch mounting measurements 19x13mm black 1NO 250V 16A non-illuminated connection male faston 4.8mm 1-pole		
<b>For models:</b>	DSP1, DSP2, DSP4		

			
1			
<b>Part No.</b>	345499	<b>Ref. No.</b>	0301004
<b>description</b>	push switch mounting measurements 28.5x28.5mm grey 1CO/1NO 250V 16A connection male faston 6.3mm ambient temperature max. 150°C protection IP40		
<b>For models:</b>	050F, 050F-Dep, F85, S280Dep, Super-QS-Dep		

### microswitches

#### lever actuated

			
1			
<b>Part No.</b>	359446 <sup>1</sup>	<b>Ref. No.</b>	0301003
<b>description</b>	push switch mounting measurements 19x13mm yellow 2NO 250V 16A illuminated connection male faston 6.3mm ambient temperature max. 125°C protection IP65 with cover cap		
<b>For models:</b>	DSP1, DSP2, DSP4		

			
1			
<b>Part No.</b>	346969	<b>Ref. No.</b>	0300141
<b>description</b>	microswitch with lever 250V 16A 1NO connection male faston 6.3mm L 59mm L1 29mm ambient temperature max. 120°C mounting distance 22mm actuating force: 50g lever length 50mm		

<sup>1</sup>illuminated

28.5x28.5mm

			
1			
<b>Part No.</b>	345498	<b>Ref. No.</b>	0301101
<b>description</b>	momentary push switch mounting measurements 28.5x28.5mm green 2NO 250V 16A connection male faston 6.3mm ambient temperature max. 150°C protection IP40		
<b>For models:</b>	S200		

### position switches

#### SIEMENS

#### 3SE0 series

#### switches (complete)

			
1			
<b>Part No.</b>	347236	<b>Ref. No.</b>	0300232
<b>description</b>	position switch with handle with a switch 1NO/1NC 230V		

			
1			
<b>Part No.</b>	345497	<b>Ref. No.</b>	0301005
<b>description</b>	push switch mounting measurements 28.5x28.5mm green 2CO 250V 16A connection male faston 6.3mm ambient temperature max. 150°C protection IP40		
<b>For models:</b>	015-24L, 050F, 050F-Dep, F85, L20, L21, S200, S280, S280Dep, Super-QS, Super-QS-Dep		

### system switches (ROLD)

			
1			
<b>Part No.</b>	345537	<b>Ref. No.</b>	0301051
<b>description</b>	element holder mounting measurements 20.6x16.4mm grey arched for push buttons 13x17mm		
<b>For models:</b>	015-24L, 050F, 050F-Dep, DSP5, F85-Dep, L20, L21		



			
1			
<b>Part No.</b>	346810	<b>Ref. No.</b>	0301068
<b>description</b>	push button size 17x13mm blue		
<b>For models:</b>	015-24L, 050F, 050F-Dep, DSP5, F85-Dep, L20, L21		

			
1			
<b>Part No.</b>	346809	<b>Ref. No.</b>	0301066
<b>description</b>	push button size 17x13mm green		
<b>For models:</b>	015-24L, 050F, 050F-Dep, DSP5, L20		

			
1			
<b>Part No.</b>	345539	<b>Ref. No.</b>	0301069
<b>description</b>	push button size 17x13mm grey		
<b>For models:</b>	050F, 050F-Dep, DSP5, F85-Dep		



			
1			
<b>Part No.</b>	346572	<b>Ref. No.</b>	0301067
<b>description</b>	push button size 17x13mm yellow		
<b>For models:</b>	F85-Dep		

## rotary switches



### LOVATO

			
1			
<b>Part No.</b>	347976 <sup>1</sup>	<b>Ref. No.</b>	0301020
<b>description</b>	rotary switch 2 0-1 sets of contacts 2 type GN209775U20 690V 20A shaft $\varnothing$ 6x6mm shaft L 15mm shaft square connection screw		

<sup>1</sup>incl. knob and dial plate

			
1			
<b>Part No.</b>	347429 <sup>1</sup>	<b>Ref. No.</b>	0301022
<b>description</b>	rotary switch 3 0-1-2 sets of contacts 3 type GN209773U20 690V 20A shaft $\varnothing$ 6x6mm shaft L 15mm shaft square connection screw		
<b>For models:</b>	M150, MATIC20		
<b>spare parts for</b>	347429		
	<b>Part No.</b>	112633	<b>Ref. No.</b> 0300352
	knob $\varnothing$ 33mm shaft $\varnothing$ 6x6mm grey		

<sup>1</sup>incl. knob

			
1			
<b>Part No.</b>	345799	<b>Ref. No.</b>	0300206 0301019 0301025
<b>description</b>	rotary switch 4 1-2-3-4 sets of contacts 7 type GN20 9779 U20 690V 20A shaft $\varnothing$ 6x6mm shaft L 13.5mm shaft square connection screw		
<b>For models:</b>	015-24L, F85-Dep, L21, LP31L, LP6, LP6L, P550		
<b>accessories for</b>	345799		
	<b>Part No.</b>	112633	<b>Ref. No.</b> 0300352
	knob $\varnothing$ 33mm shaft $\varnothing$ 6x6mm grey		



## accessories

### levers

			
1			
<b>Part No.</b>	347168	<b>Ref. No.</b>	0301084
<b>description</b>	lever 0-I lever length 118mm L 90mm W 90mm shaft 8x8mm mounting distance 68x68mm		
<b>For models:</b>	M150, MATIC20		

## magnetic switches

### 40x13mm

			
1			
<b>Part No.</b>	345504	<b>Ref. No.</b>	0300138 0300183
<b>description</b>	magnetic switch L 40mm W 13mm 1NO 250V 0.04A P max. 10W connection cable cable length 1000mm		
<b>For models:</b>	015-24L, 050F, 050F-Dep, DSP1, DSP2, DSP4, DSP5, F85, F85-Dep, L20, L21, P550, S200, S280, S280Dep, Super-QS, Super-QS-Dep		
<b>accessories for</b>	345504		
	<b>Part No.</b>	345399	<b>Ref. No.</b> 0800141 0800142
	magnet $\varnothing$ 3.3mm L 40mm H 8mm W 13mm hole distance 30mm M3		

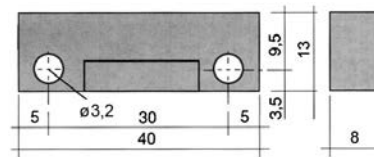





65x20mm

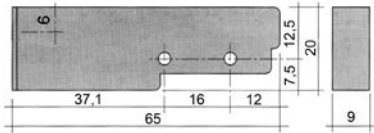

1



<b>Part No.</b>	345116	<b>Ref. No.</b>	0300082
<b>description</b>	magnetic switch L 65mm W 20mm 1NO 250V 0.4A P max. 100W connection cable cable length 3000mm		
<b>For models:</b>	LP31L, LP6, LP6L, M115, M150, MATIC20		
<b>accessories for</b>	345116		
	<b>Part No.</b>	345399	<b>Ref. No.</b> 0800141 0800142
	magnet $\varnothing$ 3.3mm L 40mm H 8mm W 13mm hole distance 30mm M3		

## accessories

## magnets



1

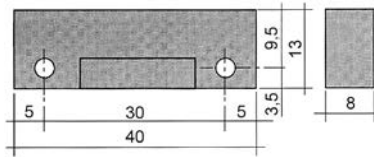

<b>Part No.</b>	345399	<b>Ref. No.</b>	0800141 0800142
<b>description</b>	magnet $\varnothing$ 3.3mm L 40mm H 8mm W 13mm hole distance 30mm M3		
<b>For models:</b>	015-24L, DSP5		



1

<b>Part No.</b>	347653	<b>Ref. No.</b>	0800139
<b>description</b>	magnet $\varnothing$ 8mm L 40mm		
<b>For models:</b>	M115, M150, MATIC20		

## magnetic holders



1

<b>Part No.</b>	347943	<b>Ref. No.</b>	0200623
<b>description</b>	magnet holder H 75mm thread M10x1.5 $\varnothing$ 17mm		
<b>For models:</b>	M115, M150, MATIC20		

## miscellaneous



1

<b>Part No.</b>	347938	<b>Ref. No.</b>	0406141
<b>description</b>	bracket L 86mm W 10mm H 12mm for magnetic switch SS		
<b>For models:</b>	015-24L, L20, L21		

## control equipment

## SIEMENS

3SB series  $\varnothing$ 22mm new

## switches (complete)





1

<b>Part No.</b>	347942	<b>Ref. No.</b>	0301010
<b>description</b>	momentary push switch mounting measurements $\varnothing$ 22mm blue 1NO non-illuminated		
<b>For models:</b>	LP31L, LP6, LP6L, M115, M150, MATIC20, P550		
<b>spare parts for</b>	347942		
	<b>Part No.</b>	346630	<b>Ref. No.</b> —
	contact block SIEMENS 3SB3400-0B 1NO max 400V 10A black		



1

<b>Part No.</b>	347944	<b>Ref. No.</b>	0301011
<b>description</b>	momentary push switch mounting measurements $\varnothing$ 22mm red 1NC/1NO OFF		
<b>For models:</b>	M115, M150, MATIC20		
<b>spare parts for</b>	347944		
	<b>Part No.</b>	346630	<b>Ref. No.</b> —
	contact block SIEMENS 3SB3400-0B 1NO max 400V 10A black		
	<b>Part No.</b>	346631	<b>Ref. No.</b> —
	contact block SIEMENS 3SB3400-0C 1NC max 400V 10A black		



miscellaneous



1

<b>Part No.</b>	347939	<b>Ref. No.</b>	0300397
<b>description</b>	contact block red L 74mm 1NC 1-pole ø 22mm type ECX1030		
<b>For models:</b>	M150, MATIC20		
<b>accessories for</b>	347939		
	<b>Part No.</b>	347940	<b>Ref. No.</b> 0301015
	emergency stop switch mounting measurements ø22mm red		



1

<b>Part No.</b>	347940	<b>Ref. No.</b>	0301015
<b>description</b>	emergency stop switch mounting measurements ø22mm red		
<b>For models:</b>	M115, M150, MATIC20		
<b>accessories for</b>	347940		
	<b>Part No.</b>	347939	<b>Ref. No.</b> 0300397
	contact block red L 74mm 1NC 1-pole ø 22mm type ECX1030		

lamps



1

<b>Part No.</b>	359807	<b>Ref. No.</b>	0300387
<b>description</b>	light bulb socket Ba9s 24V 2W ø 10mm L 28mm clear		
<b>For models:</b>	M150, MATIC20		

lamps

indicator lights

lamps

light bulbs



1

<b>Part No.</b>	359807	<b>Ref. No.</b>	0300387
<b>description</b>	light bulb socket Ba9s 24V 2W ø 10mm L 28mm clear		
<b>For models:</b>	M150, MATIC20		

indicator lights (complete)

ø 6mm



1

<b>Part No.</b>	359434	<b>Ref. No.</b>	0300284
<b>description</b>	indicator light ø 6mm 230V green		
<b>For models:</b>	015-24L, 050F, 050F-Dep, DSP5, F85, L20, L21, P550, S200, S280, S280Dep, Super-QS, Super-QS-Dep		

ø10mm

with screw socket



1

<b>Part No.</b>	357023	<b>Ref. No.</b>	0301901
<b>description</b>	indicator light ø 10mm 24V green cable length 200mm		
<b>For models:</b>	LP31L, LP6, M115		



1

<b>Part No.</b>	360578	<b>Ref. No.</b>	0301907
<b>description</b>	indicator light ø 10mm white 24V connection cable cable length 200mm		
<b>For models:</b>	LP31L, LP6		



1

<b>Part No.</b>	360579	<b>Ref. No.</b>	0301902
<b>description</b>	indicator light ø 10mm yellow 24V connection cable cable length 200mm		
<b>For models:</b>	LP31L, LP6, M115		

screw-on/push-on fit

light bulbs

for indicator lights



1

<b>Part No.</b>	359807	<b>Ref. No.</b>	0300387
<b>description</b>	light bulb socket Ba9s 24V 2W ø 10mm L 28mm clear		
<b>For models:</b>	M150, MATIC20		





## timers

## programme timers



1

<b>Part No.</b>	402949	<b>Ref. No.</b>	0300829 0301821
<b>description</b>	electronic timer 9.2.21.16G engines chambers operation time 230V shaft ømm shaft Lmm voltage 50/60		
<b>For models:</b>	DSP5		



1

<b>Part No.</b>	360403	<b>Ref. No.</b>	0300818
<b>description</b>	timer CDC 11803 engines 1 chambers 3 operation time 120s 230V shaft ømm shaft Lmm manif. no. 11803F1 / 0300818 motor type M48R ATS		
<b>spare parts for</b>	360403		
	<b>Part No.</b>	360118	<b>Ref. No.</b> 0300850
	motor CDC pinion ø 4.9mm teeth 10 230V voltage AC 50/60Hz turn direction right motor ø 47mm H 19.3mm motor type M48R ATS for timer cable length 260mm 1.9/2.5W		



1

<b>Part No.</b>	360411	<b>Ref. No.</b>	0300818
<b>description</b>	timer CDC 11803 engines 1 chambers 3 operation time 120s 230V shaft ømm shaft Lmm motor type M48R ATS		
<b>spare parts for</b>	360411		
	<b>Part No.</b>	360118	<b>Ref. No.</b> 0300850
	motor CDC pinion ø 4.9mm teeth 10 230V voltage AC 50/60Hz turn direction right motor ø 47mm H 19.3mm motor type M48R ATS for timer cable length 260mm 1.9/2.5W		



1

<b>Part No.</b>	360257	<b>Ref. No.</b>	0300117
<b>description</b>	timer CDC 4904F engines 1 chambers 4 operation time 6min 230V shaft ømm shaft Lmm manif. no. 4904F3 / 360257 motor type M48L ATS		
<b>For models:</b>	015-24L		
<b>spare parts for</b>	360257		
	<b>Part No.</b>	360083	<b>Ref. No.</b> —
	motor CDC pinion ø 4.9mm teeth 10 230V turn direction left motor ø 47mm H 19.3mm motor type M48L ATS for timer		



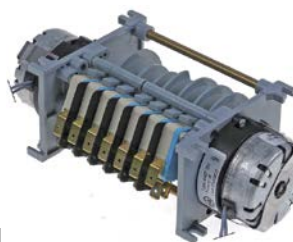

1

<b>Part No.</b>	360393	<b>Ref. No.</b>	0300803
<b>description</b>	timer CDC 4905 engines 1 chambers 5 operation time 12min 230V shaft ømm shaft Lmm		
<b>For models:</b>	L21, LP6L, P550		
<b>spare parts for</b>	360393		
	<b>Part No.</b>	360118	<b>Ref. No.</b> 0300850
	motor CDC pinion ø 4.9mm teeth 10 230V voltage AC 50/60Hz turn direction right motor ø 47mm H 19.3mm motor type M48R ATS for timer cable length 260mm 1.9/2.5W		





1

<b>Part No.</b>	360457	<b>Ref. No.</b>	0300822
<b>description</b>	timer CDC 4907DV engines 2 chambers 7 operation time 6s / 8min 24V		
<b>For models:</b>	LP31L, LP6		
<b>spare parts for</b>	360457		
	<b>Part No.</b>	360323	<b>Ref. No.</b> —
	motor CDC pinion ø 4.9mm teeth 10 24V voltage AC turn direction left motor ø 47mm H 19.3mm motor type M48L ATS for timer		

1

<b>Part No.</b>	360255	<b>Ref. No.</b>	0300101 0300806 0300807 0300812
<b>description</b>	timer CDC 7003F engines 1 chambers 3 operation time 6min 230V shaft ø 6x4.6mm shaft L 20mm manif. no. 7003F3 / 360255 motor type M37LN		
<b>For models:</b>	F85, L20		
<b>spare parts for</b>	360255		
	<b>Part No.</b>	360131	<b>Ref. No.</b> —
<b>accessories for</b>	360255		
	<b>Part No.</b>	110905	<b>Ref. No.</b> 0300049
	knob switch zero mark ø 42mm shaft ø 6x4.6mm shaft flat right black		



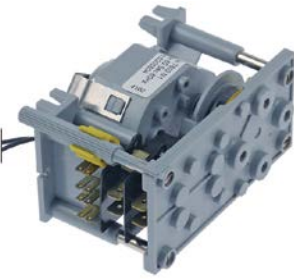

1

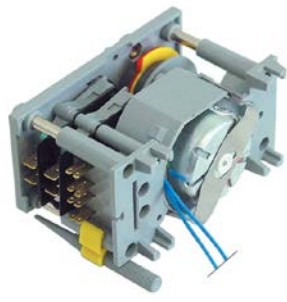
<b>Part No.</b>	360582	<b>Ref. No.</b>	0300804
<b>description</b>	timer CDC 7802 engines 1 chambers 2 operation time 60s 208V 60Hz shaft ømm shaft Lmm manif. no. 7802M1 / 0300804 motor type M37RS warewashing		





1

<b>Part No.</b>	360254	<b>Ref. No.</b>	0300085
<b>description</b>	timer CDC 7802 engines 1 chambers 2 operation time 60s 230V manif. no. 7802M1 / 0300085 motor type M37RN		
<b>For models:</b>	015-24L, 050F, 050F-Dep, F85, L20, L21, S200, S280, S280Dep, Super-QS, Super-QS-Dep		
<b>spare parts for</b>	360254		
	<b>Part No.</b>	360119	<b>Ref. No.</b> —
	motor CDC pinion ø 5.4mm teeth 12 230V turn direction right motor ø 37mm motor type M37RN for timer		





1

<b>Part No.</b>	360256	<b>Ref. No.</b>	0300143
<b>description</b>	timer CDC 7804F engines 1 chambers 4 operation time 120s 230V shaft ømm shaft Lmm manif. no. 7804F1 / 360256 motor type M37RN		
<b>For models:</b>	050F, 050F-Dep, S200, S280, S280Dep, Super-QS, Super-QS-Dep		
<b>spare parts for</b>	360256		
	<b>Part No.</b>	360119	<b>Ref. No.</b> —
	motor CDC pinion ø 5.4mm teeth 12 230V turn direction right motor ø 37mm motor type M37RN for timer		



1

<b>Part No.</b>	360253	<b>Ref. No.</b>	0300297
<b>description</b>	timer CDC 7804F engines 1 chambers 4 operation time 20min 230V manif. no. 7804F1 / 0300297 motor type M37RN		
<b>For models:</b>	050F, 050F-Dep, F85, S280Dep, Super-QS-Dep		
<b>spare parts for</b>	360253		
	<b>Part No.</b>	360119	<b>Ref. No.</b> —
	motor CDC pinion ø 5.4mm teeth 12 230V turn direction right motor ø 37mm motor type M37RN for timer		



1

<b>Part No.</b>	360580	<b>Ref. No.</b>	0300821
<b>description</b>	timer CDC 7805F engines 1 chambers 5 operation time 120s 230V shaft ømm shaft Lmm manif. no. 7805F1 motor type M37RN voltage AC		
<b>For models:</b>	050F, 050F-Dep		



1

<b>Part No.</b>	360581	<b>Ref. No.</b>	0300805
<b>description</b>	timer CDC 7805F engines 1 chambers 5 operation time 150s 208V shaft ømm shaft Lmm manif. no. 7805F1 motor type M37RS voltage AC		
<b>For models:</b>	S200, S280, S280Dep, Super-QS, Super-QS-Dep		



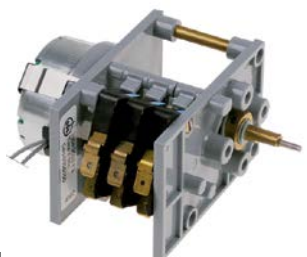

1

<b>Part No.</b>	360500	<b>Ref. No.</b>	0300801
<b>description</b>	timer CDC 7806M engines 1 chambers 6 operation time 150s 230V manif. no. 7806M1 motor type M37RN 5 chambers adjustable, 1 chamber fixed voltage AC		



1

<b>Part No.</b>	360402	<b>Ref. No.</b>	0300100
<b>description</b>	timer CDC 9003F engines 1 chambers 3 operation time 6min 230V shaft ø 6x4.6mm shaft L 22mm manif. no. 9003F3 / 0300100 motor type M48R ATS		
<b>spare parts for</b>	360402		
	<b>Part No.</b>	360118	<b>Ref. No.</b> 0300850
	motor CDC pinion ø 4.9mm teeth 10 230V voltage AC 50/60Hz turn direction right motor ø 47mm H 19.3mm motor type M48R ATS for timer cable length 260mm 1.9/2.5W		
<b>accessories for</b>	360402		
	<b>Part No.</b>	110197	<b>Ref. No.</b> —
	knob switch zero mark ø 42mm shaft ø 6x4.6mm shaft flat adjustable black		

## digital timers

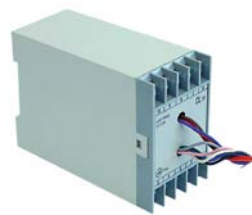

1

<b>Part No.</b>	400946	<b>Ref. No.</b>	0300810
<b>description</b>	timer electronic		

## spare parts and accessories

## motors

## CDC



1

<b>Part No.</b>	360118	<b>Ref. No.</b>	0300850
<b>description</b>	motor CDC pinion ø 4.9mm teeth 10 230V voltage AC 50/60Hz turn direction right motor ø 47mm H 19.3mm motor type M48R ATS for timer cable length 260mm 1.9/2.5W		

## contactors

## GENERAL ELECTRIC (AEG)

## power contactors



1

<b>Part No.</b>	380237	<b>Ref. No.</b>	0300392
<b>description</b>	power contactor resistive load 16A 230VAC (AC3/400V) 6A/3kW main contacts 3NO auxiliary contacts 1NC connection male faston 6.3mm type AEG LS0701F		
<b>For models:</b>	015-24L, L21, LP6L, P550		



1

<b>Part No.</b>	380236	<b>Ref. No.</b>	0300059
<b>description</b>	power contactor resistive load 16A 230VAC (AC3/400V) 6A/3kW main contacts 3NO auxiliary contacts 1NO connection male faston 6.3mm type AEG LS0710F		
<b>For models:</b>	DSP4, DSP5		

1

<b>Part No.</b>	380238	<b>Ref. No.</b>	0300058
<b>description</b>	power contactor resistive load 20A 230VAC (AC3/400V) 8.4A/4kW main contacts 3NO auxiliary contacts 1NO connection screw connection type LS0510A type AEG LS0510A type GE MC1A 310A		



1

<b>Part No.</b>	380244	<b>Ref. No.</b>	0300390
<b>description</b>	power contactor resistive load 25A 230VAC (AC3/400V) 9A/4kW main contacts 3NO auxiliary contacts 1NO connection screw connection type AEG LS4K 10A type GE CL00A 310		
<b>For models:</b>	P550		

TELEMECANIQUE (Schneider Electric)

power contactors



1

<b>Part No.</b>	380479	<b>Ref. No.</b>	0300050
<b>description</b>	power contactor resistive load 25A 230VAC (AC3/400V) 9A/4kW main contacts 3NO auxiliary contacts 1NO/1NC connection screw connection type LC1D09P7		
<b>For models:</b>	015-24L, LP6L, P550		

relays

power relays

with flange mounting



1

<b>Part No.</b>	380310	<b>Ref. No.</b>	0300063 0301745
<b>description</b>	power relays FINDER 230VAC 16A 2CO connection male faston 6.3mm screw mounting at 250VA manuf. no. 62.82.8.230.0000+062.10		
<b>For models:</b>	F85-Dep		

with bracket mounting



1

<b>Part No.</b>	380815	<b>Ref. No.</b>	0301794
<b>description</b>	power relays 230VAC 16A 2NO connection male faston 6.3mm flange dimensions 36x38x68mm		



1

<b>Part No.</b>	380139	<b>Ref. No.</b>	0301747
<b>description</b>	power relays FINDER 230VAC 16A 2CO connection F6.3 bracket mounting dimensions 68x38.2x35.8mm manuf. no. 62.82.8.230.0000		



1

<b>Part No.</b>	380808	<b>Ref. No.</b>	0301746
<b>description</b>	power relays FINDER 230VAC 16A 3CO connection male faston 6.3mm bracket mounting manuf. no. 62.83.8.230.0000		
<b>For models:</b>	050F, 050F-Dep, F85, F85-Dep, S280Dep, Super-QS-Dep		



1

<b>Part No.</b>	380702	<b>Ref. No.</b>	0301795
<b>description</b>	power relays FINDER 230VAC 16A 3NO connection male faston 6.3mm flange dimensions 36x38x68mm manif. no. 62.83.8.230.0300 230V		

## relay sockets



1

<b>Part No.</b>	380885	<b>Ref. No.</b>	0300121
<b>description</b>	relay socket 11-pole dimensions 47x47x20mm		

## time relays

### time relays



1

<b>Part No.</b>	401894	<b>Ref. No.</b>	0300823	
<b>description</b>	time relay 9.2.21.04G 230V 11-pole model NDWT 30/11			
<b>accessories for</b>	401894			
	<b>Part No.</b>	380885	<b>Ref. No.</b>	0300121
	relay socket 11-pole dimensions 47x47x20mm			

## electronic controllers

### EVCO - EVERY CONTROL

#### electronic thermometers

##### built-in version



1

<b>Part No.</b>	378346	<b>Ref. No.</b>	0500400
<b>description</b>	thermometer EVCO type EVK100P3 mounting measurements 71x29mm 12/24V voltage AC/DC -50 up to +150°C measuring input PTC display 3½ digits front measurements 75x33mm protection IP64 accuracy 1%		

## probes

### accessories

#### probe extension cables



1

<b>Part No.</b>	378309	<b>Ref. No.</b>	0305101
<b>description</b>	probe L 2500mm		

## electronics

### PCBs



1

<b>Part No.</b>	402338	<b>Ref. No.</b>	0306011
<b>description</b>	display PCB		



1

<b>Part No.</b>	403266	<b>Ref. No.</b>	0500406
<b>description</b>	thermometer dishwasher Linear 30/40/60 LS 350/500 L 10mm W 9mm temperature 24V		



## keypads

### front foils

			
1			
<b>Part No.</b>	506441	<b>Ref. No.</b>	0400041
<b>description</b>	front foil		

			
1			
<b>Part No.</b>	506152	<b>Ref. No.</b>	0500230
<b>description</b>	keypad foil dishwasher S200/240		
<b>For models:</b>	S200		

### membrane keypads





			
1			
<b>Part No.</b>	403279	<b>Ref. No.</b>	0502003 0502008
<b>description</b>	membrane keypad warewashing 045F buttons 3 Qty 1 pcs L 317mm W 40mm		















### control panel

			
1			
<b>Part No.</b>	506440	<b>Ref. No.</b>	0400192
<b>description</b>	control panel		

## solenoïd valves





### solenoïd valves (water)

			
1			
<b>Part No.</b>	370021	<b>Ref. No.</b>	0300056
<b>description</b>	solenoid valve double straight 230VAC inlet 3/4" outlet 11.5mm DN10 TP flow regulating valve inlet white		
<b>spare parts for</b>	370021		
	<b>Part No.</b>	371013	<b>Ref. No.</b>
	solenoid coil TP 230VAC 50/60Hz		
<b>accessories for</b>	370021		
	<b>Part No.</b>	371220	<b>Ref. No.</b>
	reducer TP flow rate 3l/min red tolerance ±15%		
	<b>Part No.</b>	371221	<b>Ref. No.</b>
	reducer TP flow rate 5.5l/min yellow tolerance ±15%		
	<b>Part No.</b>	371222	<b>Ref. No.</b>
	reducer TP flow rate 6l/min grey tolerance ±15%		

<b>accessories for</b>	370021		
	<b>Part No.</b>	371223	<b>Ref. No.</b>
	reducer TP flow rate 10l/min white tolerance ±15%		
	<b>Part No.</b>	371224	<b>Ref. No.</b>
	reducer TP flow rate 12l/min bronze tolerance ±15%		
	<b>Part No.</b>	371225	<b>Ref. No.</b>
	reducer TP flow rate 16l/min light brown tolerance ±15%		
	<b>Part No.</b>	371226	<b>Ref. No.</b>
	reducer TP flow rate 20l/min red tolerance ±15%		
	<b>Part No.</b>	371230	<b>Ref. No.</b>
	reducer TP flow rate 0.25l/min red tolerance ±25%		
	<b>Part No.</b>	371231	<b>Ref. No.</b>
	reducer TP flow rate 0.35l/min violet tolerance ±25%		
	<b>Part No.</b>	371232	<b>Ref. No.</b>
	reducer TP flow rate 0.5l/min orange tolerance ±25%		
	<b>Part No.</b>	371233	<b>Ref. No.</b>
	reducer TP flow rate 0.8l/min white tolerance ±25%		
	<b>Part No.</b>	371234	<b>Ref. No.</b>
	reducer TP flow rate 1l/min light blue tolerance ±25%		
	<b>Part No.</b>	371235	<b>Ref. No.</b>
	reducer TP flow rate 1.2l/min brown tolerance ±25%		
	<b>Part No.</b>	371236	<b>Ref. No.</b>
	reducer TP flow rate 1.5l/min light brown tolerance ±25%		
	<b>Part No.</b>	371237	<b>Ref. No.</b>
	reducer TP flow rate 2.5l/min yellow tolerance ±25%		
	<b>Part No.</b>	371238	<b>Ref. No.</b>
	reducer TP flow rate 3.4l/min dark green tolerance ±25%		
	<b>Part No.</b>	371239	<b>Ref. No.</b>
	reducer TP flow rate 5l/min black tolerance ±25%		
	<b>Part No.</b>	371240	<b>Ref. No.</b>
	reducer TP flow rate 8l/min blue tolerance ±20%		



			
			
<b>Part No.</b>	370017	<b>Ref. No.</b>	0300025
<b>description</b>	solenoid valve single straight 230VAC inlet 3/4" outlet 11.5mm DN10 TP p max 10bar		
<b>For models:</b>	015-24L, 050F, 050F-Dep, DSP1, DSP2, DSP4, DSP5, F85, F85-Dep, L20, L21, LP6L, P550, S200, S280, S280Dep, Super-QS, Super-QS-Dep		
<b>spare parts for</b>	370017		
	Part No.	371013	Ref. No. —
	solenoid coil TP 230VAC 50/60Hz		
<b>accessories for</b>	370017		
	Part No.	371220	Ref. No. —
	reducer TP flow rate 3l/min red tolerance ±15%		
	Part No.	371221	Ref. No. —
	reducer TP flow rate 5.5l/min yellow tolerance ±15%		
	Part No.	371222	Ref. No. —
	reducer TP flow rate 6l/min grey tolerance ±15%		
	Part No.	371223	Ref. No. —
	reducer TP flow rate 10l/min white tolerance ±15%		
	Part No.	371224	Ref. No. —
	reducer TP flow rate 12l/min bronze tolerance ±15%		
	Part No.	371225	Ref. No. —
	reducer TP flow rate 16l/min light brown tolerance ±15%		
	Part No.	371226	Ref. No. —
	reducer TP flow rate 20l/min red tolerance ±15%		
	Part No.	371230	Ref. No. —
	reducer TP flow rate 0.25l/min red tolerance ±25%		
	Part No.	371231	Ref. No. —
	reducer TP flow rate 0.35l/min violet tolerance ±25%		
	Part No.	371232	Ref. No. —
	reducer TP flow rate 0.5l/min orange tolerance ±25%		
	Part No.	371233	Ref. No. —
	reducer TP flow rate 0.8l/min white tolerance ±25%		
	Part No.	371234	Ref. No. —
	reducer TP flow rate 1l/min light blue tolerance ±25%		
	Part No.	371235	Ref. No. —
	reducer TP flow rate 1.2l/min brown tolerance ±25%		
	Part No.	371236	Ref. No. —
	reducer TP flow rate 1.5l/min light brown tolerance ±25%		



<b>accessories for</b>	370017		
	Part No.	371237	Ref. No. —
	reducer TP flow rate 2.5l/min yellow tolerance ±25%		
	Part No.	371238	Ref. No. —
	reducer TP flow rate 3.4l/min dark green tolerance ±25%		
	Part No.	371239	Ref. No. —
	reducer TP flow rate 5l/min black tolerance ±25%		
	Part No.	371240	Ref. No. —
	reducer TP flow rate 8l/min blue tolerance ±20%		

## solenoid valves with reducers

			
1			
<b>Part No.</b>	370242	<b>Ref. No.</b>	0300096
<b>description</b>	solenoid valve triple straight 230VAC inlet 3/4" outlet 11.5mm plastic		

## various

			
1			
<b>Part No.</b>	370241	<b>Ref. No.</b>	0301149
<b>description</b>	solenoid valve 2-fold, with reducer straight 230VAC suitable for Lamber		
<b>For models:</b>	050F, 050F-Dep, F85, F85-Dep, S280, S280Dep, Super-QS, Super-QSDep		

			
1			
<b>Part No.</b>	370636	<b>Ref. No.</b>	0301161
<b>description</b>	solenoid valve single CO 230VAC outlet 10.5mm MILANO 00168401 plastic 3-ways inlet 10.5mm 50/60Hz male faston 6.3mm		
<b>accessories for</b>	370636		
	Part No.	371142	Ref. No. —
	reducer for solenoid valve ø 8.2mm		



metal

BÜRKERT

solenoid valves (various)



1

<b>Part No.</b>	370741	<b>Ref. No.</b>	0301159
<b>description</b>	solenoid valve 2-ways 230VAC inlet 1/2" IT outlet 1/2" IT L 135mm BÜRKERT membranes EPDM p max 16bar p min 0.2bar 50/60Hz brass		



1

<b>Part No.</b>	370544	<b>Ref. No.</b>	0300173
<b>description</b>	solenoid valve 2-ways 24VAC inlet 1/2" outlet 1/2" L 65mm DN 13mm BÜRKERT membranes NBR 24V brass		
<b>For models:</b>	M115, M150, MATIC20		

SIRAI

2-way

L180-B series



1

<b>Part No.</b>	370391	<b>Ref. No.</b>	0300070
<b>description</b>	solenoid valve 2-ways 24VAC connection 3/4" L 79mm DN 18mm -10 up to +90°C coil type Z610A membranes NBR (water) p max 12bar p min 0.35bar		
<b>For models:</b>	LP31L, LP6		
<b>accessories for</b>	370391		



<b>Part No.</b>	371091	<b>Ref. No.</b>	—
power socket plug type DIN 43650B cable lengthmm small			

drain valves



1

<b>Part No.</b>	370543	<b>Ref. No.</b>	0300066
<b>description</b>	drain solenoid valve angled 230V single inlet 46mm outlet 1 1/2" duty cycle 60% SIRAI Z923G plastic		



1

<b>Part No.</b>	371109	<b>Ref. No.</b>	0301157
<b>description</b>	drain valve 230V 50/60Hz single inlet 50mm outlet 50mm		

pressure switches

for warewashing

ø 58mm with male faston 6.3mm

with connection horizontal



1

<b>Part No.</b>	541842	<b>Ref. No.</b>	0301503
<b>description</b>	pressure control pressure range 100/40mbar connection 6mm ø 58mm pressure connection horizontal warewashing pressure connection ø 5.5mm		
<b>For models:</b>	L20, L21		

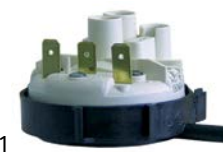

1

<b>Part No.</b>	541011	<b>Ref. No.</b>	0301501
<b>description</b>	pressure control pressure range 110/70mbar connection 6mm ø 58mm pressure connection horizontal warewashing		
<b>For models:</b>	015-24L, LP31L, LP6, LP6L, M115, M150, MATIC20, P550		





			
1			
<b>Part No.</b>	541165	<b>Ref. No.</b>	0300026 0301502
<b>description</b>	pressure control pressure range 60/30mbar connection 6mm ø 58mm pressure connection horizontal warewashing pressure connection ø 6mm		
<b>For models:</b>	015-24L, 050F, 050F-Dep, DSP1, DSP2, DSP4, DSP5, F85, F85-Dep, LP31L, LP6, LP6L, M115, M150, MATIC20, P550, S200, S280, S280Dep, Super-QS, Super-QS-Dep		

## pumps

## wash and rinse pumps

## ALBA (C&amp;A)

## pumps

			
1			
<b>Part No.</b>	500417	<b>Ref. No.</b>	0300252
<b>description</b>	pump inlet ø 28mm outlet ø 28mm type C904 230V 50Hz 1 phase 0.15kW 0.2HP L 200mm rotation direction right capacitor 6.3µF ALBA PUMPS (C&A)		
<b>For models:</b>	DSP1, DSP2, S200, S280, S280Dep, Super-QS, Super-QS-Dep		
<b>spare parts for</b>	500417		
	<b>Part No.</b>	365012	<b>Ref. No.</b> 0300110
	operating capacitor capacity 6.3µF 450V tolerance 5% 50Hz ambient temperature max. -25 to +85°C ø 30mm L 61mm M8 plastic connection male faston 6.3mm protection		
	<b>Part No.</b>	510693	<b>Ref. No.</b> 0200242 0200340 0209707
	mechanical shaft seal for shaft ø 12mm slide ring ext. ø 24mm slide ring H 15.5mm slide ring int. ø 11mm counter ring mounting ø 24mm height counter ring 8mm counter ring int. ø 13.5mm		
	<b>Part No.</b>	532490	<b>Ref. No.</b> —
	O-ring EPDM thickness 2.62mm ID ø 72.69mm Qty 1 pcs		

## EBARA

## pumps

			
1			
<b>Part No.</b>	499007	<b>Ref. No.</b>	0301249 0301254
<b>description</b>	pump inlet ø 63mm outlet ø 63mm type DW0150 230/400V 50Hz 3 phase 1.1kW 1.5HP L 360mm EBARA		
<b>For models:</b>	M115, M150		

			
1			
<b>Part No.</b>	500357	<b>Ref. No.</b>	0301254
<b>description</b>	pump inlet ø 63mm outlet ø 63mm type DW0150 230/400V 50Hz 3 phase 1.1kW 1.5HP L 360mm rotation direction left EBARA inlet ø 63mm outlet ø 63mm		
<b>For models:</b>	015-24L, P550		
<b>spare parts for</b>	500357		
	<b>Part No.</b>	503147	<b>Ref. No.</b> 0209906
	pump cover gasket thickness 3.53mm ID ø 148.8mm Qty 1 pcs		
	<b>Part No.</b>	503148	<b>Ref. No.</b> 0209709
	mechanical shaft seal for shaft ø 18mm height counter ring 12.5mm ID ø 18.5mm ED ø 32mm H 31mm mounting ø 33mm int. ø 19mm		
	<b>Part No.</b>	521270	<b>Ref. No.</b> 0209820
	impellor ø 88mm H 24mm with flute shaft intake ø 13mm rotation direction left blades 6 stainless steel		





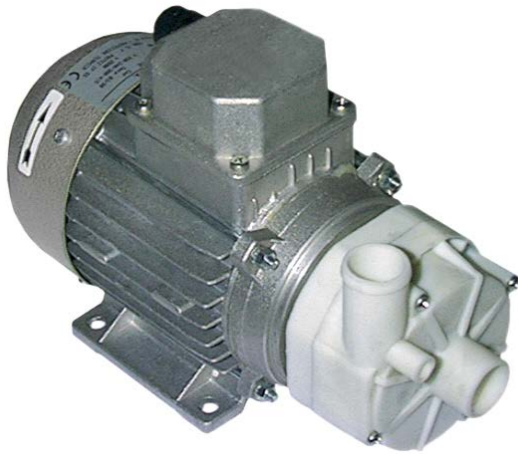

FIR

pumps



1

<b>Part No.</b>	500030	<b>Ref. No.</b>	0300205
<b>description</b>	pump inlet $\varnothing$ 28mm outlet $\varnothing$ 26mm type 4226.2540 230/400V 50Hz 3 phase 0.35kW 0.5HP L 260mm rotation direction right FIR		
<b>spare parts for</b>	500030		
	<b>Part No.</b>	510510	<b>Ref. No.</b> —
	pump cover pump type 2212/2228/2229/2211		
	<b>Part No.</b>	510690	<b>Ref. No.</b> —
	mechanical shaft seal for shaft $\varnothing$ 8mm ED $\varnothing$ 24mm mounting $\varnothing$ 24/26mm		
	<b>Part No.</b>	521202	<b>Ref. No.</b> —
	impellor $\varnothing$ 72mm H 17mm thread M5L		
	<b>Part No.</b>	521703	<b>Ref. No.</b> —
	pump cover gasket EPDM thickness 2.5mm ID $\varnothing$ 75mm Qty 1 pcs		







1

<b>Part No.</b>	500375	<b>Ref. No.</b>	0300245
<b>description</b>	pump inlet $\varnothing$ 45mm outlet $\varnothing$ 40mm type 3983.1411 230V 50Hz 1 phase 0.37kW 0.5HP L 200mm rotation direction right capacitor 12.5 $\mu$ F FIR		



1

<b>Part No.</b>	500323	<b>Ref. No.</b>	0300310
<b>description</b>	pump inlet $\varnothing$ 63mm outlet $\varnothing$ 47mm type 1227.2721 230/400V 50Hz 3 phase 2kW 2.7HP L 335mm rotation direction right FIR		
<b>spare parts for</b>	500323		
	<b>Part No.</b>	510599	<b>Ref. No.</b> —
	impellor $\varnothing$ 123mm H 34mm M8L		
	<b>Part No.</b>	510693	<b>Ref. No.</b> 0200242 0200340 0209707
	mechanical shaft seal for shaft $\varnothing$ 12mm slide ringext. $\varnothing$ 24mm slide ring H 15.5mm slide ring int. $\varnothing$ 11mm counter ring mounting $\varnothing$ 24mm height counter ring 8mm counter ring int. $\varnothing$ 13.5mm		
	<b>Part No.</b>	521513	<b>Ref. No.</b> —
	pump cover FIR inlet $\varnothing$ 63mm outlet $\varnothing$ 47mm turn direction right ID $\varnothing$ 150mm inner height 32mm		
	<b>Part No.</b>	524416	<b>Ref. No.</b> 0200290
	pump cover gasket thickness 4x4mm Qty 1 pcs		

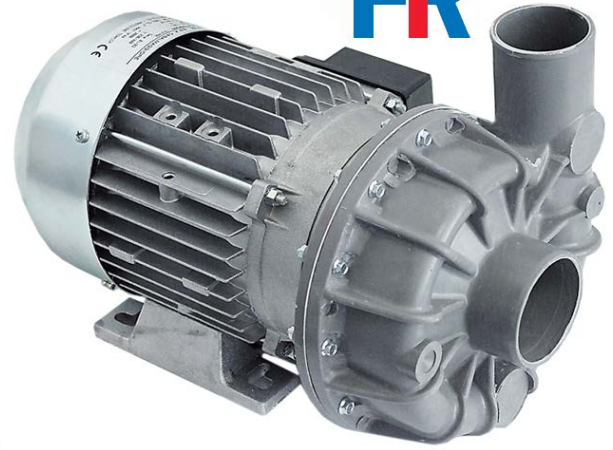

1





<b>Part No.</b>	500111	<b>Ref. No.</b>	0300021
<b>description</b>	pump inlet $\varnothing$ 63mm outlet $\varnothing$ 53mm type 1241.2500 230/400V 50Hz 3 phase 1.1kW 1.5HP L 330mm rotation direction left FIR		
<b>spare parts for</b>	500111		
	<b>Part No.</b>	510531	<b>Ref. No.</b> 0200593
	pump cover FIR inlet $\varnothing$ 63mm outlet $\varnothing$ 53mm auxiliary pressure connection M16x1.5mm supporting pressure open turn direction left $\varnothing$ 185mm ID $\varnothing$ 150mm inner height 37mm		

Table continues overleaf



<b>spare parts for</b> 500111			
	Part No.	510612	Ref. No. —
impellor ø 110mm H 34mm M8R			
	Part No.	510693	Ref. No. 0200242 0200340 0209707
mechanical shaft seal for shaft ø 12mm slide ring ext. ø 24mm slide ring H 15.5mm slide ring int. ø 11mm counter ring mounting ø 24mm height counter ring 8mm counter ring int. ø 13.5mm			
	Part No.	524416	Ref. No. 0200290
pump cover gasket thickness 4x4mm Qty 1 pcs			





1



<b>Part No.</b>	499293	<b>Ref. No.</b>	0301243
<b>description</b>	pump inlet ø 63mm outlet ø 53mm type 2241.2703 230/400V 50Hz 3 phase 0.89kW 1.2HP L 300mm rotation direction left FIR		

LGB



1

<b>Part No.</b>	500353	<b>Ref. No.</b>	0300372
<b>description</b>	pump inlet ø 28mm outlet ø 26mm type ZF115SX 230V 50Hz 1 phase 0.2kW 0.27HP L 190mm rotation direction right capacitor 5µF LGB		
<b>spare parts for</b> 500353			
	Part No.	365017	Ref. No. 0300105
operating capacitor capacity 5µF 450V tolerance 5% 50/60Hz ambient temperature max. -25 to +85°C ø 28mm L 54mm M8 plastic connection male faston 6.3mm 16.10.08 protection			
	Part No.	510122	Ref. No. 0200595
pump cover LGB inlet ø 28mm outlet ø 26mm auxiliary pressure connection 13mm supporting pressure open ø 98mm ID ø 77mm inner height 31mm			
	Part No.	510703	Ref. No. 0200397
mechanical shaft seal for shaft ø 13mm slide ring H 13mm height counter ring 5.5mm ED ø 26mm			

<b>spare parts for</b> 500353			
	Part No.	521223	Ref. No. 0209804
impellor ø 61mm H 17mm thread M7L shaft ø 13mm shaft length 12mm			
	Part No.	528800	Ref. No. 0209905
O-ring EPDM thickness 2.62mm ID ø 75.87mm Qty 1 pcs			









1

<b>Part No.</b>	500352	<b>Ref. No.</b>	0300373
<b>description</b>	pump inlet ø 28mm outlet ø 26mm type ZF130SX 230V 50Hz 1 phase 0.2kW 0.27HP L 195mm rotation direction right capacitor 6.3µF LGB		
<b>spare parts for</b> 500352			
	Part No.	365012	Ref. No. 0300110
operating capacitor capacity 6.3µF 450V tolerance 5% 50Hz ambient temperature max. -25 to +85°C ø 30mm L 61mm M8 plastic connection male faston 6.3mm protection			
	Part No.	510122	Ref. No. 0200595
pump cover LGB inlet ø 28mm outlet ø 26mm auxiliary pressure connection 13mm supporting pressure open ø 98mm ID ø 77mm inner height 31mm			
	Part No.	510703	Ref. No. 0200397
mechanical shaft seal for shaft ø 13mm slide ring H 13mm height counter ring 5.5mm ED ø 26mm			
	Part No.	521085	Ref. No. —
impellor ø 72mm H 17mm thread M7L shaft ø 13mm shaft length 12mm blades 3			
	Part No.	528800	Ref. No. 0209905
O-ring EPDM thickness 2.62mm ID ø 75.87mm Qty 1 pcs			



1

<b>Part No.</b>	500355	<b>Ref. No.</b>	0301203 0301204
<b>description</b>	pump inlet ø 45mm outlet ø 40mm type ZF320SX 230V 50Hz 1 phase 0.7kW 0.95HP L 200mm rotation direction right capacitor 12.5µF LGB		
<b>For models:</b>	050F, 050F-Dep, DSP4, DSP5, F85, F85-Dep, L20, L21		
<b>spare parts for</b>	500355		
	<b>Part No.</b>	365014	<b>Ref. No.</b> 0300081
	operating capacitor capacity 12.5µF 450V tolerance 5%Hz ambient temperature max. -25 to +85°C ø 35mm L 70mm M8 plastic connection male faston 6.3mm 45S.C3DS.12.5 protection		
	<b>Part No.</b>	510702	<b>Ref. No.</b> —
	mechanical shaft seal height counter ring 5.5mm ID ø 12mm		
	<b>Part No.</b>	512404	<b>Ref. No.</b> —
	bracket mounting distance 130mm		
	<b>Part No.</b>	521246	<b>Ref. No.</b> —
	impellor ø 103mm H 26mm thread M8L shaft ø 20mm shaft length 7mm seat ø 8.2mm blades 6		
	<b>Part No.</b>	521542	<b>Ref. No.</b> —
	pump cover LGB inlet ø 45mm outlet ø 40mm auxiliary pressure connection 13mm supporting pressure open ø 150mm ID ø 120mm inner height 25mm		
	<b>Part No.</b>	521714	<b>Ref. No.</b> —
	pump cover gasket thickness 4x4mm Qty 1 pcs		

booster pumps I



1

<b>Part No.</b>	500060	<b>Ref. No.</b>	0300361
<b>description</b>	pump inlet ø 1" outlet ø 1" type PQM60 230V 50Hz 1 phase 0.37kW PEDRELLO		
<b>For models:</b>	015-24L, L20, L21, LP6L, P550		
<b>accessories for</b>	500060		
	<b>Part No.</b>	365015	<b>Ref. No.</b> 0300106
	operating capacitor capacity 10µF 400V tolerance 5%Hz ambient temperature max. -25 to +85°C ø 35.5mm L 59mm M8 plastic connection male faston 6.3mm protection		



1



<b>Part No.</b>	499292	<b>Ref. No.</b>	0100631
<b>description</b>	pump inlet ø 1 1/4" IT outlet ø 1" IT type CDX/A 120/07 230-240V 50Hz 3 phase 0.55kW 0.75HP L 320mm rotation direction left EBARA		
<b>For models:</b>	LP6		

drain pumps

PLASET



1

<b>Part No.</b>	500354	<b>Ref. No.</b>	0300068
<b>description</b>	drain pump inlet ø 30mm outlet ø 22mm 230V 30W 50Hz PLASET type 64079		
<b>For models:</b>	015-24L, 050F, 050F-Dep, DSP5, F85, F85-Dep, L20, L21, S200, S280, S280Dep, Super-QS, Super-QS-Dep		
<b>accessories for</b>	500354		
	<b>Part No.</b>	506074	<b>Ref. No.</b> 0200521
	drain hose ID ø 32mm ED ø 41mm L 1m wire reinforced		
	<b>Part No.</b>	506207	<b>Ref. No.</b> 0900006
	drain hose DN19 L 1500mm straight ø inside 19mm straight ext. ø 24mm elbow ø inside 21mm elbow ext. ø 27mm outer hose ø 25mm		

booster pumps II

accessories



1

<b>Part No.</b>	365015	<b>Ref. No.</b>	0300106
<b>description</b>	operating capacitor capacity 10µF 400V tolerance 5%Hz ambient temperature max. -25 to +85°C ø 35.5mm L 59mm M8 plastic connection male faston 6.3mm protection		
<b>For models:</b>	F85		





1

<b>Part No.</b>	365017	<b>Ref. No.</b>	0300105
<b>description</b>	operating capacitor capacity 5µF 450V tolerance 5% 50/60Hz ambient temperature max. -25 to +85°C ø 28mm L 54mm M8 plastic connection male faston 6.3mm 16.10.08 protection		
<b>For models:</b>	S200, S280, S280Dep, Super-QS, Super-QS-Dep		



1

<b>Part No.</b>	365012	<b>Ref. No.</b>	0300110
<b>description</b>	operating capacitor capacity 6.3µF 450V tolerance 5% 50Hz ambient temperature max. -25 to +85°C ø 30mm L 61mm M8 plastic connection male faston 6.3mm protection		



1

<b>Part No.</b>	365017	<b>Ref. No.</b>	0300105
<b>description</b>	operating capacitor capacity 5µF 450V tolerance 5% 50/60Hz ambient temperature max. -25 to +85°C ø 28mm L 54mm M8 plastic connection male faston 6.3mm 16.10.08 protection		
<b>For models:</b>	S200, S280, S280Dep, Super-QS, Super-QS-Dep		



1

<b>Part No.</b>	365012	<b>Ref. No.</b>	0300110
<b>description</b>	operating capacitor capacity 6.3µF 450V tolerance 5% 50Hz ambient temperature max. -25 to +85°C ø 30mm L 61mm M8 plastic connection male faston 6.3mm protection		

## condensators & interference suppression filters

### operating capacitors

#### plastic



1

<b>Part No.</b>	365015	<b>Ref. No.</b>	0300106
<b>description</b>	operating capacitor capacity 10µF 400V tolerance 5%Hz ambient temperature max. -25 to +85°C ø 35.5mm L 59mm M8 plastic connection male faston 6.3mm protection		
<b>For models:</b>	F85		



1

<b>Part No.</b>	365014	<b>Ref. No.</b>	0300081
<b>description</b>	operating capacitor capacity 12.5µF 450V tolerance 5%Hz ambient temperature max. -25 to +85°C ø 35mm L 70mm M8 plastic connection male faston 6.3mm 45S.C3DS.12.5 protection		
<b>For models:</b>	050F, 050F-Dep, DSP4, DSP5, F85, F85-Dep, L20, L21		

### filters

#### interference suppression filters



1

<b>Part No.</b>	365046	<b>Ref. No.</b>	0300900
<b>description</b>	interference suppression filter type 10S7E-G1474253105-Q 115/250V 50/60Hz conductor 2 with E connection male faston 6.3mm L 40mm ø 40mm Hmm Wmm M8 plastic Qty 1 pcs		
<b>For models:</b>	015-24L, 050F, 050F-Dep, DSP1, DSP2, DSP4, DSP5, F85, F85-Dep, L20, L21, LP31L, LP6, LP6L, M115, M150, MATIC20, P550, S200, S280, S280Dep, Super-QS, Super-QS-Dep		

### fuses

#### line circuit breakers

#### miscellaneous

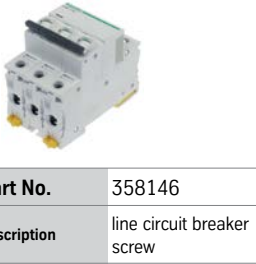

1

<b>Part No.</b>	358146	<b>Ref. No.</b>	0301723
<b>description</b>	line circuit breaker 3-pole 16A tripping type C rated 400V connection screw		
<b>For models:</b>	M150, MATIC20		



 <p>1</p>			
<b>Part No.</b>	358145	<b>Ref. No.</b>	0301729
<b>description</b>	line circuit breaker 3-pole 32A tripping type C rated 400V connection screw		
<b>For models:</b>	M115		

 <p>1</p>			
<b>Part No.</b>	358144	<b>Ref. No.</b>	0301730
<b>description</b>	shunt release rated 12-24V Qty 1 pcs		
<b>For models:</b>	M115, M150, MATIC20		

## electric accessories

### terminals

#### connection boxes

 <p>1</p>			
<b>Part No.</b>	550670	<b>Ref. No.</b>	0300750
<b>description</b>	power terminal block 3-pole contacts P+N+E		
<b>For models:</b>	DSP1, DSP2, S200, S280, S280Dep, Super-QS, Super-QS-Dep		

 <p>1</p>			
<b>Part No.</b>	550671	<b>Ref. No.</b>	0300751
<b>description</b>	power terminal block 6-pole contacts 3P+N+E		
<b>For models:</b>	050F, 050F-Dep, DSP4, DSP5, F85, F85-Dep, L20, L21		

#### rail-mounted terminals

#### SIEMENS



#### feed-through terminals

 <p>1</p>			
<b>Part No.</b>	551238	<b>Ref. No.</b>	0300405
<b>description</b>	rail-mounted terminal 16mm <sup>2</sup> beige 1-pole		
<b>For models:</b>	LP31L, LP6, M115		

## auxiliary gas parts

### screw connections

#### olives

 <p>1</p>			
<b>Part No.</b>	101273	<b>Ref. No.</b>	0200182
<b>description</b>	olive for pipe ø 12mm L 9.5mm brass Qty 1 pcs suitable for universal		
<b>For models:</b>	015-24L, DSP1, DSP2, DSP4, DSP5, L20, L21, LP31L, LP6, LP6L, S200, S280, S280Dep, Super-QS, Super-QS-Dep		
<b>accessories for</b>	101273		
			
<b>Part No.</b>	100944	<b>Ref. No.</b>	—
<b>description</b>	union nut thread M18x1.5 for pipe ø 12mm		
			
<b>Part No.</b>	101276	<b>Ref. No.</b>	—
<b>description</b>	union screw thread 3/8" tube ø 12mm Qty 1 pcs		

## equipment-specific units

### for dough mixers

#### chains

#### connectors

 <p>1</p>			
<b>Part No.</b>	693276	<b>Ref. No.</b>	0813444
<b>description</b>	connector single DIN/ISO 08 B-1 splitting 1/2" links 1 L 23mm internal width 11.8mm rollerø 4.3mm metal		
<b>For models:</b>	M115, M150, MATIC20		



## for espresso machines

## brewing units

## filter holder gaskets

## O-rings



1

<b>Part No.</b>	510409	<b>Ref. No.</b>	0200041
-----------------	--------	-----------------	---------

**description** O-ring EPDM thickness 5.34mm ID ø 56.52mm Qty 1 pcs

**For models:** 015-24L, 050F, 050F-Dep, DSP1, DSP2, DSP4, DSP5, F85, F85-Dep, L20, L21, LP31L, LP6, LP6L, M115, M150, MATIC20, P550, S200, S280, S280Dep, Super-QS, Super-QS-Dep

## steam/water taps

## steam/water pipes

## accessories

## gaskets



1

<b>Part No.</b>	510893	<b>Ref. No.</b>	0203012
-----------------	--------	-----------------	---------

**description** O-ring EPDM thickness 2.62mm ID ø 9.92mm Qty 1 pcs

## for dishwashers

## drain and intake components

## LAMBER

## drain /intake bodies



1

<b>Part No.</b>	517685	<b>Ref. No.</b>	0221333
-----------------	--------	-----------------	---------

**description** drain connection ø 40mm L 62mm thread 1½"



1

<b>Part No.</b>	506035	<b>Ref. No.</b>	0200128
-----------------	--------	-----------------	---------

**description** drain fitting thread 1¼" ID ø 27mm

**For models:** DSP1, DSP2, S200, S280, S280Dep, Super-QS, Super-QS-Dep



1

<b>Part No.</b>	506026	<b>Ref. No.</b>	0200113
-----------------	--------	-----------------	---------

**description** drain fitting thread 2"/1¼" ID ø 42mm

**For models:** 015-24L, 050F, 050F-Dep, DSP4, DSP5, F85, F85-Dep, L20, L21, P550

**accessories for** 506026



1

<b>Part No.</b>	506043	<b>Ref. No.</b>	0200173
-----------------	--------	-----------------	---------

**description** flat gasket rubber ED ø 75mm ID ø 58.5mm thickness 2mm Qty 1 pcs



1

<b>Part No.</b>	506017	<b>Ref. No.</b>	0200078
-----------------	--------	-----------------	---------

**description** drain fitting with gasket thread 1¼" ID ø 24mm hose ø 32mm

**For models:** 015-24L, 050F, 050F-Dep, F85, F85-Dep, L20, L21, P550, S200, S280, S280Dep, Super-QS, Super-QS-Dep

**spare parts for** 506017



1

<b>Part No.</b>	512073	<b>Ref. No.</b>	—
-----------------	--------	-----------------	---

**description** flat gasket rubber ED ø 31mm ID ø 22mm thickness 2mm Qty 1 pcs



1

<b>Part No.</b>	506028	<b>Ref. No.</b>	0200115
-----------------	--------	-----------------	---------

**description** flange ED ø 140mm



1

<b>Part No.</b>	506072	<b>Ref. No.</b>	0200403
-----------------	--------	-----------------	---------

**description** flat gasket fibre ED ø 38mm ID ø 27mm thickness 2mm outflow for thread 1¼" Qty 1 pcs

**For models:** 015-24L, 050F, 050F-Dep, DSP5, F85, F85-Dep, L20, L21, P550, S200, S280, S280Dep, Super-QS, Super-QS-Dep



1

<b>Part No.</b>	506121	<b>Ref. No.</b>	0201524 0208153
-----------------	--------	-----------------	--------------------

**description** flat gasket rubber ED ø 68mm ID ø 41mm thickness 2mm Qty 1 pcs

**For models:** DSP1, DSP2, L20, L21, S200, S280, S280Dep, Super-QS, Super-QS-Dep



1

<b>Part No.</b>	506043	<b>Ref. No.</b>	0200173
-----------------	--------	-----------------	---------

**description** flat gasket rubber ED ø 75mm ID ø 58.5mm thickness 2mm Qty 1 pcs

**For models:** 015-24L, 050F, 050F-Dep, DSP4, DSP5, F85, F85-Dep, L20, L21, P550





1

<b>Part No.</b>	504442	<b>Ref. No.</b>	0201532
-----------------	--------	-----------------	---------



**description** gasket for intake filter ED ø 140mm ID ø 84mm thickness 2mm hole distance 78mm







 <p>1</p>			
<b>Part No.</b>	506022	<b>Ref. No.</b>	0200098
<b>description</b>	gasket with 4 screw holes ED ø 134mm ID ø 65mm thickness 2.5mm		
<b>For models:</b>	DSP4, DSP5		

 <p>1</p>			
<b>Part No.</b>	506106	<b>Ref. No.</b>	0208153 old
<b>description</b>	gasket with 4 screw holes ED ø 68mm ID ø 41mm		

 <p>1</p>			
<b>Part No.</b>	506123	<b>Ref. No.</b>	0221305
<b>description</b>	hose connector		



 <p>1</p>			
<b>Part No.</b>	506122	<b>Ref. No.</b>	0221302
<b>description</b>	hose connector plastic straight thread 1¼" hose ø 31mm Qty 1 pcs		
<b>For models:</b>	015-24L, DSP5, L20, L21, P550		
<b>accessories for</b>	506122		
	<b>Part No.</b>	506072	<b>Ref. No.</b> 0200403
	flat gasket fibre ED ø 38mm ID ø 27mm thickness 2mm outflow for thread 1¼" Qty 1 pcs		
	<b>Part No.</b>	506074	<b>Ref. No.</b> 0200521
	drain hose ID ø 32mm ED ø 41mm L 1m wire reinforced		

 <p>1</p>			
<b>Part No.</b>	506129	<b>Ref. No.</b>	0221331
<b>description</b>	hose connector thread 1½" hose ø 40mm		
<b>For models:</b>	050F, 050F-Dep, F85, F85-Dep		
<b>accessories for</b>	506129		
	<b>Part No.</b>	506015	<b>Ref. No.</b> 0200056
	O-ring EPDM thickness 3.53mm ID ø 39.69mm Qty 1 pcs		
	<b>Part No.</b>	506016	<b>Ref. No.</b> 0200058
	quick-fit retaining nut thread 1½"		

 <p>1</p>			
<b>Part No.</b>	506096	<b>Ref. No.</b>	0201470
<b>description</b>	intake body		

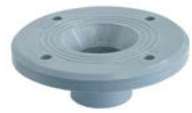
 <p>1</p>			
<b>Part No.</b>	506030	<b>Ref. No.</b>	0200118
<b>description</b>	intake body ED ø 110mm thread 1¼"		
<b>For models:</b>	DSP5, M115, M150, MATIC20		

 <p>1</p>			
<b>Part No.</b>	506029	<b>Ref. No.</b>	0200116
<b>description</b>	intake body ED ø 140mm		
<b>For models:</b>	DSP4, DSP5		

 <p>1</p>			
<b>Part No.</b>	506034	<b>Ref. No.</b>	0200127
<b>description</b>	intake body thread 1¼" ID ø 25mm		
<b>For models:</b>	DSP1, DSP2, L20, L21, S200, S280, S280Dep, Super-QS, Super-QS-Dep		
<b>accessories for</b>	506034		
	<b>Part No.</b>	506018	<b>Ref. No.</b> 0200080
	nut thread 1¼"		
	<b>Part No.</b>	506121	<b>Ref. No.</b> 0201524 0208153
	flat gasket rubber ED ø 68mm ID ø 41mm thickness 2mm Qty 1 pcs		

 <p>1</p>			
<b>Part No.</b>	506018	<b>Ref. No.</b>	0200080
<b>description</b>	nut thread 1¼"		
<b>For models:</b>	015-24L, 050F, 050F-Dep, DSP1, DSP2, DSP4, DSP5, F85, F85-Dep, L20, L21, P550, S200, S280, S280Dep, Super-QS, Super-QS-Dep		

 <p>1</p>			
<b>Part No.</b>	506027	<b>Ref. No.</b>	0200114
<b>description</b>	nut thread 2" for intake body		
<b>For models:</b>	015-24L, 050F, 050F-Dep, DSP4, DSP5, F85, F85-Dep, L20, L21, P550		







			
1			
<b>Part No.</b>	506015	<b>Ref. No.</b>	0200056
<b>description</b>	O-ring EPDM thickness 3.53mm ID ø 39.69mm Qty 1 pcs		
<b>For models:</b>	015-24L, 050F, 050F-Dep, DSP1, DSP2, DSP4, DSP5, F85, L20, L21, P550, S200, S280, S280Dep, Super-QS, Super-QS-Dep		

			
1			
<b>Part No.</b>	532547	<b>Ref. No.</b>	0203009
<b>description</b>	O-ring EPDM thickness 3.53mm ID ø 44.45mm Qty 1 pcs		
<b>For models:</b>	050F, 050F-Dep, F85, F85-Dep		

			
1			
<b>Part No.</b>	528315	<b>Ref. No.</b>	0800074
<b>description</b>	O-ring EPDM thickness 3.53mm ID ø 47.63mm Qty 1 pcs		

			
1			
<b>Part No.</b>	506016	<b>Ref. No.</b>	0200058
<b>description</b>	quick-fit retaining nut thread 1½"		
<b>For models:</b>	050F, 050F-Dep, F85, F85-Dep, LP31L, LP6, LP6L, M115, M150, MATIC20		

## filters

			
1			
<b>Part No.</b>	517675	<b>Ref. No.</b>	0202015
<b>description</b>	filter for dishwasher L 122mm W 122mm H 100mm SS		

			
1			
<b>Part No.</b>	517676	<b>Ref. No.</b>	0202000
<b>description</b>	filter for dishwasher L 200mm W 155mm H 120mm SS		

			
1			
<b>Part No.</b>	517674	<b>Ref. No.</b>	0202008
<b>description</b>	filter for dishwasher L 248mm W 248mm H 41mm SS		
<b>For models:</b>	M115, M150		

			
1			
<b>Part No.</b>	517673	<b>Ref. No.</b>	0202034
<b>description</b>	filter for dishwasher L 365mm W 292mm H 17mm SS		

			
1			
<b>Part No.</b>	517672	<b>Ref. No.</b>	0202063
<b>description</b>	filter for dishwasher L 415mm W 203mm H 37mm SS		

			
1			
<b>Part No.</b>	517681	<b>Ref. No.</b>	0202014
<b>description</b>	filter for dishwasher L 608mm W 180mm H 30mm SS		

			
1			
<b>Part No.</b>	517680	<b>Ref. No.</b>	0202013
<b>description</b>	filter for dishwasher L 660mm W 200mm H 62mm SS		
<b>For models:</b>	M150		

			
1			
<b>Part No.</b>	517684	<b>Ref. No.</b>	0200310
<b>description</b>	filter ø 22mm H 93mm SS		
<b>For models:</b>	LP31L, LP6, M115, M150, MATIC20		





			
1			
<b>Part No.</b>	506115	<b>Ref. No.</b>	0202006
<b>description</b>	flat filter		

			
1			
<b>Part No.</b>	506133	<b>Ref. No.</b>	0400151
<b>description</b>	flat filter		
<b>For models:</b>	050F, 050F-Dep, F85, F85-Dep		

			
1			
<b>Part No.</b>	506410	<b>Ref. No.</b>	0202005
<b>description</b>	flat filter L 270mm W 165mm		

			
1			
<b>Part No.</b>	506134	<b>Ref. No.</b>	0400152
<b>description</b>	flat filter L 320mm W 235mm		
<b>For models:</b>	015-24L, DSP5, L21, P550		

			
1			
<b>Part No.</b>	506135	<b>Ref. No.</b>	0400153
<b>description</b>	flat filter L 322mm W 216mm		

			
1			
<b>Part No.</b>	506143	<b>Ref. No.</b>	0400395
<b>description</b>	flat filter mounting pos. centre		
<b>For models:</b>	050F, 050F-Dep, F85, F85-Dep		

			
1			
<b>Part No.</b>	506144	<b>Ref. No.</b>	0400396
<b>description</b>	flat filter mounting pos. centre		

			
1			
<b>Part No.</b>	517683	<b>Ref. No.</b>	0202055
<b>description</b>	rectangular filter L 140mm W 60mm H 86mm plastic		

			
1			
<b>Part No.</b>	506056	<b>Ref. No.</b>	0200247
<b>description</b>	round filters ø 100mm		
<b>For models:</b>	DSP1, DSP2, S200, S280, S280Dep, Super-QS, Super-QS-Dep		

			
1			
<b>Part No.</b>	506422	<b>Ref. No.</b>	0202003
<b>description</b>	round filters ø 101mm connection ø48x55mm for pump suitable for L25/S		

			
1			
<b>Part No.</b>	517677	<b>Ref. No.</b>	0202065
<b>description</b>	round filters ø 145mm H 90mm overall height 130mm SS		



			
1			
<b>Part No.</b>	506009	<b>Ref. No.</b>	0200024
<b>description</b>	round filters $\varnothing$ 165mm H 50mm		
<b>For models:</b>	L20, L21		

			
1			
<b>Part No.</b>	506119	<b>Ref. No.</b>	0202209
<b>description</b>	round filters $\varnothing$ 185mm H 80mm		
<b>For models:</b>	015-24L, M115, M150, MATIC20, P550		

			
1			
<b>Part No.</b>	506010	<b>Ref. No.</b>	0200025
<b>description</b>	round filters $\varnothing$ 215mm		
<b>For models:</b>	050F, 050F-Dep, DSP4, DSP5, F85, F85-Dep		

## overflow pipes

			
1			
<b>Part No.</b>	517662	<b>Ref. No.</b>	0800903
<b>description</b>	cover $\varnothing$ 80mm ID $\varnothing$ 55mm H 25mm for overflow pipe		
<b>For models:</b>	LP31L, LP6, LP6L, M115, M150, MATIC20		

			
1			
<b>Part No.</b>	517663	<b>Ref. No.</b>	0500801
<b>description</b>	knob $\varnothing$ 35.5mm thread M8 H 23.5mm for overflow pipe		
<b>For models:</b>	LP31L, LP6, LP6L, M115, M150, MATIC20		

			
1			
<b>Part No.</b>	506007	<b>Ref. No.</b>	0200020
<b>description</b>	overflow pipe L 125mm $\varnothing$ 28mm		
<b>For models:</b>	DSP1, DSP2, S200, S280, S280Dep, Super-QS, Super-QS-Dep		

			
1			
<b>Part No.</b>	506047	<b>Ref. No.</b>	0200180
<b>description</b>	overflow pipe L 140mm $\varnothing$ 45mm		
<b>For models:</b>	050F, 050F-Dep, DSP4, DSP5, F85, F85-Dep		

			
1			
<b>Part No.</b>	524259	<b>Ref. No.</b>	0204007
<b>description</b>	overflow pipe L 180mm $\varnothing$ 28mm		

			
1			
<b>Part No.</b>	517668	<b>Ref. No.</b>	0200021
<b>description</b>	overflow pipe L 200mm $\varnothing$ 45mm		

			
1			
<b>Part No.</b>	506008	<b>Ref. No.</b>	0200022
<b>description</b>	overflow pipe L 226mm $\varnothing$ 45mm		
<b>For models:</b>	L20, L21		

			
1			
<b>Part No.</b>	506416	<b>Ref. No.</b>	0200023
<b>description</b>	overflow pipe L 320mm $\varnothing$ 45mm		



			
1			
<b>Part No.</b>	506120	<b>Ref. No.</b>	0204003
<b>description</b>	overflow pipe L 366mm ø 45mm usable height 340mm		
<b>For models:</b>	015-24L, P550		

			
1			
<b>Part No.</b>	524784	<b>Ref. No.</b>	0204006
<b>description</b>	overflow pipe L 405mm ø 45mm plastic ID ø 38mm		

			
1			
<b>Part No.</b>	517664	<b>Ref. No.</b>	0204004
<b>description</b>	overflow pipe L 430mm ø 45mm		

			
1			
<b>Part No.</b>	517661	<b>Ref. No.</b>	0204001 0204001+0200304+0500801
<b>description</b>	overflow pipe L 530mm ø 45mm		
<b>For models:</b>	M115, M150, MATIC20		
<b>accessories for</b>	517661		
	<b>Part No.</b>	516255	<b>Ref. No.</b> 0200304
	gasket silicone ED ø 45mm ID ø 35mm thickness 6mm Qty 1 pcs		
	<b>Part No.</b>	517662	<b>Ref. No.</b> 0800903
	cover ø 80mm ID ø 55mm H 25mm for overflow pipe		
	<b>Part No.</b>	517663	<b>Ref. No.</b> 0500801
	knob ø 35.5mm thread M8 H 23.5mm for overflow pipe		







			
1			
<b>Part No.</b>	517665	<b>Ref. No.</b>	0204002
<b>description</b>	overflow pipe L 575mm ø 45mm SS ID ø 33mm		
<b>For models:</b>	LP6, LP6L		

containers

dosing containers

			
1			
<b>Part No.</b>	506432	<b>Ref. No.</b>	0520003
<b>description</b>	rinse aid container 0.25l		

salt tanks

			
1			
<b>Part No.</b>	510929	<b>Ref. No.</b>	0200149
<b>description</b>	salt tank ø 120mm H 117mm hose ø 10mm mounting ø 70mm overall height 157mm		
<b>For models:</b>	050F, 050F-Dep, F85, F85-Dep, S280, S280Dep, Super-QS, Super-QSDep		
<b>spare parts for</b>	510929		
	<b>Part No.</b>	506015	<b>Ref. No.</b> 0200056
	O-ring EPDM thickness 3.53mm ID ø 39.69mm Qty 1 pcs		
	<b>Part No.</b>	510018	<b>Ref. No.</b> —
	nut ø 92mm H 10.5mm for salt tank ID ø 64mm		
	<b>Part No.</b>	524177	<b>Ref. No.</b> —
	lid ø 69mm H 20mm for salt tank ID ø 50mm		
<b>accessories for</b>	510929		
	<b>Part No.</b>	510071	<b>Ref. No.</b> —
	flat gasket rubber ED ø 81mm ID ø 68mm thickness 3mm for salt tank Qty 1 pcs		
	<b>Part No.</b>	510654	<b>Ref. No.</b> —
	gasket H 6mm D1 ø 82mm D2 ø 68mm		
	<b>Part No.</b>	510883	<b>Ref. No.</b> —
	gasket rubber ED ø 86mm ID ø 66mm thickness 2mm for salt tank Qty 1 pcs		



## boilers

## boilers for dishwashers



1

<b>Part No.</b>	506142	<b>Ref. No.</b>	0400268
<b>description</b>	boiler		
<b>For models:</b>	S200, S280, S280Dep, Super-QS, Super-QS-Dep		

1

<b>Part No.</b>	506145	<b>Ref. No.</b>	0403051
<b>description</b>	boiler		
<b>For models:</b>	015-24L		



1

<b>Part No.</b>	506136	<b>Ref. No.</b>	0400259 siehe Bemerkung
<b>description</b>	boiler capacity 3l		

1

<b>Part No.</b>	506141	<b>Ref. No.</b>	0400264
<b>description</b>	boiler capacity 4.5l		



1

<b>Part No.</b>	506137	<b>Ref. No.</b>	0400260 siehe Bemerkung
<b>description</b>	boiler capacity 4l		



1

<b>Part No.</b>	506139	<b>Ref. No.</b>	0400262
<b>description</b>	boiler capacity 5l		
<b>For models:</b>	050F, 050F-Dep, F85, F85-Dep		

1

<b>Part No.</b>	506138	<b>Ref. No.</b>	0400261 old
<b>description</b>	boiler capacity 8l		

1

<b>Part No.</b>	506140	<b>Ref. No.</b>	0400263
<b>description</b>	boiler capacity 8l		

1

<b>Part No.</b>	506262	<b>Ref. No.</b>	0400261
<b>description</b>	boiler capacity 8l		
<b>For models:</b>	015-24L, L20, L21, LP6, LP6L, P550		

1

<b>Part No.</b>	517679	<b>Ref. No.</b>	400266 400266+1x200324+6x300079+1x403012
<b>description</b>	boiler with insulation ø 220mm L 540mm		



rotation plates

rotation plates



1

<b>Part No.</b>	506442	<b>Ref. No.</b>	0800027
<b>description</b>	rotation plate for model A81		

softener cartridges

softening columns



1

<b>Part No.</b>	530000	<b>Ref. No.</b>	0200011
<b>description</b>	softener 4-fold L 380mm W 180mm		
<b>For models:</b>	050F, 050F-Dep, F85, F85-Dep, S280, S280Dep, Super-QS, Super-QSDep		



1

<b>Part No.</b>	530001	<b>Ref. No.</b>	200011
<b>description</b>	softener 4-fold L 380mm W 180mm		

housing and bezels

fastening angles



1

<b>Part No.</b>	504437	<b>Ref. No.</b>	0406127
<b>description</b>	fastening angle for valve SS L 85mm W 65mm thickness 1mm H 20mm		

fascias



1

<b>Part No.</b>	506440	<b>Ref. No.</b>	0400192
<b>description</b>	control panel		

hood mechanics for dishwashers

bolts



1

<b>Part No.</b>	506171	<b>Ref. No.</b>	0800117
<b>description</b>	screw bolt for grab handle hood mechanics		
<b>For models:</b>	015-24L, DSP5, L21		



1

<b>Part No.</b>	506206	<b>Ref. No.</b>	0899999
<b>description</b>	screw bolt for grab handle hood mechanics		
<b>For models:</b>	015-24L		

bushes





1

<b>Part No.</b>	506190	<b>Ref. No.</b>	0800497
<b>description</b>	bush for grab handle hood mechanics		
<b>For models:</b>	015-24L, DSP5, L21		



			
1			
<b>Part No.</b>	506188	<b>Ref. No.</b>	0800418
<b>description</b>	bush for roller hood mechanics		
<b>For models:</b>	015-24L, DSP5, L21		

			
1			
<b>Part No.</b>	506211	<b>Ref. No.</b>	0800108
<b>description</b>	bush hood mechanics		
<b>For models:</b>	015-24L, DSP5, L20, L21		

			
1			
<b>Part No.</b>	506212	<b>Ref. No.</b>	0800109
<b>description</b>	spacer bush hood mechanics		
<b>For models:</b>	015-24L, DSP5, L20, L21		



			
1			
<b>Part No.</b>	506213	<b>Ref. No.</b>	0800110
<b>description</b>	spacer bush hood mechanics		
<b>For models:</b>	015-24L, DSP5, L20, L21		

## guide bars

			
1			
<b>Part No.</b>	506436	<b>Ref. No.</b>	0800116
<b>description</b>	guide bar L 1115mm ø 31.5mm		
<b>For models:</b>	DSP5, L20, L21		

## linkage

			
1			
<b>Part No.</b>	506426	<b>Ref. No.</b>	0800701
<b>description</b>	linkage L 602mm hood mechanics for dishwasher		
<b>For models:</b>	DSP5		

			
1			
<b>Part No.</b>	506228	<b>Ref. No.</b>	0800702
<b>description</b>	linkage L 635mm hood mechanics for dishwasher		
<b>For models:</b>	015-24L		
<b>accessories for</b>	506228		
	<b>Part No.</b>	560475	<b>Ref. No.</b>
			0800144
	hexagonal nut thread M10 H 11.5mm zinc-coated steel WS 17 Qty 1 pcs DIN/ISO DIN 982		

## hood handles

			
1			
<b>Part No.</b>	506176	<b>Ref. No.</b>	0800241
<b>description</b>	hood handle		
<b>For models:</b>	DSP5, L20, L21		

			
1			
<b>Part No.</b>	506201	<b>Ref. No.</b>	0800750
<b>description</b>	hood handle		
<b>For models:</b>	015-24L		

			
1			
<b>Part No.</b>	506202	<b>Ref. No.</b>	0800751
<b>description</b>	hood handle		
<b>For models:</b>	015-24L		

## rollers

			
1			
<b>Part No.</b>	506163	<b>Ref. No.</b>	0800048
<b>description</b>	roller hood mechanics dimensions 23/9.4/8mm		
<b>For models:</b>	015-24L, DSP5, L20, L21, M115, M150, MATIC20		

			
1			
<b>Part No.</b>	506178	<b>Ref. No.</b>	0800244
<b>description</b>	roller hood mechanics dimensions 35x12mm PVC		
<b>For models:</b>	015-24L, DSP5, L21		



miscellaneous



1

<b>Part No.</b>	506023	<b>Ref. No.</b>	0200099
<b>description</b>	gasket hood mechanics thread M8		
<b>For models:</b>	015-24L, 050F, 050F-Dep, DSP4, DSP5, F85, F85-Dep, L20, L21, LP31L, LP6, LP6L, M115, M150, MATIC20, P550		



1

<b>Part No.</b>	506170	<b>Ref. No.</b>	0800115
<b>description</b>	hinge pin hood mechanics		
<b>For models:</b>	015-24L, DSP5, L20, L21		



1

<b>Part No.</b>	524791	<b>Ref. No.</b>	0200650
<b>description</b>	plate for hood mechanics L 39mm thread M10 zinc-coated steel H 10mm W 21mm		
<b>For models:</b>	015-24L, DSP5, L20, L21		



1

<b>Part No.</b>	506159	<b>Ref. No.</b>	0150007 0800020 GA0150007
<b>description</b>	rod guide hood mechanics with rollers		
<b>For models:</b>	015-24L, DSP5, L20, L21		



1

<b>Part No.</b>	506177	<b>Ref. No.</b>	0800242
<b>description</b>	spacer piece hood mechanics		
<b>For models:</b>	015-24L		



1

<b>Part No.</b>	506189	<b>Ref. No.</b>	0800420
<b>description</b>	spacer piece hood mechanics L 18mm thread M16		
<b>For models:</b>	015-24L, DSP5, L21		

basket guides

guide bars



1

<b>Part No.</b>	506439	<b>Ref. No.</b>	0400156
<b>description</b>	guide bar for warewashing basket mounting pos. left		
<b>For models:</b>	050F, 050F-Dep, F85, F85-Dep		



1

<b>Part No.</b>	506438	<b>Ref. No.</b>	0400157
<b>description</b>	guide bar for warewashing basket mounting pos. right		
<b>For models:</b>	050F, 050F-Dep, F85, F85-Dep		





## basket holders



<b>Part No.</b>	971148	<b>Ref. No.</b>	0400360 siehe Bemerkung
<b>description</b>	basket support for dishwasher L 580mm W 510mm H 75mm		
<b>For models:</b>	015-24L		
<b>accessories for</b>	971148		
	<b>Part No.</b>	971151	<b>Ref. No.</b> 0400370 0400370 (KIT)
mixer coupling L 450mm H 75mm			

## miscellaneous



<b>Part No.</b>	512078	<b>Ref. No.</b>	0800094
<b>description</b>	guide for dishwasher L 99mm W 45mm H 31.5mm		
<b>For models:</b>	M115, M150, MATIC20		







<b>Part No.</b>	971151	<b>Ref. No.</b>	0400370 0400370 (KIT)
<b>description</b>	mixer coupling L 450mm H 75mm		
<b>For models:</b>	015-24L, DSP5, L20, L21		

## air traps

## air traps



<b>Part No.</b>	506221	<b>Ref. No.</b>	0201455 0201455+0200196+0800652
<b>description</b>	air trap L 40mm W 40mm H 85mm thread M12x1.75 ABS plastic		
<b>For models:</b>	015-24L, 050F, 050F-Dep, DSP1, DSP5, F85, F85-Dep, L20, L21, LP31L, LP6, LP6L, M115, M150, MATIC20, P550, S200, S280, S280Dep, Super-QS, Super-QS-Dep		
<b>accessories for</b>	506221		
	<b>Part No.</b>	506063	<b>Ref. No.</b> 0200295
gasket suitable for Lamber equip. no. 0200295 air trap ED ø 15.5mm ID ø 11.5mm Nyltite			

<b>accessories for</b>	506221		
	<b>Part No.</b>	506076	<b>Ref. No.</b> 0200638
hose connector thread M12x1.75 hose ø 6mm			
	<b>Part No.</b>	506220	<b>Ref. No.</b> 0200196
gasket ø 4mm H 2.5mm nylon			
	<b>Part No.</b>	560227	<b>Ref. No.</b> 0800652
hexagonal nut thread M3 H 4mm SS WS 5.5 Qty 1 pcs self-locking			



<b>Part No.</b>	506414	<b>Ref. No.</b>	0200019
<b>description</b>	air trap ø 40mm H 100mm hose ø 10mm plastic		
<b>For models:</b>	DSP2, DSP4		

## air trap accessories



<b>Part No.</b>	506429	<b>Ref. No.</b>	0200289
<b>description</b>	gasket for air trap		
<b>For models:</b>	DSP2, DSP4		



<b>Part No.</b>	506220	<b>Ref. No.</b>	0200196
<b>description</b>	gasket ø 4mm H 2.5mm nylon		
<b>For models:</b>	015-24L, 050F, 050F-Dep, DSP1, DSP5, F85, F85-Dep, L20, L21, LP31L, LP6, LP6L, S200, S280, S280Dep, Super-QS, Super-QS-Dep		





<b>Part No.</b>	506431	<b>Ref. No.</b>	0200200
<b>description</b>	hose ED ø 10/15mm ID ø 4/10mm L 2200mm temp.-resist. 70°C for air trap		
<b>For models:</b>	015-24L, DSP2, DSP4, L20, L21, LP31L, LP6, LP6L		



<b>Part No.</b>	506040	<b>Ref. No.</b>	0200147
<b>description</b>	hose connector ø 4mm thread M12		
<b>For models:</b>	050F, 050F-Dep, DSP1, DSP5, F85, F85-Dep, S200, S280, S280Dep, Super-QS, Super-QS-Dep		





			
1			
<b>Part No.</b>	506076	<b>Ref. No.</b>	0200638
<b>description</b>	hose connector thread M12x1.75 hose ø 6mm		
<b>For models:</b>	M115, M150, MATIC20, P550		

			
1			
<b>Part No.</b>	694970	<b>Ref. No.</b>	0802707
<b>description</b>	gear wheel H 28mm ID ø 64mm ED ø 85mm hole ø 20mm		
<b>For models:</b>	M115, M150		

mechanics for flight type dishwashers

			
1			
<b>Part No.</b>	524826	<b>Ref. No.</b>	0802051
<b>description</b>	bush for ratchet L 21mm ID ø 8mm ED ø 10mm suitable for Lamber		
<b>For models:</b>	M115, M150, MATIC20		



			
1			
<b>Part No.</b>	524787	<b>Ref. No.</b>	0802046
<b>description</b>	thread bolt for drive shaft L 62mm ø 12mm suitable for Lamber thread M8x1.25		
<b>For models:</b>	M115, M150, MATIC20		

			
1			
<b>Part No.</b>	524789	<b>Ref. No.</b>	0800492
<b>description</b>	cable clamp wire gauge ø 5mm SS		
<b>For models:</b>	M115, M150, MATIC20		

backflow preventers

			
1			
<b>Part No.</b>	506210	<b>Ref. No.</b>	0500602
<b>description</b>	backflow preventer dishwasher		

			
1			
<b>Part No.</b>	504436	<b>Ref. No.</b>	0800407
<b>description</b>	coupling for transport system L 55mm ø 70mm ID ø 19mm suitable for Lamber		
<b>For models:</b>	M115, M150, MATIC20		

			
1			
<b>Part No.</b>	516101	<b>Ref. No.</b>	0500605
<b>description</b>	backflow preventer dishwasher hose ø 12mm		
<b>For models:</b>	015-24L, 050F, 050F-Dep, DSP5, F85, F85-Dep, L20, L21, LP31L, LP6, LP6L, M115, M150, P550, S200, S280, S280Dep, Super-QS, Super-QSDep		
<b>spare parts for</b>	516101		
	<b>Part No.</b>	506367	<b>Ref. No.</b> —
	flat gasket rubber ED ø 40mm ID ø 28mm thickness 1.8mm Qty 1 pcs		

			
1			
<b>Part No.</b>	524790	<b>Ref. No.</b>	0802048
<b>description</b>	distance washers for drive shaft H 10mm ID ø 12.4mm ED ø 22mm		
<b>For models:</b>	M115, M150, MATIC20		

			
1			
<b>Part No.</b>	529272	<b>Ref. No.</b>	0800123 0800150
<b>description</b>	drive shaft for transport system		
<b>For models:</b>	M115, M150, MATIC20		
<b>accessories for</b>	529272		
	<b>Part No.</b>	532144	<b>Ref. No.</b> —
	O-ring EPDM thickness 3.53mm ID ø 98.02mm Qty 10 pcs		
	<b>Part No.</b>	694970	<b>Ref. No.</b> 0802707
	gear wheel H 28mm ID ø 64mm ED ø 85mm hole ø 20mm		

non-return valves

			
1			
<b>Part No.</b>	506073	<b>Ref. No.</b>	0200426
<b>description</b>	non-return valve plastic total length 26mm hose ø 11mm		
<b>For models:</b>	050F, 050F-Dep, F85, F85-Dep, S280, S280Dep, Super-QS, Super-QSDep		



## miscellaneous



<b>Part No.</b>	506160	<b>Ref. No.</b>	0800028
<b>description</b>	plain washer ID $\varnothing$ 8.6mm ED $\varnothing$ 16mm thickness 1.5mm SS Qty 1 pcs		
<b>For models:</b>	015-24L, DSP5, L20, L21, LP31L, LP6, LP6L, M115, M150, MATIC20		

## door mechanics

## springs

## tension springs



<b>Part No.</b>	519494	<b>Ref. No.</b>	0800714
<b>description</b>	tension spring $\varnothing$ 9mm wire gauge $\varnothing$ 1.5mm total length 168mm for door		
<b>For models:</b>	050F, 050F-Dep, F85, F85-Dep		

## linkage



<b>Part No.</b>	506186	<b>Ref. No.</b>	0800408
<b>description</b>	door pin L 180mm door pin $\varnothing$ 5mm		
<b>For models:</b>	DSP1, DSP2, S200, S280, S280Dep, Super-QS, Super-QS-Dep		



<b>Part No.</b>	506179	<b>Ref. No.</b>	0800400
<b>description</b>	door pin L 305mm door pin $\varnothing$ 5mm		
<b>For models:</b>	050F, 050F-Dep, DSP2, DSP4, DSP5, F85, F85-Dep, LP31L, LP6, LP6L, M115, M150, P550, S280, S280Dep, Super-QS, Super-QS-Dep		

## threaded shafts



<b>Part No.</b>	506180	<b>Ref. No.</b>	0800401
<b>description</b>	threaded part spigot		
<b>For models:</b>	050F, 050F-Dep, DSP1, DSP2, DSP4, F85, F85-Dep, S200, S280, S280Dep, Super-QS, Super-QS-Dep		

## sliding plates



<b>Part No.</b>	506182	<b>Ref. No.</b>	0800403 0800403+2x0800187
<b>description</b>	sliding plate plate		
<b>For models:</b>	050F, 050F-Dep, DSP1, DSP2, DSP4, F85, F85-Dep, S200, S280, S280Dep, Super-QS, Super-QS-Dep		

## hinges



<b>Part No.</b>	506167	<b>Ref. No.</b>	0800098
<b>description</b>	door bolt door bearing		



<b>Part No.</b>	506168	<b>Ref. No.</b>	0800099
<b>description</b>	door bolt door bearing		
<b>For models:</b>	DSP1, DSP2, DSP4		



<b>Part No.</b>	692467	<b>Ref. No.</b>	0800174
<b>description</b>	hinge L 52mm W 57mm H 18mm mounting distance 34mm hole $\varnothing$ 5mm plastic		

## rod support



<b>Part No.</b>	506434	<b>Ref. No.</b>	0400190
<b>description</b>	support bracket		

## door bumpers





<b>Part No.</b>	506181	<b>Ref. No.</b>	0800402 0800402+0800256+0800653
<b>description</b>	door bumper hinge camp		
<b>For models:</b>	050F, 050F-Dep, DSP1, DSP2, DSP4, DSP5, F85, F85-Dep, P550, S200, S280, S280Dep, Super-QS, Super-QS-Dep		





<b>Part No.</b>	506185	<b>Ref. No.</b>	0800406
<b>description</b>	door bumper hinge camp brass		
<b>For models:</b>	LP31L, LP6, LP6L, M115, M150		





locks			
			
1			
<b>Part No.</b>	506157	<b>Ref. No.</b>	0800006
<b>description</b>	door catch catch		
<b>For models:</b>	050F, 050F-Dep, DSP1, DSP2, DSP4, F85, F85-Dep, S200, S280, S280Dep, Super-QS, Super-QS-Dep		

			
1			
<b>Part No.</b>	506183	<b>Ref. No.</b>	0800404 0800404+0800652+0800665
<b>description</b>	door catch counterpart		
<b>For models:</b>	050F, 050F-Dep, DSP1, DSP2, DSP4, F85, F85-Dep, S200, S280, S280Dep, Super-QS, Super-QS-Dep		

			
1			
<b>Part No.</b>	506184	<b>Ref. No.</b>	0800405
<b>description</b>	door catch SS door catch		

miscellaneous			
			
1			
<b>Part No.</b>	506173	<b>Ref. No.</b>	0800169
<b>description</b>	bush for door bolt		
<b>For models:</b>	DSP1, DSP2, DSP4		

			
1			
<b>Part No.</b>	506187	<b>Ref. No.</b>	0800409
<b>description</b>	bush for door bolt		

			
1			
<b>Part No.</b>	524254	<b>Ref. No.</b>	0800480
<b>description</b>	hauling cable for door ø 3mm L 1800mm		
<b>For models:</b>	M115, M150, MATIC20		

screw connections			
			
1			
<b>Part No.</b>	506196	<b>Ref. No.</b>	0800673
<b>description</b>	nut brass		
<b>For models:</b>	015-24L, 050F, 050F-Dep, DSP5, F85, F85-Dep, L20, L21, LP31L, LP6, LP6L, P550, S200, S280, S280Dep, Super-QS, Super-QS-Dep		

			
1			
<b>Part No.</b>	506027	<b>Ref. No.</b>	0200114
<b>description</b>	nut thread 2" for intake body		
<b>For models:</b>	015-24L, 050F, 050F-Dep, DSP4, DSP5, F85, F85-Dep, L20, L21, P550		

			
1			
<b>Part No.</b>	506132	<b>Ref. No.</b>	0300047
<b>description</b>	nut thread 3/8"		
<b>For models:</b>	050F, 050F-Dep, F85, F85-Dep, S200, S280, S280Dep, Super-QS, Super-QS-Dep		

washing and rinsing systems			
			
1			
<b>Part No.</b>	506012	<b>Ref. No.</b>	0200038
<b>description</b>	bearing rinse arm SS		
<b>For models:</b>	015-24L, 050F, 050F-Dep, DSP1, DSP2, DSP4, DSP5, F85, F85-Dep, L20, L21, P550, S200, S280, S280Dep, Super-QS, Super-QS-Dep		

			
1			
<b>Part No.</b>	506174	<b>Ref. No.</b>	0800175
<b>description</b>	bush for rinse arm mounting pos. lower		
<b>For models:</b>	LP31L, LP6, LP6L		



1

<b>Part No.</b>	506193	<b>Ref. No.</b>	0800500
<b>description</b>	bush for rinse arm mounting pos. lower		
<b>For models:</b>	LP31L, LP6, LP6L		



1

<b>Part No.</b>	506192	<b>Ref. No.</b>	0800499
<b>description</b>	bush for rinse arm $\varnothing$ 13.3mm		
<b>For models:</b>	015-24L, 050F, 050F-Dep, F85, F85-Dep, L20, L21, P550, S200, S280, S280Dep, Super-QS, Super-QS-Dep		



1

<b>Part No.</b>	506191	<b>Ref. No.</b>	0800498
<b>description</b>	bush for rinse arm $\varnothing$ 16.2mm		
<b>For models:</b>	015-24L, 050F, 050F-Dep, F85, F85-Dep, L20, L21, P550, S200, S280, S280Dep, Super-QS, Super-QS-Dep		



1

<b>Part No.</b>	517682	<b>Ref. No.</b>	0200121
<b>description</b>	bush for wash arm mounting pos. upper H 52mm thread 1 $\frac{1}{4}$ " D1 $\varnothing$ 54mm D2 $\varnothing$ 41mm Qty 1 pcs		



1

<b>Part No.</b>	506197	<b>Ref. No.</b>	0800685
<b>description</b>	disc for wash arm ID $\varnothing$ 18mm ED $\varnothing$ 50mm thickness 2mm nylon		



1

<b>Part No.</b>	506198	<b>Ref. No.</b>	0800686
<b>description</b>	disc for wash arm ID $\varnothing$ 50mm ED $\varnothing$ 22mm thickness 2mm nylon		
<b>For models:</b>	015-24L, 050F, 050F-Dep, F85, F85-Dep, L20, L21, P550		



1

<b>Part No.</b>	524264	<b>Ref. No.</b>	0800053
<b>description</b>	disc for wash arm support mounting pos. upper $\varnothing$ 50mm H 2mm		
<b>For models:</b>	DSP4, DSP5		



1

<b>Part No.</b>	506161	<b>Ref. No.</b>	0800030
<b>description</b>	disc SS for wash arm ID $\varnothing$ 18.2mm ED $\varnothing$ 50mm		



1

<b>Part No.</b>	506094	<b>Ref. No.</b>	0201458
<b>description</b>	flange thread 1 $\frac{1}{4}$ " $\varnothing$ 110mm		
<b>For models:</b>	015-24L, 050F, 050F-Dep, F85, F85-Dep, L20, L21, P550		



1

<b>Part No.</b>	524792	<b>Ref. No.</b>	0200259
<b>description</b>	gasket for rinse arm mounting pos. upper/lower $\varnothing$ 22.5mm ID $\varnothing$ 13mm thickness 10mm		
<b>For models:</b>	M115, M150, MATIC20		



1

<b>Part No.</b>	524786	<b>Ref. No.</b>	0200400
<b>description</b>	gasket for wash arm mounting pos. upper/lower $\varnothing$ 46mm ID $\varnothing$ 36mm		
<b>For models:</b>	M115, M150, MATIC20		

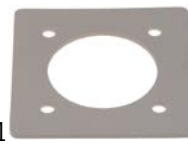

1

<b>Part No.</b>	524258	<b>Ref. No.</b>	0201504
<b>description</b>	gasket suitable for Lamber for wash arm support L 100mm W 100mm Qty 1m ID $\varnothing$ 61mm		
<b>For models:</b>	LP31L, LP6, LP6L		



1			
<b>Part No.</b>	504440	<b>Ref. No.</b>	0201505
<b>description</b>	gasket suitable for Lamber L 100mm W 100mm ID ø 43mm thickness 3mm		
<b>For models:</b>	M115, M150, MATIC20		

1			
<b>Part No.</b>	504441	<b>Ref. No.</b>	0201503
<b>description</b>	gasket suitable for Lamber L 100mm W 100mm Qty 1m ID ø 40mm thickness 3mm		
<b>For models:</b>	M115, M150, MATIC20		

1			
<b>Part No.</b>	506128	<b>Ref. No.</b>	0221315
<b>description</b>	hose connector curved plastic		

1			
<b>Part No.</b>	506127	<b>Ref. No.</b>	0221314
<b>description</b>	hose connector thread 1¼" for hose ID 30mm curved plastic		
<b>For models:</b>	DSP4, MATIC20		

1			
<b>Part No.</b>	506101	<b>Ref. No.</b>	0201820
<b>description</b>	rinse arm support mounting pos. lower		
<b>For models:</b>	050F, 050F-Dep, F85, F85-Dep		

1			
<b>Part No.</b>	506103	<b>Ref. No.</b>	0201830
<b>description</b>	rinse arm support mounting pos. lower		

1			
<b>Part No.</b>	506020	<b>Ref. No.</b>	0200096
<b>description</b>	rinse pipe		
<b>For models:</b>	DSP1, DSP2, DSP4, DSP5, S200, S280, S280Dep, Super-QS, Super-QSDep		

1			
<b>Part No.</b>	506091	<b>Ref. No.</b>	0201344
<b>description</b>	rinse pipe		

1			
<b>Part No.</b>	506104	<b>Ref. No.</b>	0201836
<b>description</b>	rinse pipe		
<b>For models:</b>	015-24L, L20, L21		

1			
<b>Part No.</b>	506437	<b>Ref. No.</b>	0201335
<b>description</b>	rinse pipe		

1			
<b>Part No.</b>	506200	<b>Ref. No.</b>	0800712
<b>description</b>	spring SS for rinse pipe		
<b>For models:</b>	015-24L, 050F, 050F-Dep, F85, F85-Dep, L20, L21, P550, S200, S280, S280Dep, Super-QS, Super-QS-Dep		

1			
<b>Part No.</b>	506172	<b>Ref. No.</b>	0800130
<b>description</b>	Thumb screw thread M6 thread L 9mm ø 22mm H 6mm SS		
<b>For models:</b>	015-24L, 050F, 050F-Dep, F85, F85-Dep, L20, L21, LP31L, LP6, LP6L, P550, S200, S280, S280Dep, Super-QS, Super-QS-Dep		



			
1			
<b>Part No.</b>	510338	<b>Ref. No.</b>	0200219
<b>description</b>	union nut dosing pump thread 1/2" ø 32mm H 15mm for dosing pump		

			
1			
<b>Part No.</b>	506102	<b>Ref. No.</b>	0201822
<b>description</b>	wash arm support mounting pos. lower		

			
1			
<b>Part No.</b>	506100	<b>Ref. No.</b>	0201811
<b>description</b>	wash pipe		

			
1			
<b>Part No.</b>	506421	<b>Ref. No.</b>	0800043
<b>description</b>	wash pipe L 200mm nylon size inch 1 1/4"		
<b>For models:</b>	M150		

			
1			
<b>Part No.</b>	506105	<b>Ref. No.</b>	0201841
<b>description</b>	wash pipe mounting pos. lower		

## washing and rinsing systems (sorted by producer)

## LAMBER

			
1			
<b>Part No.</b>	506267	<b>Ref. No.</b>	0200861
<b>description</b>	rinse arm L 372mm mounting pos. upper nozzles 4 mounting ø 16mm		

			
1			
<b>Part No.</b>	506064	<b>Ref. No.</b>	0200296
<b>description</b>	rinse arm L 375mm mounting pos. lower nozzles 4 mounting ø 17mm complete		
<b>For models:</b>	S280, S280Dep, Super-QS, Super-QS-Dep		

			
1			
<b>Part No.</b>	506265	<b>Ref. No.</b>	0200808 0200855
<b>description</b>	rinse arm L 376mm mounting pos. lower nozzles 4		
<b>For models:</b>	DSP2		

			
1			
<b>Part No.</b>	506261	<b>Ref. No.</b>	0200804 0200807 0200852
<b>description</b>	rinse arm L 420mm mounting pos. upper nozzles 4 thread M18x1		
<b>For models:</b>	015-24L, 050F, 050F-Dep, F85, F85-Dep, L20, L21, P550		

1

<b>Part No.</b>	517830	<b>Ref. No.</b>	0200850
<b>description</b>	rinse arm L 480mm mounting pos. lower nozzles 6		



1

<b>Part No.</b>	506276	<b>Ref. No.</b>	0200859
<b>description</b>	rinse arm L 620mm nozzles 6 mounting ø uppermm		



1

<b>Part No.</b>	517667	<b>Ref. No.</b>	0500515
<b>description</b>	wash arm L 380mm mounting pos. upper/lower nozzles 6		
<b>For models:</b>	M115, M150, MATIC20		



1

<b>Part No.</b>	506155	<b>Ref. No.</b>	0500502 0500505
<b>description</b>	wash arm L 383mm mounting pos. upper nozzles 6 mounting ø 43.5mm		
<b>For models:</b>	050F, 050F-Dep, DSP1, DSP2, DSP4, DSP5, F85, F85-Dep, L20, L21, S200, S280, S280Dep, Super-QS, Super-QS-Dep		



1

<b>Part No.</b>	506153	<b>Ref. No.</b>	0500500
<b>description</b>	wash arm L 545mm mounting pos. lower nozzles 6 mounting ø 43mm		
<b>For models:</b>	050F, 050F-Dep, DSP4, DSP5, F85, F85-Dep, L20, L21, P550		



1

<b>Part No.</b>	524783	<b>Ref. No.</b>	0500510
<b>description</b>	wash arm L 550/600mm mounting pos. upper/lower nozzles 8 complete		
<b>For models:</b>	LP31L, LP6, LP6L		



1

<b>Part No.</b>	524782	<b>Ref. No.</b>	0500516
<b>description</b>	wash arm L 550mm mounting pos. upper/lower nozzles 6 complete		





1

<b>Part No.</b>	506154	<b>Ref. No.</b>	0200094 0500501
<b>description</b>	wash arm L 550mm mounting pos. upper/lower nozzles 8 mounting ø 43mm		
<b>For models:</b>	015-24L		



1

<b>Part No.</b>	506061	<b>Ref. No.</b>	0200286 0200287
<b>description</b>	rinse arm L 470mm nozzles 6 mounting ø 17mm mounting pos. lower complete		
<b>For models:</b>	015-24L, 050F, 050F-Dep, F85, F85-Dep, L20, L21, P550		
<b>accessories for</b>	506061		
	<b>Part No.</b>	506012	<b>Ref. No.</b> 0200038
	bearing rinse arm SS		





1

<b>Part No.</b>	505045	<b>Ref. No.</b>	0200303
<b>description</b>	O-ring EPDM thickness 1.78mm ID ø 5.28mm Qty 1 pcs		
<b>For models:</b>	015-24L, 050F, 050F-Dep, F85, F85-Dep, L20, L21, LP31L, LP6, LP6L, M115, M150, MATIC20, P550, S200, S280, S280Dep, Super-QS, Super-QS-Dep		









			
1			
<b>Part No.</b>	506001	<b>Ref. No.</b>	0200012
<b>description</b>	rinse arm L 235mm nozzles 3 thread M12x1 mounting pos. lower		
<b>For models:</b>	015-24L, 050F, 050F-Dep, F85, F85-Dep, L20, L21, P550		

			
1			
<b>Part No.</b>	506002	<b>Ref. No.</b>	0200013
<b>description</b>	rinse arm L 235mm nozzles 3 thread M12x1 mounting pos. lower		
<b>For models:</b>	015-24L, 050F, 050F-Dep, F85, F85-Dep, L20, L21, P550		

			
1			
<b>Part No.</b>	506019	<b>Ref. No.</b>	0200086
<b>description</b>	rinse arm boss		
<b>For models:</b>	015-24L, 050F, 050F-Dep, DSP1, DSP2, DSP4, DSP5, F85, F85-Dep, L20, L21, P550, S200, S280, S280Dep, Super-QS, Super-QS-Dep		

			
1			
<b>Part No.</b>	506089	<b>Ref. No.</b>	0201164
<b>description</b>	rinse jet		
<b>For models:</b>	015-24L, 050F, 050F-Dep, F85, F85-Dep, L20, L21, P550, S200, S280, S280Dep, Super-QS, Super-QS-Dep		
<b>accessories for</b>	506089		
	<b>Part No.</b>	505045	<b>Ref. No.</b> 0200303
	O-ring EPDM thickness 1.78mm ID ø 5.28mm Qty 1 pcs		
	<b>Part No.</b>	524788	<b>Ref. No.</b> 0200625
	union nut for rinse jet mounting pos. upper/lower thread M12x1 H 10mm WS 14		

			
1			
<b>Part No.</b>	506090	<b>Ref. No.</b>	0201165
<b>description</b>	rinse jet ø 1.5mm approval NSF		
<b>For models:</b>	015-24L, 050F, 050F-Dep, F85, F85-Dep, L20, L21, P550, S200, S280, S280Dep, Super-QS, Super-QS-Dep		

			
1			
<b>Part No.</b>	506075	<b>Ref. No.</b>	0200608
<b>description</b>	union nut rinse jet		
<b>For models:</b>	015-24L, 050F, 050F-Dep, F85, F85-Dep, L20, L21, P550, S200, S280, S280Dep, Super-QS, Super-QS-Dep		

			
1			
<b>Part No.</b>	506079	<b>Ref. No.</b>	0200804
<b>description</b>	rinse arm L 420mm nozzles 4 mounting ø 16mm mounting pos. upper complete		

			
1			
<b>Part No.</b>	506062	<b>Ref. No.</b>	0200288
<b>description</b>	rinse arm L 422mm nozzles 4 mounting ø 17mm mounting pos. lower complete		

			
1			
<b>Part No.</b>	505045	<b>Ref. No.</b>	0200303
<b>description</b>	O-ring EPDM thickness 1.78mm ID ø 5.28mm Qty 1 pcs		
<b>For models:</b>	015-24L, 050F, 050F-Dep, F85, F85-Dep, L20, L21, LP31L, LP6, LP6L, M115, M150, MATIC20, P550, S200, S280, S280Dep, Super-QS, Super-QS-Dep		



			
1			
<b>Part No.</b>	506067	<b>Ref. No.</b>	0200370
<b>description</b>	rinse arm L 200mm nozzles 2 thread M12x1 mounting pos. upper		
<b>For models:</b>	015-24L, 050F, 050F-Dep, F85, F85-Dep, L20, L21, P550		

			
1			
<b>Part No.</b>	506068	<b>Ref. No.</b>	0200371
<b>description</b>	rinse arm L 200mm nozzles 2 thread M12x1 mounting pos. upper		
<b>For models:</b>	015-24L, 050F, 050F-Dep, F85, F85-Dep, L20, L21, P550		

			
1			
<b>Part No.</b>	506019	<b>Ref. No.</b>	0200086
<b>description</b>	rinse arm boss		
<b>For models:</b>	015-24L, 050F, 050F-Dep, DSP1, DSP2, DSP4, DSP5, F85, F85-Dep, L20, L21, P550, S200, S280, S280Dep, Super-QS, Super-QS-Dep		





 <p>1</p>			
<b>Part No.</b>	506088	<b>Ref. No.</b>	0201151
<b>description</b>	rinse arm boss		
<b>For models:</b>	015-24L, 050F, 050F-Dep, F85, F85-Dep, L20, L21, P550, S200, S280, S280Dep, Super-QS, Super-QS-Dep		

 <p>1</p>											
<b>Part No.</b>	506089	<b>Ref. No.</b>	0201164								
<b>description</b>	rinse jet										
<b>For models:</b>	015-24L, 050F, 050F-Dep, F85, F85-Dep, L20, L21, P550, S200, S280, S280Dep, Super-QS, Super-QS-Dep										
<b>accessories for</b>	506089										
	 <table border="1"> <tr> <td><b>Part No.</b></td> <td>505045</td> <td><b>Ref. No.</b></td> <td>0200303</td> </tr> <tr> <td><b>description</b></td> <td colspan="3">O-ring EPDM thickness 1.78mm ID ø 5.28mm Qty 1 pcs</td> </tr> </table>	<b>Part No.</b>	505045	<b>Ref. No.</b>	0200303	<b>description</b>	O-ring EPDM thickness 1.78mm ID ø 5.28mm Qty 1 pcs				
<b>Part No.</b>	505045	<b>Ref. No.</b>	0200303								
<b>description</b>	O-ring EPDM thickness 1.78mm ID ø 5.28mm Qty 1 pcs										
	 <table border="1"> <tr> <td><b>Part No.</b></td> <td>524788</td> <td><b>Ref. No.</b></td> <td>0200625</td> </tr> <tr> <td><b>description</b></td> <td colspan="3">union nut for rinse jet mounting pos. upper/lower thread M12x1 H 10mm WS 14</td> </tr> </table>	<b>Part No.</b>	524788	<b>Ref. No.</b>	0200625	<b>description</b>	union nut for rinse jet mounting pos. upper/lower thread M12x1 H 10mm WS 14				
<b>Part No.</b>	524788	<b>Ref. No.</b>	0200625								
<b>description</b>	union nut for rinse jet mounting pos. upper/lower thread M12x1 H 10mm WS 14										

 <p>1</p>			
<b>Part No.</b>	506090	<b>Ref. No.</b>	0201165
<b>description</b>	rinse jet ø 1.5mm approval NSF		
<b>For models:</b>	015-24L, 050F, 050F-Dep, F85, F85-Dep, L20, L21, P550, S200, S280, S280Dep, Super-QS, Super-QS-Dep		

 <p>1</p>			
<b>Part No.</b>	506075	<b>Ref. No.</b>	0200608
<b>description</b>	union nut rinse jet		
<b>For models:</b>	015-24L, 050F, 050F-Dep, F85, F85-Dep, L20, L21, P550, S200, S280, S280Dep, Super-QS, Super-QS-Dep		

 <p>1</p>			
<b>Part No.</b>	506215	<b>Ref. No.</b>	0200806
<b>description</b>	rinse arm L 322mm nozzles 4 mounting ø 16mm mounting pos. upper		
<b>For models:</b>	S200, S280, S280Dep, Super-QS, Super-QS-Dep		

 <p>1</p>			
<b>Part No.</b>	506077	<b>Ref. No.</b>	0200801
<b>description</b>	rinse arm L 325mm nozzles 4 mounting ø 17mm mounting pos. lower		
<b>For models:</b>	S200		

 <p>1</p>			
<b>Part No.</b>	505045	<b>Ref. No.</b>	0200303
<b>description</b>	O-ring EPDM thickness 1.78mm ID ø 5.28mm Qty 1 pcs		
<b>For models:</b>	015-24L, 050F, 050F-Dep, F85, F85-Dep, L20, L21, LP31L, LP6, LP6L, M115, M150, MATIC20, P550, S200, S280, S280Dep, Super-QS, Super-QS-Dep		

 <p>1</p>			
<b>Part No.</b>	506003	<b>Ref. No.</b>	0200016
<b>description</b>	rinse arm L 150mm nozzles 2 thread M12x1 mounting pos. upper/lower		
<b>For models:</b>	S200, S280, S280Dep, Super-QS, Super-QS-Dep		

 <p>1</p>			
<b>Part No.</b>	506004	<b>Ref. No.</b>	0200017
<b>description</b>	rinse arm L 150mm nozzles 2 thread M12x1 mounting pos. upper/lower		
<b>For models:</b>	S200, S280, S280Dep, Super-QS, Super-QS-Dep		

 <p>1</p>			
<b>Part No.</b>	506019	<b>Ref. No.</b>	0200086
<b>description</b>	rinse arm boss		
<b>For models:</b>	015-24L, 050F, 050F-Dep, DSP1, DSP2, DSP4, DSP5, F85, F85-Dep, L20, L21, P550, S200, S280, S280Dep, Super-QS, Super-QS-Dep		



1



<b>Part No.</b>	506088	<b>Ref. No.</b>	0201151
<b>description</b>	rinse arm boss		
<b>For models:</b>	015-24L, 050F, 050F-Dep, F85, F85-Dep, L20, L21, P550, S200, S280, S280Dep, Super-QS, Super-QS-Dep		

1



<b>Part No.</b>	506089	<b>Ref. No.</b>	0201164
<b>description</b>	rinse jet		
<b>For models:</b>	015-24L, 050F, 050F-Dep, F85, F85-Dep, L20, L21, P550, S200, S280, S280Dep, Super-QS, Super-QS-Dep		

<b>accessories for</b>	506089		
------------------------	--------	--	--



<b>Part No.</b>	505045	<b>Ref. No.</b>	0200303
<b>description</b>	O-ring EPDM thickness 1.78mm ID ø 5.28mm Qty 1 pcs		



<b>Part No.</b>	524788	<b>Ref. No.</b>	0200625
<b>description</b>	union nut for rinse jet mounting pos. upper/lower thread M12x1 H 10mm WS 14		

1



<b>Part No.</b>	506090	<b>Ref. No.</b>	0201165
<b>description</b>	rinse jet ø 1.5mm approval NSF		
<b>For models:</b>	015-24L, 050F, 050F-Dep, F85, F85-Dep, L20, L21, P550, S200, S280, S280Dep, Super-QS, Super-QS-Dep		

1



<b>Part No.</b>	506075	<b>Ref. No.</b>	0200608
<b>description</b>	union nut rinse jet		
<b>For models:</b>	015-24L, 050F, 050F-Dep, F85, F85-Dep, L20, L21, P550, S200, S280, S280Dep, Super-QS, Super-QS-Dep		

1



<b>Part No.</b>	506078	<b>Ref. No.</b>	0200802
<b>description</b>	rinse arm L 620mm nozzles 6 mounting ø 16mm mounting pos. lower complete		

1



<b>Part No.</b>	505045	<b>Ref. No.</b>	0200303
<b>description</b>	O-ring EPDM thickness 1.78mm ID ø 5.28mm Qty 1 pcs		
<b>For models:</b>	015-24L, 050F, 050F-Dep, F85, F85-Dep, L20, L21, LP31L, LP6, LP6L, M115, M150, MATIC20, P550, S200, S280, S280Dep, Super-QS, Super-QS-Dep		

1



<b>Part No.</b>	506069	<b>Ref. No.</b>	0200372
<b>description</b>	rinse arm L 295mm nozzles 3 thread M12x1 mounting pos. upper/lower		
<b>For models:</b>	LP31L, LP6, LP6L		

1



<b>Part No.</b>	506070	<b>Ref. No.</b>	0200373
<b>description</b>	rinse arm L 295mm nozzles 3 thread M12x1 mounting pos. upper/lower		
<b>For models:</b>	LP31L, LP6, LP6L		

1



<b>Part No.</b>	506087	<b>Ref. No.</b>	0201150
<b>description</b>	rinse arm boss		
<b>For models:</b>	LP31L, LP6, LP6L		

1



<b>Part No.</b>	517658	<b>Ref. No.</b>	0201172
<b>description</b>	rinse jet mounting pos. upper/lower ø 1.2mm H 19mm SS		
<b>For models:</b>	LP31L, LP6, LP6L, M115, M150, MATIC20		

1





<b>Part No.</b>	524788	<b>Ref. No.</b>	0200625
<b>description</b>	union nut for rinse jet mounting pos. upper/lower thread M12x1 H 10mm WS 14		
<b>For models:</b>	015-24L, 050F, 050F-Dep, F85, F85-Dep, L20, L21, LP31L, LP6, LP6L, M115, M150, MATIC20, S200, S280, S280Dep, Super-QS, Super-QS-Dep		





			
1			
<b>Part No.</b>	506080	<b>Ref. No.</b>	0200805
<b>description</b>	rinse arm L 472mm nozzles 6 mounting ø 16mm mounting pos. upper complete		

			
1			
<b>Part No.</b>	505045	<b>Ref. No.</b>	0200303
<b>description</b>	O-ring EPDM thickness 1.78mm ID ø 5.28mm Qty 1 pcs		
<b>For models:</b>	015-24L, 050F, 050F-Dep, F85, F85-Dep, L20, L21, LP31L, LP6, LP6L, M115, M150, MATIC20, P550, S200, S280, S280Dep, Super-QS, Super-QS-Dep		

			
1			
<b>Part No.</b>	506001	<b>Ref. No.</b>	0200012
<b>description</b>	rinse arm L 235mm nozzles 3 thread M12x1 mounting pos. lower		
<b>For models:</b>	015-24L, 050F, 050F-Dep, F85, F85-Dep, L20, L21, P550		

			
1			
<b>Part No.</b>	506002	<b>Ref. No.</b>	0200013
<b>description</b>	rinse arm L 235mm nozzles 3 thread M12x1 mounting pos. lower		
<b>For models:</b>	015-24L, 050F, 050F-Dep, F85, F85-Dep, L20, L21, P550		

			
1			
<b>Part No.</b>	506088	<b>Ref. No.</b>	0201151
<b>description</b>	rinse arm boss		
<b>For models:</b>	015-24L, 050F, 050F-Dep, F85, F85-Dep, L20, L21, P550, S200, S280, S280Dep, Super-QS, Super-QS-Dep		

			
1			
<b>Part No.</b>	517658	<b>Ref. No.</b>	0201172
<b>description</b>	rinse jet mounting pos. upper/lower ø 1.2mm H 19mm SS		
<b>For models:</b>	LP31L, LP6, LP6L, M115, M150, MATIC20		

			
1			
<b>Part No.</b>	524788	<b>Ref. No.</b>	0200625
<b>description</b>	union nut for rinse jet mounting pos. upper/lower thread M12x1 H 10mm WS 14		
<b>For models:</b>	015-24L, 050F, 050F-Dep, F85, F85-Dep, L20, L21, LP31L, LP6, LP6L, M115, M150, MATIC20, S200, S280, S280Dep, Super-QS, Super-QS-Dep		

			
1			
<b>Part No.</b>	517656	<b>Ref. No.</b>	0201844
<b>description</b>	rinse arm mounting pos. upper/lower L 500mm nozzles 4 stationary thread M12x1		
<b>For models:</b>	M115, M150		

			
1			
<b>Part No.</b>	524781	<b>Ref. No.</b>	0200376
<b>description</b>	rinse arm mounting pos. upper/lower L 590mm nozzles 5 stationary thread M12x1		

			
1			
<b>Part No.</b>	505045	<b>Ref. No.</b>	0200303
<b>description</b>	O-ring EPDM thickness 1.78mm ID ø 5.28mm Qty 1 pcs		
<b>For models:</b>	015-24L, 050F, 050F-Dep, F85, F85-Dep, L20, L21, LP31L, LP6, LP6L, M115, M150, MATIC20, P550, S200, S280, S280Dep, Super-QS, Super-QS-Dep		

			
1			
<b>Part No.</b>	517658	<b>Ref. No.</b>	0201172
<b>description</b>	rinse jet mounting pos. upper/lower ø 1.2mm H 19mm SS		
<b>For models:</b>	LP31L, LP6, LP6L, M115, M150, MATIC20		

			
1			
<b>Part No.</b>	506233	<b>Ref. No.</b>	0201171
<b>description</b>	rinse jet mounting pos. upper/lower ø 1.5mm H 20mm SS		
<b>For models:</b>	015-24L, 050F, 050F-Dep, F85, F85-Dep, L20, L21, MATIC20, S200, S280, S280Dep, Super-QS, Super-QS-Dep		





			
1			
<b>Part No.</b>	506234	<b>Ref. No.</b>	0201170
<b>description</b>	rinse jet mounting pos. upper/lower ø 1.8mm H 20mm SS		

			
1			
<b>Part No.</b>	524788	<b>Ref. No.</b>	0200625
<b>description</b>	union nut for rinse jet mounting pos. upper/lower thread M12x1 H 10mm WS 14		
<b>For models:</b>	015-24L, 050F, 050F-Dep, F85, F85-Dep, L20, L21, LP31L, LP6, LP6L, M115, M150, MATIC20, S200, S280, S280Dep, Super-QS, Super-QS-Dep		



			
1			
<b>Part No.</b>	506216	<b>Ref. No.</b>	0200803
<b>description</b>	rinse arm L 372mm nozzles 4 mounting ø 16mm mounting pos. upper		

			
1			
<b>Part No.</b>	505045	<b>Ref. No.</b>	0200303
<b>description</b>	O-ring EPDM thickness 1.78mm ID ø 5.28mm Qty 1 pcs		
<b>For models:</b>	015-24L, 050F, 050F-Dep, F85, F85-Dep, L20, L21, LP31L, LP6, LP6L, M115, M150, MATIC20, P550, S200, S280, S280Dep, Super-QS, Super-QS-Dep		

			
1			
<b>Part No.</b>	506005	<b>Ref. No.</b>	0200014
<b>description</b>	rinse arm L 175mm nozzles 2 thread M12x1 mounting pos. upper/lower		
<b>For models:</b>	S280, S280Dep, Super-QS, Super-QS-Dep		

			
1			
<b>Part No.</b>	506006	<b>Ref. No.</b>	0200015
<b>description</b>	rinse arm L 175mm nozzles 2 thread M12x1 mounting pos. upper/lower		
<b>For models:</b>	S280, S280Dep, Super-QS, Super-QS-Dep		

			
1			
<b>Part No.</b>	506088	<b>Ref. No.</b>	0201151
<b>description</b>	rinse arm boss		
<b>For models:</b>	015-24L, 050F, 050F-Dep, F85, F85-Dep, L20, L21, P550, S200, S280, S280Dep, Super-QS, Super-QS-Dep		

			
1			
<b>Part No.</b>	506089	<b>Ref. No.</b>	0201164
<b>description</b>	rinse jet		
<b>For models:</b>	015-24L, 050F, 050F-Dep, F85, F85-Dep, L20, L21, P550, S200, S280, S280Dep, Super-QS, Super-QS-Dep		
<b>accessories for</b>	506089		
	<b>Part No.</b>	<b>Ref. No.</b>	<b>0200303</b>
	 O-ring EPDM thickness 1.78mm ID ø 5.28mm Qty 1 pcs		
	<b>Part No.</b>	<b>Ref. No.</b>	<b>0200625</b>
	 union nut for rinse jet mounting pos. upper/lower thread M12x1 H 10mm WS 14		

			
1			
<b>Part No.</b>	506090	<b>Ref. No.</b>	0201165
<b>description</b>	rinse jet ø 1.5mm approval NSF		
<b>For models:</b>	015-24L, 050F, 050F-Dep, F85, F85-Dep, L20, L21, P550, S200, S280, S280Dep, Super-QS, Super-QS-Dep		

			
1			
<b>Part No.</b>	506075	<b>Ref. No.</b>	0200608
<b>description</b>	union nut rinse jet		
<b>For models:</b>	015-24L, 050F, 050F-Dep, F85, F85-Dep, L20, L21, P550, S200, S280, S280Dep, Super-QS, Super-QS-Dep		

			
1			
<b>Part No.</b>	517659	<b>Ref. No.</b>	0200814
<b>description</b>	rinse arm mounting pos. lower L 480mm nozzles 6 mounting ø 20mm		





			
1			
<b>Part No.</b>	517660	<b>Ref. No.</b>	0200815
<b>description</b>	rinse arm mounting pos. lower nozzles 5		
<b>For models:</b>	DSP4		

			
1			
<b>Part No.</b>	506019	<b>Ref. No.</b>	0200086
<b>description</b>	rinse arm boss		
<b>For models:</b>	015-24L, 050F, 050F-Dep, DSP1, DSP2, DSP4, DSP5, F85, F85-Dep, L20, L21, P550, S200, S280, S280Dep, Super-QS, Super-QS-Dep		

			
1			
<b>Part No.</b>	506049	<b>Ref. No.</b>	0200186
<b>description</b>	rinse jet thread 1/8" hole $\varnothing$ 0.9mm		
<b>For models:</b>	DSP1, DSP2, DSP4, DSP5		

			
1			
<b>Part No.</b>	506050	<b>Ref. No.</b>	0200187
<b>description</b>	rinse jet thread 1/8" hole $\varnothing$ 1.8mm		
<b>For models:</b>	DSP1, DSP2, DSP4, DSP5		

			
1			
<b>Part No.</b>	506048	<b>Ref. No.</b>	0200181
<b>description</b>	union nut thread 3/8" SS cone-shaped		
<b>For models:</b>	015-24L, DSP1, DSP2, DSP4, DSP5, L20, L21, P550, S200, S280, S280Dep, Super-QS, Super-QS-Dep		

			
1			
<b>Part No.</b>	517670	<b>Ref. No.</b>	0201174
<b>description</b>	wash jet for pre-rinsing mounting pos. upper/lower H 23mm $\varnothing$ 12mm		

			
1			
<b>Part No.</b>	506268	<b>Ref. No.</b>	0200853
<b>description</b>	rinse arm L 425mm nozzles 5 mounting $\varnothing$ 18mm		

miscellaneous

			
1			
<b>Part No.</b>	506066	<b>Ref. No.</b>	0200315
<b>description</b>	opposite support rinse jet		
<b>For models:</b>	DSP1, DSP2, DSP4, DSP5		
<b>accessories for</b>	506066		
	<b>Part No.</b>	<b>Ref. No.</b>	
	506417	0200089	
	swirl H 14mm $\varnothing$ 10mm 2mm H1 5mm		
	<b>Part No.</b>	<b>Ref. No.</b>	
	506418	0200088	
	rinse jet		
	<b>Part No.</b>	<b>Ref. No.</b>	
	506430	0200249	
	rinse jet holder		

			
1			
<b>Part No.</b>	506418	<b>Ref. No.</b>	0200088
<b>description</b>	rinse jet		
<b>For models:</b>	DSP1, DSP2, DSP4, DSP5		

			
1			
<b>Part No.</b>	506037	<b>Ref. No.</b>	0200132
<b>description</b>	rinse jet thread 1/8" brass		

			
1			
<b>Part No.</b>	506057	<b>Ref. No.</b>	0200250
<b>description</b>	rinse jet holder		







			
1			
<b>Part No.</b>	506430	<b>Ref. No.</b>	0200249
<b>description</b>	rinse jet holder		
<b>For models:</b>	DSP1, DSP2, DSP4, DSP5		
<b>spare parts for</b>	506430		
	<b>Part No.</b>	<b>Ref. No.</b>	
	510177	0200239	
	O-ring EPDM thickness 1.78mm ID $\varnothing$ 7.66mm Qty 1 pcs		

Table continues overleaf





accessories for	506430		
	Part No.	506066	Ref. No. 0200315
	opposite support rinse jet		
	Part No.	506417	Ref. No. 0200089
	swirl H 14mm ø 10mm 2mm H1 5mm		
	Part No.	506418	Ref. No. 0200088
	rinse jet		

1 	Part No.	506417	Ref. No.	0200089
	description swirl H 14mm ø 10mm 2mm H1 5mm			
	For models: DSP1, DSP2, DSP4, DSP5			

1 	Part No.	506099	Ref. No.	0201809
	description opposite support mounting pos. lower			

1 	Part No.	506033	Ref. No.	0200126
	description wash arm support mounting pos. lower			
	For models: 050F, 050F-Dep, F85, F85-Dep			

1 	Part No.	506427	Ref. No.	0201801
	description wash arm support mounting pos. lower			

1 	Part No.	524785	Ref. No.	0201452
	description wash arm support mounting pos. lower thread 1¼" D1 ø 59mm D2 ø 43mm D3 ø 37mm H 65mm ID ø 31.5mm			

1 	Part No.	506092	Ref. No.	0201451
	description wash arm support mounting pos. lower thread 1¼" ø 15.5mm nylon			
	For models: DSP1, DSP2, DSP4, S200, S280, S280Dep, Super-QS, Super-QS-Dep			

1 	Part No.	506219	Ref. No.	0200032
	description wash arm bearing 14 holes ø 54mm D2 ø 41mm H 52mm thread 1¼"			

1 	Part No.	506116	Ref. No.	0202101
	description wash arm bearing mounting pos. lower 2 holes hole ø 16mm seat ø 18mm ø 35.5mm D2 ø 41mm D3 ø 53.5mm H 51.5mm double thread 1¼"			
	For models: 015-24L, 050F, 050F-Dep, DSP5, F85, F85-Dep, L20, L21			

1 	Part No.	506117	Ref. No.	0202103
	description wash arm bearing mounting pos. lower 4 holes hole ø 16mm seat ø 18mm ø 35mm D2 ø 41mm D3 ø 54mm H 52mm 4-fold thread 1¼"			
	For models: 015-24L, DSP1, DSP2, DSP4, P550, S200, S280, S280Dep, Super-QS, Super-QS-Dep			

1 	Part No.	506118	Ref. No.	0202120
	description wash arm bearing mounting pos. upper 4 holes hole ø 16mm seat ø 22mm ø 35.5mm D2 ø 41mm D3 ø 54mm H 52mm thread 1¼"			
	For models: 015-24L, 050F, 050F-Dep, F85, F85-Dep, L20, L21, P550			

1 	Part No.	506227	Ref. No.	0202113
	description wash arm bearing mounting pos. upper ø 54mm D2 ø 41mm D3 ø 35.5mm H 51.5mm 4-fold thread M8			
	For models: DSP4, DSP5			



rinse arm shafts			
			
1			
<b>Part No.</b>	506084	<b>Ref. No.</b>	0201001
<b>description</b>	rinse arm shaft		

			
1			
<b>Part No.</b>	506086	<b>Ref. No.</b>	0201003
<b>description</b>	rinse arm shaft		
<b>For models:</b>	015-24L, 050F, 050F-Dep, F85, F85-Dep, L20, L21, P550, S200, S280, S280Dep, Super-QS, Super-QS-Dep		

			
1			
<b>Part No.</b>	506085	<b>Ref. No.</b>	0201002
<b>description</b>	rinse arm shaft for rinse arm mounting pos. upper		

gear wheels			
			
1			
<b>Part No.</b>	698414	<b>Ref. No.</b>	0802722
<b>description</b>	gear wheel splitting 1/2" teeth 22 shaft intake ø 45mm H 7mm		
<b>For models:</b>	M115, M150		

knobs			
producer-specific knobs			
LAMBER			
			
1			
<b>Part No.</b>	112633	<b>Ref. No.</b>	0300352
<b>description</b>	knob ø 33mm shaft ø 6x6mm grey		
<b>For models:</b>	F85-Dep		

			
1			
<b>Part No.</b>	110905	<b>Ref. No.</b>	0300049
<b>description</b>	knob switch zero mark ø 42mm shaft ø 6x4.6mm shaft flat right black		
<b>For models:</b>	F85, L20		

## handles and hand wheels

handle rails			
LAMBER			
			
1			
<b>Part No.</b>	508399	<b>Ref. No.</b>	0500017
<b>description</b>	handle rail L 310mm W 25mm H 30mm grey hole distance 180mm Qty 1 pcs		
<b>For models:</b>	DSP1, DSP2, DSP4		

handle rails			
			
1			
<b>Part No.</b>	508399	<b>Ref. No.</b>	0500017
<b>description</b>	handle rail L 310mm W 25mm H 30mm grey hole distance 180mm Qty 1 pcs		
<b>For models:</b>	DSP1, DSP2, DSP4		

bracket handles			
			
1			
<b>Part No.</b>	506147	<b>Ref. No.</b>	0500045 0500049
<b>description</b>	pull handle		
<b>For models:</b>	DSP5, LP31L, LP6, LP6L		





## hinges

## piano hinges

## producer-specific

## LAMBER

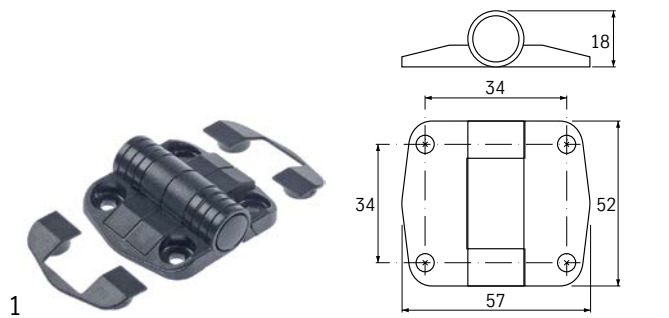

<b>Part No.</b>	692467	<b>Ref. No.</b>	0800174
<b>description</b>	hinge L 52mm W 57mm H 18mm mounting distance 34mm hole $\varnothing$ 5mm plastic		

## pullouts

## rollers

## rollers

## accessories

<b>Part No.</b>	560133	<b>Ref. No.</b>	0800063 0800656
<b>description</b>	hexagonal nut thread M6 H 5mm WS 10 SS DIN/ISO DIN 934 / ISO 4032/8673 Qty 20 pcs		
<b>For models:</b>	015-24L, 050F, 050F-Dep, F85, F85-Dep, L20, L21, LP31L, LP6, LP6L, M115, M150, MATIC20, P550, S200, S280, S280Dep, Super-QS, Super-QS-Dep		

## gaskets

## O-rings

## EPDM

<b>Part No.</b>	510302	<b>Ref. No.</b>	0200103
<b>description</b>	O-ring EPDM ID $\varnothing$ 12.42mm thickness 1.78mm Qty 1 pcs		
<b>For models:</b>	050F, 050F-Dep, F85, F85-Dep, S200, S280, S280Dep, Super-QS, Super-QS-Dep		

<b>Part No.</b>	505045	<b>Ref. No.</b>	0200303
<b>description</b>	O-ring EPDM thickness 1.78mm ID $\varnothing$ 5.28mm Qty 1 pcs		
<b>For models:</b>	015-24L, 050F, 050F-Dep, F85, F85-Dep, L20, L21, LP31L, LP6, LP6L, M115, M150, MATIC20, P550, S200, S280, S280Dep, Super-QS, Super-QS-Dep		

<b>Part No.</b>	510177	<b>Ref. No.</b>	0200239
<b>description</b>	O-ring EPDM thickness 1.78mm ID $\varnothing$ 7.66mm Qty 1 pcs		
<b>For models:</b>	DSP1, DSP2, DSP4, DSP5		

<b>Part No.</b>	532047	<b>Ref. No.</b>	0200211
<b>description</b>	O-ring EPDM thickness 2.62mm ID $\varnothing$ 7.59mm Qty 10 pcs		
<b>For models:</b>	015-24L, F85-Dep, L20, L21		

<b>Part No.</b>	528800	<b>Ref. No.</b>	0209905
<b>description</b>	O-ring EPDM thickness 2.62mm ID $\varnothing$ 75.87mm Qty 1 pcs		

<b>Part No.</b>	510893	<b>Ref. No.</b>	0203012
<b>description</b>	O-ring EPDM thickness 2.62mm ID $\varnothing$ 9.92mm Qty 1 pcs		

<b>Part No.</b>	506015	<b>Ref. No.</b>	0200056
<b>description</b>	O-ring EPDM thickness 3.53mm ID $\varnothing$ 39.69mm Qty 1 pcs		
<b>For models:</b>	015-24L, 050F, 050F-Dep, DSP1, DSP2, DSP4, DSP5, F85, L20, L21, P550, S200, S280, S280Dep, Super-QS, Super-QS-Dep		



<b>Part No.</b>	532547	<b>Ref. No.</b>	0203009
<b>description</b>	O-ring EPDM thickness 3.53mm ID $\varnothing$ 44.45mm Qty 1 pcs		
<b>For models:</b>	050F, 050F-Dep, F85, F85-Dep		

<b>Part No.</b>	510409	<b>Ref. No.</b>	0200041
<b>description</b>	O-ring EPDM thickness 5.34mm ID $\varnothing$ 56.52mm Qty 1 pcs		
<b>For models:</b>	015-24L, 050F, 050F-Dep, DSP1, DSP2, DSP4, DSP5, F85, F85-Dep, L20, L21, LP31L, LP6, LP6L, M115, M150, MATIC20, P550, S200, S280, S280Dep, Super-QS, Super-QS-Dep		

<b>Part No.</b>	528315	<b>Ref. No.</b>	0800074
<b>description</b>	O-ring EPDM thickness 3.53mm ID $\varnothing$ 47.63mm Qty 1 pcs		

<b>Part No.</b>	503147	<b>Ref. No.</b>	0209906
<b>description</b>	pump cover gasket thickness 3.53mm ID $\varnothing$ 148.8mm Qty 1 pcs		

<b>Part No.</b>	528793	<b>Ref. No.</b>	0203003
<b>description</b>	O-ring EPDM thickness 3.53mm ID $\varnothing$ 58.74mm Qty 1 pcs		

## sealing washers

### fibre gaskets

<b>Part No.</b>	890224	<b>Ref. No.</b>	0203004
<b>description</b>	O-ring EPDM thickness 3.53mm ID $\varnothing$ 98.02mm Qty 1 pcs		
<b>For models:</b>	M115, M150, MATIC20		

<b>Part No.</b>	506046	<b>Ref. No.</b>	0200178
<b>description</b>	flat gasket FIBER ED $\varnothing$ 19.5mm ID $\varnothing$ 13mm thickness 2mm Qty 1 pcs		
<b>For models:</b>	015-24L, 050F, 050F-Dep, DSP5, F85, F85-Dep, L20, L21, S200, S280, S280Dep, Super-QS, Super-QS-Dep		

<b>Part No.</b>	510811	<b>Ref. No.</b>	0200224
<b>description</b>	O-ring EPDM thickness 3mm ID $\varnothing$ 59.2mm Qty 1 pcs		

<b>Part No.</b>	506071	<b>Ref. No.</b>	0200402
<b>description</b>	flat gasket FIBER ED $\varnothing$ 25mm ID $\varnothing$ 18mm thickness 2mm Qty 1 pcs		
<b>For models:</b>	S200, S280, S280Dep, Super-QS, Super-QS-Dep		

<b>Part No.</b>	532577	<b>Ref. No.</b>	0203011
<b>description</b>	O-ring EPDM thickness 5.34mm ID $\varnothing$ 40.65mm Qty 1 pcs		
<b>For models:</b>	F85-Dep		

<b>Part No.</b>	506042	<b>Ref. No.</b>	0200171
<b>description</b>	flat gasket FIBER ED $\varnothing$ 27mm ID $\varnothing$ 17mm thickness 2mm Qty 1 pcs		
<b>For models:</b>	015-24L, DSP1, DSP2, DSP4, L20, L21, S200, S280, S280Dep, Super-QS, Super-QS-Dep		



1

<b>Part No.</b>	506025	<b>Ref. No.</b>	0200110
<b>description</b>	flat gasket FIBER ED ø 31mm ID ø 21mm thickness 2mm Qty 1 pcs		
<b>For models:</b>	015-24L, 050F, 050F-Dep, F85, F85-Dep, L20, L21, LP31L, LP6, LP6L, M115, M150, MATIC20, P550, S200, S280, S280Dep, Super-QS, Super-QS-Dep		



2

<b>Part No.</b>	506072	<b>Ref. No.</b>	0200403
<b>description</b>	flat gasket fibre ED ø 38mm ID ø 27mm thickness 2mm outflow for thread 1¼" Qty 1 pcs		
<b>For models:</b>	015-24L, 050F, 050F-Dep, DSP5, F85, F85-Dep, L20, L21, P550, S200, S280, S280Dep, Super-QS, Super-QS-Dep		

## rubber gaskets



1

<b>Part No.</b>	506051	<b>Ref. No.</b>	0200188
<b>description</b>	flat gasket rubber ED ø 25mm ID ø 16mm thickness 2mm Qty 1 pcs		
<b>For models:</b>	015-24L, 050F, 050F-Dep, DSP1, DSP2, DSP4, DSP5, F85, F85-Dep, L20, L21, LP6, LP6L, P550, S200, S280, S280Dep, Super-QS, Super-QS-Dep		



1

<b>Part No.</b>	516254	<b>Ref. No.</b>	0201500
<b>description</b>	flat gasket rubber ED ø 66mm ID ø 46mm thickness 2.1mm Qty 1 pcs		
<b>For models:</b>	LP31L, LP6, LP6L, M115, M150, MATIC20		



1

<b>Part No.</b>	506121	<b>Ref. No.</b>	0201524 0208153
<b>description</b>	flat gasket rubber ED ø 68mm ID ø 41mm thickness 2mm Qty 1 pcs		
<b>For models:</b>	DSP1, DSP2, L20, L21, S200, S280, S280Dep, Super-QS, Super-QS-Dep		



1

<b>Part No.</b>	506043	<b>Ref. No.</b>	0200173
<b>description</b>	flat gasket rubber ED ø 75mm ID ø 58.5mm thickness 2mm Qty 1 pcs		
<b>For models:</b>	015-24L, 050F, 050F-Dep, DSP4, DSP5, F85, F85-Dep, L20, L21, P550		

## PTFE gaskets



1

<b>Part No.</b>	506164	<b>Ref. No.</b>	0200222 0800052
<b>description</b>	flat gasket PTFE ED ø 57mm ID ø 41mm thickness 2mm Qty 1 pcs		
<b>For models:</b>	015-24L, 050F, 050F-Dep, DSP1, DSP2, DSP4, DSP5, F85, F85-Dep, L20, L21, P550, S200, S280, S280Dep, Super-QS, Super-QS-Dep		



1

<b>Part No.</b>	506058	<b>Ref. No.</b>	0200268
<b>description</b>	gasket PTFE ED ø 15mm ID ø 12.2mm thickness 9mm beveled size 3/8" Qty 1 pcs		
<b>For models:</b>	015-24L, 050F, 050F-Dep, DSP1, DSP2, DSP4, DSP5, F85, F85-Dep, L20, L21, LP31L, LP6, LP6L, P550, S200, S280, S280Dep, Super-QS, Super-QS-Dep		

## silicone gaskets



1

<b>Part No.</b>	516255	<b>Ref. No.</b>	0200304
<b>description</b>	gasket silicone ED ø 45mm ID ø 35mm thickness 6mm Qty 1 pcs		
<b>For models:</b>	LP31L, LP6, LP6L, M115, M150, MATIC20		

## shaft gaskets

## shaft gaskets



1

<b>Part No.</b>	697121	<b>Ref. No.</b>	0800080
<b>description</b>	shaft seal ID ø 17mm ED ø 40mm thickness 7mm		
<b>For models:</b>	M115, M150, MATIC20		



1

<b>Part No.</b>	698001	<b>Ref. No.</b>	0800078
<b>description</b>	shaft seal ID ø 20mm ED ø 35mm thickness 7mm		
<b>For models:</b>	M115, M150, MATIC20		





1

<b>Part No.</b>	698413	<b>Ref. No.</b>	0209780
<b>description</b>	shaft sealing ID ø 18mm ED ø 40mm thickness 7mm		

## special gaskets

### miscellaneous



1

<b>Part No.</b>	506044	<b>Ref. No.</b>	0200175
<b>description</b>	gasket		
<b>For models:</b>	DSP1, DSP2, DSP4		



1

<b>Part No.</b>	506039	<b>Ref. No.</b>	0200145
<b>description</b>	gasket ED ø 7mm ID ø 5mm thickness 3mm		
<b>For models:</b>	DSP1, DSP2, DSP4		



1

<b>Part No.</b>	506429	<b>Ref. No.</b>	0200289
<b>description</b>	gasket for air trap		
<b>For models:</b>	DSP2, DSP4		



1

<b>Part No.</b>	504442	<b>Ref. No.</b>	0201532
<b>description</b>	gasket for intake filter ED ø 140mm ID ø 84mm thickness 2mm hole distance 78mm		



1

<b>Part No.</b>	524792	<b>Ref. No.</b>	0200259
<b>description</b>	gasket for rinse arm mounting pos. upper/lower ø 22.5mm ID ø 13mm thickness 10mm		
<b>For models:</b>	M115, M150, MATIC20		



1

<b>Part No.</b>	524786	<b>Ref. No.</b>	0200400
<b>description</b>	gasket for wash arm mounting pos. upper/lower ø 46mm ID ø 36mm		
<b>For models:</b>	M115, M150, MATIC20		



1

<b>Part No.</b>	506063	<b>Ref. No.</b>	0200295
<b>description</b>	gasket suitable for Lamber equiv. no. 0200295 air trap ED ø 15.5mm ID ø 11.5mm Nyltite		
<b>For models:</b>	015-24L, 050F, 050F-Dep, DSP1, DSP5, F85, F85-Dep, L20, L21, LP31L, LP6, LP6L, M115, M150, MATIC20, P550, S200, S280, S280Dep, Super-QS, Super-QS-Dep		



1

<b>Part No.</b>	506097	<b>Ref. No.</b>	0201506 0203506
<b>description</b>	gasket suitable for Lamber equiv. no. 0201506 L 100mm W 100mm thickness 3mm		
<b>For models:</b>	015-24L, LP31L, LP6, LP6L, M115, M150, MATIC20, P550		

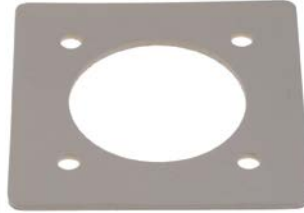

1

<b>Part No.</b>	524258	<b>Ref. No.</b>	0201504
<b>description</b>	gasket suitable for Lamber for wash arm support L 100mm W 100mm Qty 1m ID ø 61mm		
<b>For models:</b>	LP31L, LP6, LP6L		

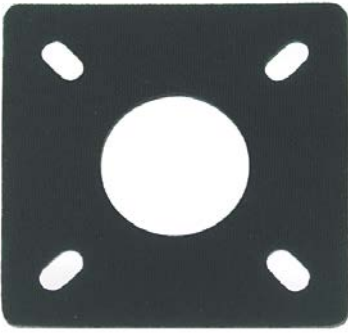

1

<b>Part No.</b>	504440	<b>Ref. No.</b>	0201505
<b>description</b>	gasket suitable for Lamber L 100mm W 100mm ID ø 43mm thickness 3mm		
<b>For models:</b>	M115, M150, MATIC20		

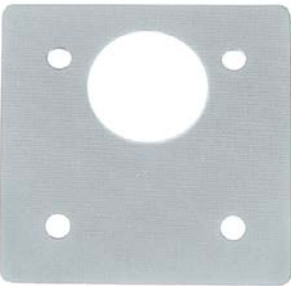

1

<b>Part No.</b>	504441	<b>Ref. No.</b>	0201503
<b>description</b>	gasket suitable for Lamber L 100mm W 100mm Qty 1m ID ø 40mm thickness 3mm		
<b>For models:</b>	M115, M150, MATIC20		

## gaskets for wash arm support



1

<b>Part No.</b>	506021	<b>Ref. No.</b>	0200097
<b>description</b>	gasket D1 ø 45mm D2 ø 105mm thickness 3.4mm rubber with 4 screw holes wash arm support equiv. no. 0200097 suitable for Lamber		
<b>For models:</b>	015-24L, 050F, 050F-Dep, DSP5, F85, F85-Dep, L20, L21, M115, M150, MATIC20, P550		

## transmission technology and ball bearings

## chains

## roller chains 08B-1 single

1

<b>Part No.</b>	697854	<b>Ref. No.</b>	0800081	
<b>description</b>	roller chain DIN/ISO 08 B-1 splitting 1/2" / 12.7mm links 90 L 226mm internal width 7.75mm rollerø 8.51mm single			
<b>For models:</b>	MATIC20			
<b>accessories for</b>	697854			
	<b>Part No.</b>	693276	<b>Ref. No.</b>	0813444
	connector single DIN/ISO 08 B-1 splitting 1/2" links 1 L 23mm internal width 11.8mm rollerø 4.3mm metal			

## connectors



1

<b>Part No.</b>	693276	<b>Ref. No.</b>	0813444
<b>description</b>	connector single DIN/ISO 08 B-1 splitting 1/2" links 1 L 23mm internal width 11.8mm rollerø 4.3mm metal		
<b>For models:</b>	M115, M150, MATIC20		

## half links



1

<b>Part No.</b>	697841	<b>Ref. No.</b>	0813534
<b>description</b>	half link single DIN/ISO 08 B-1 splitting 1/2"		
<b>For models:</b>	M115, M150, MATIC20		

## springs

## spring compressors



1

<b>Part No.</b>	517160	<b>Ref. No.</b>	0800210
<b>description</b>	spring compressor thread M10		
<b>For models:</b>	015-24L, L20, L21		



tension springs

1			
<b>Part No.</b>	506424	<b>Ref. No.</b>	0800033
<b>description</b>	tension spring		

1			
<b>Part No.</b>	700730	<b>Ref. No.</b>	0800161
<b>description</b>	tension spring ø 12mm total length 100mm wire gauge ø 1mm		
<b>For models:</b>	LP31L, LP6, LP6L		

1			
<b>Part No.</b>	506199	<b>Ref. No.</b>	0800711
<b>description</b>	tension spring ø 40.5mm total length 355mm wire gauge ø 5mm L1 220mm D1 ø 40.5mm for hood H1 30mm L 355mm windings 42		
<b>For models:</b>	015-24L, DSP5, L20, L21		

manometers

1			
<b>Part No.</b>	541865	<b>Ref. No.</b>	0301152
<b>description</b>	manometer ø 51mm pressure range 0 up to 4bar thread 1/4" marking 3 connection on the backside		
<b>For models:</b>	M115, M150, MATIC20		

dosing pumps

peristaltic dosing pumps

various

built-in version

1			
<b>Part No.</b>	361299	<b>Ref. No.</b>	0500058
<b>description</b>	dosing pump hose ø 5x7mm		

piston pumps

spare parts

1			
<b>Part No.</b>	510298	<b>Ref. No.</b>	0200425
<b>description</b>	lip valve dosing pump suitable for DB2/DS5		
<b>For models:</b>	015-24L, 050F, 050F-Dep, F85, F85-Dep, L20, L21, S200, S280, S280Dep, Super-QS, Super-QS-Dep		

membrane dosing pumps

self-priming

LANG



1				
<b>Part No.</b>	361221	<b>Ref. No.</b>	0500057	
<b>description</b>	dosing pump type N6 rinse aid pressure connection ø 4x6mm suction connection ø 6x8mm LANG			
<b>For models:</b>	DSP1, DSP2, DSP4, DSP5			
<b>spare parts for</b>	361221			
	<b>Part No.</b>	361079	<b>Ref. No.</b>	—
	spring for type N5/N6 for ball			
	<b>Part No.</b>	361080	<b>Ref. No.</b>	—
	O-ring EPDM thickness 2mm ID ø 16mm Qty 1 pcs			
	<b>Part No.</b>	361085	<b>Ref. No.</b>	—
	O-ring EPDM thickness 2mm ID ø 8mm Qty 1 pcs			
	<b>Part No.</b>	361309	<b>Ref. No.</b>	—
	ball for type N5/N6			
	<b>Part No.</b>	361310	<b>Ref. No.</b>	—
	bracket for type N6 ball guide			
	<b>Part No.</b>	361311	<b>Ref. No.</b>	—
	O-ring EPDM thickness 2mm ID ø 6mm Qty 1 pcs for type N6			
	<b>Part No.</b>	361314	<b>Ref. No.</b>	—
	valve ring for type N6 holder for O-ring			
	<b>Part No.</b>	361317	<b>Ref. No.</b>	—
	sealing disc for type N6			
	<b>Part No.</b>	361886	<b>Ref. No.</b>	—
	non-return valve inletmm outletmm outlet ø 12.4mm L 12.7mm			
	<b>Part No.</b>	505228	<b>Ref. No.</b>	—
	spacer bush ID ø 4.5mm ED ø 10mm L 16mm for dosing pump			



various



<b>Part No.</b>	361015	<b>Ref. No.</b>	0599999
<b>description</b>	dosing pump membrane dosing pump rinse aid inlet 6x8mm outlet 4x6mm pressure connection ø 4x6mm suction connection ø 6x8mm		
<b>For models:</b>	015-24L, 050F, 050F-Dep, F85, F85-Dep, L20, L21, P550, S200, S280, S280Dep, Super-QS, Super-QS-Dep		

<b>spare parts for</b>	361015		
	<b>Part No.</b>	361132	<b>Ref. No.</b> 0200428
	membrane dosing pump		
	<b>Part No.</b>	510298	<b>Ref. No.</b> 0200425
	lip valve dosing pump suitable for DB2/DS5		

spare parts



<b>Part No.</b>	510298	<b>Ref. No.</b>	0200425
<b>description</b>	lip valve dosing pump suitable for DB2/DS5		
<b>For models:</b>	015-24L, 050F, 050F-Dep, F85, F85-Dep, L20, L21, S200, S280, S280Dep, Super-QS, Super-QS-Dep		



<b>Part No.</b>	361132	<b>Ref. No.</b>	0200428
<b>description</b>	membrane dosing pump		
<b>For models:</b>	015-24L, 050F, 050F-Dep, F85, F85-Dep, L20, L21, S200, S280, S280Dep, Super-QS, Super-QS-Dep		



<b>Part No.</b>	510338	<b>Ref. No.</b>	0200219
<b>description</b>	union nut dosing pump thread 1/2" ø 32mm H 15mm for dosing pump		

self-priming with supporting pressure

ELETTROBAR



<b>Part No.</b>	510298	<b>Ref. No.</b>	0200425
<b>description</b>	lip valve dosing pump suitable for DB2/DS5		
<b>For models:</b>	015-24L, 050F, 050F-Dep, F85, F85-Dep, L20, L21, S200, S280, S280Dep, Super-QS, Super-QS-Dep		

GERMAC

spare parts



<b>Part No.</b>	510298	<b>Ref. No.</b>	0200425
<b>description</b>	lip valve dosing pump suitable for DB2/DS5		
<b>For models:</b>	015-24L, 050F, 050F-Dep, F85, F85-Dep, L20, L21, S200, S280, S280Dep, Super-QS, Super-QS-Dep		

accessories

container filters



<b>Part No.</b>	361062	<b>Ref. No.</b>	0200443
<b>description</b>	container filter hose ø 4mm		
<b>For models:</b>	015-24L, 050F, 050F-Dep, DSP1, DSP2, DSP4, DSP5, F85, F85-Dep, L20, L21, P550, S200, S280, S280Dep, Super-QS, Super-QS-Dep		



<b>Part No.</b>	506095	<b>Ref. No.</b>	0201460
<b>description</b>	filter SS for rinse aid container		
<b>For models:</b>	015-24L, 050F, 050F-Dep, DSP5, F85, F85-Dep, L20, L21, S200, S280, S280Dep, Super-QS, Super-QS-Dep		



hoses

dosing hoses









1

<b>Part No.</b>	512477	<b>Ref. No.</b>	0200511
<b>description</b>	hose ED ø 6mm ID ø 4mm PVC		
<b>For models:</b>	050F, 050F-Dep, DSP5, F85, F85-Dep, S200, S280, S280Dep, Super-QS, Super-QS-Dep		

PVC hoses



1

<b>Part No.</b>	520090	<b>Ref. No.</b>	0200091
<b>description</b>	PVC hose ID ø 4mm ED ø 6mm L 2m thickness 1mm t.max. 60°C transparent		
<b>For models:</b>	015-24L, 050F, 050F-Dep, DSP1, DSP2, DSP4, DSP5, F85, F85-Dep, L20, L21, P550, S200, S280, S280Dep, Super-QS, Super-QS-Dep		
<b>accessories for</b>	520090		
	<b>Part No.</b>	361058	<b>Ref. No.</b> —
	container filter with non-return valve SS hose ø 4x6mm ø 20mm L 56mm		
	<b>Part No.</b>	361066	<b>Ref. No.</b> —
	container filter straight SS hose ø 4x6mm L 37mm non return valve ball valve		
	<b>Part No.</b>	361106	<b>Ref. No.</b> —
	container filter with weight and non-return valve SS hose ø 4x6mm ø 21mm L 51mm non return valve lip valve		
	<b>Part No.</b>	361141	<b>Ref. No.</b> —
	container filter with weight ceramic hose ø 4mm		
	<b>Part No.</b>	361230	<b>Ref. No.</b> —
	container filter with weight stainless steel hose ø 4x6mm		
	<b>Part No.</b>	361462	<b>Ref. No.</b> —
	container filter with weight SS hose ø 4x6mm		
	<b>Part No.</b>	361728	<b>Ref. No.</b> —
	container filter with 4m 4x6 hose SS hose ø 4x6mm hose length 4000mm		

tank inlets



1

<b>Part No.</b>	506150	<b>Ref. No.</b>	0500090
<b>description</b>	tank inlet		
<b>For models:</b>	015-24L, 050F, 050F-Dep, F85, F85-Dep, L20, L21, S200, S280, S280Dep, Super-QS, Super-QS-Dep		

hoses

drain hoses



1

<b>Part No.</b>	506214	<b>Ref. No.</b>	0200112
<b>description</b>	drain hose		
<b>For models:</b>	015-24L, 050F, 050F-Dep, DSP5, F85, F85-Dep, L20, L21, P550		



1

<b>Part No.</b>	506060	<b>Ref. No.</b>	0200274 0200293 0200529
<b>description</b>	drain hose		
<b>For models:</b>	DSP1, DSP2, DSP4		



1

<b>Part No.</b>	506207	<b>Ref. No.</b>	0900006
<b>description</b>	drain hose DN19 L 1500mm straight ø inside 19mm straight ext. ø 24mm elbow ø inside 21mm elbow ext. ø 27mm outer hose ø 25mm		
<b>For models:</b>	015-24L, 050F, 050F-Dep, DSP5, F85, F85-Dep, L20, L21, S200, S280, S280Dep, Super-QS, Super-QS-Dep		



1

<b>Part No.</b>	506208	<b>Ref. No.</b>	0900027
<b>description</b>	drain hose DN25 L 1500mm straight ø inside 25mm straight ext. ø 30mm elbow ø inside 40mm elbow ext. ø 46mm outer hose ø 32mm		
<b>For models:</b>	DSP1, DSP2, DSP4, S200, S280, S280Dep, Super-QS, Super-QS-Dep		





## industrial hoses

## pressure control hoses



<b>Part No.</b>	530068	<b>Ref. No.</b>	0200515
<b>description</b>	pressure hose ID $\varnothing$ 4mm ED $\varnothing$ 8.5mm L 1m operating p. 30bar burst p. 90bar temp.-resist. 60°C L 1000mm Qty 1m		
<b>For models:</b>	050F, 050F-Dep, DSP1, DSP5, F85, F85-Dep, LP31L, LP6, LP6L, M115, M150, MATIC20, P550, S200, S280, S280Dep, Super-QS, Super-QS-Dep		

## PVC hoses

## PVC hoses without fabric



<b>Part No.</b>	520090	<b>Ref. No.</b>	0200091
<b>description</b>	PVC hose ID $\varnothing$ 4mm ED $\varnothing$ 6mm L 2m thickness 1mm t.max. 60°C transparent		
<b>For models:</b>	015-24L, 050F, 050F-Dep, DSP1, DSP2, DSP4, DSP5, F85, F85-Dep, L20, L21, P550, S200, S280, S280Dep, Super-QS, Super-QS-Dep		

## accessories for 520090

	<b>Part No.</b>	361058	<b>Ref. No.</b>	—
	container filter with non-return valve SS hose $\varnothing$ 4x6mm $\varnothing$ 20mm L 56mm			
	<b>Part No.</b>	361066	<b>Ref. No.</b>	—
	container filter straight SS hose $\varnothing$ 4x6mm L 37mm non return valve ball valve			
	<b>Part No.</b>	361106	<b>Ref. No.</b>	—
	container filter with weight and non-return valve SS hose $\varnothing$ 4x6mm $\varnothing$ 21mm L 51mm non return valve lip valve			
	<b>Part No.</b>	361141	<b>Ref. No.</b>	—
	container filter with weight ceramic hose $\varnothing$ 4mm			
	<b>Part No.</b>	361230	<b>Ref. No.</b>	—
	container filter with weight stainless steel hose $\varnothing$ 4x6mm			
	<b>Part No.</b>	361462	<b>Ref. No.</b>	—
	container filter with weight SS hose $\varnothing$ 4x6mm			
	<b>Part No.</b>	361728	<b>Ref. No.</b>	—
	container filter with 4m 4x6 hose SS hose $\varnothing$ 4x6mm hose length 4000mm			

## hoses wire reinforced

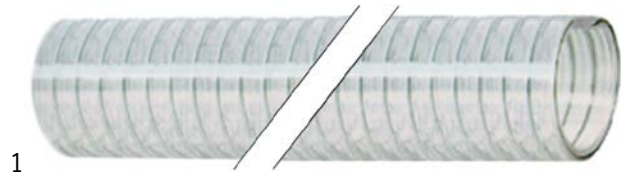

<b>Part No.</b>	506074	<b>Ref. No.</b>	0200521
<b>description</b>	drain hose ID $\varnothing$ 32mm ED $\varnothing$ 41mm L 1m wire reinforced		
<b>For models:</b>	015-24L		

## formed hoses

## straight



<b>Part No.</b>	506218	<b>Ref. No.</b>	0201923
<b>description</b>	extraction hose		
<b>For models:</b>	050F, 050F-Dep, F85, F85-Dep		



<b>Part No.</b>	506011	<b>Ref. No.</b>	0200031
<b>description</b>	formed hose dishwasher straight		



<b>Part No.</b>	506112	<b>Ref. No.</b>	0201914
<b>description</b>	formed hose dishwasher straight		
<b>For models:</b>	015-24L, P550		

1

<b>Part No.</b>	504160	<b>Ref. No.</b>	0201900
<b>description</b>	formed hose L 100mm dishwasher straight hose ext. ø 60mm equiv. no. 4085, 3927		
<b>For models:</b>	M115, M150, MATIC20		



1

<b>Part No.</b>	506036	<b>Ref. No.</b>	0200131
<b>description</b>	formed hose L 100mm dishwasher straight ø 30mm		
<b>For models:</b>	015-24L, 050F, 050F-Dep, F85, F85-Dep, L20, L21, P550		



1

<b>Part No.</b>	506032	<b>Ref. No.</b>	0200122
<b>description</b>	formed hose L 130mm dishwasher straight hose ext. ø 50mm		



1

<b>Part No.</b>	506113	<b>Ref. No.</b>	0201919
<b>description</b>	formed hose L 150mm dishwasher straight enlarged mounting pos. lower nominal-ø 60/43mm		
<b>For models:</b>	015-24L, DSP5, P550		



1

<b>Part No.</b>	506423	<b>Ref. No.</b>	0201924
<b>description</b>	formed hose L 230mm dishwasher straight ø 40mm		
<b>For models:</b>	L20, L21		



1

<b>Part No.</b>	506031	<b>Ref. No.</b>	0200119
<b>description</b>	formed hose L 50mm dishwasher straight hose ext. ø 35mm		



1

<b>Part No.</b>	506038	<b>Ref. No.</b>	0200133
<b>description</b>	formed hose L 60mm dishwasher straight mounting pos. lower ø 40mm		

form L



1

<b>Part No.</b>	506107	<b>Ref. No.</b>	0201904
<b>description</b>	formed hose end piece A ext. ø 37mm AD2 ø 28mm warewashing L-shape equiv. no. 0201904		
<b>For models:</b>	DSP1, DSP2		



1

<b>Part No.</b>	506108	<b>Ref. No.</b>	0201905
<b>description</b>	formed hose end piece A ext. ø 38mm AD2 ø 29mm warewashing L-shape equiv. no. 0201905		
<b>For models:</b>	DSP1, DSP2, S200, S280, S280Dep, Super-QS, Super-QS-Dep		



1

<b>Part No.</b>	506055	<b>Ref. No.</b>	0200244
<b>description</b>	formed hose L 133mm warewashing L-shape equiv. no. 0200244 ID ø 37mm		

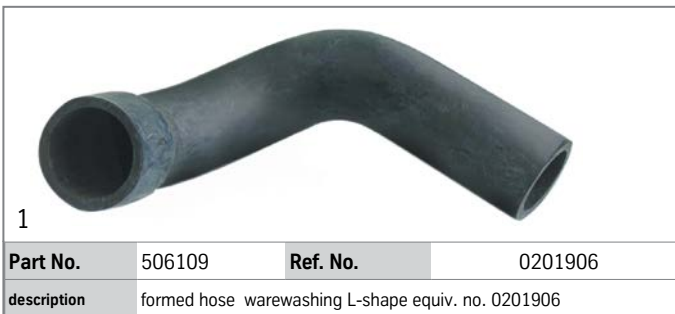
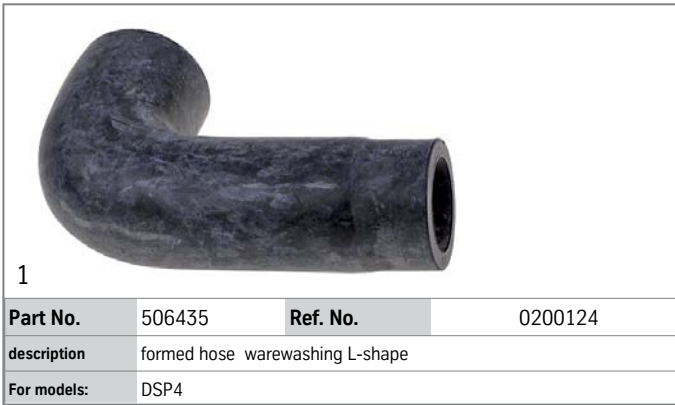

## form S



## for dishwashers

## ventilation hoses

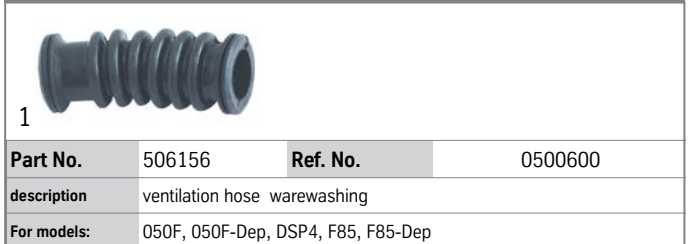

## miscellaneous

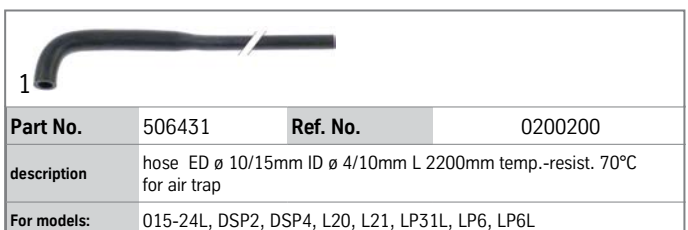
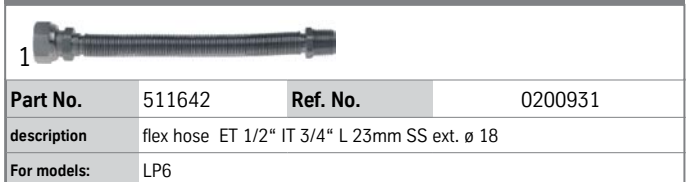



## fittings, hose and pipe connectors

### fittings

#### double nipples



1

<b>Part No.</b>	520164	<b>Ref. No.</b>	0200698
<b>description</b>	double nipple nickel-plated brass thread 1/4" - 3/8" Qty 1 pcs		



1

<b>Part No.</b>	506013	<b>Ref. No.</b>	0200040
<b>description</b>	double nipple SS thread 1/4" - 3/8" Qty 1 pcs		
<b>For models:</b>	015-24L, DSP1, DSP2, DSP4, DSP5, L20, L21, S200, S280, S280Dep, Super-QS, Super-QS-Dep		

#### reducers



1

<b>Part No.</b>	520880	<b>Ref. No.</b>	0200909
<b>description</b>	reducer thread 1/4" ET - 1" IT brass total length 26mm WS 42 Qty 1 pcs		



1

<b>Part No.</b>	520879	<b>Ref. No.</b>	0200920
<b>description</b>	reducer thread 3/4" ET - 1/2" IT brass total length 17mm WS 26 Qty 1 pcs		
<b>For models:</b>	LP31L, LP6, M115, M150		



1

<b>Part No.</b>	506083	<b>Ref. No.</b>	0200932
<b>description</b>	reducer thread 1" ET - 1/2" IT brass total length 22mm WS 34		
<b>For models:</b>	015-24L, L20, L21, LP31L, LP6L, P550		

#### angle pieces



1

<b>Part No.</b>	541675	<b>Ref. No.</b>	0200905
<b>description</b>	angle piece thread 1/2" ET - 1/2" IT brass		
<b>For models:</b>	LP6, M115, M150, MATIC20		



1

<b>Part No.</b>	540020	<b>Ref. No.</b>	0200910
<b>description</b>	angle piece thread 1/2" IT - 1/2" IT chrome-plated brass		
<b>For models:</b>	LP31L, LP6, M115, M150, MATIC20		



1

<b>Part No.</b>	506041	<b>Ref. No.</b>	0200162
<b>description</b>	angle piece thread 3/8" polypropylene		
<b>For models:</b>	015-24L, L20, L21		

hose connectors

plastic



1

<b>Part No.</b>	506122	<b>Ref. No.</b>	0221302
-----------------	--------	-----------------	---------

**description** hose connector plastic straight thread 1 1/4" hose ø 31mm Qty 1 pcs

**For models:** 015-24L, DSP5, L20, L21, P550

**accessories for** 506122

	<b>Part No.</b>	506072	<b>Ref. No.</b>	0200403
---	-----------------	--------	-----------------	---------

flat gasket fibre ED ø 38mm ID ø 27mm thickness 2mm outflow for thread 1 1/4" Qty 1 pcs

	<b>Part No.</b>	506074	<b>Ref. No.</b>	0200521
---	-----------------	--------	-----------------	---------

drain hose ID ø 32mm ED ø 41mm L 1m wire reinforced



1

<b>Part No.</b>	506125	<b>Ref. No.</b>	0221310
-----------------	--------	-----------------	---------

**description** hose connector plastic angled thread 3/8" hose ø 12mm Qty 1 pcs

**For models:** 015-24L, 050F, 050F-Dep, F85, F85-Dep, L20, L21, S200, S280, S280Dep, Super-QS, Super-QS-Dep

**accessories for** 506125

	<b>Part No.</b>	506042	<b>Ref. No.</b>	0200171
---	-----------------	--------	-----------------	---------

flat gasket FIBER ED ø 27mm ID ø 17mm thickness 2mm Qty 1 pcs

	<b>Part No.</b>	506132	<b>Ref. No.</b>	0300047
---	-----------------	--------	-----------------	---------

nut thread 3/8"

producer-specific



1

<b>Part No.</b>	506082	<b>Ref. No.</b>	0200906
-----------------	--------	-----------------	---------

**description** hose connector angled brass ø 1/2"mm

**For models:** 015-24L, L20, L21, LP31L, LP6, LP6L, M115, M150, MATIC20, P550



1

<b>Part No.</b>	506052	<b>Ref. No.</b>	0200231
-----------------	--------	-----------------	---------

**description** hose connector connection 3/4" hose ø 12mm

**For models:** LP31L



1

<b>Part No.</b>	506126	<b>Ref. No.</b>	0221313
-----------------	--------	-----------------	---------

**description** hose connector curved plastic ø 3/4"mm

**For models:** LP31L, M115, M150



1

<b>Part No.</b>	506081	<b>Ref. No.</b>	0200903
-----------------	--------	-----------------	---------

**description** hose connector straight ø 1/2"mm

**For models:** 015-24L, L20, L21, LP31L, LP6, LP6L, M115, M150, MATIC20, P550



1

<b>Part No.</b>	506014	<b>Ref. No.</b>	0200049
-----------------	--------	-----------------	---------

**description** hose connector straight ø 3/4"mm



1

<b>Part No.</b>	506415	<b>Ref. No.</b>	0221304
-----------------	--------	-----------------	---------

**description** hose connector thread 2" for hose ø60mm

**For models:** LP31L, LP6L



1

<b>Part No.</b>	505256	<b>Ref. No.</b>	0200646
-----------------	--------	-----------------	---------

**description** hose connector thread M12 ø 13mm 1/2" ET

**For models:** M115, M150, MATIC20



			
1			
<b>Part No.</b>	506124	<b>Ref. No.</b>	0221307
<b>description</b>	reducer straight plastic		

			
1			
<b>Part No.</b>	506098	<b>Ref. No.</b>	0201804
<b>description</b>	T-piece		
<b>For models:</b>	015-24L, P550		

## water cycle components

### pressure reduction valves

#### pressure reduction valves

#### universal

			
1			
<b>Part No.</b>	520881	<b>Ref. No.</b>	0301151
<b>description</b>	pressure reduction valve DESBORDES series DN15 connection 1/2" default setting 3bar setting range 1-5.5bar EN1567 p max 25bar t.max. 80°C brass WRAS/ACS		
<b>For models:</b>	M115, M150, MATIC20		

## ancillary products

### clamps

#### hose clamps

#### DIN 3017 - W2

			
1			
<b>Part No.</b>	520115	<b>Ref. No.</b>	0200298
<b>description</b>	hose clamp ø 25-40mm width 9mm Qty 10 pcs DIN 3017		
<b>For models:</b>	015-24L, 050F, 050F-Dep, DSP1, DSP2, DSP4, DSP5, F85, F85-Dep, L20, L21, P550, S200, S280, S280Dep, Super-QS, Super-QS-Dep		

			
1			
<b>Part No.</b>	520119	<b>Ref. No.</b>	0200248 0200713
<b>description</b>	hose clamp ø 60-80mm width 9mm Qty 5 pcs DIN 3017		
<b>For models:</b>	L20, L21, M115, M150, MATIC20, P550		

			
1			
<b>Part No.</b>	520117	<b>Ref. No.</b>	0200069
<b>description</b>	hose clamp stainless steel ø 40-60mm width 9mm Qty 5 pcs DIN 3017		
<b>For models:</b>	050F, 050F-Dep, DSP4, DSP5, F85, F85-Dep, L20, L21, P550		

#### DIN 3017 - W4

			
1			
<b>Part No.</b>	520120	<b>Ref. No.</b>	0200190 0200300
<b>description</b>	hose clamp SS W4 ø 12-20mm width 9mm Qty 1 pcs DIN 3017		
<b>For models:</b>	015-24L, 050F, 050F-Dep, DSP1, DSP2, DSP4, DSP5, F85, F85-Dep, L20, L21, LP31L, LP6, LP6L, P550, S200, S280, S280Dep, Super-QS, Super-QS-Dep		

## tools

### hand tools

#### wrenches

#### miscellaneous

			
1			
<b>Part No.</b>	801662	<b>Ref. No.</b>	0802792
<b>description</b>	adjusting spanner for clutch L 270mm		
<b>For models:</b>	M115, M150, MATIC20		



## measuring equipment

### thermometers

#### built-in thermometers



1

<b>Part No.</b>	541086	<b>Ref. No.</b>	0500005
<b>description</b>	thermometer mounting measurements 58x25.5mm 0 up to +120°C capillary pipe 2000mm probe ø 6mm probe L 23mm		
<b>For models:</b>	M115, M150		



1

<b>Part No.</b>	541305	<b>Ref. No.</b>	0500008
<b>description</b>	thermometer mounting measurements 62x11mm +20 up to +120°C capillary pipe 1500mm probe ø 6.5mm probe L 16mm		

#### ø52mm



1

<b>Part No.</b>	541065	<b>Ref. No.</b>	0500009
<b>description</b>	thermometer mounting ø 52mm t.max. 120°C 0 up to +120°C probe ø 6.5mm probe L 28mm capillary pipe 1500mm		
<b>For models:</b>	F85, LP31L, LP6, LP6L, MATIC20, P550, S280, S280Dep, Super-QS, Super-QS-Dep		

## fastening material

### screws

#### sheet metal screws



1

<b>Part No.</b>	560240	<b>Ref. No.</b>	0800001
<b>description</b>	sheet metal screws ø 3.9mm L 16mm SS Qty 20 pcs DIN 7982/ ISO 7050 head ø 7.5mm sunk head		
<b>For models:</b>	DSP1, DSP2, DSP4, DSP5		

### hexagonal screws



1

<b>Part No.</b>	506445	<b>Ref. No.</b>	0800228
<b>description</b>	hexagonal screw thread M10 thread L 35mm SS WS 17 Qty 1 pcs DIN 933 / ISO 4017		
<b>For models:</b>	015-24L, DSP5, L20, L21		



1

<b>Part No.</b>	560476	<b>Ref. No.</b>	0800661
<b>description</b>	hexagonal screw thread M10 thread L 40mm zinc-coated steel WS 17 Qty 1 pcs head thickness 6.4mm DIN 933 / ISO 4017		
<b>For models:</b>	015-24L, DSP5, L20, L21		



1

<b>Part No.</b>	560539	<b>Ref. No.</b>	0800667
<b>description</b>	hexagonal screw thread M10 thread L 42mm SS WS 17 Qty 1 pcs head thickness 6.5mm DIN 933 / ISO 4017		
<b>For models:</b>	M115, M150, MATIC20		



1

<b>Part No.</b>	560085	<b>Ref. No.</b>	0800648
<b>description</b>	hexagonal screw thread M5 thread L 20mm SS WS 8 Qty 20 pcs DIN 933 / ISO 4017		
<b>For models:</b>	DSP1, DSP2, DSP4		



1

<b>Part No.</b>	560088	<b>Ref. No.</b>	0800062
<b>description</b>	hexagonal screw thread M6 thread L 20mm SS WS 10 Qty 20 pcs DIN 933 / ISO 4017		
<b>For models:</b>	LP31L, LP6, LP6L, P550		



1

<b>Part No.</b>	506447	<b>Ref. No.</b>	0800009
<b>description</b>	hexagonal screw thread M8 thread L 16mm SS WS 13 Qty 1 pcs DIN 933 / ISO 4017		
<b>For models:</b>	DSP4, DSP5, LP31L, LP6, LP6L		





 <p>1</p>			
<b>Part No.</b>	506446	<b>Ref. No.</b>	0800016
<b>description</b>	hexagonal screw thread M8 thread L 40mm SS WS 13 Qty 1 pcs DIN 933 / ISO 4017		
<b>For models:</b>	015-24L, 050F, 050F-Dep, F85, F85-Dep, P550		

 <p>1</p>			
<b>Part No.</b>	560129	<b>Ref. No.</b>	0800257
<b>description</b>	hexagonal nut thread M5 H 4mm WS 8 SS DIN/ISO DIN 934 / ISO 4032/8673 Qty 1 pcs		
<b>For models:</b>	DSP1, DSP2, DSP4		

grub screws

DIN 914/ISO 4027

 <p>1</p>			
<b>Part No.</b>	560175	<b>Ref. No.</b>	0800682
<b>description</b>	grub screw thread M8 L 16mm DIN 914/ISO 4027 intake internal hexagon WS 4 Qty 1 pcs		
<b>For models:</b>	LP6L, M115, M150, MATIC20		

 <p>1</p>			
<b>Part No.</b>	560133	<b>Ref. No.</b>	0800063 0800656
<b>description</b>	hexagonal nut thread M6 H 5mm WS 10 SS DIN/ISO DIN 934 / ISO 4032/8673 Qty 20 pcs		
<b>For models:</b>	015-24L, 050F, 050F-Dep, F85, F85-Dep, L20, L21, LP31L, LP6, LP6L, M115, M150, MATIC20, P550, S200, S280, S280Dep, Super-QS, Super-QS-Dep		

knurled screws

 <p>1</p>			
<b>Part No.</b>	506172	<b>Ref. No.</b>	0800130
<b>description</b>	Thumb screw thread M6 thread L 9mm ø 22mm H 6mm SS		
<b>For models:</b>	015-24L, 050F, 050F-Dep, F85, F85-Dep, L20, L21, LP31L, LP6, LP6L, P550, S200, S280, S280Dep, Super-QS, Super-QS-Dep		

 <p>1</p>			
<b>Part No.</b>	560197	<b>Ref. No.</b>	0800106
<b>description</b>	nut thread M10 H 8mm WS 17 SS DIN/ISO DIN 934 / ISO 4032/8673 Qty 1 pcs		
<b>For models:</b>	015-24L, DSP5, L20, L21		

nuts

knurled nuts

 <p>1</p>			
<b>Part No.</b>	506146	<b>Ref. No.</b>	0500011
<b>description</b>	knurled nut thread M6		

 <p>1</p>			
<b>Part No.</b>	506166	<b>Ref. No.</b>	0800091
<b>description</b>	nut thread M12 H 10mm WS 19 SS DIN/ISO DIN 934 / ISO 4032/8673 Qty 1 pcs		
<b>For models:</b>	015-24L, 050F, 050F-Dep, DSP5, F85, F85-Dep, L20, L21, S200, S280, S280Dep, Super-QS, Super-QS-Dep		

hexagonal nuts

DIN 934 / ISO 4032/8673

 <p>1</p>			
<b>Part No.</b>	560199	<b>Ref. No.</b>	0800082
<b>description</b>	hexagonal nut thread M10 H 8mm WS 17 SS DIN/ISO DIN 934 / ISO 4032/8673 Qty 10 pcs		
<b>For models:</b>	M115, M150, MATIC20		

DIN 985

 <p>1</p>			
<b>Part No.</b>	560227	<b>Ref. No.</b>	0800652
<b>description</b>	hexagonal nut thread M3 H 4mm SS WS 5.5 Qty 1 pcs self-locking		
<b>For models:</b>	050F, 050F-Dep, DSP1, DSP2, DSP4, DSP5, F85, F85-Dep, S200, S280, S280Dep, Super-QS, Super-QS-Dep		







			
1			
<b>Part No.</b>	560142	<b>Ref. No.</b>	0800669
<b>description</b>	hexagonal nut thread M6 H 6mm SS WS 10 Qty 20 pcs DIN/ISO DIN 985 self-locking		
<b>For models:</b>	LP31L, LP6, LP6L, M115, M150		

			
1			
<b>Part No.</b>	560143	<b>Ref. No.</b>	0800093 0800657
<b>description</b>	hexagonal nut thread M8 H 8.5mm SS WS 13 Qty 20 pcs DIN/ISO DIN 985 self-locking		
<b>For models:</b>	015-24L, DSP4, DSP5, L20, L21, LP31L, LP6, LP6L, M115, M150, MATIC20, P550		

## DIN 982 (self-locking, tall version)

			
1			
<b>Part No.</b>	560475	<b>Ref. No.</b>	0800144
<b>description</b>	hexagonal nut thread M10 H 11.5mm zinc-coated steel WS 17 Qty 1 pcs DIN/ISO DIN 982		
<b>For models:</b>	015-24L, DSP5, L20, L21		

			
1			
<b>Part No.</b>	560660	<b>Ref. No.</b>	0800653
<b>description</b>	hexagonal nut thread M5 H 5.4mm zinc-coated steel WS 8 Qty 20 pcs DIN/ISO DIN 982 self-locking		

## hexagonal nuts metric (without norm)

			
1			
<b>Part No.</b>	506162	<b>Ref. No.</b>	0800045
<b>description</b>	nut		
<b>For models:</b>	015-24L, L20, L21, LP31L, LP6, LP6L, M115, M150, MATIC20, P550		

			
1			
<b>Part No.</b>	521131	<b>Ref. No.</b>	0800205
<b>description</b>	nut thread M12x1 H 3.5mm WS 17 SS Qty 1 pcs		
<b>For models:</b>	015-24L, 050F, 050F-Dep, DSP1, DSP2, DSP4, DSP5, F85, F85-Dep, L20, L21, LP31L, LP6, LP6L, P550, S200, S280, S280Dep, Super-QS, Super-QS-Dep		

			
1			
<b>Part No.</b>	521101	<b>Ref. No.</b>	0800664
<b>description</b>	nut thread M14x1.5 H 5mm WS 19 SS Qty 1 pcs		

## hexagonal nuts inch thread

			
1			
<b>Part No.</b>	506194	<b>Ref. No.</b>	0800655
<b>description</b>	nut thread 1/2" H 3mm nickel-plated brass WS 24 Qty 1 pcs		
<b>For models:</b>	050F, 050F-Dep, F85, F85-Dep, M115, M150, MATIC20, S200, S280, S280Dep, Super-QS, Super-QS-Dep		

			
1			
<b>Part No.</b>	506024	<b>Ref. No.</b>	0200101
<b>description</b>	nut thread 3/8" H 6mm SS WS 22 Qty 1 pcs		
<b>For models:</b>	015-24L, L20, L21, S200, S280, S280Dep, Super-QS, Super-QS-Dep		

## union nuts

			
1			
<b>Part No.</b>	506196	<b>Ref. No.</b>	0800673
<b>description</b>	nut brass		
<b>For models:</b>	015-24L, 050F, 050F-Dep, DSP5, F85, F85-Dep, L20, L21, LP31L, LP6, LP6L, P550, S200, S280, S280Dep, Super-QS, Super-QS-Dep		

## washers

## spring rings

			
1			
<b>Part No.</b>	560123	<b>Ref. No.</b>	0800066
<b>description</b>	lock washer ID ø 6.3mm ED ø 11mm SS DIN127 Qty 20 pcs for thread M6		
<b>For models:</b>	015-24L, 050F, 050F-Dep, DSP5, F85, F85-Dep, L20, L21, LP31L, LP6, LP6L, M115, M150, MATIC20, P550, S200, S280, S280Dep, Super-QS, Super-QS-Dep		





washers			
DIN 125A			
			
1			
<b>Part No.</b>	560112	<b>Ref. No.</b>	0800256
<b>description</b>	plain washer ID ø 5.3mm ED ø 10mm thickness 1mm SS Qty 20 pcs DIN 125A for thread M5		
<b>For models:</b>	050F, 050F-Dep, DSP1, DSP2, DSP4, F85, F85-Dep, S200, S280, S280Dep, Super-QS, Super-QS-Dep		

			
1			
<b>Part No.</b>	560113	<b>Ref. No.</b>	0800004
<b>description</b>	plain washer ID ø 6.4mm ED ø 12mm thickness 1.6mm SS Qty 20 pcs DIN 125A for thread M6		
<b>For models:</b>	LP31L, LP6, LP6L		

DIN 9021			
			
1			
<b>Part No.</b>	528761	<b>Ref. No.</b>	0800064
<b>description</b>	plain washer ID ø 6.5mm ED ø 18mm thickness 1.5mm SS Qty 1 pcs		
<b>For models:</b>	050F, 050F-Dep, F85, F85-Dep, LP31L, LP6, LP6L, M115, M150, MATIC20, P550, S200, S280, S280Dep, Super-QS, Super-QS-Dep		

miscellaneous			
			
1			
<b>Part No.</b>	506205	<b>Ref. No.</b>	0800906
<b>description</b>	disc SS		

			
1			
<b>Part No.</b>	506160	<b>Ref. No.</b>	0800028
<b>description</b>	plain washer ID ø 8.6mm ED ø 16mm thickness 1.5mm SS Qty 1 pcs		
<b>For models:</b>	015-24L, DSP5, L20, L21, LP31L, LP6, LP6L, M115, M150, MATIC20		

tooth lock washers			
DIN 6798A			
			
1			
<b>Part No.</b>	560125	<b>Ref. No.</b>	0800101
<b>description</b>	tooth lock washer ID ø 4.2mm ED ø 8mm SS DIN/ISO DIN 6798A Qty 20 pcs for thread M4		
<b>For models:</b>	050F, 050F-Dep, F85, F85-Dep, LP31L, LP6, LP6L, S200, S280, S280Dep, Super-QS, Super-QS-Dep		

## fasteners

### clamps

#### hose clamps

DIN 3017 - W2			
			
1			
<b>Part No.</b>	520115	<b>Ref. No.</b>	0200298
<b>description</b>	hose clamp ø 25-40mm width 9mm Qty 10 pcs DIN 3017		
<b>For models:</b>	015-24L, 050F, 050F-Dep, DSP1, DSP2, DSP4, DSP5, F85, F85-Dep, L20, L21, P550, S200, S280, S280Dep, Super-QS, Super-QS-Dep		

			
1			
<b>Part No.</b>	520119	<b>Ref. No.</b>	0200248 0200713
<b>description</b>	hose clamp ø 60-80mm width 9mm Qty 5 pcs DIN 3017		
<b>For models:</b>	L20, L21, M115, M150, MATIC20, P550		

			
1			
<b>Part No.</b>	520117	<b>Ref. No.</b>	0200069
<b>description</b>	hose clamp stainless steel ø 40-60mm width 9mm Qty 5 pcs DIN 3017		
<b>For models:</b>	050F, 050F-Dep, DSP4, DSP5, F85, F85-Dep, L20, L21, P550		



## DIN 3017 - W4



1

<b>Part No.</b>	520120	<b>Ref. No.</b>	0200190 0200300
<b>description</b>	hose clamp SS W4 ø 12-20mm width 9mm Qty 1 pcs DIN 3017		
<b>For models:</b>	015-24L, 050F, 050F-Dep, DSP1, DSP2, DSP4, DSP5, F85, F85-Dep, L20, L21, LP31L, LP6, LP6L, P550, S200, S280, S280Dep, Super-QS, Super-QS-Dep		

## cable clamps



1

<b>Part No.</b>	524789	<b>Ref. No.</b>	0800492
<b>description</b>	cable clamp wire gauge ø 5mm SS		
<b>For models:</b>	M115, M150, MATIC20		

## retaining rings

## DIN 471



1

<b>Part No.</b>	514030	<b>Ref. No.</b>	0800133
<b>description</b>	retaining ring shaft ø 20mm thickness 1.3mm steel DIN 471		

## screw caps



1

<b>Part No.</b>	505257	<b>Ref. No.</b>	0800166 + 0200295 0802080
<b>description</b>	screw thread 1/8" with gasket thread L 15mm V2A WS 13 head thickness 4mm		
<b>For models:</b>	LP31L, LP6, M115, M150, MATIC20		

**GASTRO**PARTS.COM

