



GASTROPARTS

Lainox

[EN] Equipment

[DE] Geräte

[ES] Aparatos

[FR] Équipement

[IT] Attrezzature

[PL] Urządzenia

[RU] Оборудование

✉ gastroparts@gastroparts.com

☎ +48 56 657 00 66

📘 fb.com/gastroparts.global

GASTROPARTS.COM





heating elements

heating elements for ovens

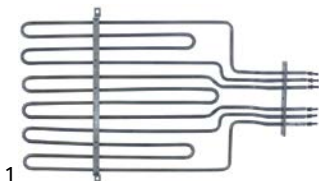

1

Part No.	420226	Ref. No.	65011040 LAR65011040
description	heating element 4500W 230V heating circuits 3 L 490mm W 285mm flange length 140mm flange width 22mm hole distance 63mm hole ø 5mm tube ø 6.2mm connection M4 windings 6 rectangular flange dry heating element H 31mm		

heating elements for refrigeration

heating elements for condensate evaporation



1

Part No.	418582	Ref. No.	BN1666101
description	heating element 100W 230V L 140mm W 225mm H 80mm W1 62mm W2 62mm cable length 1500mm connection cable tube ø 9mm thermostat sleeves ø 7.5mm length thermostat sleeves 111mm thermostat sleeve lateral, adjacent condensate evaporation number of thermostat sleeves 1		

heating cables

connection on both sides

with male fastons



1

Part No.	417576	Ref. No.	996456 FR6621641 FR996456
description	heating cable 45.3W 230V L 5000mm		

immersion heating elements

3 hole flange ø57.5mm



1

Part No.	415021	Ref. No.	50303250 LAR50303250
description	heating element 6000W 230V mounting ø 57.5mm heating circuits 3 L 343mm W 37mm H 50mm number of thermostat sleeves 1 thermostat sleeves ø 7mm length thermostat sleeves 294mm thermostat sleeve not clinging tube ø 8.5mm hole distance 72mm hole ø 8mm connection M5 3 hole flange		
For models:	FV03, FV06, ME05, ME10, ME15, ME20, ME21, ME24, ME40, MG20, MME10, MME40		
accessories for	415021		
	Part No.	550002	Ref. No. —
	tension strap H 10mm L 21mm W 10mm hole ø 6.5mm for heating element		



with round flange ø57.5mm







1

Part No.	415849	Ref. No.	65020390 65020400 65020420 65020421 LA65020421 LAR65020390 LAR65020400 LAR65020420 LAR65020421
description	heating element 15000W 230V heating circuits 3 mounting ø 57.5mm L 530mm W 45mm H 30mm round flange connection M4 immersion heater tube ø 8.5mm connection length 15mm thermostat sleeves ø 7mm number of thermostat sleeves 1 length thermostat sleeves 272mm thermostat sleeve eccentric, clinging		
For models:	GEMT20P, GEMT20T, GEMT21P, GEMT21T, GEMT40P, GEMT40T, HME102P, HME102T, HME102X, HME201P, HME201T, HME201X, HME202P, HME202T, HME202X, ME102D, ME102H, ME102M, ME102P, ME102T, ME201D, ME201H, ME201M, ME201P, ME201T, ME202D, ME202H, ME202M, ME202P, ME202T, ME220D, ME220H, ME220L, ME220M, ME220P, ME220S, ME220T, ME220X, MEC40H, MEC40M, MEMT20D, MEMT20P, MEMT21D, MEMT21P, MEMT40D, MEMT40P, MME102P		
accessories for	415849		
	Part No.	550002	Ref. No. —
	tension strap H 10mm L 21mm W 10mm hole ø 6.5mm for heating element		





			
1			
Part No.	418198	Ref. No.	65020110 65020120 LAR65020110 LAR65020120
description	heating element 3150W 220V heating circuits 3 mounting ø 57.5mm L 240mm W 54mm H 54mm flange with thread immersion heater tube ø 6.3mm thermostat sleeves ø 6mm number of thermostat sleeves 1 length thermostat sleeves 220mm thermostat sleeve clinging		
For models:	ME004L, ME004S		
accessories for	418198		
	Part No.	550002	Ref. No. —
tension strap H 10mm L 21mm W 10mm hole ø 6.5mm for heating element			



			
1			
Part No.	418199	Ref. No.	65020180 65020190 LAR65020180 LAR65020190
description	heating element 3900W 230V heating circuits 3 mounting ø 57.5mm L 230mm W 35mm H 49mm round flange connection male faston 6.3mm immersion heater tube ø 8.5mm thermostat sleeves ø 7mm number of thermostat sleeves 1 length thermostat sleeves 210mm thermostat sleeve clinging		
For models:	ME104L, ME104S		
accessories for	418199		
	Part No.	510409	Ref. No. 70045010 LA70045010 LAR70045010 R70045010
O-ring EPDM thickness 5.34mm ID ø 56.52mm Qty 1 pcs			
	Part No.	550002	Ref. No. —
tension strap H 10mm L 21mm W 10mm hole ø 6.5mm for heating element			

			
1			
Part No.	418200	Ref. No.	65020240 65020270 65020280 65025100 LA65020280 LAR65020240 LAR65020270 LAR65020280 LAR65025100
description	heating element 6000W 230V heating circuits 3 mounting ø 57.5mm L 377mm W 50mm H 38mm round flange connection M4 immersion heater tube ø 8.5mm thermostat sleeves ø 7.5mm number of thermostat sleeves 1 length thermostat sleeves 260mm thermostat sleeve eccentric, clinging		
For models:	ME105L, ME105S		
spare parts for	418200		
	Part No.	510409	Ref. No. 70045010 LA70045010 LAR70045010 R70045010
O-ring EPDM thickness 5.34mm ID ø 56.52mm Qty 1 pcs			

accessories for	418200		
	Part No.	550002	Ref. No. —
tension strap H 10mm L 21mm W 10mm hole ø 6.5mm for heating element			

			
1			
Part No.	415848	Ref. No.	50303890 65020320 65020330 65020350 LA65020350 LAR50303890 LAR65020320 LAR65020330 LAR65020350
description	heating element 7500W 230V heating circuits 3 mounting ø 57.5mm L 365mm W 36mm H 50mm round flange connection M4 immersion heater tube ø 8.5mm thermostat sleeves ø 7.5mm number of thermostat sleeves 1 length thermostat sleeves 270mm thermostat sleeve eccentric, clinging		
For models:	EM010M+SC, EM106H, EM106M, EM106M+SC, EM106P, EM110H, EM110M, EM110M+SC, EM110P, EM210H, EM210M, EM210M+SC, EM210P, EMT06D, GEMT06P, GEMT06T, GEMT10P, GEMT10T, HME061P, HME061T, HME061X, HME101P, HME101T, HME101X, ME061D, ME061H, ME061M, ME061P, ME061T, ME101D, ME101H, ME101M, ME101P, ME101T, ME106D, ME106H, ME106L, ME106M, ME106P, ME106S, ME106T, ME106X, ME110D, ME110H, ME110L, ME110M, ME110P, ME110S, ME110T, ME110X...(Other models you can see in the webshop)		
spare parts for	415848		
	Part No.	510409	Ref. No. 70045010 LA70045010 LAR70045010 R70045010
O-ring EPDM thickness 5.34mm ID ø 56.52mm Qty 1 pcs			
accessories for	415848		
	Part No.	550002	Ref. No. —
tension strap H 10mm L 21mm W 10mm hole ø 6.5mm for heating element			

with round flange (miscellaneous)

			
1			
Part No.	417720	Ref. No.	65020340 LA65020340 LAR65020340
description	heating element 7500W 277V L 370mm W 40mm H 35mm heating circuits 3 flange ø 72mm round flange connection M4 for boiler tube ø 8.5mm thermostat sleeves ø 8.5mm number of thermostat sleeves 1 length thermostat sleeves 272mm thermostat sleeve clinging		
For models:	ME110X, ME120P, ME227M, ME227P, ME227X		
accessories for	417720		
	Part No.	510409	Ref. No. 70045010 LA70045010 LAR70045010 R70045010
O-ring EPDM thickness 5.34mm ID ø 56.52mm Qty 1 pcs			



heating elements for convection



1

Part No.	420549	Ref. No.	LA65011930 LAR65011930
description	heating element 10000W 230V heating circuits 3 ID ø 265mm ED ø 282mm L 335mm H 90mm flange length 142mm flange width 25mm hole distance 63mm tube ø 8.5mm hole ø 6mm		



1

Part No.	418195	Ref. No.	65010870 65010890 65011610 LA65011610 LAR65010870 LAR65010890 LAR65011610
description	heating element 12000W 230V heating circuits 3 L 520mm W 255mm H 135mm H1 100mm H2 30mm flange length 100mm flange width 72mm hole distance 85mm connection M4 connection length 40mm tube ø 8.5mm convection heating element hole ø 6.5mm rectangular flange		
For models:	ME210L, ME210S, ME210T, ME220L, ME220S, ME220T, MG210L, MG210S, VE210L, VE210S, VE210T		



1

Part No.	418194	Ref. No.	65010880 65010900 65011620 LA65011620 LAR65010880 LAR65010900 LAR65011620
description	heating element 12000W 230V heating circuits 3 L 540mm W 260mm H 135mm H1 100mm H2 35mm flange length 100mm flange width 82mm hole distance 85mm connection M4 tube ø 8.5mm convection heating element hole ø 6mm rectangular flange		
For models:	ME210L, ME210S, ME210T, ME220L, ME220S, ME220T, MG210L, MG210S, VE210L, VE210S, VE210T		



1

Part No.	415828	Ref. No.	65011310 LAR65011310
description	heating element 15000W 230V heating circuits 3 ID ø 388mm ED ø 408mm L 428mm H 132mm L1 20mm W1 105mm H1 114mm H2 18mm flange length 140mm flange width 25mm hole distance 126mm connection M4 connection length 65mm tube ø 8.5mm convection heating element hole ø 6.3mm rectangular flange		
For models:	AVE10D, AVE10P, BPE084M, BPE084P, BPE104M, BPE104P, CE100M, EC110M, EC210M, EM010M+SC, EM110H, EM110M, EM110M+SC, EM110P, EM210H, EM210M, EM210M+SC, EM210P, EPE086T, EPE156T, EPEV08T, EPEV15T, EV110H, EV110M, EV110M+SC, EV110P, EV210H, EV210M, EV210M+SC, EV210P, GEMT10P, GEMT10T, GEMT20P, GEMT20T, GEMT21P, GEMT21T, GEMT40P, GEMT40T, GEVT10P, GEVT10T, GEVT20P, GEVT20T, GEVT21P, GEVT21T, GEVT40P, GEVT40T, HME101P, HME101T, HME101X, HME102P...(Other models you can see in the webshop)		





1

Part No.	418197	Ref. No.	65011250 LA65011250 LAR65011250
description	heating element 15000W 230V heating circuits 3 ID ø 512mm ED ø 530mm L 545mm H 130mm L1 15mm W1 105mm H1 25mm H2 105mm flange length 142mm flange width 25mm hole distance 126mm connection M4 connection length 68mm tube ø 8.5mm convection heating element hole ø 6mm rectangular flange		
For models:	EC210M, EM210H, EM210M, EM210M+SC, EM210P, EV210H, EV210M, EV210M+SC, EV210P, GEMT20P, GEMT20T, GEMT40P, GEMT40T, GEVT20P, GEVT20T, GEVT40P, GEVT40T, HME102P, HME102T, HME102X, HME202P, HME202T, HME202X, HVE102P, HVE102T, HVE102X, HVE202P, HVE202T, HVE202X, MCE202M, ME102D, ME102H, ME102M, ME102P, ME102T, ME202D, ME202H, ME202M, ME202P, ME202T, MEC24H, MEC40H, MEC40M, MEMT20D, MEMT20P, MEMT40D, MEMT40P, MEVT20D, MEVT20P, MEVT40D...(Other models you can see in the webshop)		

1 electric components





			
1			
Part No.	415251	Ref. No.	65010200 LA65010200 LAR65010200
description	heating element 2500W 230V heating circuits 1 ID ø 178mm ED ø 190mm L 242mm H 35mm L1 46mm W1 31mm H1 10mm H2 25mm flange length 70mm flange width 22mm hole distance 56mm connection male faston 6.3mm horizontal tube ø 6.3mm convection heating element hole ø 5mm rectangular flange		
For models:	AC, AU04, AU05, AU08, AU10, AU20, LA16, LV16		
spare parts for	415251		
	Part No.	510368	Ref. No. —
	gasket L 70mm W 23.5mm hole ø 5mm hole distance 56mm FIBER thickness 2mm for heating element		

			
1			
Part No.	415845	Ref. No.	65010280 65010300 65010320 A34300510 LA65010321 LAR65010280 LAR65010300 LAR65010320
description	heating element 3150W 230V heating circuits 3 ID ø 201mm ED ø 215mm L 272mm H 35mm L1 57mm W1 60mm H1 8mm H2 27mm flange length 95mm flange width 22mm hole distance 77mm connection male faston 6.3mm connection length 20mm tube ø 6.5mm convection heating element hole ø 6mm rectangular flange		
For models:	CE041M, CVE004H, CVE004M, MACE04M, MCE042M, ME004L, ME004S, MVE042P, RB142M, RC162M, RM262E, RM262M, VE004D, VE004H, VE004M, VE004S, VE004X, VE042P		

			
1			
Part No.	417721	Ref. No.	65010330 LA65010330
description	heating element 3150W 230V heating circuits 3 ID ø 204mm ED ø 216mm L 282mm H 42mm W1 83mm H2 29mm flange length 93mm flange width 22mm hole distance 77mm cable length 6.3mm hole ø 6mm		

			
1			
Part No.	415855	Ref. No.	65010430 65010431 65010440 65010441 65010450 LA65010450 LAR65010430 LAR65010431 LAR65010440 LAR65010441 LAR65010450
description	heating element 3900W 230V heating circuits 3 ID ø 176mm ED ø 244mm L 282mm H 43mm L1 38mm W1 61mm H1 13mm H2 30mm flange length 92mm flange width 22mm hole distance 78mm connection male faston 6.3mm connection length 60mm tube ø 6.3mm convection heating element hole ø 6.3mm rectangular flange		
For models:	CVE104H, CVE104M, ME104L, ME104S, VE104D, VE104H, VE104M, VE104S, VE104X		

			
1			
Part No.	419242	Ref. No.	LA65011670
description	heating element 5000W 230V heating circuits 3 ID ø 218mm ED ø 280mm L 300mm H 66mm L1 30mm H2 40mm flange length 141mm flange width 25mm hole distance 63mm connection length 64mm tube ø 6.3mm mounting thread M4		

			
1			
Part No.	415850	Ref. No.	50303810 LAR50303810
description	heating element 5400W 230V heating circuits 3 ID ø 191mm ED ø 204mm L 268mm H 84mm L1 57mm W1 103mm H1 17mm H2 67mm flange length 140mm flange width 23mm hole distance 63/63mm connection M4 tube ø 6.5mm		



			
1			
Part No.	418191	Ref. No.	50303560 65011500 65015830 LA65011500 LAR50303560 LAR65011500 LAR65015830
description	heating element 5400W 230V heating circuits 3 ID ø 194mm ED ø 205mm L 270mm H 85mm L1 65mm W1 103mm H1 20mm H2 65mm flange length 140mm flange width 22mm hole distance 62mm connection M4 connection length 65mm tube ø 6.5mm convection heating element hole ø 5mm rectangular flange		
For models:	FE05		

			
1			
Part No.	415871	Ref. No.	50303270 50303280 50303820 65010510 65010530 65011520 65015910 65015920 LA65011520 LAR50303270 LAR50303280 LAR50303820 LAR65010510 LAR65010530 LAR65011520 LAR65015910 LAR65015920
description	heating element 6000W 230V heating circuits 3 ID ø 217mm ED ø 230mm L 267mm H 75mm L1 38mm W1 103mm H1 65mm H2 10mm flange length 140mm flange width 23mm hole distance 67mm connection M4 connection length 25mm tube ø 6.5mm convection heating element hole ø 5mm rectangular flange		
For models:	CVE105H, CVE105M, ME05, ME105L, ME105S, MVE042P, RE05, VE042P, VE105D, VE105H, VE105M, VE105S, VE105X, VE155H, VE155M, VE155X		



			
1			
Part No.	418196	Ref. No.	65011530 LA65011530 LAR65011530
description	heating element 6000W 230V heating circuits 3 ID ø 215mm ED ø 228mm L 266mm H 78mm L1 38mm W1 102mm H1 10mm H2 68mm flange length 142mm flange width 25mm hole distance 57mm connection M4 connection length 66mm tube ø 6.3mm convection heating element hole ø 6mm rectangular flange		
For models:	A05PES, A05RES, A05RES+UM, A08RES, A08RES+UM, A10RES, A10RES+UM, BPE044M, BPE044P, BPE054M, BPE054P, CE051M, MACE05M, MCE051M, MVE051P, VE051P, VE055P		

			
1			
Part No.	420525	Ref. No.	65011730 LA65011730 LAR65011730
description	heating element 7000W 230V heating circuits 3 ID ø 248mm ED ø 260mm L 298mm H 87mm L1 10mm W1 102mm H1 15mm H2 66mm flange length 142mm flange width 25mm hole distance 127mm connection M4 tube ø 6.5mm		



			
1			
Part No.	415993	Ref. No.	50303580 50303830 65010680 65016010 65016020 LA65010680 LAR50303580 LAR50303830 LAR65010680 LAR65016010 LAR65016020
description	heating element 7200W 230V heating circuits 3 ID \varnothing 215mm ED \varnothing 230mm L 270mm H 78mm L1 30mm W1 102mm H1 10mm H2 68mm flange length 140mm flange width 22mm hole distance 63mm connection M4 connection length 65mm tube \varnothing 6.3mm convection heating element hole \varnothing 5mm rectangular flange		
For models:	FE105M, FE105X, PE040M, PE040X		

			
2			
Part No.	420527	Ref. No.	65011660 LA65011660 LAR65011660
description	heating element 7500W 230V heating circuits 3 ID \varnothing 224mm ED \varnothing 284mm L 302mm H 135mm L1 5mm W1 104mm H1 14mm H2 55mm flange length 140mm flange width 15mm hole distance 127mm connection M4 tube \varnothing 6.5mm hole \varnothing 6mm		

			
1			
Part No.	415829	Ref. No.	56010570 65010570 65010580 65011540 A34300700 LA65011541 LAR65010570 LAR65010580 LAR65011540
description	heating element 7500W 230V heating circuits 3 ID \varnothing 248mm ED \varnothing 260mm L 287mm H 88mm L1 20mm W1 105mm H1 23mm H2 65mm flange length 142mm flange width 25mm hole distance 64mm connection M4 connection length 78mm convection heating element hole \varnothing 5mm rectangular flange		
For models:	AVE07D, BPE064M, BPE064P, BPE074M, BPE074P, CE071M, EC106M, EM106H, EM106M, EM106M+SC, EM106P, EMT06D, EPE056T, EV006M, EV106H, EV106M, EV106M+SC, EV106P, GEMT06P, GEMT06T, GEVT06P, GEVT06T, HME061P, HME061T, HME061X, HVE061P, HVE061T, HVE061X, MACE07M, MCE071M, ME061D, ME061H, ME061M, ME061P, ME061T, ME106D, ME106H, ME106L, ME106M, ME106P, ME106S, ME106T, ME106X, MEMT06D, MEMT06P, MEVT06D, MEVT06P, MME071P, MVE071P, RB102S...(Other models you can see in the webshop)		
accessories for	415829		
	Part No.	531270	Ref. No. —
	gasket L 141mm W 22mm D1 \varnothing 10mm D2 \varnothing 9mm 9 holes graphite thickness 1mm suitable for UNOX		

			
1			
Part No.	418192	Ref. No.	65010620 65010640 65011590 LA65011590 LAR65010620 LAR65010640 LAR65011590
description	heating element 7500W 230V heating circuits 3 L 525mm W 250mm H 130mm H1 20mm H2 110mm flange length 100mm flange width 80mm hole distance 94mm connection M4 tube \varnothing 6.3mm convection heating element hole \varnothing 6.5mm rectangular flange		
For models:	ME110L, ME110S, ME110T, ME120L, ME120S, ME120T, PE015M, PE115K, VE110L, VE110S, VE110T, VE120L, VE120S		

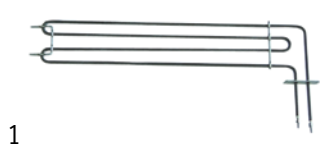

			
Part No.	418193	Ref. No.	65010610 65010630 65011580 LAR65010610 LAR65010630 LAR65011580
description	heating element 7500W 230V heating circuits 3 L 560mm W 255mm H 135mm H1 17mm H2 118mm flange length 100mm flange width 80mm hole distance 85mm connection M4 connection length 70mm tube ø 6.3mm convection heating element hole ø 6mm rectangular flange		
For models:	ME110L, ME110S, ME110T, ME120L, ME120S, ME120T, PE015M, PE108D, PE115K, VE110L, VE110S, VE110T, VE120L, VE120S		

			
Part No.	415387	Ref. No.	50303160 65010110 65015210 LAR50303160 LAR65010110 LAR65015210
description	heating element 1800W 230V heating circuits 1 L 534mm W 120mm L1 30mm L2 504mm W2 90mm flange length 70mm flange width 22mm hole distance 56mm connection M4 tube ø 6.3mm hole ø 5mm W1 30mm rectangular flange convection heating element windings 2		
For models:	ME15, PE12		

			
Part No.	419110	Ref. No.	65011900 LA65011900 LAR65011900
description	heating element 9000W 230V heating circuits 3 ID ø 250mm ED ø 266mm L 290mm H 93mm L1 24mm W1 105mm H1 11mm H2 82mm flange length 142mm flange width 25mm hole distance 63mm connection M4 tube ø 8.5mm hole ø 6.1mm		
For models:	MVE071M		

			
Part No.	415737	Ref. No.	50303150 50303860 65010130 65010140 65010141 65010180 65015300 65015310 LA65010180 LAR50303150 LAR50303860 LAR65010130 LAR65010140 LAR65010141 LAR65010180 LAR65015300 LAR65015310
description	heating element 2500W 230V heating circuits 1 L 655mm W 120mm L1 30mm L2 625mm W2 90mm flange length 70mm flange width 22mm hole distance 56mm connection length 100mm connection M4 tube ø 6.3mm hole ø 5.5mm W1 30mm rectangular flange convection heating element windings 2		
For models:	FE110M, FE110X, ME10, ME21, MME10, PE08, PE080M, PE080X, RE10		

			
Part No.	415827	Ref. No.	65011210 LAR65011210
description	heating element 9000W 230V heating circuits 3 ID ø 508mm ED ø 526mm L 550mm H 122mm L1 24mm W1 105mm H1 26mm H2 96mm flange length 140mm flange width 25mm hole distance 126mm connection M4 connection length 68mm tube ø 9mm convection heating element hole ø 6.3mm rectangular flange		
For models:	ME210D, ME210H, ME210M, ME210P, ME210X, ME220D, ME220H, ME220M, ME220P, ME220X, VE210D, VE210H, VE210M, VE210P, VE210X, VE220D, VE220H, VE220M, VE220P, VE220X		

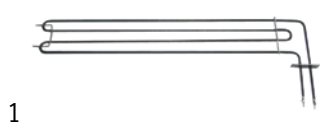
			
Part No.	415736	Ref. No.	50303170 65010371 65010390 65015660 65015670 LAR50303170 LAR65010371 LAR65010390 LAR65015660 LAR65015670
description	heating element 3500W 230V heating circuits 1 L 655mm W 125mm L1 30mm L2 625mm W2 88mm flange length 70mm flange width 22mm hole distance 56mm connection length 97mm connection M4 tube ø 6.25mm hole ø 5mm W1 30mm rectangular flange convection heating element windings 2 mounting distance 58mm		
For models:	FE210M, ME20, ME24, ME40, MG20, MME40, RE20, RE24		



energy regulators

EGO

1-circuit



Part No.	380015	Ref. No.	50304011 65080250 LA65080250 LAR50304011 LAR65080250
description	energy regulator 230V 13A single-circuit turn direction right shaft ø 6x4.6mm shaft L 23mm mounting thread M4 power release 6-100% no. 50.57021.010		
For models:	CGC40M, FE05, FG05, PE08, PE12, PG04, PG08, PG12, RE05, RE07, RE10, RE20, RE24, RG05, RG07, RG10, RG20, RG24, RG40		

thermostats

control and safety thermostats

EGO

control thermostats

55.10/19_ series



Part No.	390068	Ref. No.	50304031 LAR50304031
description	thermostat t.max. 269°C temperature range 55-269°C 1-pole 1CO 16A probe ø 3.1mm probe L 219mm capillary pipe 1280mm capillary pipe isolated 1270mm gland nut shaft ø 6x4.6mm shaft L 23mm shaft position upper° rotation 318°		
For models:	FE05, FG05, MME10, MME40, PE08, PE12, PG04, PG08, PG12, RE05, RE07, RE10, RE20, RE24, RG05, RG07, RG10, RG20, RG24, RG40		



Part No.	375216	Ref. No.	50304030 65070210 65070250 LA65070210 LAR65070210 LAR65070250
description	thermostat t.max. 280°C temperature range 50-280°C 1-pole 1NO 16A probe ø 3mm probe L 228mm capillary pipe 1300mm capillary pipe isolated 1150mm gland nut shaft L 23mm shaft position upper rotation 318°		
For models:	CGC24M, CGC40M, CVE004M, CVE104M, CVE105M, CVG105M, EC106M, EC110M, EC210M, EM010M+SC, EM106M, EM106M+SC, EM110M, EM110M+SC, EM210M, EM210M+SC, EV006M, EV106M, EV106M+SC, EV110M, EV110M+SC, EV210M, EV210M+SC, FE105M, FE105X, FE110M, FE110X, FE210M, FG051M, FG051X, FG101M, FG101X, FG105M, FG105X, FG110M, FG110X, FG210M, FG210X, GC106M, GC110M, GC210M, GM106M, GM106M+SC, GM110M, GM110M+SC, GM210M, GM210M+SC, GV106M, GV106M+SC, GV110M...(Other models you can see in the webshop)		



Part No.	375667	Ref. No.	65070360 LA65070360 LAR65070360
description	thermostat t.max. 300°C temperature range 68-300°C 1-pole 1NO 16A probe ø 3.1mm probe L 226mm capillary pipe 980mm capillary pipe isolated 980mm gland nut shaft ø 6x4.6mm shaft L 23mm shaft position upper rotation 318°		
For models:	ACG10M, BPE044M, BPE054M, BPE064M, BPE074M, BPE084M, BPE104M, BPG044M, BPG054M, BPG064M, BPG074M, BPG084M, BPG104M, CE041M, CE051M, CE071M, CE100M, CE200M, CG051M, CG071M, CG100M, CG200M, MACE04M, MACE05M, MACE07M, MACE10M, MACE20M, MACG05M, MACG07M, MACG10M, MACG20M, MCE042M, MCE051M, MCE071M, MCE101M, MCE102M, MCE201M, MCE202M, MCG051M, MCG071M, MCG101M, MCG102M, MCG201M, MCG202M, ME061M, ME101M, ME102M, ME201M, ME202M, MGO61M...(Other models you can see in the webshop)		





Part No.	375002	Ref. No.	1037102300
description	thermostat t.max. 320°C temperature range 55-320°C 1-pole 1N0 16A probe ø 3.1mm probe L 226mm capillary pipe 870mm capillary pipe isolated 850mm gland nut shaft L 23mm shaft position upper rotation 270°		



Part No.	375215	Ref. No.	65070165 LA65070165 LAR65070165
description	thermostat t.max. 65°C temperature range fixed 65°C 1-pole 1CO 16A probe ø 6mm probe L 130mm capillary pipe 900mm capillary pipe isolated 900mm gland nut shaft Lmm shaft position		
For models:	BPE064M, BPE074M, BPE084M, BPE104M, BPG064M, BPG074M, BPG084M, BPG104M, CVE004M, CVE104M, CVE105M, CVG105M, EM010M+SC, EM106M, EM106M+SC, EM110M, EM110M+SC, EM210M, EM210M+SC, EV006M, EV106M, EV106M+SC, EV110M, EV110M+SC, EV210M, EV210M+SC, GM106M, GM106M+SC, GM110M, GM110M+SC, GM210M, GM210M+SC, GV106M, GV106M+SC, GV110M, GV110M+SC, GV210M, GV210M+SC, ME061M, ME101M, ME102D, ME102M, ME106L, ME106M, ME106S, ME106X, ME110L, ME110M, ME110S, ME110X...(Other models you can see in the webshop)		



Part No.	375219	Ref. No.	65070100 LAR65070100
description	thermostat t.max. 55°C temperature range fixed 55°C 1-pole 1N0 16A probe ø 6mm probe L 130mm capillary pipe 900mm capillary pipe isolated 850mm gland nut shaft Lmm shaft position probe material SS		
For models:	EM010M+SC, EM106M, EM106M+SC, EM110M, EM110M+SC, EM210M, EM210M+SC, GM106M, GM106M+SC, GM110M, GM110M+SC, GM210M, GM210M+SC, ME061M, ME101M, ME102D, ME102M, ME106M, ME106X, ME110M, ME110X, ME120M, ME120X, ME201M, ME202M, ME210M, ME210X, ME220M, ME220X, ME C20X, MEC40M, MG061M, MG101M, MG102M, MG106M, MG106X, MG110M, MG110X, MG120M, MG120X, MG201M, MG202M, MG210M, MG210X, MG220M, MG220X, MGC20X		
accessories for	375219		
	Part No.	550148	Ref. No. —
	gland duct ET M12x0.75 IT M9x1 probe ø max. 6.5mm WS 17 silicone		



Part No.	375217	Ref. No.	65070240 65074990 LAR65070240 LAR65074990
description	thermostat t.max. 70°C temperature range fixed 70°C 1-pole 1CO 16A probe ø 6mm probe L 130mm capillary pipe 900mm capillary pipe isolated 900mm gland nut shaft Lmm shaft position probe material SS		
For models:	BPE064M, BPE074M, BPE084M, BPE104M, BPG064M, BPG074M, BPG084M, BPG104M, CVE004M, CVE104M, CVE105M, CVG105M, EM010M+SC, EM106M, EM106M+SC, EM110M, EM110M+SC, EM210M, EM210M+SC, EV006M, EV106M, EV106M+SC, EV110M, EV110M+SC, EV210M, EV210M+SC, GM106M, GM106M+SC, GM110M, GM110M+SC, GM210M, GM210M+SC, GV106M, GV106M+SC, GV110M, GV110M+SC, GV210M, GV210M+SC, ME061M, ME101M, ME102D, ME102M, ME106L, ME106M, ME106S, ME106X, ME110L, ME110M, ME110S, ME110X...(Other models you can see in the webshop)		



E-G-O



Part No.	390807	Ref. No.	65070140 LAR65070140
description	thermostat temperature range 30-110°C 1-pole probe ø 6mm probe L 139mm capillary pipe 3000mm capillary pipe isolated 2950mm gland nut shaft ø 6x4.6mm shaft L 24mm rotation 270°		

55.13_ series

E-G-O



Part No.	375505	Ref. No.	LA65070400
description	thermostat t.max. 320°C temperature range 50-320°C 1-pole 1NO 16A probe ø 3mm probe L 160mm capillary pipe 870mm capillary pipe isolatedmm gland nut shaft ø 6x4.6mm shaft L 23mm shaft position upper rotation 270°		

55.14_ series

E-G-O



Part No.	375874	Ref. No.	MA1037117700
description	thermostat t.max. 90°C temperature range 30-90°C 1-pole 1NO 16A probe ø 6mm probe L 74mm capillary pipe 900mm capillary pipe isolated 800mm gland nut M10x1 shaft ø 6x4.6mm shaft L 23mm shaft position 180° shaft position rotation 270°		

55.34_ series

E-G-O



Part No.	390073	Ref. No.	50304050 50304052 65075070 LAR50304050 LAR50304052 LAR65075070
description	thermostat t.max. 145°C temperature range 85°C/145°C 2-pole 2NC 16A probe ø 6mm probe L 130mm capillary pipe 900mm capillary pipe isolated 900mm gland nut probe material SS		
For models:	FV03, FV06, ME05, ME10, ME15, ME20, ME21, ME24, ME40, MG05, MG10, MG15, MG20, MG21, MG24, MG40, MME10, MME40		

E-G-O

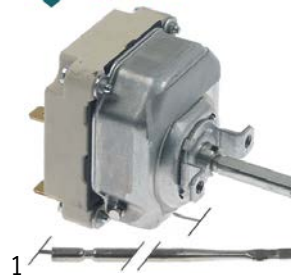

Part No.	375192	Ref. No.	1309115
description	thermostat t.max. 300°C temperature range 50-300°C 3-pole 3NO 16A probe ø 3mm probe L 219mm capillary pipe 900mm capillary pipe isolatedmm gland nut shaft ø 6x4.6mm shaft L 23mm shaft position upper rotation 270°		

E-G-O

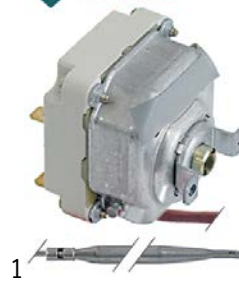

Part No.	375669	Ref. No.	65075010 LAR65075010
description	thermostat t.max. 90°C temperature range fixed 75/90°C 2-pole 2CO 16A probe ø 6mm probe L 130mm capillary pipe 900mm capillary pipe isolated 900mm gland nut		
For models:	ME004L, ME004S, ME104L, ME104S, ME105L, ME105S, ME120L, ME120S, MG105L, MG105S		



safety thermostats

55.10/19_ series

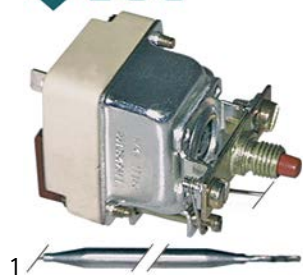

Part No.	375218	Ref. No.	50304097 65075020 LAR65075020
description	safety thermostat switch-off temp. 145°C 1-pole 16A probe ø 6mm probe L 130mm capillary pipe 900mm capillary pipe isolated 900mm gland nut probe SS		
For models:	ME004L, ME004S, ME104L, ME104S, ME105L, ME105S, ME106L, ME106S, ME110L, ME110S, ME120L, ME120S, ME210L, ME210S, ME220L, ME220S, MG105L, MG105S, MG106L, MG106S, MG110L, MG110S, MG120L, MG120S, MG210L, MG210S, MG220L, MG220S		

55.32_ series



Part No.	375668	Ref. No.	65070020 65075030 LAR65070020 LAR65075030
description	safety thermostat switch-off temp. 140°C 3-pole 20A probe ø 6mm probe L 88mm capillary pipe 890mm capillary pipe isolated 800mm gland nut		
For models:	AC, AU04, AU05, AU08, AU10, AU20, ME004L, ME004S, ME104L, ME104S		

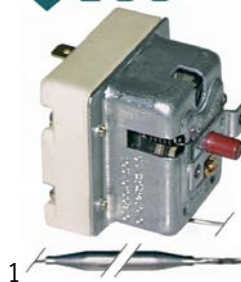

Part No.	390159	Ref. No.	65070080 65070081 65075000 LAR65070080 LAR65070081 LAR65075000
description	safety thermostat switch-off temp. 150°C 1-pole 20A probe ø 6mm probe L 89mm capillary pipe 900mm capillary pipe isolated 800mm gland nut probe		
For models:	EM010M+SC, EM106H, EM106M, EM106M+SC, EM106P, EM110H, EM110M, EM110M+SC, EM110P, EM210H, EM210M, EM210M+SC, EM210P, EMT06D, GEMT06P, GEMT06T, GEMT10P, GEMT10T, GEMT20P, GEMT20T, GEMT21P, GEMT21T, GEMT40P, GEMT40T, GGMT06P, GGMT06T, GGMT10P, GGMT10T, GGMT20P, GGMT20T, GGMT21P, GGMT21T, GGMT40P, GGMT40T, GM106H, GM106M, GM106M+SC, GM106P, GM110H, GM110M, GM110M+SC, GM110P, GM210H, GM210M, GM210M+SC, GM210P, GMT06D, GMT20D, GMT20P, HME061P...(Other models you can see in the webshop)		



Part No.	375220	Ref. No.	65070050 LAR65070050
description	safety thermostat switch-off temp. 330°C 3-pole 20A probe ø 11mm probe L 18.5mm capillary pipe 900mm capillary pipe isolated 900mm gland nut probe screw-in probe probe thread M14x1		
For models:	CVE004H, CVE004M, CVE104H, CVE104M, ME004L, ME004S, ME104L, ME104S, VE004D, VE004H, VE004M, VE004S, VE004X, VE104D, VE104H, VE104M, VE104S, VE104X		

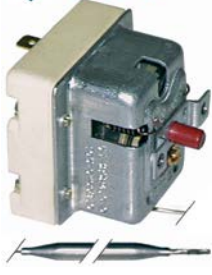

			
			
1			
Part No.	375291	Ref. No.	50304092 65070040 65070060 65075040 A34100780 LA65070060 LAR50304092 LAR65070060 LAR65075040
description	safety thermostat switch-off temp. 344°C 1-pole 20A probe ø 6mm probe L 79mm capillary pipe 900mm capillary pipe isolated 900mm gland nut probe		
For models:	FE105M, FE105X, FE110M, FE110X, FE210M, FG051M, FG051X, FG101M, FG101X, FG105M, FG105X, FG110M, FG110X, FG210M, FG210X, ME05, ME10, ME15, ME20, ME21, ME24, ME40, MG05, MG10, MG15, MG20, MG21, MG24, MG40, MME10, MME40, PE04, PE040M, PE040X, PE08, PE080M, PE080X, PE115K, PE12, PG04, PG040M, PG040X, PG041M, PG041X, PG051X, PG08, PG080M, PG080X, PG081M, PG081X...(Other models you can see in the webshop)		

			
			
2			
Part No.	375455	Ref. No.	65070070 LA65070070 LAR65070070
description	safety thermostat switch-off temp. 350°C 1-pole 16A probe ø 11mm probe L 16mm capillary pipe 900mm capillary pipe isolated 900mm gland nut probe screw-in probe probe thread M14x1		
For models:	CGC24M, CGC40M, CVE105H, CVE105M, CVG105H, CVG105M, EC106M, EC110M, EC210M, EM010M+SC, EM106H, EM106M, EM106M+SC, EM106P, EM110H, EM110M, EM110M+SC, EM110P, EM210H, EM210M, EM210M+SC, EM210P, EV006M, EV106H, EV106M, EV106M+SC, EV106P, EV110H, EV110M, EV110M+SC, EV110P, EV210H, EV210M, EV210M+SC, EV210P, GC106M, GC110M, GC210M, GM106H, GM106M, GM106M+SC, GM106P, GM110H, GM110M, GM110M+SC, GM110P, GM210H, GM210M, GM210M+SC, GM210P...(Other models you can see in the webshop)		

			
			
1			
Part No.	375684	Ref. No.	65070350 LA65070350 LAR65070350
description	safety thermostat switch-off temp. 360°C 1-pole 20A probe ø 11mm probe L 16mm capillary pipe 900mm capillary pipe isolated 900mm gland nut probe screw-in probe probe thread M14x1		
For models:	ACG10M, AVE07D, AVE10D, AVE10P, BPE044M, BPE044P, BPE054M, BPE054P, BPE064M, BPE064P, BPE074M, BPE074P, BPE084M, BPE084P, BPE104M, BPE104P, BPG044M, BPG044P, BPG054M, BPG054P, BPG064M, BPG064P, BPG074M, BPG074P, BPG084M, BPG084P, BPG104M, BPG104P, CE041M, CE051M, CE071M, CE100M, CE200M, CG051M, CG071M, CG100M, CG200M, EMT06D, EPE056T, EPE086T, EPE156T, EPEV05T, EPEV08T, EPEV15T, EPG056T, EPG086T, EPG156T, EPGV05T, EPGV08T, EPGV15T...(Other models you can see in the webshop)		

			
			
1			
Part No.	390808	Ref. No.	65070340 LAR65070340
description	safety thermostat switch-off temp. 360°C 3-pole probe ø 4mm probe L 124mm capillary pipe 900mm capillary pipe isolated 900mm gland nut		
For models:	EPEV05T, EPEV08T, EPEV15T, EPGV05T, EPGV08T, EPGV15T		

control thermostats with operation switch

55.10/19_ series

			
			
1			
Part No.	375180	Ref. No.	0109170 CR0589660 SIRO109170
description	thermostat t.max. 185°C temperature range 99-185°C 1-pole 1NO 0.5A probe ø 4mm probe L 235mm capillary pipe 870mm capillary pipe isolated 700mm gland nut shaft ø 6x4.6mm shaft L 23mm shaft position rotation 270° outer switch 2NO		







CAEM			
safety thermostats			
			
Part No.	391038	Ref. No.	65070410 65070460 LA65070460 LAR65070410 LAR65070460
description	thermostat switch-off temp. 360°C temperature range°C 1-pole 1NC 10A probe ø 3mm probe L 150mm capillary pipe 1050mm capillary pipe isolatedmm gland nut shaft ømm SS		
For models:	A05PES, A05RES, A05RES+UM, A08RES, A08RES+UM, A10RES, A10RES+UM		



accessories			
connecting bows			
			
Part No.	550060	Ref. No.	921200
description	connecting bow long for thermostat Qty 1 pcs		

switches and momentary switches

rocker/momentary rocker switches			
30x22mm			
			
Part No.	301036	Ref. No.	9410001
description	protective cover internal size 30x22mm for rocker switch mounting measurementsmm		

blank			
			
Part No.	347706	Ref. No.	65260510 LAR65260510
description	momentary rocker switch mounting measurements 30x22mm black 2CO 250V 16A connection male faston 6.3mm ambient temperature max. 100/55°C protection IP65 with cover cap		
For models:	EC106M, EC110M, EC210M, EM010M+SC, EM106M, EM106M+SC, EM110M, EM110M+SC, EM210M, EM210M+SC, EV006M, EV106M, EV106M+SC, EV110M, EV110M+SC, EV210M, EV210M+SC, FE105M, FE105X, FE110M, FE110X, FE210M, FG051M, FG051X, FG101M, FG101X, FG105M, FG105X, FG110M, FG110X, FG210M, FG210X, GC106M, GC110M, GC210M, GM106M, GM106M+SC, GM110M, GM110M+SC, GM210M, GM210M+SC, GV106M, GV106M+SC, GV110M, GV110M+SC, GV210M, GV210M+SC, PE040M, PE040X, PE080M...(Other models you can see in the webshop)		
accessories for	347706	Part No.	301036
		Ref. No.	9410001
	 protective cover internal size 30x22mm for rocker switch mounting measurementsmm		

labelled			
			
Part No.	301200	Ref. No.	65260050 LAR65260050
description	rocker switch mounting measurements 30x22mm black 2NO 230V 16A 0-1 connection male faston 6.3mm ambient temperature max. 85°C protection IP65 with cover cap		
For models:	AC, AU04, AU05, AU08, AU10, AU20, EC106M, EC110M, EC210M, EM106M, EM110M, EM210M, EV006M, EV106M, EV110M, EV210M, FE105X, FG051X, FG101X, FG105X, FG110X, FG210X, GC106M, GC110M, GC210M, GM106M, GM110M, GM210M, GV106M, GV110M, GV210M, PE040X, PG040X, PG041X, PG051X, PG080X, PG081X, PG101X		
accessories for	301200	Part No.	301036
		Ref. No.	9410001
	 protective cover internal size 30x22mm for rocker switch mounting measurementsmm		

			
Part No.	300125	Ref. No.	4640500 50304671 941003 LAR50304671
description	rocker switch mounting measurements 30x22mm green 2NO 230V 16A 0-1 connection male faston 6.3mm ambient temperature max. 125/55°C protection IP65 with cover cap		
For models:	FV03, FV06, ME05, ME10, ME15, ME20, ME21, ME24, ME40, MG05, MG10, MG15, MG20, MG21, MG24, MG40, PE04		
accessories for	300125	Part No.	301036
		Ref. No.	9410001
	 protective cover internal size 30x22mm for rocker switch mounting measurementsmm		



with symbol



1

Part No.	301228	Ref. No.	50304650 65260210 LAR50304650 LAR65260210
description	rocker switch mounting measurements 30x22mm black 2CO 250V 16A I-II connection male faston 6.3mm ambient temperature max. 125/55°C protection IP65 with cover cap		
For models:	FE105X, FG051X, FG101X, FG105X, FG110X, FG210X, ME05, ME10, ME15, ME20, ME21, ME24, ME40, MG05, MG10, MG15, MG20, MG21, MG24, MG40, MME10, MME40, PE04, PE040X, PE08, PE12, PG040X, PG041X, PG051X, PG080X, PG081X, PG101X, RE05, RE07, RE10, RE20, RE24, RG05, RG10, RG20, RG24, RG40		
accessories for	301228		
	Part No.	301036	Ref. No. 9410001
	protective cover internal size 30x22mm for rocker switch mounting measurementsmm		

push/momentary push switches

30x22mm



1

Part No.	301036	Ref. No.	9410001
description	protective cover internal size 30x22mm for rocker switch mounting measurementsmm		

ø16mm



1

Part No.	301172	Ref. No.	65260610 LAR65260610
description	momentary push switch mounting ø 16mm black 1NO 250V 16A connection male faston 6.3mm protection IP40 ambient temperature max. 150°C		
For models:	ACG10M, BPE044M, BPE054M, BPE064M, BPE074M, BPE084M, BPE104M, BPG044M, BPG054M, BPG064M, BPG074M, BPG084M, BPG104M, CE041M, CE051M, CE071M, CE100M, CE200M, CG051M, CG071M, CG100M, CG200M, MACE04M, MACE05M, MACE07M, MACE10M, MACE20M, MACG05M, MACG07M, MACG10M, MACG20M, MCE042M, MCE051M, MCE071M, MCE101M, MCE102M, MCE201M, MCE202M, MCG051M, MCG071M, MCG101M, MCG102M, MCG201M, MCG202M, ME061M, ME101M, ME102M, ME201M, ME202M, MG061M...(Other models you can see in the webshop)		



1

Part No.	346287 ¹	Ref. No.	65260480 LAR65260480
description	momentary push switch mounting ø 16mm red 1NO 250V 3A illuminated connection male faston 2.8mm ambient temperature max. 125/55°C protection IP65 with cover cap		
For models:	FG051M, FG051X, FG101M, FG101X, GC106M, GC110M, GC210M, GM106H, GM106M, GM106M+SC, GM106P, GM110H, GM110M, GM110M+SC, GM110P, GM210H, GM210M, GM210M+SC, GM210P, GV106H, GV106M, GV106M+SC, GV106P, GV110H, GV110M, GV-110M+SC, GV110P, GV210H, GV210M, GV210M+SC, GV210P, PG041M, PG041X, PG051X, PG081M, PG081X, PG101M, PG101X		

¹illuminated

1

Part No.	301227	Ref. No.	65260120 65260600 LAR65260120 LAR65260600
description	push switch mounting ø 16mm black 1NO 250V 16A connection male faston 6.3mm protection IP40 ambient temperature max. 150°C		
For models:	ACG10M, BPE044M, BPE054M, BPE064M, BPE074M, BPE084M, BPE104M, BPG044M, BPG054M, BPG064M, BPG074M, BPG084M, BPG104M, CE041M, CE051M, CE071M, CE100M, CE200M, CG051M, CG071M, CG100M, CG200M, CGC24M, CGC40M, MACE04M, MACE05M, MACE07M, MACE10M, MACE20M, MACG05M, MACG07M, MACG10M, MACG20M, MCE042M, MCE051M, MCE071M, MCE101M, MCE102M, MCE201M, MCE202M, MCG051M, MCG071M, MCG101M, MCG102M, MCG201M, MCG202M, ME061M, ME101M, ME102M, ME201M...(Other models you can see in the webshop)		

ø25mm



1

Part No.	348211	Ref. No.	65260500 LAR65260500
description	push switch mounting ø 25mm red 1NO/indicator light 250V 16A illuminated connection male faston 6.3mm ambient temperature max. 85°C protection IP65 with cover		
For models:	VG105S, VG106L, VG106S, VG106T, VG110L, VG110S, VG110T, VG210L, VG210S, VG210T		

microswitches

lever actuated





1

Part No.	345254	Ref. No.	1037111300
description	microswitch with lever 250V 16A 1CO connection male faston 6.3mm ambient temperature max. 120°C mounting distance 22mm actuating force: 60g lever length 58mm		



pin-plunger actuated			
			
Part No.	348212	Ref. No.	65260900 LAR65260900 LAR65260900K
description	microswitch kit 250V 6A for combi-steamer		

M10			
			
Part No.	345032	Ref. No.	65260540 LAR65260540
description	microswitch with plunger thread M10x1 thread L 12mm 250V 16A 1CO connection male faston 6.3mm stroke 7mm mounting distance 22mm L 28mm ambient temperature max. 125°C type SP9603 actuating force: 180g		
For models:	A05PES, A05RES, A05RES+UM, A08RES, A08RES+UM, A10RES, A10RES+UM, ACG10M, AVE07D, AVE10D, AVE10P, BPE044M, BPE044P, BPE054M, BPE054P, BPE064M, BPE064P, BPE074M, BPE074P, BPE084M, BPE084P, BPE104M, BPE104P, BPG044M, BPG044P, BPG054M, BPG054P, BPG064M, BPG064P, BPG074M, BPG074P, BPG084M, BPG084P, BPG104M, BPG104P, CE041M, CE051M, CE071M, CE100M, CE200M, CG051M, CG071M, CG100M, CG200M, EC106M, EC110M, EC210M, EM010M+SC, EM106H, EM106M...(Other models you can see in the webshop)		

M12			
			
Part No.	345350	Ref. No.	50304530 65260530 LAR50304530 LAR65260530 LAR65260540
description	microswitch with plunger mounting distance 22mm thread M12x0.75 thread L 16mm 250V 16A 1CO connection male faston 6.3mm stroke 4mm ambient temperature max. 125°C type EF83161.3 actuating force: 66g		
For models:	CVE004H, CVE004M, CVE104H, CVE104M, CVE105H, CVE105M, CVG105H, CVG105M, FE05, FG05, FV03, FV06, ME004L, ME004S, ME05, ME10, ME104L, ME104S, ME105L, ME105S, ME15, ME20, ME21, ME24, ME40, MG05, MG10, MG105L, MG105S, MG15, MG20, MG21, MG24, MG40, PE005K, PE04, PE08, PE108D, PE12, PG04, PG08, PG12, RE05, RE07, RE10, RE20, RE24, RG05, RG07, RG10...(Other models you can see in the webshop)		
accessories for	345350		
		Part No.	345351 Ref. No. —
	nut thread M12x0.75 H 1.6mm WS 14 chrome-plated brass Qty 1 pcs		

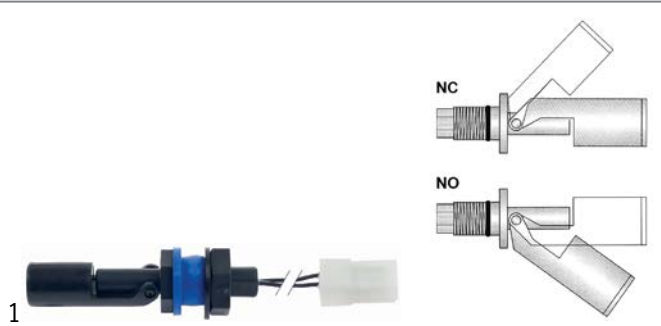
float switches			
			
Part No.	348166	Ref. No.	65260910 LAR65260910 LAR65260910
description	float switch thread M16x1.5 1NO or 1NC ø 16mm L 88mm mounting ø 16mm 250V 1A cable cable length 520mm with gasket and nut		

cam switches			
4 operating positions			
			
Part No.	300010	Ref. No.	50304020 65080010 LAR65080010 LAR50304020 LAR65080010
description	cam switch 4 operating positions 2NO/2CO sequence 0-1-2-3 16A shaft ø 6x4.6mm shaft L 23mm connection male faston 6.3mm ceramic		
For models:	ACG10M, BPE044M, BPE054M, BPE064M, BPE074M, BPE084M, BPE104M, BPG044M, BPG054M, BPG064M, BPG074M, BPG084M, BPG104M, CE041M, CE051M, CE071M, CE100M, CE200M, CG051M, CG071M, CG100M, CG200M, CGC40M, EC106M, EC110M, EC210M, FE05, FE105M, FE105X, FE110M, FE110X, FE210M, FG05, FG051M, FG051X, FG101M, FG101X, FG105M, FG105X, FG110M, FG110X, FG210M, FG210X, GC106M, GC110M, GC210M, MACE04M, MACE05M, MACE07M, MACE10M...(Other models you can see in the webshop)		

			
Part No.	300239	Ref. No.	CR0581810
description	operation switch 4 operating positions 4NO sequence 0-1-2-3 16A shaft ø 6x4.6mm shaft L 23mm connection male faston 6.3mm plastic		



5 operating positions

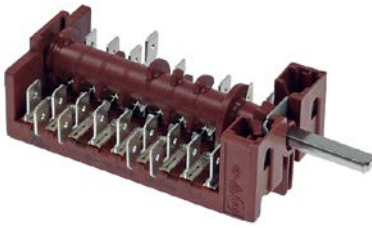

1

Part No.	347191	Ref. No.	65080020 LA65080020 LAR65080020
description	cam switch 5 operating positions 9NO sequence 1-0-2-3-4 16A shaft \varnothing 6x4.6mm shaft L 23mm connection male faston 6.3mm plastic		
For models:	CGC24M, CVE004M, CVE104M, CVE105M, CVG105M, EM010M+SC, EM106M, EM106M+SC, EM110M, EM110M+SC, EM210M, EM210M+SC, EV006M, EV106M, EV106M+SC, EV110M, EV110M+SC, EV210M, EV210M+SC, GM106M, GM106M+SC, GM110M, GM110M+SC, GM210M, GM210M+SC, GV106M, GV106M+SC, GV110M, GV110M+SC, GV210M, GV210M+SC, ME004L, ME004S, ME061M, ME101M, ME102M, ME104L, ME104S, ME105L, ME105S, ME106M, ME106S, ME106X, ME110M, ME110S, ME110X, ME120M, ME120S, ME120X, ME201M...(Other models you can see in the webshop)		

8 operating positions

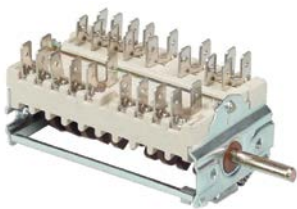

1

Part No.	301225	Ref. No.	65080060 LA65080060 LAR65080060
description	cam switch 8 operating positions sequence 0-1-2-3-4-5-6-7 shaft \varnothing 6x4.6mm connection male faston 8-pole		
For models:	ME106L, ME110L, ME120L, ME210L, ME220L, MG106L, MG110L, MG120L, MG210L, MG220L		

operation switches



1

Part No.	300002	Ref. No.	6046001
description	cam switch 2 operating positions 4NO 16A sequence 0-1 shaft \varnothing 6x4.6mm shaft L 23mm connection male faston 6.3mm ceramic		



1

Part No.	300080	Ref. No.	710300
description	cam switch 2 operating positions 4NO 16A sequence 0-1 shaft \varnothing 6x4.6mm shaft L 23mm connection screw operation switch ceramic ambient temperature max. 150°C		
accessories for	300080		
	Part No.	551456	Ref. No. —
gasket for switch ED \varnothing 14mm ID \varnothing 2.5mm thickness 3.5mm white			

touch sensitive light switches



1

Part No.	346388	Ref. No.	65260750 LAR65260750
description	touch sensitive light switch 1NOVA for combi-steamer L 47mm W 20mm H 30mm		
For models:	ACG10M, AVE07D, AVE10D, AVE10P, BPE064M, BPE064P, BPE074M, BPE074P, BPE084M, BPE084P, BPE104M, BPE104P, BPG064M, BPG064P, BPG074M, BPG074P, BPG084M, BPG084P, BPG104M, BPG104P, CE071M, CE100M, CE200M, CG071M, CG100M, CG200M, EMT06D, EPE056T, EPE086T, EPE156T, EPEV05T, EPEV08T, EPEV15T, EPG056T, EPG086T, EPG156T, EPGV05T, EPGV08T, EPGV15T, GEMT06P, GEMT06T, GEMT10P, GEMT10T, GEMT20P, GEMT20T, GEMT21P, GEMT21T, GEMT40P, GEMT40T, GEVT06P...(Other models you can see in the webshop)		

magnetic switches

37x16mm



1

Part No.	347790	Ref. No.	65265100 LAR65265100
description	magnetic switch L 37mm W 16mm 1NO 250V connection cable cable length 1960mm 10W with magnet nominal 0.04A		
For models:	CGC24M, CGC40M, EMT06D, EPE056T, EPE086T, EPE156T, EPEV05T, EPEV08T, EPEV15T, EPG056T, EPG086T, EPG156T, EPGV05T, EPGV08T, EPGV15T, GEMT06P, GEMT06T, GEMT10P, GEMT10T, GEMT20P, GEMT20T, GEMT21P, GEMT21T, GEMT40P, GEMT40T, GEVT06P, GEVT06T, GEVT10P, GEVT10T, GEVT20P, GEVT20T, GEVT21P, GEVT21T, GEVT40P, GEVT40T, GGMT06P, GGMT06T, GGMT10P, GGMT10T, GGMT20P, GGMT20T, GGMT21P, GGMT21T, GGMT40P, GGMT40T, GGVTO6P, GGVTO6T, GGVTO10P, GGVTO10T, GGVTO20P...(Other models you can see in the webshop)		

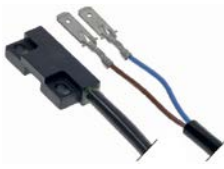

			
1			
Part No.	348209	Ref. No.	65260590 LA65260590 LAR65260590
description	magnetic switch L 37mm W 16mm 250V 0.04A connection male faston 6.3mm cable length 530mm		

miscellaneous			
			
1			
Part No.	401961	Ref. No.	66110300 LAR66110300
description	magnetic switch door contact		
For models:	ACG10M, AVE07D, AVE10D, AVE10P, BPE064M, BPE064P, BPE074M, BPE074P, BPE084M, BPE084P, BPE104M, BPE104P, BPG064M, BPG064P, BPG074M, BPG074P, BPG084M, BPG084P, BPG104M, BPG104P, CE071M, CE100M, CE200M, CG071M, CG100M, CG200M, EMT06D, EPE056T, EPE086T, EPE156T, EPEV05T, EPEV08T, EPEV15T, EPG056T, EPG086T, EPG156T, EPGV05T, EPGV08T, EPGV15T, GEMT06P, GEMT06T, GEMT10P, GEMT10T, GEMT20P, GEMT20T, GEMT21P, GEMT21T, GEMT40P, GEMT40T, GEVT06P...(Other models you can see in the webshop)		

control equipment

MOELLER/EATON

switches (complete)			
rotary switches			
			
1			
Part No.	346461	Ref. No.	65080150 LAR65080150
description	rotary switch mounting measurements ø22mm black latching 1NC/1NO sequence 0-1		
For models:	BPE064M, BPE074M, BPE084M, BPE104M, BPG064M, BPG074M, BPG084M, BPG104M, PG084, PG104M		

encoders and potentiometers

			
1			
Part No.	401338	Ref. No.	65301450 65321450 LAR65301450 LAR65321450
description	encoder		
For models:	AVE07D, AVE10D, AVE10P, BPE044P, BPE054P, BPE064P, BPE074P, BPE084P, BPE104P, BPG044P, BPG054P, BPG064P, BPG074P, BPG084P, BPG104P, EMT06D, EPE056T, EPE086T, EPE156T, EPEV05T, EPEV08T, EPEV15T, EPG056T, EPG086T, EPG156T, EPGV05T, EPGV08T, EPGV15T, GEMT06P, GEMT06T, GEMT10P, GEMT10T, GEMT20P, GEMT20T, GEMT21P, GEMT21T, GEMT40P, GEMT40T, GEVT06P, GEVT06T, GEVT10P, GEVT10T, GEVT20P, GEVT20T, GEVT21P, GEVT21T, GEVT40P, GEVT40T, GGMT06P, GGMT06T...(Other models you can see in the webshop)		

			
1			
Part No.	403835	Ref. No.	65302500 LA65302500
description	encoder rotation 360° shaft ø 6x4.6mm shaft L 26mm for combi-steamer cable length 600mm SS		

			
1			
Part No.	403084	Ref. No.	65301940 65301941 LA65301941 LAR65301940 LAR65301941
description	encoder shaft L 18mm cable length 200mm shaft 6x4.6mm		
For models:	HME061X, HME101X, HME102X, HME201X, HME202X, HMG061X, HMG101X, HMG102X, HMG201X, HMG202X, HVE061X, HVE101X, HVE102X, HVE201X, HVE202X, HVG061X, HVG101X, HVG102X, HVG201X, HVG202X		

lamps

indicator lights

indicator light lenses			
ø10mm (type SRZ-2)			
			
1			
Part No.	359358	Ref. No.	65270420 LAR65270420
description	indicator light housings mounting measurements ø10mm orange square		

indicator lights (complete)			
ø10mm			
with screw socket			
			
1			
Part No.	359378	Ref. No.	1037300810 MA1037300810
description	indicator light ø 10mm 230V green connection male faston 6.3mm socket screw base		

			
1			
Part No.	359379	Ref. No.	587500 CR0587500
description	indicator light ø 10mm 230V yellow connection male faston 6.3mm socket screw base		



with plug-in socket



1

Part No.	359140	Ref. No.	1037300910
description	indicator light ø 10mm yellow 230V connection male faston 6.3mm Qty 1 pcs		

ø12mm

with screw socket



1

Part No.	359026	Ref. No.	50304620 LAR50304620
description	indicator light ø 12mm 230V red connection male faston 6.3mm model CM/5		



1

Part No.	359027	Ref. No.	50304630 65270230 LAR50304630 LAR65270230
description	indicator light ø 12mm 250V green connection male faston 6.3mm		



1

Part No.	359291	Ref. No.	0101169 SI0101169 SIR0101169
description	indicator light ø 12mm 400V green connection male faston 6.3mm		



1

Part No.	359290	Ref. No.	0101167 65270220 LA65270220 LAR65270220 SIR0101167
description	indicator light ø 12mm 400V yellow connection male faston 6.3mm		
For models:	AC, AU04, AU05, AU08, AU10, AU20, CGC24M, CGC40M, CVE004M, CVE104M, CVE105M, CVG105M, EC106M, EC110M, EC210M, EM010M+SC, EM106M, EM106M+SC, EM110M, EM110M+SC, EM210M, EM210M+SC, EV006M, EV106M, EV106M+SC, EV110M, EV-110M+SC, EV210M, EV210M+SC, FE105M, FE105X, FE110M, FE110X, FE210M, FG051M, FG051X, FG101M, FG101X, FG105M, FG105X, FG110M, FG110X, FG210M, FG210X, GC106M, GC110M, GC210M, GM106M, GM106M+SC, GM110M...(Other models you can see in the webshop)		

ø16mm

with plug-in socket



1

Part No.	359788	Ref. No.	65270160 LAR65270160
description	indicator light ø 16mm 230V green connection male faston 6.3mm		
For models:	ACG10M, BPE044M, BPE054M, BPE064M, BPE074M, BPE084M, BPE104M, BPG044M, BPG054M, BPG064M, BPG074M, BPG084M, BPG104M, CE041M, CE051M, CE071M, CE100M, CE200M, CG051M, CG071M, CG100M, CG200M, MACE04M, MACE05M, MACE07M, MACE10M, MACE20M, MACG05M, MACG07M, MACG10M, MACG20M, MCE042M, MCE071M, MCE101M, MCE102M, MCE201M, MCE202M, MCG071M, MCG101M, MCG102M, MCG201M, MCG202M, ME061M, ME101M, ME102M, ME201M, ME202M, MG061M, MG101M, MG102M...(Other models you can see in the webshop)		



1

Part No.	359789	Ref. No.	65270150 LAR65270150
description	indicator light ø 16mm 230V yellow connection male faston 6.3mm		
For models:	ACG10M, BPE044M, BPE054M, BPE064M, BPE074M, BPE084M, BPE104M, BPG044M, BPG054M, BPG064M, BPG074M, BPG084M, BPG104M, CE041M, CE051M, CE071M, CE100M, CE200M, CG051M, CG071M, CG100M, CG200M, MACE04M, MACE05M, MACE07M, MACE10M, MACE20M, MACG05M, MACG07M, MACG10M, MACG20M, MCE042M, MCE071M, MCE101M, MCE102M, MCE201M, MCE202M, MCG071M, MCG101M, MCG102M, MCG201M, MCG202M, ME061M, ME101M, ME102M, ME201M, ME202M, MG061M, MG101M, MG102M...(Other models you can see in the webshop)		

screw-on/push-on fit

light bulbs

for ovens



1

Part No.	357153	Ref. No.	65270120 LAR65270120
description	light bulb t.max. 300°C socket E14 25W 230V ø 25mm L 55mm lens L 30mm for oven type		





halogen lamp			
for socket G4 / G6.35 / G9			
 <p>1 500°C</p>			
Part No.	359599	Ref. No.	50304520 65270020 LA65270020 LAR50304520 LAR65270020
description	halogen lamp socket G4 12V 20W temp.-resist. 500°C		
For models:	ACG10M, AVE07D, AVE10D, AVE10P, BPE064M, BPE064P, BPE074M, BPE074P, BPE084M, BPE084P, BPE104M, BPE104P, BPG064M, BPG064P, BPG074M, BPG074P, BPG084M, BPG084P, BPG104M, BPG104P, CE071M, CE100M, CE200M, CG071M, CG100M, CG200M, CGC24M, CGC40M, EC106M, EC110M, EC210M, EM010M+SC, EM106H, EM106M, EM106M+SC, EM106P, EM110H, EM110M, EM110M+SC, EM110P, EM210H, EM210M, EM210M+SC, EM210P, EMT06D, EPE056T, EPE086T, EPE156T, EPEV05T, EPEV08T...(Other models you can see in the webshop)		

 <p>2</p>			
Part No.	359946	Ref. No.	65270130 R65270130
description	halogen lamp socket G9 230V 40W temp.-resist. 300°C		

oven lamps

universal oven lamps			
55x70mm			
 <p>1</p>			
Part No.	357159	Ref. No.	65270500 LA65270500 LAR65270500
description	lamp socket socket E14 mounting measurements 55x70mm connection male faston 6.3mm Qty 1 pcs		
For models:	A05PES, A05RES, A08RES, A10RES		

 <p>1</p>			
Part No.	357159	Ref. No.	65270500 LA65270500 LAR65270500
description	lamp socket socket E14 mounting measurements 55x70mm connection male faston 6.3mm Qty 1 pcs		
For models:	A05PES, A05RES, A08RES, A10RES		



producer-specific oven lamps			
LAINOX			
 <p>1</p>			
Part No.	359672	Ref. No.	11401450 LA11401450 LAR11401450
description	frame		
For models:	ACG10M, AVE07D, AVE10D, AVE10P, BPE064M, BPE064P, BPE074M, BPE074P, BPE084M, BPE084P, BPE104M, BPE104P, BPG064M, BPG064P, BPG074M, BPG074P, BPG084M, BPG084P, BPG104M, BPG104P, CE071M, CE100M, CE200M, CG071M, CG100M, CG200M, EMT06D, EPE056T, EPE086T, EPE156T, EPEV05T, EPEV08T, EPEV15T, EPG056T, EPG086T, EPG156T, EPGV05T, EPGV08T, EPGV15T, GEMT06P, GEMT06T, GEMT10P, GEMT10T, GEMT20P, GEMT20T, GEMT21P, GEMT21T, GEMT40P, GEMT40T, GEVT06P...(Other models you can see in the webshop)		

 <p>1</p>			
Part No.	359671	Ref. No.	70044200 LA70044200 LAR70044200
description	gasket		
For models:	ACG10M, AVE07D, AVE10D, AVE10P, BPE064M, BPE064P, BPE074M, BPE074P, BPE084M, BPE084P, BPE104M, BPE104P, BPG064M, BPG064P, BPG074M, BPG074P, BPG084M, BPG084P, BPG104M, BPG104P, CE071M, CE100M, CE200M, CG071M, CG100M, CG200M, EMT06D, EPE056T, EPE086T, EPE156T, EPEV05T, EPEV08T, EPEV15T, EPG056T, EPG086T, EPG156T, EPGV05T, EPGV08T, EPGV15T, GEMT06P, GEMT06T, GEMT10P, GEMT10T, GEMT20P, GEMT20T, GEMT21P, GEMT21T, GEMT40P, GEMT40T, GEVT06P...(Other models you can see in the webshop)		

 <p>1</p>			
Part No.	359670	Ref. No.	71500150 LA71500150 LAR71500150
description	lamp glass L 105mm W 40mm thickness 4mm		
For models:	ACG10M, AVE07D, AVE10D, AVE10P, BPE064M, BPE064P, BPE074M, BPE074P, BPE084M, BPE084P, BPE104M, BPE104P, BPG064M, BPG064P, BPG074M, BPG074P, BPG084M, BPG084P, BPG104M, BPG104P, CE071M, CE100M, CE200M, CG071M, CG100M, CG200M, EMT06D, EPE056T, EPE086T, EPE156T, EPEV05T, EPEV08T, EPEV15T, EPG056T, EPG086T, EPG156T, EPGV05T, EPGV08T, EPGV15T, GEMT06P, GEMT06T, GEMT10P, GEMT10T, GEMT20P, GEMT20T, GEMT21P, GEMT21T, GEMT40P, GEMT40T, GEVT06P...(Other models you can see in the webshop)		



			
1			
Part No.	359674	Ref. No.	65270450 LA65270450 LAR65270450
description	lamp socket 24V socket G4 connection cable 100mm ømm H 16mm with 2 hole fixing mounting distance 20mm holder length 26mm Qty 1 pcs		
For models:	ACG10M, AVE07D, AVE10D, AVE10P, BPE064M, BPE064P, BPE074M, BPE074P, BPE084M, BPE084P, BPE104M, BPE104P, BPG064M, BPG064P, BPG074M, BPG074P, BPG084M, BPG084P, BPG104M, BPG104P, CE071M, CE100M, CE200M, CG071M, CG100M, CG200M, EMT06D, EPE056T, EPE086T, EPE156T, EPEV05T, EPEV08T, EPEV15T, EPG056T, EPG086T, EPG156T, EPGV05T, EPGV08T, EPGV15T, GEMT06P, GEMT06T, GEMT10P, GEMT10T, GEMT20P, GEMT20T, GEMT21P, GEMT21T, GEMT40P, GEMT40T, GEVTO6P...(Other models you can see in the webshop)		

			
2			
Part No.	359673	Ref. No.	11401440 LA11401440 LAR11401440
description	lamp socket socket G4 mounting measurements 37x103mm		
For models:	ACG10M, AVE07D, AVE10D, AVE10P, BPE064M, BPE064P, BPE074M, BPE074P, BPE084M, BPE084P, BPE104M, BPE104P, BPG064M, BPG064P, BPG074M, BPG074P, BPG084M, BPG084P, BPG104M, BPG104P, CE071M, CE100M, CE200M, CG071M, CG100M, CG200M, EMT06D, EPE056T, EPE086T, EPE156T, EPEV05T, EPEV08T, EPEV15T, EPG056T, EPG086T, EPG156T, EPGV05T, EPGV08T, EPGV15T, GEMT06P, GEMT06T, GEMT10P, GEMT10T, GEMT20P, GEMT20T, GEMT21P, GEMT21T, GEMT40P, GEMT40T, GEVTO6P...(Other models you can see in the webshop)		
spare parts for	359673		
	Part No.	359674	Ref. No. 65270450 LA65270450 LAR65270450 R65270450
	lamp socket 24V socket G4 connection cable 100mm ømm H 16mm with 2 hole fixing mounting distance 20mm holder length 26mm Qty 1 pcs		

			
1			
Part No.	359668	Ref. No.	70040800 LAR70040800
description	gasket		
For models:	CGC24M, CGC40M, ME106H, ME106L, ME106P, ME106T, ME106X, ME110H, ME110L, ME110P, ME110T, ME110X, ME120H, ME120L, ME120P, ME120X, ME210H, ME210L, ME210P, ME210T, ME210X, ME220H, ME220P, ME220X, ME227P, ME227X, MEC20H, MEC20P, MEC20X, MEC24H, MEC40H, MEC40M, MEK21H, MG106H, MG106L, MG106P, MG106T, MG106X, MG110H, MG110L, MG110P, MG110T, MG110X, MG120H, MG120P, MG120X, MG210H, MG210L, MG210P, MG210T...(Other models you can see in the webshop)		

			
1			
Part No.	359669	Ref. No.	50304510 LAR50304510
description	lamp socket socket G4 for halogen lamp		
For models:	ME05, ME10, ME15, ME20, ME21, ME24, ME40, MG05, MG10, MG15, MG20, MG21, MG24, MG40, MME10, MME40, PE04, PE08, PE12, PG04, PG08, PG12, RE05, RE07, RE10, RE20, RE24, RG05, RG07, RG10, RG20, RG24, RG40		

			
1			
Part No.	357131	Ref. No.	65270400 LAR65270400
description	lamp socket with fixing sheet L 90mm W 65mm socket G4 connection cable 100mm ømm H 21mm mounting distance 20mm for halogen lamp Qty 1 pcs		
For models:	CGC24M, CGC40M, EC106M, EC110M, EC210M, EM010M+SC, EM106H, EM106M, EM106M+SC, EM106P, EM110H, EM110M, EM110M+SC, EM110P, EM210H, EM210M, EM210M+SC, EM210P, EV006M, EV106H, EV106M, EV106M+SC, EV106P, EV110H, EV110M, EV110M+SC, EV110P, EV210H, EV210M, EV210M+SC, EV210P, FE105X, FG051X, FG101X, FG105X, FG110X, FG210X, GC106M, GC110M, GC210M, GM106H, GM106M, GM106M+SC, GM106P, GM110H, GM110M, GM110M+SC, GM110P, GM210H, GM210M...(Other models you can see in the webshop)		

			
1			
Part No.	359667	Ref. No.	10400150 LAR10400150
description	reflector L 141mm		
For models:	CGC24M, CGC40M, FE105X, FG105X, FG110X, FG210X, ME106H, ME106P, ME106X, ME110H, ME110P, ME110X, ME120H, ME120P, ME120X, ME210H, ME210P, ME210X, ME220H, ME220P, ME220X, MEC20H, MEC20P, MEC20X, MEC24H, MEC40H, MEC40M, MEK21H, MG106H, MG106P, MG106X, MG110H, MG110P, MG110X, MG120H, MG120P, MG120X, MG210H, MG210P, MG210X, MG220H, MG220P, MG220X, MGC20H, MGC20X, MGC24H, MGC40H, MGC40P, PE040X, PG040X...(Other models you can see in the webshop)		

lamps			
light bulbs			
			
1			
Part No.	357153	Ref. No.	65270120 LAR65270120
description	light bulb t.max. 300°C socket E14 25W 230V ø 25mm L 55mm lens L 30mm for oven type		





halogen lamps			
for socket G4 / G6.35 / G9			
			
1 500°C			
Part No.	359599	Ref. No.	50304520 65270020 LA65270020 LAR50304520 LAR65270020
description	halogen lamp socket G4 12V 20W temp.-resist. 500°C		
For models:	ACG10M, AVE07D, AVE10D, AVE10P, BPE064M, BPE064P, BPE074M, BPE074P, BPE084M, BPE084P, BPE104M, BPE104P, BPG064M, BPG064P, BPG074M, BPG074P, BPG084M, BPG084P, BPG104M, BPG104P, CE071M, CE100M, CE200M, CG071M, CG100M, CG200M, CGC24M, CGC40M, EC106M, EC110M, EC210M, EM010M+SC, EM106H, EM106M, EM106M+SC, EM106P, EM110H, EM110M, EM110M+SC, EM110P, EM210H, EM210M, EM210M+SC, EM210P, EMT06D, EPE056T, EPE086T, EPE156T, EPEV05T, EPEV08T...(Other models you can see in the webshop)		

			
2			
Part No.	359946	Ref. No.	65270130 R65270130
description	halogen lamp socket G9 230V 40W temp.-resist. 300°C		

timers

programme timers

			
1			
Part No.	403577	Ref. No.	65090220 65095000 LAR65090220 LAR65095000
description	gear motor CDC 4901F1 engines 1 chambers 1 operation time 20s 230V 50Hz shaft ø 6x4.6mm shaft L 24mm		
For models:	AVE10P, BPE064P, BPE074P, BPE084P, BPE104P, BPG064P, BPG074P, BPG084P, BPG104P, EPE056T, EPE086T, EPE156T, EPEV05T, EPEV08T, EPEV15T, EPG056T, EPG086T, EPG156T, EPGV05T, EPGV08T, EPGV15T, GEMT06P, GEMT06T, GEMT10P, GEMT10T, GEMT20P, GEMT20T, GEMT21P, GEMT21T, GEMT40P, GEMT40T, GEVT06P, GEVT06T, GEVT10P, GEVT10T, GEVT20P, GEVT20T, GEVT21P, GEVT21T, GEVT40P, GEVT40T, GGMT06P, GGMT06T, GGMT10P, GGMT10T, GGMT20P, GGMT20T, GGMT21P, GGMT21T, GGMT40P...(Other models you can see in the webshop)		

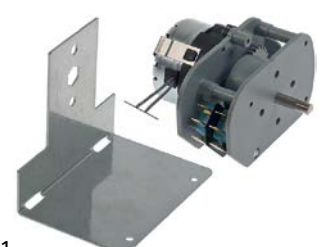

			
1			
Part No.	400115	Ref. No.	R65095000 (old version)
description	gear motor FIBER P25 engines 1 chambers 1 operation time 20s 230V 50Hz shaft ø 6x4.6mm shaft L 24mm type M51BJOR0000		

			
1			
Part No.	360633	Ref. No.	6A047080 BN6A047080
description	time switch kit 14000F3 operation time 120min impulse electric shaft ø 6x4.6mm shaft L 20mm CDC 230V engines 1 chambers 2		



			
1			
Part No.	362009	Ref. No.	65090060 A34100730 LA65090060 LAR65090060
description	timer CDC 11902F3 engines 1 chambers 2 operation time 108 230V 50/60Hz shaft ø 6x4.6mm shaft L 24mm manuf. no. 11902F3DHE000.0000 motor type M48L for combi-steamer		
For models:	RB102S, RB142M, RC162M		



			
1			
Part No.	360752	Ref. No.	65090190 LAR65090190 LAR65090190
description	timer CDC 4902F1 engines 1 chambers 2 operation time 8min 230V shaft ømm shaft Lmm		
For models:	A05PES, A05RES, A05RES+UM, A08RES, A08RES+UM, A10RES, A10RES+UM, ACG10M, BPE044M, BPE054M, BPE064M, BPE074M, BPE084M, BPE104M, BPG044M, BPG054M, BPG064M, BPG074M, BPG084M, BPG104M, CE041M, CE051M, CE071M, CE100M, CE200M, CG051M, CG071M, CG100M, CG200M, CGC24M, CGC40M, CVE004M, CVE104M, CVE105M, CVG105M, EC106M, EC110M, EC210M, EM010M+SC, EM106M, EM106M+SC, EM110M, EM110M+SC, EM210M, EM210M+SC, EV006M, EV106M, EV106M+SC, EV110M, EV110M+SC...(Other models you can see in the webshop)		

			
1			
Part No.	360505	Ref. No.	65090050 LAR65090050 LAR65090050
description	timer FIBER P25 engines 1 chambers 3 operation time 108min 230V shaft ø 6x4.6mm shaft L 25mm motor type M51BJOL6400 50/60		
For models:	PE015M, PG015M, PG115M		
spare parts for	360505		
	Part No.	360674	Ref. No. —
	motor kit pinion ø 6.8mm teeth 15 230V voltage AC 50/60Hz turn direction counterclockwise motor ø 48mm H 18.5mm motor type UDS40NE1RNZ165 cable length 150mm with holder		

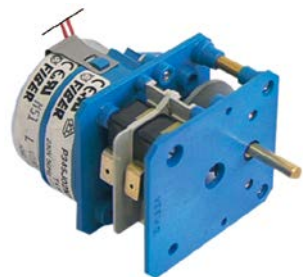
			
2			
Part No.	360720	Ref. No.	65090180 LAR65090180
description	timer CDC 4902V1 engines 1 chambers 2 operation time 8min 230V 50/60Hz manif. no. 4902V110DEY000.0000		
For models:	ME110X, ME227M, ME227X, MG106M, MG106X, MG110M, MG110X, MG120M, MG120X, MG210M, MG210X, MG220M, MG220X, MG227M, MG227X, PE015M, PG115M		

			
1			
Part No.	350038	Ref. No.	50304580 65090020 LAR50304580 LAR65090020
description	timer FIBER P34 engines 1 chambers 2 operation time 144min 230V shaft ø 6x4.6mm shaft L 20mm manif. no. P345J02N765 motor type M51BJOL6400 impulse electric		
For models:	ACG10M, BPE044M, BPE054M, BPE064M, BPE074M, BPE084M, BPE104M, BPG044M, BPG054M, BPG064M, BPG074M, BPG084M, BPG104M, CE041M, CE051M, CE071M, CE100M, CE200M, CG051M, CG071M, CG100M, CG200M, CGC40M, EC106M, EC110M, EC210M, FE05, FE105M, FE105X, FE110M, FE110X, FE210M, FG05, FG051M, FG051X, FG101M, FG101X, FG105M, FG105X, FG110M, FG110X, FG210M, FG210X, GC106M, GC110M, GC210M, MACE04M, MACE05M, MACE07M, MACE10M...(Other models you can see in the webshop)		
spare parts for	350038		
	Part No.	360674	Ref. No. —
	motor kit pinion ø 6.8mm teeth 15 230V voltage AC 50/60Hz turn direction counterclockwise motor ø 48mm H 18.5mm motor type UDS40NE1RNZ165 cable length 150mm with holder		

			
1			
Part No.	360536	Ref. No.	LAR65090180 (old version)
description	timer FIBER P25 engines 1 chambers 2 operation time 8min 230V 50/60Hz shaft ø hexagon 6mm shaft L 11mm manif. no. P255JV2J200 motor type M51BJOR0000		



electric timers

 <p>1</p>			
Part No.	350135	Ref. No.	65090090 LA65090090 LAR65090090
description	timer MS65 operation time 120min time spreadin 1CO/2NO at 250V 16A permanent position yes time range 0-120min impulse electric shaft ø 6x4.6mm shaft L 21mm mounting distance 28mm connection male faston 6.3mm screw mounting 250V voltage AC 50Hz		

with time spread

 <p>1</p>			
Part No.	350148	Ref. No.	65090070 LAR65090070
description	timer MS65 operation time 120min time spread 30min 2NO at 250V 16A permanent position yes shaft ø 6x4.6mm shaft L 20mm 2-pole		
For models:	A05PES, A05RES, A05RES+UM, A08RES, A08RES+UM, A10RES, A10RES+UM		

mechanical timers

 <p>1</p>			
Part No.	360533	Ref. No.	65090410 LAR65090410
description	timer MI12 3-pole operation time 60min impulse mechanical at 250V 16A shaft ø 6x4.6mm shaft L 24mm connection male faston 6.3mm JUNGHANS		

alarm devices

alarm units

 <p>1</p>			
Part No.	350056	Ref. No.	65330050
description	alarm device 220-240VAC ømm H 25mm wall-mounted version mounting distancemm 83dB protection IPx0		

 <p>1</p>			
Part No.	350081	Ref. No.	50304480 65330020 LAR50304480 LAR65330020
description	alarm device 9-15VDC H 14.5mm wall-mounted version 75dB protection IPx0		
For models:	EM106H, EM106P, EM110H, EM110P, EM210H, EM210P, EV106H, EV106P, EV110H, EV110P, EV210H, EV210P, FV03, FV06, GM106H, GM106P, GM110H, GM110P, GM210H, GM210P, GV106H, GV106P, GV110H, GV110P, GV210H, GV210P, ME05, ME10, ME15, ME20, ME21, ME24, ME40, MG05, MG10, MG15, MG20, MG21, MG24, MG40, PE04		

buzzer boards

 <p>1</p>			
Part No.	400143	Ref. No.	65300670 LAR65300670
description	buzzer board		
For models:	ME106P, ME110P, ME120P, ME210P, ME220P, ME227P, MG106P, MG110P, MG120P, MG210P, MG220P, MG227P, VE106P, VE120P, VE210P, VE220P, VG106P, VG110P, VG120P, VG210P, VG220P		

buzzers

 <p>1</p>			
Part No.	350055	Ref. No.	65330040 LA65330040 LAR65330040
description	buzzer 12VDC connection cable 200mm PCB buzzer 20dB		
For models:	CVE004H, CVE104H, CVE105H, CVG105H, LA16, LV16, ME106D, ME106H, ME106L, ME106P, ME106S, ME106T, ME110D, ME110H, ME110L, ME110P, ME110S, ME110T, ME120D, ME120H, ME120L, ME120P, ME120S, ME120T, ME210D, ME210H, ME210L, ME210P, ME210S, ME210T, ME220D, ME220H, ME220L, ME220P, ME220S, ME220T, ME227P, MEC20H, MEC20P, MEC24H, MEC40H, MEK21H, MG106D, MG106H, MG106L, MG106P, MG106T, MG110D, MG110H, MG110L...(Other models you can see in the webshop)		

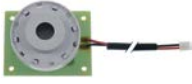

			
Part No.	350086	Ref. No.	65301440 65321440 LA65301440 LAR65301440 LAR65321440
description	buzzer 12VDC connection cable 200mm PCB buzzer 20dB		
For models:	AVE07D, AVE10D, AVE10P, BPE044P, BPE054P, BPE064P, BPE074P, BPE084P, BPE104P, BPG044P, BPG054P, BPG064P, BPG074P, BPG084P, BPG104P, EMT06D, EPE056T, EPE086T, EPE156T, EPEV05T, EPEV08T, EPEV15T, EPG056T, EPG086T, EPG156T, EPGV05T, EPGV08T, EPGV15T, GEMT06P, GEMT06T, GEMT10P, GEMT10T, GEMT20P, GEMT20T, GEMT21P, GEMT21T, GEMT40P, GEMT40T, GEVT06P, GEVT06T, GEVT10P, GEVT10T, GEVT20P, GEVT20T, GEVT21P, GEVT21T, GEVT40P, GEVT40T, GGMT06P, GGMT06T...(Other models you can see in the webshop)		

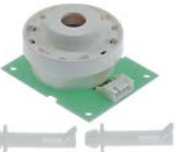
			
Part No.	350223	Ref. No.	65301960 LA65302450 LAR65302450 R65301960
description	buzzer 12VDC connection coded PCB buzzer 20dB		

			
Part No.	350050	Ref. No.	50304460 65330010 LA65330010 LAR50304460 LAR65330010
description	buzzer 230VAC connection male faston 6.3mm screw mounting thread M4 60dB		
For models:	ACG10M, CE041M, CE051M, CE071M, CE100M, CE200M, CG051M, CG071M, CG100M, CG200M, CGC24M, CGC40M, CVE004M, CVE104M, CVE105M, CVG105M, EC106M, EC110M, EC210M, EM010M+SC, EM106M, EM106M+SC, EM110M, EM110M+SC, EM210M, EM210M+SC, EV006M, EV106M, EV106M+SC, EV110M, EV110M+SC, EV210M, EV210M+SC, FE105M, FE105X, FE110M, FE110X, FE210M, FG051M, FG051X, FG101M, FG101X, FG105M, FG105X, FG110M, FG110X, FG210M, FG210X, GC106M, GC110M...(Other models you can see in the webshop)		

contactors

GENERAL ELECTRIC (AEG)

power contactors



Part No.	380261	Ref. No.	187400
description	power contactor resistive load 32A 230VAC (AC3/400V) 17A/7.5kW main contacts 3NO auxiliary contacts 1NO connection screw connection type AEG LS7K 10A type GE CL02A 310		

MOELLER/EATON

power contactors



Part No.	380550	Ref. No.	65140550 65140700 LA65140700 LAR65140550 LAR65140700
-----------------	--------	-----------------	--

description	power contactor resistive load 20A 230VAC (AC3/400V) 9A/4kW main contacts 3NO auxiliary contacts 1NC connection screw connection type DILM9 01		
--------------------	--	--	--

For models:	ACG10M, AVE07D, AVE10D, AVE10P, BPE044M, BPE044P, BPE054M, BPE054P, BPE064M, BPE064P, BPE074M, BPE074P, BPE084M, BPE084P, BPE104M, BPE104P, BPG064M, BPG064P, BPG074M, BPG074P, BPG084M, BPG084P, BPG104M, BPG104P, CE041M, CE051M, CE071M, CE100M, CE200M, CG071M, CG100M, CG200M, EMT06D, EPE056T, EPEV05T, EPEV08T, EPEV15T, EPG056T, EPG086T, EPGV05T, EPGV08T, FG051M, FG051X, FG101M, FG101X, GEMT06P, GEMT06T, GEMT10P, GEMT10T, GEVT06P, GEVT06T, GEVT10P...(Other models you can see in the webshop)		
--------------------	---	--	--

accessories for	380550		
------------------------	--------	--	--

	Part No.	380555	Ref. No.	—
auxiliary contact contacts 2NO/2NC AC15 16A for contactors DILEM connection screw type DILA-XHI22				

	Part No.	380556	Ref. No.	—
auxiliary contact contacts 4NO AC15 16A for contactors DILM 7-32 connection screw type DILA-XHI40				

	Part No.	380557	Ref. No.	—
auxiliary contact contacts 4NC AC15 16A for contactors DILM 7-32 connection screw type DILA-XHI04				

	Part No.	380558	Ref. No.	—
auxiliary contact contacts 3NO/1NC AC15 16A for contactors DILM 7-32 connection screw type DILA-XHI31				



	Part No.	380559	Ref. No.	—
auxiliary contact contacts 1NO/3NC AC15 16A for contactors DILM 7-32 connection screw type DILA-XHI13				

Table continues overleaf



accessories for 380550	
	Part No. 380568 Ref. No. —
RC circuit suitable for DILM 9-12 rated 110-240V	



Part No.	381005	Ref. No.	65140560 65140710 LA65140710 LAR65140560 LAR65140710
description	power contactor resistive load 35A 230VAC (AC3/400V) 17A/7.5kW main contacts 3NO auxiliary contacts 1NC connection screw connection type DILM 17-01		
For models:	AVE10D, AVE10P, BPE084M, BPE084P, BPE104M, BPE104P, CE100M, CE200M, EPE086T, EPEV08T, GEMT10P, GEMT10T, GEVT10P, GEVT10T, MACE10M, MACE20M, MCE101M, MCE102M, MEMT10D, MEMT10P, MEVT10D, MEVT10P, MME101P, MME102P, MVE101M, MVE101P, MVE102P		

auxiliary contacts



Part No.	381007	Ref. No.	65140730 LA65140730 LAR65140730
description	auxiliary contact contacts 1NO/1NC AC15 10A for contactors connection screw type DILA-XHI11		
For models:	BPE064M, BPE064P, BPE074M, BPE074P, EPE086T, EPEV08T, EPG056T, EPG086T, EPGV05T, EPGV08T, GEMT06P, GEMT06T, GEMT10P, GEMT10T, GEVT06P, GEVT06T, MME071P, MME101P, MVE071M, MVE071P		



Part No.	380565	Ref. No.	65140600 65140740 LA65140740 LAR65140600 LAR65140740
description	auxiliary contact contacts 1NO/1NC AC15 10A for contactors DIL 17-32 connection screw type DILM 32-CHI11-S		
For models:	AVE10P, BPE084P, BPE104P, EPE086T, EPEV08T, GEVT10P, GEVT10T, MEMT10D, MEMT10P, MEVT10D, MEVT10P, MME101P, MME102P, MVE101M, MVE101P, MVE102P		

SIEMENS

power contactors





Part No.	380644	Ref. No.	50304251 65140140 LAR50304251 LAR65140140
description	power contactor 230VAC auxiliary contacts 1NO/1NC		
For models:	FE05, FV03, ME05, ME10, ME110X, ME120P, ME15, ME20, ME21, ME227M, ME227P, ME227X, ME24, ME40, MG05, MG10, MG106M, MG106P, MG106X, MG110M, MG110P, MG110X, MG120M, MG120P, MG120X, MG15, MG20, MG21, MG210M, MG210P, MG210X, MG220M, MG220P, MG220X, MG227M, MG227P, MG227X, MG24, MG40, MME10, MME40, PE04, PE08, PE12, PG04, PG08, PG12, RE05, RE07, RE10... (Other models you can see in the webshop)		



Part No.	380645	Ref. No.	50304271 65140230 65140240 LAR50304271 LAR65140230 LAR65140240
description	power contactor 230VAC with auxiliary contacts		
For models:	EC110M, EC210M, EM010M+SC, EM110H, EM110M, EM110M+SC, EM110P, EM210H, EM210M, EM210M+SC, EM210P, EV110H, EV110M, EV110M+SC, EV110P, EV210H, EV210M, EV210M+SC, EV210P, FE110M, FE110X, FV06, ME110D, ME110H, ME110M, ME110P, ME110X, ME120D, ME120H, ME120L, ME120M, ME120P, ME120S, ME120T, ME120X, ME15, ME20, ME210D, ME210H, ME210L, ME210M, ME210P, ME210S, ME210T, ME210X, ME220D, ME220H, ME220L, ME220M, ME220P...(Other models you can see in the webshop)		





			
1			
Part No.	380652	Ref. No.	65140380 LA65140380 LAR65140380
description	power contactor resistive load 22A 230VAC (AC3/400V) 9A/4kW main contacts 3NO auxiliary contacts 1NC connection screw connection type 3RT10-16-1AP02		
For models:	EPG156T, EPGV15T, GEMT20P, GEMT21P, GEMT40P, GEVT20P, GEVT21P, GEVT40P, GGMT20P, GGMT20T, GGMT21P, GGMT21T, GGVT40P, GGVT40T, GGT20P, GGT20T, GGT21P, GGT21T, GGT40P, GGT40T, GMT20D, GMT20P, GVT20D, HME061P, HME061T, HME061X, HME101P, HME101T, HME101X, HME102P, HME201P, HME202P, HMG061P, HMG061T, HMG061X, HMG101P, HMG101T, HMG101X, HMG102P, HMG102T, HMG102X, HMG201P, HMG201T, HMG201X, HMG202P, HMG202T, HMG202X, HVE061P, HVE061T, HVE061X...(Other models you can see in the webshop)		

			
1			
Part No.	380647	Ref. No.	65140430 LA65140430 LAR65140430
description	auxiliary contact contacts 1NO/1NC AC15 3A for contactors 3RT102 3 RT103 connection screw connection type 3RH1921-1EA11 resistive load 10A AC-12 10A		
For models:	EPE156T, EPEV15T, GEMT20P, GEMT20T, GEMT21P, GEMT21T, GEMT40P, GEMT40T, GEVT20P, GEVT20T, GEVT21P, GEVT21T, GEVT40P, GEVT40T, HME101P, HME101T, HME101X, HME102P, HME102T, HME102X, HME201P, HME201T, HME201X, HME202P, HME202T, HME202X, HVE101P, HVE101T, HVE101X, HVE102P, HVE102T, HVE102X, HVE201P, HVE201T, HVE201X, HVE202P, HVE202T, HVE202X, ME101D, ME101P, ME101T, ME102D, ME102M, ME102P, ME102T, ME201D, ME201M, ME201P, ME201T, ME202D...		
	(Other models you can see in the webshop)		

motor protection circuit breakers

			
1			
Part No.	382000	Ref. No.	65160590 LA65160590 LAR65160590
description	motor protection circuit breaker type 3RU1116-1EBO setting range 2.8-4A (AC3/400V) 1.5kW		
For models:	GEMT20P, GGMT20P, GGMT21P, GGMT40P, GGT20P, GGT21P, GGT40P, GMT20D, GMT20P, GVT20D, HME101P, HME102P, HMG101P, HMG102P, HMG201P, HMG202P, HVG101P, HVG102P, HVG201P, HVG202P, MCG201M, MCG202M, MG101D, MG101M, MG101P, MG101T, MG102P, MG102T, MG201D, MG201H, MG201M, MG201P, MG201T, MG202D, MG202H, MG202M, MG202P, MG202T, MGMT21D, MGMT21P, MGMT40D, MGMT40P, MGVT21D, MGVT21P, MGVT40D, MGVT40P, VG101D, VG101M, VG101P, VG201D...(Other models you can see in the webshop)		

			
1			
Part No.	380648	Ref. No.	50304170 65160010 LAR50304170 LAR65160010
description	motor protection circuit breaker type 3VU1300-1MF00 setting range 0.6-1A auxiliary contacts 1NO/1NC		
For models:	ME10, ME15, ME20, ME21, ME24, ME40, MG10, MG15, MG20, MG21, MG24, MG40, MME10, MME40, PE08, PE12, PG08, PG12, RE07, RE10, RE20, RE24, RG07, RG10, RG20, RG24, RG40		

			
2			
Part No.	380646	Ref. No.	65140400 LA65140400 LAR65140400
description	power contactor resistive load 40A 230VAC (AC3/400V) 17A/7.5kW main contacts 3NO auxiliary contacts connection screw connection type 3RT10-25-1AL20		
For models:	EPE156T, EPEV15T, GEMT20P, GEMT20T, GEMT21P, GEMT21T, GEMT40P, GEMT40T, GEVT20P, GEVT20T, GEVT21P, GEVT21T, GEVT40P, GEVT40T, HME101P, HME101T, HME101X, HME102P, HME102T, HME102X, HME201P, HME201T, HME201X, HME202P, HME202T, HME202X, HVE101P, HVE101T, HVE101X, HVE102P, HVE102T, HVE102X, HVE201P, HVE201T, HVE201X, HVE202P, HVE202T, HVE202X, MCE201M, ME101D, ME101H, ME101M, ME101P, ME101T, ME102D, ME102H, ME102M, ME102P, ME102T, ME201D...		
	(Other models you can see in the webshop)		

auxiliary contacts

			
1			
Part No.	380653	Ref. No.	65140420 LA65140420 LAR65140420
description	auxiliary contact contacts 1NO/1NC AC15 3A for contactors 3RT101 connection screw connection type 3RH1911-1FA11		
For models:	HME101P, HME101T, HME101X, HVE061P, HVE061T, HVE061X, ME061D, ME061M, ME061P, ME061T, ME101D, ME101M, ME101P, ME101T, VE061P		







			
1			
Part No.	380649	Ref. No.	50304190 65160020 LAR50304190 LAR65160020
description	motor protection circuit breaker type 3VU1300-1MH00 setting range 1.6-2.4A auxiliary contacts 1NO/1NC		
For models:	ME10, ME15, ME20, ME21, ME24, ME40, MG10, MG15, MG20, MG21, MG24, MG40, MME10, MME40, PE08, PE12, PG08, PG12, RE07, RE10, RE20, RE24, RG07, RG10, RG20, RG24, RG40		

			
1			
Part No.	380651	Ref. No.	50304200 65160030 LAR50304200 LAR65160030
description	motor protection circuit breaker type 3VU1300-1MJ00 setting range 2.4-4A auxiliary contacts 1NO/1NC		
For models:	ME10, ME15, ME20, ME21, ME24, ME40, MG10, MG15, MG20, MG21, MG24, MG40, MME10, MME40, PE08, PE12, PG08, PG12, RE07, RE10, RE20, RE24, RG07, RG10, RG20, RG24, RG40		

			
1			
Part No.	380650	Ref. No.	50304180 65160040 LAR50304180 LAR65160040
description	motor protection circuit breaker type 3VU1300-1MK00 setting range 4-6A auxiliary contacts 1NO/1NC		
For models:	MG10, MG15, MG21, MG24, MG40, MME10, MME40, PG08, PG12, RE07, RG07, RG10, RG20, RG24, RG40		

miscellaneous

kits

							
1							
Part No.	381158	Ref. No.	65160130 LAR65160130				
description	overload switch kit						
For models:	CGC24M, CGC40M, FG110M, FG110X, FG210M, FG210X, GC110M, GC210M, GM110H, GM110M, GM110M+SC, GM110P, GM210H, GM210M, GM210M+SC, GM210P, GV110H, GV110M, GV110M+SC, GV110P, GV210H, GV210M, GV210M+SC, GV210P, ME110X, ME120P, ME227M, ME227P, ME227X, MG110D, MG110H, MG110L, MG110M, MG110P, MG110S, MG110T, MG110X, MG120D, MG120H, MG120L, MG120M, MG120P, MG120S, MG120T, MG120X, MG210D, MG210H, MG210M, MG210P, MG210T...(Other models you can see in the webshop)						
spare parts for	381158						
		<table border="1"> <tr> <td>Part No.</td> <td>380652</td> <td>Ref. No.</td> <td>65140380 LA65140380 LAR65140380 R65140380</td> </tr> </table>	Part No.	380652	Ref. No.	65140380 LA65140380 LAR65140380 R65140380	<p>power contactor resistive load 22A 230VAC (AC3/400V) 9A/4kW main contacts 3NO auxiliary contacts 1NC connection screw connection type 3RT10-16-1AP02</p>
Part No.	380652	Ref. No.	65140380 LA65140380 LAR65140380 R65140380				
		<table border="1"> <tr> <td>Part No.</td> <td>380660</td> <td>Ref. No.</td> <td>—</td> </tr> </table>	Part No.	380660	Ref. No.	—	<p>base</p>
Part No.	380660	Ref. No.	—				
		<table border="1"> <tr> <td>Part No.</td> <td>381071</td> <td>Ref. No.</td> <td>65160600 LA65160600</td> </tr> </table>	Part No.	381071	Ref. No.	65160600 LA65160600	<p>overload switch setting range 3.5-5A</p>
Part No.	381071	Ref. No.	65160600 LA65160600				

power contactors

			
1			
Part No.	380654	Ref. No.	65140150 65140170 LAR65140150 LAR65140170
description	power contactor 230V with auxiliary contacts		
For models:	CGC24M, CGC40M, CVE004H, CVE004M, CVE104H, CVE104M, CVE105H, CVE105M, CVG105H, CVG105M, EC106M, EC110M, EC210M, EM010M+SC, EM106H, EM106M, EM106M+SC, EM106P, EM110H, EM110M, EM110M+SC, EM110P, EM210H, EM210M, EM210M+SC, EM210P, EV006M, EV106H, EV106M, EV106M+SC, EV106P, EV110H, EV110M, EV110M+SC, EV110P, EV210H, EV210M, EV210M+SC, EV210P, FE105M, FE105X, FE110M, FE110X, FE210M, FG105M, FG105X, FG110M, FG110X, FG210M, FG210X...(Other models you can see in the webshop)		



relays





power relays

with DIN rail mounting

lateral



1

Part No.	380336	Ref. No.	65170100 LA65170100 LAR65170100
description	power relays FINDER 230VAC 16A 2NO connection male faston 6.3mm DIN rail manuf. no. 62.82.8.230.0308		
For models:	BPE044P, BPE054P, BPG044M, BPG044P, BPG054M, BPG054P, BPG064M, BPG064P, BPG074M, BPG074P, BPG084M, BPG084P, BPG104M, BPG104P, CVE004H, CVE104H, GGMT06P, GGMT10P, GGMT20P, GGMT21P, GGMT40P, GGVT06P, GGVT10P, GGVT20P, GGVT21P, GGVT40P, HMG061P, HMG101P, HMG102P, HMG201P, HMG202P, HVG061P, HVG101P, HVG102P, HVG201P, HVG202P, MCG051M, MCG071M, MCG101M, MCG102M, MMG071P, MMG101P, MMG102P, MVE042P, MVE051P, MVG051P, MVG071P, MVG101P, MVG102P, VE004D...(Other models you can see in the webshop)		
accessories for	380336		
	Part No.	380703	Ref. No. —
	adapter for flange mounting suitable for Finder relay 62 series.		
	Part No.	380811	Ref. No. —
	adapter with bracket mounting suitable for Finder relay 62 series.		
	Part No.	380954	Ref. No. —
	adapter hole distance 54mm bracket mounting suitable for Finder relay 62 series. L 41mm W 39mm H 49mm		
	Part No.	381003	Ref. No. —
	adapter for DIN rail mounting suitable for Finder relay 62 series.		
	Part No.	381039	Ref. No. —
	adapter for DIN rail mounting suitable for Finder relay 62 series.		



1

Part No.	380379	Ref. No.	890029 SIRA890029 SIRRA890029
description	power relays SCHRACK 230VAC 25A 2CO connection male faston 6.3mm DIN rail manuf. no. RM809730		



1

Part No.	380926	Ref. No.	65180100 LAR65180100
description	relay 230VAC 16A 2CO connection male faston 6.3mm DIN rail 2-pole		

with bracket mounting



1

Part No.	380702	Ref. No.	687240
description	power relays FINDER 230VAC 16A 3NO connection male faston 6.3mm flange dimensions 36x38x68mm manuf. no. 62.83.8.230.0300 230V		

with male contacts

female contact 6.3mm



1

Part No.	381466	Ref. No.	LA65170180 LAR65170180
description	power relays FINDER 16A/250VA connection male faston 6.3mm plug-in connection manuf. no. 62.83.8.230.0309		

plug-in/print relays



1

Part No.	381467	Ref. No.	LAR65170190
description	print relay 0-12VDC 1CO at 250V 10A connection pins with relay socket FINDER manuf. no. 40.31.8.230.5000 95.63		

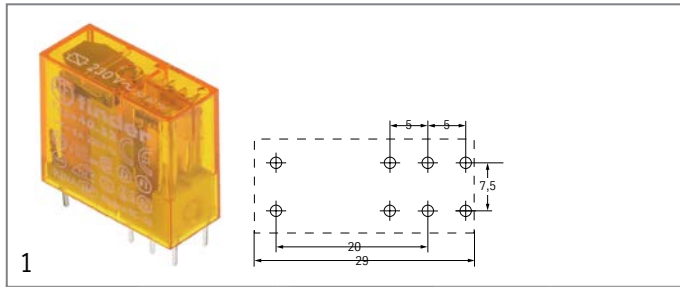

Part No.	380333	Ref. No.	65170050 LAR65170050
description	print relay 230VAC 2CO at 250V 8A connection pins raster size 5mm FINDER manuf. no. 40.52.8.230.0000 95.65/95.75		
For models:	BPE064M, BPE074M, CGC24M, CGC40M, GEMT06P, GEMT06T, GEMT10P, GEMT10T, GEMT21P, GEMT21T, GEVT06P, GEVT06T, GEVT10P, GEVT10T, GEVT21P, GEVT21T, GGMT06P, GGMT06T, GGMT10P, GGMT10T, GGMT21P, GGMT21T, GGVT06P, GGVT06T, GGVT10P, GGVT10T, GGVT21P, GGVT21T, GMT20P, MCE201M, MCE202M, MCG201M, MCG202M, ME061M, ME101M, ME102D, ME102M, ME106M, ME106S, ME106X, ME110L, ME110M, ME110S, ME110X, ME120L, ME120M, ME120S, ME120X, ME201M, ME202M... (Other models you can see in the webshop)		
accessories for	380333		
	Part No.	380340	Ref. No. —
	relay socket dimensions 62x36x15mm 250V voltage AC 10A Italiana Relè manuf. no. ZMEM/5		
	Part No.	380505	Ref. No. —
	relay socket 2CO 40.52 dimensions 81.9x15.5x75mm 250V voltage AC 10A FINDER manuf. no. 95.95.3		
	Part No.	381181	Ref. No. —
	relay socket 2-pole 40.51/40.52/40.61 connection screw clamp dimensions 15.8x78.6mm 250V voltage AC 10A FINDER manuf. no. 95.75		

Part No.	380664	Ref. No.	65170020 LAR65170020
description	print relay 250VAC 1CO		
For models:	ME105L, ME105S, ME106L, ME106S, ME110L, ME110S, ME120L, ME120S, ME210L, ME210S, ME220L, ME220S, MG105L, MG105S, MG106L, MG106S, MG110L, MG110S, MG120L, MG120S, MG210L, MG210S, MG220L, MG220S, VE105S, VE106L, VE106S, VE110L, VE110S, VE120L, VE120S, VE210L, VE210S, VG105S, VG106L, VG106S, VG110L, VG110S, VG210L, VG210S		

Part No.	380662	Ref. No.	LAR65170020
description	print relay 250VAC 1CO at 250V 10A connection pins raster size 3.5mm		
accessories for	380662		
	Part No.	380663	Ref. No. —
	relay socket 250V voltage AC 10A FINDER manuf. no. 95.83.3		

level relays

GICAR



Part No.	401224	Ref. No.	65120010 LAR65120010
description	level relay 230V connection F6.3 type RL30/3ES/F/G		
For models:	EM010M+SC, EM106M, EM106M+SC, EM110M, EM110M+SC, EM210M, EM210M+SC, GM106M, GM106M+SC, GM110M, GM110M+SC, GM210M, GM210M+SC, ME061M, ME101M, ME102D, ME102M, ME106M, ME106X, ME110M, ME110X, ME120M, ME120X, ME201M, ME202M, ME210M, ME210X, ME220M, ME220X, ME227M, ME227X, MEC20X, MEC40M, MG061M, MG101M, MG102M, MG106M, MG106X, MG110M, MG110X, MG120M, MG120X, MG201M, MG202M, MG210M, MG210X, MG220M, MG220X, MG227M, MG227X...(Other models you can see in the webshop)		



time relays

time relays



Part No.	381421	Ref. No.	65090450 LA65090450 LAR65090450
description	time relay CROUZET EMAR7 88 829 117 time range 0.1s-20h 240VAC 5A NO connection grip connection		
For models:	ACG10M, BPE064M, BPE074M, BPE084M, BPE104M, BPG064M, BPG074M, BPG084M, BPG104M, CG051M, CG071M, CG100M, CG200M, CGC24M, CGC40M, CVG105H, CVG105M, MACG05M, MACG07M, MACG10M, MACG20M, MCG051M, MCG071M, MCG101M, MCG102M, ME061M, ME101M, ME102D, ME102M, ME201M, ME202M, MEC20X, MEC40M, MG061M, MG101M, MG102M, MG106D, MG106H, MG106M, MG106P, MG106X, MG110D, MG110H, MG110M, MG110P, MG110X, MG120D, MG120H, MG120M, MG120P...(Other models you can see in the webshop)		



			
1			
Part No.	380329	Ref. No.	65090460 LAR65090460
description	time relay FIBER 85.02.8.240 time range 0.05s - 100h 230-240VAC 10A mounting measurements 20.6x27.7mm 2CO connection 2.0		
For models:	ME106M, ME106X, ME110M, ME110X, ME120M, ME120X, ME210M, ME210X, ME220M, ME220X, MG106M, MG106X, MG110M, MG110X, MG120M, MG120X, MG210M, MG210X, MG220M, MG220X, PE015M, PG115M		
accessories for	380329		
	Part No.	380378	Ref. No. —
	relay socket 2-pole 55/85 dimensions 70.5x30x27mm 250V voltage AC 10A FINDER manuf. no. 94.72		
	Part No.	380803	Ref. No. —
	relay socket 2-pole dimensions 76.2x27x86.1mm 250V voltage AC 10A FINDER manuf. no. 94.92.3		

transformers

encapsulated transformers

with screw connection

			
1			
Part No.	400127	Ref. No.	65180430 LA65180430 LAR65180430
description	transformer primary 230VAC secondary 12VAC 40VA secondary 3.2A H 63mm L 75mm W 78mm connection 2-wire connection systems 50/60Hz moulded		
For models:	CGC24M, CGC40M, EC110M, EC210M, EM010M+SC, EM110H, EM110M, EM110M+SC, EM110P, EM210H, EM210M, EM210M+SC, EM210P, EPE086T, EPE156T, EPEV08T, EPEV15T, EPG086T, EPG156T, EPGV08T, EPGV15T, EV110H, EV110M, EV110M+SC, EV110P, EV210H, EV210M, EV210M+SC, EV210P, FG101X, FG110X, FG210X, GC110M, GC210M, GEMT10P, GEMT10T, GEMT20P, GEMT20T, GEMT21P, GEMT21T, GEMT40P, GEMT40T, GEVT10P, GEVT10T, GEVT20P, GEVT20T, GEVT21P, GEVT21T, GEVT40P, GEVT40T...(Other models you can see in the webshop)		

PMA			
			
1			
Part No.	401340	Ref. No.	65180770 LA65180770 LAR65180770
description	transformer primary 220/240V secondary 24V 50VA secondary 2.1A connection screw 50/60Hz		
For models:	ACG10M, CG051M, CG071M, CG100M, CG200M, GMT06D, GMT20D, GMT20P, GVT06D, GVT20D, MACG05M, MACG07M, MACG10M, MACG20M, MG061D, MG061H, MG061M, MG061P, MG061T, MG101D, MG101H, MG101M, MG101P, MG101T, MG102D, MG102H, MG102M, MG102P, MG102T, MG201D, MG201H, MG201M, MG201P, MG201T, MG202D, MG202H, MG202M, MG202P, MG202T, MGMT06D, MGMT06P, MGMT10D, MGMT10P, MGMT20D, MGMT20P, MGMT21D, MGMT21P, MGMT40D, MGMT40P, MGVT06D...(Other models you can see in the webshop)		

			
1			
Part No.	401339	Ref. No.	65180370 LA65180370 LAR65180370
description	transformer primary 220/240V secondary 8/12V 6VA secondary 0.3/0.2A connection screw 50/60Hz		
For models:	ME004L, ME004S, ME104L, ME104S, ME105L, ME105S, ME106L, ME106S, ME110L, ME110S, ME120L, ME120S, ME210L, ME210S, ME220L, ME220S, MG105L, MG105S, MG106L, MG106S, MG110L, MG110S, MG120L, MG120S, MG210L, MG210S, MG220L, MG220S, VE004S, VE104S, VE105S, VE106L, VE106S, VE110L, VE110S, VE120L, VE120S, VE210L, VE210S, VG105S, VG106L, VG106S, VG110L, VG110S, VG210L, VG210S		

			
1			
Part No.	400125	Ref. No.	65180410 LA65180410 LAR65180410
description	transformer primary 220-240V secondary 12V 16VA secondary 12V/0.3A/1AA connection screw 50Hz		
For models:	EM106P, EM110P, EM210P, EV106P, EV110P, EV210P, GM106P, GM110P, GM210P, GV106P, GV110P, GV210P, ME106P, ME106T, ME110P, ME110T, ME120P, ME120T, ME210P, ME210T, ME220P, ME220T, MEC20P, MG106P, MG106T, MG110P, MG110T, MG120P, MG120T, MG210P, MG210T, MG220P, MG220T, MGC40P, PE108D, VE106P, VE106T, VE110P, VE110T, VE210P, VE210T, VE220P, VEC20P, VG106P, VG106T, VG110P, VG110T, VG120P, VG210P, VG210T...(Other models you can see in the webshop)		



			
1			
Part No.	400096	Ref. No.	50305030 50305080 65180400 LA65180400 LAR50305030 LAR50305080 LAR65180400
description	transformer primary 230V secondary 12V 15VA connection screw 50Hz		
For models:	FV03, FV06, ME05, ME10, ME15, ME20, ME21, ME24, ME40, MG05, MG10, MG15, MG20, MG21, MG24, MG40, PE04		

			
1			
Part No.	400126	Ref. No.	65180420 960002 LA65180420 LAR65180420
description	transformer primary 230VAC secondary 12VAC 20VA secondary 2.1A connection screw 50Hz		
For models:	ACG10M, AVE07D, AVE10D, AVE10P, BPE044M, BPE044P, BPE054M, BPE054P, BPE064M, BPE064P, BPE074M, BPE074P, BPE084M, BPE084P, BPE104M, BPE104P, BPG044M, BPG044P, BPG054M, BPG054P, BPG064M, BPG064P, BPG074M, BPG074P, BPG084M, BPG084P, BPG104M, BPG104P, CE071M, CE100M, CE200M, CG071M, CG100M, CG200M, EC106M, EM106H, EM106M, EM106M+SC, EM106P, EMT06D, EPE056T, EPE086T, EPE156T, EPEV05T, EPEV08T, EPEV15T, EPG056T, EPG086T, EPG156T, EPGV05T...(Other models you can see in the webshop)		

			
1			
Part No.	379054	Ref. No.	50305010 65180530 LAR50305010 LAR65180530
description	transformer primary 230VAC secondary 12VAC 3VA secondary 0.25A H 40mm L 45mm W 50mm connection screw 50/60Hz type 153/M		
For models:	ME004L, ME004S, ME104L, ME104S, ME105L, ME105S, ME106L, ME106S, ME110L, ME110S, ME120L, ME120S, ME210L, ME210S, ME220L, ME220S, MG105L, MG105S, MG106L, MG106S, MG110L, MG110S, MG120L, MG120S, MG210L, MG210S, MG220L, MG220S, MME10, MME40, RE05, RE07, RE10, RE20, RE24, RG05, RG10, RG20, RG24, RG40		

for lighting

			
1			
Part No.	400095	Ref. No.	50305050 65180630 LAR50305050 LAR65180630
description	electrical ballast primary 230V secondary 11.5V 45VA		
For models:	ME05, ME10, ME15, ME20, ME21, ME24, ME40, MG05, MG10, MG15, MG20, MG21, MG24, MG40, MME10, MME40, PE04, PE08, PE12, PG04, PG08, PG12, RE05, RE07, RE10, RE20, RE24, RG05, RG07, RG10, RG20, RG24, RG40		

electronic controllers

ELIWELL

universal controllers

built-in version

			
1			
Part No.	379560	Ref. No.	65340030 LAR65340030
description	electronic controller ELIWELL type IC901 mounting measurements 71x29mm 12V voltage AC/DC NTC/PTC relay outputs 1 relay refrigeration front measurements 74x32mm built-in depth 60mm protection IP65 accuracy superior to 0.5% from final value% defr. funct. no -55 up to +150°C display 2½ digit Templn1 yes 8A		
accessories for	379560		
Part No.	379052	Ref. No.	—
description	temperature probe PTC 1kOhm cable silicone probe -50 up to +150°C cable -50 up to +180°C probe ø6x40mm cable length 1.5m without screw connection 2-wire		
Part No.	379064	Ref. No.	65320540 995562 FR995562 RA930008 SIRRA930008
description	temperature probe PTC 1kOhm cable silicone probe -50 up to +150°C cable -50 up to +180°C probe ø6x40mm cable length 3m without screw connection 2-wire		
Part No.	379160	Ref. No.	—
description	temperature probe NTC 10kOhm cable thermoplastic probe -40 up to +110°C cable -40 up to +110°C probe ø6x14mm cable length 1.5m without screw connection 2-wire		
Part No.	379161	Ref. No.	—
description	temperature probe NTC 10kOhm cable thermoplastic probe -40 up to +110°C cable -40 up to +110°C probe ø6x14mm cable length 3m without screw connection 2-wire		



1			
Part No.	379605	Ref. No.	65340010
description	electronic controller ELIWELL type ICPlus915 model ICP22JI35000 mounting measurements 71x29mm 12V voltage AC/DC Pt100/TC (J,K) relay outputs 2 NO-8A(4) NO-8A(4) Pt100/TC (J,K) cooking front measurements 78x37mm built-in depth 59mm mode of operation cooking protection IPx0 accuracy 1% built-in version defr. funct. no dependend on probe°C display 3½ digits		
accessories for	379605		
	Part No.	Ref. No.	65325010 LAR65325010 R65320160 R65325010
	temperature probe Pt100 cable Vetrotex probe -200 up to +600°C cable -50 up to +350°C probe ø6x100mm cable length 2.7m without screw connection 3-wire		
	Part No.	Ref. No.	50305010 65180530 LAR50305010 LAR65180530 R50305010 R65180530
	transformer primary 230VAC secondary 12VAC 3VA secondary 0.25A H 40mm L 45mm W 50mm connection screw 50/60Hz type 153/M		
	Part No.	Ref. No.	—
	temperature probe Pt100 cable silicone probe -100 up to 450°C cable -50 up to +180°C probe ø6x100mm cable length 1.5m without screw connection 2-wire resistor 0.1kOhm		
	Part No.	Ref. No.	—
	temperature probe Pt100 cable silicone probe -100 up to 450°C cable -50 up to +180°C probe ø6x100mm cable length 3m without screw connection 2-wire resistor 0.1kOhm		
	Part No.	Ref. No.	—
	temperature probe Pt100 cable Vetrotex probe -200 up to +600°C cable -50 up to +350°C probe ø6x100mm cable length 1.4m without screw connection 2-wire resistor 0.1kOhm		

EVCO - EVERY CONTROL

refrigeration controllers

built-in version



1			
Part No.	379820	Ref. No.	1681114 BN1681114
description	electronic controller EVERY CONTROL type EVC20S35N7ALX30 mounting measurements 165x45mm 230V voltage AC NTC relay outputs 3 NO-16A(5) NO-8A(4) CO-8A(4) NTC NTC DI for fridge front measurementsmm built-in depth 56mm protection IP00 yes yes yes -40° up to 105°C display 4 digits		



1			
Part No.	379850	Ref. No.	1681118 936092 BN1681118 FR936092
description	electronic controller EVERY CONTROL type EVC20S35N7ALX40 mounting measurements 165x45mm 230V voltage AC NTC relay outputs 4 NO-16A(5) NO-8A(4) CO-8A(4) NO-8A(4) NTC NTC DI DI for fridge front measurementsmm built-in depth 56mm protection IP00 yes yes yes -40 up to +99°C display 4 digits		

SHANGFANG

accessories



1			
Part No.	379054	Ref. No.	50305010 65180530 LAR50305010 LAR65180530
description	transformer primary 230VAC secondary 12VAC 3VA secondary 0.25A H 40mm L 45mm W 50mm connection screw 50/60Hz type 153/M		
For models:	ME004L, ME004S, ME104L, ME104S, ME105L, ME105S, ME106L, ME106S, ME110L, ME110S, ME120L, ME120S, ME210L, ME210S, ME220L, ME220S, MG105L, MG105S, MG106L, MG106S, MG110L, MG110S, MG120L, MG120S, MG210L, MG210S, MG220L, MG220S, MME10, MME40, RE05, RE07, RE10, RE20, RE24, RG05, RG10, RG20, RG24, RG40		

TECNOLOGIC

universal controllers

built-in version



1			
Part No.	379268	Ref. No.	50304860 LAR50304860 LAR65340010
description	electronic controller TECNOLOGIC type TLK38FCR mounting measurements 71x29mm Pt100		
For models:	ME05, ME10, ME15, ME20, ME21, ME24, ME40, MG05, MG10, MG15, MG20, MG21, MG24, MG40, MME10, MME40, RE05, RE07, RE10, RE20, RE24, RG05, RG10, RG20, RG24, RG40		



miscellaneous

refrigeration controllers



1			
Part No.	378411	Ref. No.	996595 FR996595
description	power PCB EVCO type EVC80P16P7FRL01 mounting measurements 170x120mm		

probes

universal probes

temperature probes



1			
Part No.	379130 ¹	Ref. No.	50305101 65325000 LAR50305101 LAR65325000
description	temperature probe Pt100 cable Vetrotex probe -200 up to +600°C cable -50 up to +350°C probe ø6x100mm cable length 1.4m without screw connection 3-wire resistance at 0°C 1000hm		

¹3-wire



1			
Part No.	379050 ¹	Ref. No.	65325010 LAR65325010 R65320160
description	temperature probe Pt100 cable Vetrotex probe -200 up to +600°C cable -50 up to +350°C probe ø6x100mm cable length 2.7m without screw connection 3-wire		
For models:	EPE156T, EPEV15T, EPG156T, EPGV15T, GEMT21P, GEMT21T, GEMT40P, GEMT40T, GEVT21P, GEVT21T, GEVT40P, GEVT40T, GGMT21P, GGMT21T, GGMT40P, GGMT40T, GGV21P, GGV21T, GGV40P, GGV40T, HME201P, HME201T, HME202P, HME202T, HMG201P, HMG201T, HMG202P, HMG202T, HVE201P, HVE201T, HVE202P, HVE202T, HVG201P, HVG201T, HVG202P, HVG202T, ME201D, ME202D, ME220D, ME220H, ME220P, ME220T, MEC24H, MEC40H, MEMT21D, MEMT21P, MEMT40D, MEVT21D, MEVT21P, MEVT40D...(Other models you can see in the webshop)		

¹3-wire



1			
Part No.	379064	Ref. No.	65320540 995562 FR995562 RA930008 SIRRA930008
description	temperature probe PTC 1k0hm cable silicone probe -50 up to +150°C cable -50 up to +180°C probe ø6x40mm cable length 3m without screw connection 2-wire		
For models:	DP112S		

1			
Part No.	381363	Ref. No.	65320220 LAR65320220
description	temperature probe thermocouple K (NiCr-Ni) probe -50 up to 1150°C cable -50 up to +180°C cable length 1.5m thread M10x1 adapter length 93mm adapter ø 6mm cable colours silver/yellow probe L 90/14mm probe ø 6/3mm		
For models:	HME061X, HME101X, HME102X, HME201X, HME202X, HMG061X, HMG101X, HMG102X, HMG201X, HMG202X, HVE061X, HVE101X, HVE102X, HVE201X, HVE202X, HVG061X, HVG101X, HVG102X, HVG201X, HVG202X		

core probes

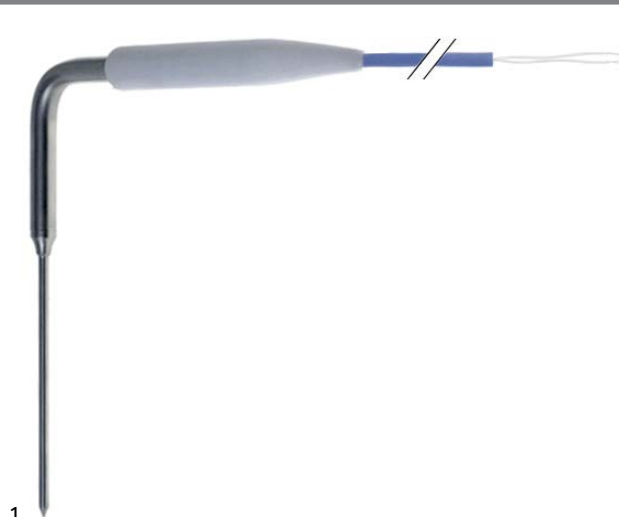

1			
Part No.	378392	Ref. No.	996424 FR6638200 FR996424
description	core temperature probe Pt1000 universal angled probe -40 up to +120°C cable -10 up to 100°C cable PVC probe ø4x100mm cable length 5m 2-wire resistance at 0°C 10000hm for blast chiller		

producer-specific probes

probes





1			
Part No.	379143	Ref. No.	50305111 65320150 65325020 KAR65LAR65320150 LAR50305111 LAR65325020
description	temperature probe Pt100 cable Vetrotex probe -200 up to +600°C cable -50 up to +350°C connection 2-wire thread probe ø3-6x90mm cable length 5m		
For models:	ME20, ME220D, ME220H, ME220P, ME220T, MEC40H, MG20, MG220D, MG220H, MG220P, MG220T, MGC40H, MGC40P, VE220D, VE220H, VE220P, VG220D, VG220H, VG220P, VGC24H		

spare parts for 379143			
	Part No.	100909	Ref. No.
			62060223 LA62060223 LAR62060223 R62060223
union screw thread M10x1 for pipe ø 6mm Qty 1 pcs			
	Part No.	101286	Ref. No.
			62070023 LA62070023 LAR62070023 R62070023
olive ID ø 6mm Qty 1 pcs			





			
Part No.	379711	Ref. No.	RA932000 RA932001 SIRA932001 SIRRA932000 SIRRA932001
description	temperature probe PTC 1kOhm cable silicone probe -50 up to +150°C cable -50 up to +180°C connection coded plug thread probe ø6x40mm cable length 3.5m		
For models:	XESH6X40, XESH6X40A, XESH6X40B, XESH6X41, XESH6X41A, XESH6X41B, XESH6X42, XESH6X42A, XESH6X42B, XESH6X42C, XESH6X42D, XESH6X43, XESH6X43A, XESH6X43B, XESH6X43C, XESH6X43D, XESH6X44, XESH6X44A, XESH6X44B, XESH6X45, XESH6X46, XESH6X46A, XESH6X46B, XESH6X46C, XESH6X46D, XESH6X47, XESH6X48, XESH6X49, XESH6X50, XESH6X51, XESH6X51A, XESH6X51B, XESH6X51C, XESH6X51D, XESH6X51E, XESH6X51F, XESH6X51G, XESH6X51H, XESH6X52, XESH6X53, XESH6X53A, XESH6X53B, XESH6X53C, XESH6X53D, XESH6X53E, XESH6X53F, XESH6X53G, XESH6X53H, XESH6X54, XESH6X55...(Other models you can see in the webshop)		

			
Part No.	379511	Ref. No.	65320250 65320270 A34100660 LA65320270 LAR65320250 LAR65320270
description	temperature probe thermocouple J cable silicone probe -50 up to +750°C cable -50 up to +180°C connection 2-wire thread probe ø3x150mm cable length 3m		
For models:	LA16, LV16, PE108D, PE115K, RB072E, RM262E		

			
Part No.	381463	Ref. No.	65320230 LAR65320230
description	temperature probe thermocouple K (NiCr-Ni) cable glass fibre thread M9x1 probe 6x80 cable length 3m		
For models:	HME201X, HME202X, HMG201X, HMG202X, HVE201X, HVE202X, HVG201X, HVG202X		

core probes

			
Part No.	379134	Ref. No.	65320900 LA65320900 LAR65320900
description	core temperature probe Pt100 cable PTFE probe -40 up to +250°C cable -40 up to +250°C connection plug probe ø4x100mm thread cable length 1m handle ø 15mm handle length 83mm		
For models:	CVE004H, CVE104H, CVE105H, CVG105H, EM010M+SC, EM106H, EM106M+SC, EM106P, EM110H, EM110M+SC, EM110P, EM210H, EM210M+SC, EM210P, EV106H, EV106M+SC, EV106P, EV110H, EV110M+SC, EV110P, EV210H, EV210M+SC, EV210P, GM106H, GM106M+SC, GM106P, GM110H, GM110M+SC, GM110P, GM210H, GM210M+SC, GM210P, GV106H, GV106M+SC, GV106P, GV110H, GV-110M+SC, GV110P, GV210H, GV210M+SC, GV210P, ME061M, ME101M, ME102M, ME106H, ME106P, ME106X, ME110H, ME110P, ME110X... (Other models you can see in the webshop)		

			
Part No.	379135	Ref. No.	65320690 65320700 65320730 65320740 65320770 65320780 65320810 65320820 65320850 65320860 65325200 65325210 65325220 65325230 65325240 65325250 65325800 LAR65320690 LAR65320700 LAR65320730 LAR65320740 LAR65320770 LAR65320780 LAR65320810 LAR65320820 LAR65320850 LAR65320860 LAR65325200 LAR65325210 LAR65325220 LAR65325230 LAR65325240 LAR65325800
description	core temperature probe Pt100 cable PTFE probe -40 up to +250°C cable -40 up to +250°C connection plug probe ø4x100mm thread cable length 1m handle ø 15mm handle length 83mm		
For models:	ME004L, ME104L, ME105L, ME105S, ME106L, ME106T, ME110L, ME110T, ME120L, ME120S, ME120T, ME210L, ME210T, ME220L, ME220S, ME220T, MG105L, MG105S, MG106L, MG106T, MG110L, MG110T, MG120L, MG120T, MG210L, MG210T, MG220L, MG220T, VE004S, VE104S, VE105S, VE106L, VE106T, VE110L, VE110T, VE120L, VE210L, VE210T, VG105S, VG106L, VG106T, VG110L, VG110S, VG110T, VG210L, VG210S, VG210T		

			
Part No.	379132	Ref. No.	50305121 65320180 LAR50305121 LAR65320180
description	core temperature probe Pt100 cable SS corrugated hose probe -40 up to +250°C cable -40 up to +250°C connection 2-wire probe ø4x100mm thread 1/8" cable length 2.5m handle ø 9mm handle length 85mm		
For models:	ME05, ME10, ME20, ME24, MG05, MG10, MG20, MG24, MME10, RE05, RE07, RE20, RE24, RG05, RG20, RG24		

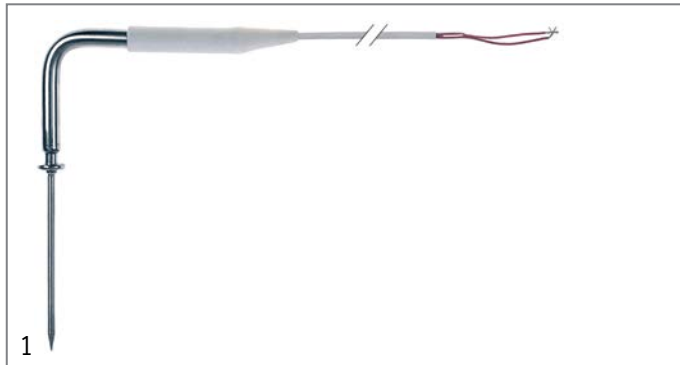
Part No.	379544	Ref. No.	RA930011 RA930013 SIRA930013 SIRRA930011 SIRRA930013
description	core temperature probe Pt1000 cable silicone probe -40 up to +120°C cable -50 up to +180°C connection 2-wire probe ø4x100mm thread cable length 3.6m handle ø 16mm handle length 120mm		
For models:	XESH6X40, XESH6X40A, XESH6X40B, XESH6X41, XESH6X41A, XESH6X41B, XESH6X42, XESH6X42A, XESH6X42B, XESH6X43, XESH6X43A, XESH6X43B, XESH6X43C, XESH6X43D, XESH6X44, XESH6X44A, XESH6X44B, XESH6X45, XESH6X46, XESH6X46A, XESH6X46B, XESH6X47, XESH6X48, XESH6X49, XESH6X50, XESH6X51, XESH6X51A, XESH6X51B, XESH6X51C, XESH6X51D, XESH6X52, XESH6X53, XESH6X53A, XESH6X53B, XESH6X53C, XESH6X53D, XESH6X54, XESH6X55, XESH6X55A, XESH6X55B, XESH6X56, XESH6X57, XESH6X57A, XESH6X57B, XESH6X57C, XESH6X57D, XESH6X58, XESH6X59, XESH6X59A, XESH6X59B... (Other models you can see in the webshop)		

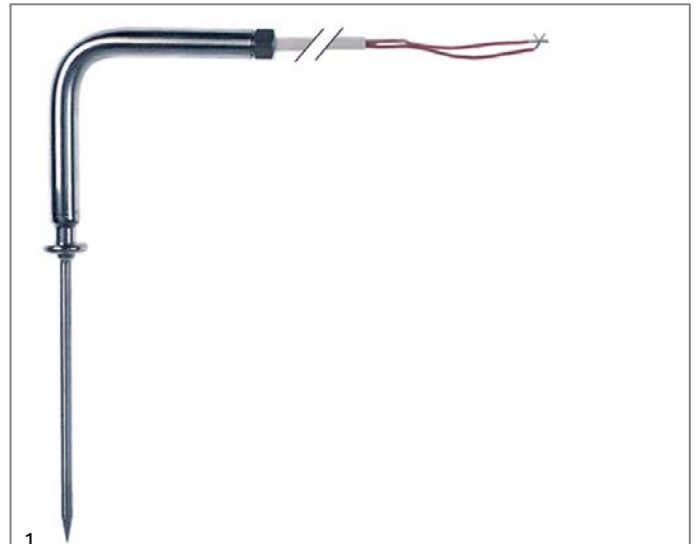

Part No.	379663	Ref. No.	R65320430 RA930004C RA930010 SIRA930010 SIRRA930010
description	core temperature probe PTC 1kOhm cable silicone probe -40 up to +120°C cable -50 up to +180°C connection 2-wire probe ø4x100mm thread cable length 3m handle ø 10mm handle length 65/65mm		
For models:	DP112S		

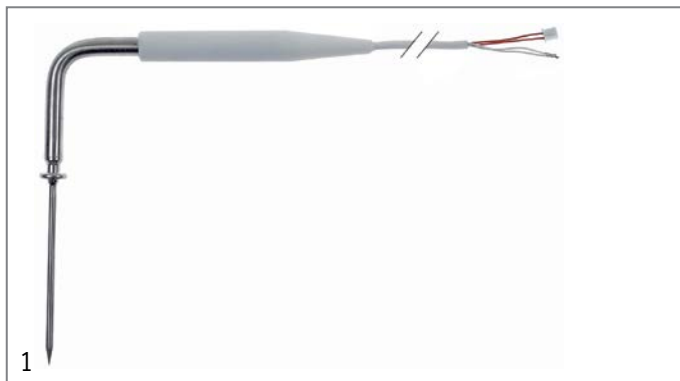

Part No.	379757	Ref. No.	RA930012 RA930014 SIRA930014 SIRRA930014
description	core temperature probe Pt1000 cable silicone probe -40 up to +120°C cable -50 up to +180°C connection 2-wire probe ø4x100mm thread cable length 3.6m handle ø 16mm handle length 125mm		
For models:	XESH6X40, XESH6X40A, XESH6X40B, XESH6X41, XESH6X41A, XESH6X41B, XESH6X42, XESH6X42A, XESH6X42B, XESH6X42C, XESH6X42D, XESH6X43, XESH6X43A, XESH6X43B, XESH6X44, XESH6X44A, XESH6X44B, XESH6X45, XESH6X46, XESH6X46A, XESH6X46B, XESH6X46C, XESH6X46D, XESH6X47, XESH6X48, XESH6X49, XESH6X50, XESH6X51, XESH6X51A, XESH6X51B, XESH6X51C, XESH6X51D, XESH6X51E, XESH6X51F, XESH6X51G, XESH6X51H, XESH6X52, XESH6X53, XESH6X53A, XESH6X53B, XESH6X53C, XESH6X53D, XESH6X53E, XESH6X53F, XESH6X53G, XESH6X53H, XESH6X54, XESH6X55, XESH6X55A, XESH6X55B... (Other models you can see in the webshop)		



Part No.	401693	Ref. No.	65320550 LAR65320550 RA930002 SIRA930002 SIRRA930002
description	core temperature probe PTC 1kOhm cable silicone probe -40 up to +120°C cable -50 up to +180°C connection 4-wire probe ø4x100mm thread cable length 3m handle ø 10mm handle length 65/65mm		

1			
Part No.	379834	Ref. No.	65491200 LAR65491200
description	core temperature probe thermocouple J (Fe-CuNi) cable PTFE probe -40 up to +250°C cable -40 up to +250°C connection plug probe ø3.5x90mm thread cable length 1.05m handle ø 12mm handle length 90mm		



1			
Part No.	379510	Ref. No.	65321100 65321102 LA65321102 LAR65321100 LAR65321102
description	core temperature probe thermocouple K (NiCr-Ni) cable PTFE probe -40 up to +250°C cable -40 up to +250°C connection 6-pin connector probe ø3.5x90mm thread cable length 1.1m handle ømm handle length 90mm		
For models:	GEMT06T, GEMT10T, GEMT20T, GEMT21T, GEMT40T, GEVT06T, GEVT10T, GEVT20T, GEVT21T, GEVT40T, GGMT06T, GGMT10T, GGMT20T, GGMT21T, GGMT40T, GGVT06T, GGVT10T, GGVT20T, GGVT21T, GGVT40T, HME061T, HME061X, HME101T, HME101X, HME102T, HME102X, HME201T, HME201X, HME202T, HME202X, HMG061T, HMG061X, HMG101T, HMG101X, HMG102T, HMG102X, HMG201T, HMG201X, HMG202T, HMG202X, HVE061T, HVE061X, HVE101T, HVE101X, HVE102T, HVE102X, HVE201T, HVE201X, HVE202T, HVE202X...(Other models you can see in the webshop)		



1			
Part No.	379773 ¹	Ref. No.	65321120 LA65321122 LAR65321120
description	core temperature probe thermocouple K (NiCr-Ni) cable PTFE probe -40 up to +250°C cable -40 up to +250°C connection plug probe ø3.5x90mm thread cable length 1.1m handle ømm handle length 90mm		
For models:	AVE07D, AVE10D, AVE10P, EMT06D, GEMT06P, GEMT10P, GEMT20P, GEMT21P, GEMT40P, GEVT06P, GEVT10P, GEVT20P, GEVT21P, GEVT40P, GGMT06P, GGMT10P, GGMT20P, GGMT21P, GGMT40P, GGVT06P, GGVT10P, GGVT20P, GGVT21P, GGVT40P, GMT06D, GMT20D, GMT20P, GVT06D, GVT20D, HME061P, HME101P, HME102P, HME201P, HME202P, HMG061P, HMG101P, HMG102P, HMG201P, HMG202P, HVE061P, HVE101P, HVE102P, HVE201P, HVE202P, HVG061P, HVG101P, HVG102P, HVG201P, HVG202P, ME061D...(Other models you can see in the webshop)		

¹ multipoint probe



1			
Part No.	403800	Ref. No.	LA65301110
description	temperature probe Pt100 cable silicone probe -70 up to +500°C connection 2-wire probe ø3x80mm thread M10 cable length 2m handle ø 15mm handle length 120mm		

accessories

plugs/bushes



1			
Part No.	378016	Ref. No.	65320920 LA65320920 LAR65320920
description	female connector 4-pole		
For models:	AVE07D, AVE10D, AVE10P, CVE004H, CVE104H, CVE105H, CVG105H, EM010M+SC, EM106H, EM106M+SC, EM106P, EM110H, EM110M+SC, EM110P, EM210H, EM210M+SC, EM210P, EMT06D, EV106H, EV106M+SC, EV106P, EV110H, EV110M+SC, EV110P, EV210H, EV210M+SC, EV210P, GEMT06P, GEMT10P, GEMT20P, GEMT21P, GEMT40P, GEVT06P, GEVT10P, GEVT20P, GEVT21P, GEVT40P, GGMT06P, GGMT10P, GGMT20P, GGMT21P, GGMT40P, GGVT06P, GGVT10P, GGVT20P, GGVT21P, GGVT40P, GM106H, GM106M+SC, GM106P... (Other models you can see in the webshop)		

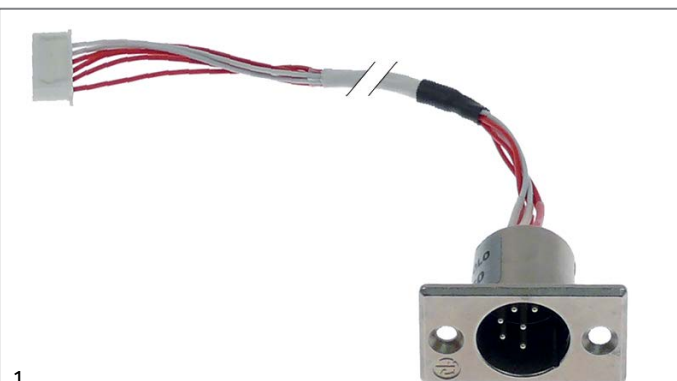

1			
Part No.	381462	Ref. No.	65321360 LA65321360
description	female connector with cable 6-pole for combi-steamer L 1000mm		



1			
Part No.	378017	Ref. No.	65321020 LA65321020 LAR65321020
description	lid for plug contact		
For models:	AVE07D, AVE10D, AVE10P, CVE004H, CVE104H, CVE105H, CVG105H, EM010M+SC, EM106H, EM106M+SC, EM106P, EM110H, EM110M+SC, EM110P, EM210H, EM210M+SC, EM210P, EMT06D, EV106H, EV106M+SC, EV106P, EV110H, EV110M+SC, EV110P, EV210H, EV210M +SC, EV210P, GEMT06P, GEMT06T, GEMT10P, GEMT10T, GEMT20P, GEMT20T, GEMT21P, GEMT21T, GEMT40P, GEMT40T, GEVT06P, GEVT06T, GEVT10P, GEVT10T, GEVT20P, GEVT20T, GEVT21P, GEVT21T, GEVT40P, GEVT40T, GGMT06P, GGMT06T, GGMT10P...(Other models you can see in the webshop)		



miscellaneous

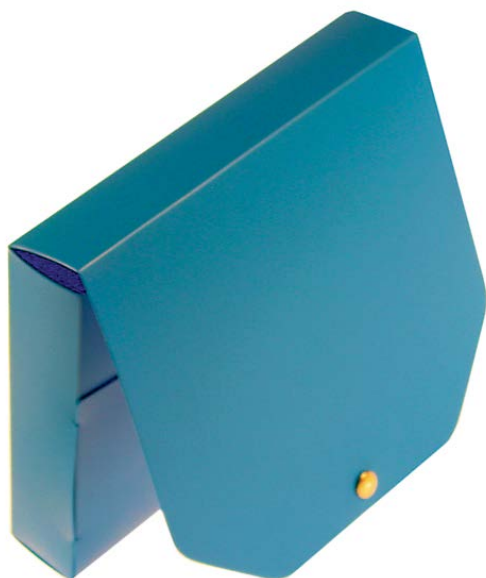

1

Part No.	379856	Ref. No.	86020420 LAR86020420
description	bag for core temperature probe		
For models:	AVE07D, AVE10D, AVE10P, CVE004H, CVE104H, CVE105H, CVG105H, EM010M+SC, EM106H, EM106M+SC, EM106P, EM110H, EM110M+SC, EM110P, EM210H, EM210M+SC, EM210P, EMT06D, EV106H, EV106M+SC, EV106P, EV110H, EV110M+SC, EV110P, EV210H, EV210M+SC, EV210P, GEMT06P, GEMT06T, GEMT10P, GEMT10T, GEMT20P, GEMT20T, GEMT21P, GEMT21T, GEMT40P, GEMT40T, GEVT06P, GEVT06T, GEVT10P, GEVT10T, GEVT20P, GEVT20T, GEVT21P, GEVT21T, GEVT40P, GEVT40T, GGMT06P, GGMT06T, GGMT10P...(Other models you can see in the webshop)		

electronics

frequency converters



1

Part No.	403841	Ref. No.	65140830 65140890 LA65140890 LAR65140830 LAR65140890
description	frequency converter with heat sink for combi-steamer L 135mm W 135mm 800W ECS P0010205-0		
For models:	EPE056T, EPE086T, EPE156T, EPEV05T, EPEV08T, EPEV15T, EPG056T, EPG086T, EPG156T, EPGV05T, EPGV08T, EPGV15T, GEMT10T, GEMT20T, GEMT21T, GEMT40T, GEVT10T, GEVT20T, GEVT21T, GEVT40T, GGMT10T, GGMT20T, GGMT21T, GGMT40T, GGVT10T, GGVT20T, GGVT21T, GGVT40T, HME101T, HME101X, HME102T, HME102X, HME201T, HME201X, HME202T, HME202X, HMG101T, HMG101X, HMG102T, HMG102X, HMG201T, HMG201X, HMG202T, HMG202X, HVE101T, HVE101X, HVE102T, HVE102X, HVE201T, HVE201X...(Other models you can see in the webshop)		

rectifiers



1

Part No.	403671	Ref. No.	65301760 LA65301760 LAR65301760
description	rectifier 1000V 25A		

PCBs



1

Part No.	400192	Ref. No.	65300990 LAR65300990
description	calibrator		

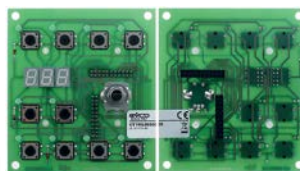

1

Part No.	403749	Ref. No.	LA65301290
description	control PCB combi-steamer MODULINE/LAINOX L 95mm W 105mm with potentiometer		

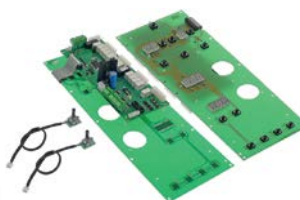



1

Part No.	403472	Ref. No.	65301400 LAR65301400
description	control PCB combi-steamer VE 061/1011 L 410mm W 150mm suitable for LAINOX		
For models:	AVE10P, MEVT06P, MEVT10P, MEVT20P, MEVT21P, MEVT40P, MGVT06P, MGVT10P, MGVT20P, MGVT21P, MGVT40P, VE061P, VE101P, VE102P, VE201P, VE202P, VG061P, VG101P, VG102P, VG201P, VG202P		





			
1			
Part No.	402427	Ref. No.	65301370 65301390 LA65301390 LAR65301370 LAR65301390
description	control PCB L 410mm W 150mm for LAINOX buttons 13		
For models:	AVE10P, GMT20P, ME061H, ME061P, ME101H, ME101P, ME102H, ME102P, ME201H, ME201P, ME202H, ME202P, MEMT06P, MEMT10P, MEMT20P, MEMT21P, MEMT40P, MEVT06P, MEVT10P, MEVT20P, MEVT21P, MEVT40P, MG061H, MG061P, MG101H, MG101P, MG102H, MG102P, MG201H, MG201P, MG202H, MG202P, MGMT06P, MGMT10P, MGMT20P, MGMT21P, MGMT40P, MGV06P, MGV10P, MGV20P, MGV21P, MGV40P, VE061P, VE101P, VE102P, VE201P, VE202P, VG061P, VG101P, VG102P...(Other models you can see in the webshop)		

			
1			
Part No.	403750	Ref. No.	LA65301090
description	control PCB oven MODULINE/LAINOX L 147mm W 34mm		

			
1			
Part No.	403751	Ref. No.	LA65301380
description	control PCB warmer L 147mm W 70mm		



			
1			
Part No.	401769	Ref. No.	RA910066 SIRRA910066
description	display PCB with keypad		
For models:	DP112S		

			
1			
Part No.	400149	Ref. No.	65300580 LAR65300580
description	keypad PCB		
For models:	VE004X, VE104X, VE105X, VE155X, VG105X		

			
1			
Part No.	401332	Ref. No.	65300540 LAR65300540
description	keypad PCB		
For models:	EM010M+SC, EM106M+SC, EM110M+SC, EM210M+SC, EV106M+SC, EV110M+SC, EV210M+SC, GM106M+SC, GM110M+SC, GM210M+SC, GV106M+SC, GV110M+SC, GV210M+SC, ME061M, ME101M, ME102M, ME201M, ME202M, MEC20X, MG061M, MG101M, MG102M, MG201M, MG202M, MGC20X, MVE071M, MVE101M, VE061M, VE101M, VE102M, VE201M, VE202M, VG061M, VG101M, VG102M, VG106X, VG201M, VG202M		

			
1			
Part No.	401957	Ref. No.	65302180 LAR65302180
description	keypad PCB		
For models:	GEMT06P, GEMT10P, GEMT20P, GEMT21P, GEMT40P, GEVT06P, GEVT10P, GEVT20P, GEVT21P, GEVT40P, GGMT06P, GGMT10P, GGMT20P, GGMT21P, GGMT40P, GGV06P, GGV10P, GGV20P, GGV21P, GGV40P, HME061P, HME101P, HME102P, HME201P, HME202P, HMG061P, HMG101P, HMG102P, HMG201P, HMG202P, HVE061P, HVE101P, HVE102P, HVE201P, HVE202P, HVG061P, HVG101P, HVG102P, HVG201P, HVG202P, MME071P, MME101P, MME102P, MMG071P, MMG101P, MMG102P, MVE071P, MVE101P, MVE102P, MVG071P... (Other models you can see in the webshop)		

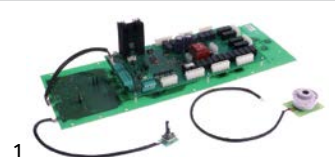



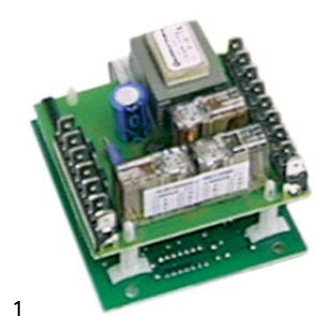

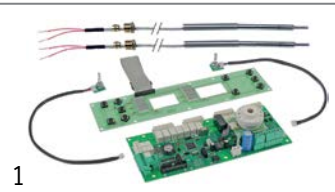
			
1			
Part No.	401591	Ref. No.	65301410 65301420 65301460 LAR65301410 LAR65301420 LAR65301460
description	keypad PCB combi-steamer ME061T complete		
For models:	ME061T, ME101T, ME102T, ME201T, ME202T, MG061T, MG101T, MG102T, MG201T, MG202T		
spare parts for	401591		
	Part No.	350086	Ref. No. 65301440 65321440 LA65301440 LAR65301440 LAR65321440 R65301440 R65321440
buzzer 12VDC connection cable 200mm PCB buzzer 20dB			

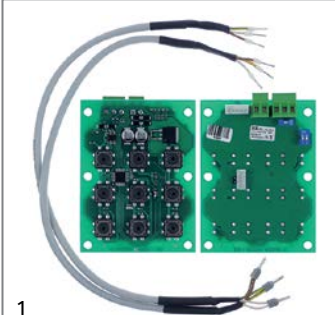
			
1			
Part No.	400140	Ref. No.	65300500 LAR65300500
description	keypad PCB combi-steamer ME106M with keypad		
For models:	ME106M, ME110M, ME120M, ME210M, MG106M, MG110M, MG120M, MG210M, MG220M, VE106M, VE110M, VE120M, VE210M, VE220M, VG106M, VG110M, VG120M, VG210M, VG220M		

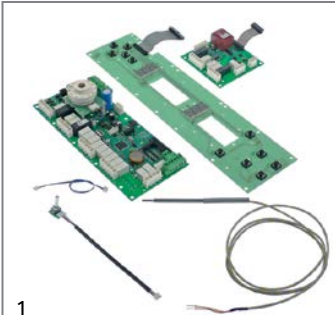
			
1			
Part No.	401661	Ref. No.	65301800 65301810 65301820 65301830 LAR65301800 LAR65301810 LAR65301820 LAR65301830
description	keypad PCB combi-steamer MVE04 kit		
For models:	BPE044P, BPE054P, BPG044P, BPG054P, MVE042P, MVE051P, MVG051P, VE042P, VE051P, VE055P, VG051P		

			
1			
Part No.	403672	Ref. No.	65302470 LAR65302470
description	keypad PCB combi-steamer SAPIENS L 98mm W 74mm		

			
1			
Part No.	403498	Ref. No.	65302160 LAR65302160
description	keypad PCB combi-steamer with steam generator suitable for HME/HVE/HVG/HMG suitable for LAINOX 3 type K probes		
For models:	GEMT06P, GEMT10P, GEMT20P, GEMT21P, GEMT40P, GGMT06P, GGMT10P, GGMT20P, GGMT21P, GGMT40P, HME061P, HME101P, HME102P, HME201P, HME202P, HMG061P, HMG101P, HMG102P, HMG201P, HMG202P, MME071P, MME101P, MME102P, MMG071P, MMG101P, MMG102P		
spare parts for	403498		
	Part No.	379130	Ref. No. 50305101 65325000 LAR50305101 LAR65325000 R50305101 R65325000
temperature probe Pt100 cable Vetrotex probe -200 up to +600°C cable -50 up to +350°C probe ø6x100mm cable length 1.4m without screw connection 3-wire resistance at 0°C 1000hm			
	Part No.	381363	Ref. No. 65320220 LAR65320220 R65320220
temperature probe thermocouple K (NiCr-Ni) probe -50 up to 1150°C cable -50 up to +180°C cable length 1.5m thread M10x1 adapter length 93mm adapter ø 6mm cable colours silver/yellow probe L 90/14mm probe ø 6/3mm			
accessories for	403498		
	Part No.	381363	Ref. No. 65320220 LAR65320220 R65320220
temperature probe thermocouple K (NiCr-Ni) probe -50 up to 1150°C cable -50 up to +180°C cable length 1.5m thread M10x1 adapter length 93mm adapter ø 6mm cable colours silver/yellow probe L 90/14mm probe ø 6/3mm			

1

Part No.	400142	Ref. No.	65300370 65300570 LAR65300370 LAR65300570
description	keypad PCB L 100mm W 95mm buttons 8		
For models:	ME106X, ME110X, ME120X, ME210X, ME220M, ME220X, MG106X, MG110X, MG120X, MG210X, MG220X, VE106X, VE110X, VE120X, VE210X, VE220X, VG106X, VG110X, VG120X, VG210X, VG220X		



1

Part No.	400150	Ref. No.	65300830 LAR65300830
description	main PCB		
For models:	CVE004H, CVE104H, CVE105H, CVG105H, VE004D, VE004H, VE104D, VE104H, VE105D, VE105H, VE155H, VG105D, VG105H		

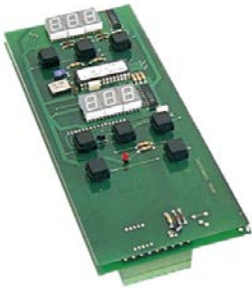

1

Part No.	400154	Ref. No.	50304890 65300070 LAR50304890 LAR65300070
description	keypad PCB L 217mm W 112mm with display		
For models:	FV03, FV06		

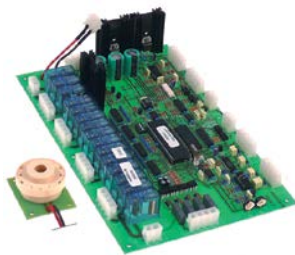

1

Part No.	400174	Ref. No.	65300190 LAR65300190
description	main PCB		
For models:	ME106T, ME110T, ME120T, ME210T, ME220T, MG106T, MG110T, MG120T, MG210T, MG220T, VE106T, VE110T, VE210T, VG106T, VG110T, VG210T		



1

Part No.	401352	Ref. No.	65301330 LAR65301330 scheda tastiera -D-2004
description	keypad PCB temperature		
For models:	GMT06D, GMT20D, ME061D, ME101D, ME102D, ME201D, MG061D, MG101D, MG102D, MG201D, MG202D, VE061D, VE101D, VE102D, VE201D, VE202D, VG061D, VG101D, VG102D, VG201D, VG202D		



1

Part No.	403209	Ref. No.	65302280 LA65302280 LAR65302280
description	main PCB combi-steamer REV051/077/1015 L 250mm W 105mm LAINOX		

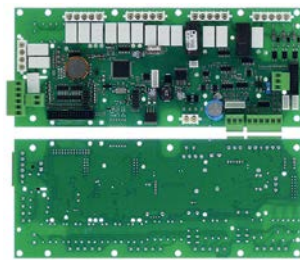



1

Part No.	403824	Ref. No.	65302250 LA65302250 LAR65302250
description	main PCB for combi-steamer L 250mm W 103mm		





			
1			
Part No.	400148	Ref. No.	65300550 LAR65300550
description	PCB		
For models:	VE004X, VE104X, VE105X, VE155X, VG105X		

			
1			
Part No.	400141	Ref. No.	65300520 910059 LAR65300520 RA910060
description	PCB blast chiller suitable for LAINOX		
For models:	DP112S, ME106X, ME110X, ME120X, ME210X, ME220X, ME227X, MG106X, MG110X, MG120X, MG210X, MG220X, MG227X, VE106X, VE110X, VE120X, VE210X, VE220X, VG106X, VG110X, VG120X, VG210X, VG220X		

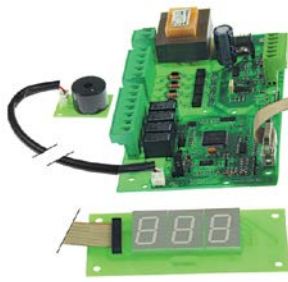
			
1			
Part No.	401333	Ref. No.	65300490 LA65300490 LAR65300490
description	PCB		
For models:	EM010M+SC, EM106M+SC, EM110M+SC, EM210M+SC, EV106M+SC, EV110M+SC, EV210M+SC, GM106M+SC, GM110M+SC, GM210M+SC, GV106M+SC, GV110M+SC, GV210M+SC, ME061M, ME101M, ME102M, ME201M, ME202M, MEC20X, MG061M, MG101M, MG102M, MG201M, MG202M, MGC20X, MVE071M, MVE101M, VE061M, VE101M, VE102M, VE201M, VE202M, VG061M, VG101M, VG102M, VG106X, VG201M, VG202M		

			
1			
Part No.	401195	Ref. No.	3103245
description	PCB combi-steamer CV10E complete without potentiometer		

			
1			
Part No.	401341	Ref. No.	63130020 63130021 LA63130021 LAR63130020 LAR63130021
description	PCB		
For models:	ACG10M, CG051M, CG071M, CG100M, CG200M, GMT06D, GMT20D, GMT20P, GVT06D, GVT20D, MACG05M, MACG07M, MACG10M, MACG20M, MG061D, MG061H, MG061M, MG061P, MG061T, MG101D, MG101H, MG101M, MG101P, MG101T, MG102D, MG102H, MG102M, MG102P, MG102T, MG201D, MG201H, MG201M, MG201P, MG201T, MG202D, MG202H, MG202M, MG202P, MG202T, MGMT06D, MGMT06P, MGMT10D, MGMT10P, MGMT20D, MGMT20P, MGMT21D, MGMT21P, MGMT40D, MGMT40P, MGVT06D...(Other models you can see in the webshop)		

			
1			
Part No.	402825	Ref. No.	65301480 65301480 EVCO LAR65301480 LAR65301480 EVCO
description	PCB combi-steamer GEMT L 130mm W 86mm new edition level control steam generator EVCO		
For models:	EMT06D, GEMT06P, GEMT10P, GEMT20P, GEMT21P, GEMT40P, GGMT06P, GGMT10P, GGMT20P, GGMT21P, GGMT40P, GMT06D, GMT20D, GMT20P, HME061P, HME101P, HME102P, HMG061P, HMG101P, HMG102P, HMG201P, HMG202P, ME061D, ME061H, ME061P, ME101D, ME101H, ME101P, ME102D, ME102H, ME102P, ME201D, ME201H, ME201P, ME202D, ME202H, ME202P, MEMT06D, MEMT06P, MEMT10D, MEMT10P, MEMT20D, MEMT20P, MEMT21D, MEMT21P, MEMT40D, MEMT40P, MG061D, MG061H, MG061P...(Other models you can see in the webshop)		

1

Part No.	401962	Ref. No.	65301910 LA65301910 LAR65301910
description	PCB combi-steamer HME 611/1011		
For models:	HME061P, HME061X, HME101P, HME101X, HME102P, HME102X, HME201P, HME201X, HME202P, HME202X, HMG061P, HMG061X, HMG101P, HMG101X, HMG102P, HMG102X, HMG201P, HMG201X, HMG202P, HMG202X, HVE061P, HVE061X, HVE101P, HVE101X, HVE102P, HVE102X, HVE201P, HVE201X, HVE202P, HVE202X, HVG061P, HVG061X, HVG101P, HVG101X, HVG102P, HVG102X, HVG201P, HVG201X, HVG202P, HVG202X, MME071P, MME101P, MME102P, MMG071P, MMG101P, MMG102P, MVE101P, MVE102P, MVG071P, MVG101P...(Other models you can see in the webshop)		



1

Part No.	403668	Ref. No.	65302530 LA65302530 LAR65302530
description	PCB combi-steamer NABOO L 103mm W 85mm suitable for LAINOX		



1

Part No.	403670	Ref. No.	65302510 LA65302510 LAR65302510
description	PCB combi-steamer NABOO suitable for LAINOX model gas		

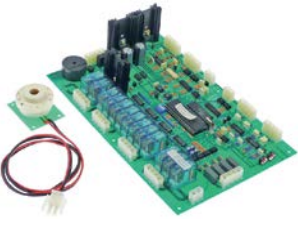

1

Part No.	403101	Ref. No.	65300250 LAR65300250
description	PCB combi-steamer L 269mm W 170mm with buzzer		



1

Part No.	403669	Ref. No.	65302550 LA65302550 LAR65302550
description	PCB combi-steamer SAPIENS L 90mm W 67mm suitable for LAINOX		



1

Part No.	379141	Ref. No.	65300160 LAR65300160
description	PCB combi-steamer ME 110/120		
For models:	ME110L, ME110S, ME120L, ME120S, ME210L, ME210S, ME220L, ME220S, MG106L, MG110L, MG110S, MG120L, MG120S, MG210L, MG210S, MG220L, MG220S, VE106L, VE106S, VE110L, VE110S, VE120L, VE120S, VE210L, VE210S, VG106L, VG106S, VG110L, VG110S, VG210L, VG210S		



1

Part No.	400152	Ref. No.	65300850 LAR65300850
description	PCB core temperature		
For models:	CVE004H, CVE104H, CVE105H, CVG105H, VE004H, VE104H, VE105H, VE155H, VG105H		

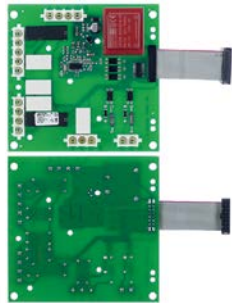

1

Part No.	403827	Ref. No.	LA65302260 LAR65302260
description	PCB for combi-steamer L 106mm W 103mm		

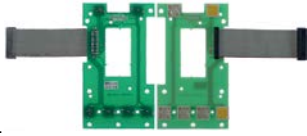

1

Part No.	403838	Ref. No.	LA65302440
description	PCB for combi-steamer L 147mm W 84mm		

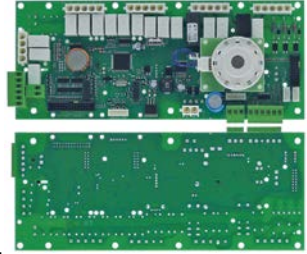

1

Part No.	403825	Ref. No.	LA65302410
description	PCB for combi-steamer L 250mm W 103mm		

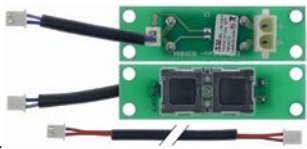

1

Part No.	403833	Ref. No.	65301930 LA65301930 LAR65301930
description	PCB for combi-steamer L 74mm W 22mm		
For models:	HME061X, HME101X, HME102X, HME201X, HME202X, HMG061X, HMG101X, HMG102X, HMG201X, HMG202X, HVE061X, HVE101X, HVE102X, HVE201X, HVE202X, HVG061X, HVG101X, HVG102X, HVG201X, HVG202X		

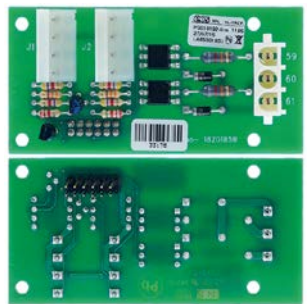

1

Part No.	403828	Ref. No.	65301950 LA65301950 LAR65301950
description	PCB for combi-steamer L 85mm W 42mm		
For models:	HMG061X, HMG101X, HMG102X, HMG201X, HMG202X, HVG061X, HVG101X, HVG102X, HVG201X, HVG202X		

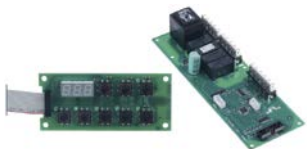

1

Part No.	402923	Ref. No.	65300750 65300751 LAR65300750 LAR65300751
description	PCB for display PCB		
For models:	LA16, LV16		



1

Part No.	400153	Ref. No.	50304940 65300130 LAR50304940 LAR65300130
description	PCB for water level		
For models:	FV03, FV06		



1

Part No.	402922	Ref. No.	65301280 LAR65301280
description	PCB L 175mm W 83mm		



1

Part No.	402973	Ref. No.	63130050 LA63130050 LAR63130050
description	PCB oven BPG044-104 L 140mm W 80mm for cooler control		
For models:	BPG044M, BPG044P, BPG054M, BPG054P, BPG064M, BPG064P, BPG074M, BPG074P, BPG084M, BPG084P, BPG104M, BPG104P, EPG056T, EPG086T, EPG156T, EPGV05T, EPGV08T, EPGV15T, GGMT06P, GGMT06T, GGMT10P, GGMT10T, GGMT20P, GGMT20T, GGMT21P, GGMT21T, GGMT40P, GGMT40T, GGVT06P, GGVT06T, GGVT10P, GGVT10T, GGVT20P, GGVT20T, GGVT21P, GGVT21T, GGVT40P, GGVT40T, HMG061P, HMG061T, HMG101P, HMG101T, HMG102P, HMG102T, HMG102X, HMG201P, HMG201T, HMG202P, HMG202T, HVG061P...(Other models you can see in the webshop)		

1

Part No.	401767	Ref. No.	RA910059 SIRRA910059
description	power PCB		
For models:	DP112S		



1

Part No.	400194	Ref. No.	65300150 LAR65300150
description	reset PCB		
For models:	MG105L, MG105S, MG106L, MG106T, MG110L, MG110S, MG110T, MG120L, MG120S, MG120T, MG210T, MG220L, MG220S, MG220T		

central units



1

Part No.	403082	Ref. No.	65307300 FR966061 LAR65307300 RA910070	
description	control box with probe for blast freezer			
For models:	DP112S			
accessories for	403082			
	Part No.	401767	Ref. No.	RA910059 SIRRA910059
	power PCB			

keypads

front foils



1

Part No.	401294	Ref. No.	67010100 LAR67010100
description	front foil		
For models:	MG105S, VE105S, VG105S		



1

Part No.	401295	Ref. No.	67010110 LAR67010110
description	front foil		
For models:	ME105L, MG105L, VE105S, VG105S		



1

Part No.	401296	Ref. No.	50708710 67010010 LAR50708710 LAR67010010
description	front foil		
For models:	PE08, PE12, PG04, PG08, PG12, RE05, RE07, RE10, RE20, RE24, RG05, RG07, RG10, RG20, RG24, RG40		



1

Part No.	401302	Ref. No.	67010230 LAR67010230
description	front foil		
For models:	VE106S, VE120S, VE210S, VG106S, VG110S, VG210S		



1

Part No.	401303	Ref. No.	67010240 LAR67010240
description	front foil		
For models:	VE106L, VE110L, VE110S, VE120L, VE210L, VG106L, VG110L, VG210L		



1

Part No.	401304	Ref. No.	67010450 LAR67010450
description	front foil		
For models:	CVE004M, CVE104M, VE004M, VE104M		



1 			
Part No.	401308	Ref. No.	67010530 LAR67010530
description	front foil		
For models:	VE106M, VE110M, VE120M, VE210M, VE220M, VG106M, VG110M, VG120M, VG210M, VG220M		

1 			
Part No.	401313	Ref. No.	67012950 LAR67012950
description	front foil		
For models:	ME061M, ME101M, ME102M, ME201M, ME202M, MG061M, MG101M, MG102M, MG201M, MG202M, VE061M, VE101M, VE102M, VE201M, VE202M, VG061M, VG101M, VG102M, VG201M, VG202M		

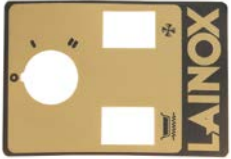
1 			
Part No.	401315	Ref. No.	50708430 67012040 LAR50708430 LAR67012040
description	front foil		
For models:	ME05, ME10, ME15, ME20, ME21, ME24, ME40, MG05, MG10, MG15, MG20, MG21, MG24, MG40		

1 			
Part No.	401316	Ref. No.	50708460 67012050 LAR50708460 LAR67012050
description	front foil		
For models:	ME10, ME15, ME20, ME21, ME24, ME40		

1 			
Part No.	401297	Ref. No.	67010080 LAR67010080
description	front foil blue suitable for LAINOX L 400mm W 75mm		
For models:	ME004S, ME104S, VE004S, VE104S		

1 			
Part No.	511930	Ref. No.	67012200 LAR67012200
description	front foil blue suitable for LAINOX L 430mm W 95mm		
For models:	CGC40M		

1 			
Part No.	401301	Ref. No.	67010031 LAR67010031
description	front foil blue suitable for LAINOX L 435mm W 102mm		
For models:	ME106L, ME110L, ME110S, ME120L, ME120S, ME210L, ME220L, MG106L, MG110L, MG120L, MG210L, MG220L		

1 			
Part No.	401959	Ref. No.	67450510 LAR67450510
description	front foil combi-steamer MVE042P		
For models:	MVE042P		

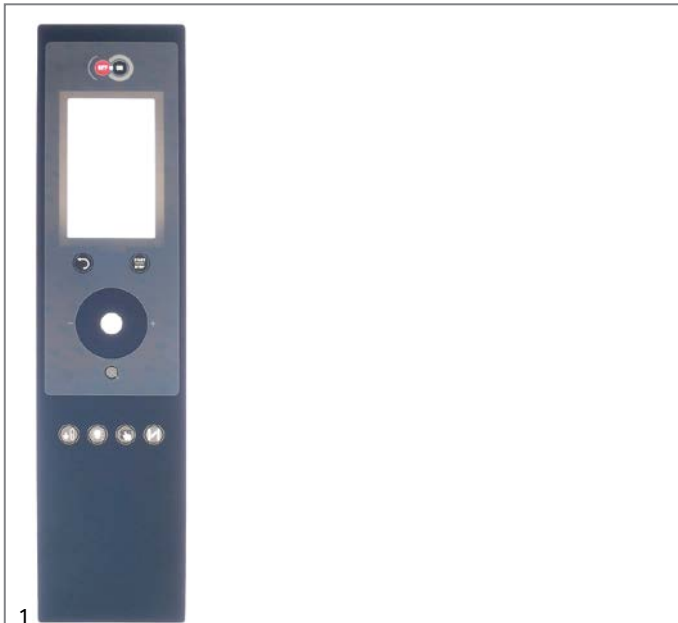

1

Part No.	403820	Ref. No.	67013900 LA67013940 LAR67013900
description	front foil for combi-steamer L 660mm W 160mm		
For models:	HME061X, HME101X, HME102X, HME201X, HME202X, HMG061X, HMG101X, HMG102X, HMG201X, HMG202X, HVE061X, HVE101X, HVE102X, HVE201X, HVE202X, HVG061X, HVG101X, HVG102X, HVG201X, HVG202X		

1

Part No.	401305	Ref. No.	67010460 LAR67010460
description	front foil suitable for LAINOX L 399mm W 74mm		
For models:	VE004X, VE104X		

1

Part No.	401306	Ref. No.	67010490 LAR67010490
description	front foil suitable for LAINOX L 493mm W 75mm		
For models:	CVE105M, CVG105M, VE105M, VE155M, VG105M		

1

Part No.	401293	Ref. No.	67010830 LAR67010830
description	keypad foil		
For models:	MG105L, MG105S, MG106L, MG106S, MG106T, MG110L, MG110S, MG110T, MG120L, MG120S, MG120T, MG210T, MG220L, MG220S, MG220T		

1

Part No.	401307	Ref. No.	67010500 LAR67010500
description	keypad foil		
For models:	VE105X, VE155X, VG105X		

1

Part No.	401309	Ref. No.	67010550 LAR67010550
description	keypad foil		
For models:	VE106X, VE110X, VE120X, VE210X, VE220X, VG106X, VG110X, VG120X, VG210X, VG220X		

1

Part No.	401311	Ref. No.	67010630 LAR67010630
description	keypad foil		
For models:	ME106X, ME110X, ME120X, ME210X, ME220X, MG106X, MG110X, MG120X, MG210X, MG220X		

1

Part No.	401312	Ref. No.	67012960 LAR67012960
description	keypad foil		
For models:	ME061M, ME101M, ME102M, ME201M, ME202M, MG061M, MG101M, MG102M, MG201M, MG202M, VE061M, VE101M, VE102M, VE201M, VE202M, VG061M, VG101M, VG102M, VG201M, VG202M		

1

Part No.	401317	Ref. No.	50708100 67010730 LAR50708100 LAR67010730
description	keypad foil		
For models:	FV03, FV06		

1

Part No.	401319	Ref. No.	50708040 LAR50708040
description	keypad foil		
For models:	PE04		



			
1			
Part No.	401320	Ref. No.	67010780 LAR67010780
description	keypad foil		
For models:	ME106T, ME110T, ME120T, ME210T, ME220T, MG106T, MG110T, MG120T, MG210T, MG220T		

			
1			
Part No.	401321	Ref. No.	67010900 LAR67010900
description	keypad foil		
For models:	VE106T, VE110T, VE210T, VG106T, VG210T		

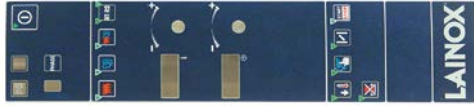
			
1			
Part No.	401322	Ref. No.	67010650 LAR67010650
description	keypad foil		
For models:	ME106D, ME110D, ME120D, ME210D, ME220D, MG106D, MG110D, MG120D, MG210D, MG220D		

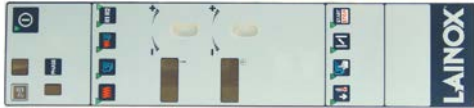
			
1			
Part No.	401323	Ref. No.	67010930 LAR67010930
description	keypad foil		
For models:	VE106D, VE110D, VE120D, VE210D, VE220D, VG106D, VG110D, VG120D, VG210D, VG220D		

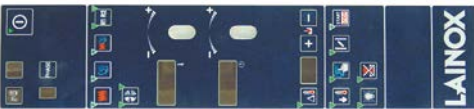
			
1			
Part No.	401324	Ref. No.	67010660 LAR67010660
description	keypad foil		
For models:	ME106H, ME110H, ME120H, ME210H, ME220H, MEC20H, MEC24H, MEC40H, MEK21H, MG106H, MG110H, MG120H, MG210H, MG220H, MGC20H, MGC24H, MGC40H		

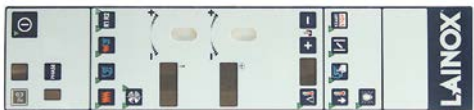
			
1			
Part No.	401325	Ref. No.	67010940 LAR67010940
description	keypad foil		
For models:	VE106H, VE110H, VE120H, VE210H, VE220H, VG106H, VG110H, VG120H, VG210H, VG220H, VGC20H, VGC24H		

			
1			
Part No.	401326	Ref. No.	67010920 LAR67010920
description	keypad foil		
For models:	ME106P, ME110P, ME120P, ME210P, ME220P, MEC20P, MG106P, MG110P, MG120P, MG210P, MG220P, MGC40P		

			
1			
Part No.	401327	Ref. No.	67010950 LAR67010950
description	keypad foil		
For models:	VE106P, VE120P, VE210P, VE220P, VEC20P, VG106P, VG110P, VG120P, VG210P, VG220P		

			
1			
Part No.	401329	Ref. No.	67010870 LAR67010870
description	keypad foil		
For models:	CVE004H, CVE104H, VE004H, VE104H		

			
1			
Part No.	401330	Ref. No.	67012910 LAR67012910
description	keypad foil		
For models:	ME061H, ME101H, ME102H, ME201H, ME202H, MG061H, MG101H, MG101P, MG102H, MG201H, MG202H		

			
1			
Part No.	401349	Ref. No.	67013461 LA67013461 LAR67013461
description	keypad foil		
For models:	VE042P, VE051P, VE055P, VG051P		

			
1			
Part No.	401768	Ref. No.	RA130017 SIRRA130017
description	keypad foil blast chiller suitable for HIBER/LAINOX L 147mm W 95mm		
For models:	DP112S		



			
1			
Part No.	401771	Ref. No.	RA130108 SIRRA130108
description	keypad foil blast chiller suitable for HIBER/LAINOX L 147mm W 95mm		
For models:	DP112S		

			
1			
Part No.	511931	Ref. No.	67901230 LAR67901230
description	keypad foil blue L 270mm W 90mm		

			
1			
Part No.	511932	Ref. No.	67901250 LAR67901250
description	keypad foil blue L 270mm W 90mm		

			
1			
Part No.	401328	Ref. No.	67010850 LAR67010850
description	keypad foil blue L 400mm W 75mm buttons 7		
For models:	VE004D, VE104D		



			
1			
Part No.	511933	Ref. No.	67010770 LAR67010770
description	keypad foil L 430mm W 95mm buttons 17		

membrane keypads

			
1			
Part No.	403673	Ref. No.	67016870 LA67016870 LAR67016870
description	keypad foil combi-steamer NABOO suitable for LAINOX		

solenoid valves

solenoid valves (water)

ELBI			
straight			
			
1			
Part No.	373021	Ref. No.	65110040 65115000 LAR65110040 LAR65115000
description	solenoid valve double straight 230VAC inlet 3/4" outlet 11.5mm output 1x 4.7l/min DN10 ELBI		
For models:	CVE105H, CVE105M, CVG105H, CVG105M, EM010M+SC, EM106H, EM106M, EM106M+SC, EM106P, EM110H, EM110M, EM110M+SC, EM110P, EM210H, EM210M, EM210M+SC, EM210P, GM106H, GM106M, GM106M+SC, GM106P, GM110H, GM110M, GM110M+SC, GM110P, GM210H, GM210M, GM210M+SC, GM210P, ME106D, ME106H, ME106L, ME106M, ME106P, ME106S, ME106T, ME106X, ME110D, ME110H, ME110L, ME110M, ME110P, ME110S, ME110T, ME110X, ME120D, ME120H, ME120L, ME120M, ME120P...(Other models you can see in the webshop)		
spare parts for	373021		
	Part No.	370467	Ref. No. —
	solenoid valve filter suitable for ELBI		
	Part No.	371263	Ref. No. —
	reducer ELBI type EATON (INVENSYS) flow rate 4.7l/min pressure range 0 up to 10bar tolerance ±15/25% grey		





			
1			
Part No.	373017	Ref. No.	50102860 65110010 LA65110010 LAR50102860 LAR65110010
description	solenoid valve single straight 230VAC inlet 3/4" outlet 11.5mm DN10 ELBI		
For models:	EM010M+SC, EM106M, EM106M+SC, EM110M, EM110M+SC, EM210M, EM210M+SC, EV006M, EV106H, EV106M, EV106M+SC, EV106P, EV110H, EV110M, EV110M+SC, EV110P, EV210H, EV210M, EV210M+SC, EV210P, FE05, FE105M, FE105X, FE110M, FE110X, FE210M, FG05, FG051M, FG051X, FG101M, FG101X, FG105M, FG105X, FG110M, FG110X, FG210M, FG210X, GM106M, GM106M+SC, GM110M, GM110M+SC, GM210M, GM210M+SC, GV106H, GV106M, GV106M+SC, GV106P, GV110H, GV110M, GV110M+SC...(Other models you can see in the webshop)		
spare parts for	373017		
	Part No.	370467	Ref. No. —
solenoid valve filter suitable for ELBI			

			
1			
Part No.	370360	Ref. No.	65115040 LAR65115040
description	solenoid valve single straight 230VAC inlet 3/4" outlet 11.5mm output 0.25l/min t.max. 90°C ELBI plastic flow regulating valve outlet white flow regulating valve inlet clear		
For models:	CGC24M, CGC40M, EC110M, EC210M, EV110M, EV110M+SC, EV210M, EV210M+SC, GC110M, GC210M, GV110M, GV110M+SC, GV210M, GV210M+SC, VE106D, VE106H, VE106M, VE106P, VE106X, VE110D, VE110H, VE110M, VE110X, VE210D, VE210H, VE210M, VE210P, VE210X, VG106D, VG106H, VG106M, VG106P, VG106X, VG110D, VG110H, VG110M, VG110P, VG110X, VG210D, VG210H, VG210M, VG210P, VG210X		

			
1			
Part No.	370359	Ref. No.	65115050 LAR65115050
description	solenoid valve double straight 230VAC inlet 3/4" outlet 11.5mm input 5.5l/min t.max. 90°C ELBI plastic flow regulating valve inlet yellow output A 5.5l/min output B 2l/min output A brown output B white		
For models:	CVE004H, CVE004M, CVE104H, CVE104M, VE004D, VE004H, VE004M, VE004S, VE004X, VE104D, VE104H, VE104M, VE104S, VE104X		

			
1			
Part No.	370357	Ref. No.	50102891 61115000 LAR50102891 LAR61115000
description	solenoid valve double straight 230VAC inlet 3/4" outlet 11.5mm plastic flow regulating valve outlet A 0.25		
For models:	FV03, FV06, ME05, ME10, ME15, ME20, ME21, ME24, ME40, MG05, MG10, MG15, MG20, MG21, MG24, MG40		

			
1			
Part No.	370361	Ref. No.	65115060 LAR65115060
description	solenoid valve double straight 230VAC inlet 3/4" outlet 11.5mm plastic output A 0.25l/min		
For models:	VE120D, VE120H, VE120L, VE120M, VE120P, VE120S, VE120X, VE220D, VE220H, VE220M, VE220P, VE220X, VES40M, VG120D, VG120H, VG120M, VG120P, VG120X, VG220D, VG220H, VG220M, VG220P, VG220X, VGS40M		

			
1			
Part No.	370358	Ref. No.	65115010 LAR65115010
description	solenoid valve double straight 230VAC inlet 3/4" outlet 11.5mm t.max. 90°C ELBI plastic output A 2l/min output B 2l/min		
For models:	ME004L, ME004S, ME104L, ME104S		

RPE

JOHN GUEST

			
1			
Part No.	374032 ¹	Ref. No.	65110230 LAR65110230
description	solenoid valve double straight 230VAC inlet 3/4" outlet 10mm DN10 plastic output A w/t membrane (constantly open)		
For models:	AVE07D, AVE10D, AVE10P, BPE044P, BPE054P, BPE064P, BPE074P, BPE084P, BPE104P, BPG044P, BPG054P, BPG064P, BPG074P, BPG084P, BPG104P, GGMT20T, GEVT06P, GEVT06T, GEVT10P, GEVT10T, GEVT20P, GGMT20T, GGVT06P, GGVT06T, GGVT10P, GGVT10T, GGVT20P, GGVT20T, GMT20P, GVT06D, GVT20D, HME061T, HME061X, HME101T, HME101X, HME102T, HME102X, HMG061T, HMG061X, HMG101T, HMG101X, HMG102T, HMG102X, HVE061P, HVE101P, HVE102P, HVE201P, HVG061P, HVG101P, HVG101T...(Other models you can see in the webshop)		

¹cylindrical outlet





			
Part No.	370768 ¹	Ref. No.	65110200 LA65110200 LAR65110200
description	solenoid valve single straight 230VAC inlet 3/4" outlet 10mm input/ min output/min DN10 t.max. 90°C duty cycle 100% RPE		
For models:	ACG10M, AVE07D, AVE10D, AVE10P, BPE044M, BPE054M, BPE064M, BPE074M, BPE084M, BPE104M, BPG044M, BPG054M, BPG064M, BPG074M, BPG084M, BPG104M, CE041M, CE051M, CE071M, CE100M, CE200M, CG051M, CG071M, CG100M, CG200M, EMT06D, EPE056T, EPE086T, EPE156T, EPEV05T, EPEV08T, EPEV15T, EPG056T, EPG086T, EPG156T, EPGV05T, EPGV08T, EPGV15T, GEMT06P, GEMT10P, GEMT10T, GEMT20P, GEMT21P, GEMT21T, GEMT40P, GEMT40T, GEVTO6P, GEVTO6T, GEVTO10P, GEVTO10T...(Other models you can see in the webshop)		

¹cylindrical outlet

			
Part No.	374031	Ref. No.	65110210 LAR65110210
description	solenoid valve double straight 230VAC inlet 3/4 outlet JG 10 input 10-12l/min t.max. 90°C RPE plastic flow regulating valve inlet white + outlet reducer red		
For models:	EMT06D, GEMT06P, GEMT06T, GEMT10P, GEMT10T, GEMT20P, GEMT20T, GEMT21P, GEMT21T, GEVTO6P, GEVTO6T, GGMT06P, GGMT06T, GGMT10P, GGMT10T, GGMT20P, GGMT20T, GGMT21P, GGMT21T, GMT20D, GMT20P, HME061P, HME061T, HME061X, HME101P, HME101T, HME101X, HME102P, HME102T, HME102X, HME201P, HME201T, HME201X, HMG061P, HMG061T, HMG061X, HMG101P, HMG101T, HMG101X, HMG102P, HMG102T, HMG102X, HVE061T, HVE061X, HVE101T, HVE101X, HVE102T, HVE102X, HVG061T, HVG061X, ME061D, ME061H...(Other models you can see in the webshop)		

reducers			
outlet side			
			
Part No.	371269	Ref. No.	65110420 65110500 LA65110500 LAR65110420 LAR65110500
description	reducer flow rate 0.07-0.14l/min brown		
For models:	AVE07D, BPE044M, BPE044P, BPE054M, BPE054P, BPE064M, BPE064P, BPE074M, BPE074P, BPG044M, BPG044P, BPG054M, BPG054P, BPG064M, BPG064P, BPG074M, BPG074P, CE041M, CE051M, CE071M, CG051M, CVE004H, CVE004M, CVE104H, CVE104M, EMT06D, EPE056T, EPEV05T, EPG056T, EPGV05T, EV106H, EV106P, EV110H, GEMT06P, GEMT06T, GEMT40P, GEMT40T, GEVTO6P, GEVTO6T, GEVTO10P, GEVTO10T, GGMT06P, GGMT06T, GGMT40P, GGMT40T, GGVT06P, GGVT06T, GGVT40P, GGVT40T, GMT06D...(Other models you can see in the webshop)		

			
Part No.	374011	Ref. No.	65110160 LAR65110160
description	solenoid valve double straight 230VAC inlet 3/4" outlet 1/4" input 10-12l/min t.max. 25°C RPE plastic flow regulating valve inlet white output A 0.2 - 3l/min output B 0.2 - 3l/min flow regulating valve outlet A red flow regulating valve outlet B red		
For models:	A08RES+UM, A10RES+UM		
spare parts for	374011		
		Part No.	371315
		Ref. No.	—
	solenoid valve holder RPE flange support		

solenoid valves with reducers			
single			
			
Part No.	374105	Ref. No.	LAR65110150
description	solenoid valve single straight 230VAC inlet 3/4" outlet 13 input 10-12l/min t.max. 25°C duty cycle 100% RPE type B plastic flow regulating valve outlet green flow regulating valve inlet white		

3-fold			
			
Part No.	374014 ¹	Ref. No.	65110280 LAR65110280
description	solenoid valve triple straight 230VAC inlet 3/4" outlet 10mm input 10-12l/min RPE plastic flow regulating valve inlet white flow regulating valve outlet A red/green flow regulating valve outlet B red/green flow regulating valve outlet C red/green		
For models:	GEMT40P, GEMT40T, GGMT21P, GGMT21T, GGMT40P, GGMT40T, GGVT40P, GGVT40T, HME201X, HME202P, HME202T, HME202X, HMG201P, HMG201T, HMG201X, HMG202P, HMG202T, HMG202X, HVG202P, HVG202T, HVG202X		

¹cylindrical outlet

2-fold			
			
Part No.	374106	Ref. No.	LAR65110330
description	solenoid valve double straight 230 inlet 3/4" outlet JG 10 t.max. 25°C duty cycle 100% RPE type D plastic		

1 electric components



			
1			
Part No.	374033	Ref. No.	65110240 LAR65110240
description	solenoid valve triple straight 230VAC inlet 3/4" outlet 10mm input 10-12l/min t.max. 90°C RPE plastic flow regulating valve inlet white output B w/t membrane (constantly open)		
For models:	EPE056T, EPE086T, EPE156T, EPEV05T, EPEV08T, EPEV15T, EPG056T, EPG086T, EPG156T, EPGV05T, EPGV08T, EPGV15T, GEMT06P, GEMT06T, GEMT10P, GEMT10T, GEMT20P, GEMT20T, GEMT21P, GEMT21T, GEMT40P, GEMT40T, GEVT06P, GEVT06T, GEVT10P, GEVT10T, GEVT20P, GEVT20T, GEVT21P, GEVT21T, GEVT40P, GEVT40T, GGMT06P, GGMT06T, GGMT10P, GGMT10T, GGMT20P, GGMT20T, GGMT21P, GGMT21T, GGMT40P, GGMT40T, GGVT06P, GGVT06T, GGVT10P, GGVT10T, GGVT20P, GGVT20T, GGVT21P, GGVT21T...(Other models you can see in the webshop)		

TP
spare parts and accessories

reducers

outlet side

			
1			
Part No.	691081	Ref. No.	65110410 LA65110410 LAR65110410
description	reducer flow rate 0.25l/min green tolerance ±25%		
For models:	CVE105H, CVE105M, CVG105H, CVG105M, EV110P, EV210H, EV210P, GV110H, GV110P, GV210H, GV210P, VE105D, VE105H, VE105M, VE105S, VE105X, VE110L, VE110S, VE110T, VE155H, VE155M, VE155X, VE210L, VE210S, VE210T, VEC20P, VG105D, VG105H, VG105M, VG105S, VG105X, VG110L, VG110S, VG110T, VG210L, VG210S, VG210T, VGC20H, VGC24H		

various

			
1			
Part No.	374057	Ref. No.	65115120 LAR65115120
description	solenoid valve single straight 230VAC inlet 3/4" outlet 11.5mm output 0.12l/min ELBI		
For models:	EC106M, EV006M, EV106M, EV106M+SC, GC106M, GV106M, GV-106M+SC, VG106X		

			
1			
Part No.	370363	Ref. No.	65110260 LA65110260 LAR65110260
description	solenoid valve single straight cable length 600mm suitable for LAINOX		
For models:	EPE056T, EPE086T, EPE156T, EPEV05T, EPEV08T, EPEV15T, EPG056T, EPG086T, EPG156T, EPGV05T, EPGV08T, EPGV15T, GEMT06P, GEMT06T, GEMT10P, GEMT10T, GEMT20P, GEMT20T, GEMT21P, GEMT21T, GEMT40P, GEMT40T, GEVT06P, GEVT06T, GEVT10P, GEVT10T, GEVT20P, GEVT20T, GEVT21P, GEVT21T, GEVT40P, GEVT40T, GGMT06P, GGMT06T, GGMT10P, GGMT10T, GGMT20P, GGMT20T, GGMT21P, GGMT21T, GGMT40P, GGMT40T, GGVT06P, GGVT06T, GGVT10P, GGVT10T, GGVT20P, GGVT20T, GGVT21P, GGVT21T...(Other models you can see in the webshop)		

metal

ASCO

spare parts and accessories

O-rings

			
1			
Part No.	371100	Ref. No.	70010030 LAR70010030
description	O-ring silicone thickness 1.78mm ID ø 6.07mm Qty 1 pcs		

SIRAI

2-way

L139-B series

			
1			
Part No.	370700	Ref. No.	65110100 LAR65110100
description	solenoid valve brass 2-ways 230VAC inlet 1/4" outlet 1/4" connection 1/4" L 40mm DN 4.5mm t.max. 90°C -10 up to +90°C SIRAI type series L139 coil type Z130A p max 8bar p min 0bar valve set L139B08 50Hz		





Solenoid valve - accessories

			
1			
Part No.	371100	Ref. No.	70010030 LAR70010030
description	O-ring silicone thickness 1.78mm ID ø 6.07mm Qty 1 pcs		

			
1			
Part No.	530903	Ref. No.	65090300 LA65090300 LAR65090300
description	solenoid coil plug type F6.3x0.8 230V for combi-steamer		

ball valves electric

			
1			
Part No.	403842	Ref. No.	65110570 LAR65110570
description	ball valve inlet 1" IT outlet 1" IT for combi-steamer 2-way 230V 50/60Hz brass mode of operation electric 3-pole-pole		

			
1			
Part No.	401342	Ref. No.	65110560 old Version LAR65110560 old Version
description	ball valve inlet 3/4" IT outlet 3/4" IT 230V IT 3/4"		

			
1			
Part No.	403042	Ref. No.	65110560 LAR65110560
description	ball valve inlet 3/4" IT outlet 3/4" IT 230V L 68mm closed off-current mode of operation electric connection cable 400mm		
For models:	EMT06D, GEMT06P, GEMT06T, GEMT10P, GEMT10T, GEMT20P, GEMT20T, GEMT21P, GEMT21T, GEMT40P, GEMT40T, GGMT06P, GGMT06T, GGMT10P, GGMT10T, GGMT20P, GGMT20T, GGMT21P, GGMT21T, GGMT40P, GGMT40T, GMT06D, GMT20D, GMT20P, HME061P, HME061T, HME061X, HME101P, HME101T, HME101X, HME102P, HME102T, HME102X, HME201P, HME201T, HME201X, HME202P, HME202T, HME202X, HMG061P, HMG061T, HMG061X, HMG101P, HMG101T, HMG101X, HMG102P, HMG102T, HMG102X, HMG201P, HMG201T...(Other models you can see in the webshop)		

pressure switches

for gas equipment

			
1			
Part No.	541073	Ref. No.	63070010 LA63070010 LAR63070010
description	pressure control ø 45mm pressure range adjustable 5-20mbar pressure connection vertical gas technology connection 1/4" pressure connection ø 1/4"mm		
For models:	ACG10M, BPG044M, BPG044P, BPG054M, BPG054P, BPG064M, BPG064P, BPG074M, BPG074P, BPG084M, BPG084P, BPG104M, BPG104P, CG051M, CG071M, CG100M, CG200M, CGC24M, CGC40M, CVG105H, CVG105M, EPG056T, EPG086T, EPG156T, EPGV05T, EPGV08T, EPGV15T, GC106M, GC110M, GC210M, GGMT06P, GGMT06T, GGMT10P, GGMT10T, GGMT20P, GGMT20T, GGMT21P, GGMT21T, GGMT40P, GGMT40T, GGVT06P, GGVT06T, GGVT10P, GGVT10T, GGVT20P, GGVT20T, GGVT21P, GGVT21T, GGVT40P, GGVT40T...(Other models you can see in the webshop)		

1 electric components



for steam control



1

Part No.	541074	Ref. No.	63070050 LAR63070050
description	pressure control ø 45mm triggering pressure 0.5bar reset pressure 0.35bar pressure connection vertical steam control pressure range 0.35/0.51bar connection 1/8" pressure connection 1/8"		
For models:	AVE07D, AVE10D, AVE10P, BPE044P, BPE054P, BPE064M, BPE064P, BPE074M, BPE074P, BPE084M, BPE084P, BPE104M, BPE104P, BPG044P, BPG054P, BPG064M, BPG064P, BPG074M, BPG074P, BPG084M, BPG084P, BPG104M, BPG104P, EPE056T, EPE086T, EPE156T, EPEV05T, EPEV08T, EPEV15T, EPG056T, EPG086T, EPG156T, EPGV05T, EPGV08T, EPGV15T, EV106H, EV106P, EV110H, EV110P, EV210H, EV210P, GEVT06P, GEVT06T, GEVT10P, GEVT10T, GEVT20P, GEVT20T, GEVT21P, GEVT21T, GEVT40P... (Other models you can see in the webshop)		



1

Part No.	400130	Ref. No.	65320010 65324680 65324730 LA65320010 LAR65320010 LAR65324680 LAR65324730
description	level electrode M14x1.25 total length 220mm probe L 194mm insulated probe length 26mm connection male faston 6.3mm ø 2.5mm		
For models:	EM010M+SC, EM106H, EM106M, EM106M+SC, EM106P, EM110H, EM110M, EM110M+SC, EM110P, EM210H, EM210M, EM210M+SC, EM210P, EMT06D, GEMT06P, GEMT06T, GEMT10P, GEMT10T, GEMT20P, GEMT20T, GEMT21P, GEMT21T, GEMT40P, GEMT40T, GGMT06P, GGMT06T, GGMT10P, GGMT10T, GGMT20P, GGMT20T, GGMT21P, GGMT21T, GGMT40P, GGMT40T, GM106H, GM106M, GM106M+SC, GM106P, GM110H, GM110M, GM110M+SC, GM110P, GM210H, GM210M, GM210M+SC, GM210P, GMT06D, GMT20D, GMT20P, HME061P...(Other models you can see in the webshop)		

electrodes



1

Part No.	400171	Ref. No.	0102478 65324720 LAR65324720 R0102478 SIR0102478
description	level electrode 1/4" total length 350mm probe L 325mm insulated probe length 26mm connection male faston 6.3mm stainless steel ø 2.5mm		
For models:	MG105L, MG105S		



1

Part No.	403834	Ref. No.	LA65324550 LAR65324550
description	level electrode M14x1.25 total length 60mm probe L 7.5mm insulated probe length 12.5mm connection male faston 6.3mm stainless steel ø 2.5mm		



1

Part No.	403106	Ref. No.	65324740 LAR65324740
description	level electrode M14x1.25 total length 155mm probe L 129mm insulated probe length 26mm connection male faston 6.3mm ø 2.5mm		
For models:	MG106L, MG106S, MG106T, MG110L, MG110S, MG110T		



1

Part No.	400054	Ref. No.	65324620 LAR65324620
description	level electrode total length 107mm probe L 73mm insulated probe length 18mm connection male faston 6.3mm ø 2.5mm thread M14x1.25		
For models:	ME105L, ME105S, ME106L, ME106S, ME106T		



1

Part No.	403105	Ref. No.	65324780 LAR65324780
description	level electrode M14x1.25 total length 178mm probe L 150mm insulated probe length 26mm connection male faston 6.3mm ø 2.5mm		
For models:	MG106L, MG106S, MG106T, MG110L, MG110S, MG110T		



fans

axial fans

ebm-papst



1

Part No.	601030 ¹	Ref. No.	3102350 65060050 BN3102350 LA65060050 LAR65060050
description	axial fan L 119mm W 119mm H 38mm 230VAC 50Hz 18W bearing ball bearing manuf. no. 4656Z metal connection male faston 2.8mm ebm-papst fan wheel ø 110mm temp.-resist. 75°C		
For models:	ACG10M, AVE07D, AVE10D, AVE10P, BPE064M, BPE064P, BPE074M, BPE074P, BPE084M, BPE084P, BPE104M, BPE104P, BPG064M, BPG064P, BPG074M, BPG074P, BPG084M, BPG084P, BPG104M, BPG104P, CE071M, CE100M, CE200M, CG071M, CG100M, CG200M, CGC24M, CGC40M, EC106M, EC110M, EC210M, EM010M+SC, EM106H, EM106M, EM106M+SC, EM106P, EM110H, EM110M, EM110M+SC, EM110P, EM210H, EM210M, EM210M+SC, EM210P, EMT06D, EPE056T, EPE086T, EPE156T, EPEV05T, EPEV08T...(Other models you can see in the webshop)		
accessories for	601030		
	Part No.	550898	Ref. No. —
	connecting cable cable length 2000mm connection F 2.8 connection distance 7.9mm for axial flow fan		
	Part No.	692497	Ref. No. —
	guard ø 105mm mounting distance 150mm for axial fan ebm-papstmm		

¹with ball bearings

import



1

Part No.	601081 ¹	Ref. No.	65060010 LA65060010 LAR65060010
description	axial fan L 80mm W 80mm H 38mm 230VAC 50/60Hz 14/13.5W bearing ball bearing connection male faston 2.8mm metal ADDA fan wheel ø 75mm temp.-resist. 70°C		
For models:	BPE044P, BPE054P, BPG044M, BPG044P, BPG054M, BPG054P, CVE105H, CVE105M, CVG105H, CVG105M, FG051M, FG051X, MCG051M, ME105L, ME105S, ME106D, ME106H, ME106L, ME106M, ME106P, ME106S, ME106T, ME106X, ME110D, ME110H, ME110L, ME110M, ME110P, ME110S, ME110T, ME110X, ME120D, ME120H, ME120L, ME120M, ME120P, ME120S, ME120T, ME120X, ME210D, ME210H, ME210L, ME210M, ME210P, ME210S, ME210T, ME210X, ME220D, ME220H, ME220L...(Other models you can see in the webshop)		
accessories for	601081		
	Part No.	691102	Ref. No. —
	guard ø 75mm mounting distance 71mm for axial fan 80mm		

¹with ball bearings



1

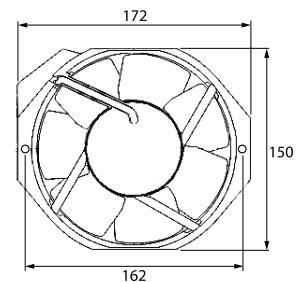

Part No.	602151	Ref. No.	65060060 LAR65060060
description	axial fan L 172mm W 150mm H 51mm 220-240V 50-60Hz manuf. no. AA1752HB-AW connection cable cable length 3000mm ADDA suitable for combi-steamer fan wheel ø 140mm 0.27/0.23A		
For models:	EPE156T, EPEV15T, HME201P, HME201T, HME201X, HMG201P, HMG201T, HMG201X, HVE201P, HVE201T, HVE201X, HVG201P, HVG201T, HVG201X, MCE201M, MCG201M, ME101H, ME101M, ME101P, ME101T, ME201D, ME201H, ME201M, ME201P, ME201T, ME202D, ME202H, ME202M, ME202P, ME202T, MEMT40D, MEMT40P, MEVT40D, MEVT40P, MG101H, MG101M, MG101P, MG101T, MG201D, MG201H, MG201M, MG201P, MG201T, MG202D, MG202H, MG202M, MG202P, MG202T, MGMT40D, MGMT40P...(Other models you can see in the webshop)		





refrigeration fans

cold air circulating fans (complete)

ebm-papst

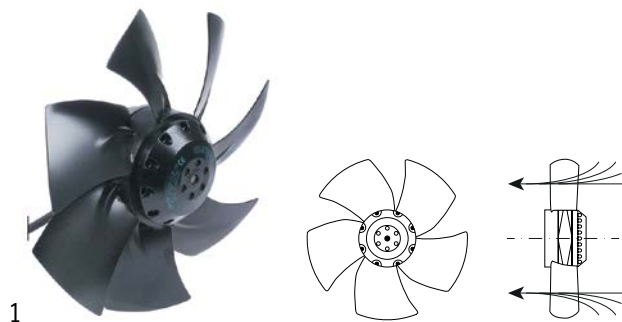
A2E series



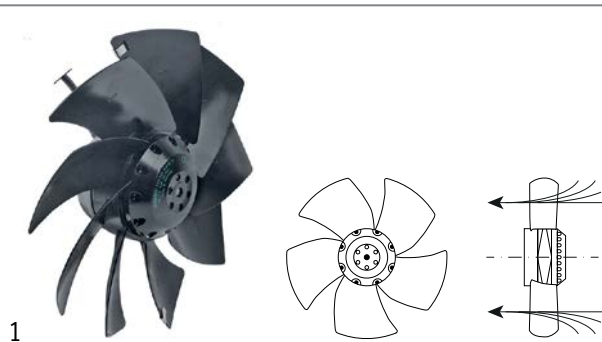

Part No.	601750	Ref. No.	65060190 LAR65060190 RA880002 SIRA880002 SIRRA880002
description	fan A2E250-AL06-09 fan wheel ø 250mm blades 7 230V 50/60Hz 120/160W 2500rpm cable length 200mm ebm-papst sucking suitable capacitor 3µF		
For models:	XESH6X41, XESH6X41A, XESH6X41B, XESH6X43, XESH6X43A, XESH6X43B, XESH6X43C, XESH6X43D, XESH6X49, XESH6X50, XESH6X52, XESH6X53, XESH6X53A, XESH6X53B, XESH6X53C, XESH6X53D, XESH6X53E, XESH6X53F, XESH6X53G, XESH6X53H, XESH6X55, XESH6X55A, XESH6X55B, XESH6X55C, XESH6X55D, XESH6X60, XESH6X61, XESH6X61A, XESH6X61B, XESH6X61C, XESH6X61D, XESH6X61E, XESH6X61F, XESH6X61G, XESH6X61H, XESH6X62, XESH6X62A, XESH6X62B, XESH6X62C, XESH6X62D, XESH6X63, XESH6X64, XESH6X64A, XESH6X64B, XESH6X64C, XESH6X64D, XESH6X65, XESH6X66, XESH6X66A, XESH6X66B... (Other models you can see in the webshop)		
accessories for	601750		
	Part No.	365137	Ref. No. —
	capacitor capacity 3µF 450V tolerance 5% 50/60Hz ambient temperature max. -25 to +85°C ø 25mm L 56mm M8 plastic connection cable 250mm 416.17.77GF protection		

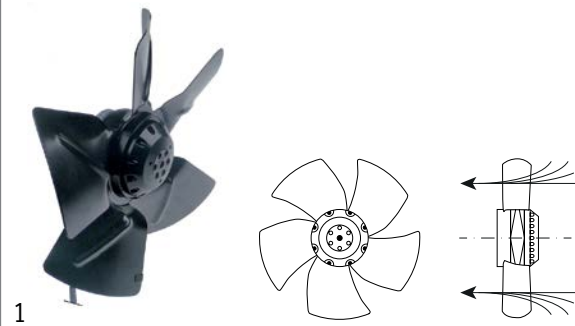

Part No.	601964	Ref. No.	RA880004 SIRRA880004
description	fan A2E250AM06-12 fan wheel ø 250mm blades 9 230V 50/60Hz 115/150W ø 250mm 2450rpm cable length 1400mm sucking suitable capacitor 3µF		
spare parts for	601964		
	Part No.	365137	Ref. No. —
	capacitor capacity 3µF 450V tolerance 5% 50/60Hz ambient temperature max. -25 to +85°C ø 25mm L 56mm M8 plastic connection cable 250mm 416.17.77GF protection		

A4E series



Part No.	601623	Ref. No.	RA880046 SIRA880046 SIRRA880046
description	fan A4E315-AC08-19 fan wheel ø 315mm blades 5 230V 50Hz 95W 1370rpm cable length 450mm ebm-papst sucking suitable capacitor 3µF		
For models:	XESH6X40, XESH6X40A, XESH6X40B, XESH6X42, XESH6X42A, XESH6X42B, XESH6X42C, XESH6X42D, XESH6X44, XESH6X44A, XESH6X44B, XESH6X45, XESH6X46, XESH6X46A, XESH6X46B, XESH6X46C, XESH6X46D, XESH6X47, XESH6X48, XESH6X51, XESH6X51A, XESH6X51B, XESH6X51C, XESH6X51D, XESH6X51E, XESH6X51F, XESH6X51G, XESH6X51H, XESH6X54, XESH6X56, XESH6X57, XESH6X57A, XESH6X57B, XESH6X57C, XESH6X57D, XESH6X57E, XESH6X57F, XESH6X57G, XESH6X57H, XESH6X58, XESH6X59, XESH6X59A, XESH6X59B, XESH6X59C, XESH6X59D, XESH6X79, XESH6X79A, XESH6X79B		
accessories for	601623		
	Part No.	365137	Ref. No. —
	capacitor capacity 3µF 450V tolerance 5% 50/60Hz ambient temperature max. -25 to +85°C ø 25mm L 56mm M8 plastic connection cable 250mm 416.17.77GF protection		

HIDRIA

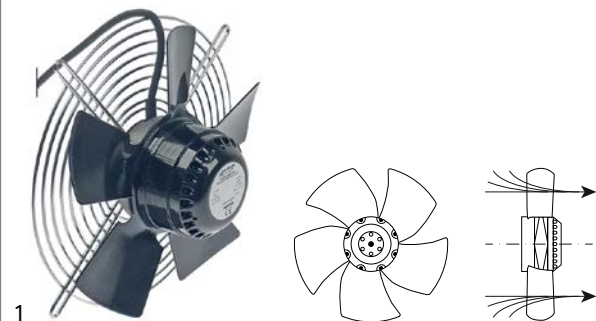



Part No.	602073	Ref. No.	965313 FR6678570 FR965313
description	fan type R09R-2525P-2M-3510 fan wheel ø 250mm 230V 50Hz 95W HIDRIA 2700rpm blowing cable length 2500mm mounting distance 300mm		







hot air motors

 <p>1</p>			
Part No.	550857	Ref. No.	58003870 LA58003870 LAR58003870
description	counterflange for fan motor ED ø 50mm int. ø 1 25mm int. ø 2 16mm thickness 6mm brass		
For models:	AVE07D, BPE064M, BPE064P, BPE074M, BPE074P, BPG064M, BPG064P, BPG074M, BPG074P, CE071M, CG071M, CVE105H, CVE105M, CVG105H, CVG105M, EC106M, EM106H, EM106M, EM106M+SC, EM106P, EMT06D, EV006M, EV106H, EV106M, EV106M+SC, EV106P, FE105M, FE105X, FG051M, FG051X, FG105M, FG105X, GC106M, GEMT06P, GEMT06T, GEVT06P, GEVT06T, GGMT06P, GGMT06T, GGVTO6P, GGVTO6T, GM106H, GM106M, GM106M+SC, GM106P, GMT06D, GV106H, GV106M, GV106M+SC, GV106P...(Other models you can see in the webshop)		

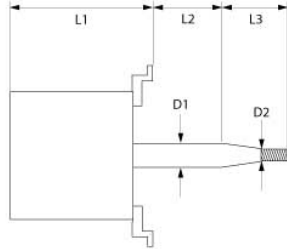
 <p>2</p>			
Part No.	550859	Ref. No.	58003850 LA58003850 LAR58003850
description	counterflange for fan motor ED ø 60mm int. ø 1 34mm int. ø 2 25mm thickness 6mm brass		
For models:	ACG10M, AVE10D, AVE10P, BPE084M, BPE084P, BPE104M, BPE104P, BPG084M, BPG084P, BPG104M, BPG104P, CE100M, CE200M, CG100M, CG200M, CGC24M, CGC40M, EC110M, EC210M, EM010M+SC, EM110H, EM110M, EM110M+SC, EM110P, EM210H, EM210M, EM210M+SC, EM210P, EPE056T, EPE086T, EPE156T, EPEV05T, EPEV08T, EPEV15T, EPG056T, EPG086T, EPG156T, EPGV05T, EPGV08T, EPGV15T, EV110H, EV110M, EV110M+SC, EV110P, EV210H, EV210M, EV210M+SC, EV210P, FE110M, FE110X...(Other models you can see in the webshop)		

 <p>1</p>			
Part No.	601044	Ref. No.	65040310 LAR65040310
description	fan motor		

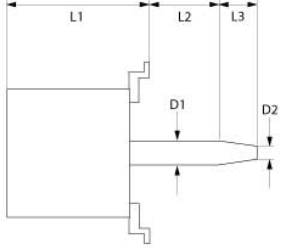
  <p>1</p>							
Part No.	500656	Ref. No.	65040520 LAR65040520				
description	fan motor 200-240/415V 3 phase 50/60Hz 0.15/0.55kW 900/1400rpm speeds 2 L1 150mm L2 50mm L3 48mm D1 ø 24mm D2 ø 20mm M12L IT 2.3/1.3-1.2/0.7A at 50Hz 200-240/415V at 60Hz 200-240/480V at 50Hz 900/1400rpm at 60Hz 1100/1700rpm type 3042D4050						
For models:	AVE10P, BPE084M, BPE084P, BPE104M, BPE104P, ME101P, ME101T, ME102P, ME102T, ME201P, ME201T, MG101P, PE156T, VE101P, VE201P						
spare parts for	500656						
 <table border="1"> <tr> <td>Part No.</td> <td>511172</td> <td>Ref. No.</td> <td>50505890 70020050 LA70020050 LAR50505890 LAR70020050 R50505890 R70020050</td> </tr> </table> <p>shaft sealing ID ø 24mm ED ø 29mm thickness 3mm</p>				Part No.	511172	Ref. No.	50505890 70020050 LA70020050 LAR50505890 LAR70020050 R50505890 R70020050
Part No.	511172	Ref. No.	50505890 70020050 LA70020050 LAR50505890 LAR70020050 R50505890 R70020050				

  <p>1</p>							
Part No.	500137	Ref. No.	50405530 65040050 65040160 LAR50405530 LAR65040050 LAR65040160				
description	fan motor 200-240/415V 3 phase 50/60Hz 0.185/0.55kW 900/1400rpm speeds 2 L1 190mm L2 45mm L3 47mm D1 ø 24mm D2 ø 20mm M12L IT 3/1.7-1.5/0.85A at 50Hz 200-240/415V at 60Hz 200-240/480V at 50Hz 900/1400rpm at 60Hz 1100/1700rpm						
accessories for	500137						
 <table border="1"> <tr> <td>Part No.</td> <td>511172</td> <td>Ref. No.</td> <td>50505890 70020050 LA70020050 LAR50505890 LAR70020050 R50505890 R70020050</td> </tr> </table> <p>shaft sealing ID ø 24mm ED ø 29mm thickness 3mm</p>				Part No.	511172	Ref. No.	50505890 70020050 LA70020050 LAR50505890 LAR70020050 R50505890 R70020050
Part No.	511172	Ref. No.	50505890 70020050 LA70020050 LAR50505890 LAR70020050 R50505890 R70020050				



1

Part No.	500655	Ref. No.	65040190 LAR65040190
description	fan motor 200-240/415V 3 phase 50/60Hz 0.185/0.55kW speeds 2 3/1.7-1.5/0.85A at 50Hz 200-240/415V at 60Hz 200-240/480V at 50Hz 900/1400rpm at 60Hz 1100/1700rpm type 1063/46T		
spare parts for	500655		
	Part No.	511172	Ref. No. 50505890 70020050 LA70020050 LAR50505890 LAR70020050 R50505890 R70020050
shaft sealing ID ø 24mm ED ø 29mm thickness 3mm			

1

Part No.	500671	Ref. No.	65040070 65040071 LAR65040070 LAR65040071
description	fan motor 200-240V 1 phase 50/60Hz 0.11kW 2760/3320rpm speeds 1 L1 130mm L2 55mm L3 30mm D1 ø 15mm D2 ø 12mm M10L ET at 50Hz 2760rpm at 60Hz 3320rpm		
For models:	CVE105H, CVE105M, CVG105H, CVG105M, ME105L, ME105S, MG105L, MG105S, VE105D, VE105M, VE105S, VE105X, VE155M, VE155X, VG105D, VG105H, VG105M, VG105S, VG105X		

1

Part No.	500134	Ref. No.	50405225 65040021 LAR50405225 LAR65040021
description	fan motor 200-240V 1 phase 50/60Hz 0.25HP 1400/1700rpm speeds 1 L1 115mm L2 77mm L3 30mm D1 ø 15mm D2 ø 12mm M10L ET 1A suitable capacitor 5µF/400V at 50Hz 1400rpm at 60Hz 1700rpm type 1060.1950		
For models:	ME106D, ME106M, ME106S, MG106D, MG106M, MG106S, VE106D, VE106L, VE106M, VE106S, VG106D, VG106L, VG106M, VG106S		
accessories for	500134		
	Part No.	380656	Ref. No. 50304450 65160100 65160110 LAR50304450 LAR65160100 LAR65160110 R50304450 R65160100 R65160110
overload switch setting range 0.63-1A			

1

Part No.	500135	Ref. No.	50405235 65040030 65040031 LAR50405235 LAR65040030 LAR65040031
description	fan motor 200-240V 1 phase 50Hz 0.185/0.55kW 900/1400rpm speeds 2 L1 195mm L2 45mm L3 47mm D1 ø 24mm D2 ø 20mm M12L IT 3.6/2A suitable capacitor 16µF-450V/12.5µF-450V at 50Hz 900/1400rpm type 1063D2250		
For models:	FG101X, FG110X, FG210X, GM110H, GM110P, GM210H, GM210P, GMT20P, GV110H, GV110P, GV210H, GV210P, MG102P, MG102T, MG110H, MG110L, MG110P, MG110T, MG110X, MG120H, MG120L, MG120P, MG120T, MG120X, MG210H, MG210P, MG210T, MG210X, MG220D, MG220H, MG220L, MG220P, MG220T, MG220X, MGC20H, MGC24H, MGC40H, MGC40P, MGMT10P, MGMT20P, MGMT21P, MGVT10P, MGVT20P, MGVT21P, PG080X, PG081X, PG101X, VG102P, VG110H, VG110P...(Other models you can see in the webshop)		

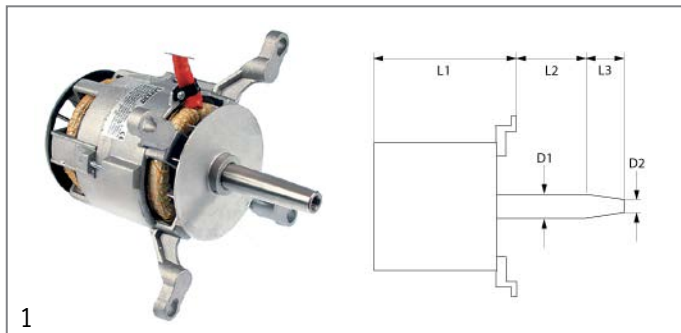

Part No.	601046	Ref. No.	50405510 52405265 65040061 65040130 65040150 65040170 LAR50405510 LAR52405265 LAR65040061 LAR65040130 LAR65040150 LAR65040170
description	fan motor 220/380V 3 phase 50/60Hz 0.75kW 1350/1650rpm speeds 1 L1 185mm L2 42mm L3 47mm D1 ø 24mm D2 ø 20mm M12L IT 1.9/3.3A Cos(fi) 0.83 at 50Hz 200-240/346-415V at 60Hz 200-277/346-480V at 50Hz 1350rpm at 60Hz 1650rpm type ST80/4 no. 661512		
For models:	EC110M, EC210M, EM010M+SC, EM110M, EM110M+SC, EM210M, EM210M+SC, EV110M, EV110M+SC, EV210M, EV210M+SC, FE110M, FE210M, ME10, ME102D, ME102H, ME102M, ME110D, ME110M, ME120D, ME120M, ME15, ME20, ME202D, ME202M, ME21, ME210D, ME210M, ME220D, ME220M, ME227M, ME24, ME40, MEC20X, MEC40M, MEMT10D, MEMT20D, MEMT21D, MEMT40D, MEVT10D, MEVT20D, MEVT21D, MEVT40D, MG10, MG15, MG20, MG21, MG24, MG40, MME10...(Other models you can see in the webshop)		

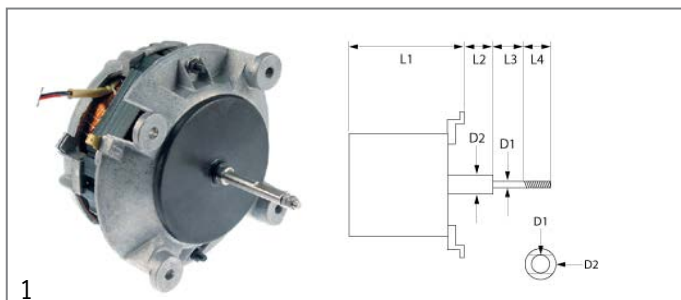

Part No.	500662	Ref. No.	65041000 LAR65041000
description	fan motor 220-240V 1 phase 50/60Hz 0.12kW 2800/3200rpm speeds 1 L1 85mm L2 7mm L3 47mm L4 12mm D1 ø 8/6mm D2 ø 12mm M5R ET 1.6A power input 0.25W suitable capacitor 5µF/400V		
For models:	A05PES, A05RES, A05RES+UM, A08RES, A08RES+UM, A10RES, A10RES+UM, BPE044M, BPE044P, BPE054M, BPE054P, BPG044M, BPG044P, BPG054M, BPG054P, CE041M, CE051M, CG051M, MACE04M, MACE05M, MACG05M, MCE042M, MCE051M, MCG051M, MVE042P, MVE051P, MVG051P, VE042P, VE051P, VE055P, VG051P		



Part No.	501587	Ref. No.	65040051 LAR65040051
description	fan motor 220-240V 1 phase 50/60Hz 0.55kW 1400/1700rpm L1 190mm L2 45mm L3 47mm D1 ø 24mm D2 ø 20mm M12L IT 3.6A type 1063A2250		
For models:	EM110H, EM110P, EM210H, EM210P, EV110H, EV110P, EV210H, EV210P, ME102P, ME102T, ME110H, ME110P, ME110X, ME120H, ME120P, ME120X, ME202H, ME202P, ME202T, ME210H, ME210P, ME210X, ME220H, ME220P, ME220X, ME227P, ME227X, MEC20H, MEC20P, MEC24H, MEC40H, MEK21H, MEMT10P, MEMT20P, MEMT21P, MEMT40P, MEVT10P, MEVT20P, MEVT21P, MEVT40P, PE005K, PE015M, PE108D, PE115K, PG015M, PG115M, VE102P, VE110H, VE110X, VE120H...(Other models you can see in the webshop)		

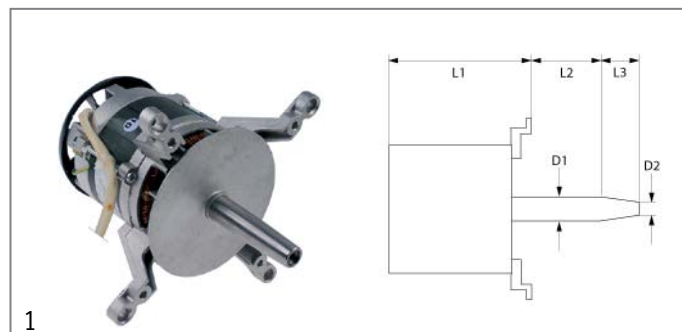

Part No.	500136	Ref. No.	65040040 65040041 65040180 LAR65040041 LAR65040180
description	fan motor 220-240V 1 phase 50/60Hz 0.55kW 1400rpm speeds 1 L1 190mm L2 47mm L3 47mm D1 ø 24mm D2 ø 20mm M12L IT 3.6A suitable capacitor 16µF/450V Cos(fi) 0.9 at 50Hz 1400rpm at 60Hz 1700rpm type 1063/4M		
For models:	CGC24M, CGC40M, FG101M, FG110M, FG210M, GC110M, GC210M, GM110M, GM110M+SC, GM210M, GM210M+SC, GMT20D, GV110M, GV110M+SC, GV210M, GV210M+SC, GVT20D, MG102D, MG102H, MG102M, MG110D, MG110M, MG110S, MG120D, MG120M, MG120S, MG210D, MG210M, MG220L, MG220M, MG220S, MGC20X, MGMT10D, MGMT20D, MGMT21D, MGVT10D, MGVT20D, MGVT21D, PG080M, PG081M, PG101M, VG102D, VG102M, VG110D, VG110L, VG110M, VG110S, VG120D, VG120M, VG210D...(Other models you can see in the webshop)		

accessories for	500136		
	Part No.	511172	Ref. No.
			50505890 70020050 LA70020050 LAR50505890 LAR70020050 R50505890 R70020050
shaft sealing ID ø 24mm ED ø 29mm thickness 3mm			

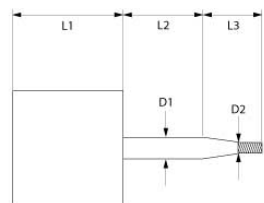
1

Part No.	500661	Ref. No.	65040431 LAR65040431
description	fan motor 220-240V 1 phase 50Hz 0.03/0.2kW 0.05/0.25HP 1400/2700rpm speeds 2 L1 123mm L2 77mm L3 30mm D1 ø 15mm D2 ø 12mm M10L ET 1.6/0.6A suitable capacitor 10µF/450 V at 50Hz 1400/2700rpm type 1057D1901		
For models:	BPE064M, BPE064P, BPE074M, BPE074P, BPG064M, BPG064P, BPG074M, BPG074P, ME061P, ME061T, MEMT06P, MEVT06P, MG061P, MG061T, MGMT06P, MGVT06P, VE061P, VG061P		



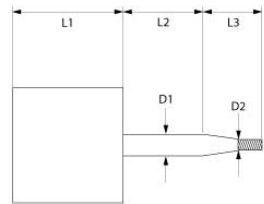

1

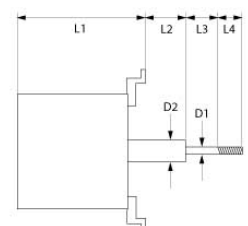
Part No.	500133	Ref. No.	30405215 65040011 LAR30405215 LAR65040011
description	fan motor 220-240V 1 phase 50Hz 0.1/0.25HP 900/1400rpm speeds 2 L1 123mm L2 77mm L3 30mm D1 ø 15mm D2 ø 12mm M10L ET 1/0.6A suitable capacitor 5µF/450V at 50Hz 900/1400rpm at 60Hz 1100/1700rpm type 1061.1950		
For models:	ME106H, ME106L, ME106P, ME106T, ME106X, MG106H, MG106L, MG106P, MG106T, MG106X, VE106H, VE106P, VE106T, VE106X, VG106H, VG106P, VG106T, VG106X		

1

Part No.	601354	Ref. No.	50405580 65040380 LA65040380 LAR50405580 LAR65040380
description	fan motor 220-240V 1 phase 50Hz 0.11kW 2760rpm speeds 1 L1 130mm L2 32mm L3 30mm L4 18mm D1 ø 7/8mm D2 ø 9mm M4R IT 0.9A at 50Hz 230V at 50Hz 2760rpm suitable capacitor 4µF type LM63 shaft flat length 17mm		
For models:	FE05, FG05		
accessories for	601354		
	Part No.	365031	Ref. No. 50405600 65190010 LAR65190010 R65190010
	operating capacitor capacity 4µF 450V tolerance 5% 50/60Hz ambient temperature max. -25 to +85°C ø 31mm L 58mm M8 plastic connection male faston 6.3mm protection		

accessories for 601354



Part No.	601061	Ref. No.	50405740 75400060 LA75400060 LAR50405740 LAR75400060 R50405740 R75400060
-----------------	--------	-----------------	--

fan wheel D1 ø 160mm H1 60mm blades 15 D2 ø 18mm D3 ø 18mm H2 35mm

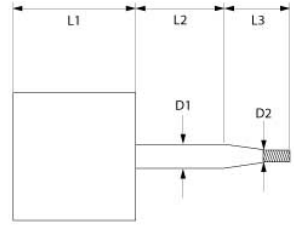
1

Part No.	601043	Ref. No.	50405610 65040260 LAR50405610 LAR65040260
description	fan motor 220-240V 1 phase 50Hz 0.37/0.07kW 0.1/0.5HP 1400/2700rpm speeds 2 L1 123mm L2 107mm L3 15mm D1 ø 15mm D2 ø 12mm M10L ET 2/0.7A suitable capacitor 20µF/250V at 50Hz 1400/2700rpm type 1057		
For models:	FE105M, FE105X, FG105M, FG105X, ME05, MG05, PE04, PE040M, PE040X, PG04, PG040M, PG040X, RE05, RG05		

1

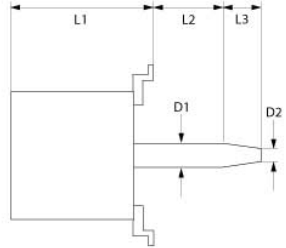

Part No.	500658	Ref. No.	65040530 LAR65040530
description	fan motor 230/400V 3 phase 50/60Hz 0.55kW 1400/1700rpm speeds 1 L1 145mm L2 47mm L3 47mm D1 ø 24mm D2 ø 20mm M12L IT 2.6-2.3/1.5-1.3A (at 50-60Hz)A Cos(φ) 0.73 at 50Hz 200-240/415V at 60Hz 200-240/480V at 50Hz 1400rpm at 60Hz 1700rpm		
For models:	AVE10D, CE100M, CE200M, EPE056T, EPE086T, EPE156T, EPEV05T, EPEV08T, EPEV15T, EPG056T, EPG086T, EPG156T, EPGV05T, EPGV08T, EPGV15T, GEMT10P, GEMT10T, GEMT20P, GEMT20T, GEMT21P, GEMT21T, GEMT40P, GEMT40T, GEVT10P, GEVT10T, GEVT20P, GEVT20T, GEVT21P, GEVT21T, GEVT40P, GEVT40T, GGMT10T, GGMT20T, GGMT21T, GGMT40T, GGVT10T, GGVT20T, GGVT21T, GGVT40T, HME101P, HME101T, HME101X, HME102P, HME102T, HME102X, HME201P, HME201T, HME201X, HME202P, HME202T... (Other models you can see in the webshop)		
spare parts for	500658		
	Part No.	511172	Ref. No. 50505890 70020050 LA70020050 LAR50505890 LAR70020050 R50505890 R70020050
	shaft sealing ID ø 24mm ED ø 29mm thickness 3mm		

Table continues overleaf



accessories for 500658					
	<table border="1"> <tr> <th>Part No.</th> <td>560449</td> <th>Ref. No.</th> <td>58004000 LA58004000 LAR58004000 R58004000</td> </tr> </table> <p>hexagonal screw thread M12x1.5 L thread L 22mm bore ϕ 6.3mm WS 19 total length 30mm</p>	Part No.	560449	Ref. No.	58004000 LA58004000 LAR58004000 R58004000
Part No.	560449	Ref. No.	58004000 LA58004000 LAR58004000 R58004000		
	<table border="1"> <tr> <th>Part No.</th> <td>601244</td> <th>Ref. No.</th> <td>75400440 LA75400440 LAR75400440 R75400440</td> </tr> </table> <p>fan wheel D1 ϕ 350mm H1 114mm blades 12 D2 ϕ 19.5mm D3 ϕ 23mm H2 45mm</p>	Part No.	601244	Ref. No.	75400440 LA75400440 LAR75400440 R75400440
Part No.	601244	Ref. No.	75400440 LA75400440 LAR75400440 R75400440		



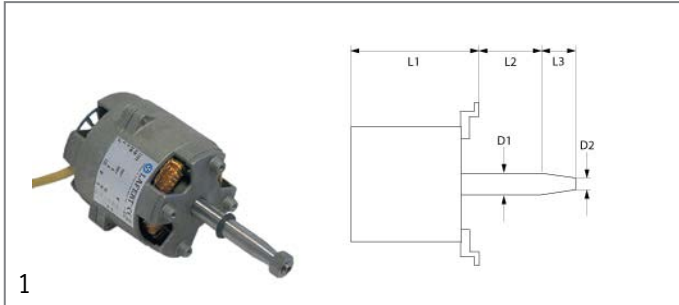

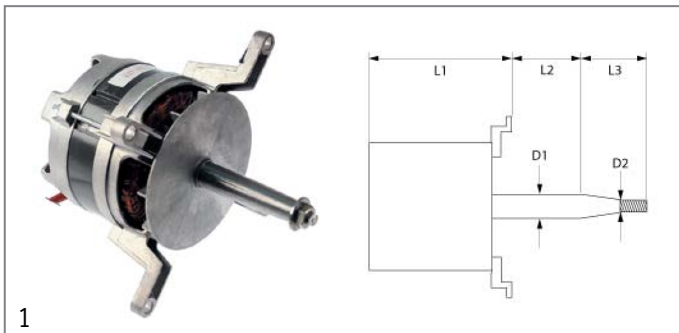
Part No.	500139	Ref. No.	65040071+58004020 LAR65040071+LAR58004020 R65040071+R58004020
description	fan motor 230V 1 phase 0.11kW speeds 1 L1 123mm L2 82mm		

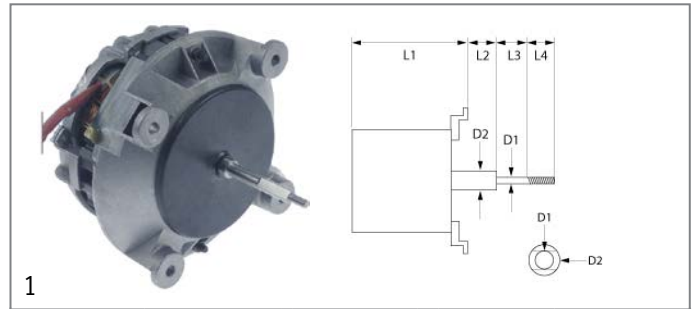

Part No.	500659	Ref. No.	65040550 LAR65040550
description	fan motor 230V 1 phase 50/60Hz 0.55kW 1400/1700rpm speeds 1 L1 150mm L2 52mm L3 45mm D1 ϕ 24mm D2 ϕ 20mm M12L IT 3A suitable capacitor 20 μ F/450V Cos(fi) 0.9 at 50Hz 1400rpm at 60Hz 1700rpm type 3042A2350		
For models:	ACG10M, CG100M, CG200M, GGMT10P, GGMT20P, GGMT21P, GGMT40P, GGV10P, GGV20P, GGV21P, GGV40P, GMT20D, GVT20D, HMG101P, HMG102P, HMG201P, HMG202P, HVG101P, HVG102P, HVG201P, HVG202P, MACG10M, MACG20M, MCG101M, MCG102M, MCG201M, MCG202M, ME201M, MG101D, MG101H, MG101M, MG201D, MG201H, MG201M, MG202D, MG202H, MG202M, MGMT40D, MGVT40D, MMG101P, MMG102P, MVG101P, MVG102P, VG101D, VG101M, VG201D, VG201M, VG202D, VG202M		

spare parts for 500659					
	<table border="1"> <tr> <th>Part No.</th> <td>511172</td> <th>Ref. No.</th> <td>50505890 70020050 LA70020050 LAR50505890 LAR70020050 R50505890 R70020050</td> </tr> </table> <p>shaft sealing ID ϕ 24mm ED ϕ 29mm thickness 3mm</p>	Part No.	511172	Ref. No.	50505890 70020050 LA70020050 LAR50505890 LAR70020050 R50505890 R70020050
Part No.	511172	Ref. No.	50505890 70020050 LA70020050 LAR50505890 LAR70020050 R50505890 R70020050		



Part No.	601856	Ref. No.	65041010 LAR65041010		
description	fan motor 230V 1 phase 50Hz 0.075kW 2650rpm speeds 1 L1 85mm L2 30mm L3 23mm L4 12mm D1 ϕ 8x6mm D2 ϕ 8mm 0.6A suitable capacitor 5 μ F/400V				
accessories for	601856				
	<table border="1"> <tr> <th>Part No.</th> <td>365017</td> <th>Ref. No.</th> <td>—</td> </tr> </table> <p>operating capacitor capacity 5μF 450V tolerance 5% 50/60Hz ambient temperature max. -25 to +85°C ϕ 28mm L 54mm M8 plastic connection male faston 6.3mm 16.10.08 protection</p>	Part No.	365017	Ref. No.	—
Part No.	365017	Ref. No.	—		

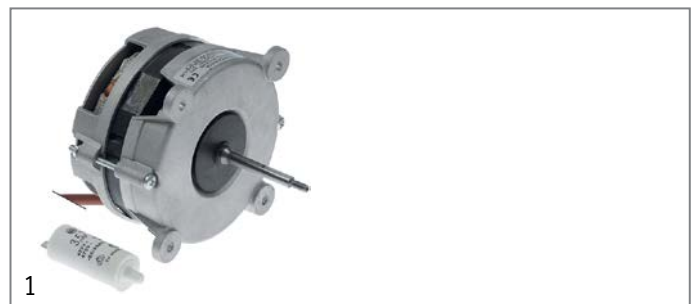

Part No.	501564	Ref. No.	65060070 LAR65060070
description	fan motor 230V 1 phase 50Hz 0.09kW 2500rpm L1 79mm L2 48mm L3 12mm D1 ϕ 5mm D2 ϕ 8mm M5 0.75A suitable capacitor 3.5 μ F Cos(fi) 0.98 type FIR no. 3012.2352		

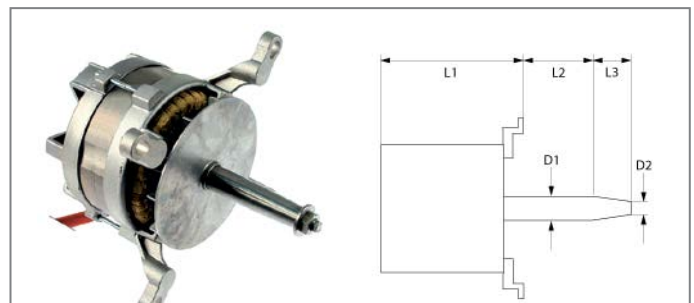

Part No.	500657	Ref. No.	65040540 LAR65040540
description	fan motor 230V 1 phase 50Hz 0.15/0.55kW 900/1400rpm speeds 2 L1 150mm L2 45mm L3 47mm D1 ϕ 24mm D2 ϕ 20mm M12L IT 1.3/3.0A suitable capacitor 20/10 μ F Cos(fi) 0.98 at 50Hz 900/1400rpm at 60Hz 1100/1700rpm 4P/6P type LM/FB 100L no. 472986		
For models:	BPG084M, BPG084P, BPG104M, BPG104P, GMT20P, MG101P, MG101T, MG102P, MG102T, MG201P, MG201T, MG202P, MG202T, MGMT40P, MGVT40P, PG084, PG104M, VG101P, VG201P, VG202P		

spare parts for 500657					
	<table border="1"> <tr> <th>Part No.</th> <td>511172</td> <th>Ref. No.</th> <td>50505890 70020050 LA70020050 LAR50505890 LAR70020050 R50505890 R70020050</td> </tr> </table> <p>shaft sealing ID ϕ 24mm ED ϕ 29mm thickness 3mm</p>	Part No.	511172	Ref. No.	50505890 70020050 LA70020050 LAR50505890 LAR70020050 R50505890 R70020050
Part No.	511172	Ref. No.	50505890 70020050 LA70020050 LAR50505890 LAR70020050 R50505890 R70020050		

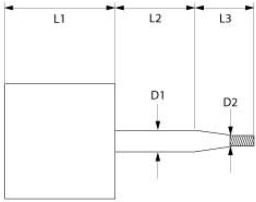



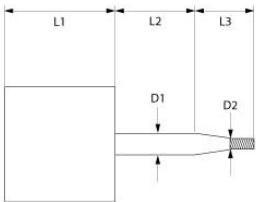

1

Part No.	500663	Ref. No.	65040421 LAR65040421
description	fan motor 230V 1 phase 50Hz 0.18kW 0.25HP 2800rpm speeds 1 L1 123mm L2 77mm L3 30mm D1 ø 15mm D2 ø 12mm M10L ET 1.6A suitable capacitor 10µF/400V Cos(fi) 0.95 at 50Hz 2800rpm type 1057C2401		
For models:	AVE07D, CE071M, CG071M, EMT06D, GEMT06P, GEVT06P, GGMT06P, GGVT06P, GMT06D, GVT06D, HME061P, HMG061P, HVE061P, HVG061P, MACE07M, MACG07M, MCE071M, MCG071M, ME061D, ME061H, ME061M, MEMT06D, MEVT06D, MG061D, MG061H, MG061M, MGMT06D, MGVT06D, MME071P, MMG071P, MVE071M, MVE071P, MVG071P, VE061D, VE061M, VG061D, VG061M		

1

Part No.	500680	Ref. No.	65040420 LAR65040420
description	fan motor 230V 1 phase 50Hz 0.37kW 2800rpm speeds 1 L1 121mm L2 77mm L3 31mm D1 ø 16mm D2 ø 11mm 2.5A Cos(fi) 0.95 at 50Hz 230V at 50Hz 2800rpm type 1057.2155		
For models:	EC106M, EM106M, EM106M+SC, EV006M, EV106M, EV106M+SC, FG051M, GC106M, GM106M, GM106M+SC, GV106M, GV106M+SC, PG041M, VG106X		
accessories for	500680		
	Part No.	601060	Ref. No. 50405730 75400120 75400130 LA75400130 LAR50405730 LAR75400120 LAR75400130 R50405730 R75400120 R75400130
	fan wheel D1 ø 180mm H1 60mm blades 16 D2 ø 11mm D3 ø 16mm H2 30mm		



1

Part No.	501565	Ref. No.	LAR65041040
description	fan motor 230V 1 phase 50Hz 75W 2800rpm L1 85mm L2 57mm L3 12mm D1 ø 8mm D2 ø 5mm M5 0.6A suitable capacitor 5µF power input 125W Cos(fi) 0.96 type FIR no. 3013.2353		



1

Part No.	501566	Ref. No.	65040600 LAR65040600
description	fan motor 230V 3 phase 50Hz 0.25kW 2700rpm L1 122mm L2 77mm L3 30mm D1 ø 15mm D2 ø 8mm M10 1.5A type FIR no. 1057.2650		
For models:	GEMT06T, GEVT06T, GGMT06T, GGVT06T, HME061T, HME061X, HMG061T, HMG061X, HVE061T, HVE061X, HVG061T, HVG061X		



1

Part No.	602150	Ref. No.	LA75400550
description	fan wheel blades 12 D1 ø 325mm D2 ø 19.5mm D3 ø 23mm H1 130mm H2 42mm H3 87mm		



1

Part No.	602148	Ref. No.	75400470 75400471 LA75400471 LAR75400470 LAR75400471
description	fan wheel blades 12 D1 ø 350mm D2 ø 19.5mm D3 ø 23mm H1 118mm H2 50mm		
For models:	BPE084M, BPE084P, BPE104M, BPE104P, BPG084M, BPG084P, BPG104M, BPG104P, GEMT10P, GEMT21P, GEVT10P, GEVT21P, GGMT10P, GGMT20P, GGMT21P, GGMT40P, GGVT10P, GGVT20P, GGVT21P, GGVT40P, HME101P, HME102P, HME201P, HME202P, HMG101P, HMG102P, HMG201P, HMG202P, HVE101P, HVE102P, HVE201P, HVE202P, HVG101P, HVG102P, HVG201P, HVG202P, MCE101M, MCE102M, MCE201M, MCE202M, MCG101M, MCG102M, MCG201M, MCG202M, MME101P, MME102P, MMG101P, MMG102P, MVE101M, MVE101P...(Other models you can see in the webshop)		

1

Part No.	602146	Ref. No.	75400490 LA75400490 LAR75400490
description	fan wheel blades 8 D1 ø 220mm D2 ø 11mm D3 ø 16mm H1 83mm H2 25mm		
For models:	MVE071M		



1

Part No.	601061	Ref. No.	50405740 75400060 LA75400060 LAR50405740 LAR75400060
description	fan wheel D1 ø 160mm H1 60mm blades 15 D2 ø 18mm D3 ø 18mm H2 35mm		
For models:	FE05, FG05		



1

Part No.	601067	Ref. No.	50405781 75400030 75400040 LAR50405781 LAR75400030 LAR75400040
description	fan wheel D1 ø 150mm H1 38mm blades 36 D2 ø 6mm D3 ø 6mm H2 14mm		
For models:	CVE004H, CVE004M, CVE104H, CVE104M, ME004L, ME004S, ME104L, ME104S, VE004D, VE004H, VE004M, VE004S, VE004X, VE104D, VE104H, VE104M, VE104S, VE104X		



1

Part No.	601068	Ref. No.	50405795 75400080 75400090 LAR50405795 LAR75400080 LAR75400090
description	fan wheel D1 ø 160mm H1 70mm blades 16 D2 ø 12mm D3 ø 16mm H2 29mm		
For models:	CVE105H, CVE105M, CVG105H, CVG105M, ME105L, ME105S, MG105L, MG105S, VE105D, VE105H, VE105M, VE105S, VE105X, VE155H, VE155M, VE155X, VG105D, VG105H, VG105M, VG105S, VG105X		



1

Part No.	601353	Ref. No.	75400510 LA75400510 LAR75400510
description	fan wheel D1 ø 150mm H1 50mm blades 36 D2 ø 8mm D3 ø 6/8mm H2 26mm		
For models:	CE041M, MACE04M, MCE042M, MVE042P, VE042P		



1

Part No.	601060	Ref. No.	50405730 75400120 75400130 LA75400130 LAR50405730 LAR75400120 LAR75400130
description	fan wheel D1 ø 180mm H1 60mm blades 16 D2 ø 11mm D3 ø 16mm H2 30mm		
For models:	FE105M, FE105X, FG051M, FG051X, FG105M, FG105X, ME05, MG05, PE04, PE040M, PE040X, PG04, PG040M, PG040X, PG041M, PG041X, PG051X, RE05, RG05		



			
1			
Part No.	601246	Ref. No.	34300730 75400410 LA75400410 LAR75400410
description	fan wheel D1 ø 180mm H1 77mm blades 12 D2 ø 8mm D3 ø 6mm H2 25.5mm		
For models:	A05PES, A05RES, A05RES+UM, A08RES, A08RES+UM, A10RES, A10RES+UM, BPE044M, BPE044P, BPE054M, BPE054P, BPG044M, BPG044P, BPG054M, BPG054P, CE051M, CG051M, MACE05M, MACG05M, MCE051M, MCG051M, MVE051P, MVG051P, VE051P, VE055P, VG051P		

			
1			
Part No.	601243	Ref. No.	75400400 LA75400400 LAR75400400
description	fan wheel D1 ø 220mm H1 78mm blades 12 D2 ø 11mm D3 ø 16mm H2 29mm		
For models:	AVE07D, BPE064M, BPE064P, BPE074M, BPE074P, BPG064M, BPG064P, BPG074M, BPG074P, CE071M, CG071M, EC106M, EM106H, EM106M, EM106M+SC, EM106P, EMT06D, EV006M, EV106H, EV106M, EV106M+SC, EV106P, GC106M, GEMT06P, GEMT06T, GEVT06P, GEVT06T, GEVT10T, GEVT21P, GEVT21T, GGMT06P, GGMT06T, GGVTO6P, GGVTO6T, GM106H, GM106M, GM106M+SC, GM106P, GMT06D, GV106H, GV106M, GV106M+SC, GV106P, GVT06D, HME061P, HME061T, HME061X, HMG061P, HMG061T, HMG061X... (Other models you can see in the webshop)		

			
1			
Part No.	601064	Ref. No.	50405812 75400210 75400230 LA75400230 LAR50405812 LAR75400210 LAR75400230
description	fan wheel D1 ø 220mm H1 78mm blades 20 D2 ø 11.5mm D3 ø 16.5mm H2 30mm		
For models:	ME106D, ME106H, ME106L, ME106M, ME106P, ME106S, ME106T, ME106X, MG106D, MG106H, MG106L, MG106M, MG106P, MG106S, MG106T, MG106X, VE106D, VE106H, VE106L, VE106M, VE106P, VE106S, VE106T, VE106X, VG106D, VG106H, VG106L, VG106M, VG106P, VG106S, VG106T, VG106X		

			
1			
Part No.	602145	Ref. No.	LA75400570K_081
description	fan wheel D1 ø 240mm D2 ø 11mm SS D3 ø 16mm H1 83mm blades 6		

			
1			
Part No.	601062	Ref. No.	50405720 75400240 LAR50405720 LAR75400240
description	fan wheel D1 ø 270mm H1 100mm blades 24 D2 ø 19.5mm D3 ø 23mm H2 46mm		
For models:	ME15, ME21, MG15, MG21, PE12, PG12, RE07, RG07		

			
1			
Part No.	601065	Ref. No.	50405820 75400270 75400290 LA75400290 LAR50405820 LAR75400270 LAR75400290
description	fan wheel D1 ø 300mm H1 120mm blades 20 D2 ø 19.5mm D3 ø 23mm H2 46mm		
For models:	EC110M, EM010M+SC, EM110H, EM110M, EM110M+SC, EM110P, EV110H, EV110M, EV110M+SC, EV110P, GC110M, GM110H, GM110M, GM110M+SC, GM110P, GV110H, GV110M, GV110M+SC, GV110P, ME110D, ME110H, ME110L, ME110M, ME110P, ME110S, ME110T, ME110X, ME120D, ME120H, ME120L, ME120M, ME120P, ME120S, ME120T, ME120X, MEC20H, MEC20P, MEC20X, MEK21H, MG110D, MG110H, MG110L, MG110M, MG110P, MG110S, MG110T, MG110X, MG120D, MG120H, MG120L... (Other models you can see in the webshop)		



Part No.	601063	Ref. No.	50405710 75400330 LAR50405710 LAR75400330
description	fan wheel D1 ø 350mm H1 100mm blades 24 D2 ø 19.5mm D3 ø 23mm H2 46mm		
For models:	ME10, ME20, ME24, ME40, MG10, MG20, MG24, MG40, MME10, MME40, PE08, PG08, RE10, RE20, RE24, RG10, RG20, RG24, RG40		



Part No.	601244	Ref. No.	75400440 LA75400440 LAR75400440
description	fan wheel D1 ø 350mm H1 114mm blades 12 D2 ø 19.5mm D3 ø 23mm H2 45mm		
For models:	ACG10M, AVE10D, AVE10P, BPE084M, BPE084P, BPE104M, BPE104P, BPG084M, BPG084P, BPG104M, BPG104P, CE100M, CE200M, CG100M, CG200M, EPE086T, EPE156T, EPEV08T, EPEV15T, EPG086T, EPG156T, EPGV08T, EPGV15T, GEMT10P, GEMT10T, GEMT20P, GEMT20T, GEMT21P, GEMT21T, GEMT40P, GEMT40T, GEVT10P, GEVT20P, GEVT20T, GEVT40P, GEVT40T, GGMT10P, GGMT10T, GGMT20P, GGMT20T, GGMT21P, GGMT21T, GGMT40P, GGMT40T, GGV10P, GGV10T, GGV20P, GGV20T, GGV21P, GGV21T...(Other models you can see in the webshop)		



Part No.	601066	Ref. No.	75400360 75400380 LAR75400360 LAR75400380
description	fan wheel D1 ø 350mm H1 120mm blades 24 D2 ø 19.5mm D3 ø 23.5mm H2 45mm		
For models:	CGC24M, CGC40M, EC210M, EM210H, EM210M, EM210M+SC, EM210P, EV210H, EV210M, EV210M+SC, EV210P, GC210M, GM210H, GM210M, GM210M+SC, GM210P, GV210H, GV210M, GV210M+SC, GV210P, ME210D, ME210H, ME210L, ME210M, ME210P, ME210S, ME210T, ME210X, ME220D, ME220H, ME220L, ME220M, ME220P, ME220S, ME220T, ME220X, MEC24H, MEC40H, MEC40M, MG210D, MG210H, MG210L, MG210M, MG210P, MG210S, MG210T, MG210X, MG220D, MG220H, MG220L...(Other models you can see in the webshop)		

Part No.	550855	Ref. No.	58005510 LAR58005510
description	flange for fan motor ED ø 35mm int. ø 1 22mm int. ø 2 8mm thickness 8mm brass		
For models:	CVE004H, CVE004M, CVE104H, CVE104M, VE004D, VE004H, VE004M, VE004X, VE104D, VE104H, VE104M, VE104X		

Part No.	550856	Ref. No.	58003860 LA58003860 LAR58003860
description	flange for fan motor ED ø 50mm int. ø 1 19.5mm int. ø 2 16mm thickness 3mm brass		
For models:	AVE07D, BPE064M, BPE064P, BPE074M, BPE074P, BPG064M, BPG064P, BPG074M, BPG074P, CE071M, CG071M, CVE105H, CVE105M, CVG105H, CVG105M, EC106M, EM106H, EM106M, EM106M+SC, EM106P, EMT06D, EV006M, EV106H, EV106M, EV106M+SC, EV106P, FE105M, FE105X, FG051M, FG051X, FG105M, FG105X, GC106M, GEMT06P, GEMT06T, GEVT06P, GEVT06T, GGMT06P, GGMT06T, GGV06P, GGV06T, GM106H, GM106M, GM106M+SC, GM106P, GMT06D, GV106H, GV106M, GV106M+SC, GV106P...(Other models you can see in the webshop)		

Part No.	550858	Ref. No.	58003840 LA58003840 LAR58003840
description	flange for fan motor ED ø 60mm int. ø 1 28.5mm int. ø 2 25mm thickness 4mm brass		
For models:	ACG10M, AVE10D, AVE10P, BPE084M, BPE084P, BPE104M, BPE104P, BPG084M, BPG084P, BPG104M, BPG104P, CE100M, CE200M, CG100M, CG200M, CGC24M, CGC40M, EC110M, EC210M, EM010M+SC, EM110H, EM110M, EM110M+SC, EM110P, EM210H, EM210M, EM210M+SC, EM210P, EPE056T, EPE086T, EPE156T, EPEV05T, EPEV08T, EPEV15T, EPG056T, EPG086T, EPG156T, EPGV05T, EPGV08T, EPGV15T, EV110H, EV110M, EV110M+SC, EV110P, EV210H, EV210M, EV210M+SC, EV210P, FE110M, FE110X...(Other models you can see in the webshop)		

Part No.	550860	Ref. No.	58005500 LAR58005500
description	flange for gasket ED ø 35mm int. ø 1 22mm int. ø 2 9mm thickness 8mm brass		
For models:	BPE044M, BPE044P, BPE054M, BPE054P, BPG044M, BPG044P, BPG054M, BPG054P, CE041M, CE051M, CG051M, MACE04M, MACE05M, MACG05M, MCE042M, MCE051M, MCG051M, MVE042P, MVE051P, MVG051P, VE042P, VE051P, VE055P, VG051P		





			
1			
Part No.	560449	Ref. No.	58004000 LA58004000 LAR58004000
description	hexagonal screw thread M12x1.5 L thread L 22mm bore ϕ 6.3mm WS 19 total length 30mm		
For models:	ACG10M, AVE10D, AVE10P, BPE084M, BPE084P, BPE104M, BPE104P, BPG084M, BPG084P, BPG104M, BPG104P, CE100M, CE200M, CG100M, CG200M, CGC24M, CGC40M, EC110M, EC210M, EM010M+SC, EM110H, EM110M, EM110M+SC, EM110P, EM210H, EM210M, EM210M+SC, EM210P, EPE056T, EPE086T, EPE156T, EPEV05T, EPEV08T, EPEV15T, EPG056T, EPG086T, EPG156T, EPGV05T, EPGV08T, EPGV15T, EV110H, EV110M, EV110M+SC, EV110P, EV210H, EV210M, EV210M+SC, EV210P, FE110M, FE110X... (Other models you can see in the webshop)		

			
1			
Part No.	500639	Ref. No.	65040101 65490710 LAR65040101 LAR65490710
description	motor kit 220/240V 1 phase 50/60Hz 0.25kW type K48210		
For models:	CVE004H, CVE004M, CVE104H, CVE104M, VE004D, VE004H, VE004M, VE004X, VE104D, VE104H, VE104M, VE104X		
spare parts for	500639		

			
Part No.	511170	Ref. No.	50505895 70020010 LAR50505895 LAR70020010 R50505895 R70020010
description	shaft seal ID ϕ 7mm ED ϕ 22mm thickness 7mm		

			
Part No.	550855	Ref. No.	58005510 LAR58005510 R58005510
description	flange for fan motor ED ϕ 35mm int. ϕ 1 22mm int. ϕ 2 8mm thickness 8mm brass		

			
Part No.	601067	Ref. No.	50405781 75400030 75400040 LAR50405781 LAR75400030 LAR75400040 R50405781 R75400030 R75400040
description	fan wheel D1 ϕ 150mm H1 38mm blades 36 D2 ϕ 6mm D3 ϕ 6mm H2 14mm		

			
Part No.	601856	Ref. No.	65041010 LAR65041010 R65041010
description	fan motor 230V 1 phase 50Hz 0.075kW 2650rpm speeds 1 L1 85mm L2 30mm L3 23mm L4 12mm D1 ϕ 8x6mm D2 ϕ 8mm 0.6A suitable capacitor 5 μ F/400V		

			
1			
Part No.	550861	Ref. No.	70020020 LA70020020 LAR70020020
description	shaft seal for fan motor ID ϕ 7.5mm ED ϕ 22mm thickness 7mm		
For models:	BPE044M, BPE044P, BPE054M, BPE054P, BPG044M, BPG044P, BPG054M, BPG054P, CE041M, CE051M, CG051M, MACE04M, MACE05M, MACG05M, MCE042M, MCE051M, MCG051M, MVE042P, MVE051P, MVG051P, VE042P, VE051P, VE055P, VG051P		

			
1			
Part No.	511171	Ref. No.	50505880 70020040 LA70020040 LAR50505880 LAR70020040
description	shaft seal ID ϕ 14.5mm ED ϕ 20mm thickness 3mm		
For models:	AVE07D, BPE064M, BPE064P, BPE074M, BPE074P, BPG064M, BPG064P, BPG074M, BPG074P, CE071M, CG071M, CVE105H, CVE105M, CVG105H, CVG105M, EC106M, EM106H, EM106M, EM106M+SC, EM106P, EMT06D, EPE056T, EPEV05T, EPG056T, EPGV05T, EV006M, EV106H, EV106M, EV106M+SC, EV106P, FE105M, FE105X, FG051M, FG051X, FG105M, FG105X, GC106M, GEMT06P, GEMT06T, GEMT10P, GEMT10T, GEMT21P, GEMT21T, GEVT06P, GEVT06T, GEVT10P, GEVT10T, GEVT21P, GEVT21T, GGMT06P...(Other models you can see in the webshop)		

			
1			
Part No.	511170	Ref. No.	50505895 70020010 LAR50505895 LAR70020010
description	shaft seal ID ϕ 7mm ED ϕ 22mm thickness 7mm		
For models:	CVE004H, CVE004M, CVE104H, CVE104M, ME004L, ME004S, ME104L, ME104S, VE004D, VE004H, VE004M, VE004S, VE004X, VE104D, VE104H, VE104M, VE104S, VE104X		



			
1			
Part No.	511172	Ref. No.	50505890 70020050 LA70020050 LAR50505890 LAR70020050
description	shaft sealing ID ϕ 24mm ED ϕ 29mm thickness 3mm		
For models:	ACG10M, AVE10D, AVE10P, BPE084M, BPE084P, BPE104M, BPE104P, BPG084M, BPG084P, BPG104M, BPG104P, CE100M, CE200M, CG100M, CG200M, CGC24M, CGC40M, EC110M, EC210M, EM010M+SC, EM110H, EM110M, EM110M+SC, EM110P, EM210H, EM210M, EM210M+SC, EM210P, EPE086T, EPE156T, EPEV08T, EPEV15T, EPG086T, EPG156T, EPGV08T, EPGV15T, EV110H, EV110M, EV110M+SC, EV110P, EV210H, EV210M, EV210M+SC, EV210P, FE110M, FE110X, FE210M, FG101M, FG101X, FG110M...(Other models you can see in the webshop)		

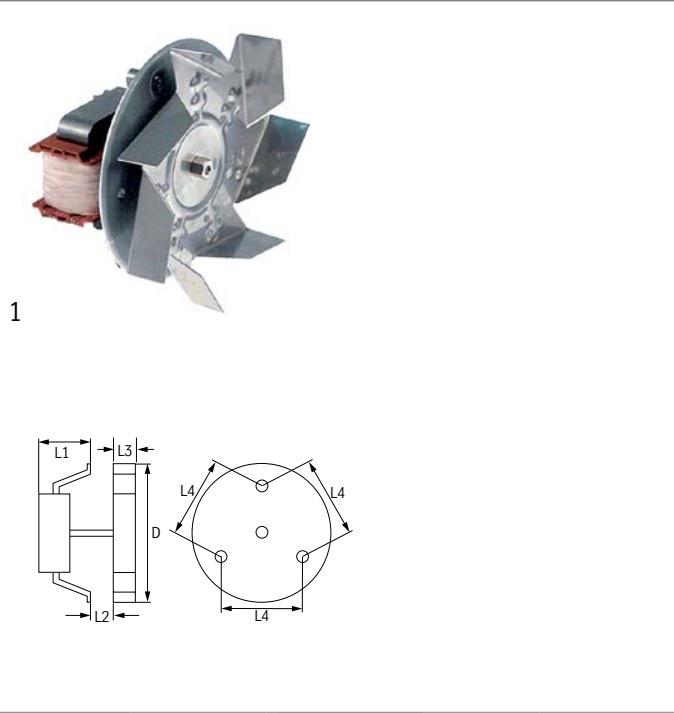

hot air fans

miscellaneous



Part No.	601054	Ref. No.	65060040 650600400 LAR650600400 MA1037117200
description	hot air fan 220-240V 32W 50/60Hz L1 60mm L2 10mm L3 25mm L4 87mm fan wheel ø 150mm FIME type C20X0E01/46		
For models:	VE210L, VE210S		
spare parts for	601054		
	Part No.	601441	Ref. No. —
	fan wheel ø 150mm W 25mm shaft intake ø 6x5mm stainless steel blades 7		
accessories for	601054		
	Part No.	550879	Ref. No. —
	insulation ø 130mm thickness 3mm hole ø 20mm for hot air fan		

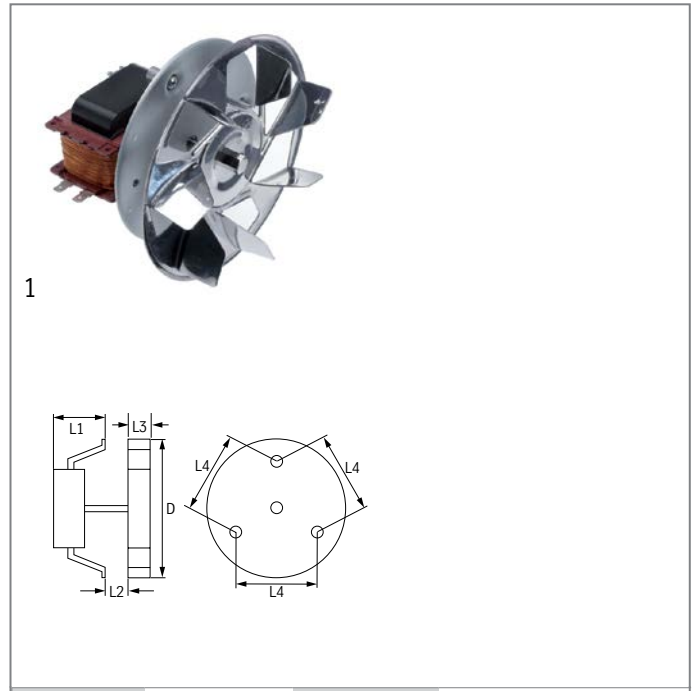

Part No.	601175	Ref. No.	34300420 65060030 A34300420 LA65060030 LAR65060030
description	hot air fan 230V 47W 50/60Hz L1 73mm L2 28mm L3 29mm L4 87mm fan wheel ø 154mm FIME type C30X0L13/05CLH		
For models:	RB142M, RC162M, RM262E, RM262M		

accessories

miscellaneous

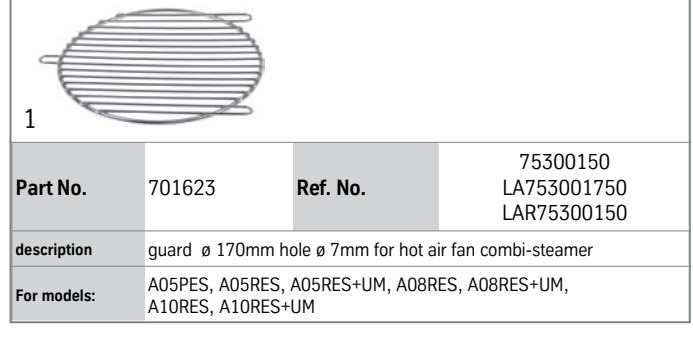

Part No.	701623	Ref. No.	75300150 LA753001750 LAR75300150
description	guard ø 170mm hole ø 7mm for hot air fan combi-steamer		
For models:	A05PES, A05RES, A05RES+UM, A08RES, A08RES+UM, A10RES, A10RES+UM		



Part No.	551434	Ref. No.	58004010 LA58004010 LAR58004010
description	plain washer ø 30mm thickness 3mm hole ø 12.5mm for fan wheel combi-steamer		
For models:	ACG10M, AVE10D, AVE10P, BPE084M, BPE084P, BPE104M, BPE104P, BPG084M, BPG084P, BPG104M, BPG104P, CE100M, CE200M, CG100M, CG200M, CGC24M, CGC40M, EC110M, EC210M, EM010M+SC, EM110H, EM110M, EM110M+SC, EM110P, EM210H, EM210M, EM210M+SC, EM210P, EPE056T, EPE086T, EPE156T, EPEV05T, EPEV08T, EPEV15T, EPG056T, EPG086T, EPG156T, EPGV05T, EPGV08T, EPGV15T, EV110H, EV110M, EV110M+SC, EV110P, EV210H, EV210M, EV210M+SC, EV210P, FE110M, FE110X... (Other models you can see in the webshop)		



miscellaneous



1

Part No.	500201	Ref. No.	65110300 LA65110300 LAR65110300
description	drain pump inlet ø 24mm outlet ø 22mm 230V 100W		
For models:	GMT06D		

booster pumps II

accessories





1

Part No.	365015	Ref. No.	65190180 LA65190180 LAR65190180
description	operating capacitor capacity 10µF 400V tolerance 5%Hz ambient temperature max. -25 to +85°C ø 35.5mm L 59mm M8 plastic connection male faston 6.3mm protection		
For models:	ACG10M, AVE07D, AVE10D, AVE10P, BPE044M, BPE044P, BPE054M, BPE054P, BPG044M, BPG044P, BPG054M, BPG054P, BPG064M, BPG064P, BPG074M, BPG074P, CE041M, CE051M, CE071M, CE100M, CE200M, CG051M, CG071M, CG100M, CG200M, EC106M, EM106H, EM106M, EM106M+SC, EM106P, EMT06D, EV006M, EV106H, EV106M, EV106M+SC, EV106P, FG051M, FG051X, GC106M, GGMT06P, GGVT06P, GM106H, GM106M, GM106M+SC, GM106P, GMT06D, GV106H, GV106M, GV106M+SC, GV106P...(Other models you can see in the webshop)		

vibration pumps



1

Part No.	500568	Ref. No.	65110600 LAR65110600
description	vibration pump 230V 32W 50Hz inlet ø 7 outlet ø 1/8" IT CEME type E512/A32		
For models:	EPE056T, EPE086T, EPE156T, EPEV05T, EPEV08T, EPEV15T, EPG056T, EPG086T, EPG156T, EPGV05T, EPGV08T, EPGV15T, GEMT06P, GEMT06T, GEMT10P, GEMT10T, GEMT20P, GEMT20T, GEMT21P, GEMT21T, GEMT40P, GEMT40T, GEVT06P, GEVT06T, GEVT10P, GEVT10T, GEVT20P, GEVT20T, GEVT21P, GEVT21T, GEVT40P, GEVT40T, GGMT06P, GGMT06T, GGMT10P, GGMT10T, GGMT20P, GGMT20T, GGMT21P, GGVT06T, GGVT10P, GGVT10T, GGVT20P, GGVT20T, GGVT21P, GGVT21T...(Other models you can see in the webshop)		
spare parts for	500568		
	Part No.	390698	Ref. No. —
	thermal fuse switch-off temp. 110°C suitable for ULKA pump		
	Part No.	520153	Ref. No. —
	bracket rubber dimensions 53x34x28mm		



1

Part No.	501567	Ref. No.	65110620 LAR65110620
description	vibration pump type HF 230V 22W 50Hz inlet ø 6 outlet ø 6 ULKA plastic L 97mm connection male faston 4.8mm		



1

Part No.	500563	Ref. No.	69200060 99600624 A34300430 LAR69200060 LAR99600624
description	vibration pump type NME Typ2 230V 16W 50Hz inlet ø 4 outlet ø 6 ULKA L 76mm 110cc/min		
For models:	RB072E, RC162M, RM262E, RM262M		

condensators & interference sup
pression filters

operating capacitors

plastic



1

Part No.	365015	Ref. No.	65190180 LA65190180 LAR65190180
description	operating capacitor capacity 10µF 400V tolerance 5%Hz ambient temperature max. -25 to +85°C ø 35.5mm L 59mm M8 plastic connection male faston 6.3mm protection		
For models:	ACG10M, AVE07D, AVE10D, AVE10P, BPE044M, BPE044P, BPE054M, BPE054P, BPG044M, BPG044P, BPG054M, BPG054P, BPG064M, BPG064P, BPG074M, BPG074P, CE041M, CE051M, CE071M, CE100M, CE200M, CG051M, CG071M, CG100M, CG200M, EC106M, EM106H, EM106M, EM106M+SC, EM106P, EMT06D, EV006M, EV106H, EV106M, EV106M+SC, EV106P, FG051M, FG051X, GC106M, GGMT06P, GGV06P, GM106H, GM106M, GM106M+SC, GM106P, GMT06D, GV106H, GV106M, GV106M+SC, GV106P...(Other models you can see in the webshop)		



1

Part No.	365014	Ref. No.	LA65190090
description	operating capacitor capacity 12.5µF 450V tolerance 5%Hz ambient temperature max. -25 to +85°C ø 35mm L 70mm M8 plastic connection male faston 6.3mm 45S.C3DS.12.5 protection		

1

Part No.	365034	Ref. No.	65190090 LA65190090 LAR65190090
description	operating capacitor capacity 12µF with plastic sheathing		
For models:	FG101X, GM110H, GM110P, GM210H, GM210P, GMT20P, GV110H, GV110P, GV210H, GV210P, MG102P, MG102T, MG110H, MG110L, MG110P, MG110T, MG110X, MG120H, MG120L, MG120P, MG120T, MG120X, MG210H, MG210P, MG210T, MG210X, MG220H, MG220L, MG220P, MG220T, MG220X, MGC20H, MGC24H, MGC40H, MGC40P, MGMT20P, MGV20P, PG081X, PG101X, VG102P, VG110H, VG110P, VG110T, VG110X, VG120H, VG120P, VG120X, VG210H, VG210P, VG210T...(Other models you can see in the webshop)		



1

Part No.	365021	Ref. No.	65190030 LAR65190030
description	operating capacitor capacity 16µF 425V tolerance 5% 50/60Hz ambient temperature max. -25 to +85°C ø 35mm L 73mm single M8 plastic connection male faston 6.3mm 416.10.99 protection		
For models:	CGC24M, CGC40M, GC110M, GC210M, GM110H, GM110M, GM110M+SC, GM110P, GM210H, GM210M, GM210M+SC, GM210P, GMT20D, GMT20P, GV110H, GV110M, GV110M+SC, GV110P, GV210H, GV210M, GV210M+SC, GV210P, GVT20D, MG102D, MG102H, MG102M, MG102P, MG102T, MG110D, MG110H, MG110L, MG110M, MG110P, MG110S, MG110T, MG110X, MG120D, MG120H, MG120L, MG120M, MG120P, MG120S, MG120T, MG120X, MG210D, MG210H, MG210M, MG210P, MG210T, MG210X...(Other models you can see in the webshop)		



1

Part No.	365009	Ref. No.	965315
description	operating capacitor capacity 2.5µF 400V tolerance 5% 50Hz ambient temperature max. -25 to +85°C ø 36.5mm L 55mm M8 plastic connection male faston 6.3mm 1.27.65C3 protection		



1

Part No.	365019	Ref. No.	65190040
description	operating capacitor capacity 20µF 400V tolerance 5% 50/60Hz ambient temperature max. -25 to +85°C ø 39.5mm L 70mm M8 plastic connection male faston 6.3mm 16.10.25. protection		



1

Part No.	365031	Ref. No.	50405600 65190010 LAR65190010
description	operating capacitor capacity 4µF 450V tolerance 5% 50/60Hz ambient temperature max. -25 to +85°C ø 31mm L 58mm M8 plastic connection male faston 6.3mm protection		
For models:	FE05, FG05, ME004L, ME004S, ME104L, ME104S, ME105L, ME105S, MG105L, MG105S, VE004S, VE104S, VE105S, VG105S		





1

Part No.	365033	Ref. No.	65190080 LA65190080 LAR65190080
description	operating capacitor capacity 5µF with plastic sheathing		
For models:	CVE004H, CVE004M, CVE104H, CVE104M, CVE105H, CVE105M, CVG105H, CVG105M, ME106D, ME106H, ME106L, ME106M, ME106P, ME106S, ME106T, ME106X, MG106D, MG106H, MG106L, MG106M, MG106P, MG106S, MG106T, MG106X, VE004D, VE004H, VE004M, VE004X, VE104D, VE104H, VE104M, VE104X, VE105D, VE105H, VE105M, VE105X, VE106D, VE106H, VE106L, VE106M, VE106P, VE106S, VE106T, VE106X, VE155H, VE155M, VE155X, VG105D, VG105H, VG105M...(Other models you can see in the webshop)		

filters

interference suppression filters



1

Part No.	365044	Ref. No.	65280200 LA65280200 LAR65280200
description	interference suppression filter type FC701Y2F 250V 50-60Hz conductor 2 with E connection cable 200mm L 42mm ø 23mm Hmm Wmm plastic Qty 1 pcs		
For models:	AVE07D, AVE10D, AVE10P, BPE044M, BPE044P, BPE054M, BPE054P, BPE064P, BPE074P, BPE084P, BPE104P, CE041M, CE051M, CE071M, CE100M, CE200M, CG051M, EC106M, EC110M, EC210M, EM010M+SC, EM106H, EM106M, EM106M+SC, EM106P, EM110H, EM110M, EM110M+SC, EM110P, EM210H, EM210M, EM210M+SC, EM210P, EMT06D, EPG056T, EPG086T, EPGV05T, EPGV08T, EV006M, EV106H, EV106M, EV106M+SC, EV106P, EV110H, EV110M, EV110M+SC, EV110P, EV210H, EV210M, EV210M+SC...(Other models you can see in the webshop)		

ferrite rings



1

Part No.	691295	Ref. No.	65280450 LAR65280450
description	ferrite ring ID ø 17mm ED ø 28mm H 20mm for protection		
For models:	AVE07D, AVE10D, AVE10P, EM106H, EM106P, EM110H, EM110P, EM210H, EM210P, EMT06D, EV106H, EV106P, EV110H, EV110P, EV210H, EV210P, GM106H, GM106P, GM110H, GM110P, GM210H, GM210P, GMT06D, GMT20D, GMT20P, GV106H, GV106P, GV110H, GV110P, GV210H, GV210P, GVT06D, GVT20D, ME061D, ME061H, ME061P, ME061T, ME101D, ME101H, ME101P, ME101T, ME102H, ME102P, ME102T, ME201D, ME201H, ME201P, ME201T, ME202D, ME202H...(Other models you can see in the webshop)		

RC circuits



1

Part No.	365155	Ref. No.	65280010 65280130 LAR65280010 LAR65280130
description	RC circuit 250/630V connection male faston 6.3mm cable length 65mm capacity 47nF 1000hm		
For models:	ACG10M, BPE064M, BPE074M, BPE084M, BPE104M, CE041M, CE051M, CE071M, CE100M, CE200M, CG051M, CG071M, CG100M, CG200M, CGC24M, CGC40M, EC106M, EC110M, EC210M, EM010M+SC, EM106M, EM106M+SC, EM110M, EM110M+SC, EM210M, EM210M+SC, EV006M, EV106M, EV106M+SC, EV110M, EV110M+SC, EV210M, EV210M+SC, FG051M, FG051X, FG101M, FG101X, GC106M, GC110M, GC210M, GM106M, GM106M+SC, GM110M, GM110M+SC, GM210M, GM210M+SC, GV106M, GV106M+SC, GV110M, GV110M+SC...(Other models you can see in the webshop)		



1

Part No.	365054	Ref. No.	65280490 LAR65280490
description	ferrite ring ID ø 22mm ED ø 38mm H 17mm for protection		
For models:	BPE044P, BPE054P, BPE064P, BPE074P, BPE084P, BPE104P, BPG044P, BPG054P, BPG064P, BPG074P, BPG084P, BPG104P, EPG056T, EPG086T, EPG156T, EPGV05T, EPGV08T, EPGV15T, GEMT06P, GEMT06T, GEMT10P, GEMT10T, GEMT20P, GEMT20T, GEMT21P, GEMT21T, GEMT40P, GEMT40T, GEVT06P, GEVT06T, GEVT10P, GEVT10T, GEVT20P, GEVT20T, GEVT21P, GEVT21T, GEVT40P, GEVT40T, GGMT06P, GGMT06T, GGMT10P, GGMT10T, GGMT20P, GGMT20T, GGMT21P, GGMT21T, GGMT40P, GGMT40T, GGVT06P, GGVT06T...(Other models you can see in the webshop)		

fuses

fine fuses



1

Part No.	358662	Ref. No.	65200080
description	fine fuse size ø5x20mm 0.125A fast-acting rated 250V Qty 10 pcs		
For models:	ME004L, ME004S, ME104L, ME104S, ME105L, ME105S, ME106L, ME106S, ME106T, ME110L, ME110S, ME110T, ME120L, ME120S, ME120T, ME210L, ME210S, ME210T, ME220L, ME220S, ME220T, MG105L, MG105S, MG106L, MG106S, MG106T, MG110L, MG110S, MG110T, MG120L, MG120S, MG120T, MG210L, MG210S, MG210T, MG220L, MG220S, MG220T, VE004S, VE104S, VE105S, VE106L, VE106S, VE106T, VE110L, VE110S, VE110T, VE210L, VE210S, VE210T...(Other models you can see in the webshop)		



			
1			
Part No.	358532	Ref. No.	65200200 LA65200200 LAR65200200
description	fine fuse size ø5x20mm 2A fast-acting rated 250V Qty 10 pcs		
For models:	ACG10M, AVE07D, AVE10D, AVE10P, BPE044M, BPE044P, BPE054M, BPE054P, BPE064M, BPE064P, BPE074M, BPE074P, BPE084M, BPE084P, BPE104M, BPE104P, BPG044M, BPG044P, BPG054M, BPG054P, BPG064M, BPG064P, BPG074M, BPG074P, BPG084M, BPG084P, BPG104M, BPG104P, CE041M, CE051M, CE071M, CE100M, CE200M, CG051M, CG071M, CG100M, CG200M, CGC24M, CGC40M, CVE004H, CVE004M, CVE104H, CVE104M, CVE105H, CVE105M, CVG105H, CVG105M, EC106M, EC110M, EC210M...(Other models you can see in the webshop)		

			
1			
Part No.	358678	Ref. No.	65200370 LA65200370
description	fine fuse size ø5x20mm 8A fast-acting rated 250V Qty 10 pcs		

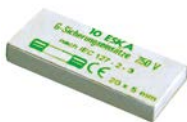
			
1			
Part No.	358593	Ref. No.	65200086 LAR65200086 R65200088
description	fine fuse size ø5x20mm 0.125A slow-acting rated 250V Qty 10 pcs		
For models:	BPE044M, BPE044P, BPE054M, BPE054P, BPE064M, BPE064P, BPE074M, BPE074P, BPE084M, BPE084P, BPE104M, BPE104P, BPG044M, BPG044P, BPG054M, BPG054P, BPG064M, BPG064P, BPG074M, BPG074P, BPG084M, BPG084P, BPG104M, BPG104P, CVE004H, CVE104H, CVE105H, CVG105H, EM010M+SC, EM106H, EM106M+SC, EM106P, EM110M+SC, EM110P, EM210M+SC, EM210P, EPE056T, EPE086T, EPE156T, EPEV05T, EPEV08T, EPEV15T, EPG056T, EPG086T, EPG156T, EPGV05T, EPGV08T, EPGV15T, EV106H, EV106M+SC...(Other models you can see in the webshop)		

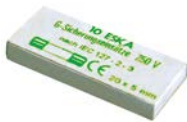
			
1			
Part No.	358592	Ref. No.	65200140 65200300 LA65200300 LAR65200140 LAR65200300
description	fine fuse size ø5x20mm 0.1A slow-acting rated 250V Qty 10 pcs		
For models:	GMT20D, ME004L, ME004S, ME104L, ME104S, ME105L, ME105S, ME106L, ME106S, ME110L, ME110S, ME120L, ME120S, ME210L, ME210S, ME220L, ME220S, MG061M, MG101D, MG101M, MG102D, MG102M, MG105L, MG105S, MG106L, MG106S, MG110L, MG110S, MG120L, MG120S, MG201D, MG201M, MG210L, MG210S, MG220L, MG220S, MGMT20D, VG101D, VG101M, VG102D, VG102M, VG201D, VG201M		

			
1			
Part No.	358595	Ref. No.	65200145 65200320 LA65200320 LAR65200145 LAR65200320
description	fine fuse size ø5x20mm 0.2A slow-acting rated 250V Qty 10 pcs		
For models:	AVE10D, BPE064P, BPE074P, BPG064P, BPG074P, CE100M, CE200M, EC106M, EM106H, EM106M, EM106M+SC, EM106P, EM110H, EM110P, EM210H, EM210P, EPE056T, EPEV05T, EPG056T, EPGV05T, EV006M, EV106H, EV106M, EV106M+SC, EV106P, EV110H, EV110P, EV210H, EV210P, FG051X, FG105X, GC106M, GEMT06P, GEMT06T, GEVT06P, GEVT06T, GGMT06P, GGMT06T, GGVT06P, GGVT06T, GM106H, GM106M, GM106M+SC, GM106P, GM110H, GM210H, GV106H, GV106M, GV106M+SC, GV106P...(Other models you can see in the webshop)		

			
1			
Part No.	358703	Ref. No.	65200350 LA65200350 LAR65200350
description	fine fuse size ø5x20mm 0.4A slow-acting rated 250V Qty 10 pcs		
For models:	BPE084P, BPE104P, BPG084P, BPG104P, CGC24M, CGC40M, EC110M, EC210M, EM010M+SC, EM110H, EM110M, EM110M+SC, EM110P, EM210H, EM210M, EM210M+SC, EM210P, EPE086T, EPE156T, EPEV08T, EPEV15T, EPG086T, EPG156T, EPGV08T, EPGV15T, EV110H, EV110M, EV110M+SC, EV110P, EV210H, EV210M, EV210M+SC, EV210P, FE105X, FG101X, FG110X, FG210X, GC110M, GC210M, GEMT10P, GEMT10T, GEMT20P, GEMT20T, GEMT21P, GEMT21T, GEMT40P, GEMT40T, GEVT10P, GEVT10T, GEVT20P...(Other models you can see in the webshop)		

			
1			
Part No.	358600	Ref. No.	65200160
description	fine fuse size ø5x20mm 1A slow-acting rated 250V Qty 10 pcs		

			
1			
Part No.	358609	Ref. No.	65200240 R65200240
description	fine fuse size ø5x20mm 5A slow-acting rated 250V Qty 10 pcs		



fine fuse holders

1			
Part No.	358512	Ref. No.	50302160 65210020 LA65210020 LAR50302160 LAR65210020
description	fuse holder		
For models:	ACG10M, AVE07D, AVE10D, AVE10P, BPE044M, BPE044P, BPE054M, BPE054P, BPE064M, BPE064P, BPE074M, BPE074P, BPE084M, BPE084P, BPE104M, BPE104P, BPG044M, BPG044P, BPG054M, BPG054P, BPG064M, BPG064P, BPG074M, BPG074P, BPG084M, BPG084P, BPG104M, BPG104P, CE041M, CE051M, CE071M, CE100M, CE200M, CG051M, CG071M, CG100M, CG200M, CGC24M, CGC40M, CVE004H, CVE004M, CVE104H, CVE104M, CVE105H, CVE105M, CVG105H, CVG105M, EC106M, EC110M, EC210M...(Other models you can see in the webshop)		

2			
Part No.	550104	Ref. No.	LA65210020
description	fuse holder WIELAND type WK4/THSI 5 U/V0 suitable fuse ø5x30mm 0.5-6mm² top-hat rail 35mm 10A rated 600V		

overload switches

1			
Part No.	358514	Ref. No.	65160300 LA65160300 LAR65160300
description	overload switch drop-away current 0.8A		
For models:	BPE064M, BPE064P, BPE074M, BPE074P, BPG064M, BPG064P, BPG074M, BPG074P, EM106H, EM106P, EV106H, EV106P, FG051X, GM106H, GM106P, GV106H, GV106P, ME061P, ME061T, MEMT06P, MEVT06P, MG061P, MG061T, MGMT06P, MGVT06P, PG041X, PG051X, VE061P, VG061P		

1			
Part No.	358522	Ref. No.	50304370 65160400 LAR50304370 LAR65160400
description	overload switch drop-away current 1.5A		
For models:	FE05, FG05		

1			
Part No.	358515	Ref. No.	65160310 LA65160310 LAR65160310
description	overload switch drop-away current 2.5A		
For models:	EC106M, EM106H, EM106M, EM106M+SC, EM106P, EV006M, EV106H, EV106M, EV106M+SC, EV106P, FG051M, FG051X, GC106M, GM106H, GM106M, GM106M+SC, GM106P, GV106H, GV106M, GV106M+SC, GV106P, MG061H, MG061M, MG061P, MG061T, PG041M, PG041X, PG051X, VG106X		

1			
Part No.	358520	Ref. No.	50304400 65160220 LAR50304400 LAR65160220
description	overload switch drop-away current 2.5A connection male faston 6.3mm		
For models:	FE105M, FE105X, FG105M, FG105X, ME05, MG05, PE04, PE040M, PE040X, PG04, PG040M, PG040X, RE05, RG05		

1			
Part No.	358516	Ref. No.	65160320 LA65160320 LAR65160320
description	overload switch drop-away current 2A		
For models:	AVE07D, BPE064M, BPE064P, BPE074M, BPE074P, BPG064M, BPG064P, BPG074M, BPG074P, CE071M, CG071M, EMT06D, GEMT06P, GEVT06P, GGMT06P, GGVTO6P, GMT06D, GVT06D, HME061P, HMG061P, HVE061P, HVG061P, MACE07M, MACG07M, MCE071M, MCG071M, ME061D, ME061H, ME061M, ME061P, ME061T, MEMT06D, MEMT06P, MEVT06D, MEVT06P, MG061D, MG061M, MG061P, MG061T, MGMT06D, MGMT06P, MGVT06D, MGVT06P, MME071P, MMG071P, MVE071M, MVE071P, MVG071P, VE061D, VE061M...(Other models you can see in the webshop)		

electric accessories

cables

ribbon cables

group 1

1			
Part No.	403107	Ref. No.	65301470 LAR65301470
description	ribbon cable 16-pole L 85mm plug type 2 row coded		
For models:	AVE10P, ME061H, ME061P, ME101H, ME101P, ME102H, ME102P, ME201H, ME201P, ME202H, ME202P, MEMT06P, MEMT10P, MEMT20P, MEMT21P, MEMT40P, MEVT06P, MEVT10P, MEVT20P, MEVT21P, MEVT40P, MG061H, MG061P, MG101H, MG101P, MG102H, MG102P, MG201H, MG201P, MG202H, MG202P, MGMT06P, MGMT10P, MGMT20P, MGMT21P, MGMT40P, MGVT06P, MGVT10P, MGVT20P, MGVT21P, MGVT40P, VE061P, VE101P, VE102P, VE201P, VE202P, VG061P, VG101P, VG102P, VG201P...(Other models you can see in the webshop)		



miscellaneous



Part No.	403839	Ref. No.	66110310 LA66110310
description	cable for combi-steamer L 370m copper insulation glass fibre braiding/silicone rubber		



Part No.	403840	Ref. No.	66110330 LAR66110330
description	cable for combi-steamer L 860m copper insulation glass fibre braiding/silicone rubber		



Part No.	401960	Ref. No.	66110320 LA66110320 LAR66110320
description	kable set		
For models:	ACG10M, AVE07D, AVE10D, AVE10P, BPE064M, BPE064P, BPE074M, BPE074P, BPE084M, BPE084P, BPE104M, BPE104P, BPG064M, BPG064P, BPG074M, BPG074P, BPG084M, BPG084P, BPG104M, BPG104P, CE071M, CE100M, CE200M, CG071M, CG100M, CG200M, EPE086T, EPE156T, EPEV08T, EPEV15T, EPG086T, EPG156T, EPGV08T, EPGV15T, GEMT10P, GEMT10T, GEMT20P, GEMT20T, GEMT40P, GEMT40T, GEVT10P, GEVT10T, GEVT20P, GEVT20T, GEVT40P, GEVT40T, GGMT10P, GGMT10T, GGMT20P, GGMT20T... (Other models you can see in the webshop)		

terminals

connection terminals with screw/faston connections



Part No.	550411	Ref. No.	1037104000
description	power terminal block 6-pole max. 40A max 450V connection $\phi 6\text{mm}^2$ / F6.3 temp.-resist. 150°C cross section 6mm ²		

rail-mounted terminals

rail-mounted terminal blocks



Part No.	550552	Ref. No.	50304742 65220140 LAR50304742 LAR65220140
description	rail-mounted terminal block		
For models:	ME40, MME40		





Part No.	550421 ¹	Ref. No.	50304720 65220090 65220091 LAR50304720 LAR65220090 LAR65220091
description	rail-mounted terminal block 5-pole contacts 3P+N+E cross section 1.0-10mm ²		
For models:	A05PES, A05RES, A05RES+UM, A08RES, A08RES+UM, A10RES, A10RES+UM, AVE07D, BPE044M, BPE044P, BPE054M, BPE054P, BPE064M, BPE064P, BPE074M, BPE074P, CE041M, CE051M, CE071M, CG051M, CVE004H, CVE004M, CVE104H, CVE104M, CVE105H, CVE105M, CVG105H, CVG105M, EC106M, EM106H, EM106M, EM106M+SC, EM106P, EMT06D, EVO06M, EV106H, EV106M, EV106M+SC, EV106P, FE05, FE105M, FE105X, FE110M, FE110X, FG110M, FG110X, FG210M, FG210X, FV03, GEMT06P... (Other models you can see in the webshop)		

¹with fused terminal block

Part No.	550420	Ref. No.	65220080 65220081 65225000 LAR65220080 LAR65220081 LAR65225000
description	rail-mounted terminal block 5-pole contacts 3P+N+E cross section 1.5-16mm ²		
For models:	AVE10D, AVE10P, BPE084M, BPE084P, BPE104M, BPE104P, CE100M, EC110M, EM010M+SC, EM110H, EM110M, EM110M+SC, EM110P, EPG056T, EPG086T, EPGV05T, EPGV08T, EV110H, EV110M, EV110M+SC, EV110P, FE210M, GEMT10P, GEMT10T, GEVT10P, GEVT10T, HME101P, HME101T, HME101X, HVE101P, HVE101T, HVE101X, MACE10M, MCE101M, ME101D, ME101H, ME101M, ME101P, ME101T, ME110D, ME110H, ME110L, ME110M, ME110P, ME110S, ME110T, ME110X, ME227M, ME227P, ME227X... (Other models you can see in the webshop)		



			
1			
Part No.	550422	Ref. No.	50304741 65220130 65220131 65225020 LAR50304741 LAR65220130 LAR65220131 LAR65225020
description	rail-mounted terminal block 9-pole		
For models:	EC210M, EM210H, EM210M, EM210M+SC, EM210P, EV210H, EV210M, EV210M+SC, EV210P, GEMT40P, GEMT40T, GEVT40P, GEVT40T, HME202P, HME202T, HME202X, HVE202P, HVE202T, HVE202X, MCE202M, ME102D, ME102H, ME102M, ME102P, ME102T, ME120D, ME120H, ME120L, ME120M, ME120P, ME120S, ME120T, ME120X, ME15, ME20, ME201D, ME201H, ME201M, ME201P, ME201T, ME202D, ME202H, ME202M, ME202P, ME202T, ME21, ME210D, ME210H, ME210L, ME210M...		
	(Other models you can see in the webshop)		

WIELAND			
fuse terminal blocks			
			
1			
Part No.	550104	Ref. No.	LA65210020
description	fuse holder WIELAND type WK4/THSI 5 U/V0 suitable fuse ø5x30mm 0.5-6mm ² top-hat rail 35mm 10A rated 600V		

electronic magnets

			
1			
Part No.	698948	Ref. No.	65090310 LA65090310 LAR65090310
description	electronic magnet 220V voltage ACHz L 164mm W 65mm H 45mm 400W		

electronic components







varistors

			
1			
Part No.	403108	Ref. No.	65280040 LAR65280040
description	varistor S10K275		

gas thermostats

SIT

630 Eurosit series

			
1			
Part No.	101409	Ref. No.	MA1031504800
description	gas thermostat type 630 Eurosit series t.max. 280°C 40-280°C gas inlet 3/8" gas outlet 3/8" thermocouple connection M9x1 pilot connection M10x1 probe ø 4mm probe L 72mm capillary pipe 1050mm SIT		
spare parts for	101409		
	Part No.	101333	Ref. No.
		plug thread 3/8" with O-ring	
accessories for	101409		
	Part No.	100904	Ref. No.
		locking screw M10x1 for pipe ø 4mm Qty 1 pcs	
	Part No.	100905	Ref. No.
		locking screw M10x1 for pipe ø 6mm Qty 1 pcs	
	Part No.	101273	Ref. No.
		olive for pipe ø 12mm L 9.5mm brass Qty 1 pcs suitable for universal	
	Part No.	101276	Ref. No.
		union screw thread 3/8" tube ø 12mm Qty 1 pcs	



gas valves and ignition boxes

gas control valves

HONEYWELL



1

Part No.	106004	Ref. No.	63020150 LA63020150 LAR63020150
description	gas valve type VK4105C 220-240V 50/60Hz gas inlet flange 32x32mm gas outlet flange 32x32mm thermocouple connection pilot connection pressure range 15-60mbar max 60mbar operator type pressure controller type V5306E 1234 1 suitable for HONEYWELL flange 32x32mm		
For models:	FG051M, FG051X, FG101M, FG101X, GC106M, GC110M, GC210M, GV106M, GV106M+SC, GV110M, GV110M+SC, GV210M, GV210M+SC, PG041M, PG041X, PG051X, PG081M, PG081X, PG101M, PG101X, VG106X		
accessories for	106004		
	Part No.	102845	Ref. No. —
	gas connection angled 1/2" flange 32x32mm hole distance 24x24mm Tandem		
	Part No.	102846	Ref. No. —
	gas connection straight 1/2" flange 32x32mm hole distance 24x24mm suitable for Tandem		



1

Part No.	102320	Ref. No.	63020160 LA63020160 LAR63020160
description	gas valve type VK4105Q 220-240V 50/60Hz gas inlet flange 32x32mm gas outlet flange 32x32mm thermocouple connection pilot connection pressure range 15-60mbar max 60mbar operator type HONEYWELL coil type 220/240V (V4336A 2212 1) flange 32x32mm		
For models:	GM106H, GM106M, GM106M+SC, GM106P, GM110H, GM110M, GM110M+SC, GM110P, GM210H, GM210M, GM210M+SC, GM210P, GV106H, GV106P, GV110H, GV110P, GV210H, GV210P		
accessories for	102320		
	Part No.	102845	Ref. No. —
	gas connection angled 1/2" flange 32x32mm hole distance 24x24mm Tandem		
	Part No.	102846	Ref. No. —
	gas connection straight 1/2" flange 32x32mm hole distance 24x24mm suitable for Tandem		



1

Part No.	106012	Ref. No.	63020170 LAR63020170
description	gas valve type VK4115V 220-240V 50/60Hz gas inlet flange 32x32mm gas outlet flange 32x32mm thermocouple connection pilot connection pressure range 15-60mbar max 60mbar operator type HONEYWELL flange 32x32mm		
For models:	ACG10M, BPG044M, BPG044P, BPG054M, BPG054P, BPG064M, BPG064P, BPG074M, BPG074P, BPG084M, BPG084P, BPG104M, BPG104P, CG051M, CG071M, CG100M, CG200M, EPG056T, EPG086T, EPG156T, EPGV05T, EPGV08T, EPGV15T, GGMT06P, GGMT06T, GGMT10P, GGMT10T, GGMT20P, GGMT20T, GGMT21P, GGMT21T, GGMT40P, GGMT40T, GGVT06P, GGVT06T, GGVT10P, GGVT10T, GGVT20P, GGVT20T, GGVT21P, GGVT21T, GGVT40P, GGVT40T, GMT06D, GMT20D, GMT20P, GVT06D, GVT20D, HMG061P, HMG061T...(Other models you can see in the webshop)		
accessories for	106012		
	Part No.	102845	Ref. No. —
	gas connection angled 1/2" flange 32x32mm hole distance 24x24mm Tandem		
	Part No.	102846	Ref. No. —
	gas connection straight 1/2" flange 32x32mm hole distance 24x24mm suitable for Tandem		



1

Part No.	101395	Ref. No.	63020010 LA63020010 LAR63020010
description	gas valve type VR4605P 230V 50Hz gas inlet 1/2" gas outlet 1/2" thermocouple connection pilot connection pressure range 8-50mbar operator type 230V (V404A 1071) pressure controller type 220/240V (V404A 1071 4) HONEYWELL coil type 220/240V (V4336A 2220) flange 45x45mm		
For models:	CGC24M, CGC40M, CVG105H, CVG105M, MG105L, MG105S, MG106D, MG106H, MG106L, MG106M, MG106P, MG106S, MG106T, MG106X, MG110D, MG110H, MG110L, MG110M, MG110P, MG110S, MG110T, MG110X, MG120D, MG120H, MG120L, MG120M, MG120P, MG120S, MG120T, MG120X, MG210D, MG210H, MG210M, MG210P, MG210T, MG210X, MG220D, MG220H, MG220L, MG220M, MG220P, MG220S, MG220T, MG220X, MGC20H, MGC20X, MGC24H, MGC40H, MGC40P, PG015M...(Other models you can see in the webshop)		
accessories for	101395		
	Part No.	101320	Ref. No. —
	cover suitable for gas valves HONEYWELL		
	Part No.	102845	Ref. No. —
	gas connection angled 1/2" flange 32x32mm hole distance 24x24mm Tandem		

Table continues overleaf



accessories for	101395		
	Part No.	102846	Ref. No. —
	gas connection straight 1/2" flange 32x32mm hole distance 24x24mm suitable for Tandem		

SIT

ELETTROSIT

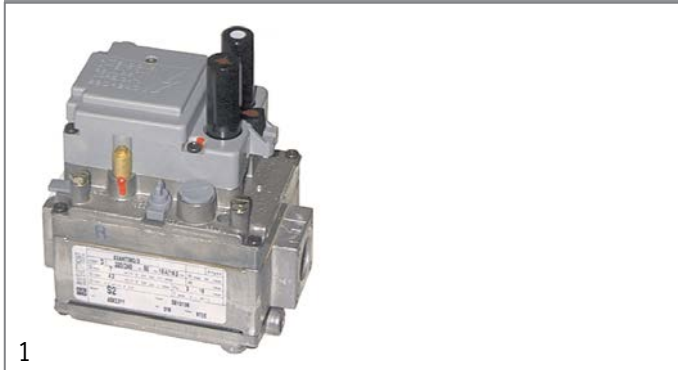

1

Part No.	101126	Ref. No.	50203151 63025020 LAR50203151 LAR63025020
description	gas valve SIT type ELETTROSIT 230V gas inlet 1/2" gas outlet 1/2" thermocouple connection M9x1 pilot connection M10x1 bottom equiv. no. 0.810.136		
For models:	FG05, FG105M, FG105X, MG05, PG04, PG040M, PG040X, RG05		
spare parts for	101126		
	Part No.	101312	Ref. No. 5001050
	microswitch		
	Part No.	101352	Ref. No. —
	solenoid coil 230V 50Hz suitable for ELETTROSIT		
accessories for	101126		
	Part No.	100006	Ref. No. —
	piezoelectric igniter suitable for ELETTROSIT body plastic blowing connection ø2.4mm ø 14mm		
	Part No.	100904	Ref. No. 1394700
	locking screw M10x1 for pipe ø 4mm Qty 1 pcs		
	Part No.	100905	Ref. No. —
	locking screw M10x1 for pipe ø 6mm Qty 1 pcs		
	Part No.	101301	Ref. No. —
	gas connection thread 1/2" straight ELETTROSIT screw with O-ring		
	Part No.	101303	Ref. No. —
	gas connection straight thread 3/4" ELETTROSIT		
	Part No.	101309	Ref. No. —
	extension		

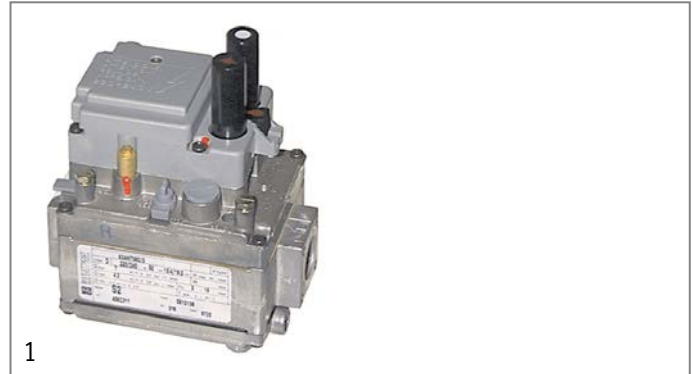







1

Part No.	101993	Ref. No.	5001051
description	gas valve SIT type ELETTROSIT 230V gas inlet 1/2" gas outlet 1/2" thermocouple connection M9x1 pilot connection M10x1 lateral equiv. no. 0.810.126		
spare parts for	101993		
	Part No.	101312	Ref. No. 5001050
	microswitch		
	Part No.	101352	Ref. No. —
	solenoid coil 230V 50Hz suitable for ELETTROSIT		
accessories for	101993		
	Part No.	100006	Ref. No. —
	piezoelectric igniter suitable for ELETTROSIT body plastic blowing connection ø2.4mm ø 14mm		
	Part No.	100904	Ref. No. 1394700
	locking screw M10x1 for pipe ø 4mm Qty 1 pcs		
	Part No.	100905	Ref. No. —
	locking screw M10x1 for pipe ø 6mm Qty 1 pcs		
	Part No.	101301	Ref. No. —
	gas connection thread 1/2" straight ELETTROSIT screw with O-ring		
	Part No.	101303	Ref. No. —
	gas connection straight thread 3/4" ELETTROSIT		
	Part No.	101309	Ref. No. —
	extension		
	Part No.	103104	Ref. No. —
	ignition switch		
	Part No.	541504	Ref. No. —
	double nipple thread 1/2" - 1/2"		



1			
Part No.	101127	Ref. No.	50203161 63025030 LAR50203161 LAR63025030
description	gas valve SIT type ELETROSIT 230V gas inlet 3/4" gas outlet 3/4" thermocouple connection M9x1 pilot connection M10x1 lateral equiv. no. 0.810.175		
For models:	FG110M, FG110X, FG210M, FG210X, MG05, MG10, MG15, MG21, MG24, MG40, PG08, PG080M, PG080X, PG12, RG07, RG10, RG20, RG24, RG40		
spare parts for	101127		
	Part No.	101312	Ref. No. 5001050
	microswitch		
	Part No.	101352	Ref. No. —
	solenoid coil 230V 50Hz suitable for ELETROSIT		
accessories for	101127		
	Part No.	100006	Ref. No. —
	piezoelectric igniter suitable for ELETROSIT body plastic blowing connection ø2.4mm ø 14mm		
	Part No.	100904	Ref. No. 1394700
	locking screw M10x1 for pipe ø 4mm Qty 1 pcs		
	Part No.	100905	Ref. No. —
	locking screw M10x1 for pipe ø 6mm Qty 1 pcs		
	Part No.	101301	Ref. No. —
	gas connection thread 1/2" straight ELETROSIT screw with O-ring		
	Part No.	101303	Ref. No. —
	gas connection straight thread 3/4" ELETROSIT		
	Part No.	101309	Ref. No. —
	extension		



1			
Part No.	101122	Ref. No.	63025010
description	gas valve SIT type ELETROSIT 24V gas inlet 3/4" gas outlet 3/4" thermocouple connection M9x1 equiv. no. 0.810.171 pilot outlet M10x1		
spare parts for	101122		
	Part No.	101312	Ref. No. 5001050
	microswitch		
accessories for	101122		
	Part No.	100006	Ref. No. —
	piezoelectric igniter suitable for ELETROSIT body plastic blowing connection ø2.4mm ø 14mm		
	Part No.	100904	Ref. No. 1394700
	locking screw M10x1 for pipe ø 4mm Qty 1 pcs		
	Part No.	100905	Ref. No. —
	locking screw M10x1 for pipe ø 6mm Qty 1 pcs		
	Part No.	101301	Ref. No. —
	gas connection thread 1/2" straight ELETROSIT screw with O-ring		
	Part No.	101303	Ref. No. —
	gas connection straight thread 3/4" ELETROSIT		
	Part No.	101309	Ref. No. —
	extension		

NOVASIT









1			
Part No.	101187	Ref. No.	826920090 BN826920090 MA1870800
description	gas valve SIT series Novasit 820 0.17VHz gas inlet 1/2" gas outlet 1/2" thermocouple connection M9x1 pilot connection M10x1 ignition pressurembar pressure range 5-50mbar pressure regulator connection blind equiv. no. 0.820.301 supply Operator millivolt		
spare parts for	101187		
	Part No.	101065	Ref. No. —
	magnet unit with cable L 44mm D1 ø 30mm D2 ø 20mm suitable for NOVASIT		

Table continues overleaf



accessories for		101187	
	Part No.	100110	Ref. No. —
	pilot burner SIT type 190 series 3 flames nozzle ømm gas connectionmm		
	Part No.	101305	Ref. No. 63080010 LAR63080010 R63080010
	gas connection straight 1/2" flange 45x45mm ELETTROSIT/V4400/4600/4605 suitable for SIT/HONEYWELL hole distance 36x36mm		
	Part No.	101306	Ref. No. 63080020 LAR63080020 R63080020
	gas connection angled flange 45x45mm hole distance 36x36mm 1/2" ELETTROSIT/V4400/4600/4605 screw with O-ring suitable for SIT/HONEYWELL		
	Part No.	101307	Ref. No. —
	gas connection straight flange 45x45mm hole distance 36x36mm 3/4" ELETTROSIT/V4400/4600/4605 screw with O-ring suitable for SIT/HONEYWELL		
	Part No.	101308	Ref. No. —
	gas connection angled flange 45x45mm hole distance 36x36mm 3/4" ELETTROSIT/V4400/4600/4605 screw with O-ring suitable for SIT/HONEYWELL		
	Part No.	102116	Ref. No. 1870712
	thermopile ROBERTSHAW L 900mm probe ø 9mm probe L 57mm 250-750mV screw connection 7/16"		

ignition boxes

HONEYWELL



1

Part No.	101165	Ref. No.	63060020 LA63060020 LAR63060020
description	ignition box HONEYWELL type S4560A 1008 equiv. no. S4560A 1008 electrodes 1 waiting time 0s safety time 10s 220-240V 10VA 50Hz		
For models:	MG105L, MG105S, MG106L, MG106S, MG106T, MG110L, MG110S, MG110T, MG120L, MG120S, MG120T, MG210T, MG220L, MG220S, MG220T, PG015M, PG115M, VG105S, VG106L, VG106S, VG106T, VG110L, VG110S, VG110T, VG210L, VG210S, VG210T		
spare parts for	101165		
	Part No.	358696	Ref. No. —
	fine fuse size ø5x20mm 4A medium lag rated 250V Qty 10 pcs		

Honeywell



1

Part No.	102367	Ref. No.	63060120 LAR63060120
description	ignition box HONEYWELL type S4565A 2092 1 electrodes 3 waiting times safety time 10s 220-240V 4VA 50/60Hz		
For models:	ACG10M, CG051M, CG071M, CG100M, CG200M, GMT06D, GMT20D, GMT20P, GVT06D, GVT20D, MACG05M, MACG07M, MACG10M, MACG20M, MG061D, MG061H, MG061M, MG061P, MG061T, MG101D, MG101H, MG101M, MG101P, MG101T, MG102D, MG102H, MG102M, MG102P, MG102T, MG201D, MG201H, MG201M, MG201P, MG201T, MG202D, MG202H, MG202M, MG202P, MG202T, MGMT06D, MGMT06P, MGMT10D, MGMT10P, MGMT20D, MGMT20P, MGMT21D, MGMT21P, MGMT40D, MGMT40P, MGVT06D...(Other models you can see in the webshop)		





Honeywell



















1

Part No.	102318	Ref. No.	63060100 LA63060100 LAR63060100
description	ignition box HONEYWELL type S4565AF 1007V01 electrodes 2 waiting times safety time 10s 220-240V 4VA 50/60Hz		
For models:	FG051M, FG051X, FG101M, FG101X, GC106M, GC110M, GC210M, GM106H, GM106M, GM106M+SC, GM106P, GM110H, GM110M, GM110M+SC, GM110P, GM210H, GM210M, GM210M+SC, GM210P, GV106H, GV106M, GV106M+SC, GV106P, GV110H, GV110M, GV-110M+SC, GV110P, GV210H, GV210M, GV210M+SC, GV210P, PG041M, PG041X, PG051X, PG081M, PG081X, PG101M, PG101X, VG106X		



accessories for		106906	
	Part No.	102110	Ref. No. —
	pilot tube copper pipe ø 4mm thickness 1mm L 3000mm		
	Part No.	102111	Ref. No. —
	pilot tube copper pipe ø 6mm thickness 1mm L 3000mm		
	Part No.	107171	Ref. No. 1842300
	pilot burner nozzle SIT natural/liquid gas bore ø 0.25mm Qty 1 pcs		
	Part No.	107700	Ref. No. —
	pilot burner bottom part SIT 100 series nozzle ø 0.25mm		
	Part No.	107702	Ref. No. —
	pilot burner bottom part SIT 100 series nozzle ø 0.35mm		

accessories for		106907	
	Part No.	102110	Ref. No. —
	pilot tube copper pipe ø 4mm thickness 1mm L 3000mm		
	Part No.	102111	Ref. No. —
	pilot tube copper pipe ø 6mm thickness 1mm L 3000mm		
	Part No.	107171	Ref. No. 1842300
	pilot burner nozzle SIT natural/liquid gas bore ø 0.25mm Qty 1 pcs		
	Part No.	107700	Ref. No. —
	pilot burner bottom part SIT 100 series nozzle ø 0.25mm		
	Part No.	107701	Ref. No. —
	pilot burner bottom part SIT 100 series nozzle ø 0.2mm		

			
1			
Part No.	106907	Ref. No.	588730
description	pilot burner SIT type 100 series 3 flames nozzle ø 0.35mm gas connection 6mm		
spare parts for	106907		
	Part No.	100246	Ref. No. —
	pilot burner nozzle natural gas bore ø 0.35mm Qty 1 pcs thread M8x0.75		
	Part No.	100855	Ref. No. —
	pilot burner bracket triple		
	Part No.	100885	Ref. No. —
	air mixing sleeve for pilot burner Qty 1 pcs		
	Part No.	100916	Ref. No. —
	compression spring for pilot burner Qty 1 pcs		
	Part No.	100917	Ref. No. —
	gasket for pilot burner Qty 1 pcs aluminium		
	Part No.	100918	Ref. No. —
	screw for pilot burner		
	Part No.	107162	Ref. No. —
	pilot burner cap SIT 3 flames Hmm Lmm Qty 1 pcs		
	Part No.	107702	Ref. No. —
	pilot burner bottom part SIT 100 series nozzle ø 0.35mm		
accessories for	106907		
	Part No.	100245	Ref. No. 1415100
	pilot burner nozzle LPG code 20 bore ø 0.2mm Qty 1 pcs thread M8x0.75		
	Part No.	100904	Ref. No. 1394700
	locking screw M10x1 for pipe ø 4mm Qty 1 pcs		
	Part No.	100905	Ref. No. —
	locking screw M10x1 for pipe ø 6mm Qty 1 pcs		





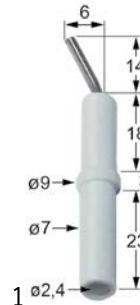











accessories			
pilot burner nozzles			
			
1			
Part No.	100245	Ref. No.	1415100
description	pilot burner nozzle LPG code 20 bore ø 0.2mm Qty 1 pcs thread M8x0.75		

ignition electrodes			
			
1			
Part No.	100706	Ref. No.	1888300
description	ignition electrode connection M4 Qty 1 pcs		

			
1			
Part No.	100707	Ref. No.	50102720 63050010 LAR50102720 LAR63050010
description	ignition electrode D1 ø 7mm D2 ø 9mm connection ø2.4mm L1 14mm L2 6mm BL1 18mm BL2 3mm BL3 23mm to clip Qty 1 pcs		
For models:	FG05, FG105M, FG105X, FG110M, FG110X, FG210M, FG210X, MG05, MG10, MG15, MG21, MG24, MG40, PG04, PG040M, PG040X, PG08, PG080M, PG080X, PG12, RG05, RG07, RG10, RG20, RG24, RG40		



140 - 145 -150 series

			
1			
Part No.	107114 ¹	Ref. No.	29000
description	pilot burner SIT type 140 series 2 flames nozzle 8mm gas connectionmm		
spare parts for	107114		
	Part No.	100907	Ref. No. 1891700
	screw connection thread M10x1 Qty 1 pcs type SEF 1 8mm for thermocouple		
accessories for	107114		
	Part No.	100204	Ref. No. 1888000
	pilot burner nozzle SIT LPG code 14 bore ø 0.18/0.20mm Qty 1 pcs suitable for 140 series		
	Part No.	100205	Ref. No. —
	pilot burner nozzle SIT LPG code 19 bore ø 0.23/0.26mm Qty 1 pcs suitable for SIT 150 series		
	Part No.	100206	Ref. No. —
	pilot burner nozzle SIT natural gas code 36 bore ø 0.60/0.55mm Qty 1 pcs suitable for SIT 150 series		
	Part No.	100207	Ref. No. —
	pilot burner nozzle SIT natural gas code 27 bore ø 0.40/0.38mm suitable for SIT 140 series		
	Part No.	100216	Ref. No. —
	pilot burner nozzle SIT natural gas code 38 bore ø 0.45mm Qty 1 pcs suitable for SIT 150 series		
	Part No.	100701	Ref. No. 1949900
	ignition electrode connection M4 Qty 1 pcs		
	Part No.	100801	Ref. No. —
	gasket for pilot burner Qty 1 pcs		
	Part No.	100897	Ref. No. 1887800
	olive for pipe ø 4mm Qty 1 pcs for pilot burner		
	Part No.	100898	Ref. No. —
	olive for pipe ø 6mm Qty 1 pcs for pilot burner		
	Part No.	100906	Ref. No. 1888100
	screw connection thread M10x1 for ignition electrode brass Qty 1 pcs WS 10		
	Part No.	100908	Ref. No. 1888400
	union screw thread M10x1 for pipe ø 4mm Qty 1 pcs		
	Part No.	100909	Ref. No. 62060223 LA62060223 LAR62060223 R62060223
	union screw thread M10x1 for pipe ø 6mm Qty 1 pcs		
	Part No.	102110	Ref. No. —
	pilot tube copper pipe ø 4mm thickness 1mm L 3000mm		
	Part No.	102111	Ref. No. —
	pilot tube copper pipe ø 6mm thickness 1mm L 3000mm		

¹incl. thermocouple fitting

electrodes

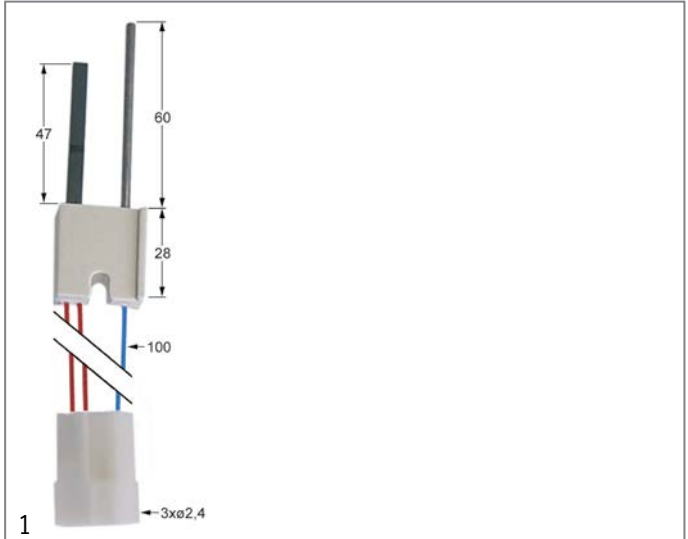

1			
Part No.	100730	Ref. No.	63050040 LAR63050040
description	glow plug cable length 100mm connection ø2.4mm L1 47mm L2 60mm		
For models:	CGC24M, CGC40M, CVG105H, CVG105M, MG106D, MG106H, MG106M, MG106P, MG106X, MG110D, MG110H, MG110M, MG110X, MG120D, MG120H, MG120M, MG120P, MG120X, MG210D, MG210H, MG210M, MG210P, MG210X, MG220D, MG220H, MG220M, MG220P, MG220X, MGC20H, MGC20X, MGC24H, MGC40H, MGC40P, VG105D, VG105H, VG105M, VG105X, VG106D, VG106H, VG106M, VG106P, VG106X, VG110D, VG110H, VG110M, VG110P, VG110X, VG120D, VG120H, VG120M...(Other models you can see in the webshop)		



1			
Part No.	102476	Ref. No.	2617322
description	glow plug conversion kit flange length 41mm flange width 20mm ø 11mm mounting distance 29mm cable length 60mm connection male faston 2.8mm total length 101mm L1 73mm L2 28mm 24V		



1			
Part No.	102477	Ref. No.	2617321
description	glow plug conversion kit flange length 41mm flange width 20mm ø 11mm mounting distance 29mm cable length 60mm connection male faston 2.8mm total length 64mm L1 54mm L2 10mm 24V		



Part No.	100701	Ref. No.	1949900
description	ignition electrode connection M4 Qty 1 pcs		
accessories for	100701		
	Part No.	100906	Ref. No. 1888100
	screw connection thread M10x1 for ignition electrode brass Qty 1 pcs WS 10		

Part No.	100706	Ref. No.	1888300
description	ignition electrode connection M4 Qty 1 pcs		

Part No.	100707	Ref. No.	50102720 63050010 LAR50102720 LAR63050010
description	ignition electrode D1 ø 7mm D2 ø 9mm connection ø2.4mm L1 14mm L2 6mm BL1 18mm BL2 3mm BL3 23mm to clip Qty 1 pcs		
For models:	FG05, FG105M, FG105X, FG110M, FG110X, FG210M, FG210X, MG05, MG10, MG15, MG21, MG24, MG40, PG04, PG040M, PG040X, PG08, PG080M, PG080X, PG12, RG05, RG07, RG10, RG20, RG24, RG40		

Part No.	104687	Ref. No.	63050080 63050090 LAR63050080 LAR63050090
description	ignition electrode flange length 17mm flange width 24mm D1 ø 9.5mm D2 ø 9.5mm L1 49mm BL1 64mm BL2 52mm connection male faston 2.8mm fixing dimensions 4.5mm flange		
For models:	MG102H, MG102M, MG102P, MG102T, MG201M, MG201P, MG202H, MG202M, MG202P, MG202T		

Part No.	400172	Ref. No.	63050060 LA63050060 LAR63050060
description	ignition electrode flange length 23mm flange width 1 15mm D1 ø 7mm L1 111mm BL1 23mm BL2 33mm connection F2.8x0.8 with flange		
For models:	FG051M, FG051X, FG101M, FG101X, PG041M, PG041X, PG051X, PG081M, PG081X, PG101M, PG101X		





			
1			
Part No.	104695	Ref. No.	63050310 LAR63050310
description	ignition electrode flange length 23mm flange width 15mm D1 ø 7mm D2 ø 7mm L1 13mm L2 19mm L3 13mm BL1 31mm BL2 24mm connection M4 fixing dimensions 4x5mm flange		
For models:	GC106M, GM106H, GM106M, GM106M+SC, GM106P, GV106H, GV106M, GV106M+SC, GV106P, VG106X		

			
1			
Part No.	104451	Ref. No.	63050350 LAR63050350
description	ignition electrode flange length 23mm flange width 15mm D1 ø 7mm L1 25mm L2 14mm L4 15mm BL1 22mm BL2 34mm		
For models:	GC110M, GC210M, GM110H, GM110M, GM110M+SC, GM110P, GM210H, GM210M, GM210M+SC, GM210P, GV110H, GV110M, GV-110M+SC, GV110P, GV210H, GV210M, GV210M+SC, GV210P		

			
1			
Part No.	104686	Ref. No.	63050340 LAR63050340
description	ignition electrode flange length 23mm flange width 15mm D1 ø 7mm D2 ø 7mm L1 20mm L2 15mm BL1 22mm BL2 4mm BL3 28mm connection male faston 2.8mm		
For models:	GC110M, GC210M, GM110H, GM110M, GM110M+SC, GM110P, GM210H, GM210M, GM210M+SC, GM210P, GV110H, GV110M, GV-110M+SC, GV110P, GV210H, GV210M, GV210M+SC, GV210P		

			
1			
Part No.	106756	Ref. No.	63050130 LAR63050130
description	ignition electrode flange length 24mm flange width 17mm D1 ø 9.3mm L1 45mm BL1 57mm BL2 37mm connection ø6 fixing dimensions ø4.5mm A1/B13/C2		
For models:	BPG044M, BPG044P, BPG054M, BPG054P, BPG064M, BPG064P, BPG074M, BPG074P, BPG084M, BPG084P, BPG104M, BPG104P, EPG056T, EPG086T, EPG156T, EPGV05T, EPGV08T, EPGV15T, GGMT06P, GGMT06T, GGMT10P, GGMT10T, GGMT20P, GGMT20T, GGMT21P, GGMT21T, GGMT40P, GGMT40T, GGVT06P, GGVT06T, GGVT10P, GGVT10T, GGVT20P, GGVT20T, GGVT21P, GGVT21T, GGVT40P, GGVT40T, HMG061P, HMG061T, HMG061X, HMG101P, HMG101T, HMG101X, HMG102P, HMG102T, HMG102X, HMG201P, HMG201T, HMG201X... (Other models you can see in the webshop)		

			
1			
Part No.	104685	Ref. No.	63050300 LAR63050300
description	ignition electrode flange length 23mm flange width 15mm D1 ø 7mm L1 15mm L2 12mm BL1 22mm BL2 31mm connection male faston 2.8mm fixing dimensions ø4mm with flange		
For models:	GC106M, GM106H, GM106M, GM106M+SC, GM106P, GV106H, GV106M, GV106M+SC, GV106P, VG106X		

1

Part No.	102364	Ref. No.	65265030 LAR65265030
description	ignition electrode flange length 48mm flange width 20mm L1 11mm L2 21mm L3 18mm BL1 17mm BL2 29mm fixing dimensions $\phi 5.5 \times 4.5 \text{mm} / \phi 4.5 \text{mm}$ with flange connection $\phi 6 \text{mm}$		
For models:	MG105L, MG105S		



1

Part No.	104549	Ref. No.	56260560 LAR56260560
description	ignition electrode flange length 48mm flange width 22mm D1 $\phi 10 \text{mm}$ D2 $\phi 10 \text{mm}$ L1 100mm BL1 18mm BL2 30mm flange connection $\phi 6 \text{mm}$		



1

Part No.	106525	Ref. No.	63050070 LAR63050070
description	ignition electrode set Qty 2 flange length 23mm flange width 15/17mm D1 $\phi 7/9.5 \text{mm}$ L1 80/45mm BL1 33/48mm BL2 57/47mm connection F2.8x0.8 fixing dimensions $\phi 4.5 \text{mm}$		
For models:	CG051M, CG071M, MACG05M, MACG07M, MG061D, MG061H, MG061M, MG061P, MG061T, MG101H, MG101M, MG101P, MG101T, MG201H, MG201M, MG201P, MG201T, VG051P, VG061D, VG061M, VG061P		

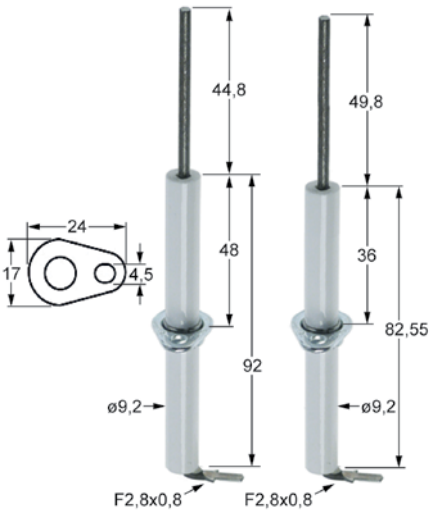

1

Part No.	106647	Ref. No.	63050100 LAR63050100
description	ignition electrode set flange length 24mm flange width 17mm D1 $\phi 9.5 \text{mm}$ L1 45mm BL1 48mm BL2 48mm connection male faston 2.8mm with screw connection 1x ignition 1x flame monitoring		
For models:	ACG10M, CG100M, CG200M, GGMT06P, GGMT06T, GGVT06P, GGVT06T, GMT06D, GMT20D, GMT20P, GVT06D, GVT20D, MACG10M, MACG20M, MG101D, MG101M, MG101P, MG101T, MG102D, MG102M, MG102P, MG102T, MG201D, MG201M, MG201P, MG201T, MG202D, MG202M, MG202P, MG202T, MGMT06D, MGMT06P, MGMT10D, MGMT10P, MGMT20D, MGMT20P, MGMT21D, MGMT21P, MGMT40D, MGMT40P, MGVT06D, MGVT06P, MGVT10D, MGVT10P, MGVT20D, MGVT20P, MGVT21D, MGVT21P, MGVT40D, MGVT40P...(Other models you can see in the webshop)		



1

Part No.	100906	Ref. No.	1888100
description	screw connection thread M10x1 for ignition electrode brass Qty 1 pcs WS 10		

ignition cables

pre-assembled cables

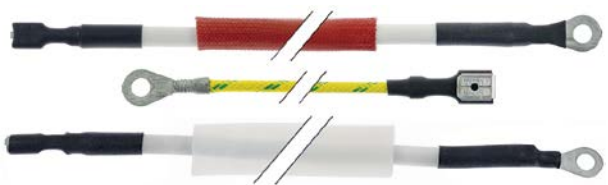

1

Part No.	107856	Ref. No.	LAR66605810
description	ignition cable 3-piece L 1080mm		
For models:	GGMT40P, GGMT40T, GGVT40P, GGVT40T, HMG202P, HMG202T, HMG202X, HVG202P, HVG202T, HVG202X, MCG202M		

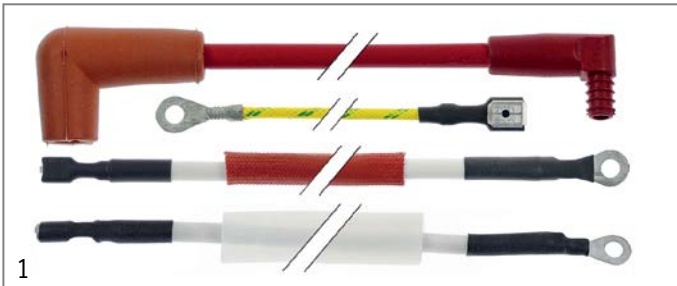
Part No.	107857	Ref. No.	66605820 LAR66605820
description	ignition cable 4-piece L 520mm		
For models:	BPG044M, BPG044P, BPG054M, BPG054P, BPG064M, BPG064P, BPG074M, BPG074P, BPG084M, BPG084P, BPG104M, BPG104P, GGMT06P, GGMT06T, GGMT10P, GGMT10T, GGMT21P, GGMT21T, GGV21P, GGV21T, HMG061P, HMG061T, HMG061X, HMG101P, HMG101T, HMG101X, HMG201P, HMG201T, HMG201X, HVG101P, HVG101T, HVG101X, HVG201P, HVG201T, HVG201X, MCG051M, MCG071M, MCG101M, MCG102M, MCG201M, MMG071P, MMG101P, MMG102P, MVG051P, MVG071P, MVG101P, MVG102P		



Part No.	100179	Ref. No.	50707360 66600400 LAR50707360 LAR66600400
description	ignition cable cable length 1200mm connection F2.8mm / ø2.4mm		
For models:	FG105M, FG105X, MG05, MG10, MG15, MG21, MG24, MG40, PG040M, PG040X, PG08, PG12, RG07, RG10, RG20, RG24, RG40		



Part No.	102163	Ref. No.	50707370 66600410 LAR50707370 LAR66600410
description	ignition cable cable length 1500mm connection F2.8mm / ø2.4mm		
For models:	FG05, FG110M, FG110X, FG210M, FG210X, MG05, PG04, PG080M, PG080X, RG05		

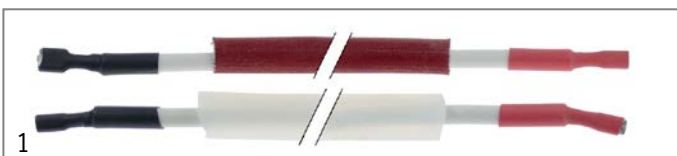

Part No.	107851	Ref. No.	66110370 LAR66110370
description	ignition cable cable length 300mm set 2-piece		
For models:	ACG10M, CG051M, CG071M, CG100M, CG200M, HVG061P, HVG061T, HVG061X, MACG05M, MACG07M, MACG10M, MACG20M, MG061D, MG061M, MG061P, MG061T, MG101D, MG101M, MG101P, MG101T, MG201D, MG201M, MG201P, MG201T, PG084, PG104M, VG051P, VG061D, VG061M, VG061P, VG101D, VG101M, VG101P, VG201D, VG201M, VG201P		



Part No.	100025	Ref. No.	100025 1950324
description	ignition cable cable length 600mm connection ø4mm / F6.3mm		

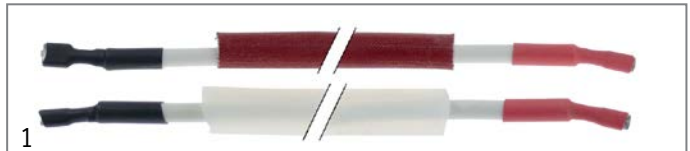

Part No.	107853	Ref. No.	66605900 LAR66605900
description	ignition cable for combi-steamer set 2-piece L 800mm		
For models:	GC106M, GC110M, GC210M, GM106H, GM106M, GM106M+SC, GM106P, GM110H, GM110M, GM110M+SC, GM110P, GM210H, GM210M, GM210M+SC, GM210P, GV106H, GV106M, GV106M+SC, GV106P, GV110H, GV110M, GV110M+SC, GV110P, GV210H, GV210M, GV210M+SC, GV210P		



Part No.	107852	Ref. No.	66605140 LA66605140 LAR66605140
description	ignition cable ID ø 6.3-3.2mm thickness 7mm silicone t.max. 155°C flashover voltage 30000V red L 400mm combi-steamer LAINOX		



Part No.	107786	Ref. No.	66605120 66605150 LA66605120 LAR66605120 LAR66605150
description	ignition cable ID ø 7/4mm thicknessmm Qty 1m silicone permanent temperature°C t.max. 155°C flashover voltage 30000V red L 800mm		

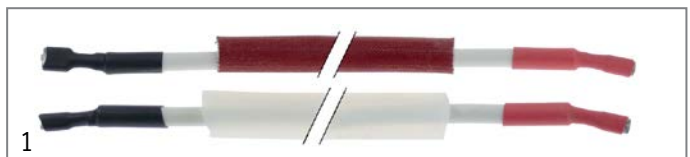

Part No.	107855	Ref. No.	66110380 66605840 LAR66110380 LAR66605840
description	ignition cable set 2-piece L 700mm		
For models:	FG101M, FG101X, MG102M, MG102P, MG102T, PG081M, PG081X, PG101M, PG101X		

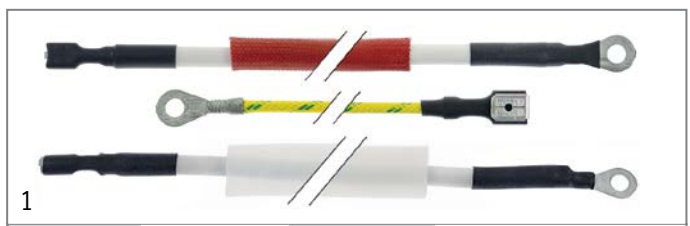



Part No.	107854	Ref. No.	66605800 LAR66605800 r66605800
description	ignition cable set 3-piece L 700mm		
For models:	GGMT06P, GGMT06T, GGMT10P, GGMT10T, GGMT20P, GGMT20T, GGMT21P, GGMT21T, GGV206P, GGV206T, GGV210P, GGV210T, GGV220P, GGV220T, HMG061P, HMG061T, HMG061X, HMG101P, HMG101T, HMG101X, HMG102P, HMG102T, HMG102X, HMG201P, HMG201T, HMG201X, HVG102P, HVG102T, HVG102X, MMG071P, MMG101P, MMG102P		

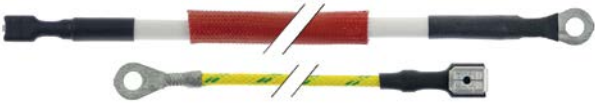

			
1			
Part No.	107787	Ref. No.	66605801 66605921 LAR66605801 LAR66605921
description	ignition cable set L 700mm		

ignition units

			
1			
Part No.	104688	Ref. No.	65180270 LAG65180270 LAR65180270
description	ignition unit outputs 1 220-240VAC dimensions 84x62x38mm mounting distance 59mm inlet F6.3x0.8 outlet ø4mm type TRK2-30PVD 69VA 50/60Hz 0.3A protection IP00		
For models:	BPG044M, BPG044P, BPG054M, BPG054P, BPG064M, BPG064P, BPG074M, BPG074P, BPG084M, BPG084P, BPG104M, BPG104P, EPG056T, EPG086T, EPG156T, EPGV05T, EPGV08T, EPGV15T, GGMT06P, GGMT06T, GGMT10P, GGMT10T, GGMT20P, GGMT20T, GGMT21P, GGMT21T, GGMT40P, GGMT40T, GGVT06P, GGVT06T, GGVT10P, GGVT10T, GGVT20P, GGVT20T, GGVT21P, GGVT21T, GGVT40P, GGVT40T, HMG061P, HMG061T, HMG061X, HMG101P, HMG101T, HMG101X, HMG102P, HMG102T, HMG102X, HMG201P, HMG201T, HMG201X... (Other models you can see in the webshop)		

			
1			
Part No.	102485	Ref. No.	50102700 50102710 65180280 65180290 BN6A050100 LAR50102700 LAR50102710 LAR65180280 LAR65180290 MA2971400
description	ignition unit outputs 2 220-240VAC 0.6VA 50-60Hz		
For models:	FG05, FG105M, FG105X, FG110M, FG110X, FG210M, FG210X, MG05, MG10, MG15, MG21, MG24, MG40, PG04, PG040M, PG040X, PG08, PG080M, PG080X, PG12, RG05, RG07, RG10, RG20, RG24, RG40		

			
1			
Part No.	101002	Ref. No.	0101193 2971400 65180310 LAR65180310 SIR0101193
description	ignition unit outputs 2 230VAC dimensions 88x23x34mm mounting distance 73mm inlet F6.3x0.8 outlet F2.8x0.8 0.6VA 50/60Hz		

thermocouples

plug-in thermocouples

plug-in thermocouples standard

with barrel socket ø6(6.5)mm

thermocouples SIT

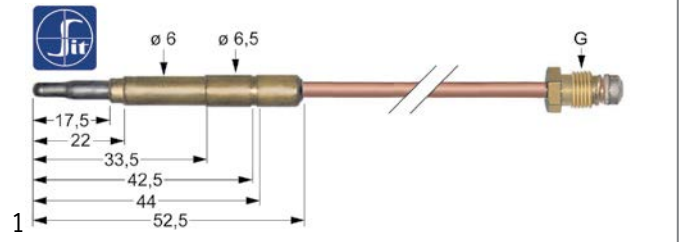

Part No.	107601	Ref. No.	1206400
description	thermocouple SIT M8x1 L 600mm plug connection ø6.0(6.5)mm		

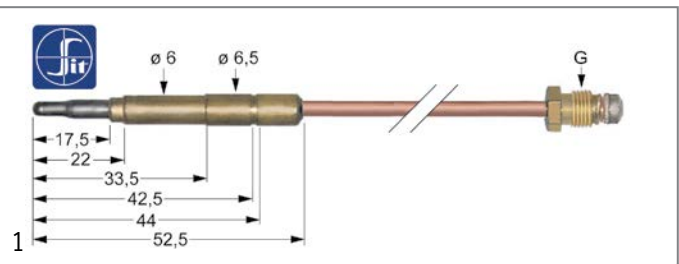

Part No.	107613	Ref. No.	263800
description	thermocouple SIT M9x1 L 1200mm plug connection ø6.0(6.5)mm		

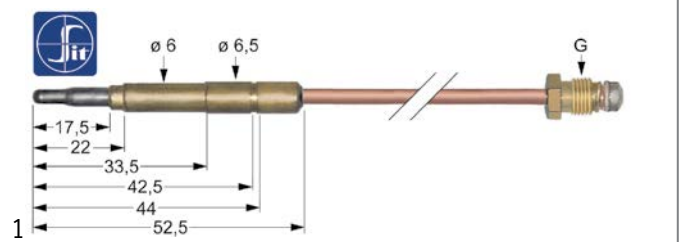

Part No.	107614	Ref. No.	0100818 50203240 63040030 LAR50203240 LAR63040030 SI0100818 SIR0100818
description	thermocouple SIT M9x1 L 1500mm plug connection ø6.0(6.5)mm		
For models:	FG110M, FG110X, FG210M, FG210X, MG05, MG10, MG15, MG21, MG24, MG40, PG08, PG080M, PG080X, PG12, RG07, RG10, RG20, RG24, RG40		

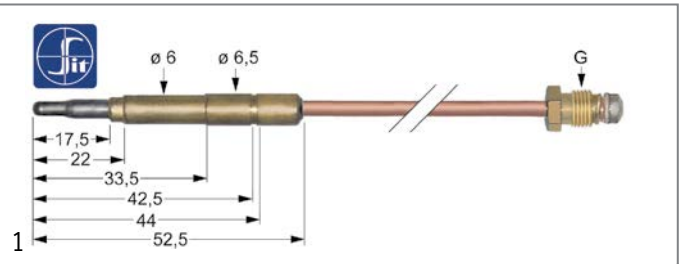

Part No.	107606	Ref. No.	1031500400
description	thermocouple SIT M9x1 L 320mm plug connection ø6.0(6.5)mm		



Part No.	107608	Ref. No.	1031504300
description	thermocouple SIT M9x1 L 500mm plug connection $\varnothing 6.0(6.5)$ mm		

Part No.	107611	Ref. No.	50203230 63040020 LAR50203230 LAR63040020
description	thermocouple SIT M9x1 L 850mm plug connection $\varnothing 6.0(6.5)$ mm		
For models:	FG05, FG105M, FG105X, MG05, MG24, MG40, PG04, PG040M, PG040X, RG05		

thermocouples with aluminised tip

Part No.	102034	Ref. No.	1033027800
description	thermocouple M8x1 L 600mm plug connection $\varnothing 6.0(6.5)$ mm		

thermopiles

Part No.	102116	Ref. No.	1870712
description	thermopile ROBERTSHAW L 900mm probe $\varnothing 9$ mm probe L 57mm 250-750mV screw connection 7/16"		

accessories

displays

Part No.	101414	Ref. No.	50202830 65350010 LAR50202830 LAR65350010
description	display soldering connection		
For models:	MG15, MG21, MG24, MG40, PG12, RG20, RG24, RG40		

interrupters

Part No.	101265	Ref. No.	0100835 50203130 63040210 LAR50203130 LAR63040210 SIR0100835
description	interrupter thread M9x1		
For models:	FG105M, FG105X, FG110M, FG110X, FG210M, FG210X, MG15, MG21, MG24, MG40, PG040M, PG040X, PG080M, PG080X, PG12, RG20, RG24, RG40		

gas burners

bar burners

bar burners

Part No.	106885	Ref. No.	63010080 LA63010080 LAR63010080
description	bar burner		





 <p>1</p>			
Part No.	108098	Ref. No.	63010070 63016520 LA63010070 LAR63010070 LAR63016520
description	bar burner 1-row L 440mm ø 50mm flange width 57mm flange length 57mm MG110, VG110		
For models:	GC110M, GM110H, GM110M, GM110M+SC, GM110P, GV110H, GV110M, GV110M+SC, GV110P		

 <p>1</p>			
Part No.	105543	Ref. No.	63010010 LA63010010 LAR63010010
description	bar burner 1-row ø 40mm Wmm Hmm L 420mm flange width 43mm flange length 43mm bain marie		

 <p>1</p>			
Part No.	104216	Ref. No.	63010120 LAR63010120
description	bar burner 1-row ø 50mm Wmm Hmm L 485mm		

 <p>1</p>			
Part No.	105831	Ref. No.	63016050 LAR63016050
description	bar burner 2 row L 425mm Wmm ø 40mm Hmm flange width 43mm flange length 43mm combi-steamer MG106, VG106		
For models:	MG106D, MG106H, MG106M, MG106P, MG106X, VG106D, VG106H, VG106M, VG106P, VG106X		

 <p>1</p>			
Part No.	105827	Ref. No.	63016060 LAR63016060
description	bar burner 2 row L 485mm W 160mm ø 40mm H 90mm combi-steamer MG106		
For models:	MG106D, MG106H, MG106M, MG106P, MG106X		

 <p>1</p>			
Part No.	105855	Ref. No.	63015010 LAR63015010
description	bar burner 2 row L 485mm W 160mm ø 90mm H 40mm combi-steamer MG106		
For models:	MG106L, MG106S, MG106T		

 <p>1</p>			
Part No.	105841	Ref. No.	50204230 63015240 LAR50204230 LAR63015240
description	bar burner 2 row L 485mm Wmm ø 50mm Hmm hot air RG10, MG10		
For models:	MG10, RG10		

 <p>1</p>			
Part No.	105848	Ref. No.	63014980 LAR63014980
description	bar burner 2 row L 490mm W 145mm ø 39mm H 90mm combi-steamer MG105, VG105		
For models:	MG105L, MG105S, VG105S		





			
1			
Part No.	105849	Ref. No.	63015000 LAR63015000
description	bar burner 2 row L 490mm W 160mm ø 40mm H 90mm combi-steamer MG106, VG106		
For models:	MG106L, MG106S, MG106T, VG106L, VG106S, VG106T		

			
1			
Part No.	105836	Ref. No.	50204220 63015470 LAR50204220 LAR63015470
description	bar burner 2 row L 500mm W 164mm ø 50mm H 85mm combi-steamer MG05-21		
For models:	MG05, MG10, MG15, MG21		
spare parts for	105836		
	Part No.	104633	Ref. No.
			63010110 LA63010110 LAR63010110 R63010110
	bar burner ø 50mm Wmm Hmm L 434mm flange width 57mm flange length 57mm		

			
1			
Part No.	105856	Ref. No.	63015030 LAR63015030
description	bar burner 2 row L 500mm W 240mm ø 50mm H 110mm combi-steamer MG110		
For models:	MG110L, MG110S, MG110T		

			
1			
Part No.	105850	Ref. No.	63015020 LAR63015020
description	bar burner 2 row L 500mm W 240mm ø 50mm H 110mm combi-steamer MG110, VG110		
For models:	MG110L, MG110S, MG110T, VG110L, VG110S, VG110T		

			
1			
Part No.	105845	Ref. No.	50204260 63015280 63015300 LAR50204260 LAR63015280 LAR63015300
description	bar burner 2 row L 550mm W 165mm ø 50mm H 85mm combi-steamer MG21		
For models:	FG101M, FG101X, FG110M, FG110X, MG21, PG080M, PG080X, PG081M, PG081X, PG101M, PG101X		

			
1			
Part No.	105842	Ref. No.	50204240 LAR50204240
description	bar burner 2 row L 550mm W 165mm ø 50mm H 85mm combi-steamer RG20/24, MG15, PG08		
For models:	MG15, PG08, RG20, RG24		

			
1			
Part No.	105834	Ref. No.	63016090 LAR63016090
description	bar burner 2 row L 575mm W 240mm ø 50mm H 110mm combi-steamer MG210, VG210		
For models:	MG210D, MG210H, MG210M, MG210P, MG210X, MG227M, MG227P, MG227X, VG210D, VG210H, VG210M, VG210P, VG210X		

			
1			
Part No.	105853	Ref. No.	63015070 LAR63015070
description	bar burner 2 row L 720mm W 240mm ø 50mm H 110mm combi-steamer MG220, VG220		
For models:	MG220L, MG220S, MG220T		



1			
Part No.	105854	Ref. No.	63014990 LAR63014990
description	bar burner combi-steamer MG105		
For models:	MG105L, MG105S		

1			
Part No.	105844	Ref. No.	50204250 63015290 LAR50204250 LAR63015290
description	bar burner combi-steamer MG20/24		
For models:	MG24		

2			
Part No.	105828	Ref. No.	63016080 LAR63016080
description	bar burner combi-steamer MG110		
For models:	MG110D, MG110H, MG110M, MG110P, MG110X, MG227M, MG227P, MG227X		

1			
Part No.	105852	Ref. No.	63015040 LAR63015040
description	bar burner combi-steamer MG210, VG210		
For models:	MG210T, VG210L, VG210S, VG210T		

1			
Part No.	105851	Ref. No.	63015060 LAR63015060
description	bar burner combi-steamer MG120, VG120		
For models:	MG120L, MG120S, MG120T, PG015M, PG115M		

1			
Part No.	105830	Ref. No.	63016130 LAR63016130
description	bar burner combi-steamer MG220		
For models:	MG220D, MG220H, MG220M, MG220P, MG220X, MGC40H, MGC40P		

1			
Part No.	105829	Ref. No.	63016100 LAR63016100
description	bar burner combi-steamer MG120/210		
For models:	MG120D, MG120H, MG120M, MG120P, MG120X, MG210D, MG210H, MG210M, MG210P, MG210X, MGC20H, MGC20X, MGC24H		

1			
Part No.	105858	Ref. No.	63015080 LAR63015080
description	bar burner combi-steamer MG220		
For models:	MG220L, MG220S, MG220T		

1			
Part No.	105857	Ref. No.	63015050 LAR63015050
description	bar burner combi-steamer MG120/210		
For models:	MG120L, MG120S, MG120T, MG210T		



1

Part No.	105837	Ref. No.	50204270 63015480 LAR50204270 LAR63015480
description	bar burner combi-steamer MG24		
For models:	MG24, MG40		



1

Part No.	105838	Ref. No.	50204200 63015210 LAR50204200 LAR63015210
description	bar burner convection oven FG05		
For models:	FG05		

2

Part No.	105846	Ref. No.	50204300 63015270 LAR50204300 LAR63015270
description	bar burner combi-steamer PG04		
For models:	FG051M, FG051X, FG105M, FG105X, PG04, PG040M, PG040X, PG041M, PG041X, PG051X		

1

Part No.	105832	Ref. No.	63016070 LAR63016070
description	bar burner convection oven MG110, VG190		
For models:	MG110D, MG110H, MG110M, MG110P, MG110X, VG110D, VG110H, VG110M, VG110P, VG110X		

1

Part No.	105839	Ref. No.	50204210 LAR50204210
description	bar burner combi-steamer RG05, MG05		
For models:	MG05, RG05		

1

Part No.	105833	Ref. No.	63016110 LAR63016110
description	bar burner convection oven MG120, VG120		
For models:	MG120D, MG120H, MG120M, MG120P, MG120X, MGC20H, MGC20X, VG120D, VG120H, VG120M, VG120P, VG120X, VGC20H		

1

Part No.	105840	Ref. No.	50204290 LAR50204290
description	bar burner combi-steamer RG07		
For models:	RG07		

1

Part No.	105835	Ref. No.	63016120 LAR63016120
description	bar burner convection oven MG220, VG220		
For models:	CGC24M, CGC40M, MG220D, MG220H, MG220M, MG220P, MG220X, MGC24H, MGC40H, MGC40P, VG220D, VG220H, VG220M, VG220P, VG220X, VGC24H, VGS40M		



1			
Part No.	105847	Ref. No.	50204310 63015260 LAR50204310 LAR63015260
description	bar burner convection oven PG12		
For models:	FG210M, FG210X, PG12		

2			
Part No.	105000	Ref. No.	63016250 LAR63016250
description	bar burner L 435mm ø 52mm connection 1/2" combi-steamer MG110		

1			
Part No.	106944	Ref. No.	63010060 LAR63010060
description	bar burner ø 40mm Wmm Hmm L 425mm flange width 43mm flange length 43mm		

1			
Part No.	107774	Ref. No.	63010090 LA63010090 LAR63010090
description	bar burner ø 50mm L 495mm flange width 58mm flange length 58mm		

1			
Part No.	105547	Ref. No.	100268
description	bar burner ø 50mm Wmm Hmm L 432mm flange width 71mm fryer flange ø 75mm		

1			
Part No.	104633	Ref. No.	63010110 LA63010110 LAR63010110
description	bar burner ø 50mm Wmm Hmm L 434mm flange width 57mm flange length 57mm		

forced air burners

1			
Part No.	104309	Ref. No.	63140020 LAR63140020
description	gasket L 106mm W 100mm H 3mm 4 holes		
For models:	ACG10M, CG100M, CG200M, GMT20D, GMT20P, GVT20D, MACG10M, MACG20M, MG101D, MG101H, MG101M, MG101P, MG101T, MG102D, MG102H, MG102M, MG102P, MG102T, MG201D, MG201H, MG201M, MG201P, MG201T, MG202D, MG202H, MG202M, MG202P, MG202T, MGMT10D, MGMT10P, MGMT20D, MGMT20P, MGMT21D, MGMT21P, MGMT40D, MGMT40P, MGVT10D, MGVT10P, MGVT20D, MGVT20P, MGVT21D, MGVT21P, MGVT40D, MGVT40P, PG084, PG104M, VG101D, VG101M, VG101P, VG102D...(Other models you can see in the web-shop)		

1			
Part No.	104314	Ref. No.	63140060 LA63140060 LAR63140060
description	gasket L 108mm W 103mm H 3mm 6 holes		
For models:	ACG10M, CG100M, CG200M, GGMT10P, GGMT10T, GGMT20P, GGMT20T, GGMT21P, GGMT21T, GGMT40P, GGMT40T, GMT20D, GMT20P, GVT20D, HMG101P, HMG101T, HMG101X, HMG102P, HMG102T, HMG102X, HMG201P, HMG201T, HMG201X, HMG202P, HMG202T, HMG202X, MACG10M, MACG20M, MG101P, MG101T, MG102P, MG102T, MMG101P, MMG102P, PG084, PG104M, VG101D, VG101P, VG102D, VG102P		





			
1			
Part No.	107650	Ref. No.	100802
description	pilot burner nozzle SIT LPG code 30 Qty 1 pcs		

			
1			
Part No.	107174	Ref. No.	1033719700
description	pilot burner nozzle SIT natural gas code 41 Qty 1 pcs		



auxiliary gas parts

screw connections

olives

			
1			
Part No.	101248	Ref. No.	417810
description	olive for pipe ø 12mm Qty 1 pcs suitable for PEL		
accessories for	101248		
	Part No.	101251	Ref. No. —
	union nut thread M20x1.5 for pipe ø 12mm		

			
1			
Part No.	100897	Ref. No.	1887800
description	olive for pipe ø 4mm Qty 1 pcs for pilot burner		





			
1			
Part No.	101286	Ref. No.	62070023 LA62070023 LAR62070023
description	olive ID ø 6mm Qty 1 pcs		
accessories for	101286		
	Part No.	100909	Ref. No. 62060223 LA62060223 LAR62060223 R62060223
	union screw thread M10x1 for pipe ø 6mm Qty 1 pcs		
	Part No.	101464	Ref. No. —
	union nut thread M12x1 for pipe ø 6mm		

union screws

			
1			
Part No.	100904	Ref. No.	1394700
description	locking screw M10x1 for pipe ø 4mm Qty 1 pcs		

			
1			
Part No.	100906	Ref. No.	1888100
description	screw connection thread M10x1 for ignition electrode brass Qty 1 pcs WS 10		

			
1			
Part No.	100907	Ref. No.	1891700
description	screw connection thread M10x1 Qty 1 pcs type SEF 1 ømm for thermocouple		

			
1			
Part No.	100908	Ref. No.	1888400
description	union screw thread M10x1 for pipe ø 4mm Qty 1 pcs		
accessories for	100908		
	Part No.	100897	Ref. No. 1887800
	olive for pipe ø 4mm Qty 1 pcs for pilot burner		
	Part No.	101246	Ref. No. —
	olive for pipe ø 4mm Qty 1 pcs		
	Part No.	101280	Ref. No. —
	olive for pipe ø 4mm Qty 1 pcs		
	Part No.	101282	Ref. No. —
	olive for pipe ø 4mm L 7.4mm Qty 1 pcs		



			
1			
Part No.	698946	Ref. No.	69180220 LAR69180220
description	drip rail L 557mm plastic W 33.5mm		

			
1			
Part No.	692707	Ref. No.	69180150 LAR69180150
description	drip rail L 690mm plastic W 40mm for combi-steamer hole ø 6mm		
For models:	HME061P, HME061T, HME061X, HMG061P, HMG061T, HMG061X, HVE061P, HVE061T, HVE061X, HVG061P, HVG061T, HVG061X		

			
1			
Part No.	698947	Ref. No.	69180230 LAR69180230
description	drip rail L 797mm plastic W 33.5mm		

			
1			
Part No.	694606	Ref. No.	11200520 LAR11200520
description	drip rail L 90mm edition from 2000 until 2009		
For models:	ME061H, ME061M, ME061P, ME061T, ME101H, ME101M, ME101P, ME101T, ME102H, ME102M, ME102P, ME102T, MG061H, MG061M, MG061P, MG061T, MG101H, MG101M, MG101P, MG101T, MG102H, MG102M, MG102P, MG102T		

			
1			
Part No.	692808	Ref. No.	69180160 LAR69180160
description	drip rail with screw connection L 730mm plastic W 32mm for combi-steamer		
For models:	HME061P, HME061T, HME061X, HMG061P, HMG061T, HMG061X, HVE061P, HVE061T, HVE061X, HVG061P, HVG061T, HVG061X		

			
1			
Part No.	692807	Ref. No.	69180170 LAR69180170
description	drip rail with screw connection L 750mm plastic W 70mm for combi-steamer		
For models:	EPE056T, EPE086T, EPEV05T, EPEV08T, EPG056T, EPG086T, EPGV05T, EPGV08T, GEMT20P, GEMT20T, GEVT20P, GEVT20T, GGMT20P, GGMT20T, GGVT20P, GGVT20T, HME101P, HME101T, HME101X, HME102P, HME102T, HME102X, HMG101P, HMG101T, HMG101X, HMG102P, HMG102T, HMG102X, HVE101P, HVE101T, HVE101X, HVE102P, HVE102T, HVE102X, HVG101P, HVG101T, HVG101X, HVG102P, HVG102T, HVG102X		

accessories

			
1			
Part No.	698949	Ref. No.	69040030 LAR69040030
description	cover ED ø 80mm H 8mm		

			
1			
Part No.	698945	Ref. No.	69040040 LA69040040 LAR69040040
description	cover ED ø 90mm H 51mm		





			
1			
Part No.	698944	Ref. No.	69040060 LA69040060 LAR69040060
description	drain filter ED ø 85mm H 41mm		

drain valves			
			
1			
Part No.	694977	Ref. No.	LA62280038
description	drain pipe angled 90° polypropylene DN50 for combi-steamer		

antennas			
			
1			
Part No.	698951	Ref. No.	65302560 LA65302560 LAR65302560
description	stirrer L 105mm ø 10mm		

			
1			
Part No.	699451	Ref. No.	70080010 LAR7008001 LAR70080010
description	bush for steam generator ID ø 60mm ED ø 76mm L 70mm ceramic suitable for combi-steamer		
For models:	GMT20D, GMT20P, MG101D, MG101H, MG101M, MG101P, MG101T, MG102D, MG102H, MG102M, MG102P, MG102T, MG201D, MG201H, MG201M, MG201P, MG201T, MG202D, MG202H, MG202M, MG202P, MG202T, MGMT10D, MGMT10P, MGMT20D, MGMT20P, MGMT21D, MGMT21P, MGMT40D, MGMT40P		

injection nozzles			
			
1			
Part No.	691278	Ref. No.	58006130 58006140 LA58006130 LAR58006130 LAR58006140
description	injection nozzle bore ø 1mm for combi-steamer		
For models:	AVE07D, AVE10D, AVE10P, BPG044M, BPG044P, BPG054M, BPG054P, EMT06D, EPE056T, EPE086T, EPE156T, EPEV05T, EPEV08T, EPEV15T, EPG056T, EPG086T, EPG156T, EPGV05T, EPGV08T, EPGV15T, GEMT06P, GEMT06T, GEMT10P, GEMT10T, GEMT20P, GEMT20T, GEMT21P, GEMT21T, GEMT40P, GEMT40T, GEVT06P, GEVT06T, GEVT10P, GEVT10T, GEVT20P, GEVT20T, GEVT21P, GEVT21T, GEVT40P, GEVT40T, GGMT06P, GGMT06T, GGMT10P, GGMT10T, GGMT20P, GGMT20T, GGMT21P, GGMT21T, GGMT40P, GGMT40T...(Other models you can see in the webshop)		

			
1			
Part No.	698950	Ref. No.	LA69040050 LAR69040050
description	injection nozzle bore ø 2mm D1 ø 27mm D2 ø 5.6mm plastic		

			
1			
Part No.	692326	Ref. No.	58006080 LAR58006080
description	injection nozzle bore ø 2mm L 33mm WS 14 brass for combi-steamer T1: M10x1 T2: M10x1		
For models:	EM210H, EM210M, EM210M+SC, EM210P, EV210H, EV210M, EV210M+SC, EV210P, GM210H, GM210M, GM210M+SC, GM210P, GV210H, GV210M, GV210M+SC, GV210P, ME120D, ME120H, ME120M, ME120P, ME120X, ME210D, ME210H, ME210M, ME210P, ME210X, ME220D, ME220H, ME220M, ME220P, ME220X, MEC20H, MEC20P, MEC20X, MEC24H, MEC40H, MEC40M, MEK21H, MG120D, MG120H, MG120M, MG120P, MG120X, MG210D, MG210H, MG210M, MG210P, MG210X, MG220D, MG220H...(Other models you can see in the webshop)		



injection pipes



1

Part No.	696767	Ref. No.	10206480 LA10206480 LAR10206480
description	extension U-shape for injection pipe ED ø 8/12mm ID ø 6/8mm		
For models:	CGC24M, CGC40M, EC110M, EC210M, EM010M+SC, EM110H, EM110M, EM110M+SC, EM110P, EM210H, EM210M, EM210M+SC, EM210P, EV110H, EV110M, EV110M+SC, EV110P, EV210H, EV210M, EV210M+SC, EV210P, GC110M, GC210M, GM110H, GM110M, GM110M+SC, GM110P, GM210H, GM210M, GM210M+SC, GM210P, GV110H, GV110M, GV110M+SC, GV110P, GV210H, GV210M, GV-210M+SC, GV210P, MEC20H, MEC20P, MEC20X, MEC24H, MEC40H, MEC40M, MEK21H, MGC20H, MGC20X, MGC24H, MGC40H...(Other models you can see in the webshop)		



2

Part No.	692819	Ref. No.	11201980 LA11201980 LAR11201980
description	injection pipe for combi-steamer ED ø 8mm ID ø 5.5mm L 170mm W 115mm		
For models:	EPG086T, GVT20D, HVG101P, HVG101T, HVG101X, MGVT10D, MGVT10P, MGVT20D, MGVT20P, MGVT40D, MGVT40P, VG101D, VG101M, VG101P, VG102D, VG102M, VG102P, VG201D, VG201M, VG201P, VG202D, VG202M, VG202P		



1

Part No.	692821	Ref. No.	18200540 LA18200540 LAR18200540
description	injection pipe for combi-steamer H 75mm ED ø 8mm ID ø 6mm L 105mm		
For models:	BPE044M, BPE044P, BPE054M, BPE054P, BPG044M, BPG044P, BPG054M, BPG054P, CE041M, CE051M, CG051M, MACE04M, MACE05M, MACG05M, MCE042M, MCE051M, MCG051M, MVE042P, MVE051P, MVG051P, VE042P, VE051P, VE055P, VG051P		



1

Part No.	692832	Ref. No.	11201990 LA11201990 LAR11201990
description	injection pipe for combi-steamer U-shape ED ø 8mm ID ø 6mm		
For models:	ACG10M, BPG084M, BPG084P, BPG104M, BPG104P, CG100M, CG200M, EPE056T, EPEV05T, EPG056T, EPG156T, EPGV05T, GEMT21P, GEMT21T, GEMT40P, GEMT40T, GEVT21P, GEVT21T, GEVT40P, GEVT40T, GGMT20P, GGMT20T, GGMT21P, GGMT21T, GGMT40P, GGMT40T, GGVT20P, GGVT20T, GGVT21P, GGVT21T, GGVT40P, GGVT40T, GMT20D, GMT20P, HME202P, HME202T, HME202X, HMG101P, HMG101T, HMG101X, HMG102P, HMG102T, HMG102X, HMG201P, HMG201T, HMG201X, HMG202P, HMG202T, HMG202X, HVE202P...(Other models you can see in the webshop)		



1

Part No.	694318	Ref. No.	10206540 LA10206540 LAR10206540
description	injection pipe L1 66mm L2 49mm tube ø 8mm mounting distance 36mm		
For models:	CGC24M, CGC40M, EC106M, EC110M, EC210M, EM010M+SC, EM106H, EM106M, EM106M+SC, EM106P, EM110H, EM110M, EM110M+SC, EM110P, EM210H, EM210M, EM210M+SC, EM210P, EV006M, EV106H, EV106M, EV106M+SC, EV106P, EV110H, EV110M, EV110M+SC, EV110P, EV210H, EV210M, EV210M+SC, EV210P, GC106M, GC110M, GC210M, GM106H, GM106M, GM106M+SC, GM106P, GM110H, GM110M, GM110M+SC, GM110P, GM210H, GM210M, GM210M+SC, GM210P, GV106H, GV106M, GV106M+SC, GV106P...(Other models you can see in the webshop)		



1

Part No.	692820	Ref. No.	11200650 LAR11200650
description	injection pipe with holder for combi-steamer ED ø 8mm ID ø 6mm L 150mm H 75mm		
For models:	AVE07D, BPE064M, BPE064P, BPE074M, BPE074P, BPG064M, BPG064P, BPG074M, BPG074P, CE071M, CG071M, EMT06D, GEMT06P, GEMT06T, GEVT06P, GEVT06T, GGMT06P, GGMT06T, GGVT06P, GGVT06T, GMT06D, GVT06D, HME061P, HME061T, HME061X, HMG061P, HMG061T, HMG061X, HVE061P, HVE061T, HVE061X, HVG061P, HVG061T, HVG061X, MACE07M, MACG07M, MCE071M, MCG071M, ME061D, ME061H, ME061M, ME061P, ME061T, MEMT06D, MEMT06P, MEVT06D, MEVT06P, MG061D, MG061H, MG061M...(Other models you can see in the webshop)		



spare parts and accessories



1	Part No.	692833	Ref. No.	LA17402180 LAR17402180
description door hinge L 62mm W 35mm H 36mm mounting distance 38mm mounting pos. upper ID ø 8.5mm thickness 4mm for combi-steamer				



1	Part No.	692829	Ref. No.	17402190 LA17402190 LAR17402190
description door hinge L 62mm W 35mm H 36mm mounting pos. lower thickness 4mm for combi-steamer				



1	Part No.	692828	Ref. No.	17400540 LA17400540 LAR17400540
description door hinge upper for combi-steamer L 63mm W 35mm H 31mm				
For models: A05PES, A05RES, A05RES+UM, A08RES, A08RES+UM, A10RES, A10RES+UM				



1	Part No.	692835	Ref. No.	58003110 LA58003110 LAR58003110
description pin for air baffle combi-steamer L 38mm ø 7mm				
For models: EPE056T, EPEV05T, EPG056T, EPGV05T, GEMT06P, GEMT06T, GEMT10P, GEMT10T, GEMT21P, GEMT21T, GEVT06P, GEVT06T, GEVT10P, GEVT10T, GEVT21P, GEVT21T, GGMT06P, GGMT06T, GGMT10P, GGMT10T, GGMT21P, GGMT21T, GGV06P, GGV06T, GGV10P, GGV10T, GGV21P, GGV21T, HME061P, HME061T, HME061X, HMG061P, HMG061T, HMG061X, HVE061P, HVE061T, HVE061X, HVG061P, HVG061T, HVG061X				



1	Part No.	694979	Ref. No.	LA69180110 LAR69180110
description thermostatic steam trap for combi-steamer plastic				



1	Part No.	694981	Ref. No.	69180100 LA69180100
description thermostatic steam trap for combi-steamer plastic				

filters



1	Part No.	691269	Ref. No.	18200260 LAR18200260
description drain filter ø 43mm				
For models: CE041M, MACE04M, MCE042M, MVE042P, VE042P				



1	Part No.	691270	Ref. No.	02200280 10201700 LA10201700 LAR02200280 LAR10201700
description drain filter ø 76mm				
For models: AVE07D, BPE064M, BPE064P, BPE074M, BPE074P, BPG064M, BPG064P, BPG074M, BPG074P, CE071M, CG071M, EC106M, EC110M, EC210M, EM010M+SC, EM106H, EM106M, EM106M+SC, EM106P, EM110H, EM110M, EM110M+SC, EM110P, EM210H, EM210M, EM210M+SC, EM210P, EPE056T, EPE086T, EPEV08T, EPG086T, EPGV08T, EV006M, EV106H, EV106M, EV106M+SC, EV106P, EV110H, EV110M, EV110M+SC, EV110P, EV210H, EV210M, EV210M+SC, EV210P, FE105M, FE105X, FE110M, FE110X, FG051M...(Other models you can see in the webshop)				



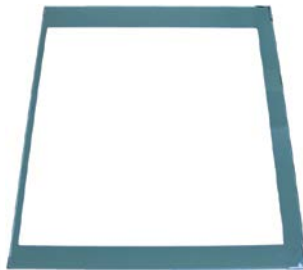

			
1			
Part No.	691271	Ref. No.	10201710 LA10201710 LAR10201710
description	drain filter ø 87mm		
For models:	ACG10M, AVE10D, AVE10P, BPE084M, BPE084P, BPE104M, BPE104P, BPG084M, BPG084P, BPG104M, BPG104P, CE100M, CE200M, CG100M, CG200M, EMT06D, EPE156T, EPEV05T, EPEV15T, EPG056T, EPG156T, EPGV05T, EPGV15T, GEMT40P, GEMT40T, GEVT40P, GEVT40T, GGMT21P, GGMT21T, GGMT40P, GGMT40T, GGV21P, GGV21T, GGV40P, GGV40T, GMT06D, GMT20D, GMT20P, GVT06D, HME201P, HME201T, HME201X, HME202P, HME202T, HME202X, HMG201P, HMG201T, HMG201X, HMG202P, HMG202T...(Other models you can see in the webshop)		

			
1			
Part No.	696396	Ref. No.	11100140 LAR11100140
description	glass panel L 860mm W 730mm thickness 6mm mounting pos. inner for combi-steamer		
For models:	EPE086T, EPEV08T, EPG086T, EPGV08T, GEMT20P, GEMT20T, GEVT20P, GEVT20T, GGMT20P, GGMT20T, GGV20P, GGV20T, GMT20D, GMT20P, GVT20D, HME101P, HME101T, HME101X, HME102P, HME102T, HME102X, HMG101P, HMG101T, HMG101X, HMG102P, HMG102T, HMG102X, HVE101P, HVE101T, HVE101X, HVE102P, HVE102T, HVE102X, HVG101P, HVG101T, HVG101X, HVG102P, HVG102T, HVG102X, ME101D, ME101H, ME101M, ME101P, ME101T, ME102D, ME102H, ME102M, ME102P, ME102T, MEMT20D...(Other models you can see in the webshop)		

glass panels			
			
1			
Part No.	694230	Ref. No.	71200200 LAR71200200
description	glass panel		
For models:	PE015M, PE115K, PG015M, PG115M		

			
1			
Part No.	696395	Ref. No.	99600638 LAR99600638
description	glass panel L 800mm W 591mm thickness 5mm for combi-steamer		

cleaning system			
nozzles			
			
1			
Part No.	550864	Ref. No.	62210042 LAR62210042
description	nozzle flow rate 0.56l/min for combi-steamer		
For models:	EPE056T, EPE086T, EPE156T, EPEV05T, EPEV08T, EPEV15T, EPG056T, EPG086T, EPG156T, EPGV05T, EPGV08T, EPGV15T, GEMT06P, GEMT06T, GEMT10P, GEMT10T, GEMT20P, GEMT20T, GEMT21P, GEMT21T, GEMT40P, GEMT40T, GEVT06P, GEVT06T, GEVT10P, GEVT10T, GEVT20P, GEVT20T, GEVT21P, GEVT21T, GEVT40P, GEVT40T, GGMT06P, GGMT06T, GGMT10P, GGMT10T, GGMT20P, GGMT20T, GGMT21P, GGMT21T, GGMT40P, GGMT40T, GGV06P, GGV06T, GGV10P, GGV10T, GGV20P, GGV20T, GGV21P, GGV21T...(Other models you can see in the webshop)		

			
1			
Part No.	550865	Ref. No.	62210032 LAR62210032
description	nozzle flow rate 1.3l/min for combi-steamer		
For models:	EPE056T, EPE086T, EPE156T, EPEV05T, EPEV08T, EPEV15T, EPG056T, EPG086T, EPG156T, EPGV05T, EPGV08T, EPGV15T, GEMT06P, GEMT06T, GEMT10P, GEMT10T, GEMT20P, GEMT20T, GEMT21P, GEMT21T, GEMT40P, GEMT40T, GEVT06P, GEVT06T, GEVT10P, GEVT10T, GEVT20P, GEVT20T, GEVT21P, GEVT21T, GEVT40P, GEVT40T, GGMT06P, GGMT06T, GGMT10P, GGMT10T, GGMT20P, GGMT20T, GGMT21P, GGMT21T, GGMT40P, GGMT40T, GGV06P, GGV06T, GGV10P, GGV10T, GGV20P, GGV20T, GGV21P, GGV21T...(Other models you can see in the webshop)		



coupling bushings



1

Part No.	550863	Ref. No.	58004980 LA58004980 LAR58004980
description	bush for wash arm		
For models:	EPE056T, EPE086T, EPE156T, EPEV05T, EPEV08T, EPEV15T, EPG056T, EPG086T, EPG156T, EPGV05T, EPGV08T, EPGV15T, GEMT06P, GEMT06T, GEMT10P, GEMT10T, GEMT20P, GEMT20T, GEMT21P, GEMT21T, GEMT40P, GEMT40T, GEVT06P, GEVT06T, GEVT10P, GEVT10T, GEVT20P, GEVT20T, GEVT21P, GEVT21T, GEVT40P, GEVT40T, GGMT06P, GGMT06T, GGMT10P, GGMT10T, GGMT20P, GGMT20T, GGMT21P, GGMT21T, GGMT40P, GGMT40T, GGVT06P, GGVT06T, GGVT10P, GGVT10T, GGVT20P, GGVT20T, GGVT21P, GGVT21T...(Other models you can see in the webshop)		

cleaning arms



1

Part No.	542409	Ref. No.	58007020 L58007020 LAR58007020
description	mounting flange with gasket for wash arm suitable for LAINOX combi-steamer		

hoses



1

Part No.	694953	Ref. No.	80150040 80150040A LAR70070080 LAR80150040 LAR80150040A
description	hose ID \varnothing 13mm ED \varnothing 23mm L 1mm EPDM blue/white t.max. 120°C for combi-steamer		

screw connections



1

Part No.	542411	Ref. No.	LA58007050 LAR58007050
description	bolt for fixing wash arm M12x1 L 110mm		



1

Part No.	542412	Ref. No.	58007000 LA58007000 LAR58007000
description	bolt for flange wash arm L 50mm M12x1 suitable for combi-steamer		



1

Part No.	361814	Ref. No.	62020108 LA62020108 LAR62020108
description	double nipple 1/8" L 20mm plastic WS 11		
For models:	ME061T, ME101T, ME102T, ME201T, ME202T, MG061T, MG101T, MG102T, MG201T, MG202T		

pipes



1

Part No.	520970	Ref. No.	62180022 LAR62180022
description	drain pipe flexible L 135mm ID \varnothing 18mm ED \varnothing 27.5mm connection 3/4" ET - 3/4" IT SS for combi-steamer		
For models:	GGMT06P, GGMT06T, GGMT10P, GGMT10T, GGMT20P, GGMT20T, GGMT21P, GGMT21T, GGMT40P, GGMT40T, GGVT10P, GGVT10T, GMT06D, HMG061P, HMG061T, HMG061X, HMG101P, HMG101T, HMG101X, HMG102P, HMG102T, HMG102X, HMG201P, HMG201T, HMG201X, HMG202P, HMG202T, HMG202X, ME201D, ME201H, ME201M, ME201P, ME201T, MEMT21D, MEMT21P, MG061D, MG061M, MG061P, MG061T, MG101D, MG101M, MG101P, MG101T, MG120D, MG120H, MG120M, MG120P, MG120X, MG201D, MG201H...(Other models you can see in the webshop)		

hoses



1

Part No.	530904	Ref. No.	77700056 LAR77700056
description	hose ID \varnothing 30mm ED \varnothing 36mm L 3000mm for combi-steamer		
For models:	BPG044M, BPG044P, BPG054M, BPG054P, BPG064M, BPG064P, BPG074M, BPG074P, BPG084M, BPG084P, BPG104M, BPG104P, EPG056T, EPG086T, EPG156T, EPGV05T, EPGV08T, EPGV15T, GGMT06P, GGMT06T, GGMT10P, GGMT10T, GGMT20P, GGMT20T, GGMT21P, GGMT21T, GGMT40P, GGMT40T, GGVT06P, GGVT06T, GGVT10P, GGVT10T, GGVT20P, GGVT20T, GGVT21P, GGVT21T, GGVT40P, GGVT40T, HMG061P, HMG061T, HMG061X, HMG101P, HMG101T, HMG101X, HMG102P, HMG102T, HMG102X, HMG201P, HMG201T, HMG201X... (Other models you can see in the webshop)		



1

Part No.	520534	Ref. No.	70060040 LA70060040 LAR70060040
description	hose ID ø 50mm ED ø 58mm L 50mm silicone Qty 1 for combi-steamer thickness 4mm		
For models:	EPE056T, EPE086T, EPE156T, EPEV05T, EPEV08T, EPEV15T, EPG056T, EPG086T, EPG156T, EPGV05T, EPGV08T, EPGV15T, FE105M, FE105X, FE110M, FE110X, FG051M, FG051X, FG101M, FG101X, FG105M, FG105X, FG110M, FG110X, GEMT06P, GEMT06T, GEMT10P, GEMT10T, GEMT20P, GEMT20T, GEMT21P, GEMT21T, GEMT40P, GEMT40T, GEVT06P, GEVT06T, GEVT10P, GEVT10T, GEVT20P, GEVT20T, GEVT21P, GEVT21T, GEVT40P, GEVT40T, GGMT06P, GGMT06T, GGMT10P, GGMT10T, GGMT20P, GGMT20T... (Other models you can see in the webshop)		



2

Part No.	530901	Ref. No.	70060050 LA70060050 R70060050
description	hose ID ø 54mm ED ø 60mm L 50mm for combi-steamer		
For models:	FE210M, FG210M, FG210X, GEMT20P, GEMT20T, GEMT40P, GEMT40T, GEVT20P, GEVT20T, GEVT40P, GEVT40T, GGMT40P, GGMT40T, GGV40P, GGV40T, HME102P, HME102T, HME102X, HME202P, HME202T, HME202X, HMG202P, HMG202T, HMG202X, HVE102P, HVE102T, HVE102X, HVE202P, HVE202T, HVE202X, HVG202P, HVG202T, HVG202X, MCE202M, MCG202M, ME102H, ME102M, ME102P, ME102T, ME202D, ME202H, ME202M, ME202P, ME202T, MEMT40D, MEMT40P, MEVT40D, MEVT40P, MG102H, MG102M... (Other models you can see in the webshop)		

service kits

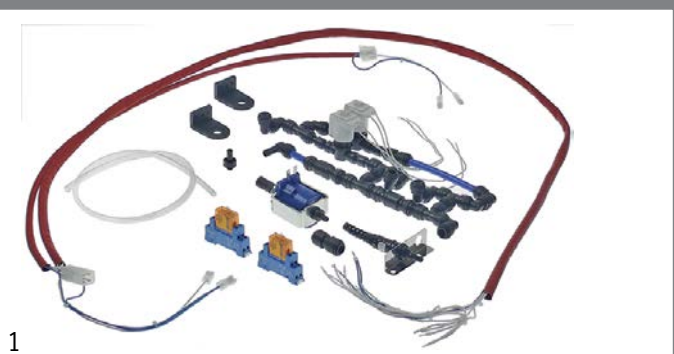

1

Part No.	512503	Ref. No.	62300028 LAR62300028
description	backflow preventer kit		
For models:	EPE056T, EPE086T, EPE156T, EPEV05T, EPEV08T, EPEV15T, EPG056T, EPG086T, EPG156T, EPGV05T, EPGV08T, EPGV15T, GEMT06P, GEMT06T, GEMT10P, GEMT10T, GEMT20P, GEMT20T, GEVT06P, GEVT06T, GEVT10P, GEVT10T, GEVT20P, GEVT20T, GGMT06P, GGMT06T, GGMT10P, GGMT10T, GGMT20P, GGMT20T, GGV06P, GGV06T, GGV10P, GGV10T, GGV20P, GGV20T, GMT20P, HME061P, HME061T, HME061X, HME101P, HME101T, HME101X, HME102P, HME102T, HME102X, HME201P, HME201T, HME201X, HMG061P... (Other models you can see in the webshop)		



1

Part No.	530902	Ref. No.	99000160 LA99000160 LAR99000160
description	flange kit for washing arms suitable for combi-steamer LAINOX		



1

Part No.	699468	Ref. No.	58003100 LAR58003100
description	mounting set for air baffle 4-piece		
For models:	CGC24M, CGC40M, EMT06D, EPE086T, EPE156T, EPEV08T, EPEV15T, EPG086T, EPG156T, EPGV08T, EPGV15T, GEMT20P, GEMT20T, GEMT40P, GEMT40T, GEVT20P, GEVT20T, GEVT40P, GEVT40T, GGMT20P, GGMT20T, GGMT40P, GGMT40T, GGV20P, GGV20T, GGV40P, GGV40T, GMT06D, GMT20D, GMT20P, GVT06D, GVT20D, HME101P, HME101T, HME101X, HME102P, HME102T, HME102X, HME201P, HME201T, HME201X, HME202P, HME202T, HME202X, HMG101P, HMG101T, HMG101X, HMG102P, HMG102T, HMG102X... (Other models you can see in the webshop)		

mechanical components,
equipment accessories
1



drip water trays



1

Part No.	699854	Ref. No.	69180190 LAR69180190
description	drip tray L 520mm W 35mm H 70mm		
For models:	GEMT06P, GEMT06T, GEMT10P, GEMT10T, GEVT06P, GEVT06T, GEVT10P, GEVT10T, GGMT06P, GGMT06T, GGMT10P, GGMT10T, GGVT06P, GGVT06T, GGVT10P, GGVT10T		



1

Part No.	699242	Ref. No.	69180200 LAR69180200
description	drip tray L 576mm W 32mm H 51mm		
For models:	GEMT06P, GEMT06T, GEMT10P, GEMT10T, GEVT06P, GEVT06T, GEVT10P, GEVT10T, GGMT06P, GGMT06T, GGMT10P, GGMT10T, GGVT06P, GGVT06T, GGVT10P, GGVT10T		

door mechanics

holders



1

Part No.	691272	Ref. No.	18203910 LAR18203910
description	bracket for glass plate mounting pos. lower		
For models:	ACG10M, AVE07D, AVE10D, AVE10P, BPE064M, BPE064P, BPE074M, BPE074P, BPE084M, BPE084P, BPE104M, BPE104P, BPG064M, BPG064P, BPG074M, BPG074P, BPG084M, BPG084P, BPG104M, BPG104P, CE071M, CE100M, CE200M, CG071M, CG100M, CG200M, MACE07M, MACE10M, MACE20M, MACG07M, MACG10M, MACG20M, MCE071M, MCE101M, MCE102M, MCG071M, MCG101M, MCG102M, MME071P, MME101P, MME102P, MMG071P, MMG101P, MMG102P, MVE071M, MVE071P, MVE101M, MVE101P, MVE102P, MVG071P... (Other models you can see in the webshop)		



1

Part No.	691273	Ref. No.	18203920 LAR18203920
description	bracket for glass plate mounting pos. upper		
For models:	ACG10M, AVE07D, AVE10D, AVE10P, BPE064M, BPE064P, BPE074M, BPE074P, BPE084M, BPE084P, BPE104M, BPE104P, BPG064M, BPG064P, BPG074M, BPG074P, BPG084M, BPG084P, BPG104M, BPG104P, CE071M, CE100M, CE200M, CG071M, CG100M, CG200M, MACE07M, MACE10M, MACE20M, MACG07M, MACG10M, MACG20M, MCE071M, MCE101M, MCE102M, MCG071M, MCG101M, MCG102M, MME071P, MME101P, MME102P, MMG071P, MMG101P, MMG102P, MVE071M, MVE071P, MVE101M, MVE101P, MVE102P, MVG071P... (Other models you can see in the webshop)		

accessories



1

Part No.	699243	Ref. No.	69010200 LA69010200 LAR69010200
description	cover for handle W 23mm L 95mm		
For models:	A05PES, A05RES, A05RES+UM, A08RES, A08RES+UM, A10RES, A10RES+UM		



1

Part No.	692834	Ref. No.	10207680 LA10207680 LAR10207680
description	fixing plate for door W 30mm L 50mm		
For models:	CGC24M, CGC40M, EPE156T, EPEV15T, EPG156T, EPGV15T, GEMT21P, GEMT21T, GEMT40P, GEMT40T, GEVT21P, GEVT21T, GEVT40P, GEVT40T, GGMT21P, GGMT21T, GGMT40P, GGMT40T, GGVT21P, GGVT21T, GGVT40P, GGVT40T, HME201P, HME201T, HME201X, HME202P, HME202T, HME202X, HMG201P, HMG201T, HMG201X, HMG202P, HMG202T, HMG202X, HVE201P, HVE201T, HVE201X, HVE202P, HVE202T, HVE202X, HVG201P, HVG201T, HVG201X, HVG202P, HVG202T, HVG202X, MCE201M, MCE202M, MCG201M, MCG202M... (Other models you can see in the webshop)		



vibration pumps



1

Part No.	500568	Ref. No.	65110600 LAR65110600
description	vibration pump 230V 32W 50Hz inlet \varnothing 7 outlet \varnothing 1/8" IT CEME type E512/A32		
For models:	EPE056T, EPE086T, EPE156T, EPEV05T, EPEV08T, EPEV15T, EPG056T, EPG086T, EPG156T, EPGV05T, EPGV08T, EPGV15T, GEMT06P, GEMT06T, GEMT10P, GEMT10T, GEMT20P, GEMT20T, GEMT21P, GEMT21T, GEMT40P, GEMT40T, GEVT06P, GEVT06T, GEVT10P, GEVT10T, GEVT20P, GEVT20T, GEVT21P, GEVT21T, GEVT40P, GEVT40T, GGMT06P, GGMT06T, GGMT10P, GGMT10T, GGMT20P, GGMT20T, GGMT21P, GGMT21T, GGMT40P, GGMT40T, GGVTO6P, GGVTO6T, GGVT10P, GGVT10T, GGVT20P, GGVT20T, GGVT21P, GGVT21T...(Other models you can see in the webshop)		
spare parts for	500568		
	Part No.	390698	Ref. No. —
	 thermal fuse switch-off temp. 110°C suitable for ULKA pump		



1

Part No.	501567	Ref. No.	65110620 LAR65110620
description	vibration pump type HF 230V 22W 50Hz inlet \varnothing 6 outlet \varnothing 6 ULKA plastic L 97mm connection male faston 4.8mm		

heat exchangers



1

Part No.	520509	Ref. No.	58004170 LA58004170 LAR58004170
description	reducing washer gas burner brass ID \varnothing 3mm ED \varnothing 16mm thickness 2.2mm code 3		
For models:	BPG044M, BPG044P, BPG054M, BPG054P, BPG064M, BPG064P, BPG074M, BPG074P, CG051M, EPG056T, EPGV05T, GGMT06P, GGMT06T, GGVTO6P, GGVTO6T, HMG061P, HMG061T, HMG061X, HVG061P, HVG061T, HVG061X, MACG05M, MCG051M, MCG071M, MMG071P, MVG051P, MVG071P, VG051P		

miscellaneous



1

Part No.	696428	Ref. No.	11201970 LA11201970 LAR11201970
description	extension U-shape for injection pipe D1 \varnothing 8mm D2 \varnothing 10mm L 212mm WS 12 stainless steel		
For models:	AVE10D, AVE10P, BPE084M, BPE084P, BPE104M, BPE104P, CE100M, CE200M, EPE086T, EPE156T, EPEV08T, EPEV15T, EPGV08T, EPGV15T, GEMT10P, GEMT10T, GEMT20P, GEMT20T, GEMT21P, GEMT21T, GEVT10P, GEVT10T, GEVT20P, GEVT20T, GEVT21P, GEVT21T, GGMT10P, GGMT10T, GGVT10P, GGVT10T, HME101P, HME101T, HME101X, HME102P, HME102T, HME102X, HME201P, HME201T, HME201X, HVE101P, HVE101T, HVE101X, HVE102P, HVE102T, HVE102X, HVE201P, HVE201T, HVE201X, MACE10M, MACE20M...(Other models you can see in the webshop)		



1

Part No.	696394	Ref. No.	10206470 LAR10206470
description	extension U-shape for injection pipe D1 \varnothing 8mm D2 \varnothing 12mm L 113mm W 72mm		
For models:	EC106M, EM106H, EM106M, EM106M+SC, EM106P, EV006M, EV106H, EV106M, EV106M+SC, EV106P, GC106M, GM106H, GM106M, GM106M+SC, GM106P, GV106H, GV106M, GV106M+SC, GV106P, VE106D, VE106H, VE106M, VE106P, VE106X, VG106D, VG106H, VG106M, VG106P, VG106X		



1

Part No.	691290	Ref. No.	10100140 LAR10100140
description	extractor stubs complete		
For models:	AVE10P, BPE064P, BPE074P, BPE084P, BPE104P, BPG064P, BPG074P, BPG084P, BPG104P, EPE056T, EPE086T, EPEV05T, EPEV08T, EPG056T, EPG086T, EPGV05T, EPGV08T, GEMT06P, GEMT06T, GEMT10P, GEMT10T, GEMT20P, GEMT20T, GEMT21P, GEMT21T, GEVT06P, GEVT06T, GEVT10P, GEVT10T, GEVT20P, GEVT20T, GEVT21P, GEVT21T, GGMT06P, GGMT06T, GGMT10P, GGMT10T, GGMT20P, GGMT20T, GGVTO6P, GGVTO6T, GGVT10P, GGVT10T, GGVT20P, GGVT20T, HME061P, HME061T, HME061X, HME101P, HME101T...(Other models you can see in the webshop)		





			
1			
Part No.	691282	Ref. No.	58005350 LA58005350 LAR58005350
description	gasket for door handle D1 ø 30mm D2 ø 18mm mounting pos. upper H 1.4mm		
For models:	ACG10M, AVE07D, AVE10D, AVE10P, BPE044M, BPE044P, BPE054M, BPE054P, BPE064M, BPE064P, BPE074M, BPE074P, BPE084M, BPE084P, BPE104M, BPE104P, BPG044M, BPG044P, BPG054M, BPG054P, BPG064M, BPG064P, BPG074M, BPG074P, BPG084M, BPG084P, BPG104M, BPG104P, CE041M, CE051M, CE071M, CE100M, CE200M, CG051M, CG071M, CG100M, CG200M, CVE004H, CVE004M, CVE104H, CVE104M, CVE105H, CVE105M, CVG105H, CVG105M, EC106M, EC110M, EC210M, EM010M+SC, EM106H... (Other models you can see in the webshop)		

			
1			
Part No.	691291	Ref. No.	70060020 LA70060020 LAR70060020
description	gasket for extractor stubs D1 ø 30mm D2 ø 35mm W 9mm		
For models:	AVE10P, BPE064P, BPE074P, BPE084P, BPE104P, BPG064P, BPG074P, BPG084P, BPG104P, EPE056T, EPE086T, EPEV05T, EPEV08T, EPG056T, EPG086T, EPGV05T, EPGV08T, GEMT06P, GEMT06T, GEMT10P, GEMT10T, GEMT20P, GEMT20T, GEMT21P, GEMT21T, GEVT06P, GEVT06T, GEVT10P, GEVT10T, GEVT20P, GEVT20T, GEVT21P, GEVT21T, GGMT06P, GGMT06T, GGMT10P, GGMT10T, GGMT20P, GGMT20T, GGVT06P, GGVT06T, GGVT10P, GGVT10T, GGVT20P, GGVT20T, HME061P, HME061T, HME061X, HME101P, HME101T... (Other models you can see in the webshop)		

			
1			
Part No.	690762	Ref. No.	69180180 LAR69180180
description	gutter for inner door L 790mm plastic W 34mm with screws		
For models:	EPE056T, EPE086T, EPEV05T, EPEV08T, EPG056T, EPG086T, EPGV05T, EPGV08T, GEMT20P, GEMT20T, GEVT20P, GEVT20T, GGMT20P, GGMT20T, GGVT20P, GGVT20T, HME101P, HME101T, HME101X, HME102P, HME102T, HME102X, HMG101P, HMG101T, HMG101X, HMG102P, HMG102T, HMG102X, HVE101P, HVE101T, HVE101X, HVE102P, HVE102T, HVE102X, HVG101P, HVG101T, HVG101X, HVG102P, HVG102T, HVG102X		

			
1			
Part No.	690099	Ref. No.	50005090 58002150 LA58002150 LAR50005090 LAR58002150
description	hinge pin mounting pos. upper for door		
For models:	ACG10M, AVE07D, AVE10D, AVE10P, BPE064M, BPE064P, BPE074M, BPE074P, BPE084M, BPE084P, BPE104M, BPE104P, BPG064M, BPG064P, BPG074M, BPG074P, BPG084M, BPG084P, BPG104M, BPG104P, CE071M, CE100M, CE200M, CG071M, CG100M, CG200M, CGC24M, CGC40M, EC106M, EC110M, EC210M, EM010M+SC, EM106H, EM106M, EM106M+SC, EM106P, EM110H, EM110M, EM110M+SC, EM110P, EM210H, EM210M, EM210M+SC, EM210P, EMT06D, EPE056T, EPE086T, EPE156T, EPEV05T, EPEV08T... (Other models you can see in the webshop)		

			
1			
Part No.	696547	Ref. No.	11202270 LA11202270 LAR11202270
description	injection pipe angled for combi-steamer D1 ø 10mm D2 ø 8mm L 170mm		
For models:	BPE064M, BPE064P, BPE074M, BPE074P, BPE084M, BPE084P, BPE104M, BPE104P, BPG064M, BPG064P, BPG074M, BPG074P, BPG084M, BPG084P, BPG104M, BPG104P, EPEV05T, EPEV08T, EPEV15T, EPGV05T, EPGV08T, EPGV15T, GEMT20P, GEMT20T, GEMT40P, GEMT40T, GEVT20P, GEVT20T, GEVT40P, GEVT40T, GGMT20P, GGMT20T, GGMT21P, GGMT21T, GGMT40P, GGMT40T, GGVT20P, GGVT20T, GGVT21P, GGVT21T, GGVT40P, GGVT40T, HME061P, HME061T, HME061X, HME101P, HME101T, HME101X, HME102P, HME102T... (Other models you can see in the webshop)		



			
1			
Part No.	506229	Ref. No.	11200380 LA11200380 LAR11200380
description	injection pipe for combi-steamer L 205mm ø 10mm		
For models:	ACG10M, AVE07D, AVE10D, AVE10P, CE071M, CE100M, CE200M, CG071M, CG100M, CG200M, EMT06D, GEMT06P, GEMT06T, GEMT10P, GEMT10T, GEVT06P, GEVT06T, GEVT10P, GEVT10T, GGMT06P, GGMT06T, GGMT10P, GGMT10T, GGVT06P, GGVT06T, GGVT10P, GGVT10T, GMT06D, GMT20D, GMT20P, GVT06D, GVT20D, MACE07M, MACE10M, MACE20M, MACG07M, MACG10M, MACG20M, ME061D, ME061H, ME061M, ME061P, ME061T, ME101D, ME101H, ME101M, ME101P, ME101T, ME101T, ME102D, ME102H... (Other models you can see in the webshop)		





			
1			
Part No.	691289	Ref. No.	58004830 LAR58004830
description	nut thread M18x1 H 5mm WS 22 brass Qty 1 pcs for door handle		
For models:	ACG10M, AVE07D, AVE10D, AVE10P, BPE044M, BPE044P, BPE054M, BPE054P, BPE064M, BPE064P, BPE074M, BPE074P, BPE084M, BPE084P, BPE104M, BPE104P, BPG044M, BPG044P, BPG054M, BPG054P, BPG064M, BPG064P, BPG074M, BPG074P, BPG084M, BPG084P, BPG104M, BPG104P, CE041M, CE051M, CE071M, CE100M, CE200M, CG051M, CG071M, CG100M, CG200M, CVE004H, CVE004M, CVE104H, CVE104M, CVE105H, CVE105M, CVG105H, CVG105M, EC106M, EC110M, EC210M, EM010M+SC, EM106H...		

			
1			
Part No.	691297	Ref. No.	62030118 LA62030118 LAR62030118
description	reducer thread 1/4 / 1/8		
For models:	AVE07D, AVE10D, AVE10P, BPE044P, BPE054P, BPE064M, BPE064P, BPE074M, BPE074P, BPE084M, BPE084P, BPE104M, BPE104P, BPG044P, BPG054P, BPG064M, BPG064P, BPG074M, BPG074P, BPG084M, BPG084P, BPG104M, BPG104P, EPE056T, EPE086T, EPE156T, EPEV05T, EPEV08T, EPEV15T, EPG056T, EPG086T, EPG156T, EPGV05T, EPGV08T, EPGV15T, GEVT06P, GEVT06T, GEVT10P, GEVT10T, GEVT20P, GEVT20T, GEVT21P, GEVT21T, GEVT40P, GEVT40T, GGVTO6P, GGVTO6T, GGVTO10P, GGVTO10T, GGVTO20P...		

			
1			
Part No.	691296	Ref. No.	61400052 LA61400052 LAR61400052
description	plain washer ID ø 10.5mm ED ø 21mm thickness 2mm SS Qty 1 pcs for fan wheel		
For models:	AVE07D, BPE064M, BPE064P, BPE074M, BPE074P, BPG064M, BPG064P, BPG074M, BPG074P, CE071M, CG071M, CVE105H, CVE105M, CVG105H, CVG105M, EC106M, EM106H, EM106M, EM106M+SC, EM106P, EMT06D, EV006M, EV106H, EV106M, EV106M+SC, EV106P, FE105M, FE105X, FG051M, FG051X, FG105M, FG105X, GC106M, GEMT06P, GEMT06T, GEVT06P, GEVT06T, GGMT06P, GGMT06T, GGVTO6P, GGVTO6T, GM106H, GM106M, GM106M+SC, GM106P, GMT06D, GV106H, GV106M, GV106M+SC, GV106P...		

			
1			
Part No.	692340	Ref. No.	62030113 LA62030113 LAR62030113
description	reducer with O-ring brass thread 1/4" / 1/8" Qty 1 pcs total length 25mm		
spare parts for	692340		
	Part No.	Ref. No.	—
	 O-ring EPDM thickness 2.62mm ID ø 7.59mm Qty 1 pcs		

			
1			
Part No.	691292	Ref. No.	10401710 LAR10401710
description	plain washer ID ø 12mm ED ø 17.5mm thickness 1mm SS Qty 1 pcs		
For models:	ACG10M, AVE07D, AVE10D, AVE10P, BPE064M, BPE064P, BPE074M, BPE074P, BPE084M, BPE084P, BPE104M, BPE104P, BPG064M, BPG064P, BPG074M, BPG074P, BPG084M, BPG084P, BPG104M, BPG104P, CE071M, CE100M, CE200M, CG071M, CG100M, CG200M, EMT06D, EPE056T, EPE086T, EPEV05T, EPEV08T, EPG056T, EPG086T, EPGV05T, EPGV08T, GEMT06P, GEMT06T, GEMT10P, GEMT10T, GEMT20P, GEMT20T, GEVT06P, GEVT06T, GEVT10P, GEVT10T, GEVT20P, GEVT20T, GGMT06P, GGMT06T, GGMT10P...		

			
1			
Part No.	694319	Ref. No.	58003390 LA58003390 LAR58003390
description	screw connection for pressure switch L 50mm WS 30 brass thread 1/4"		
For models:	CVE004H, CVE004M, CVE104H, CVE104M, CVE105H, CVE105M, CVG105H, CVG105M, EV106H, EV106P, EV110H, EV110P, EV210H, EV210P, GV106H, GV106P, GV110H, GV110P, GV210H, GV210P, MG202D, MG202H, MG202M, MG202P, MG202T, MGMT40D, MGMT40P, MGMT40T, MGMT40P, PE005K, PE108D, PE115K, VE004D, VE004H, VE004M, VE004X, VE104D, VE104H, VE104M, VE104X, VE105D, VE105H, VE105M, VE105X, VE106D, VE106H, VE106P, VE110D, VE110H, VE120D...		

			
1			
Part No.	691283	Ref. No.	58003240 LAR58003240
description	pressure bolt for door handle D1 ø 8mm D2 ø 11mm L 73mm thread M6 bolt 16mm bolt ø 5mm		
For models:	ACG10M, AVE07D, AVE10D, AVE10P, BPE044M, BPE044P, BPE054M, BPE054P, BPE064M, BPE064P, BPE074M, BPE074P, BPE084M, BPE084P, BPE104M, BPE104P, BPG044M, BPG044P, BPG054M, BPG054P, BPG064M, BPG064P, BPG074M, BPG074P, BPG084M, BPG084P, BPG104M, BPG104P, CE041M, CE051M, CE071M, CE100M, CE200M, CG051M, CG071M, CG100M, CG200M, CVE105H, CVE105M, CVG105H, CVG105M, FE105M, FE105X, FE110M, FE110X, FE210M, FG051M, FG051X, FG101M, FG101X...		



1

Part No.	691280	Ref. No.	58005340 LA58005340 LAR58005340
description	sealing disc for door handle mounting pos. lower ED ø 25mm ID ø 5.5mm H 5mm		
For models:	ACG10M, AVE07D, AVE10D, AVE10P, BPE044M, BPE044P, BPE054M, BPE054P, BPE064M, BPE064P, BPE074M, BPE074P, BPE084M, BPE084P, BPE104M, BPE104P, BPG044M, BPG044P, BPG054M, BPG054P, BPG064M, BPG064P, BPG074M, BPG074P, BPG084M, BPG084P, BPG104M, BPG104P, CE041M, CE051M, CE071M, CE100M, CE200M, CG051M, CG071M, CG100M, CG200M, CVE004H, CVE004M, CVE104H, CVE104M, CVE105H, CVE105M, CVG105H, CVG105M, EC106M, EC110M, EC210M, EM010M+SC, EM106H... (Other models you can see in the webshop)		

2



Part No.	691281	Ref. No.	58004270 LAR58004270
description	spacer piece for door handle L 34mm ID ø 6mm ED ø 8mm		
For models:	ACG10M, AVE07D, AVE10D, AVE10P, BPE044M, BPE044P, BPE054M, BPE054P, BPE064M, BPE064P, BPE074M, BPE074P, BPE084M, BPE084P, BPE104M, BPE104P, BPG044M, BPG044P, BPG054M, BPG054P, BPG064M, BPG064P, BPG074M, BPG074P, BPG084M, BPG084P, BPG104M, BPG104P, CE041M, CE051M, CE071M, CE100M, CE200M, CG051M, CG071M, CG100M, CG200M, CVE004H, CVE004M, CVE104H, CVE104M, CVE105H, CVE105M, CVG105H, CVG105M, FE105M, FE105X, FE110M, FE110X, FE210M... (Other models you can see in the webshop)		

1



Part No.	692300	Ref. No.	70050100 70050180 LAR70050100 LAR70050180
description	stopper with screw connection for glass plate D1 ø 15mm L 8mm thread M4		
For models:	ACG10M, AVE07D, AVE10D, AVE10P, BPE064M, BPE064P, BPE074M, BPE074P, BPE084M, BPE084P, BPE104M, BPE104P, BPG064M, BPG064P, BPG074M, BPG074P, BPG084M, BPG084P, BPG104M, BPG104P, CE071M, CE100M, CE200M, CG071M, CG100M, CG200M, EMT06D, EPE056T, EPE086T, EPE156T, EPEV05T, EPEV08T, EPEV15T, EPG056T, EPG086T, EPG156T, EPGV05T, EPGV08T, EPGV15T, GEMT06P, GEMT06T, GEMT10P, GEMT10T, GEMT20P, GEMT20T, GEMT21P, GEMT21T, GEMT40P, GEMT40T, GEVT06P... (Other models you can see in the webshop)		

EQUIPMENT-SPECIFIC UNITS/KNOBS LAINOX

for dishwashers

backflow preventers

non-return valves



1

Part No.	520886	Ref. No.	65110640 LAR65110640 LARR65110640
description	non-return valve plastic total length 67mm		
For models:	EPE056T, EPE086T, EPE156T, EPEV05T, EPEV08T, EPEV15T, EPG056T, EPG086T, EPG156T, EPGV05T, EPGV08T, EPGV15T, GEMT06P, GEMT06T, GEMT10P, GEMT10T, GEMT20P, GEMT20T, GEMT21P, GEMT21T, GEMT40P, GEMT40T, GEVT06P, GEVT06T, GEVT10P, GEVT10T, GEVT20P, GEVT20T, GEVT21P, GEVT21T, GEVT40P, GEVT40T, GGMT06P, GGMT06T, GGMT10P, GGMT10T, GGMT20P, GGMT20T, GGMT21P, GGMT21T, GGMT40P, GGMT40T, GGVT06P, GGVT06T, GGVT10P, GGVT10T, GGVT20P, GGVT20T, GGVT21P, GGVT21T... (Other models you can see in the webshop)		

1



Part No.	520338	Ref. No.	65110640 (old) LAR65110640 (old)
description	non-return valve thread 1/4" plastic total length 45mm		

knobs

producer-specific knobs

LAINOX





1

Part No.	111772	Ref. No.	69030260 69030280 LA69030260 LA69030280 LAR69030260 LAR69030280
description	knob ø 42mm shaft ø 6x4.6mm shaft flat universal		
For models:	AVE07D, AVE10D, AVE10P, BPE044P, BPE054P, BPE064P, BPE074P, BPE084P, BPE104P, BPG044P, BPG054P, BPG064P, BPG074P, BPG084P, BPG104P, EMT06D, GEMT06P, GEMT10P, GEMT21P, GEVT06P, GEVT10P, GEVT21P, GEMT06D, GMT20D, GMT20P, GVT06D, GVT20D, ME061D, ME061H, ME061P, ME101D, ME101H, ME101P, ME102D, ME102H, ME102P, ME201D, ME201H, ME201P, ME202D, ME202H, ME202P, MEMT06D, MEMT06P, MEMT10D, MEMT10P, MEMT20D, MEMT20P, MEMT21D, MEMT21P... (Other models you can see in the webshop)		



			
1			
Part No.	111791	Ref. No.	69030270 LA69030270 LAR69030270
description	knob ø 61mm shaft ø 6x4.6mm black		
For models:	GEMT20P, GEMT20T, GEMT40P, GEMT40T, GEVT20P, GEVT20T, GEVT40P, GEVT40T, GGMT06P, GGMT06T, GGMT10P, GGMT10T, GGMT20P, GGMT20T, GGMT21P, GGMT21T, GGMT40P, GGMT40T, GGVT06P, GGVT06T, GGVT10P, GGVT10T, GGVT20P, GGVT20T, GGVT21P, GGVT21T, GGVT40P, GGVT40T, HME061P, HME061T, HME061X, HME101P, HME101T, HME101X, HME102P, HME102T, HME102X, HME201P, HME201T, HME201X, HME202P, HME202T, HME202X, HMG061P, HMG061T, HMG061X, HMG101P, HMG101T, HMG101X, HMG102P...(Other models you can see in the webshop)		

			
1			
Part No.	110138	Ref. No.	69030150 LAR69030150
description	knob switch zero mark ø 42mm shaft ø 6x4.6mm shaft flat upper black		
For models:	CGC24M, CGC40M, CVE004H, CVE004M, CVE104H, CVE104M, CVE105H, CVE105M, CVG105H, CVG105M, FE105M, FE105X, FE110M, FE110X, FE210M, FG051M, FG051X, FG101M, FG101X, FG105M, FG105X, FG110M, FG110X, FG210M, FG210X, ME061M, ME101M, ME102M, ME106D, ME106H, ME106M, ME106P, ME106X, ME110D, ME110H, ME110M, ME110P, ME110X, ME120D, ME120H, ME120M, ME120P, ME120X, ME201M, ME202M, ME210D, ME210H, ME210M, ME210P, ME210X...(Other models you can see in the webshop)		

			
1			
Part No.	111771	Ref. No.	50103120 50103130 69030050 69030060 69030080 69030170 69030250 69030290 LA69030170 LAR50103130 LAR69030060 LAR69030080 LAR69030170 LAR69030250 LAR69030290
description	knob switch zero mark ø 42mm shaft ø 6x4.6mm shaft flat upper black		
For models:	ACG10M, BPE044M, BPE054M, BPE064M, BPE074M, BPE084M, BPE104M, BPG044M, BPG054M, BPG064M, BPG074M, BPG084M, BPG104M, CE041M, CE051M, CE071M, CE100M, CE200M, CG051M, CG071M, CG100M, CG200M, EC106M, EC110M, EC210M, EM010M+SC, EM106H, EM106M, EM106M+SC, EM106P, EM110H, EM110M, EM110M+SC, EM110P, EM210H, EM210M, EM210M+SC, EM210P, EPE056T, EPE086T, EPE156T, EPEV05T, EPEV08T, EPEV15T, EPG056T, EPG086T, EPG156T, EPGV05T, EPGV08T, EPGV15T...(Other models you can see in the webshop)		

locks

handle latches

producer-specific

LAINOX

group 1

			
1			
Part No.	690337	Ref. No.	69010630 LAR69010630
description	cover L 39.5mm ø 55.5mm		
For models:	EMT06D, EPE056T, EPE086T, EPEV05T, EPEV08T, EPG056T, EPG086T, EPGV05T, EPGV08T, GEMT06P, GEMT06T, GEMT10P, GEMT10T, GEMT20P, GEMT20T, GEVT06P, GEVT06T, GEVT10P, GEVT10T, GEVT20P, GEVT20T, GGMT06P, GGMT06T, GGMT10P, GGMT10T, GGMT20P, GGMT20T, GGVT06P, GGVT06T, GGVT10P, GGVT10T, GGVT20P, GGVT20T, GMT06D, GMT20D, GMT20P, GMT06D, GMT20D, HME061P, HME061T, HME061X, HME101P, HME101T, HME101X, HME102P, HME102T, HME102X, HMG061P, HMG061T, HMG061X...(Other models you can see in the webshop)		

			
1			
Part No.	694067	Ref. No.	69010260 LA69010260 LAR69010260
description	door catch with spigot 1-stage L 26mm total length 51mm thread M8		
For models:	EMT06D, EPE056T, EPE086T, EPEV05T, EPEV08T, EPG056T, EPG086T, EPGV05T, EPGV08T, GEMT06P, GEMT06T, GEMT10P, GEMT10T, GEMT20P, GEMT20T, GEVT06P, GEVT06T, GEVT10P, GEVT10T, GEVT20P, GEVT20T, GGMT06P, GGMT06T, GGMT10P, GGMT10T, GGMT20P, GGMT20T, GGVT06P, GGVT06T, GGVT10P, GGVT10T, GGVT20P, GGVT20T, GMT06D, GMT20D, GMT20P, GMT06D, GMT20D, HME061P, HME061T, HME061X, HME101P, HME101T, HME101X, HME102P, HME102T, HME102X, HMG061P, HMG061T, HMG061X...(Other models you can see in the webshop)		







			
1			
Part No.	690339	Ref. No.	69010270 LAR69010270
description	door catch with spigot 2-stage L 30mm H 17mm H1 18mm total length 55mm thread M8 thread L 20mm stainless steel		
For models:	EMT06D, EPE056T, EPE086T, EPEV05T, EPEV08T, EPG056T, EPG086T, EPGV05T, EPGV08T, GEMT06P, GEMT06T, GEMT10P, GEMT10T, GEMT20P, GEMT20T, GEVT06P, GEVT06T, GEVT10P, GEVT10T, GEVT20P, GEVT20T, GGMT06P, GGMT06T, GGMT10P, GGMT10T, GGMT20P, GGMT20T, GGVT06P, GGVT06T, GGVT10P, GGVT10T, GGVT20P, GGVT20T, GMT06D, GMT20D, GMT20P, GMT06D, GMT20D, HME061P, HME061T, HME061X, HME101P, HME101T, HME101X, HME102P, HME102T, HME102X, HMG061P, HMG061T, HMG061X...(Other models you can see in the webshop)		



			
1			
Part No.	694284	Ref. No.	11100300 11100330 LAR11100300 LAR11100330
description	door catch kit		
For models:	EMT06D, EPE056T, EPE086T, EPEV05T, EPEV08T, EPG056T, EPG086T, EPGV05T, EPGV08T, GEMT06P, GEMT06T, GEMT10P, GEMT10T, GEMT20P, GEMT20T, GEVT06P, GEVT06T, GEVT10P, GEVT10T, GEVT20P, GEVT20T, GGMT06P, GGMT06T, GGMT10P, GGMT10T, GGMT20P, GGMT20T, GGVT06P, GGVT06T, GGVT10P, GGVT10T, GGVT20P, GGVT20T, GMT06D, GMT20D, GMT20P, GVT06D, GVT20D, HME061P, HME061T, HME061X, HME101P, HME101T, HME101X, HME102P, HME102T, HME102X, HMG061P, HMG061T, HMG061X... (Other models you can see in the webshop)		

			
1			
Part No.	692709	Ref. No.	69010210 LA69010210 LAR69010210
description	door handle complete 6303 L 170mm W 53mm H 68mm handle ø 37mm spring length 45mm mounting distance 39mm mounting thread M3		

			
1			
Part No.	692806	Ref. No.	69010290 69010460 LA69010230 LAR69010230 LAR69010290 LAR69010460
description	door handle for combi-steamer L 175mm W 100mm H 53mm spring length 42mm M4 black plastic round		

				
1				
Part No.	690336	Ref. No.	69010250 69010440 LA69010440 LAR69010250 LAR69010430 LAR69010440	
description	door handle L 195mm H 60mm mounting distance 40mm spring length 46mm ø 60mm black plastic round			
For models:	EMT06D, EPE056T, EPE086T, EPEV05T, EPEV08T, EPG056T, EPG086T, EPGV05T, EPGV08T, GEMT06P, GEMT06T, GEMT10P, GEMT10T, GEMT20P, GEMT20T, GEVT06P, GEVT06T, GEVT10P, GEVT10T, GEVT20P, GEVT20T, GGMT06P, GGMT06T, GGMT10P, GGMT10T, GGMT20P, GGMT20T, GGVT06P, GGVT06T, GGVT10P, GGVT10T, GGVT20P, GGVT20T, GMT06D, GMT20D, GMT20P, GVT06D, GVT20D, HME061P, HME061T, HME061X, HME101P, HME101T, HME101X, HME102P, HME102T, HME102X, HMG061P, HMG061T, HMG061X... (Other models you can see in the webshop)			
spare parts for	690336			
	Part No.	514390	Ref. No.	61620132 LA61620132 LAR61620132 R61620132
	spring for door handle ø 6mm L 54mm W 27.5mm			
	Part No.	691666	Ref. No.	—
	catch clamp length 46mm BL 31mm for off-set 59-69mm			
accessories for	690336			
	Part No.	690337	Ref. No.	69010630 LAR69010630 R69010630
	cover L 39.5mm ø 55.5mm			
	Part No.	690339	Ref. No.	69010270 LAR69010270 R69010270
	door catch with spigot 2-stage L 30mm H 17mm H1 18mm total length 55mm thread M8 thread L 20mm stainless steel			
	Part No.	694067	Ref. No.	69010260 LA69010260 LAR69010260 R69010260
	door catch with spigot 1-stage L 26mm total length 51mm thread M8			







			
1			
Part No.	514390	Ref. No.	61620132 LA61620132 LAR61620132
description	spring for door handle ø 6mm L 54mm W 27.5mm		
For models:	EMT06D, EPE056T, EPE086T, EPEV05T, EPEV08T, EPG056T, EPG086T, EPGV05T, EPGV08T, GEMT06P, GEMT06T, GEMT10P, GEMT10T, GEMT20P, GEMT20T, GEVT06P, GEVT06T, GEVT10P, GEVT10T, GEVT20P, GEVT20T, GGMT06P, GGMT06T, GGMT10P, GGMT10T, GGMT20P, GGMT20T, GGVTO6P, GGVTO6T, GGVT10P, GGVT10T, GGVT20P, GGVT20T, GMT20D, GMT20P, GVT06D, GVT20D, HME061P, HME061T, HME061X, HME101P, HME101T, HME101X, HME102P, HME102T, HME102X, HMG061P, HMG061T, HMG061X, HMG101P... (Other models you can see in the webshop)		

			
1			
Part No.	690091	Ref. No.	50202710 61620041 LA61620041 LAR50202710 LAR61620041
description	compression spring ø 12mm L 49mm wire gauge ø 1mm		
For models:	ACG10M, AVE07D, AVE10D, AVE10P, BPE044M, BPE044P, BPE054M, BPE054P, BPE064M, BPE064P, BPE074M, BPE074P, BPE084M, BPE084P, BPE104M, BPE104P, BPG044M, BPG044P, BPG054M, BPG054P, BPG064M, BPG064P, BPG074M, BPG074P, BPG084M, BPG084P, BPG104M, BPG104P, CE041M, CE051M, CE071M, CE100M, CE200M, CG051M, CG071M, CG100M, CG200M, CVE004H, CVE004M, CVE104H, CVE104M, CVE105H, CVE105M, CVG105H, CVG105M, EC106M, EC110M, EC210M, EM010M+SC, EM106H... (Other models you can see in the webshop)		

group 2			
			
1			
Part No.	690094	Ref. No.	50004040 58002160 LA58002160 LAR50004040 LAR58002160
description	bolt ø 4mm L 36mm		
For models:	ACG10M, AVE07D, AVE10D, AVE10P, BPE044M, BPE044P, BPE054M, BPE054P, BPE064M, BPE064P, BPE074M, BPE074P, BPE084M, BPE084P, BPE104M, BPE104P, BPG044M, BPG044P, BPG054M, BPG054P, BPG064M, BPG064P, BPG074M, BPG074P, BPG084M, BPG084P, BPG104M, BPG104P, CE041M, CE051M, CE071M, CE100M, CE200M, CG051M, CG071M, CG100M, CG200M, CVE004H, CVE004M, CVE104H, CVE104M, CVE105H, CVE105M, CVG105H, CVG105M, EC106M, EC110M, EC210M, EM010M+SC, EM106H... (Other models you can see in the webshop)		

			
1			
Part No.	692830	Ref. No.	10100100 LA10100100 LAR10100100
description	door catch for combi-steamer L 62mm mounting distance 46mm hole ø 6mm		
For models:	CVE004H, CVE004M, CVE104H, CVE104M, CVE105H, CVE105M, CVG105H, CVG105M, ME004L, ME004S, ME104L, ME104S, VE004D, VE004H, VE004M, VE004S, VE004X, VE104D, VE104H, VE104M, VE104S, VE104X, VE105D, VE105H, VE105M, VE105X, VE155H, VE155M, VE155X, VG105D, VG105H, VG105M, VG105X		

			
1			
Part No.	690093	Ref. No.	50004090 58005050 LAR50004090 LAR58005050
description	catch hook L 27mm W 12mm H 19.6mm hole ø 4mm		
For models:	ACG10M, AVE07D, AVE10D, AVE10P, BPE044M, BPE044P, BPE054M, BPE054P, BPE064M, BPE064P, BPE074M, BPE074P, BPE084M, BPE084P, BPE104M, BPE104P, BPG044M, BPG044P, BPG054M, BPG054P, BPG064M, BPG064P, BPG074M, BPG074P, BPG084M, BPG084P, BPG104M, BPG104P, CE041M, CE051M, CE071M, CE100M, CE200M, CG051M, CG071M, CG100M, CG200M, CVE004H, CVE004M, CVE104H, CVE104M, CVE105H, CVE105M, CVG105H, CVG105M, EC106M, EC110M, EC210M, EM010M+SC, EM106H... (Other models you can see in the webshop)		



spare parts for	692830			
	Part No.	690093	Ref. No.	50004090 58005050 LAR50004090 LAR58005050 R50004090 R58005050
catch hook L 27mm W 12mm H 19.6mm hole ø 4mm				
	Part No.	690094	Ref. No.	50004040 58002160 LA58002160 LAR50004040 LAR58002160 R50004040 R58002160
bolt ø 4mm L 36mm				
	Part No.	690095	Ref. No.	50001196 61620012 LA61620012 LAR50001196 LAR61620012 R50001196 R61620012
torsion spring ø 6mm L2 15mm wire gauge ø 0.9mm L1 2x6mm L3 15mm Qty 1 pcs for closing hub				



1 mechanical components, equipment accessories



			
1			
Part No.	691274	Ref. No.	18200940 LA18200940 LAR18200940
description	door catch H 33mm L 40mm W 25mm mounting distance 12mm		
For models:	BPE044M, BPE044P, BPE054M, BPE054P, BPG044M, BPG044P, BPG054M, BPG054P, CE041M, CE051M, CG051M, MACE04M, MACE05M, MACG05M, MCE042M, MCE051M, MCG051M, MVE042P, MVE051P, MVG051P, VE042P, VE051P, VE055P, VG051P		

			
2			
Part No.	691275	Ref. No.	18202020 LA18202020 LAR18202020
description	door catch H 45mm W 37mm mounting distance 12mm		
For models:	ACG10M, AVE07D, AVE10D, AVE10P, BPE064M, BPE064P, BPE074M, BPE074P, BPE084M, BPE084P, BPE104M, BPE104P, BPG064M, BPG064P, BPG074M, BPG074P, BPG084M, BPG084P, BPG104M, BPG104P, CE071M, CE100M, CE200M, CG071M, CG100M, CG200M, MACE07M, MACE10M, MACE20M, MACG07M, MACG10M, MACG20M, MCE071M, MCE101M, MCE102M, MCG071M, MCG101M, MCG102M, MME071P, MME101P, MME102P, MMG071P, MMG101P, MMG102P, MVE071M, MVE071P, MVE101M, MVE101P, MVE102P, MVG071P... (Other models you can see in the webshop)		

			
1			
Part No.	690092	Ref. No.	10100110 LAR10100110
description	door catch L 62mm W 35.5mm H 26.5mm mounting distance 19/46mm		
For models:	ACG10M, AVE07D, AVE10D, AVE10P, BPE044M, BPE044P, BPE054M, BPE054P, BPE064M, BPE064P, BPE074M, BPE074P, BPE084M, BPE084P, BPE104M, BPE104P, BPG044M, BPG044P, BPG054M, BPG054P, BPG064M, BPG064P, BPG074M, BPG074P, BPG084M, BPG084P, BPG104M, BPG104P, CE041M, CE051M, CE071M, CE100M, CE200M, CG051M, CG071M, CG100M, CG200M, EC106M, EC110M, EC210M, EM010M+SC, EM106H, EM106M, EM106M+SC, EM106P, EM110H, EM110M, EM110M+SC, EM110P, EM210H... (Other models you can see in the webshop)		
spare parts for	690092		
	Part No.	690093	Ref. No.
			50004090 58005050 LAR50004090 LAR58005050 R50004090 R58005050
	catch hook L 27mm W 12mm H 19.6mm hole ø 4mm		
	Part No.	690094	Ref. No.
			50004040 58002160 LA58002160 LAR50004040 LAR58002160 R50004040 R58002160
	bolt ø 4mm L 36mm		





spare parts for	690092		
	Part No.	690095	Ref. No.
			50001196 61620012 LA61620012 LAR50001196 LAR61620012 R50001196 R61620012
	torsion spring ø 6mm L2 15mm wire gauge ø 0.9mm L1 2x6mm L3 15mm Qty 1 pcs for closing hub		
accessories for	690092		
	Part No.	560370	Ref. No.
			—
	countersunk screw thread M5 L 16mm stainless steel DIN 965/ISO 7046 Qty 1 pcs intake Phillips head ø 9mm		

			
1			
Part No.	691279	Ref. No.	09200230 LAR09200230
description	door handle		
For models:	ACG10M, AVE07D, AVE10D, AVE10P, BPE044M, BPE044P, BPE054M, BPE054P, BPE064M, BPE064P, BPE074M, BPE074P, BPE084M, BPE084P, BPE104M, BPE104P, BPG044M, BPG044P, BPG054M, BPG054P, BPG064M, BPG064P, BPG074M, BPG074P, BPG084M, BPG084P, BPG104M, BPG104P, CE041M, CE051M, CE071M, CE100M, CE200M, CG051M, CG071M, CG100M, CG200M, CVE004H, CVE004M, CVE104H, CVE104M, CVE105H, CVE105M, CVG105H, CVG105M, EC106M, EC110M, EC210M, EM010M+SC, EM106H... (Other models you can see in the webshop)		

			
1			
Part No.	690088	Ref. No.	69015010 LAR69015010
description	door handle L 170mm handle ø 16mm spring length 49mm metal complete bolt ø 5mm bolt 13mm		
For models:	CVE004H, CVE004M, CVE104H, CVE104M, ME004L, ME004S, ME104L, ME104S, VE004D, VE004H, VE004M, VE004S, VE004X, VE104D, VE104H, VE104M, VE104S, VE104X		
spare parts for	690088		
	Part No.	690090	Ref. No.
			50004050 69031150 69031190 LA69031190 LAR50004050 LAR69031150 LAR69031190 R50004050 R69031150 R69031190
	push button ø 17mm L 16mm M6		

Table continues overleaf



spare parts for 690088			
	Part No.	690091	Ref. No.
			50202710 61620041 LA61620041 LAR50202710 LAR61620041 R50202710 R61620041
compression spring ø 12mm L 49mm wire gauge ø 1mm			
	Part No.	691279	Ref. No.
			09200230 LAR09200230 R09200230
door handle			
	Part No.	691280	Ref. No.
			58005340 LA58005340 LAR58005340 R58005340
sealing disc for door handle mounting pos. lower ED ø 25mm ID ø 5.5mm H 5mm			
	Part No.	691282	Ref. No.
			58005350 LA58005350 LAR58005350 R58005350
gasket for door handle D1 ø 30mm D2 ø 18mm mounting pos. upper H 1.4mm			
	Part No.	691289	Ref. No.
			58004830 LAR58004830 R58004830
nut thread M18x1 H 5mm WS 22 brass Qty 1 pcs for door handle			
accessories for 690088			
	Part No.	691281	Ref. No.
			58004270 LAR58004270 R58004270
spacer piece for door handle L 34mm ID ø 6mm ED ø 8mm			
	Part No.	692830	Ref. No.
			10100100 LA10100100 LAR10100100 R10100100
door catch for combi-steamer L 62mm mounting distance 46mm hole ø 6mm			













 <p>1</p>			
Part No.	690087	Ref. No.	69015000 LAR69015000
description	door handle L 170mm handle ø 16mm spring length 49mm metal complete bolt ø 5mm bolt 16mm		
For models:	ACG10M, AVE07D, AVE10D, AVE10P, BPE044M, BPE044P, BPE054M, BPE054P, BPE064M, BPE064P, BPE074M, BPE074P, BPE084M, BPE084P, BPE104M, BPE104P, BPG044M, BPG044P, BPG054M, BPG054P, BPG064M, BPG064P, BPG074M, BPG074P, BPG084M, BPG084P, BPG104M, BPG104P, CE041M, CE051M, CE071M, CE100M, CE200M, CG051M, CG071M, CG100M, CG200M, CVE105H, CVE105M, CVG105H, CVG105M, FE105M, FE105X, FE110M, FE110X, FE210M, FG051M, FG051X, FG101M, FG101X...(Other models you can see in the web-shop)		
spare parts for 690087			
	Part No.	690090	Ref. No.
			50004050 69031150 69031190 LA69031190 LAR50004050 LAR69031150 LAR69031190 R50004050 R69031150 R69031190
push button ø 17mm L 16mm M6			
	Part No.	690091	Ref. No.
			50202710 61620041 LA61620041 LAR50202710 LAR61620041 R50202710 R61620041
compression spring ø 12mm L 49mm wire gauge ø 1mm			
	Part No.	691279	Ref. No.
			09200230 LAR09200230 R09200230
door handle			
	Part No.	691280	Ref. No.
			58005340 LA58005340 LAR58005340 R58005340
sealing disc for door handle mounting pos. lower ED ø 25mm ID ø 5.5mm H 5mm			
	Part No.	691282	Ref. No.
			58005350 LA58005350 LAR58005350 R58005350
gasket for door handle D1 ø 30mm D2 ø 18mm mounting pos. upper H 1.4mm			
	Part No.	691283	Ref. No.
			58003240 LAR58003240 R58003240
pressure bolt for door handle D1 ø 8mm D2 ø 11mm L 73mm thread M6 bolt 16mm bolt ø 5mm			
	Part No.	691289	Ref. No.
			58004830 LAR58004830 R58004830
nut thread M18x1 H 5mm WS 22 brass Qty 1 pcs for door handle			

Table continues overleaf

1 mechanical components, equipment accessories





accessories for		690087	
	Part No.	690092	Ref. No. 10100110 LAR10100110 R10100110
door catch L 62mm W 35.5mm H 26.5mm mounting distance 19/46mm			
	Part No.	691274	Ref. No. 18200940 LA18200940 LAR18200940 R18200940
door catch H 33mm L 40mm W 25mm mounting distance 12mm			
	Part No.	691275	Ref. No. 18202020 LA18202020 LAR18202020 R18202020
door catch H 45mm W 37mm mounting distance 12mm			
	Part No.	691281	Ref. No. 58004270 LAR58004270 R58004270
spacer piece for door handle L 34mm ID ø 6mm ED ø 8mm			

	1		
Part No.	691282	Ref. No.	58005350 LA58005350 LAR58005350
description gasket for door handle D1 ø 30mm D2 ø 18mm mounting pos. upper H 1.4mm			
For models: ACG10M, AVE07D, AVE10D, AVE10P, BPE044M, BPE044P, BPE054M, BPE054P, BPE064M, BPE064P, BPE074M, BPE074P, BPE084M, BPE084P, BPE104M, BPE104P, BPG044M, BPG044P, BPG054M, BPG054P, BPG064M, BPG064P, BPG074M, BPG074P, BPG084M, BPG084P, BPG104M, BPG104P, CE041M, CE051M, CE071M, CE100M, CE200M, CG051M, CG071M, CG100M, CG200M, CVE004H, CVE004M, CVE104H, CVE104M, CVE105H, CVE105M, CVG105H, CVG105M, EC106M, EC110M, EC210M, EM010M+SC, EM106H... (Other models you can see in the webshop)			

	1		
Part No.	690597	Ref. No.	58002760 LAR58002760
description hook L 33.6mm W 25mm H 25mm mounting distance 12mm			
For models: CVE105H, CVE105M, CVG105H, CVG105M, EC106M, EC110M, EC210M, EM010M+SC, EM106H, EM106M, EM106M+SC, EM106P, EM110H, EM110M, EM110M+SC, EM110P, EM210H, EM210M, EM210M+SC, EM210P, EV006M, EV106H, EV106M, EV106M+SC, EV106P, EV110H, EV110M, EV110M+SC, EV110P, EV210H, EV210M, EV210M+SC, EV210P, FE105M, FE105X, FE110M, FE110X, FE210M, FG051M, FG051X, FG101M, FG101X, FG105M, FG105X, FG110M, FG110X, FG210M, FG210X, GC106M, GC110M... (Other models you can see in the webshop)			

	1		
Part No.	691289	Ref. No.	58004830 LAR58004830
description nut thread M18x1 H 5mm WS 22 brass Qty 1 pcs for door handle			
For models: ACG10M, AVE07D, AVE10D, AVE10P, BPE044M, BPE044P, BPE054M, BPE054P, BPE064M, BPE064P, BPE074M, BPE074P, BPE084M, BPE084P, BPE104M, BPE104P, BPG044M, BPG044P, BPG054M, BPG054P, BPG064M, BPG064P, BPG074M, BPG074P, BPG084M, BPG084P, BPG104M, BPG104P, CE041M, CE051M, CE071M, CE100M, CE200M, CG051M, CG071M, CG100M, CG200M, CVE004H, CVE004M, CVE104H, CVE104M, CVE105H, CVE105M, CVG105H, CVG105M, EC106M, EC110M, EC210M, EM010M+SC, EM106H... (Other models you can see in the webshop)			

	1		
Part No.	691283	Ref. No.	58003240 LAR58003240
description pressure bolt for door handle D1 ø 8mm D2 ø 11mm L 73mm thread M6 bolt 16mm bolt ø 5mm			
For models: ACG10M, AVE07D, AVE10D, AVE10P, BPE044M, BPE044P, BPE054M, BPE054P, BPE064M, BPE064P, BPE074M, BPE074P, BPE084M, BPE084P, BPE104M, BPE104P, BPG044M, BPG044P, BPG054M, BPG054P, BPG064M, BPG064P, BPG074M, BPG074P, BPG084M, BPG084P, BPG104M, BPG104P, CE041M, CE051M, CE071M, CE100M, CE200M, CG051M, CG071M, CG100M, CG200M, CVE105H, CVE105M, CVG105H, CVG105M, FE105M, FE105X, FE110M, FE110X, FE210M, FG051M, FG051X, FG101M, FG101X... (Other models you can see in the web-shop)			

	1		
Part No.	690090	Ref. No.	50004050 69031150 69031190 LA69031190 LAR50004050 LAR69031150 LAR69031190
description push button ø 17mm L 16mm M6			
For models: ACG10M, AVE07D, AVE10D, AVE10P, BPE044M, BPE044P, BPE054M, BPE054P, BPE064M, BPE064P, BPE074M, BPE074P, BPE084M, BPE084P, BPE104M, BPE104P, BPG044M, BPG044P, BPG054M, BPG054P, BPG064M, BPG064P, BPG074M, BPG074P, BPG084M, BPG084P, BPG104M, BPG104P, CE041M, CE051M, CE071M, CE100M, CE200M, CG051M, CG071M, CG100M, CG200M, CVE004H, CVE004M, CVE104H, CVE104M, CVE105H, CVE105M, CVG105H, CVG105M, EC106M, EC110M, EC210M, EM010M+SC, EM106H... (Other models you can see in the webshop)			



 <p>1</p>			
Part No.	691280	Ref. No.	58005340 LA58005340 LAR58005340
description	sealing disc for door handle mounting pos. lower ED ø 25mm ID ø 5.5mm H 5mm		
For models:	ACG10M, AVE07D, AVE10D, AVE10P, BPE044M, BPE044P, BPE054M, BPE054P, BPE064M, BPE064P, BPE074M, BPE074P, BPE084M, BPE084P, BPE104M, BPE104P, BPG044M, BPG044P, BPG054M, BPG054P, BPG064M, BPG064P, BPG074M, BPG074P, BPG084M, BPG084P, BPG104M, BPG104P, CE041M, CE051M, CE071M, CE100M, CE200M, CG051M, CG071M, CG100M, CG200M, CVE004H, CVE004M, CVE104H, CVE104M, CVE105H, CVE105M, CVG105H, CVG105M, EC106M, EC110M, EC210M, EM010M+SC, EM106H... (Other models you can see in the webshop)		

 <p>2</p>			
Part No.	691281	Ref. No.	58004270 LAR58004270
description	spacer piece for door handle L 34mm ID ø 6mm ED ø 8mm		
For models:	ACG10M, AVE07D, AVE10D, AVE10P, BPE044M, BPE044P, BPE054M, BPE054P, BPE064M, BPE064P, BPE074M, BPE074P, BPE084M, BPE084P, BPE104M, BPE104P, BPG044M, BPG044P, BPG054M, BPG054P, BPG064M, BPG064P, BPG074M, BPG074P, BPG084M, BPG084P, BPG104M, BPG104P, CE041M, CE051M, CE071M, CE100M, CE200M, CG051M, CG071M, CG100M, CG200M, CVE004H, CVE004M, CVE104H, CVE104M, CVE105H, CVE105M, CVG105H, CVG105M, FE105M, FE105X, FE110M, FE110X, FE210M... (Other models you can see in the webshop)		



 <p>1</p>			
Part No.	690095	Ref. No.	50001196 61620012 LA61620012 LAR50001196 LAR61620012
description	torsion spring ø 6mm L2 15mm wire gauge ø 0.9mm L1 2x6mm L3 15mm Qty 1 pcs for closing hub		
For models:	ACG10M, AVE07D, AVE10D, AVE10P, BPE044M, BPE044P, BPE054M, BPE054P, BPE064M, BPE064P, BPE074M, BPE074P, BPE084M, BPE084P, BPE104M, BPE104P, BPG044M, BPG044P, BPG054M, BPG054P, BPG064M, BPG064P, BPG074M, BPG074P, BPG084M, BPG084P, BPG104M, BPG104P, CE041M, CE051M, CE071M, CE100M, CE200M, CG051M, CG071M, CG100M, CG200M, CVE004H, CVE004M, CVE104H, CVE104M, CVE105H, CVE105M, CVG105H, CVG105M, EC106M, EC110M, EC210M, EM010M+SC, EM106H... (Other models you can see in the webshop)		

edgmount latches

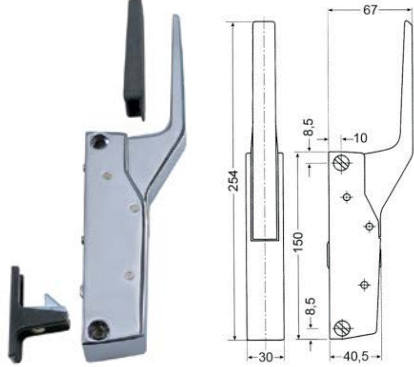

handle latches

CAFF/FERMOD

 <p>1</p>			
Part No.	701024	Ref. No.	69010010 69010320 LA69010010 LAR69010010 LAR69010320
description	handle latch L 150mm mounting distance 133mm heated units type 790		
For models:	A05PES, A05RES, A05RES+UM, A08RES, A08RES+UM, A10RES, A10RES+UM		
spare parts for	701024		

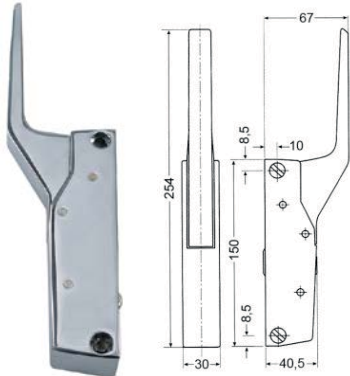
			
Part No.	700061	Ref. No.	69015020
description	door catch L 58mm W 20mm H 35mm mounting distance 42mm chrome-plated brass for headed units		
			
Part No.	700062	Ref. No.	—
description	handle protection heated units		

 <p>1</p>			
Part No.	700060	Ref. No.	A33200310
description	handle latch L 150mm mounting distance 133mm non lockable heated units G 791		
For models:	RB072E, RB102S, RC162M, RM262E, RM262M		
accessories for	700060		





			
Part No.	700061	Ref. No.	69015020
description	door catch L 58mm W 20mm H 35mm mounting distance 42mm chrome-plated brass for headed units		
			
Part No.	700062	Ref. No.	—
description	handle protection heated units		

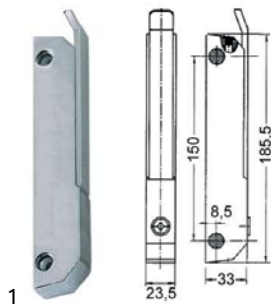

RAHRBACH

6188 ERGO series



Part No.	700081	Ref. No.	50103010 69010030 LAR50103010 LAR69010030
description	handle latch L 185mm mounting distance 150mm chrome-plated non lockable refrigeration units 6188		
For models:	FV03, FV06		
accessories for	700081		
	Part No.	690110	Ref. No. —
	base plate H 1mm L 38mm W 11mm mounting distance 26mm plastic		
	Part No.	690111	Ref. No. —
	base plate H 2mm L 38mm W 11mm mounting distance 26mm plastic		
	Part No.	690114	Ref. No. —
	base plate H 3.5mm L 185mm W 30mm mounting distance 150mm with inclination thread M5		
	Part No.	700082	Ref. No. 50103020 69010500 LAR50103020 LAR69010500 R50103020 R69010500
	door catch L 38mm W 18mm mounting distance 26mm		

door catches



Part No.	700082	Ref. No.	50103020 69010500 LAR50103020 LAR69010500
description	door catch L 38mm W 18mm mounting distance 26mm		
For models:	FV03, FV06		



Part No.	700061	Ref. No.	69015020
description	door catch L 58mm W 20mm H 35mm mounting distance 42mm chrome-plated brass for headed units		
accessories for	700061		
	Part No.	690414	Ref. No. —
	handle latch L 150mm mounting distance 133mm non lockable refrigeration units G 791		

walk-in fridge catches

INTERKLIMAT

7000 series

locks



Part No.	694920	Ref. No.	965180 FR965180
description	walk-in fridge catch type 7325 door thickness 70-80mm L 243mm W 167mm H 60mm lockable		

snap locks

universal



Part No.	690596	Ref. No.	50103110 69050010 LA69050010 LAR50103110 LAR69050010
description	snap lock L 60mm W 15mm H 36mm mounting distance 48/28mm spring thickness 1.5mm complete with door catch zamak		
For models:	FE05, FG05, ME05, ME10, ME20, MG05, MG10, MG20, MME10, PE04, PE08, PG04, PG08, RE05, RE07, RE10, RE20, RG05, RG07, RG10, RG20		



producer-specific			
LAINOX			
			
1			
Part No.	694586	Ref. No.	69050020 LAR69050020 RZ960029 SIRRZ960029
description	snap lock repair set		
For models:	DP112S		

espagnolette locks			
producer-specific			
LAINOX			
group 1			
			
1			
Part No.	690591	Ref. No.	03200970 50001190 58003150 LA03200970 LAR03200970 LAR50001190 LAR58003150
description	base plate H 12mm L 60mm W 45mm mounting distance 30/40mm hole ø 12mm		
For models:	CGC24M, CGC40M, EPE156T, EPEV15T, EPG156T, EPGV15T, GEMT21P, GEMT21T, GEMT40P, GEMT40T, GEVT21P, GEVT21T, GEVT40P, GEVT40T, GGMT21P, GGMT21T, GGMT40P, GGMT40T, GGV21P, GGV21T, GGV40P, GGV40T, HME201P, HME201T, HME201X, HME202P, HME202T, HME202X, HMG201P, HMG201T, HMG201X, HMG202P, HMG202T, HMG202X, HVE201P, HVE201T, HVE201X, HVE202P, HVE202T, HVE202X, HVG201P, HVG201T, HVG201X, HVG202P, HVG202T, HVG202X, MCE201M, MCE202M, MCG201M, MCG202M...(Other models you can see in the webshop)		

			
1			
Part No.	694990	Ref. No.	11205340 LAR11205340
description	cross bar with coupling for espagnolette lock		
For models:	EPE156T, EPEV15T, EPG156T, EPGV15T, GEMT21P, GEMT21T, GEMT40P, GEMT40T, GEVT21P, GEVT21T, GEVT40P, GEVT40T, GGMT21P, GGMT21T, GGMT40P, GGMT40T, GGV21P, GGV21T, GGV40P, GGV40T, HME201P, HME201T, HME201X, HME202P, HME202T, HME202X, HMG201P, HMG201T, HMG201X, HMG202P, HMG202T, HMG202X, HVE201P, HVE201T, HVE201X, HVE202P, HVE202T, HVE202X, HVG201P, HVG201T, HVG201X, HVG202P, HVG202T, HVG202X, MCE201M, MCE202M, MCG201M, MCG202M, ME201D, ME201H...(Other models you can see in the webshop)		











			
1			
Part No.	694316	Ref. No.	11100310 11100340 LAR11100310 LAR11100340
description	door handle for espagnolette lock L 205mm H 65mm handle ø 60mm		
For models:	EPE156T, EPEV15T, EPG156T, EPGV15T, GEMT21P, GEMT21T, GEMT40P, GEMT40T, GEVT21P, GEVT21T, GEVT40P, GEVT40T, GGMT21P, GGMT21T, GGMT40P, GGMT40T, GGV21P, GGV21T, GGV40P, GGV40T, HME201P, HME201T, HME201X, HME202P, HME202T, HME202X, HMG201P, HMG201T, HMG201X, HMG202P, HMG202T, HMG202X, HVE201P, HVE201T, HVE201X, HVE202P, HVE202T, HVE202X, HVG201P, HVG201T, HVG201X, HVG202P, HVG202T, HVG202X, MCE201M, MCE202M, MCG201M, MCG202M, ME201D, ME201H...(Other models you can see in the webshop)		
spare parts for	694316		
	Part No.	560289	Ref. No. —
	side bolts thread M6 L 12mm SS Qty 1 pcs intake Phillips head ø 12.6mm		
	Part No.	560540	Ref. No. —
	countersunk screw ø 5mm L 120mm SS Qty 1 pcs intake Phillips for door handle		
	Part No.	560542	Ref. No. —
	grub screw thread M6 L 16mm in stainless steel DIN 916/ISO 4029 intake internal hexagon WS 3 Qty 1 pcs		
	Part No.	690591	Ref. No. 03200970 50001190 58003150 LA03200970 LAR03200970 LAR50001190 LAR58003150 R03200970 R50001190 R58003150
	base plate H 12mm L 60mm W 45mm mounting distance 30/40mm hole ø 12mm		
	Part No.	694611	Ref. No. 69010600 69010640 LAR69010600 LAR69010640 R69010600
	tap head for door handle ø 60mm grey L 105mm W 60mm H 65mm		
	Part No.	694624	Ref. No. 69010610 69010650 LAR69010610 LAR69010650 R69010610
	door handle L 185mm handle ø 28mm screw mounting dark grey plastic hole ø 6mm		
	Part No.	694625	Ref. No. —
	coupling for door handle ø 20mm L 28mm hole ø 11mm		
	Part No.	694626	Ref. No. —
	cross bar H 17mm L 107mm W 50mm for espagnolette lock mounting distance 40mm D1 ø 11mm D2 ø 12mm		
	Part No.	694627	Ref. No. —
	thread bolt L 13.5mm for espagnolette lock D1 ø 11mm D2 ø 10mm thread M6		

Table continues overleaf



spare parts for 694316			
	Part No. 694630	Ref. No.	—
bush H 9mm for espagnolette lock ID ø 10mm ED ø 14mm			



Part No. 694624	Ref. No.	69010610 69010650 LAR69010610 LAR69010650
------------------------	-----------------	--

description door handle L 185mm handle ø 28mm screw mounting dark grey plastic hole ø 6mm

For models: EPE156T, EPEV15T, EPG156T, EPGV15T, GEMT21P, GEMT21T, GEMT40P, GEMT40T, GEVT21P, GEVT21T, GEVT40P, GEVT40T, GGMT21P, GGMT21T, GGMT40P, GGMT40T, GGVT21P, GGVT21T, GGVT40P, GGVT40T, HME201P, HME201T, HME201X, HME202P, HME202T, HME202X, HMG201P, HMG201T, HMG201X, HMG202P, HMG202T, HMG202X, HVE201P, HVE201T, HVE201X, HVE202P, HVE202T, HVE202X, HVG201P, HVG201T, HVG201X, HVG202P, HVG202T, HVG202X, MCE201M, MCE202M, MCG201M, MCG202M, ME201D, ME201H...(Other models you can see in the webshop)

spare parts for 694624

	Part No. 560540	Ref. No.	—
countersunk screw ø 5mm L 120mm SS Qty 1 pcs intake Phillips for door handle			

accessories for 694624

	Part No. 560540	Ref. No.	—
countersunk screw ø 5mm L 120mm SS Qty 1 pcs intake Phillips for door handle			

	Part No. 694611	Ref. No.	69010600 69010640 LAR69010600 LAR69010640 R69010600
tap head for door handle ø 60mm grey L 105mm W 60mm H 65mm			

	Part No. 694625	Ref. No.	—
coupling for door handle ø 20mm L 28mm hole ø 11mm			

	Part No. 694626	Ref. No.	—
cross bar H 17mm L 107mm W 50mm for espagnolette lock mounting distance 40mm D1 ø 11mm D2 ø 12mm			

	Part No. 694630	Ref. No.	—
bush H 9mm for espagnolette lock ID ø 10mm ED ø 14mm			

	Part No. 560541	Ref. No.	61040272 LA61050102 LAR61040272
description raised countersunk head screw thread M6 thread L 13mm SS DIN 966/ISO 7047 Qty 1 pcs intake slotted head ø 11mm head thickness 5mm			
For models: CGC24M, CGC40M, EPE156T, EPEV15T, EPG156T, EPGV15T, GEMT21P, GEMT21T, GEMT40P, GEMT40T, GEVT21P, GEVT21T, GEVT40P, GEVT40T, GGMT21P, GGMT21T, GGMT40P, GGMT40T, GGVT21P, GGVT21T, GGVT40P, GGVT40T, HME201P, HME201T, HME201X, HME202P, HME202T, HME202X, HMG201P, HMG201T, HMG201X, HMG202P, HMG202T, HMG202X, HVE201P, HVE201T, HVE201X, HVE202P, HVE202T, HVE202X, HVG201P, HVG201T, HVG201X, HVG202P, HVG202T, HVG202X, MCE201M, MCE202M, MCG201M, MCG202M...(Other models you can see in the webshop)			





Part No. 694611	Ref. No.	69010600 69010640 LAR69010600 LAR69010640
------------------------	-----------------	--

description tap head for door handle ø 60mm grey L 105mm W 60mm H 65mm

For models: EPE156T, EPEV15T, EPG156T, EPGV15T, GEMT21P, GEMT21T, GEMT40P, GEMT40T, GEVT21P, GEVT21T, GEVT40P, GEVT40T, GGMT21P, GGMT21T, GGMT40P, GGMT40T, GGVT21P, GGVT21T, GGVT40P, GGVT40T, HME201P, HME201T, HME201X, HME202P, HME202T, HME202X, HMG201P, HMG201T, HMG201X, HMG202P, HMG202T, HMG202X, HVE201P, HVE201T, HVE201X, HVE202P, HVE202T, HVE202X, HVG201P, HVG201T, HVG201X, HVG202P, HVG202T, HVG202X, MCE201M, MCE202M, MCG201M, MCG202M, ME201D, ME201H...(Other models you can see in the webshop)

accessories for 694611

	Part No. 560540	Ref. No.	—
countersunk screw ø 5mm L 120mm SS Qty 1 pcs intake Phillips for door handle			

	Part No. 694624	Ref. No.	69010610 69010650 LAR69010610 LAR69010650 R69010610
door handle L 185mm handle ø 28mm screw mounting dark grey plastic hole ø 6mm			

	Part No. 694625	Ref. No.	—
coupling for door handle ø 20mm L 28mm hole ø 11mm			

	Part No. 694626	Ref. No.	—
cross bar H 17mm L 107mm W 50mm for espagnolette lock mounting distance 40mm D1 ø 11mm D2 ø 12mm			





group 2			
 <p>1</p>			
Part No.	690591	Ref. No.	03200970 50001190 58003150 LA03200970 LAR03200970 LAR50001190 LAR58003150
description	base plate H 12mm L 60mm W 45mm mounting distance 30/40mm hole ø 12mm		
For models:	CGC24M, CGC40M, EPE156T, EPEV15T, EPG156T, EPGV15T, GEMT21P, GEMT21T, GEMT40P, GEMT40T, GEVT21P, GEVT21T, GEVT40P, GEVT40T, GGMT21P, GGMT21T, GGMT40P, GGMT40T, GGVT21P, GGVT21T, GGVT40P, GGVT40T, HME201P, HME201T, HME201X, HME202P, HME202T, HME202X, HMG201P, HMG201T, HMG201X, HMG202P, HMG202T, HMG202X, HVE201P, HVE201T, HVE201X, HVE202P, HVE202T, HVE202X, HVG201P, HVG201T, HVG201X, HVG202P, HVG202T, HVG202X, MCE201M, MCE202M, MCG201M, MCG202M...(Other models you can see in the webshop)		

 <p>2</p>			
Part No.	690589	Ref. No.	50001140 58000990 LAR50001140 LAR58000990
description	bush for door mechanism L 18mm ED ø 22mm ID ø 12mm D1 ø 20mm		
For models:	ME15, ME21, ME24, ME40, MG15, MG21, MG24, MG40, MME40, PE12, PG12, RE24, RG24, RG40		

 <p>1</p>			
Part No.	690590	Ref. No.	50001160 58004780 LAR50001160 LAR58004780
description	catch hook L 13mm ø 12mm M6 bolt ø 10mm		
For models:	ME120L, ME120S, ME120T, ME15, ME21, ME220L, ME220S, ME220T, ME24, ME40, MG120L, MG120S, MG120T, MG15, MG21, MG220L, MG220S, MG220T, MG24, MG40, MME40, PE12, PG12, RE24, RG24, RG40, VE120L, VE120S		

 <p>1</p>			
Part No.	690599	Ref. No.	03200950 50001170 LAR03200950 LAR50001170
description	closing rod		
For models:	ME15, ME21, ME24, ME40, MG15, MG21, MG24, MG40, MME40, PE12, PG12, RE24, RG24, RG40		

 <p>1</p>			
Part No.	694315	Ref. No.	10202960 LA10202960 LAR10202960
description	closing rod ø 12mm L 755mm		
For models:	CGC40M, ME120D, ME120H, ME120L, ME120M, ME120P, ME120S, ME120T, ME120X, ME220D, ME220H, ME220L, ME220M, ME220P, ME220S, ME220T, ME220X, MEC20H, MEC20P, MEC20X, MEC40H, MEC40M, MEK21H, MG120D, MG120H, MG120L, MG120M, MG120P, MG120S, MG120T, MG120X, MG220D, MG220H, MG220L, MG220M, MG220P, MG220S, MG220T, MG220X, MGC20H, MGC20X, MGC40H, MGC40P, PE015M, PE115K, PG015M, PG115M, VE120D, VE120H, VE120L...(Other models you can see in the webshop)		

 <p>1</p>			
Part No.	694314	Ref. No.	10202950 LA10202950 LAR10202950
description	closing rod ø 12mm L 785mm		
For models:	CGC40M, ME120D, ME120H, ME120L, ME120M, ME120P, ME120S, ME120T, ME120X, ME220D, ME220H, ME220L, ME220M, ME220P, ME220S, ME220T, ME220X, MEC20H, MEC20P, MEC20X, MEC40H, MEC40M, MEK21H, MG120D, MG120H, MG120L, MG120M, MG120P, MG120S, MG120T, MG120X, MG220D, MG220H, MG220L, MG220M, MG220P, MG220S, MG220T, MG220X, MGC20H, MGC20X, MGC40H, MGC40P, PE015M, PE115K, PG015M, PG115M, VE120D, VE120H, VE120L...(Other models you can see in the webshop)		

 <p>1</p>			
Part No.	694286	Ref. No.	11205381 LA11205381 LAR11205381
description	closing rod ø 12mm L 820mm		
For models:	EPE156T, EPEV15T, EPG156T, EPGV15T, GEMT21P, GEMT21T, GEMT40P, GEMT40T, GEVT21P, GEVT21T, GEVT40P, GEVT40T, GGMT21P, GGMT21T, GGMT40P, GGMT40T, GGVT21P, GGVT21T, GGVT40P, GGVT40T, HME201P, HME201T, HME201X, HME202P, HME202T, HME202X, HMG201P, HMG201T, HMG201X, HMG202P, HMG202T, HMG202X, HVE201P, HVE201T, HVE201X, HVE202P, HVE202T, HVE202X, HVG201P, HVG201T, HVG201X, HVG202P, HVG202T, HVG202X, MCE201M, MCE202M, MCG201M, MCG202M, ME201D, ME201H...(Other models you can see in the webshop)		

 <p>1</p>			
Part No.	694285	Ref. No.	11205370 LA11205370 LAR11205370
description	closing rod ø 12mm L 840mm		
For models:	EPE156T, EPEV15T, EPG156T, EPGV15T, GEMT21P, GEMT21T, GEMT40P, GEMT40T, GEVT21P, GEVT21T, GEVT40P, GEVT40T, GGMT21P, GGMT21T, GGMT40P, GGMT40T, GGVT21P, GGVT21T, GGVT40P, GGVT40T, HME201P, HME201T, HME201X, HME202P, HME202T, HME202X, HMG201P, HMG201T, HMG201X, HMG202P, HMG202T, HMG202X, HVE201P, HVE201T, HVE201X, HVE202P, HVE202T, HVE202X, HVG201P, HVG201T, HVG201X, HVG202P, HVG202T, HVG202X, MCE201M, MCE202M, MCG201M, MCG202M, ME201D, ME201H...(Other models you can see in the webshop)		







			
1			
Part No.	690089	Ref. No.	69015050 LAR69015050
description	door handle L 155mm W 75mm handle ø 40mm stainless steel complete mounting distance 30mm		
For models:	CGC24M, CGC40M, ME120D, ME120H, ME120M, ME120P, ME120X, ME220D, ME220H, ME220M, ME220P, ME220X, MEC20H, MEC20P, MEC20X, MEC24H, MEC40H, MEC40M, MEK21H, MG120D, MG120H, MG120M, MG120P, MG120X, MG220D, MG220H, MG220M, MG220P, MG220X, MGC20H, MGC20X, MGC24H, MGC40H, MGC40P, VE120D, VE120H, VE120M, VE120P, VE120X, VE220D, VE220H, VE220M, VE220P, VE220X, VEC20P, VES40M, VG120D, VG120H, VG120M, VG120P...(Other models you can see in the webshop)		

			
1			
Part No.	690562	Ref. No.	58003180 LAR58003180
description	door handle metal		
For models:	CGC24M, CGC40M, ME120D, ME120H, ME120L, ME120M, ME120P, ME120S, ME120T, ME120X, ME220D, ME220H, ME220L, ME220M, ME220P, ME220S, ME220T, ME220X, MEC20H, MEC20P, MEC20X, MEC24H, MEC40H, MEC40M, MEK21H, MG120D, MG120H, MG120M, MG120P, MG120T, MG120X, MG220D, MG220H, MG220L, MG220M, MG220P, MG220S, MG220T, MG220X, MGC20H, MGC20X, MGC24H, MGC40H, MGC40P, VE120D, VE120H, VE120L, VE120M, VE120P, VE120S...(Other models you can see in the webshop)		

			
1			
Part No.	690588	Ref. No.	50001150 58003170 LAR50001150 LAR58003170
description	door handle metal		
For models:	ME120L, ME120S, ME15, ME21, ME24, ME40, MG15, MG21, MG24, MG40, MME40, PE12, PG12, RE24, RG24, RG40		

			
1			
Part No.	560024	Ref. No.	61090052 LA61090052 LAR61090052
description	grub screw thread M6 L 16mm SS DIN 913/ISO 4026 intake internal hexagon WS 3 Qty 20 pcs		
For models:	CGC24M, CGC40M, EPE156T, EPEV15T, EPG156T, EPGV15T, GEMT21P, GEMT21T, GEMT40P, GEMT40T, GEVT21P, GEVT21T, GEVT40P, GEVT40T, GGMT21P, GGMT21T, GGMT40P, GGMT40T, GGV21P, GGV21T, GGV24P, GGV24T, HME201P, HME201T, HME201X, HME202P, HME202T, HME202X, HMG201P, HMG201T, HMG201X, HMG202P, HMG202T, HMG202X, HVE201P, HVE201T, HVE201X, HVE202P, HVE202T, HVE202X, HVG201P, HVG201T, HVG201X, HVG202P, HVG202T, HVG202X, MCE201M, MCE202M, MCG201M, MCG202M...(Other models you can see in the webshop)		

			
1			
Part No.	694317	Ref. No.	58004781 LAR58004781
description	hook for door bolt M6		
For models:	CGC24M, CGC40M, EPE156T, EPEV15T, EPG156T, EPGV15T, GEMT21P, GEMT21T, GEMT40P, GEMT40T, GEVT21P, GEVT21T, GEVT40P, GEVT40T, GGMT21P, GGMT21T, GGMT40P, GGMT40T, GGV21P, GGV21T, GGV24P, GGV24T, HME201P, HME201T, HME201X, HME202P, HME202T, HME202X, HMG201P, HMG201T, HMG201X, HMG202P, HMG202T, HMG202X, HVE201P, HVE201T, HVE201X, HVE202P, HVE202T, HVE202X, HVG201P, HVG201T, HVG201X, HVG202P, HVG202T, HVG202X, MCE201M, MCE202M, MCG201M, MCG202M...(Other models you can see in the webshop)		
spare parts for	694317		
	Part No.	694627	Ref. No. —
	thread bolt L 13.5mm for espagnolette lock D1 ø 11mm D2 ø 10mm thread M6		
	Part No.	694630	Ref. No. —
	bush H 9mm for espagnolette lock ID ø 10mm ED ø 14mm		

			
1			
Part No.	697933	Ref. No.	61420021 LAR61420021
description	spring washer ID ø 13mm ED ø 24mm Qty 1 pcs		
For models:	CGC24M, CGC40M, EPE156T, EPEV15T, EPG156T, EPGV15T, GEMT21P, GEMT21T, GEMT40P, GEMT40T, GEVT21P, GEVT21T, GEVT40P, GEVT40T, GGMT21P, GGMT21T, GGMT40P, GGMT40T, GGV21P, GGV21T, GGV24P, GGV24T, HME201P, HME201T, HME201X, HME202P, HME202T, HME202X, HMG201P, HMG201T, HMG201X, HMG202P, HMG202T, HMG202X, HVE201P, HVE201T, HVE201X, HVE202P, HVE202T, HVE202X, HVG201P, HVG201T, HVG201X, HVG202P, HVG202T, HVG202X, MCE201M, MCE202M, MCG201M, MCG202M...(Other models you can see in the webshop)		

			
1			
Part No.	697934	Ref. No.	67011050 LAR67011050
description	sticker for door handle ø 20mm dark blue		
For models:	LA16, LV16, PE015M, PE115K, PG015M, PG115M		

miscellaneous

			
1			
Part No.	691286	Ref. No.	58001780 LAR58001780
description	catch for glass plate		
For models:	ACG10M, AVE07D, AVE10D, AVE10P, BPE064M, BPE064P, BPE074M, BPE074P, BPE084M, BPE084P, BPE104M, BPE104P, BPG064M, BPG064P, BPG074M, BPG074P, BPG084M, BPG084P, BPG104M, BPG104P, CE071M, CE100M, CE200M, CG071M, CG100M, CG200M, EMT06D, EPE056T, EPE086T, EPE156T, EPEV05T, EPEV08T, EPEV15T, EPG056T, EPG086T, EPG156T, EPGV05T, EPGV08T, EPGV15T, GEMT06P, GEMT06T, GEMT10P, GEMT10T, GEMT20P, GEMT20T, GEMT21P, GEMT21T, GEMT40P, GEMT40T, GEVT06P...(Other models you can see in the webshop)		



hinges

edgemount hinges

CAFF/FERMOD

Part No.	690431	Ref. No.	A33200080 LA69010330 LAR69010330
description	edgemount hinge L 100mm W 25mm mounting distance 60mm hinging left/right without lift chrome-plated refrigeration units series G 303 centre of rotation 24mm		
For models:	RB072E, RB102S, RC162M, RM262E, RM262M		
accessories for	690431		
	Part No.	690395	Ref. No. —
	base plate for type 300/303 thickness 5mm L 100mm		

door bearing

Part No.	691288	Ref. No.	58002520 LA58002520 LAR58002520
description	door bolt		
For models:	ACG10M, AVE07D, AVE10D, AVE10P, BPE064M, BPE064P, BPE074M, BPE074P, BPE084M, BPE084P, BPE104M, BPE104P, BPG064M, BPG064P, BPG074M, BPG074P, BPG084M, BPG084P, BPG104M, BPG104P, CE071M, CE100M, CE200M, CG071M, CG100M, CG200M, EMT06D, GMT06D, GMT20D, GMT20P, GVT06D, GVT20D, MACE07M, MACE10M, MACE20M, MACG07M, MACG10M, MACG20M, MCE071M, MCE101M, MCE102M, MCG071M, MCG101M, MCG102M, ME061D, ME101D, ME102D, MEMT06D, MEMT06P, MEMT10D...(Other models you can see in the webshop)		

Part No.	692831	Ref. No.	58002670 LA58002670 LAR58002670
description	door bolt mounting pos. bottom left thread M12 bolt 15mm bolt ø 10mm		
For models:	EMT06D, EPE056T, EPE086T, EPEV05T, EPEV08T, EPG056T, EPG086T, EPGV05T, EPGV08T, GEMT06P, GEMT06T, GEMT10P, GEMT10T, GEMT20P, GEMT20T, GEVT06P, GEVT06T, GEVT10P, GEVT10T, GEVT20P, GEVT20T, GGMT06P, GGMT06T, GGMT10P, GGMT10T, GGMT20P, GGMT20T, GGVT06P, GGVT06T, GGVT10P, GGVT10T, GGVT20P, GGVT20T, GMT20D, GMT20P, GVT06D, GVT20D, HME061P, HME061T, HME061X, HME101P, HME101T, HME101X, HME102P, HME102T, HME102X, HMG061P, HMG061T, HMG061X, HMG101P... (Other models you can see in the webshop)		

Part No.	701436	Ref. No.	14850012 BN14850012 FR935179
description	door hinge L 60mm W 30mm mounting pos. upper bolt 14mm bolt ø 15mm suitable for refrigerator		

Part No.	692833	Ref. No.	LA17402180 LAR17402180
description	door hinge L 62mm W 35mm H 36mm mounting distance 38mm mounting pos. upper ID ø 8.5mm thickness 4mm for combi-steamer		

Part No.	692829	Ref. No.	17402190 LA17402190 LAR17402190
description	door hinge L 62mm W 35mm H 36mm mounting pos. lower thickness 4mm for combi-steamer		





			
1			
Part No.	690098	Ref. No.	10201330 LAR10201330
description	door hinge mounting pos. lower with holder		
For models:	CGC24M, CGC40M, ME120D, ME120H, ME120M, ME120P, ME120X, ME220D, ME220H, ME220M, ME220P, ME220X, MEC20H, MEC20P, MEC20X, MEC24H, MEC40H, MEC40M, MEK21H, MG120D, MG120H, MG120M, MG120P, MG120X, MG220D, MG220H, MG220M, MG220P, MG220X, MGC20H, MGC20X, MGC24H, MGC40H, MGC40P, PE015M, PE115K, PG015M, PG115M, VE120D, VE120H, VE120M, VE120P, VE120X, VE220D, VE220H, VE220M, VE220P, VE220X, VEC20P, VES40M... (Other models you can see in the webshop)		

			
1			
Part No.	690097	Ref. No.	10201290 LA10201290 LAR10201290
description	door hinge mounting pos. upper		
For models:	ME106D, ME106H, ME106M, ME106P, ME106X, ME110D, ME110H, ME110M, ME110P, ME110X, ME120D, ME120H, ME120M, ME120P, ME120X, ME210D, ME210H, ME210M, ME210P, ME210X, ME227M, ME227P, ME227X, MEC20H, MEC20P, MEC20X, MEK21H, MG106D, MG106H, MG106M, MG106P, MG106X, MG110D, MG110H, MG110M, MG110P, MG110X, MG120D, MG120H, MG120M, MG120P, MG120X, MG210D, MG210H, MG210M, MG210P, MG210X, MG227M, MG227P, MG227X... (Other models you can see in the webshop)		

			
1			
Part No.	692828	Ref. No.	17400540 LA17400540 LAR17400540
description	door hinge upper for combi-steamer L 63mm W 35mm H 31mm		
For models:	A05PES, A05RES, A05RES+UM, A08RES, A08RES+UM, A10RES, A10RES+UM		

			
1			
Part No.	691287	Ref. No.	18404500 LAR18404500
description	hinge		
For models:	ACG10M, AVE07D, AVE10D, AVE10P, BPE064M, BPE064P, BPE074M, BPE074P, BPE084M, BPE084P, BPE104M, BPE104P, BPG064M, BPG064P, BPG074M, BPG074P, BPG084M, BPG084P, BPG104M, BPG104P, CE071M, CE100M, CE200M, CG071M, CG100M, CG200M, MACE07M, MACE10M, MACE20M, MACG07M, MACG10M, MACG20M, MCE071M, MCE101M, MCE102M, MCG071M, MCG101M, MCG102M, MME071P, MME101P, MME102P, MMG071P, MMG101P, MMG102P, MVE071M, MVE071P, MVE101M, MVE101P, MVE102P, MVG071P... (Other models you can see in the webshop)		

			
1			
Part No.	691284	Ref. No.	58001760 LA58001760 LAR58001760
description	hinge for glass plate		
For models:	ACG10M, AVE07D, AVE10D, AVE10P, BPE064M, BPE064P, BPE074M, BPE074P, BPE084M, BPE084P, BPE104M, BPE104P, BPG064M, BPG064P, BPG074M, BPG074P, BPG084M, BPG084P, BPG104M, BPG104P, CE071M, CE100M, CE200M, CG071M, CG100M, CG200M, EMT06D, EPE056T, EPE086T, EPE156T, EPEV05T, EPEV08T, EPEV15T, EPG056T, EPG086T, EPG156T, EPGV05T, EPGV08T, EPGV15T, GEMT06P, GEMT06T, GEMT10P, GEMT10T, GEMT20P, GEMT20T, GEMT21P, GEMT21T, GEMT40P, GEMT40T, GEVT06P... (Other models you can see in the webshop)		

			
1			
Part No.	694388	Ref. No.	12200630 LA12200630 LAR12200630
description	hinge L 130mm W 35mm H 22mm mounting pos. lower with bolt suitable for oven		
For models:	PE005K, PE108D		

			
1			
Part No.	692333	Ref. No.	02200140 LAR02200140
description	hinge L 42mm W 30mm H 62mm mounting pos. lower bolt 14mm bolt ø 10mm		

			
1			
Part No.	699245	Ref. No.	32213056 A051004 BN32213056 RRA051004 SIRRA051004
description	hinge L 58.5mm W 35mm H 109mm mounting pos. lower bolt 94mm bolt ø 8mm with accessories		





			
1			
Part No.	691277	Ref. No.	18201270 LA18201270 LAR18201270
description	hinge mounting pos. bottom left		
For models:	BPE044M, BPE044P, BPE054M, BPE054P, BPG044M, BPG044P, BPG054M, BPG054P, CE041M, CE051M, CG051M, MACE04M, MACE05M, MACG05M, MCE042M, MCE051M, MCG051M, MVE042P, MVE051P, MVG051P, VE042P, VE051P, VE055P, VG051P		

			
1			
Part No.	690586	Ref. No.	11200560 LA1142683 LAR11200560
description	hinge bearing mounting pos. upper left without bolt		
For models:	ACG10M, AVE07D, AVE10D, AVE10P, BPE064M, BPE064P, BPE074M, BPE074P, BPE084M, BPE084P, BPE104M, BPE104P, BPG064M, BPG064P, BPG074M, BPG074P, BPG084M, BPG084P, BPG104M, BPG104P, CE071M, CE100M, CE200M, CG071M, CG100M, CG200M, EMT06D, EPE056T, EPE086T, EPE156T, EPEV05T, EPEV08T, EPEV15T, EPG056T, EPG086T, EPG156T, EPGV05T, EPGV08T, EPGV15T, GEMT06P, GEMT06T, GEMT10P, GEMT10T, GEMT20P, GEMT20T, GEMT21P, GEMT21T, GEMT40P, GEMT40T, GEVT06P...(Other models you can see in the webshop)		

			
1			
Part No.	690587	Ref. No.	11200550 11200551 LA11200551 LAR11200550 LAR11200551
description	hinge bearing mounting pos. lower with bolt		
For models:	ME061H, ME061M, ME061P, ME061T, ME101H, ME101M, ME101P, ME101T, ME102H, ME102M, ME102P, ME102T, MG061H, MG061M, MG061P, MG061T, MG101H, MG101M, MG101P, MG101T, MG102H, MG102M, MG102P, MG102T		

			
1			
Part No.	514524	Ref. No.	11207240 LA11207240 LAR11207240
description	hinge bearing without bolt for combi-steamer mounting pos. bottom left		
For models:	EMT06D, EPE056T, EPE086T, EPEV05T, EPEV08T, EPG056T, EPG086T, EPGV05T, EPGV08T, GEMT06P, GEMT06T, GEMT10P, GEMT10T, GEMT20P, GEMT20T, GEVT06P, GEVT06T, GEVT10P, GEVT10T, GEVT20P, GEVT20T, GGMT06P, GGMT06T, GGMT10P, GGMT10T, GGMT20P, GGMT20T, GGV06P, GGV06T, GGV10P, GGV10T, GGV20P, GGV20T, GMT20D, GMT20P, GVT06D, GVT20D, HME061P, HME061T, HME061X, HME101P, HME101T, HME101X, HME102P, HME102T, HME102X, HMG061P, HMG061T, HMG061X, HMG101P...(Other models you can see in the webshop)		

			
1			
Part No.	690096	Ref. No.	10201190 LAR10201190
description	hinge bearing mounting pos. lower without bolt		
For models:	ME106D, ME106H, ME106M, ME106P, ME106X, ME110D, ME110H, ME110M, ME110P, ME110X, ME210D, ME210H, ME210M, ME210P, ME210X, MG106D, MG106H, MG106M, MG106P, MG106X, MG110D, MG110H, MG110M, MG110P, MG110X, MG210D, MG210H, MG210M, MG210P, MG210X, VE106D, VE106H, VE106M, VE106P, VE106X, VE110D, VE110H, VE110M, VE110X, VE210D, VE210H, VE210M, VE210P, VE210X, VG106D, VG106H, VG106M, VG106P, VG106X, VG110D...(Other models you can see in the webshop)		

			
1			
Part No.	691285	Ref. No.	58001770 LA58001770 LAR58001770
description	hinge bolt		
For models:	ACG10M, AVE07D, AVE10D, AVE10P, BPE064M, BPE064P, BPE074M, BPE074P, BPE084M, BPE084P, BPE104M, BPE104P, BPG064M, BPG064P, BPG074M, BPG074P, BPG084M, BPG084P, BPG104M, BPG104P, CE071M, CE100M, CE200M, CG071M, CG100M, CG200M, EMT06D, EPE056T, EPE086T, EPE156T, EPEV05T, EPEV08T, EPEV15T, EPG056T, EPG086T, EPG156T, EPGV05T, EPGV08T, EPGV15T, GEMT06P, GEMT06T, GEMT10P, GEMT10T, GEMT20P, GEMT20T, GEMT21P, GEMT21T, GEMT40P, GEMT40T, GEVT06P...(Other models you can see in the webshop)		

			
1			
Part No.	691276	Ref. No.	18201260 LA18201260 LAR18201260
description	hinge bearing mounting pos. upper left		
For models:	BPE044M, BPE044P, BPE054M, BPE054P, BPG044M, BPG044P, BPG054M, BPG054P, CE041M, CE051M, CG051M, MACE04M, MACE05M, MACG05M, MCE042M, MCE051M, MCG051M, MVE042P, MVE051P, MVG051P, VE042P, VE051P, VE055P, VG051P		



			
1			
Part No.	690099	Ref. No.	50005090 58002150 LA58002150 LAR50005090 LAR58002150
description	hinge pin mounting pos. upper for door		
For models:	ACG10M, AVE07D, AVE10D, AVE10P, BPE064M, BPE064P, BPE074M, BPE074P, BPE084M, BPE084P, BPE104M, BPE104P, BPG064M, BPG064P, BPG074M, BPG074P, BPG084M, BPG084P, BPG104M, BPG104P, CE071M, CE100M, CE200M, CG071M, CG100M, CG200M, CGC24M, CGC40M, EC106M, EC110M, EC210M, EM010M+SC, EM106H, EM106M, EM106M+SC, EM106P, EM110H, EM110M, EM110M+SC, EM110P, EM210H, EM210M, EM210M+SC, EM210P, EMT06D, EPE056T, EPE086T, EPE156T, EPEV05T, EPEV08T...(Other models you can see in the webshop)		

			
1			
Part No.	690593	Ref. No.	58002570 LA58002570 LAR58002570
description	plain washer ID ø 15mm ED ø 30mm thickness 3mm Qty 1 pcs for door hinge		
For models:	CGC24M, CGC40M, EPE156T, EPEV15T, EPG156T, EPGV15T, GEMT21P, GEMT21T, GEMT40P, GEMT40T, GEVT21P, GEVT21T, GEVT40P, GEVT40T, GGMT21P, GGMT21T, GGMT40P, GGMT40T, GGV21P, GGV21T, GGV40P, GGV40T, HME201P, HME201T, HME201X, HME202P, HME202T, HME202X, HMG201P, HMG201T, HMG201X, HMG202P, HMG202T, HMG202X, HVE201P, HVE201T, HVE201X, HVE202P, HVE202T, HVE202X, HVG201P, HVG201T, HVG201X, HVG202P, HVG202T, HVG202X, MCE201M, MCE202M, MCG201M, MCG202M...(Other models you can see in the webshop)		

accessories

miscellaneous

			
1			
Part No.	690595	Ref. No.	58002550 LA58002550 LAR58002550
description	bush for door hinge		
For models:	CGC24M, CGC40M, EPE156T, EPEV15T, EPG156T, EPGV15T, GEMT21P, GEMT21T, GEMT40P, GEMT40T, GEVT21P, GEVT21T, GEVT40P, GEVT40T, GGMT21P, GGMT21T, GGMT40P, GGMT40T, GGV21P, GGV21T, GGV40P, GGV40T, HME201P, HME201T, HME201X, HME202P, HME202T, HME202X, HMG201P, HMG201T, HMG201X, HMG202P, HMG202T, HMG202X, HVE201P, HVE201T, HVE201X, HVE202P, HVE202T, HVE202X, HVG201P, HVG201T, HVG201X, HVG202P, HVG202T, HVG202X, MCE201M, MCE202M, MCG201M, MCG202M...(Other models you can see in the webshop)		

			
1			
Part No.	690594	Ref. No.	58002560 LA58002560 LAR58002560
description	pressure screw for door hinge		
For models:	CGC24M, CGC40M, EPE156T, EPEV15T, EPG156T, EPGV15T, GEMT21P, GEMT21T, GEMT40P, GEMT40T, GEVT21P, GEVT21T, GEVT40P, GEVT40T, GGMT21P, GGMT21T, GGMT40P, GGMT40T, GGV21P, GGV21T, GGV40P, GGV40T, HME201P, HME201T, HME201X, HME202P, HME202T, HME202X, HMG201P, HMG201T, HMG201X, HMG202P, HMG202T, HMG202X, HVE201P, HVE201T, HVE201X, HVE202P, HVE202T, HVE202X, HVG201P, HVG201T, HVG201X, HVG202P, HVG202T, HVG202X, MCE201M, MCE202M, MCG201M, MCG202M...(Other models you can see in the webshop)		

equipment feet and end caps

equipment feet

with fixing plate

			
1			
Part No.	690592	Ref. No.	58002540 LAR58002540
description	pin for hinge		
For models:	CGC24M, CGC40M, EPE156T, EPEV15T, EPG156T, EPGV15T, GEMT21P, GEMT21T, GEMT40P, GEMT40T, GEVT21P, GEVT21T, GEVT40P, GEVT40T, GGMT21P, GGMT21T, GGMT40P, GGMT40T, GGV21P, GGV21T, GGV40P, GGV40T, HME201P, HME201T, HME201X, HME202P, HME202T, HME202X, HMG201P, HMG201T, HMG201X, HMG202P, HMG202T, HMG202X, HVE201P, HVE201T, HVE201X, HVE202P, HVE202T, HVE202X, HVG201P, HVG201T, HVG201X, HVG202P, HVG202T, HVG202X, MCE201M, MCE202M, MCG201M, MCG202M...(Other models you can see in the webshop)		

			
1			
Part No.	700724	Ref. No.	MA6086113
description	equipment foot tube ø 58mm plate size 70x70mm hole distance 56x56mm H 130-210mm SS size 2 1/4" Qty 1 pcs		



screw-in feet

 <p>1</p>			
Part No.	701571	Ref. No.	LA69070250
description	equipment foot thread M5 thread L 15mm ø 50mm H 32mm pipe ø 22		

TENTE

with fixing plate

stainless steel

 <p>1</p>			
Part No.	701624	Ref. No.	69090100 LA69090100 LAR69090100
description	swivel castor with swivel brake ø 125mm plate fixing housing stainless steel plate size 105x85mm hole distance 78x60mm capacity 200kg bearing slide bearing wheel body polyamide tread polyurethane H 155mm wheel width 32mm		
For models:	EPE156T, EPEV15T, EPG156T, EPGV15T, GEMT21P, GEMT21T, GEMT40P, GEMT40T, GEVT21P, GEVT21T, GEVT40P, GEVT40T, GGMT21P, GGMT21T, GGMT40P, GGMT40T, GGVT21P, GGVT21T, GGVT40P, GGVT40T, HME201P, HME201T, HME201X, HME202P, HME202T, HME202X, HMG201P, HMG201T, HMG201X, HMG202P, HMG202T, HMG202X, HVE201P, HVE201T, HVE201X, HVE202P, HVE202T, HVE202X, HVG201P, HVG201T, HVG201X, HVG202P, HVG202T, HVG202X, MCE201M, MCE202M, MCG201M, MCG202M, ME201D, ME201H...(Other models you can see in the webshop)		

 <p>1</p>			
Part No.	701622	Ref. No.	69090090 LA69090090 LAR69090090
description	swivel castor without brake ø 125mm plate fixing housing stainless steel plate size 105x85mm hole distance 78x60mm capacity 200kg bearing slide bearing wheel body polyamide tread polyurethane H 155mm wheel width 32mm		
For models:	EPE156T, EPEV15T, EPG156T, EPGV15T, GEMT21P, GEMT21T, GEMT40P, GEMT40T, GEVT21P, GEVT21T, GEVT40P, GEVT40T, GGMT21P, GGMT21T, GGMT40P, GGMT40T, GGVT21P, GGVT21T, GGVT40P, GGVT40T, HME201P, HME201T, HME201X, HME202P, HME202T, HME202X, HMG201P, HMG201T, HMG201X, HMG202P, HMG202T, HMG202X, HVE201P, HVE201T, HVE201X, HVE202P, HVE202T, HVE202X, HVG201P, HVG201T, HVG201X, HVG202P, HVG202T, HVG202X, MCE201M, MCE202M, MCG201M, MCG202M, ME201D, ME201H...(Other models you can see in the webshop)		

with bolt hole

plastic

 <p>1</p>			
Part No.	701595	Ref. No.	LAR69090360
description	swivel castor with brake ø 100mm bolt hole bolt hole ø 10mm housing polyamide capacity 100kg bearing ball bearing wheel body polyamide tread polyurethane H 103mm wheel width 73.5mm -10 up to +40°C Qty 1 pcs		





 <p>1</p>			
Part No.	701594	Ref. No.	LAR69090350
description	swivel castor without brake ø 100mm bolt hole bolt hole ø 10mm housing polyamide capacity 100kg bearing ball bearing wheel body polyamide tread polyurethane H 103mm wheel width 73.5mm -10 up to +40°C Qty 1 pcs		

shelves and shelf rails

grates

universal

without upstand

 <p>1</p>				
Part No.	970122	Ref. No.	FR6350610 FR990039 X1100	
description	grate W 325mm D 530mm GN 1/1 H 8mm stainless steel wire gauge frame 7mm lengthwise wires gauge 4mm crossing wires 1			
accessories for	970122			
	Part No.	690330	Ref. No.	—
	rack L 1000mm W 22mm H 4mm aperture 3x8mm hole distance 12.5mm stainless steel			
	Part No.	694700	Ref. No.	—
	shelf support L 31/28mm W 22mm H 18mm SS Qty 12 pcs			
	Part No.	694701	Ref. No.	—
	shelf support L 31/28mm W 22mm H 17mm SS with hook Qty 12 pcs			



shelf rails and supports

producer-specific



1

Part No.	701628	Ref. No.	58001850 LA58001850 LAR58001850
description	bolt for setting bar L 21mm thread ø M5mm		

gaskets

refrigeration gaskets

plug-in gaskets

profile 9048

We offer custom-made gaskets for this profile

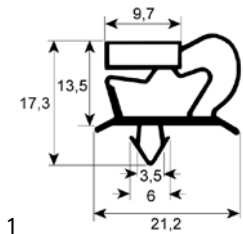

1

Part No.	901415	Ref. No.	SIR227017971
description	refrigeration gasket profile 9048 W 350mm L 675mm plug size		

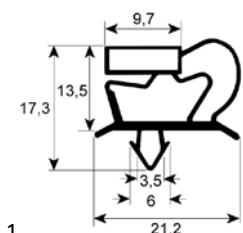

1

Part No.	901230	Ref. No.	RA190067 SIRA190067 SIRRA190067
description	refrigeration gasket profile 9048 W 390mm L 685mm plug size for blast chiller		
For models:	XESH6X40, XESH6X40A, XESH6X40B, XESH6X41, XESH6X41A, XESH6X41B, XESH6X42, XESH6X42A, XESH6X42B, XESH6X42C, XESH6X42D, XESH6X43, XESH6X43A, XESH6X43B, XESH6X43C, XESH6X43D, XESH6X44, XESH6X44A, XESH6X44B, XESH6X45, XESH6X46, XESH6X46A, XESH6X46B, XESH6X46C, XESH6X46D, XESH6X47, XESH6X48, XESH6X49, XESH6X50, XESH6X76, XESH6X76A, XESH6X77, XESH6X77A, XESH6X77B, XESH6X77C		

SHELVES AND SHELF RAILS/GASKETS LAINOX

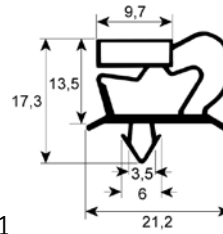

1

Part No.	901228	Ref. No.	RA190071 RA1971 SIRA190071 SIRRA190071
description	refrigeration gasket profile 9048 W 685mm L 1105mm plug size for blast chiller		
For models:	XESH6X52, XESH6X53, XESH6X53A, XESH6X53B, XESH6X53C, XESH6X53D, XESH6X53E, XESH6X53F, XESH6X53G, XESH6X53H, XESH6X60, XESH6X61, XESH6X61A, XESH6X61B, XESH6X61C, XESH6X61D, XESH6X61E, XESH6X61F, XESH6X61G, XESH6X61H, XESH6X62, XESH6X62A, XESH6X62B, XESH6X62C, XESH6X62D, XESH6X63, XESH6X75, XESH6X75A, XESH6X75B, XESH6X75C, XESH6X80, XESH6X80A, XESH6X80B, XESH6X80C, XESH6X81, XESH6X81A, XESH6X81B, XESH6X81C		

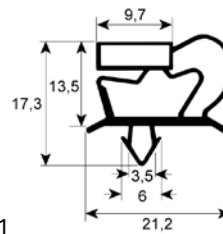

1

Part No.	901229	Ref. No.	RA190070 SIRA190070 SIRRA190070
description	refrigeration gasket profile 9048 W 690mm L 825mm plug size		
For models:	XESH6X51, XESH6X51A, XESH6X51B, XESH6X51C, XESH6X51D, XESH6X51E, XESH6X51F, XESH6X51G, XESH6X51H, XESH6X54, XESH6X55A, XESH6X55B, XESH6X55C, XESH6X55D, XESH6X56, XESH6X57, XESH6X57A, XESH6X57B, XESH6X57C, XESH6X57D, XESH6X57E, XESH6X57F, XESH6X57G, XESH6X57H, XESH6X58, XESH6X59, XESH6X59A, XESH6X59B, XESH6X59C, XESH6X59D, XESH6X64A, XESH6X64B, XESH6X64C, XESH6X64D, XESH6X79, XESH6X79A, XESH6X79B		

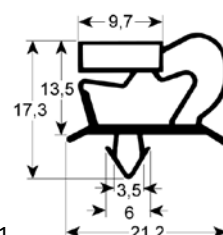

1

Part No.	902258	Ref. No.	N/A
description	refrigeration gasket profile 9048 Wmm L 2500mm		



profile 9773

We offer custom-made gaskets for this profile

Part No.	901231	Ref. No.	70043000 LAR70043000
description	refrigeration gasket profile 9773 W 385mm L 660mm external size W1 372mm L1 647mm plug size suitable for HIBER/LAINOX for blast chiller		

Part No.	902305	Ref. No.	N/A
description	refrigeration gasket profile 9773 Wmm L 2500mm		

profile 9794

We offer custom-made gaskets for this profile

Part No.	900693	Ref. No.	4501121 935638 FR4501121 FR935638
description	refrigeration gasket profile 9794 W 680mm L 1535mm plug size		

Part No.	902308	Ref. No.	N/A
description	refrigeration gasket profile 9794 Wmm L 2500mm		

profile 9195

We offer custom-made gaskets for this profile

Part No.	902435	Ref. No.	996453 FR996453
description	refrigeration gasket profile 9195 W 400mm L 690mm		

gaskets for heated units

window seals

Part No.	900787	Ref. No.	70044650 80100010 LAR70044650 LAR80100010
description	window gasket profile 1515 L 2200mm suitable for LAINOX		
For models:	AVE07D, BPE064M, BPE064P, BPE074M, BPE074P, BPG064M, BPG064P, BPG074M, BPG074P, CE071M, CG071M, MACE07M, MACG07M, MCE071M, MCG071M, MME071P, MMG071P, MVE071M, MVE071P, MVG071P		

Part No.	900129	Ref. No.	70040840 70040890 LAR70040840 LAR70040890
description	window gasket profile 1530 L 1015mm Qty 1		
For models:	ME110D, ME110H, ME110L, ME110M, ME110P, ME110S, ME110T, ME110X, ME210D, ME210H, ME210L, ME210M, ME210P, ME210S, ME210T, ME210X, MG110D, MG110H, MG110L, MG110M, MG110P, MG110S, MG110T, MG110X, MG210D, MG210H, MG210L, MG210M, MG210P, MG210S, MG210T, MG210X, PE005K, PE115K, VE110D, VE110H, VE110L, VE110M, VE110S, VE110T, VE110X, VE210D, VE210H, VE210L, VE210M, VE210P, VE210S, VE210T, VE210X, VG110D...(Other models you can see in the webshop)		

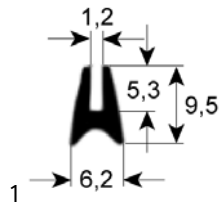
Part No.	900501	Ref. No.	70044260 LAR70044260
description	window gasket profile 1530 L 1200mm Qty 1		
For models:	ACG10M, AVE10D, AVE10P, BPE084M, BPE084P, BPE104M, BPE104P, BPG084M, BPG084P, BPG104M, BPG104P, CE100M, CE200M, CG100M, CG200M, EPE086T, EPEV08T, EPG086T, EPGV08T, HME101P, HME101T, HME101X, HMG101P, HMG101T, HMG101X, HVE101P, HVE101T, HVE101X, HVG101P, HVG101T, HVG101X, MACE10M, MACE20M, MACG10M, MACG20M, MCE101M, MCE102M, MCG101M, MCG102M, ME101D, ME101H, ME101M, ME101P, ME101T, ME102H, ME102M, ME102P, ME102T, MG101D, MG101H... (Other models you can see in the webshop)		

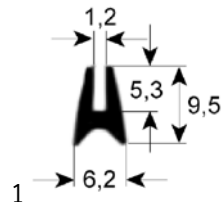

Part No.	900504	Ref. No.	70044290 LAR70044290
description	window gasket profile 1530 L 1950mm Qty 1		
For models:	GEMT40P, GEMT40T, GEVT40P, GEVT40T, GGMT40P, GGMT40T, GGVT40P, GGVT40T, HME202T, HME202X, HMG202P, HMG202T, HMG202X, HVE202P, HVE202T, HVE202X, HVG202P, HVG202T, HVG202X, MCE202M, MCG202M, ME202D, ME202H, ME202M, ME202P, ME202T, MEMT21D, MEMT21P, MEMT40D, MEMT40P, MEVT21D, MEVT21P, MEVT40D, MEVT40P, MG202H, MG202M, MG202P, MG202T, MGMT21D, MGMT21P, MGMT40D, MGMT40P, MGVT21D, MGVT21P, MGVT40D, MGVT40P, VE202D, VE202M, VE202P... (Other models you can see in the webshop)		

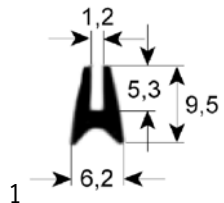

Part No.	900130	Ref. No.	70040850 70040900 LAR70040850 LAR70040900
description	window gasket profile 1530 L 1750mm Qty 1		
For models:	CGC40M, ME120D, ME120H, ME120L, ME120M, ME120P, ME120S, ME120T, ME120X, ME220D, ME220H, ME220L, ME220M, ME220P, ME220S, ME220T, ME220X, MEC20H, MEC20P, MEC20X, MEC40H, MEC40M, MEK21H, MG120D, MG120H, MG120L, MG120M, MG120P, MG120S, MG120T, MG120X, MG220D, MG220H, MG220L, MG220M, MG220P, MG220S, MG220T, MG220X, MGC20H, MGC20X, MGC40H, MGC40P, PE015M, PG015M, PG115M, VE120D, VE120H, VE120L, VE120M... (Other models you can see in the webshop)		

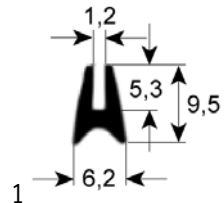

Part No.	900483	Ref. No.	70044150 LAR70044150
description	window gasket profile 1530 L 2400mm Qty 1		
For models:	ACG10M, AVE10D, AVE10P, BPE084M, BPE084P, BPE104M, BPE104P, BPG084M, BPG084P, BPG104M, BPG104P, CE100M, CE200M, CG100M, CG200M, EPE086T, EPEV08T, EPG086T, EPGV08T, GEMT20P, GEMT20T, GEVT20P, GEVT20T, GGMT20P, GGMT20T, GGVT20P, GGVT20T, GMT20D, GMT20P, GVT20D, HME061P, HME061T, HME061X, HME101P, HME101T, HME101X, HME102P, HME102T, HME102X, HMG061P, HMG061T, HMG061X, HMG101P, HMG101T, HMG101X, HMG102P, HMG102T, HMG102X, HVE061P, HVE061T... (Other models you can see in the webshop)		

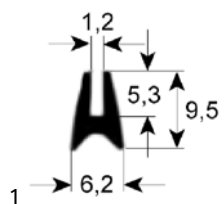

Part No.	900503	Ref. No.	70044280 LAR70044280
description	window gasket profile 1530 L 1800mm Qty 1		
For models:	EPE156T, EPEV15T, EPG156T, EPGV15T, HME201T, HME201X, HMG201P, HMG201T, HMG201X, HVE201P, HVE201T, HVE201X, HVG201P, HVG201T, HVG201X, MCE201M, MCG201M, ME201D, ME201H, ME201M, ME201P, ME201T, MG201D, MG201H, MG201M, MG201P, MG201T, PE156T, VE201D, VE201M, VE201P, VG201D, VG201M, VG201P		

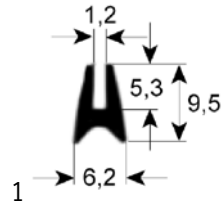

Part No.	900484	Ref. No.	70044160 LAR70044160
description	window gasket profile 1530 L 3720mm Qty 1		
For models:	EPE156T, EPEV15T, EPG156T, EPGV15T, GEMT40P, GEMT40T, GEVT40P, GEVT40T, GGMT40P, GGMT40T, GGVT40P, GGVT40T, HME201P, HME201T, HME201X, HME202P, HME202T, HME202X, HMG201P, HMG201T, HMG201X, HMG202P, HMG202T, HMG202X, HVE201P, HVE201T, HVE201X, HVE202P, HVE202T, HVE202X, HVG201P, HVG201T, HVG201X, HVG202P, HVG202T, HVG202X, MCE201M, MCE202M, MCG201M, MCG202M, ME201D, ME201H, ME201M, ME201P, ME201T, ME202D, ME202H, ME202M, ME202P, ME202T... (Other models you can see in the webshop)		

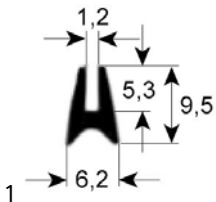
Part No.	900117	Ref. No.	70040810 LAR70040810
description	window gasket profile 1530 L 505mm Qty 1		
For models:	CVE004H, CVE004M, CVE104H, CVE104M, ME004L, ME004S, ME104L, ME104S, VE004D, VE004H, VE004M, VE004S, VE004X, VE104D, VE104H, VE104M, VE104S, VE104X		

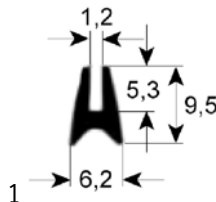

Part No.	900143	Ref. No.	80100100 LAR80100100
description	window gasket profile 1530 Qty supplied by meter		

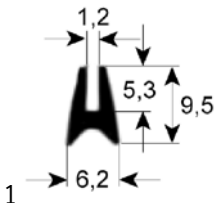

Part No.	900118	Ref. No.	70040820 LAR70040820
description	window gasket profile 1530 L 595mm Qty 1		
For models:	CVE105H, CVE105M, CVG105H, CVG105M, ME105L, ME105S, MG105L, MG105S, VE105D, VE105H, VE105M, VE105S, VE105X, VE155H, VE155M, VE155X, VG105D, VG105H, VG105M, VG105S, VG105X		

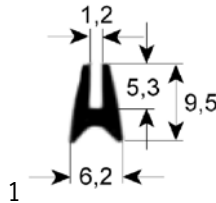

Part No.	900637	Ref. No.	70040640 70040650 LAR70040640 LAR70040650
description	window gasket profile 1530 Qty supplied by meter		
For models:	FE110M, FE110X, FE210M, FG110M, FG110X, FG210M, FG210X, GEMT10P, GEMT10T, GEVT10P, GEVT10T, GGMT10P, GGMT10T, GGVT10P, GGVT10T, ME110L, ME110S, ME110T, ME110X, ME210L, ME210S, ME210T, ME227M, ME227P, ME227X, MEMT10D, MEMT10P, MEVT10D, MEVT10P, MG110L, MG110M, MG110P, MG110S, MG110T, MG110X, MG210L, MG210M, MG210P, MG210S, MG210T, MG210X, MG227M, MG227P, MG227X, MGMT10D, MGMT10P, MGVT10D, MGVT10P, PE080M, PE080X...(Other models you can see in the webshop)		

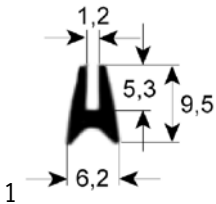

Part No.	900128	Ref. No.	70040830 70040880 LAR70040830 LAR70040880
description	window gasket profile 1530 L 750mm Qty 1		
For models:	ME106D, ME106H, ME106L, ME106M, ME106P, ME106S, ME106T, ME106X, MG106D, MG106H, MG106L, MG106M, MG106P, MG106S, MG106T, MG106X, VE106D, VE106H, VE106L, VE106M, VE106P, VE106S, VE106T, VE106X, VG106D, VG106H, VG106L, VG106M, VG106P, VG106S, VG106T, VG106X		

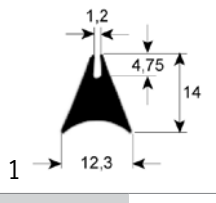

Part No.	900120	Ref. No.	70040050 70040060 LAR70040050 LAR70040060
description	window gasket profile 1620 L 1175mm Qty 1		
For models:	CVE004H, CVE004M, CVE104H, CVE104M, ME004L, ME004S, ME104L, ME104S, VE004D, VE004H, VE004M, VE004S, VE004X, VE104D, VE104H, VE104M, VE104S, VE104X		

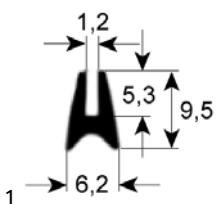

Part No.	900500	Ref. No.	70044250 LAR70044250
description	window gasket profile 1530 L 900mm Qty 1		
For models:	AVE07D, BPE044M, BPE044P, BPE054M, BPE054P, BPE064M, BPE064P, BPE074M, BPE074P, BPG044M, BPG044P, BPG054M, BPG054P, BPG064M, BPG064P, BPG074M, BPG074P, CE071M, CG071M, EPE056T, EPEV05T, EPG056T, EPGV05T, GEMT06P, GEMT06T, GEVT06P, GEVT06T, GGMT06P, GGMT06T, GGVT06P, GGVT06T, HME061P, HME061T, HME061X, HMG061P, HMG061T, HMG061X, HVE061P, HVE061T, HVE061X, HVG061P, HVG061T, HVG061X, MACE07M, MACG07M, MCE051M, MCE071M, MCG051M, MCG071M, ME061D...(Other models you can see in the webshop)		

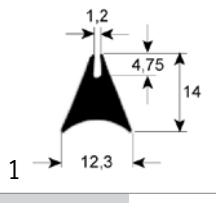

Part No.	900119	Ref. No.	50505821 70040010 70040020 LAR50505821 LAR70040010 LAR70040020
description	window gasket profile 1620 L 1500mm Qty 1		
For models:	CVE105H, CVE105M, CVG105H, CVG105M, FE05, FG05, FG051M, FG051X, ME05, ME105L, ME105S, MG05, MG105L, MG105S, PE04, PG04, PG041M, PG041X, PG051X, RE05, RG05, VE105D, VE105H, VE105M, VE105S, VE105X, VE155H, VE155M, VE155X, VG105D, VG105H, VG105M, VG105S, VG105X		



Part No.	900121	Ref. No.	50505822 70040080 LAR50505822 LAR70040080
description	window gasket profile 1620 L 1690mm Qty 1		
For models:	ME106D, ME106H, ME106M, ME106P, ME106X, MG106D, MG106H, MG106M, MG106P, MG106X, RE07, RG07, VE106D, VE106H, VE106L, VE106M, VE106P, VE106S, VE106T, VE106X, VG106D, VG106L, VG106M, VG106P, VG106S, VG106T, VG106X		

Part No.	900481	Ref. No.	50505823 70040120 70040130 70040210 70040690 LAR50505823 LAR70040120 LAR70040130 LAR70040210 LAR70040690
description	window gasket profile 1620 L 2400mm Qty 1		
For models:	FG101M, FG101X, ME10, ME120P, ME20, ME24, MG10, MG120M, MG120P, MG120X, MG20, MG220M, MG220P, MG220X, MG24, MME10, PE08, PG08, PG081M, PG081X, PG101M, PG101X, RE10, RE20, RE24, RG10, RG20, RG24		

Part No.	900482	Ref. No.	50505824 70040160 LAR50505824 LAR70040160
description	window gasket profile 1620 L 1800mm Qty 1		
For models:	ME15, MG15, PE12, PG12		

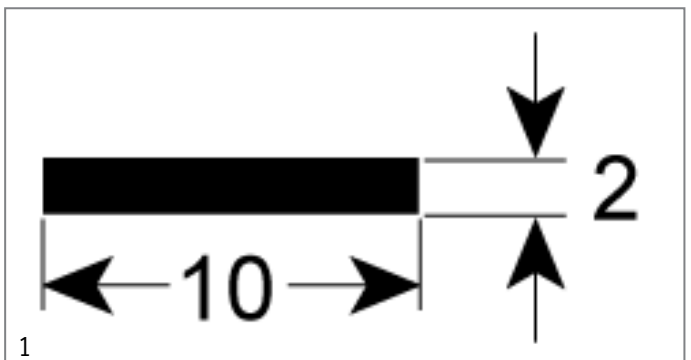

Part No.	900122	Ref. No.	50505825 70040200 LAR50505825 LAR70040200
description	window gasket profile 1620 L 2125mm Qty 1		
For models:	CGC24M, CGC40M, ME110D, ME110H, ME110M, ME110P, ME110X, ME120D, ME120H, ME120L, ME120M, ME120P, ME120S, ME120T, ME120X, ME21, ME210D, ME210H, ME210M, ME210P, ME210X, ME220D, ME220H, ME220L, ME220M, ME220P, ME220S, ME220T, ME220X, ME40, MEC20H, MEC20P, MEC20X, MEC24H, MEC40H, MEC40M, MEK21H, MG110D, MG110H, MG110M, MG110P, MG110X, MG120D, MG120H, MG120L, MG120M, MG120P, MG120S, MG120T, MG120X...(Other models you can see in the webshop)		

Part No.	902460	Ref. No.	70042680 LAR70042680
description	window gasket profile 1887 L 3200mm Qty 1 suitable for LAINOX		
For models:	EC210M, EM210H, EM210M, EM210M+SC, EM210P, EV210H, EV210M, EV210M+SC, EV210P, GC210M, GM210H, GM210M, GM210M+SC, GM210P, GV210H, GV210M, GV210M+SC, GV210P		

Part No.	901361	Ref. No.	70042610 LAR70042610
description	window gasket profile 1887 L 6500mm suitable for LAINOX		
For models:	PE108D		

Part No.	900935	Ref. No.	70042630 LAR70042630
description	window gasket profile 1887 L 8900mm front		
For models:	PE015M, PE115K, PG015M, PG115M		



Part No.	902459	Ref. No.	70042770 70042780 LAR70042770 LAR70042780
description	window gasket profile 1887/1515 L 2200mm suitable for LAINOX set 2-piece		

Part No.	901360	Ref. No.	70042710 LAR70042710
description	window gasket profile 1887/1515 L 2830mm set 2-piece suitable for LAINOX		
For models:	PE108D		
spare parts for	901360		

Part No.	900637	Ref. No.	70040640 70040650 LAR70040640 LAR70040650 R70040640 R70040650
description	window gasket profile 1530 Qty supplied by meter		

door seals

Part No.	902461	Ref. No.	70042860 LAR70042860
description	door seal profile 2010 L 1900mm Qty 1 suitable for LAINOX		
For models:	EC106M, EM106H, EM106M, EM106M+SC, EM106P, EV006M, EV106H, EV106M, EV106M+SC, EV106P, GC106M, GM106H, GM106M, GM106M+SC, GM106P, GV106H, GV106M, GV106M+SC, GV106P		

Part No.	901147	Ref. No.	70042880 LAR70042880
description	door seal profile 2010 L 3000mm Qty 1		
For models:	EC210M, EM210H, EM210M, EM210M+SC, EM210P, EV210H, EV210M, EV210M+SC, EV210P, GC210M, GM210H, GM210M, GM210M+SC, GM210P, GV210H, GV210M, GV210M+SC, GV210P		

Part No.	900142	Ref. No.	70042830 70043250 70043280 70043290 80100070 LAR70042830 LAR70043250 LAR70043280 LAR70043290 LAR80100070
description	door seal profile 2010 Qty supplied by meter		
For models:	CGC24M, MEC20H, MEC20P, MEC20X, MEC24H, MEK21H, MGC20H, MGC20X, MGC24H, PE015M, PE115K, PG015M, PG115M, VEC20P, VG106X, VGC20H, VGC24H		

Part No.	900131	Ref. No.	70040980 LAR70040980
description	door seal profile 2010 W 520mm L 610mm external size Qty 1		
For models:	ME106D, ME106H, ME106L, ME106M, ME106P, ME106S, ME106T, ME106X, MG106D, MG106H, MG106L, MG106M, MG106P, MG106S, MG106T, MG106X, VE106D, VE106H, VE106L, VE106M, VE106P, VE106S, VE106T, VE106X, VG106D, VG106H, VG106L, VG106M, VG106P, VG106S, VG106T, VG106X		

Part No.	900132	Ref. No.	70040990 70043260 LAR70040990 LAR70043260
description	door seal profile 2010 W 625mm L 750mm external size Qty 1		
For models:	ME110D, ME110H, ME110L, ME110M, ME110P, ME110S, ME110T, ME110X, MG110D, MG110H, MG110L, MG110M, MG110P, MG110S, MG110T, MG110X, VE110D, VE110H, VE110L, VE110M, VE110S, VE110T, VE110X, VG110D, VG110H, VG110L, VG110M, VG110P, VG110S, VG110T, VG110X		

Part No.	900134	Ref. No.	70041010 LAR70041010
description	door seal profile 2010 W 680mm L 1425mm external size Qty 1		
For models:	ME120D, ME120H, ME120L, ME120M, ME120P, ME120S, ME120T, ME120X, MG120D, MG120H, MG120L, MG120M, MG120P, MG120S, MG120T, MG120X, VE120D, VE120H, VE120L, VE120M, VE120P, VE120S, VE120X, VG120D, VG120H, VG120L, VG120M, VG120P, VG120X		

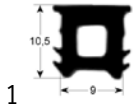

Part No.	900135	Ref. No.	70041020 LAR70041020
description	door seal profile 2010 W 700mm L 1410mm external size Qty 1		
For models:	ME220D, ME220H, ME220L, ME220M, ME220P, ME220S, ME220T, ME220X, MG220D, MG220H, MG220L, MG220M, MG220P, MG220S, MG220T, MG220X, VE220D, VE220H, VE220M, VE220P, VE220X, VG220D, VG220H, VG220M, VG220P, VG220X		

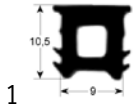

Part No.	900133	Ref. No.	70041000 LAR70041000
description	door seal profile 2010 W 740mm L 765mm external size Qty 1		
For models:	ME210D, ME210H, ME210L, ME210M, ME210P, ME210S, ME210T, ME210X, MG210D, MG210H, MG210L, MG210M, MG210P, MG210S, MG210T, MG210X, VE210D, VE210H, VE210L, VE210M, VE210P, VE210S, VE210T, VE210X, VG210D, VG210H, VG210L, VG210M, VG210P, VG210S, VG210T, VG210X		

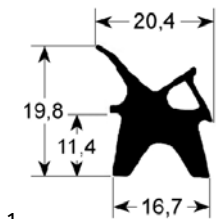

Part No.	900059	Ref. No.	80100490 LA80100491 LAR80100490
description	door seal profile 2410 Qty supplied by meter		

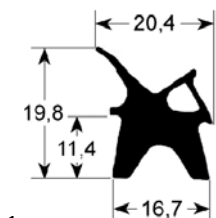

Part No.	900115	Ref. No.	70041760 70041990 70042070 LAR70041760 LAR70041990 LAR70042070
description	door seal profile 2410 W 320mm L 420mm external size Qty 1		
For models:	CVE004H, CVE004M, CVE104H, CVE104M, ME004L, ME004S, ME104L, ME104S, VE004D, VE004H, VE004M, VE004S, VE004X, VE104D, VE104H, VE104M, VE104S, VE104X		

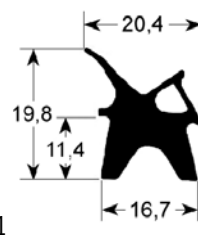

Part No.	900136	Ref. No.	50505940 70041200 LA70041201 LAR50505940 LAR70041200
description	door seal profile 2410 W 345mm L 560mm external size Qty 1		
For models:	FE05, FG05		

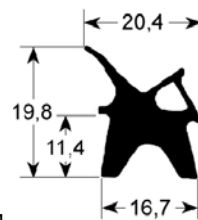

Part No.	900138	Ref. No.	50505953 70041210 LAR50505953 LAR70041210
description	door seal profile 2410 W 353mm L 405mm external size Qty 1		
For models:	FV03		

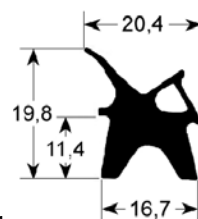

Part No.	900116	Ref. No.	70042000 70042080 LAR70042000 LAR70042080
description	door seal profile 2410 W 380mm L 608mm external size Qty 1		
For models:	CVE105H, CVE105M, CVG105H, CVG105M, ME105L, ME105S, MG105L, MG105S, VE105D, VE105H, VE105M, VE105S, VE105X, VE155H, VE155M, VE155X, VG105D, VG105H, VG105M, VG105S, VG105X		



Part No.	900157	Ref. No.	50505950 70041540 LAR50505950 LAR70041540
description	door seal profile 2410 W 380mm L 632mm external size Qty 1		
For models:	FE105M, FE105X, FG051M, FG051X, FG105M, FG105X, PE04, PE040M, PE040X, PG04, PG040M, PG040X, PG041M, PG041X, PG051X		

Part No.	900818	Ref. No.	70042570 70042571 LAR70042570 LAR70042571
description	door seal profile 2410 W 465mm L 765mm external size Qty 1		
For models:	EC110M, EM010M+SC, EM110H, EM110M, EM110M+SC, EM110P, EV110H, EV110M, EV110M+SC, EV110P, GC110M, GM110H, GM110M, GM110M+SC, GM110P, GV110H, GV110M, GV110M+SC, GV110P		

Part No.	900158	Ref. No.	50505941 70041250 70041260 LAR50505941 LAR70041250 LAR70041260
description	door seal profile 2410 W 413mm L 608mm external size Qty 1		
For models:	ME05, MG05, RE05, RG05		

Part No.	900123	Ref. No.	70042010 70042090 70043610 LA70042011 LAR70042010 LAR70042090 LAR70043610
description	door seal profile 2410 W 500mm L 627mm external size Qty 1		
For models:	ME106D, ME106H, ME106L, ME106M, ME106P, ME106S, ME106T, ME106X, MG106D, MG106H, MG106L, MG106M, MG106P, MG106S, MG106T, MG106X, VE106D, VE106H, VE106L, VE106M, VE106P, VE106S, VE106T, VE106X, VG106D, VG106L, VG106M, VG106P, VG106S, VG106T, VG106X		

Part No.	900156	Ref. No.	50505954 70041220 LAR50505954 LAR70041220
description	door seal profile 2410 W 427mm L 726mm external size Qty 1		
For models:	FV06		

Part No.	900485	Ref. No.	50505942 70041270 LAR50505942 LAR70041270
description	door seal profile 2410 W 583mm L 647mm external size Qty 1		
For models:	RE07, RG07		

Part No.	900817	Ref. No.	70042560 LAR70042560
description	door seal profile 2410 W 465mm L 495mm external size Qty 1		
For models:	EC106M, EM106H, EM106M, EM106M+SC, EM106P, EV006M, EV106H, EV106M, EV106M+SC, EV106P, GC106M, GM106H, GM106M, GM106M+SC, GM106P, GV106H, GV106M, GV106M+SC, GV106P		

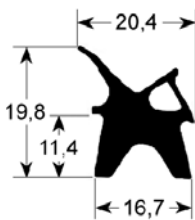

			
1			
Part No.	900816	Ref. No.	70042140 LAR70042140
description	door seal profile 2410 W 618mm L 777mm external size Qty 1		
For models:	ME227M, ME227P, ME227X, MG227M, MG227P, MG227X		

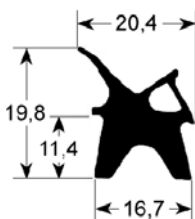
			
1			
Part No.	900124	Ref. No.	70042020 70042100 70043620 LA70042021 LAR70042020 LAR70042100 LAR70043620
description	door seal profile 2410 W 627mm L 738mm external size Qty 1		
For models:	ME110D, ME110H, ME110L, ME110M, ME110P, ME110S, ME110T, ME110X, MG110D, MG110H, MG110L, MG110M, MG110P, MG110S, MG110T, MG110X, VE110D, VE110H, VE110L, VE110M, VE110S, VE110T, VE110X, VEC20P, VG110D, VG110H, VG110L, VG110M, VG110P, VG110S, VG110T, VG110X		

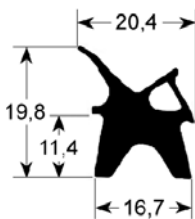
			
1			
Part No.	900820	Ref. No.	70042580 LAR70042580
description	door seal profile 2410 W 645mm L 765mm external size Qty 1		
For models:	EC210M, EM210H, EM210M, EM210M+SC, EM210P, EV210H, EV210M, EV210M+SC, EV210P, GC210M, GM210H, GM210M, GM210M+SC, GM210P, GV210H, GV210M, GV210M+SC, GV210P		

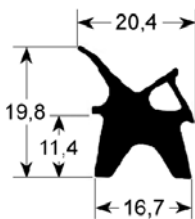
			
1			
Part No.	900159	Ref. No.	50505943 70041290 70041300 LAR50505943 LAR70041290 LAR70041300
description	door seal profile 2410 W 655mm L 755mm external size Qty 1		
For models:	ME10, MG10, MME10, RE10, RG10		

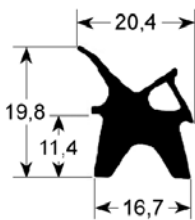
			
1			
Part No.	900486	Ref. No.	50505951 70041550 LAR50505951 LAR70041550
description	door seal profile 2410 W 666mm L 701mm external size Qty 1		
For models:	FE110M, FE110X, FG101M, FG101X, FG110M, FG110X, PE08, PE080M, PE080X, PG08, PG080M, PG080X, PG081M, PG081X, PG101M, PG101X		

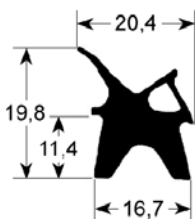
			
1			
Part No.	901260	Ref. No.	70042510 LAR70042510
description	door seal profile 2410 W 675mm L 775mm external size Qty 1 suitable for LAINOX		
For models:	PE108D		

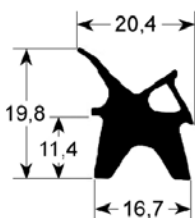
			
1			
Part No.	900762	Ref. No.	50505944 70041330 70041350 70041840 LAR50505944 LAR70041330 LAR70041350 LAR70041840
description	door seal profile 2410 W 701mm L 705mm external size Qty 1		
For models:	FE210M, FG210M, FG210X, ME20, MG20, RE20, RG20		



1			
Part No.	900165	Ref. No.	50505945 70041780 LAR50505945 LAR70041780
description	door seal profile 2410 W 710mm L 1195mm external size Qty 1		
For models:	ME15, MG15		

2			
Part No.	900568	Ref. No.	70042150 LAR70042150
description	door seal profile 2410 W 710mm L 1310mm external size Qty 1		
For models:	MEC20H, MEC20P, MEC20X, MEK21H, MGC20H, MGC20X, VGC20H		

1			
Part No.	900126	Ref. No.	50505948 70041820 70042040 70042120 70042530 LAR50505948 LAR70041820 LAR70042040 LAR70042120 LAR70042530
description	door seal profile 2410 W 710mm L 1430mm external size Qty 1		
For models:	ME120D, ME120H, ME120L, ME120M, ME120P, ME120S, ME120T, ME120X, ME21, MG120D, MG120H, MG120L, MG120M, MG120P, MG120S, MG120T, MG120X, MG21, PE015M, PE115K, PG115M, VE120D, VE120H, VE120M, VE120P, VE120X, VG120D, VG120H, VG120M, VG120P, VG120X		

1			
Part No.	900139	Ref. No.	50505946 70041370 LAR50505946 LAR70041370
description	door seal profile 2410 W 715mm L 880mm external size Qty 1		
For models:	ME24, MG24, RE24, RG24		

1			
Part No.	900813	Ref. No.	70042160 LAR70042160
description	door seal profile 2410 W 735mm L 1310mm external size Qty 1		
For models:	CGC40M, MEC40H, MEC40M, MGC40H, MGC40P, VES40M		

1			
Part No.	900127	Ref. No.	50505947 70041410 70041860 70042050 70042130 LAR50505947 LAR70041410 LAR70041860 LAR70042050 LAR70042130
description	door seal profile 2410 W 735mm L 1430mm external size Qty 1		
For models:	ME220D, ME220H, ME220L, ME220M, ME220P, ME220S, ME220T, ME220X, ME40, MG220D, MG220H, MG220L, MG220M, MG220P, MG220S, MG220T, MG220X, MG40, RG40, VE220D, VE220H, VE220M, VE220P, VE220X, VES40M, VG220D, VG220H, VG220M, VG220P, VG220X, VGS40M		

1			
Part No.	900815	Ref. No.	70041940 LAR70041940
description	door seal profile 2410 W 735mm L 830mm external size Qty 1		
For models:	CGC24M, MEC24H, MGC24H, VGC24H		

1			
Part No.	900814	Ref. No.	70041930 LAR70041930
description	door seal profile 2410 W 735mm L 955mm external size Qty 1		



1			
Part No.	900125	Ref. No.	70042030 70042110 LAR70042030 LAR70042110
description	door seal profile 2410 W 738mm L 777mm external size Qty 1		
For models:	ME210D, ME210H, ME210L, ME210M, ME210P, ME210S, ME210T, ME210X, MG210D, MG210H, MG210L, MG210M, MG210P, MG210S, MG210T, MG210X, VE210D, VE210H, VE210L, VE210M, VE210P, VE210S, VE210T, VE210X, VG210D, VG210H, VG210L, VG210M, VG210P, VG210S, VG210T, VG210X		

1			
Part No.	900487	Ref. No.	50505952 70041560 LAR50505952 LAR70041560
description	door seal profile 2410 W 765mm L 1195mm external size Qty 1		
For models:	PE12, PG12		

1			
Part No.	901447	Ref. No.	70044510 A23203290 LAR70044510
description	door seal profile 2452 L 2900mm		
For models:	RC162M, RM262E, RM262M		

1			
Part No.	901444	Ref. No.	70044520 A32100810 LAR70044520
description	door seal profile 2452 Qty 3300mm		
For models:	RB102S		

1			
Part No.	901445	Ref. No.	70044490 LAR70044490
description	door seal profile 2452 W 380mm H 280mm plug size Qty 1 4-piece		

1			
Part No.	901443	Ref. No.	70044540 LA70044540 LAR70044540
description	door seal profile 2452 W 640mm H 490mm plug size 4-piece		

1			
Part No.	901442	Ref. No.	70044500 LAR70044500
description	door seal profile 2452 W 640mm H 655mm plug size Qty 1 4-piece		

1			
Part No.	901446	Ref. No.	70044450 LAR70044450
description	door seal profile 2452 W 650mm H 795mm plug size Qty 1 4-piece		



1			
Part No.	901448	Ref. No.	70044530 LA70044530 LAR70044530
description	door seal profile 2452 W 675mm H 1310mm plug size Qty 1		

1			
Part No.	902392	Ref. No.	70044890 LA70044890 LA70044892 LAR70044890
description	door seal profile 2761 W 400mm L 440mm outer plug size suitable for LAINOX		

1			
Part No.	902458	Ref. No.	70044930 70044932 LA70044932 LAR70044930 LAR70044932
description	door seal profile 2761 W 405mm L 685mm outer plug size Qty 1		

1			
Part No.	902023	Ref. No.	70048010 LA70048012 LAR70048010
description	door seal profile 2761 W 46mm L 775mm external size Qty 1 suitable for LAINOX		

1			
Part No.	902024	Ref. No.	70048000 LA70048002 LAR70048000
description	door seal profile 2761 W 470mm L 560mm external size Qty 1		

1			
Part No.	902153	Ref. No.	70044810 LA70044812 LAR70044810
description	door seal profile 2761 W 550mm L 700mm external size Qty 1 suitable for LAINOX		

1			
Part No.	902453	Ref. No.	70044870 70044872 LAR70044870 LAR70044872
description	door seal profile 2761 W 555mm L 615mm outer plug size Qty 1 suitable for LAINOX		

1			
Part No.	902452	Ref. No.	70044820 LA70044822 LAR70044820
description	door seal profile 2761 W 585mm L 615mm outer plug size Qty 1 suitable for LAINOX		



Part No.	902134	Ref. No.	70044830 LAR70044830 LAR70044832
description	door seal profile 2761 W 620mm L 780mm external size Qty 1 suitable for LAINOX		

Part No.	902154	Ref. No.	70044920 LA70044922 LAR70044920
description	door seal profile 2761 W 700mm L 1510mm external size Qty 1 suitable for LAINOX		

Part No.	902451	Ref. No.	70044910 LA70044910 LAR70044910
description	door seal profile 2761 W 685mm L 1480mm outer plug size Qty 1 suitable for LAINOX		

Part No.	902457	Ref. No.	70044840 70044842 LAR70044840 LAR70044842
description	door seal profile 2761 W 730mm L 770mm outer plug size Qty 1 suitable for LAINOX		

Part No.	902450	Ref. No.	70044860 LA70044862 LAR70044860
description	door seal profile 2761 W 685mm L 775mm outer plug size Qty 1 suitable for LAINOX		



Part No.	902454	Ref. No.	70044880 70044882 LA70044882 LAR70044880 LAR70044882
description	door seal profile 2761 W 690mm L 775mm outer plug size Qty 1 suitable for LAINOX		

Part No.	901573	Ref. No.	70044270 LA70044270 LAR70044270
description	door seal profile 2770/2771 H 1550mm W 470mm outer plug size Qty 1		
For models:	GEMT10P, GEMT10T, GEMT20P, GEMT20T, GEMT21P, GEMT21T, GEVT10P, GEVT10T, GEVT20P, GEVT20T, GEVT21P, GEVT21T, GGMT10P, GGMT10T, GGMT20P, GGMT20T, GGMT21P, GGMT21T, GGV10P, GGV10T, GGV20P, GGV20T, GGV21P, GGV21T, GMT20D, GMT20P, GVT20D, HME102P, HME102T, HME102X, HMG102P, HMG102T, HMG102X, HVE102P, HVE102T, HVE102X, HVG102P, HVG102T, HVG102X, ME102D, ME102P, ME102T, MEMT20D, MEMT20P, MEMT21D, MEMT21P, MEVT20D, MEVT20P, MEVT21D, MEVT21P...(Other models you can see in the webshop)		

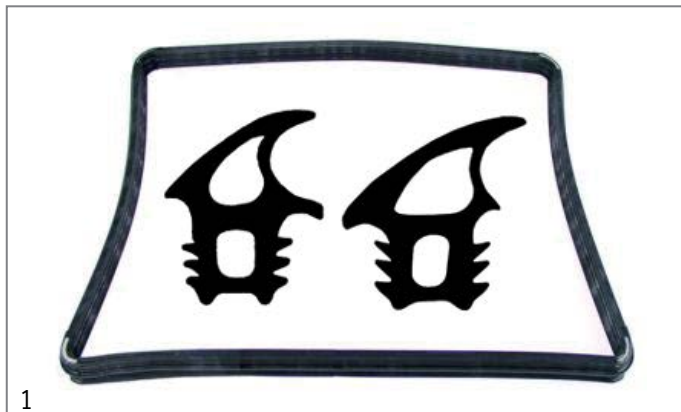

1

Part No.	900493	Ref. No.	70044130 LA70044130 LAR70044130
description	door seal profile 2770/2771 H 1550mm W 680mm outer plug size Qty 1		
For models:	EPE156T, EPEV15T, EPG156T, EPGV15T, HME201P, HME201T, HME201X, HMG201P, HMG201T, HMG201X, HVE201P, HVE201T, HVE201X, HVG201P, HVG201T, HVG201X, MCE201M, MCG201M, ME201D, ME201H, ME201M, ME201P, ME201T, MG201D, MG201H, MG201M, MG201P, MG201T, PE156T, VE201D, VE201M, VE201P, VG201D, VG201M, VG201P		

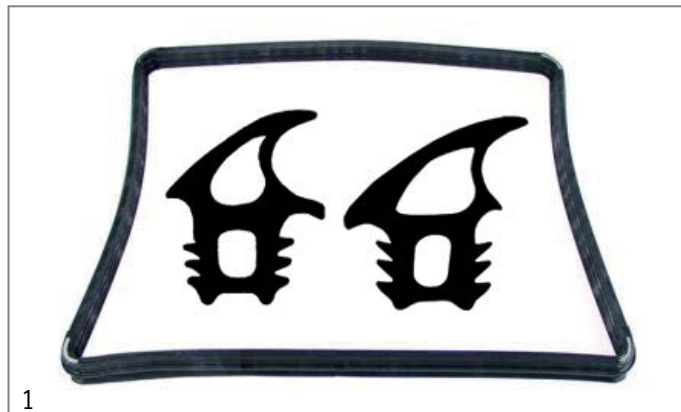

1

Part No.	900488	Ref. No.	70044330 LA70044330 LAR70044330
description	door seal profile 2770/2771 H 380mm W 420mm outer plug size Qty 1		
For models:	CE041M, MACE04M, MCE042M, MVE042P, VE042P		

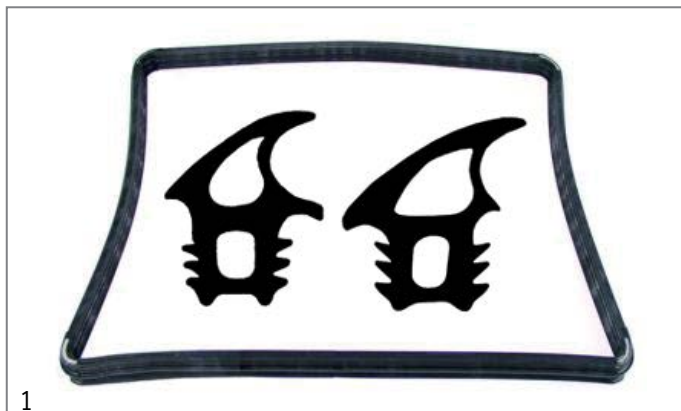

1

Part No.	900494	Ref. No.	70044140 LA70044140 LAR70044140
description	door seal profile 2770/2771 H 1550mm W 700mm outer plug size Qty 1		
For models:	GEMT40P, GEMT40T, GEVT40P, GEVT40T, GGMT40P, GGMT40T, GGVT40P, GGVT40T, HME202P, HME202T, HME202X, HMG202P, HMG202T, HMG202X, HVE202P, HVE202T, HVE202X, HVG202P, HVG202T, HVG202X, MCE202M, MCG202M, ME202D, ME202H, ME202M, ME202P, ME202T, MEMT40D, MEMT40P, MEVT40D, MEVT40P, MG202D, MG202H, MG202M, MG202P, MG202T, MGMT40D, MGMT40P, MGVT40D, MGVT40P, VE202D, VE202M, VE202P, VG202D, VG202M, VG202P		

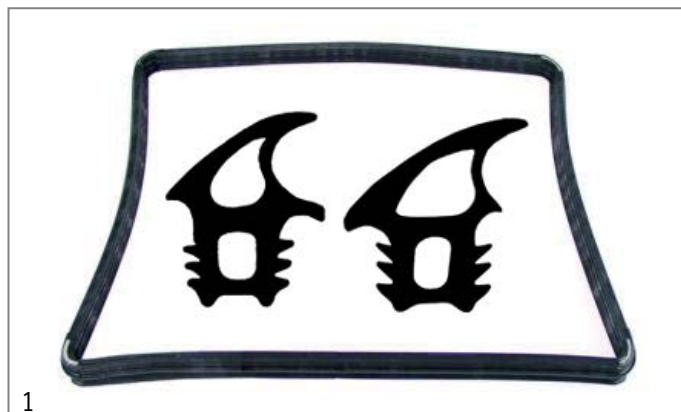

1

Part No.	900489	Ref. No.	70044340 LA70044340 LAR70044340
description	door seal profile 2770/2771 H 440mm W 600mm outer plug size Qty 1		
For models:	BPG044M, BPG044P, BPG054M, BPG054P, CE051M, CG051M, MACE05M, MACG05M, MCE051M, MCG051M, MVE051P, MVG051P, VE051P, VE055P, VG051P		

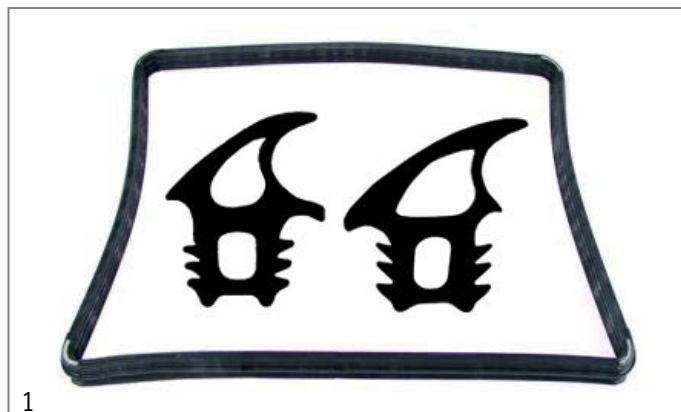

1

Part No.	902183	Ref. No.	70044350 LA70044350 LAR70044350
description	door seal profile 2770/2771 H 440mm W 670mm outer plug size Qty 1		
For models:	BPE044M, BPE044P, BPE054M, BPE054P		

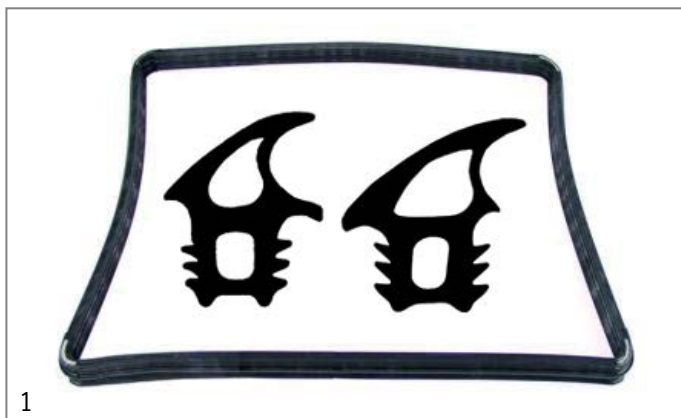

1

Part No.	901679	Ref. No.	70044210 LA70044210 LAR70044210
description	door seal profile 2770/2771 H 520mm W 470mm outer plug size suitable for LAINOX		
For models:	EMT06D, GEMT06P, GEMT06T, GEVT06P, GEVT06T, GGMT06P, GGMT06T, GGVTO6P, GGVTO6T, GMT06D, GVT06D, MEMT06D, MEMT06P, MEVT06D, MEVT06P, MGMT06D, MGMT06P, MGVT06D, MGVT06P		

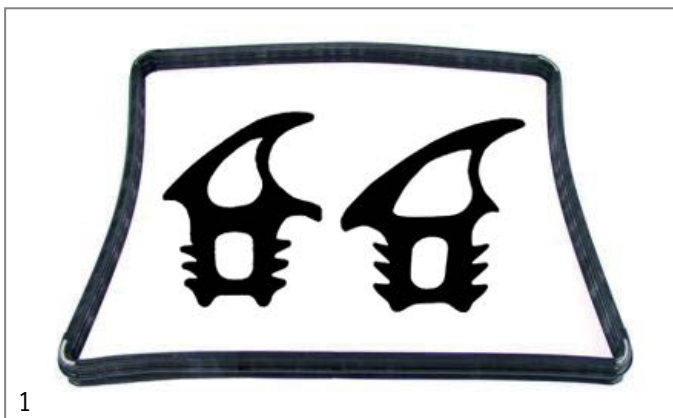

1

Part No.	900788	Ref. No.	70044230 LA70044230 LAR70044230
description	door seal profile 2770/2771 H 580mm W 680mm outer plug size Qty 1		
For models:	AVE07D, BPE064M, BPE064P, BPE074M, BPE074P, BPG064M, BPG064P, BPG074M, BPG074P, CE071M, CG071M, MACE07M, MACG07M, MCE071M, MCG071M, MME071P, MMG071P, MVE071M, MVE071P, MVG071P		



1

Part No.	900490	Ref. No.	70044100 LA70044100 LAR70044100
description	door seal profile 2770/2771 H 520mm W 620mm outer plug size Qty 1		
For models:	EPG056T, EPGV05T, HME061P, HME061T, HME061X, HMG061P, HMG061T, HMG061X, HVE061P, HVE061T, HVE061X, HVG061P, HVG061T, HVG061X, ME061D, ME061H, ME061M, ME061P, ME061T, MG061D, MG061H, MG061M, MG061P, MG061T, VE061D, VE061M, VE061P, VG061D, VG061M, VG061P		



1

Part No.	901716	Ref. No.	70044400 70044401 LA70044400 LA70044401 LAR70044400 LAR70044401
description	door seal profile 2770/2771 H 610mm W 600mm outer plug size Qty 1		

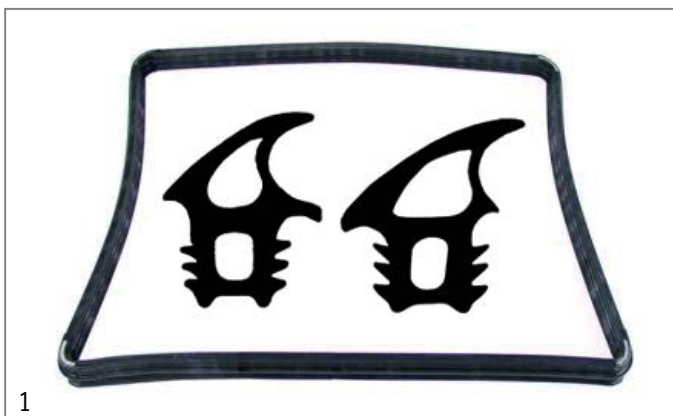

1

Part No.	902184	Ref. No.	70044430 LA70044430 LAR70044430
description	door seal profile 2770/2771 H 610mm W 670mm outer plug size Qty 1		



1			
Part No.	901276	Ref. No.	70044220 LA70044220 LAR70044220
description	door seal profile 2770/2771 H 800mm W 470mm outer plug size Qty 1 suitable for LAINOX		
For models:	GEMT10P, GEMT10T, GEVT10P, GEVT10T, GGMT10P, GGMT10T, GGVT10P, GGVT10T, MEMT10D, MEMT10P, MEVT10D, MEVT10P, MGMT10D, MGMT10P, MGVT10D, MGVT10P		

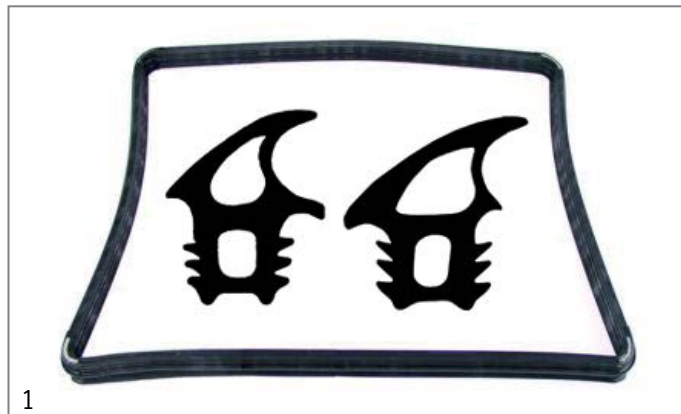

1			
Part No.	900492	Ref. No.	70044120 LA70044120 LAR70044120
description	door seal profile 2770/2771 H 800mm W 700mm outer plug size Qty 1		
For models:	GEMT20P, GEMT20T, GEVT20P, GEVT20T, GGMT20P, GGMT20T, GGVT20P, GGVT20T, GMT20D, GMT20P, GVT20D, HME102P, HME102T, HME102X, HMG102P, HMG102T, HMG102X, HVE102P, HVE102T, HVE102X, HVG102P, HVG102T, HVG102X, ME102D, ME102H, ME102M, ME102P, ME102T, MEMT20D, MEMT20P, MEVT20D, MEVT20P, MG102D, MG102H, MG102M, MG102P, MG102T, MGMT20D, MGMT20P, MGVT20D, MGVT20P, VE102D, VE102M, VE102P, VG102D, VG102M, VG102P		



1			
Part No.	900491	Ref. No.	70044110 LA70044110 LAR70044110
description	door seal profile 2770/2771 H 800mm W 680mm outer plug size Qty 1		
For models:	ACG10M, AVE10D, AVE10P, BPE084M, BPE084P, BPE104M, BPE104P, BPG084M, BPG084P, BPG104M, BPG104P, CE100M, CG100M, EPE086T, EPEV08T, EPG086T, EPGV08T, HME101P, HME101T, HME101X, HMG101P, HMG101T, HMG101X, HVE101P, HVE101T, HVE101X, HVG101P, HVG101T, HVG101X, MACE10M, MACG10M, MCE101M, MCG101M, ME101D, ME101H, ME101M, ME101P, ME101T, MG101D, MG101H, MG101M, MG101P, MG101T, MME101P, MMG101P, MVE101M, MVE101P, MVG101P, PG084, PG104M...(Other models you can see in the webshop)		



1			
Part No.	901603	Ref. No.	70044240 LA70044240 LAR70044240
description	door seal profile 2770/2771 H 800mm W 760mm outer plug size Qty 1		
For models:	CE200M, CG200M, MACE20M, MACG20M, MCE102M, MCG102M, MME102P, MMG102P, MVE102P, MVG102P		



1

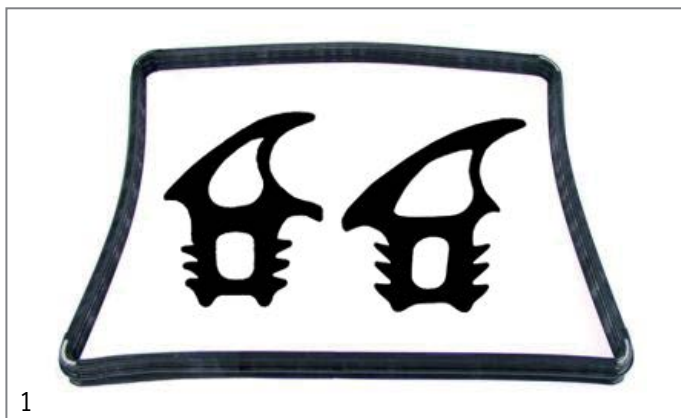

1

Part No.	901402	Ref. No.	70044410 LA70044410 LAR70044410
description	door seal profile 2770/2771 H 820mm W 600mm outer plug size Qty 1		



1

Part No.	902185	Ref. No.	70044440 LA70044440 LAR70044440
description	door seal profile 2770/2771 H 820mm W 670mm outer plug size Qty 1		

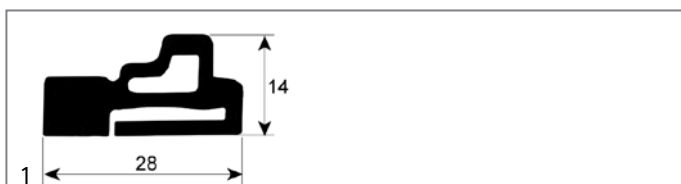

1

Part No.	900745	Ref. No.	70044300 LAR70044300
description	door seal profile 2954 L 700mm		
For models:	GEMT40P, GEMT40T, GEVT40P, GEVT40T, GGMT40P, GGMT40T, GGV40P, GGV40T, HME201P, HME201T, HME201X, HME202P, HME202T, HME202X, HMG201P, HMG201T, HMG201X, HMG202P, HMG202T, HMG202X, HVE201P, HVE201T, HVE201X, HVE202P, HVE202T, HVE202X, HVG201P, HVG201T, HVG201X, HVG202P, HVG202T, HVG202X, ME201D, ME201H, ME201M, ME201P, ME201T, ME202D, ME202H, ME202M, ME202P, ME202T, MEMT40D, MEMT40P, MEVT40D, MEVT40P, MG201D, MG201H, MG201M, MG201P...(Other models you can see in the webshop)		



Part No.	901950	Ref. No.	LA70044060 LAR70044060
description	door seal profile 2959		

door seals with fixing hook



Part No.	902463	Ref. No.	70044000 LA70044000 LAR70044000
description	door seal L 2660mm 4-sided with 8 mounting clips		

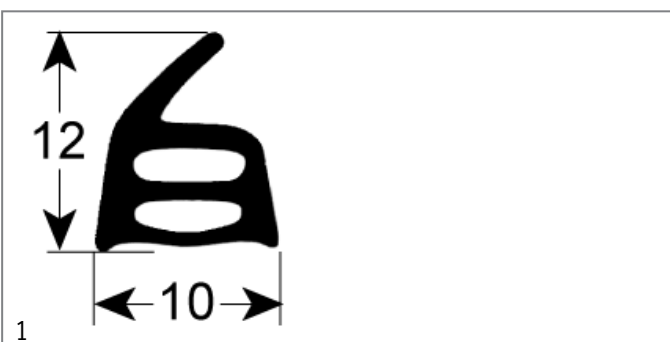

Part No.	901817	Ref. No.	70044710 LA70044710 LAR70044710
description	door seal L 540mm W 400mm 4-sided with 10 mounting clips LAINOX for model REC051 and REC051M		



Part No.	902181	Ref. No.	70044720 LA70044720 LAR70044720
description	door seal L 560mm W 550mm 4-sided with 12 mounting clips		



Part No.	902182	Ref. No.	70044730 LA70044730 LAR70044730
description	door seal L 760mm W 550mm 4-sided with 14 mounting clips		

Part No.	901371	Ref. No.	70044030 LA70044030 LAR70044030
description	oven gasket L 540mm W 390mm with 6 mounting clips		
For models:	A05RES, A05RES+UM		

Part No.	901460	Ref. No.	70044020 LA70044020 LAR70044020
description	door seal W 375mm with 4 mounting clips H 330mm		

Part No.	901278	Ref. No.	70044010 LAR70044010
description	door seal W 550mm H 750mm external size		
For models:	A08RES, A08RES+UM, A10RES, A10RES+UM		

Part No.	901434	Ref. No.	70044040 LA70044040 LAR70044040
description	door seal W 600mm with 6 mounting clips H 400mm		
For models:	A05PES		

gaskets for tray rack trolleys

Part No.	901160	Ref. No.	70044320 70044360 70044362 LAR70044320 LAR70044360 LAR70044362
description	tray rack trolley gasket L <700mm 3-piece		
For models:	EPE156T, EPEV15T, EPG156T, EPGV15T, GEMT40P, GEMT40T, GEVT40P, GEVT40T, GGMT40P, GGMT40T, GGVT40P, GGVT40T, HME201P, HME201T, HME201X, HME202P, HME202T, HME202X, HMG201P, HMG201T, HMG201X, HMG202P, HMG202T, HMG202X, HVE201P, HVE201T, HVE201X, HVE202P, HVE202T, HVE202X, HVG201P, HVG201T, HVG201X, HVG202P, HVG202T, HVG202X, MCE201M, MCE202M, MCG201M, MCG202M		





1

Part No.	901161	Ref. No.	80100910 LA80100910 LAR80100910
description	tray rack trolley gasket L 1000mm		
For models:	EPE156T, EPEV15T, EPG156T, EPGV15T, GEMT21P, GEMT21T, GEMT40P, GEMT40T, GEVT21P, GEVT21T, GEVT40P, GEVT40T, GGMT21P, GGMT21T, GGMT40P, GGMT40T, GGV21P, GGV21T, GGV40P, GGV40T, HME201P, HME201T, HME201X, HME202P, HME202T, HME202X, HMG201P, HMG201T, HMG201X, HMG202P, HMG202T, HMG202X, HVE201P, HVE201T, HVE201X, HVE202P, HVE202T, HVE202X, HVG201P, HVG201T, HVG201X, HVG202P, HVG202T, HVG202X, MCE201M, MCE202M, MCG201M, MCG202M		



1

Part No.	901711	Ref. No.	70044370 LAR70044370
description	tray rack trolley gasket L 510mm 3-piece		
For models:	GEMT21P, GEMT21T, GEVT21P, GEVT21T, GGMT21P, GGMT21T, GGV21P, GGV21T		



1

Part No.	902462	Ref. No.	70044361 LAR70044361
description	tray rack trolley gasket L 750mm 3-piece		

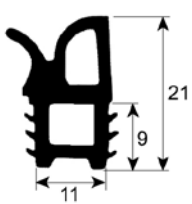

1

Part No.	900776	Ref. No.	70041150 LAR70041150
description	tray rack trolley gasket profile 4050 L 1020mm Qty 1		
For models:	CGC24M, CGC40M, MEC20H, MEC20P, MEC20X, MEC24H, MEC40H, MEC40M, MEK21H, MGC20H, MGC20X, MGC24H, MGC40H, MGC40P, VEC20P, VES40M, VGC20H, VGC24H		

O-rings

EPDM



1

Part No.	510322	Ref. No.	70010250 LA70010250 LAR70010250
description	O-ring EPDM thickness 1.78mm ID ø 17.17mm Qty 1 pcs		



1

Part No.	504590	Ref. No.	70010210 LAR70010210
description	O-ring EPDM thickness 2.62mm ID ø 18.72mm Qty 1 pcs		



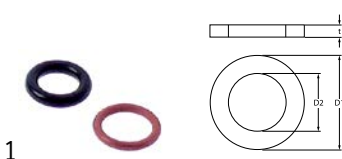

Part No.	510409	Ref. No.	70045010 LA70045010 LAR70045010
description	O-ring EPDM thickness 5.34mm ID ø 56.52mm Qty 1 pcs		
For models:	EMT06D, GEMT06P, GEMT06T, GEMT10P, GEMT10T, GEMT20P, GEMT20T, GEMT21P, GEMT21T, GEVT21P, GEVT21T, GGMT21P, GGMT21T, GGV21P, GGV21T, HME061P, HME061T, HME061X, HME101P, HME101T, HME101X, HME102P, HME102T, HME102X, HME201P, HME201T, HME201X, ME061P, ME061T, ME101D, ME101M, ME101P, ME101T, ME102D, ME102M, ME102P, ME102T, ME201D, ME201H, ME201M, ME201P, ME201T, ME202D, ME202H, ME202M, ME202P, ME202T, MEMT06D, MEMT06P, MEMT10D...(Other models you can see in the webshop)		

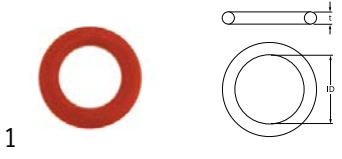

Part No.	532492	Ref. No.	70010050 LAR70010050
description	O-ring set EPDM thickness 1.78/2.62mm ID ø 9.25/7.59mm Qty 2 pcs		
For models:	EPE056T, EPE086T, EPE156T, EPEV05T, EPEV08T, EPEV15T, EPG056T, EPG086T, EPG156T, EPGV05T, EPGV08T, EPGV15T, GEMT06P, GEMT06T, GEMT10P, GEMT10T, GEMT20P, GEMT20T, GEMT21P, GEMT21T, GEMT40P, GEMT40T, GEVT06P, GEVT06T, GEVT10P, GEVT10T, GEVT20P, GEVT20T, GEVT21P, GEVT21T, GEVT40P, GEVT40T, GGMT06P, GGMT06T, GGMT10P, GGMT10T, GGMT20P, GGMT20T, GGMT21P, GGMT21T, GGMT40P, GGMT40T, GGV206P, GGV206T, GGV210P, GGV210T, GGV220P, GGV220T, GGV221P, GGV221T...(Other models you can see in the webshop)		

silicone



Part No.	371100	Ref. No.	70010030 LAR70010030
description	O-ring silicone thickness 1.78mm ID ø 6.07mm Qty 1 pcs		

Viton

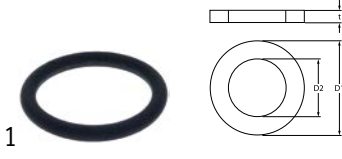

Part No.	512506	Ref. No.	70010080 LA70010080 LAR70010080
description	O-ring Viton thickness 2mm ID ø 14mm Qty 1 pcs		

sealing washers

aluminium gaskets



Part No.	560633	Ref. No.	70030060 LA70030060 LAR70030060
description	gasket aluminium ED ø 29.5mm ID ø 23.5mm thickness 2mm Qty 1 pcs		

fibre gaskets



Part No.	508031	Ref. No.	70030030 LA70030030 LAR70030030
description	flat gasket FIBER ED ø 19mm ID ø 10.5mm thickness 2mm Qty 1 pcs		



Part No.	518393	Ref. No.	70030040 70030050 LAR70030040 LAR70030050
description	flat gasket FIBER ED ø 24mm ID ø 17mm thickness 2mm Qty 1 pcs		
For models:	MG120D, MG120H, MG120M, MG120P, MG120X, MG227M, MG227P, MG227X, MGC20H, MGC20X		



Part No.	510404	Ref. No.	682770
description	flat gasket fibre ED ø 44mm ID ø 34mm thickness 2mm Qty 1 pcs		

graphite gaskets



Part No.	696702	Ref. No.	63140070 LA63140070 LAR63140070
description	gasket graphite ED ø 84mm ID ø 61mm thickness 3mm Qty 1 pcs		
For models:	BPG044M, BPG044P, BPG054M, BPG054P, BPG064M, BPG064P, BPG074M, BPG074P, EPG056T, EPGV05T, GGMT06P, GGMT06T, GGV206P, GGV206T, HMG061P, HMG061T, HMG061X, HVG061P, HVG061T, HVG061X, MCG051M, MCG071M, MMG071P, MVG051P, MVG071P		



rubber gaskets



1

Part No.	508424	Ref. No.	70050140 LA70050140 LAR70050140
description	flat gasket rubber ED ø 40mm ID ø 27mm thickness 2.5mm Qty 1 pcs		

shaft gaskets

shaft gaskets



1

Part No.	511171	Ref. No.	50505880 70020040 LA70020040 LAR50505880 LAR70020040
description	shaft seal ID ø 14.5mm ED ø 20mm thickness 3mm		
For models:	AVE07D, BPE064M, BPE064P, BPE074M, BPE074P, BPG064M, BPG064P, BPG074M, BPG074P, CE071M, CG071M, CVE105H, CVE105M, CVG105H, CVG105M, EC106M, EM106H, EM106M, EM106M+SC, EM106P, EMT06D, EPE056T, EPEV05T, EPG056T, EPGV05T, EV006M, EV106H, EV106M, EV106M+SC, EV106P, FE105M, FE105X, FG051M, FG051X, FG105M, FG105X, GC106M, GEMT06P, GEMT06T, GEMT10P, GEMT10T, GEMT21P, GEMT21T, GEVT06P, GEVT06T, GEVT10P, GEVT10T, GEVT21P, GEVT21T, GGMT06P...(Other models you can see in the webshop)		



1

Part No.	511170	Ref. No.	50505895 70020010 LAR50505895 LAR70020010
description	shaft seal ID ø 7mm ED ø 22mm thickness 7mm		
For models:	CVE004H, CVE004M, CVE104H, CVE104M, ME004L, ME004S, ME104L, ME104S, VE004D, VE004H, VE004M, VE004S, VE004X, VE104D, VE104H, VE104M, VE104S, VE104X		



1

Part No.	511172	Ref. No.	50505890 70020050 LA70020050 LAR50505890 LAR70020050
description	shaft sealing ID ø 24mm ED ø 29mm thickness 3mm		
For models:	ACG10M, AVE10D, AVE10P, BPE084M, BPE084P, BPE104M, BPE104P, BPG084M, BPG084P, BPG104M, BPG104P, CE100M, CE200M, CG100M, CG200M, CGC24M, CGC40M, EC110M, EC210M, EM010M+SC, EM110H, EM110M, EM110M+SC, EM110P, EM210H, EM210M, EM210M+SC, EM210P, EPE086T, EPE156T, EPEV08T, EPEV15T, EPG086T, EPG156T, EPGV08T, EPGV15T, EV110H, EV110M, EV110M+SC, EV110P, EV210H, EV210M, EV210M+SC, EV210P, FE110M, FE110X, FE210M, FG101M, FG101X, FG110M...(Other models you can see in the webshop)		

special gaskets

for combi-steamers



1

Part No.	512507	Ref. No.	70050090 LA70050090 LAR70050090
description	gasket suitable for LAINOX ED ø 23mm ID ø 15.5mm rubber thickness 3.2mm 21 Qty 1 pcs		



1

Part No.	699384	Ref. No.	63140050 LA63140050 LAR63140050
description	gasket suitable for LAINOX ED ø 84mm ID ø 50mm fibre thickness 2mm hole distance 50mm hole ø 6mm		
For models:	ACG10M, BPG044M, BPG044P, BPG054M, BPG054P, BPG064M, BPG064P, BPG074M, BPG074P, BPG084M, BPG084P, BPG104M, BPG104P, CG051M, CG071M, CG100M, CG200M, EPG056T, EPG086T, EPG156T, EPGV05T, EPGV08T, EPGV15T, GGMT06P, GGMT06T, GGMT10P, GGMT10T, GGMT20P, GGMT20T, GGMT21P, GGMT21T, GGMT40P, GGMT40T, GGVT06P, GGVT06T, GGVT10P, GGVT10T, GGVT20P, GGVT20T, GGVT21P, GGVT21T, GGVT40P, GGVT40T, GMT06D, GMT20D, GMT20P, GVT06D, GVT20D, HMG061P, HMG061T...(Other models you can see in the webshop)		

1

Part No.	694955	Ref. No.	63140010 LA63140010 LAR63140010
description	gasket suitable for LAINOX L 80mm W 65mm combi-steamer ID ø 51mm graphite thickness 3mm hole distance 45x60mm		
For models:	BPG044M, BPG044P, BPG054M, BPG054P, BPG064M, BPG064P, BPG074M, BPG074P, BPG084M, BPG084P, BPG104M, BPG104P, CG051M, CG071M, EPG056T, EPG086T, EPG156T, EPGV05T, EPGV08T, EPGV15T, GGMT06P, GGMT06T, GGMT10P, GGMT10T, GGMT20P, GGMT20T, GGMT21P, GGMT21T, GGMT40P, GGMT40T, GGVT06P, GGVT06T, GGVT10P, GGVT10T, GGVT20P, GGVT20T, GGVT21P, GGVT21T, GGVT40P, GGVT40T, GMT06D, GVT06D, HMG061P, HMG061T, HMG061X, HMG101P, HMG101T, HMG101X, HMG102P, HMG102T...(Other models you can see in the webshop)		



1

Part No.	699383	Ref. No.	63140080 LA63140080 LAR63140080
description	gasket suitable for LAINOX Qty 1m ED ø 126mm ID ø 90mm graphite thickness 3mm hole distance 42mm hole ø 7mm		
For models:	BPG084M, BPG084P, BPG104M, BPG104P, EPG086T, EPG156T, EPGV08T, EPGV15T, GGMT10P, GGMT10T, GGMT20P, GGMT20T, GGMT21P, GGMT21T, GGMT40P, GGMT40T, GGVT10P, GGVT10T, GGVT20P, GGVT20T, GGVT21P, GGVT21T, GGVT40P, GGVT40T, HMG101P, HMG101T, HMG101X, HMG102P, HMG102T, HMG102X, HMG201P, HMG201T, HMG201X, HMG202P, HMG202T, HMG202X, HVG101P, HVG101T, HVG101X, HVG102P, HVG102T, HVG102X, HVG201P, HVG201T, HVG201X, HVG202P, HVG202T, HVG202X, MCG101M, MCG102M...(Other models you can see in the webshop)		



1

Part No.	902464	Ref. No.	70010130 LA70010130 LAR70010130
description	gasket suitable for LAINOX Qty 1m ED ø 80mm ID ø 50mm silicone thickness 3mm hole distance 54mm hole ø 6mm		



1

Part No.	699247	Ref. No.	70045120 LAR70045120
description	gasket set for combi-steamer		



1

Part No.	699385	Ref. No.	70045100 LAR70045100
description	gasket set suitable for LAINOX for cleaning system		
For models:	GEMT10P, GEMT10T, GEMT20P, GEMT20T, GEVT10P, GEVT10T, GEVT20P, GEVT20T, GGMT10P, GGMT10T, GGMT20P, GGMT20T, GGVT10P, GGVT10T, GGVT20P, GGVT20T, GMT20P, HME102P, HME102T, HME102X, HMG102P, HMG102T, HMG102X, HVE102P, HVE102T, HVE102X, HVG102P, HVG102T, HVG102X, ME102T, MEMT10P, MEMT20P, MG102T, MGMT10P, MGMT20P		

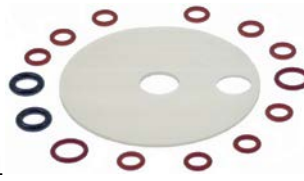

1

Part No.	699246	Ref. No.	70045110 LAR70045110
description	service kit gasket for combi-steamer		
For models:	EPE156T, EPEV15T, EPG156T, EPGV15T, GEMT21P, GEMT21T, GEMT40P, GEMT40T, GEVT21P, GEVT21T, GEVT40P, GEVT40T, GGMT21P, GGMT21T, GGMT40P, GGMT40T, GGVT21P, GGVT21T, GGVT40P, GGVT40T, HME201P, HME201T, HME201X, HME202P, HME202T, HME202X, HMG201P, HMG201T, HMG201X, HMG202P, HMG202T, HMG202X, HVE201P, HVE201T, HVE201X, HVE202P, HVE202T, HVE202X, HVG201P, HVG201T, HVG201X, HVG202P, HVG202T, HVG202X, ME201T, ME202T, MEMT21P, MEMT40P, MG201T, MG202T...(Other models you can see in the webshop)		

miscellaneous



1

Part No.	550862	Ref. No.	70045090 LAR70045090
description	gasket set for wash arm		
For models:	EPE056T, EPE086T, EPEV05T, EPEV08T, EPG056T, EPG086T, EPGV05T, EPGV08T, GEMT06P, GEMT06T, GEVT06P, GEVT06T, GGMT06P, GGMT06T, GGVT06P, GGVT06T, HME061P, HME061T, HME061X, HME101P, HME101T, HME101X, HMG061P, HMG061T, HMG061X, HMG101P, HMG101T, HMG101X, HVE061P, HVE061T, HVE061X, HVE101P, HVE101T, HVE101X, HVG061P, HVG061T, HVG061X, HVG101P, HVG101T, HVG101X, ME061T, ME101T, MEMT06P, MG061T, MG101T, MGMT06P		



springs

torsion springs



1

Part No.	690095	Ref. No.	50001196 61620012 LA61620012 LAR50001196 LAR61620012
description	torsion spring ø 6mm L2 15mm wire gauge ø 0.9mm L1 2x6mm L3 15mm Qty 1 pcs for closing hub		
For models:	ACG10M, AVE07D, AVE10D, AVE10P, BPE044M, BPE044P, BPE054M, BPE054P, BPE064M, BPE064P, BPE074M, BPE074P, BPE084M, BPE084P, BPE104M, BPE104P, BPG044M, BPG044P, BPG054M, BPG054P, BPG064M, BPG064P, BPG074M, BPG074P, BPG084M, BPG084P, BPG104M, BPG104P, CE041M, CE051M, CE071M, CE100M, CE200M, CG051M, CG071M, CG100M, CG200M, CVE004H, CVE004M, CVE104H, CVE104M, CVE105H, CVE105M, CVG105H, CVG105M, EC106M, EC110M, EC210M, EM010M+SC, EM106H... (Other models you can see in the webshop)		

compression springs



1

Part No.	690091	Ref. No.	50202710 61620041 LA61620041 LAR50202710 LAR61620041
description	compression spring ø 12mm L 49mm wire gauge ø 1mm		
For models:	ACG10M, AVE07D, AVE10D, AVE10P, BPE044M, BPE044P, BPE054M, BPE054P, BPE064M, BPE064P, BPE074M, BPE074P, BPE084M, BPE084P, BPE104M, BPE104P, BPG044M, BPG044P, BPG054M, BPG054P, BPG064M, BPG064P, BPG074M, BPG074P, BPG084M, BPG084P, BPG104M, BPG104P, CE041M, CE051M, CE071M, CE100M, CE200M, CG051M, CG071M, CG100M, CG200M, CVE004H, CVE004M, CVE104H, CVE104M, CVE105H, CVE105M, CVG105H, CVG105M, EC106M, EC110M, EC210M, EM010M+SC, EM106H... (Other models you can see in the webshop)		

miscellaneous



1

Part No.	697932	Ref. No.	10205120 919006 LAR10205120
description	spring for controllers/switches shaft diameter 6x4.6mm ømm L 40mm W 23mm H 7mm wire gauge ø 1mm		
For models:	CVE004H, CVE104H, CVE105H, CVG105H, EM106H, EM106P, EM110H, EM110P, EM210H, EM210P, EV106H, EV106P, EV110H, EV110P, EV210H, EV210P, GM106H, GM106P, GM110H, GM110P, GM210H, GM210P, GV106H, GV106P, GV110H, GV110P, GV210H, GV210P, ME106D, ME106H, ME106P, ME110D, ME110H, ME110P, ME120D, ME120H, ME120P, ME210D, ME210H, ME210P, ME220D, ME220H, ME220P, ME227P, MEC20H, MEC20P, MEC24H, MEC40H, MEK21H, MG106D... (Other models you can see in the webshop)		

kitchen accessories

baking sheets

1

Part No.	694267	Ref. No.	T14
description	baking sheet W 600mm L 400mm H 40mm aluminium		

hose reels and spray guns

spray guns



1

Part No.	542062	Ref. No.	62200028 LA62200028 LAR62200028
description	spray gun for appliances 1/2" IT L 225mm type LAINOX		
For models:	HME201X, HME202X, HMG201X, HMG202X, HVE201X, HVE202X, HVG201X, HVG202X		



1

Part No.	548455	Ref. No.	62200133 LA62200133 LAR62200133
description	spray gun for appliances 3/8" IT		
For models:	HME061X, HME101X, HME102X, HMG061P, HMG061T, HMG061X, HMG101X, HMG102X, HVE061X, HVE101X, HVE102X, HVG061P, HVG061T, HVG061X, HVG101X, HVG102X, ME061H, ME061P, ME061T, ME101H, ME101P, ME101T, ME102H, ME102P, ME102T, ME201H, ME201P, ME201T, ME202H, ME202P, ME202T, MG061H, MG061P, MG061T, MG101H, MG101P, MG101T, MG102H, MG102P, MG102T, MG201H, MG201P, MG201T, MG202H, MG202P, MG202T		



1

Part No.	542404	Ref. No.	62200058 LAR62200058
description	shower hose connections 1/2" L 2500mm unbraided nominal-ø DN8mm		
For models:	HME201X, HME202X, HMG201X, HMG202X, HVE201X, HVE202X, HVG201X, HVG202X		



hose reels

appliance hose reels



1

Part No.	542316	Ref. No.	62200172 LA62200172 LAR62200172
description	evaporator complete with spray gun hose length 1.6m connection John Guest 10mm hose ø 6x12mm		



1

Part No.	542099	Ref. No.	62200131 LA62200131 LAR62200131
description	hose reel complete with spray gun hose length 1.6m connection John Guest 10mm hose ø 6x12mm		
For models:	HME061X, HME101X, HME102X, HMG061P, HMG061T, HMG061X, HMG101X, HMG102X, HVE061X, HVE101X, HVE102X, HVG061P, HVG061T, HVG061X, HVG101X, HVG102X, ME061H, ME061P, ME061T, ME101H, ME101P, ME101T, ME102H, ME102P, ME102T, ME201H, ME201P, ME201T, ME202H, ME202P, ME202T, MG061H, MG061P, MG061T, MG101H, MG101P, MG101T, MG102H, MG102P, MG102T, MG201H, MG201P, MG201T, MG202H, MG202P, MG202T		
accessories for	542099		
		Part No.	542098
		Ref. No.	—
	spray gun for appliances 3/8" IT L 130mm type LAINOX		

dosing pumps

membrane dosing pumps

self-priming

LANG

accessories



1

Part No.	101286	Ref. No.	62070023 LA62070023 LAR62070023
description	olive ID ø 6mm Qty 1 pcs		
accessories for	101286		
		Part No.	100909
		Ref. No.	62060223 LA62060223 LAR62060223 R62060223
	union screw thread M10x1 for pipe ø 6mm Qty 1 pcs		

accessories for	101286		
		Part No.	101464
		Ref. No.	—
	union nut thread M12x1 for pipe ø 6mm		

accessories

container filters with non-return valve



1

Part No.	361058	Ref. No.	65110650 LA65110650 LAR65110650
description	container filter with non-return valve SS hose ø 4x6mm ø 20mm L 56mm		
For models:	EPE056T, EPE086T, EPE156T, EPEV05T, EPEV08T, EPEV15T, EPG056T, EPG086T, EPG156T, EPGV05T, EPGV08T, EPGV15T, GEMT06P, GEMT06T, GEMT10P, GEMT10T, GEMT20P, GEMT20T, GEMT21P, GEMT21T, GEMT40P, GEMT40T, GEVT06P, GEVT06T, GEVT10P, GEVT10T, GEVT20P, GEVT20T, GEVT21P, GEVT21T, GEVT40P, GEVT40T, GGMT06P, GGMT06T, GGMT10P, GGMT10T, GGMT20P, GGMT20T, GGMT21P, GGMT21T, GGMT40P, GGMT40T, GGV06P, GGV06T, GGV10P, GGV10T, GGV20P, GGV20T, GGV21P, GGV21T...(Other models you can see in the webshop)		

hoses

pre-rinse hoses

stainless steel flexi hoses



1

Part No.	542404	Ref. No.	62200058 LAR62200058
description	shower hose connections 1/2" L 2500mm unbraided nominal-ø DN8mm		
For models:	HME201X, HME202X, HMG201X, HMG202X, HVE201X, HVE202X, HVG201X, HVG202X		

industrial hoses

Niplaflex hoses



1







Part No.	530561	Ref. No.	70070010 LAR70070010
description	pressure hose ID ø 10mm ED ø 17mm L 5m thickness 3.5mm operating p. 10bar burst p. 30bar t.max. 110°C		



PE hoses



Part No.	520973	Ref. No.	70070040 70070050 LA80150000 LAR70070040 LAR70070050 LAR80150000
description	hose John Guest thickness 1.5mm LLDPE blue ID ø 7mm ED ø 10mm		
For models:	BPE064M, BPE064P, BPE074M, BPE074P, BPE084M, BPE084P, BPE104M, BPE104P, BPG064M, BPG064P, BPG074M, BPG074P, BPG084M, BPG084P, BPG104M, BPG104P, EPE056T, EPE086T, EPE156T, EPEV05T, EPEV08T, EPEV15T, EPG056T, EPG086T, EPG156T, EPGV05T, EPGV08T, EPGV15T, GEMT06P, GEMT06T, GEMT10P, GEMT10T, GEMT20P, GEMT20T, GEMT21P, GEMT21T, GEMT40P, GEMT40T, GEVT06P, GEVT06T, GEVT10P, GEVT10T, GEVT20P, GEVT20T, GEVT21P, GEVT21T, GEVT40P, GEVT40T, GGMT06P, GGMT06T...(Other models you can see in the webshop)		

accessories for	520973			
	Part No.	440564	Ref. No.	—
	push-in fitting John Guest straight thread 1/4" BSP pipe connection ø10mm			
	Part No.	440565	Ref. No.	—
	push-in fitting John Guest straight thread 3/8" BSP pipe connection ø10mm			
	Part No.	440608	Ref. No.	—
	push-in fitting John Guest straight thread 1/2" BSP stub ø 10mm			
	Part No.	440639	Ref. No.	—
	push-in fitting John Guest angled thread 1/4" BSP pipe connection ø10mm			
	Part No.	520359	Ref. No.	62090528 LAG2090528 LAR62090528 R62090528
	push-in fitting John Guest angled pipe connection ø10mm grommet ø 10mm			
	Part No.	520363	Ref. No.	62090468 LAG2090468 LAR62090468 R62090468
	push-in fitting John Guest T-piece pipe connection ø10mm - ø10mm - ø10mm			
	Part No.	520494	Ref. No.	62090478 LAG2090478 LAR62090478 R62090478
	push-in fitting John Guest angled pipe connection ø10mm - ø10mm			

PU hoses



Part No.	512505	Ref. No.	80150020 LA80150020 LAR80150020
description	PU hose ID ø 5mm ED ø 8mm L 1m thickness 1.5mm t.max. -40 up to +60°C polyurethane transparent/colourless		

PVC hoses

PVC hoses without fabric



Part No.	520278	Ref. No.	70070100 LAR70070100
description	PVC hose ID ø 6mm ED ø 8mm L 2m thickness 1mm t.max. 60°C transparent		
For models:	EPE056T, EPE086T, EPE156T, EPEV05T, EPEV08T, EPEV15T, EPG056T, EPG086T, EPG156T, EPGV05T, EPGV08T, EPGV15T, GEMT06P, GEMT06T, GEMT10P, GEMT10T, GEMT20P, GEMT20T, GEMT21P, GEMT21T, GEMT40P, GEMT40T, GEVT06P, GEVT06T, GEVT10P, GEVT10T, GEVT20P, GEVT20T, GEVT21P, GEVT21T, GEVT40P, GEVT40T, GGMT06P, GGMT06T, GGMT10P, GGMT10T, GGMT20P, GGMT20T, GGMT21P, GGMT21T, GGMT40P, GGMT40T, GGVT06P, GGVT06T, GGVT10P, GGVT10T, GGVT20P, GGVT20T, GGVT21P, GGVT21T...(Other models you can see in the webshop)		

silicone hoses

without fabric





Part No.	530899	Ref. No.	70060080 LAR70060080
description	silicone hose ID ø 13mm ED ø 18mm L 0.08m thickness 2.5mm red for combi-steamer		
For models:	AVE07D, AVE10D, AVE10P, CGC24M, CGC40M, EM010M+SC, EM106H, EM106M, EM106M+SC, EM106P, EM110H, EM110M, EM110M+SC, EM110P, EM210H, EM210M, EM210M+SC, EM210P, EMT06D, EPE056T, EPE086T, EPE156T, EPEV05T, EPEV08T, EPEV15T, EPG056T, EPG086T, EPG156T, EPGV05T, EPGV08T, EPGV15T, EV006M, EV106H, EV106M, EV106M+SC, EV106P, EV110H, EV110M, EV110M+SC, EV110P, EV210H, EV210M, EV210M+SC, EV210P, GEMT06P, GEMT06T, GEMT10P, GEMT10T, GEMT20P, GEMT20T...(Other models you can see in the webshop)		



Part No.	530884	Ref. No.	70060060 70060070 LAR70060060 LAR70060070
description	silicone hose ID ø 15mm ED ø 19mm L 0.08m thickness 3mm red for combi-steamer		
For models:	CVE004H, CVE004M, CVE104H, CVE104M, CVE105H, CVE105M, CVG105H, CVG105M, EM010M+SC, EM106H, EM106M, EM106M+SC, EM106P, EM110H, EM110M, EM110M+SC, EM110P, EM210H, EM210M, EM210M+SC, EM210P, GM106H, GM106M, GM106M+SC, GM106P, GM110H, GM110M, GM110M+SC, GM110P, GM210H, GM210M, GM210M+SC, GM210P, ME004L, ME004S, ME104L, ME104S, ME105L, ME105S, ME106D, ME106H, ME106L, ME106M, ME106P, ME106S, ME106T, ME106X, ME110D, ME110H, ME110L...(Other models you can see in the webshop)		



			
1			
Part No.	570157	Ref. No.	80120060 LA80120060 LAR80120060 R70070090
description	silicone hose ID ø 7mm ED ø 12mm L 1m thickness 2.5mm transparent for combi-steamer		

			
1			
Part No.	694499	Ref. No.	70070060 LAR70070060
description	hose ID ø 7mm L 2000mm LLDPE for beverage technology ED ø 10mm John Guest		
For models:	ACG10M, AVE07D, AVE10D, AVE10P, CE071M, CE100M, CE200M, CG071M, CG100M, CG200M, EMT06D, GVT20D, MACE07M, MACE10M, MACE20M, MACG07M, MACG10M, MACG20M, ME061D, ME061T, ME101T, ME102T, MEMT06D, MEVT06D, MEVT20D, MEVT20P, MG061T, MG101T, MG102T, MGVT20D, MGVT20P, PG084, PG104M, VE061D, VE061M, VE061P, VE101D, VE101M, VE101P, VE102D, VE102M, VE102P, VG061D, VG061M, VG101D, VG101M, VG101P, VG102D, VG102M, VG102P		

formed hoses

straight

			
1			
Part No.	520534	Ref. No.	70060040 LA70060040 LAR70060040
description	hose ID ø 50mm ED ø 58mm L 50mm silicone Qty 1 for combi-steamer thickness 4mm		
For models:	EPE056T, EPE086T, EPE156T, EPEV05T, EPEV08T, EPEV15T, EPG056T, EPG086T, EPG156T, EPGV05T, EPGV08T, EPGV15T, FE105M, FE105X, FE110M, FE110X, FG051M, FG051X, FG101M, FG101X, FG105M, FG105X, FG110M, FG110X, GEMT06P, GEMT06T, GEMT10P, GEMT10T, GEMT20P, GEMT20T, GEMT21P, GEMT21T, GEMT40P, GEMT40T, GEVT06P, GEVT06T, GEVT10P, GEVT10T, GEVT20P, GEVT20T, GEVT21P, GEVT21T, GEVT40P, GEVT40T, GGMT06P, GGMT06T, GGMT10P, GGMT10T, GGMT20P, GGMT20T...(Other models you can see in the webshop)		

			
1			
Part No.	592327	Ref. No.	80150060 LA80150060 LAR80150060
description	water hose ID ø 7mm ext. ø 10 L 1000mm operating p. 3bar temp.-resist. 92°C for combi-steamer		

fittings hose and pipe connectors fittings

double nipples

			
1			
Part No.	521182	Ref. No.	62020118 LA62020118 LAR62020118
description	double nipple plastic thread 1/4" - 1/4" Qty 1 pcs		

			
1			
Part No.	530901	Ref. No.	70060050 LA70060050 R70060050
description	hose ID ø 54mm ED ø 60mm L 50mm for combi-steamer		
For models:	FE210M, FG210M, FG210X, GEMT20P, GEMT20T, GEMT40P, GEMT40T, GEVT20P, GEVT20T, GEVT40P, GEVT40T, GGMT40P, GGMT40T, GGV20P, GGV20T, HME102P, HME102T, HME102X, HME202P, HME202T, HME202X, HMG202P, HMG202T, HMG202X, HVE102P, HVE102T, HVE102X, HVE202P, HVE202T, HVE202X, HVG202P, HVG202T, HVG202X, MCE202M, MCG202M, ME102H, ME102M, ME102P, ME102T, ME202D, ME202H, ME202M, ME202P, ME202T, MEMT40D, MEMT40P, MEVT40D, MEVT40P, MG102H, MG102M...(Other models you can see in the webshop)		

screw pipe fittings

angle pieces

			
1			
Part No.	699452	Ref. No.	62090633 LA62090633 LAR62090633
description	angle piece thread M14x1 tube ø 10mm brass		
For models:	EPEV05T, EPEV08T, EPEV15T, EPGV05T, EPGV08T, EPGV15T		



hose connectors

plastic



1

Part No.	362015	Ref. No.	LAR62090638
description	hose connector plastic straight IT 1/4" hose ø 8mm		



1

Part No.	362010	Ref. No.	62090492 LAR62090492
description	hose connector plastic straight thread 1/4" hose ø 8mm Qty 1 pcs		
For models:	EPE056T, EPE086T, EPE156T, EPEV05T, EPEV08T, EPEV15T, EPG056T, EPG086T, EPG156T, EPGV05T, EPGV08T, EPGV15T, GEMT06P, GEMT06T, GEMT10P, GEMT10T, GEMT20P, GEMT20T, GEMT21P, GEMT21T, GEMT40P, GEMT40T, GEVT06P, GEVT06T, GEVT10P, GEVT10T, GEVT20P, GEVT20T, GEVT21P, GEVT21T, GEVT40P, GEVT40T, GGMT06P, GGMT06T, GGMT10P, GGMT10T, GGMT20P, GGMT20T, GGMT21P, GGMT21T, GGMT40P, GGMT40T, GGVT06P, GGVT06T, GGVT10P, GGVT10T, GGVT20P, GGVT20T, GGVT21P, GGVT21T...(Other models you can see in the webshop)		



1

Part No.	362011	Ref. No.	62090538 LA62090538 LAR62090538
description	hose connector plastic straight thread 1/4" hose ø 8x6mm Qty 1 pcs		
For models:	EPE056T, EPE086T, EPE156T, EPEV05T, EPEV08T, EPEV15T, EPG056T, EPG086T, EPG156T, EPGV05T, EPGV08T, EPGV15T, GEMT06P, GEMT06T, GEMT10P, GEMT10T, GEMT20P, GEMT20T, GEMT21P, GEMT21T, GEMT40P, GEMT40T, GEVT06P, GEVT06T, GEVT10P, GEVT10T, GEVT20P, GEVT20T, GEVT21P, GEVT21T, GEVT40P, GEVT40T, GGMT06P, GGMT06T, GGMT10P, GGMT10T, GGMT20P, GGMT20T, GGMT21P, GGMT21T, GGMT40P, GGMT40T, GGVT06P, GGVT06T, GGVT10P, GGVT10T, GGVT20P, GGVT20T, GGVT21P, GGVT21T...(Other models you can see in the webshop)		



1

Part No.	362016	Ref. No.	62090658 LAR62090658
description	hose connector plastic straight thread 1/8" hose ø 8x6mm		
For models:	EPE056T, EPE086T, EPE156T, EPEV05T, EPEV08T, EPEV15T, EPG056T, EPG086T, EPG156T, EPGV05T, EPGV08T, EPGV15T, GEMT06P, GEMT06T, GEMT10P, GEMT10T, GEMT20P, GEMT20T, GEMT21P, GEMT21T, GEMT40P, GEMT40T, GEVT06P, GEVT06T, GEVT10P, GEVT10T, GEVT20P, GEVT20T, GEVT21P, GEVT21T, GEVT40P, GEVT40T, GGMT06P, GGMT06T, GGMT10P, GGMT10T, GGMT20P, GGMT20T, GGMT21P, GGMT21T, GGMT40P, GGMT40T, GGVT06P, GGVT06T, GGVT10P, GGVT10T, GGVT20P, GGVT20T, GGVT21P, GGVT21T...(Other models you can see in the webshop)		

stainless steel



1

Part No.	542385	Ref. No.	62090663 LA62090663 LAR62090663
description	hose connector SS angled thread 1/4" hose ø 10mm Qty 1 pcs		

producer-specific



1

Part No.	440027	Ref. No.	62090482 LA62090482 LAR62090482
description	connecting piece for hose ID 6mm WS 15 total length 79mm plastic John Guest		
For models:	EPE056T, EPE086T, EPE156T, EPEV05T, EPEV08T, EPEV15T, EPG056T, EPG086T, EPG156T, EPGV05T, EPGV08T, EPGV15T, GEMT06P, GEMT06T, GEMT10P, GEMT10T, GEMT20P, GEMT20T, GEMT21P, GEMT21T, GEMT40P, GEMT40T, GEVT06P, GEVT06T, GEVT10P, GEVT10T, GEVT20P, GEVT20T, GEVT21P, GEVT21T, GEVT40P, GEVT40T, GGMT06P, GGMT06T, GGMT10P, GGMT10T, GGMT20P, GGMT20T, GGMT21P, GGMT21T, GGMT40P, GGMT40T, GGVT06P, GGVT06T, GGVT10P, GGVT10T, GGVT20P, GGVT20T, GGVT21P, GGVT21T...(Other models you can see in the webshop)		



1

Part No.	520339	Ref. No.	62090518 LA62090518 LAR62090518
description	hose connector thread 1/4" straight grommet ø 10mm grommet length 20mm WS 20 total length 37mm thread L 11mm plastic		
For models:	EPE056T, EPE086T, EPE156T, EPEV05T, EPEV08T, EPEV15T, EPG056T, EPG086T, EPG156T, EPGV05T, EPGV08T, EPGV15T, GEMT06P, GEMT06T, GEMT10P, GEMT10T, GEMT20P, GEMT20T, GEMT21P, GEMT21T, GEMT40P, GEMT40T, GEVT06P, GEVT06T, GEVT10P, GEVT10T, GEVT20P, GEVT20T, GEVT21P, GEVT21T, GEVT40P, GEVT40T, GGMT06P, GGMT06T, GGMT10P, GGMT10T, GGMT20P, GGMT20T, GGMT21P, GGMT21T, GGMT40P, GGMT40T, GGVT06P, GGVT06T, GGVT10P, GGVT10T, GGVT20P, GGVT20T, GGVT21P, GGVT21T...(Other models you can see in the webshop)		

water and beverage technology



Part No.	520360	Ref. No.	62090508 LAR62090508
description	hose connector thread 1/4" with coupling straight plastic		
For models:	AVE07D, AVE10D, AVE10P, BPE044P, BPE054P, BPE064M, BPE064P, BPE074M, BPE074P, BPE084M, BPE084P, BPE104M, BPE104P, BPG044P, BPG054P, BPG064M, BPG064P, BPG074M, BPG074P, BPG084M, BPG084P, BPG104M, BPG104P, EPE056T, EPE086T, EPE156T, EPEV05T, EPEV08T, EPEV15T, EPG056T, EPG086T, EPG156T, EPGV05T, EPGV08T, EPGV15T, GEMT06P, GEMT06T, GEMT10P, GEMT10T, GEMT20P, GEMT20T, GEMT21P, GEMT21T, GEMT40P, GEMT40T, GEVT06P, GEVT06T, GEVT10P, GEVT10T, GEVT20P...(Other models you can see in the webshop)		

Part No.	520359	Ref. No.	62090528 LA62090528 LAR62090528
description	push-in fitting John Guest angled pipe connection ø10mm grommet ø 10mm		
For models:	EPE056T, EPE086T, EPE156T, EPEV05T, EPEV08T, EPEV15T, EPG056T, EPG086T, EPG156T, EPGV05T, EPGV08T, EPGV15T, GEMT06P, GEMT06T, GEMT10P, GEMT10T, GEMT20P, GEMT20T, GEMT21P, GEMT21T, GEMT40P, GEMT40T, GEVT06P, GEVT06T, GEVT10P, GEVT10T, GEVT20P, GEVT20T, GEVT21P, GEVT21T, GEVT40P, GEVT40T, GGMT06P, GGMT06T, GGMT10P, GGMT10T, GGMT20P, GGMT20T, GGMT21P, GGMT21T, GGMT40P, GGMT40T, GGVTO6P, GGVTO6T, GGVT10P, GGVT10T, GGVT20P, GGVT20T, GGVT21P, GGVT21T...(Other models you can see in the webshop)		
accessories for	520359		
	Part No.	520973	Ref. No. 70070040 70070050 LAR8150000 LAR70070040 LAR70070050 LAR80150000 R70070040 R70070050
	hose John Guest thickness 1.5mm LLDPE blue ID ø 7mm ED ø 10mm		

push-in fittings

JOHN GUEST

Part No.	440019	Ref. No.	62090548 LA62090548 LAR62090548
description	push-in fitting John Guest straight pipe connection ø6mm grommet ø 10mm		
For models:	EPE056T, EPE086T, EPE156T, EPEV05T, EPEV08T, EPEV15T, EPG056T, EPG086T, EPG156T, EPGV05T, EPGV08T, EPGV15T, GEMT06P, GEMT06T, GEMT10P, GEMT10T, GEMT20P, GEMT20T, GEMT21P, GEMT21T, GEMT40P, GEMT40T, GEVT06P, GEVT06T, GEVT10P, GEVT10T, GEVT20P, GEVT20T, GEVT21P, GEVT21T, GEVT40P, GEVT40T, GGMT06P, GGMT06T, GGMT10P, GGMT10T, GGMT20P, GGMT20T, GGMT21P, GGMT21T, GGMT40P, GGMT40T, GGVTO6P, GGVTO6T, GGVT10P, GGVT10T, GGVT20P, GGVT20T, GGVT21P, GGVT21T...(Other models you can see in the webshop)		
accessories for	440019		
	Part No.	520971	Ref. No. —
	hose thickness 1mm LLDPE blue ID ø 4mm ED ø 6mm operating pressure at 20°C 16bar		

Part No.	440021	Ref. No.	62090808 LA62090808
description	push-in fitting John Guest angled pipe connection ø6mm grommet ø 6mm		
accessories for	440021		
	Part No.	520971	Ref. No. —
	hose thickness 1mm LLDPE blue ID ø 4mm ED ø 6mm operating pressure at 20°C 16bar		

1

Part No.	440671	Ref. No.	62090648 62090678 LA62090678 LAR62090648 LAR62090678
description	push-in fitting John Guest angled pipe connection ø8mm grommet ø 8mm		
For models:	EPE056T, EPE086T, EPE156T, EPEV05T, EPEV08T, EPEV15T, EPG056T, EPG086T, EPG156T, EPGV05T, EPGV08T, EPGV15T, GEMT06P, GEMT06T, GEMT10P, GEMT10T, GEMT20P, GEMT20T, GEMT21P, GEMT21T, GEMT40P, GEMT40T, GEVT06P, GEVT06T, GEVT10P, GEVT10T, GEVT20P, GEVT20T, GEVT21P, GEVT21T, GEVT40P, GEVT40T, GGMT06P, GGMT06T, GGMT10P, GGMT10T, GGMT20P, GGMT20T, GGMT21P, GG-MT21T, GGGMT40P, GGGMT40T, GGGVT06P, GGGVT06T, GGGVT10P, GGGVT10T, GGGVT20P, GGGVT20T, GGGVT21P, GGGVT21T...(Other models you can see in the webshop)		
accessories for	440671		
	Part No.	520972	Ref. No. —
hose John Guest thickness 1mm LLDPE blue ID ø 6mm ED ø 8mm			



1

Part No.	440647	Ref. No.	62090798
description	push-in fitting John Guest straight pipe connection ø6mm - ø8mm		



1

Part No.	520961	Ref. No.	62090788 LA62090788 LAR62090788
description	push-in fitting pipe connection ø6mm - ø10mm		



1

Part No.	520494	Ref. No.	62090478 LA62090478 LAR62090478
description	push-in fitting John Guest angled pipe connection ø10mm - ø10mm		
For models:	ACG10M, AVE07D, AVE10D, AVE10P, BPE044M, BPE044P, BPE054M, BPE054P, BPE064M, BPE064P, BPE074M, BPE074P, BPE084M, BPE084P, BPE104M, BPE104P, BPG044M, BPG044P, BPG054M, BPG054P, BPG064M, BPG064P, BPG074M, BPG074P, BPG084M, BPG084P, BPG104M, BPG104P, CE041M, CE051M, CE071M, CE100M, CE200M, CG051M, CG071M, CG100M, CG200M, EMT06D, EPE056T, EPE086T, EPE156T, EPEV05T, EPEV08T, EPEV15T, EPG056T, EPG086T, EPG156T, EPGV05T, EPGV08T, EPGV15T...(Other models you can see in the webshop)		
accessories for	520494		
	Part No.	520973	Ref. No.
hose John Guest thickness 1.5mm LLDPE blue ID ø 7mm ED ø 10mm			



1



Part No.	520493	Ref. No.	62090618 LA62090618 LAR62090618
description	hose connector John Guest straight pipe connection ø8mm - ø10mm L 41mm PM201008E NSF, SK		
For models:	EPE056T, EPE086T, EPEV05T, EPEV08T, EPG056T, EPG086T, EPGV05T, EPGV08T, GEMT06P, GEMT06T, GEMT10P, GEMT10T, GEMT20P, GEMT20T, GEMT21P, GEMT21T, GEVT06P, GEVT06T, GEVT10P, GEVT10T, GEVT20P, GEVT20T, GEVT21P, GEVT21T, GGMT06P, GGMT06T, GGMT10P, GGMT10T, GGMT20P, GGMT20T, GGMT21P, GG-MT21T, GGGVT06P, GGGVT06T, GGGVT10P, GGGVT10T, GGGVT20P, GGGVT20T, GGGVT21P, GGGVT21T, GMT20P, HME061P, HME061T, HME061X, HME101P, HME101T, HME101X, HME102P, HME102T, HME102X...(Other models you can see in the webshop)		





1

Part No.	520492	Ref. No.	62090458 LA62090458 LAR62090458
description	push-in fitting John Guest straight pipe connection ø10mm - ø10mm		
For models:	AVE07D, AVE10D, AVE10P, BPE044M, BPE044P, BPE054M, BPE054P, BPE064M, BPE064P, BPE074M, BPE074P, BPE084M, BPE084P, BPE104M, BPE104P, BPG044M, BPG044P, BPG054M, BPG054P, BPG064M, BPG064P, BPG074M, BPG074P, BPG084M, BPG084P, BPG104M, BPG104P, CE041M, CE051M, CG051M, EMT06D, EPE056T, EPE086T, EPE156T, EPEV05T, EPEV08T, EPEV15T, EPG056T, EPG086T, EPG156T, EPGV05T, EPGV08T, EPGV15T, GEMT06P, GEMT06T, GEMT10P, GEMT10T, GEMT20P, GEMT20T, GEMT21P...(Other models you can see in the webshop)		



 <p>1</p>							
Part No.	520363	Ref. No.	62090468 LA62090468 LAR62090468				
description	push-in fitting John Guest T-piece pipe connection ø10mm - ø10mm - ø10mm						
For models:	EPE056T, EPE086T, EPE156T, EPEV05T, EPEV08T, EPEV15T, EPG056T, EPG086T, EPG156T, EPGV05T, EPGV08T, EPGV15T, GEMT06P, GEMT06T, GEMT10P, GEMT10T, GEMT20P, GEMT20T, GEMT21P, GEMT21T, GEMT40P, GEMT40T, GEVT06P, GEVT06T, GEVT10P, GEVT10T, GEVT20P, GEVT20T, GEVT21P, GEVT21T, GEVT40P, GEVT40T, GGMT06P, GGMT06T, GGMT10P, GGMT10T, GGMT20P, GGMT20T, GGMT21P, GGMT21T, GGMT40P, GGMT40T, GGVTO6P, GGVTO6T, GGVT10P, GGVT10T, GGVT20P, GGVT20T, GGVT21P, GGVT21T...(Other models you can see in the webshop)						
accessories for	520363						
 <table border="1"> <tr> <td>Part No.</td> <td>520973</td> <td>Ref. No.</td> <td>70070040 70070050 LA80150000 LAR70070040 LAR70070050 LAR80150000 R70070040 R70070050</td> </tr> </table> <p>hose John Guest thickness 1.5mm LLDPE blue ID ø 7mm ED ø 10mm</p>				Part No.	520973	Ref. No.	70070040 70070050 LA80150000 LAR70070040 LAR70070050 LAR80150000 R70070040 R70070050
Part No.	520973	Ref. No.	70070040 70070050 LA80150000 LAR70070040 LAR70070050 LAR80150000 R70070040 R70070050				

 <p>1</p>							
Part No.	520495	Ref. No.	62090608 LA62090608 LAR62090608				
description	push-in fitting John Guest straight thread 1/8" BSP stub ø 8mm						
For models:	EPE056T, EPE086T, EPE156T, EPEV05T, EPEV08T, EPEV15T, EPG056T, EPG086T, EPG156T, EPGV05T, EPGV08T, EPGV15T, GEMT06P, GEMT06T, GEMT10P, GEMT10T, GEMT20P, GEMT20T, GEMT21P, GEMT21T, GEMT40P, GEMT40T, GEVT06P, GEVT06T, GEVT10P, GEVT10T, GEVT20P, GEVT20T, GEVT21P, GEVT21T, GEVT40P, GEVT40T, GGMT06P, GGMT06T, GGMT10P, GGMT10T, GGMT20P, GGMT20T, GGMT21P, GGMT21T, GGMT40P, GGMT40T, GGVTO6P, GGVTO6T, GGVT10P, GGVT10T, GGVT20P, GGVT20T, GGVT21P, GGVT21T...(Other models you can see in the webshop)						
accessories for	520495						
 <table border="1"> <tr> <td>Part No.</td> <td>520971</td> <td>Ref. No.</td> <td>—</td> </tr> </table> <p>hose thickness 1mm LLDPE blue ID ø 4mm ED ø 6mm operating pressure at 20°C 16bar</p>				Part No.	520971	Ref. No.	—
Part No.	520971	Ref. No.	—				

 <p>1</p>			
Part No.	440031	Ref. No.	62090688 LA62090688 LAR62090688
description	push-in fitting John Guest straight thread 1/2" pipe connection ø8mm - ø8mm bulkhead connector		

valves and tank inlets

ball valves

universal

ball valves with butterfly handle

 <p>1</p>			
Part No.	540658	Ref. No.	1450500
description	ball valve connection 3/4" IT - 3/4" IT DN20 total length 69mm		

ball valves electric

 <p>1</p>			
Part No.	403026 ¹	Ref. No.	65110540 LAR65110540
description	ball valve inlet 1/2" IT outlet 1/2" IT 230V L 90mm 50/60Hz off-current open mode of operation electric W 60mm H 100mm connection cable 450mm IT 1/2"		
For models:	EM010M+SC, EM106H, EM106M, EM106M+SC, EM106P, EM110H, EM110M, EM110M+SC, EM110P, EM210H, EM210M, EM210M+SC, EM210P, GM106H, GM106M, GM106M+SC, GM106P, GM110H, GM110M, GM110M+SC, GM110P, GM210H, GM210M, GM210M+SC, GM210P, ME004L, ME004S, ME104L, ME104S, ME105L, ME105S, ME106D, ME106H, ME106L, ME106M, ME106P, ME106S, ME106T, ME106X, ME110D, ME110H, ME110M, ME110P, ME110T, ME110X, ME120D, ME120H, ME120L, ME120M, ME120P...(Other models you can see in the webshop)		

¹off-current open

 <p>1</p>			
Part No.	401342	Ref. No.	65110560 old Version LAR65110560 old Version
description	ball valve inlet 3/4" IT outlet 3/4" IT 230V IT 3/4"		





			
1			
Part No.	403042	Ref. No.	65110560 LAR65110560
description	ball valve inlet 3/4" IT outlet 3/4" IT 230V L 68mm closed off-current mode of operation electric connection cable 400mm		
For models:	EMT06D, GEMT06P, GEMT06T, GEMT10P, GEMT10T, GEMT20P, GEMT20T, GEMT21P, GEMT21T, GEMT40P, GEMT40T, GGMT06P, GGMT06T, GGMT10P, GGMT10T, GGMT20P, GGMT20T, GGMT21P, GGMT21T, GGMT40P, GGMT40T, GMT06D, GMT20D, GMT20P, HME061P, HME061T, HME061X, HME101P, HME101T, HME101X, HME102P, HME102T, HME102X, HME201P, HME201T, HME201X, HME202P, HME202T, HME202X, HMG061P, HMG061T, HMG061X, HMG101P, HMG101T, HMG101X, HMG102P, HMG102T, HMG102X, HMG201P, HMG201T...(Other models you can see in the webshop)		

beverage technology

valves

non-return valves

			
1			
Part No.	440727	Ref. No.	65110680 LA65110680 LAR65110680
description	non-return valve John Guest pipe connection ϕ 10mm - ϕ 10mm operating pressure at 20°C 10bar opening pressure 0.02bar POM		

			
1			
Part No.	440026	Ref. No.	62300018 LAR62300018
description	non-return valve kit John Guest pipe connection ϕ 10x10mm operating pressure at 20°C 10bar opening pressure 0.02bar POM		
For models:	ME061T, ME101T, ME102T, ME201T, MG061T, MG101T, MG102T, MG201T, MG202T		

ancillary products

clamps

hose clamps

DIN 3017 - W2

			
1			
Part No.	520112	Ref. No.	61630011 LAR61630011
description	hose clamp ϕ 12-20mm width 9mm Qty 10 pcs DIN 3017		
For models:	AVE07D, AVE10D, AVE10P, CGC24M, CGC40M, CVE004H, CVE004M, CVE104H, CVE104M, CVE105H, CVE105M, CVG105H, CVG105M, EC106M, EC110M, EC210M, EM010M+SC, EM106H, EM106M, EM106M+SC, EM106P, EM110H, EM110M, EM110M+SC, EM110P, EM210H, EM210M, EM210M+SC, EM210P, EMT06D, EPE056T, EPE086T, EPE156T, EPEV05T, EPEV08T, EPEV15T, EPG056T, EPG086T, EPG156T, EPGV05T, EPGV08T, EPGV15T, EV006M, EV106H, EV106M, EV106M+SC, EV106P, EV110H, EV110M, EV110M+SC...(Other models you can see in the webshop)		

			
1			
Part No.	520454	Ref. No.	61630041
description	hose clamp ϕ 70-90mm width 9mm Qty 5 pcs DIN 3017		

DIN 3017 - W4

			
1			
Part No.	520850	Ref. No.	61630021
description	hose clamp SS W4 ϕ 32-50mm width 9mm Qty 5 pcs DIN 3017		



measuring equipment

thermometers

built-in thermometers

ø52mm



1

Part No.	541077	Ref. No.	50304610 65340050 LA65340050 LAR50304610 LAR65340050
description	thermometer mounting ø 52mm t.max. 350°C +50 up to +350°C probe ø 6mm probe L 30mm capillary pipe 1000mm built-in depth 28mm		
For models:	CGC24M, CGC40M, EC106M, EC110M, EC210M, EM010M+SC, EM106M, EM106M+SC, EM110M, EM110M+SC, EM210M, EM210M+SC, EV006M, EV106M, EV106M+SC, EV110M, EV110M+SC, EV210M, EV210M+SC, FE05, FE105M, FE105X, FE110M, FE110X, FE210M, FG05, FG051M, FG051X, FG101M, FG101X, FG105M, FG105X, FG110M, FG110X, FG210M, FG210X, GC106M, GC110M, GC210M, GM106M, GM106M+SC, GM110M, GM110M+SC, GM210M, GM210M+SC, GV106M, GV106M+SC, GV110M, GV110M+SC, GV210M...(Other models you can see in the webshop)		

hexagonal screws



1

Part No.	550682	Ref. No.	58006410 LAR58006410
description	hexagonal screw thread M8 thread L 20mm SS WS 13 Qty 1 pcs DIN 933 / ISO 4017		
For models:	ME110L, ME110S, ME110T, ME120L, ME120S, ME120T, ME210L, ME210S, ME210T, ME220L, ME220S, ME220T, MG110L, MG110S, MG110T, MG120L, MG120S, MG120T, MG210L, MG210S, MG210T, MG220L, MG220S, MG220T, VE110L, VE110S, VE110T, VE120L, VE120S, VE120T, VE210L, VE210S, VE210T, VG110L, VG110S, VG110T, VG210L, VG210S, VG210T		



1

Part No.	560594	Ref. No.	61020562 LA61020562 LAR61020562
description	hexagonal screw thread M6 thread L 20mm WS 10 total length 59mm		
For models:	ACG10M, AVE10D, AVE10P, BPE084M, BPE084P, BPE104M, BPE104P, BPG084M, BPG084P, BPG104M, BPG104P, CE100M, CE200M, CG100M, CG200M, CGC24M, CGC40M, EC110M, EC210M, EM010M+SC, EM110H, EM110M, EM110M+SC, EM110P, EM210H, EM210M, EM210M+SC, EM210P, EPE056T, EPE086T, EPE156T, EPEV05T, EPEV08T, EPEV15T, EPG056T, EPG086T, EPG156T, EPGV05T, EPGV08T, EPGV15T, EV110H, EV110M, EV110M+SC, EV110P, EV210H, EV210M, EV210M+SC, EV210P, FE110M, FE110X...(Other models you can see in the webshop)		

fastening material

screws

raised countersunk head screws



1

Part No.	560541	Ref. No.	61040272 LA61050102 LAR61040272
description	raised countersunk head screw thread M6 thread L 13mm SS DIN 966/ISO 7047 Qty 1 pcs intake slotted head ø 11mm head thickness 5mm		
For models:	CGC24M, CGC40M, EPE156T, EPEV15T, EPG156T, EPGV15T, GEMT21P, GEMT21T, GEMT40P, GEMT40T, GEVT21P, GEVT21T, GEVT40P, GEVT40T, GGMT21P, GGMT21T, GGMT40P, GGMT40T, GGVT21P, GGVT21T, GGVT40P, GGVT40T, HME201P, HME201T, HME201X, HME202P, HME202T, HME202X, HMG201P, HMG201T, HMG201X, HMG202P, HMG202T, HMG202X, HVE201P, HVE201T, HVE201X, HVE202P, HVE202T, HVE202X, HVG201P, HVG201T, HVG201X, HVG202P, HVG202T, HVG202X, MCE201M, MCE202M, MCG201M, MCG202M...(Other models you can see in the webshop)		

cylinder head bolts

DIN 912/ISO 4762



1

Part No.	520455	Ref. No.	61030601 LA61030601 LAR61030601
description	screw thread M8 thread L 20mm WS 6 SS Qty 1 pcs DIN 912/ISO 4762		
For models:	EPE156T, EPEV15T, EPG156T, EPGV15T, GEMT21P, GEMT21T, GEMT40P, GEMT40T, GEVT21P, GEVT21T, GEVT40P, GEVT40T, GGMT21P, GGMT21T, GGMT40P, GGMT40T, GGVT21P, GGVT21T, GGVT40P, GGVT40T, HME201P, HME201T, HME201X, HME202P, HME202T, HME202X, HMG201P, HMG201T, HMG201X, HMG202P, HMG202T, HMG202X, HVE201P, HVE201T, HVE201X, HVE202P, HVE202T, HVE202X, HVG201P, HVG201T, HVG201X, HVG202P, HVG202T, HVG202X, MCE201M, MCE202M, MCG201M, MCG202M, ME201D, ME201H...(Other models you can see in the webshop)		



grub screws

DIN 913/ISO 4026



Part No.	560024	Ref. No.	61090052 LA61090052 LAR61090052
description	grub screw thread M6 L 16mm SS DIN 913/ISO 4026 intake internal hexagon WS 3 Qty 20 pcs		
For models:	CGC24M, CGC40M, EPE156T, EPEV15T, EPG156T, EPGV15T, GEMT21P, GEMT21T, GEMT40P, GEMT40T, GEVT21P, GEVT21T, GEVT40P, GEVT40T, GGMT21P, GGMT21T, GGMT40P, GGMT40T, GGV21P, GGV21T, GGV40P, GGV40T, HME201P, HME201T, HME201X, HME202P, HME202T, HME202X, HMG201P, HMG201T, HMG201X, HMG202P, HMG202T, HMG202X, HVE201P, HVE201T, HVE201X, HVE202P, HVE202T, HVE202X, HVG201P, HVG201T, HVG201X, HVG202P, HVG202T, HVG202X, MCE201M, MCE202M, MCG201M, MCG202M...(Other models you can see in the webshop)		



Part No.	560495	Ref. No.	61090592 LAR61090592
description	grub screw thread M8 L 16mm intake 4mm Qty 1 pcs		
For models:	ME120L, ME120S, ME120T, ME220L, ME220S, ME220T, MG120L, MG120S, MG120T, MG220L, MG220S, MG220T, VE120L, VE120S		

miscellaneous



Part No.	690594	Ref. No.	58002560 LA58002560 LAR58002560
description	pressure screw for door hinge		
For models:	CGC24M, CGC40M, EPE156T, EPEV15T, EPG156T, EPGV15T, GEMT21P, GEMT21T, GEMT40P, GEMT40T, GEVT21P, GEVT21T, GEVT40P, GEVT40T, GGMT21P, GGMT21T, GGMT40P, GGMT40T, GGV21P, GGV21T, GGV40P, GGV40T, HME201P, HME201T, HME201X, HME202P, HME202T, HME202X, HMG201P, HMG201T, HMG201X, HMG202P, HMG202T, HMG202X, HVE201P, HVE201T, HVE201X, HVE202P, HVE202T, HVE202X, HVG201P, HVG201T, HVG201X, HVG202P, HVG202T, HVG202X, MCE201M, MCE202M, MCG201M, MCG202M...(Other models you can see in the webshop)		



Part No.	694991	Ref. No.	58006400 LA58006400 LAR58006400
description	screw thread M6 L 16mm for air baffle combi-steamer		
For models:	ACG10M, AVE07D, AVE10D, AVE10P, BPE044M, BPE044P, BPE054M, BPE054P, BPE064M, BPE064P, BPE074M, BPE074P, BPE084M, BPE084P, BPE104M, BPE104P, BPG044M, BPG044P, BPG054M, BPG054P, BPG064M, BPG064P, BPG074M, BPG074P, BPG084M, BPG084P, BPG104M, BPG104P, CE041M, CE051M, CE071M, CE100M, CE200M, CG051M, CG071M, CG100M, CG200M, CVE004H, CVE004M, CVE104H, CVE104M, CVE105H, CVE105M, CVG105H, CVG105M, EC106M, EC110M, EC210M, EM010M+SC, EM106H...(Other models you can see in the webshop)		

nuts

hexagonal nuts

ISO 4033 / UNI5587



Part No.	550866	Ref. No.	58004020 LA58004020 LAR58004020
description	nut thread M10x1.5 H 10mm SS WS 17 Qty 1 pcs DIN/ISO DIN 934 / ISO 4032/8673 left-hand thread		
For models:	AVE07D, BPE064M, BPE064P, BPE074M, BPE074P, BPG064M, BPG064P, BPG074M, BPG074P, CE071M, CG071M, CVE105H, CVE105M, CVG105H, CVG105M, EC106M, EM106H, EM106M, EM106M+SC, EM106P, EMT06D, EV006M, EV106H, EV106M, EV106M+SC, EV106P, FE105M, FE105X, FG051M, FG051X, FG105M, FG105X, GC106M, GM106H, GM106M, GM106M+SC, GM106P, GMT06D, GV106H, GV106M, GV106M+SC, GV106P, GVT06D, MACE07M, MACG07M, MCE071M, MCG071M, ME061D, ME061H, ME061M...(Other models you can see in the webshop)		

hexagonal nuts metric (without norm)



Part No.	550681	Ref. No.	58004050 LA58004050 LAR58004050
description	nut thread M12x1.25 H 5mm WS 17 brass Qty 1 pcs		
For models:	ACG10M, AVE07D, AVE10D, AVE10P, BPE064M, BPE064P, BPE074M, BPE074P, BPE084M, BPE084P, BPE104M, BPE104P, BPG064M, BPG064P, BPG074M, BPG074P, BPG084M, BPG084P, BPG104M, BPG104P, CE071M, CE100M, CE200M, CG071M, CG100M, CG200M, CGC24M, CGC40M, EC106M, EC110M, EC210M, EM010M+SC, EM106H, EM106M, EM106M+SC, EM106P, EM110H, EM110M, EM110M+SC, EM110P, EM210H, EM210M, EM210M+SC, EM210P, EMT06D, EPE056T, EPE086T, EPE156T, EPEV05T, EPEV08T...(Other models you can see in the webshop)		



Part No.	691289	Ref. No.	58004830 LAR58004830
description	nut thread M18x1 H 5mm WS 22 brass Qty 1 pcs for door handle		
For models:	ACG10M, AVE07D, AVE10D, AVE10P, BPE044M, BPE044P, BPE054M, BPE054P, BPE064M, BPE064P, BPE074M, BPE074P, BPE084M, BPE084P, BPE104M, BPE104P, BPG044M, BPG044P, BPG054M, BPG054P, BPG064M, BPG064P, BPG074M, BPG074P, BPG084M, BPG084P, BPG104M, BPG104P, CE041M, CE051M, CE071M, CE100M, CE200M, CG051M, CG071M, CG100M, CG200M, CVE004H, CVE004M, CVE104H, CVE104M, CVE105H, CVE105M, CVG105H, CVG105M, EC106M, EC110M, EC210M, EM010M+SC, EM106H...(Other models you can see in the webshop)		



washers

spring washers



Part No.	697933	Ref. No.	61420021 LAR61420021
description	spring washer ID ø 13mm ED ø 24mm Qty 1 pcs		
For models:	CGC24M, CGC40M, EPE156T, EPEV15T, EPG156T, EPGV15T, GEMT21P, GEMT21T, GEMT40P, GEMT40T, GEVT21P, GEVT21T, GEVT40P, GEVT40T, GGMT21P, GGMT21T, GGMT40P, GGMT40T, GGV21P, GGV21T, GGV40P, GGV40T, HME201P, HME201T, HME201X, HME202P, HME202T, HME202X, HMG201P, HMG201T, HMG201X, HMG202P, HMG202T, HMG202X, HVE201P, HVE201T, HVE201X, HVE202P, HVE202T, HVE202X, HVG201P, HVG201T, HVG201X, HVG202P, HVG202T, HVG202X, MCE201M, MCE202M, MCG201M, MCG202M...(Other models you can see in the webshop)		



Part No.	696397	Ref. No.	61620091 LAR61620091
description	spring washer ID ø 6.3mm ED ø 14mm Qty 1 pcs		
For models:	CGC24M, CGC40M, EPE156T, EPEV15T, EPG156T, EPGV15T, GEMT21P, GEMT21T, GEMT40P, GEMT40T, GEVT21P, GEVT21T, GEVT40P, GEVT40T, GGMT21P, GGMT21T, GGMT40P, GGMT40T, GGV21P, GGV21T, GGV40P, GGV40T, HME201P, HME201T, HME201X, HME202P, HME202T, HME202X, HMG201P, HMG201T, HMG201X, HMG202P, HMG202T, HMG202X, HVE201P, HVE201T, HVE201X, HVE202P, HVE202T, HVE202X, HVG201P, HVG201T, HVG201X, HVG202P, HVG202T, HVG202X, MCE201M, MCE202M, MCG201M, MCG202M...(Other models you can see in the webshop)		

washers

miscellaneous



Part No.	691296	Ref. No.	61400052 LA61400052 LAR61400052
description	plain washer ID ø 10.5mm ED ø 21mm thickness 2mm SS Qty 1 pcs for fan wheel		
For models:	AVE07D, BPE064M, BPE064P, BPE074M, BPE074P, BPG064M, BPG064P, BPG074M, BPG074P, CE071M, CG071M, CVE105H, CVE105M, CVG105H, CVG105M, EC106M, EM106H, EM106M, EM106M+SC, EM106P, EMT06D, EV006M, EV106H, EV106M, EV106M+SC, EV106P, FE105M, FE105X, FG051M, FG051X, FG105M, FG105X, GC106M, GEMT06P, GEMT06T, GEVT06P, GEVT06T, GGMT06P, GGMT06T, GGV06P, GGV06T, GM106H, GM106M, GM106M+SC, GM106P, GMT06D, GV106H, GV106M, GV106M+SC, GV106P...(Other models you can see in the webshop)		



Part No.	691292	Ref. No.	10401710 LAR10401710
description	plain washer ID ø 12mm ED ø 17.5mm thickness 1mm SS Qty 1 pcs		
For models:	ACG10M, AVE07D, AVE10D, AVE10P, BPE064M, BPE064P, BPE074M, BPE074P, BPE084M, BPE084P, BPE104M, BPE104P, BPG064M, BPG064P, BPG074M, BPG074P, BPG084M, BPG084P, BPG104M, BPG104P, CE071M, CE100M, CE200M, CG071M, CG100M, CG200M, EMT06D, EPE056T, EPE086T, EPEV05T, EPEV08T, EPG056T, EPG086T, EPGV05T, EPGV08T, GEMT06P, GEMT06T, GEMT10P, GEMT10T, GEMT20P, GEMT20T, GEVT06P, GEVT06T, GEVT10P, GEVT10T, GEVT20P, GEVT20T, GGMT06P, GGMT06T, GGMT10P...(Other models you can see in the webshop)		



Part No.	690593	Ref. No.	58002570 LA58002570 LAR58002570
description	plain washer ID ø 15mm ED ø 30mm thickness 3mm Qty 1 pcs for door hinge		
For models:	CGC24M, CGC40M, EPE156T, EPEV15T, EPG156T, EPGV15T, GEMT21P, GEMT21T, GEMT40P, GEMT40T, GEVT21P, GEVT21T, GEVT40P, GEVT40T, GGMT21P, GGMT21T, GGMT40P, GGMT40T, GGV21P, GGV21T, GGV40P, GGV40T, HME201P, HME201T, HME201X, HME202P, HME202T, HME202X, HMG201P, HMG201T, HMG201X, HMG202P, HMG202T, HMG202X, HVE201P, HVE201T, HVE201X, HVE202P, HVE202T, HVE202X, HVG201P, HVG201T, HVG201X, HVG202P, HVG202T, HVG202X, MCE201M, MCE202M, MCG201M, MCG202M...(Other models you can see in the webshop)		



Part No.	551434	Ref. No.	58004010 LA58004010 LAR58004010
description	plain washer ø 30mm thickness 3mm hole ø 12.5mm for fan wheel combi-steamer		
For models:	ACG10M, AVE10D, AVE10P, BPE084M, BPE084P, BPE104M, BPE104P, BPG084M, BPG084P, BPG104M, BPG104P, CE100M, CE200M, CG100M, CG200M, CGC24M, CGC40M, EC110M, EC210M, EM010M+SC, EM110H, EM110M, EM110M+SC, EM110P, EM210H, EM210M, EM210M+SC, EM210P, EPE056T, EPE086T, EPE156T, EPEV05T, EPEV08T, EPEV15T, EPG056T, EPG086T, EPG156T, EPGV05T, EPGV08T, EPGV15T, EV110H, EV110M, EV110M+SC, EV110P, EV210H, EV210M, EV210M+SC, EV210P, FE110M, FE110X...(Other models you can see in the webshop)		



fasteners

clamps

hose clamps

DIN 3017 - W2



1

Part No.	520112	Ref. No.	61630011 LAR61630011
description	hose clamp ø 12-20mm width 9mm Qty 10 pcs DIN 3017		
For models:	AVE07D, AVE10D, AVE10P, CGC24M, CGC40M, CVE004H, CVE004M, CVE104H, CVE104M, CVE105H, CVE105M, CVG105H, CVG105M, EC106M, EC110M, EC210M, EM010M+SC, EM106H, EM106M, EM106M+SC, EM106P, EM110H, EM110M, EM110M+SC, EM110P, EM210H, EM210M, EM210M+SC, EM210P, EMT06D, EPE056T, EPE086T, EPE156T, EPEV05T, EPEV08T, EPEV15T, EPG056T, EPG086T, EPG156T, EPGV05T, EPGV08T, EPGV15T, EV006M, EV106H, EV106M, EV106M+SC, EV106P, EV110H, EV110M, EV110M+SC...(Other models you can see in the webshop)		



1

Part No.	520454	Ref. No.	61630041
description	hose clamp ø 70-90mm width 9mm Qty 5 pcs DIN 3017		

DIN 3017 - W4



1

Part No.	520850	Ref. No.	61630021
description	hose clamp SS W4 ø 32-50mm width 9mm Qty 5 pcs DIN 3017		

FASTENING MATERIAL/CONSUMABLES LAINOX

consumables

sealants and adhesives

high temperature silicone



1

Part No.	890037	Ref. No.	85010015 LAR85010015
description	high temperature silicone MOMENTIVE RTV106 -60 up to +260°C red tube 83ml		
description	Momentive RTV106 - tube 83ml - red Used for sealing heating elements, gasketing, electrical insulation, and other critical bonding and sealing applications where parts must perform at high temperatures. Can be applied to vertical or overhead surfaces. Capability to cure at room temperature and ambient humidity, low temperature flexibility, excellent weatherability and ozone and chemical resistance, excellent electrical insulation properties. Temperature range -60°C to +260°C NSF approved		

cleaning agents

combi-steamer detergents/descalers

Notice: Articles labelled 'DANGEROUS GOODS' are delivered by road through a forwarder for reasons of safety and are charged separately!

1

Part No.	802065	Ref. No.	85150080 CF010 CR0349981 LA85150080 LAR85150080
description	descaler CALFREE Qty 1 pcs 10l		
description			



 <p>1</p>			
Part No.	802112	Ref. No.	85150140 LA85150140 LAR85150140 SCA01
description	descaler for combi-steamer LAINOX SOLID CAL 6 cans of 850g		
description	<p>Lainox SOLID CAL - descaler - 6 cans of 1kg (powder) is a LAINOX product that hinders limescale formation in steam generators. SOLID CAL offers a number of advantages:</p> <ul style="list-style-type: none"> - Faults caused by limescale deposits are avoided - A sufficient amount of clean steam is always available - Maximum energy efficiency and hence reduced consumption - High performance even after a long running time - Longer steam generator life SOLID CLEAN with a new formula has a maximum disinfecting action, can be transported without a permit (not a liquid), takes us little space (solid) and rehydrates during use. 		

 <p>2</p>			
Part No.	802039 ¹	Ref. No.	331520 85150020 CR0331520 LA85150020 LAR85150020
description	detergent for combi-steamer LAINOX Combi Clean 10 litres		
description	<p>Lainox Combi Clean - detergent - canister 10l Triple-action alkaline detergent, specially designed for cleaning the cooking chambers of Lainox combi steamers. With its special 3-in-1 formula with detergent, rinse aid and descaler the detergent removes food residue and gives the cooking chamber a streak-free shine. The detergent helps ensure a long seal life. Can corrode metals.</p>		

¹DANGEROUS GOODS

 <p>1</p>			
Part No.	802105	Ref. No.	85150130 CR0331521 LA85150130 LAR85150130 SCL01
description	detergent for combi-steamer LAINOX SOLID CLEAN 6 cans of 930g		
description	<p>Lainox SOLID CLEAN - detergent - 6 cans of 1kg SOLID CLEAN with a new formula has a maximum disinfecting action, can be transported without a permit (not a liquid), takes us little space (solid) and rehydrates during use.</p>		

fuses

fine fuses

 <p>1</p>			
Part No.	358662	Ref. No.	65200080
description	fine fuse size ø5x20mm 0.125A fast-acting rated 250V Qty 10 pcs		
For models:	<p>ME004L, ME004S, ME104L, ME104S, ME105L, ME105S, ME106L, ME106S, ME106T, ME110L, ME110S, ME110T, ME120L, ME120S, ME120T, ME210L, ME210S, ME210T, ME220L, ME220S, ME220T, MG105L, MG105S, MG106L, MG106S, MG106T, MG110L, MG110S, MG110T, MG120L, MG120S, MG120T, MG210L, MG210S, MG210T, MG220L, MG220S, MG220T, VE004S, VE104S, VE105S, VE106L, VE106S, VE106T, VE110L, VE110S, VE110T, VE210L, VE210S, VE210T...(Other models you can see in the webshop)</p>		

 <p>1</p>			
Part No.	358532	Ref. No.	65200200 LA65200200 LAR65200200
description	fine fuse size ø5x20mm 2A fast-acting rated 250V Qty 10 pcs		
For models:	<p>ACG10M, AVE07D, AVE10D, AVE10P, BPE044M, BPE044P, BPE054M, BPE054P, BPE064M, BPE064P, BPE074M, BPE074P, BPE084M, BPE084P, BPE104M, BPE104P, BPG044M, BPG044P, BPG054M, BPG054P, BPG064M, BPG064P, BPG074M, BPG074P, BPG084M, BPG084P, BPG104M, BPG104P, CE041M, CE051M, CE071M, CE100M, CE200M, CG051M, CG071M, CG100M, CG200M, CGC24M, CGC40M, CVE004H, CVE004M, CVE104H, CVE104M, CVE105H, CVE105M, CVG105H, CVG105M, EC106M, EC110M, EC210M...(Other models you can see in the webshop)</p>		

 <p>1</p>			
Part No.	358678	Ref. No.	65200370 LA65200370
description	fine fuse size ø5x20mm 8A fast-acting rated 250V Qty 10 pcs		

 <p>1</p>			
Part No.	358593	Ref. No.	65200086 LAR65200086 R65200088
description	fine fuse size ø5x20mm 0.125A slow-acting rated 250V Qty 10 pcs		
For models:	<p>BPE044M, BPE044P, BPE054M, BPE054P, BPE064M, BPE064P, BPE074M, BPE074P, BPE084M, BPE084P, BPE104M, BPE104P, BPG044M, BPG044P, BPG054M, BPG054P, BPG064M, BPG064P, BPG074M, BPG074P, BPG084M, BPG084P, BPG104M, BPG104P, CVE004H, CVE104H, CVE105H, CVG105H, EM1010M+SC, EM106H, EM106M+SC, EM106P, EM110M+SC, EM110P, EM210M+SC, EM210P, EPE056T, EPE086T, EPE156T, EPEV05T, EPEV08T, EPEV15T, EPG056T, EPG086T, EPG156T, EPGV05T, EPGV08T, EPGV15T, EV106H, EV106M+SC...(Other models you can see in the webshop)</p>		



			
1			
Part No.	358592	Ref. No.	65200140 65200300 LA65200300 LAR65200140 LAR65200300
description	fine fuse size ø5x20mm 0.1A slow-acting rated 250V Qty 10 pcs		
For models:	GMT20D, ME004L, ME004S, ME104L, ME104S, ME105L, ME105S, ME106L, ME106S, ME110L, ME110S, ME120L, ME120S, ME210L, ME210S, ME220L, ME220S, MG061M, MG101D, MG101M, MG102D, MG102M, MG105L, MG105S, MG106L, MG106S, MG110L, MG110S, MG120L, MG120S, MG201D, MG201M, MG210L, MG210S, MG220L, MG220S, MGMT20D, VG101D, VG101M, VG102D, VG102M, VG201D, VG201M		

			
1			
Part No.	358595	Ref. No.	65200145 65200320 LA65200320 LAR65200145 LAR65200320
description	fine fuse size ø5x20mm 0.2A slow-acting rated 250V Qty 10 pcs		
For models:	AVE10D, BPE064P, BPE074P, BPG064P, BPG074P, CE100M, CE200M, EC106M, EM106H, EM106M, EM106M+SC, EM106P, EM110H, EM110P, EM210H, EM210P, EPE056T, EPEV05T, EPG056T, EPGV05T, EV006M, EV106H, EV106M, EV106M+SC, EV106P, EV110H, EV110P, EV210H, EV210P, FG051X, FG105X, GC106M, GEMT06P, GEMT06T, GEVT06P, GEVT06T, GGMT06P, GGMT06T, GGVT06P, GGVT06T, GM106H, GM106M, GM106M+SC, GM106P, GM110H, GM210H, GV106H, GV106M, GV106M+SC, GV106P..(Other models you can see in the webshop)		

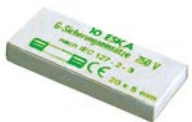
			
1			
Part No.	358703	Ref. No.	65200350 LA65200350 LAR65200350
description	fine fuse size ø5x20mm 0.4A slow-acting rated 250V Qty 10 pcs		
For models:	BPE084P, BPE104P, BPG084P, BPG104P, CGC24M, CGC40M, EC110M, EC210M, EM010M+SC, EM110H, EM110M, EM110M+SC, EM110P, EM210H, EM210M, EM210M+SC, EM210P, EPE086T, EPE156T, EPEV08T, EPEV15T, EPG086T, EPG156T, EPGV08T, EPGV15T, EV110H, EV110M, EV110M+SC, EV110P, EV210H, EV210M, EV210M+SC, EV210P, FE105X, FG101X, FG110X, FG210X, GC110M, GC210M, GEMT10P, GEMT10T, GEMT20P, GEMT20T, GEMT21P, GEMT21T, GEMT40P, GEMT40T, GEVT10P, GEVT10T, GEVT20P..(Other models you can see in the webshop)		

			
1			
Part No.	358600	Ref. No.	65200160
description	fine fuse size ø5x20mm 1A slow-acting rated 250V Qty 10 pcs		

			
1			
Part No.	358609	Ref. No.	65200240 R65200240
description	fine fuse size ø5x20mm 5A slow-acting rated 250V Qty 10 pcs		

fine fuse holders

			
1			
Part No.	358512	Ref. No.	50302160 65210020 LA65210020 LAR50302160 LAR65210020
description	fuse holder		
For models:	ACG10M, AVE07D, AVE10D, AVE10P, BPE044M, BPE044P, BPE054M, BPE054P, BPE064M, BPE064P, BPE074M, BPE074P, BPE084M, BPE084P, BPE104M, BPE104P, BPG044M, BPG044P, BPG054M, BPG054P, BPG064M, BPG064P, BPG074M, BPG074P, BPG084M, BPG084P, BPG104M, BPG104P, CE041M, CE051M, CE071M, CE100M, CE200M, CG051M, CG071M, CG100M, CG200M, CGC24M, CGC40M, CVE004H, CVE004M, CVE104H, CVE104M, CVE105H, CVE105M, CVG105H, CVG105M, EC106M, EC110M, EC210M... (Other models you can see in the webshop)		

GASTROPARTS.COM

