



GASTROPARTS

La-Spaziale

- [EN]** Equipment
- [DE]** Geräte
- [ES]** Aparatos
- [FR]** Équipement
- [IT]** Attrezzature
- [PL]** Urządzenia
- [RU]** Оборудование

✉ gastroparts@gastroparts.com

☎ +48 56 657 00 66

📘 fb.com/gastroparts.global

GASTROPARTS.COM





heating elements

heating elements for coffee machine



1

Part No.	417390	Ref. No.	806
description	heating element 1250W 220V heating circuits 1 L 135mm W 50mm H 22mm L1 24mm L2 36mm L3 75mm mounting distance 42mm thread 1/4" connection male faston 6.3mm connection length 22mm tube ø 8.3mm 2 hole fixing immersion heater		



1

Part No.	417391	Ref. No.	7201
description	heating element 1250W 230V heating circuits 1 flange ø 50mm L 160mm W 22mm H 54mm tube ø 8.3mm connection male faston 6.3mm immersion heater		





1

Part No.	417393	Ref. No.	7478
description	heating element 1250W 230V heating circuits 1 ø 65mm H 200mm W1 48mm H1 135mm H2 65mm mounting distance 32mm thread 3/8" copper windings 5 tube ø 8.5mm immersion heater 2 hole fixing connection male faston 6.3mm		



1

Part No.	417038	Ref. No.	N/A
description	heating element 2700W 230V heating circuits 1 ø 110mm H 200mm W1 48mm H1 158mm H2 42mm mounting distance 40mm thread 3/8" copper windings 4 tube ø 8mm immersion heater 2 hole fixing connection M6		
accessories for	417038		
	Part No.	361183	Ref. No. —
	nut thread 3/8" H 6mm nickel-plated brass WS 20 Qty 1 pcs		
	Part No.	521137	Ref. No. —
	flat gasket fibre ED ø 20mm ID ø 18mm thickness 1.5mm for thread 3/8" Qty 1 pcs		



1

Part No.	417394	Ref. No.	425
description	heating element 2700W 230V heating circuits 1 ø 112mm H 205mm W1 44mm H1 160mm H2 45mm mounting distance 30mm thread 3/8" copper windings 4 tube ø 8.5mm immersion heater connection male faston 6.3mm		



1

Part No.	417387	Ref. No.	5504
description	heating element 2800W 230V heating circuits 3 mounting ø 50mm hole distance 63mm L 345mm W 35mm H 75mm L1 40mm L2 50mm L3 255mm H1 35mm H2 40mm tube ø 8.3mm connection male faston 6.3mm immersion heater 3 hole flange		



1

Part No.	417389	Ref. No.	426
description	heating element 3500W 230V heating circuits 1 ø 115mm H 205mm W1 50mm H1 160mm H2 45mm mounting distance 32mm thread 3/8" copper windings 4 tube ø 8.5mm immersion heater 2 hole fixing connection male faston 6.3mm		



1

Part No.	417388	Ref. No.	1724
description	heating element 3500W 230V heating circuits 3 mounting ø 50mm hole distance 63mm L 350mm W 35mm H 70mm L1 40mm L2 60mm L3 250mm H1 35mm H2 35mm hole ø 8mm tube ø 8.3mm connection male faston 6.3mm immersion heater 3 hole flange		



1

Part No.	417386	Ref. No.	5505
description	heating element 3800W 230V heating circuits 3 mounting ø 50mm hole distance 63mm L 550mm W 35mm H 70mm L1 45mm L2 55mm L3 450mm H1 35mm H2 35mm hole ø 8mm tube ø 8.3mm connection male faston 6.3mm immersion heater 3 hole flange		



			
Part No.	417147	Ref. No.	5505
description	heating element 3800W 230V heating circuits 3 mounting ϕ 51mm hole distance 63mm L 550mm W 38mm H 65mm hole ϕ 10mm thermostat sleeves ϕ 7mm length thermostat sleeves 245mm number of thermostat sleeves 1 thermostat sleeve not clinging tube ϕ 8mm connection M6 immersion heater 3 hole flange		

			
Part No.	417392	Ref. No.	7356
description	heating element 800W 230V heating circuits 1 flange ϕ 50mm L 160mm W 22mm H 54mm tube ϕ 8.3mm connection male faston 6.3mm immersion heater		

heating elements for contact grills

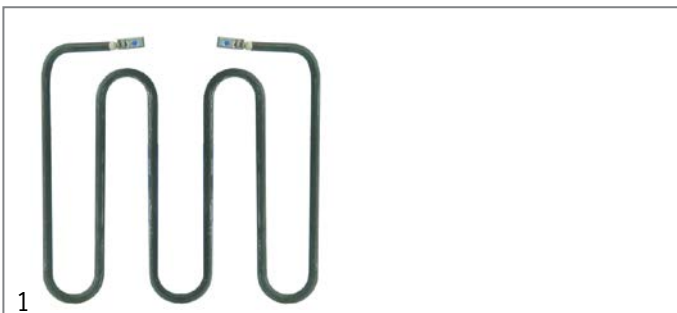
			
Part No.	416145	Ref. No.	2987
description	heating element 1000W 230V L 177mm W 180mm H 18mm W1 46mm W2 88mm tube ϕ 6.3mm windings 3 connection M4 dry heating element		

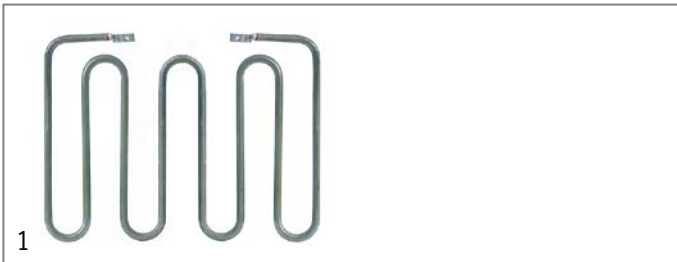
			
Part No.	416146	Ref. No.	5684
description	heating element 1200W 230V L 180mm W 228mm H 20mm W1 55mm W2 118mm connection length 23mm tube ϕ 6.3mm windings 4 connection M4 dry heating element		

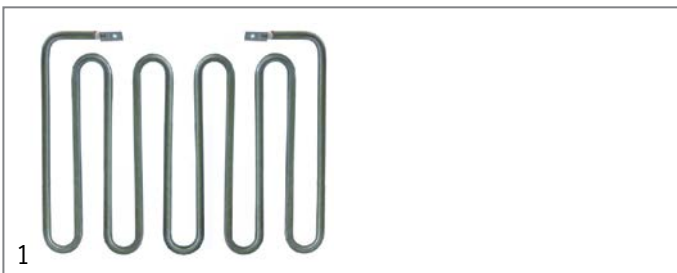
			
Part No.	416147	Ref. No.	5697
description	heating element 1500W 230V L 180mm W 175mm H 15mm W1 52mm W2 71mm connection length 22mm tube ϕ 6.3mm windings 5 connection M4 dry heating element		

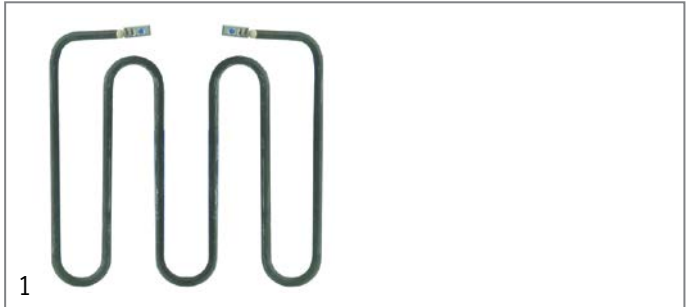
			
Part No.	416148	Ref. No.	2986
description	heating element 800W 230V heating circuits 1 L 175mm W 180mm H 20mm W1 46mm W2 118mm connection length 23mm tube ϕ 6.3mm windings 3 connection M4 dry heating element		

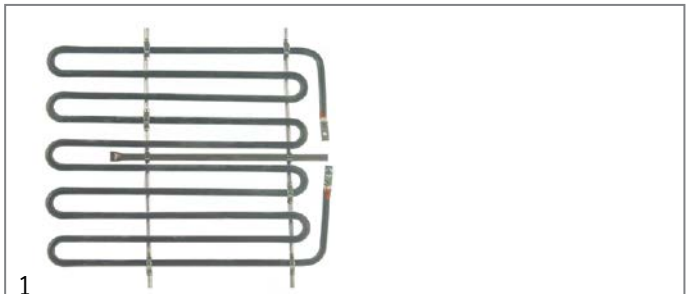
			
Part No.	416173	Ref. No.	6521
description	heating element 850W 230V heating circuits 1 L 254mm W 202mm H 25mm W1 68mm W2 66mm connection length 23mm tube ϕ 6.3mm windings 5 connection M4 number of thermostat sleeves 1 thermostat sleeves ϕ 5mm length thermostat sleeves 195mm bridge length 240mm dry heating element		

accessories

washers

			
Part No.	560113	Ref. No.	1746 624
description	plain washer ID ϕ 6.4mm ED ϕ 12mm thickness 1.6mm SS Qty 20 pcs DIN 125A for thread M6		

sealing washers

graphite gaskets

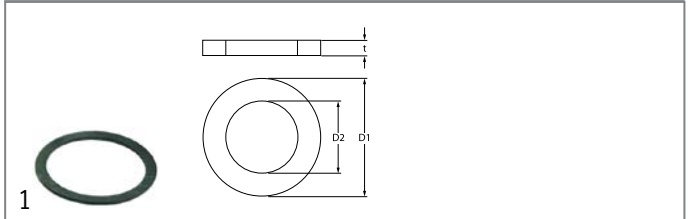
			
Part No.	528016	Ref. No.	N/A
description	flat gasket graphite ED ϕ 62mm ID ϕ 50mm thickness 2mm Qty 1 pcs		



PTFE gaskets

Part No.	528885	Ref. No.	424
description	flat gasket PTFE ED ø 26mm ID ø 17mm thickness 2mm Qty 1 pcs suitable for SPAZIALE		

O-rings

Part No.	510243	Ref. No.	02418
description	O-ring Viton thickness 3.53mm ID ø 55.56mm Qty 1 pcs		

flange gaskets

Part No.	528024	Ref. No.	N/A
description	gasket for heating element		

Part No.	528015	Ref. No.	N/A
description	gasket ID ø 55mm fibre thickness 2mm hole ø 8mm hole distance 62mm suitable for SPAZIALE for heating element coffee machine parts		

thermostats

bi-metal thermostats

safety bi-metal thermostats

Part No.	390590	Ref. No.	3343
description	bi-metal safety thermostat hole distance 24mm switch-off temp.°C 1NC 1-poleAV connection plug 2 hole fixing		

Part No.	390709	Ref. No.	6687
description	bi-metal safety thermostat switch-off temp. 180°C 1NC 1-pole 16A connection F6.3 screw mounting thread M4		

control and safety thermostats

EGO

safety thermostats

55.32_ series

Part No.	390324	Ref. No.	1477
description	safety thermostat switch-off temp. 169°C 3-pole 3NC 20A probe ø 4mm probe L 128mm capillary pipe 890mm capillary pipe isolated 210/210mm gland nut probe SS		

IMIT / TEMPOMATIC / ARTHERMO

control thermostats

Part No.	390707	Ref. No.	11168 809
description	thermostat t.max. 130°C temperature range°C 1-pole NC 16A probe ø 7mm probe L 90mm capillary pipe 150mm capillary pipe isolatedmm gland nut M14x1 shaft ø 6x4.6mm shaft L 23mm rotation 270°		

switches and momentary switches

rocker/momentary rocker switches

30x11mm

Part No.	301010	Ref. No.	805
description	rocker switch mounting measurements 30x11mm red 1NO/indicator light 250V 16A 0-I connection male faston 6.3mm ambient temperature max. 85/125°C protection IP40		
accessories for	301010		
	Part No.	Ref. No.	—
	protective cover mounting measurements 30x11mm		



30x22mm



1

Part No.	301001	Ref. No.	804
description	rocker switch mounting measurements 30x22mm red 2NO 250V 16A illuminated 0-I connection male faston 6.3mm ambient temperature max. 125/55°C protection IP65		
accessories for	301001		
	Part No.	301036	Ref. No. —
	protective cover internal size 30x22mm for rocker switch mounting measurementsmm		

push/momentary push switches

20.6x16.4mm



1

Part No.	347320	Ref. No.	4953
description	momentary push switch mounting measurements 20.6x16.4mm black 1NO 250V 12A connection male faston 6.3mm ambient temperature max. 85°C protection IP40		

28.5x28.5mm





1

Part No.	345142	Ref. No.	2942
description	push switch mounting measurements 28.5x28.5mm red/green 2NO 250V 16A cup connection male faston 6.3mm ambient temperature max. 150°C protection IP40 with indicator		



1

Part No.	347319	Ref. No.	2942
description	push switch mounting measurements 28.5x28.5mm green/red 2NO 250V 16A cup connection male faston 6.3mm ambient temperature max. 150°C protection IP40 with indicator		
spare parts for	347319		
	Part No.	345604	Ref. No. —
	element holder single mounting measurements 28.5x28.5mm black for push buttons 23x23mm		
	Part No.	345720	Ref. No. —
	switch 2NO 250V 16A connection male faston 6.3mm		
	Part No.	346251	Ref. No. —
	rotary disc orange/green disc ø 20.6mm		

miscellaneous



1

Part No.	347321	Ref. No.	5825
description	switch black 1NO 20V 1A momentary connection coded plug ambient temperature max. 85°C		

microswitches

pin-plunger actuated

M10



1

Part No.	347216	Ref. No.	607
description	microswitch with plunger thread M10x0.75 thread L 14mm 250V 10A 1CO connection male faston 6.3mm stroke 7.5mm mounting distance 22mm L 28mm ambient temperature max. 125°C type NR6K5 actuating force: 260g		



1

Part No.	345032	Ref. No.	607
description	microswitch with plunger thread M10x1 thread L 12mm 250V 16A 1CO connection male faston 6.3mm stroke 7mm mounting distance 22mm L 28mm ambient temperature max. 125°C type SP9603 actuating force: 180g		

system switches (ROLD)



1

Part No.	347192	Ref. No.	6619
description	switch 2NO 250V 16A connection male faston 6.3mm		
accessories for	347192		
	Part No.	347183	Ref. No. —
	push button mounting ø 14.3mm chrome-plated		



float switches

			
1			
Part No.	347337	Ref. No.	1322
description	float switch thread 1/8" 1NC ø 28mm L 100mm mounting ø 1/8"mm 230V 0.5A plug-in connection cable length 300mm		

rotary switches

GIOVENZANA

rotary switches

			
1			
Part No.	347323	Ref. No.	503
description	rotary switch 2 0-1 sets of contacts 2 type PO20 690V 20A shaft ø 5x5mm shaft L 28mm shaft square connection screw		

			
1			
Part No.	347326	Ref. No.	2496
description	rotary switch 2 0-1 sets of contacts 2 type PO20 690V 32A shaft ø 5x5mm shaft L 28mm shaft square connection screw 2 operating positions		

			
1			
Part No.	347324	Ref. No.	2620
description	rotary switch 2 0-1 sets of contacts 4 type PO20 690V 20A shaft ø 5x5mm shaft L 28mm shaft square connection screw		

			
1			
Part No.	347325	Ref. No.	5694
description	rotary switch 3 0-1-2 sets of contacts 6 type PO20 690V 20A shaft ø 5x5mm shaft L 23mm shaft square connection screw		

accessories

			
1			
Part No.	111344	Ref. No.	2421
description	knob zero mark ø 40mm shaftmm shaft diameter 5x5mm		

VM

			
1			
Part No.	347322	Ref. No.	504
description	rotary switch 0-1 36A shaft L 24mm connection screw 2 operating positions 4-pole CODE P501531 shaft 5x5mm		

accessories

levers

			
1			
Part No.	111342	Ref. No.	1611 4968 6049
description	lever for rotary switch ON-OFF L 80mm W 32mm aperture 5x5mm black		

magnetic switches

23x14mm

			
1			
Part No.	347339	Ref. No.	7635
description	magnetic switch L 23mm W 14mm NO connection male faston 2.8mm cable length 250mm		

ø 9mm

			
1			
Part No.	346107	Ref. No.	2727
description	magnetic switch NO connection male faston 6.3mm cable length 140mm L 31.5mm mounting ø 9mm		



lamps

indicator lights

indicator light lenses

ø10mm (type SRZ-3)



1

Part No.	359123	Ref. No.	1113
-----------------	--------	-----------------	------

description	indicator light housings mounting measurements ø10mm green round Qty 1 pcs		
--------------------	--	--	--

accessories for	359123		
------------------------	--------	--	--



Part No.	359132	Ref. No.	—
description	indicator lamp green 250V connection male faston 6.3mm protection IP54 ambient temperature max. 85°C		

indicator lamps for socket type SRZ / SDK / SDY / SFK



1

Part No.	359130	Ref. No.	1112 6593
-----------------	--------	-----------------	--------------

description	indicator lamp 230V clear connection male faston 6.3mm ø 8mm		
--------------------	--	--	--



1

Part No.	359573	Ref. No.	1112 6593
-----------------	--------	-----------------	--------------

description	indicator lamp 230V connection plug-in connection ø 8mm		
--------------------	---	--	--

indicator lights (complete)

30x11mm



1

Part No.	359158	Ref. No.	1096
-----------------	--------	-----------------	------

description	indicator light mounting measurements 30x11mm 230V red connection male faston 6.3mm temp.-resist. 125°C		
--------------------	---	--	--

relays

level relays

GIEMME



1

Part No.	402535	Ref. No.	5236
-----------------	--------	-----------------	------

description	level controller 230V 50/60Hz type RLO 2 RELE+LIV/F		
--------------------	---	--	--



1

Part No.	402532	Ref. No.	1964
-----------------	--------	-----------------	------

description	level controller 230V type MAGNETIC+AUTOL.		
--------------------	--	--	--



1

Part No.	401945	Ref. No.	N/A
-----------------	--------	-----------------	-----

description	level relay 230V voltage AC 5A connection male faston 6.3mm type RL1E/2C/F		
--------------------	--	--	--

probes

producer-specific probes

probes





1

Part No.	379482	Ref. No.	2817
-----------------	--------	-----------------	------

description	temperature probe NTC 200kOhm cable PTFE probe -40 up to +125°C cable -40 up to +250°C connection coded plug thread probe ø4x30mm cable length 0.14m		
--------------------	--	--	--



			
1			
Part No.	402551	Ref. No.	5060
description	temperature probe NTC cable PTFE probe -40 up to +125°C cable -40 up to +250°C connection male faston 2.8mm thread 3/8" probe ø5x10mm cable length 0.1m		

			
1			
Part No.	379481	Ref. No.	1486 7540
description	temperature probe NTC cable PVC probe -40 up to +110°C cable -10 up to 100°C connection male faston 2.8mm thread probe ø4x30mm cable length 0.15m		

			
1			
Part No.	379490	Ref. No.	6226
description	temperature probe PTC cable silicone probe -50 up to +150°C cable -50 up to +180°C connection 2-wire thread probe ø6x40mm cable length 1.2m		

Hall sensors

			
1			
Part No.	402550	Ref. No.	3418
description	Hall sensor L 16mm W 16mm H 10mm for flow meter		

electronics

PCBs

			
1			
Part No.	402513	Ref. No.	6683
description	display L 150mm W 98mm		

			
1			
Part No.	402522	Ref. No.	7390
description	keypad PCB L 154mm W 49mm buttons 5		

			
1			
Part No.	402520	Ref. No.	1485
description	keypad PCB L 31mm W 27mm buttons 1		

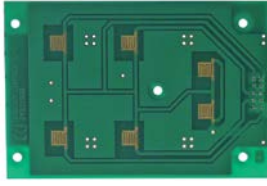
			
1			
Part No.	402521	Ref. No.	6001
description	keypad PCB L 94mm W 64mm buttons 6		

			
1			
Part No.	402508	Ref. No.	1561
description	PCB L 100mm W 60mm with button supply 240VAC		

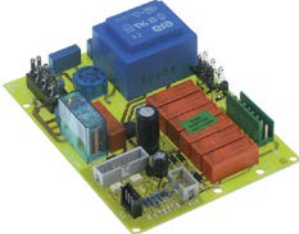
			
1			
Part No.	402506	Ref. No.	6682
description	PCB L 135mm W 100mm supply 230VAC		

			
1			
Part No.	402498	Ref. No.	7389
description	PCB L 140mm W 80mm supply 230VAC		





			
1			
Part No.	402499	Ref. No.	7522
description	PCB L 140mm W 80mm supply 230VAC		

			
1			
Part No.	402536	Ref. No.	6263
description	PCB L 178mm W 100mm doser supply 230VAC		

			
1			
Part No.	402493	Ref. No.	1584 1585
description	PCB L 200mm W 100mm for display PCB supply 230VAC		

			
1			
Part No.	402505	Ref. No.	4850
description	PCB L 200mm W 100mm supply 230VAC		

			
1			
Part No.	402510	Ref. No.	2948
description	PCB L 80mm W 55mm supply 24VAC		

			
1			
Part No.	402511	Ref. No.	5067
description	PCB L 80mm W 55mm supply 24VAC		

central units

			
1			
Part No.	402538	Ref. No.	6381
description	central unit 24V 5A		

			
1			
Part No.	402512	Ref. No.	4951
description	central unit with display		

dosing electronics

GICAR

group 5

			
1			
Part No.	403207	Ref. No.	N/A
description	dosing electronics 230V voltage AC 50/60Hz 10A type DOS 30/2GR+LIV		



GIEMME



1			
Part No.	402533	Ref. No.	2473
description	dosing electronics 230V 50/60Hz 8A type RLO 2GR+RL/F		



1			
Part No.	402534	Ref. No.	3200
description	dosing electronics 230V 50/60Hz 5-10A type RL2 4GR+RL+THE/F-C		

keypads

front foils



1			
Part No.	402529	Ref. No.	1518
description	keypad foil coffee machine Super 3000 L 193mm W 60mm buttons 5		



1			
Part No.	400499	Ref. No.	1521
description	keypad foil L 110mm W 38mm buttons 5		



1			
Part No.	400500	Ref. No.	2475
description	keypad foil L 110mm W 38mm buttons 5		



1			
Part No.	402531	Ref. No.	4643
description	keypad foil L 110mm W 38mm buttons 5		



1			
Part No.	402530	Ref. No.	1519
description	keypad foil L 193mm W 59mm buttons 1		

membrane keypads



1			
Part No.	403677	Ref. No.	08500
description	membrane keypad for espresso machine S5/S5 COMPACT buttons 5 L 75mm W 32mm		



1			
Part No.	402523	Ref. No.	5805
description	membrane keypad L 108mm W 48mm		



1			
Part No.	402524	Ref. No.	6308
description	membrane keypad L 135mm W 100mm		

keypad units



1			
Part No.	402514	Ref. No.	1605
description	keypad unit buttons 1 lighting red L 70mm W 48mm		



1			
Part No.	402516	Ref. No.	1598
description	keypad unit buttons 5 L 118mm W 43mm		





1			
Part No.	402518	Ref. No.	2474
description	keypad unit buttons 5 L 118mm W 43mm		





			
1			
Part No.	402519	Ref. No.	4848
description	keypad unit buttons 5 L 118mm W 43mm		

accessories

			
1			
Part No.	402527	Ref. No.	7396
description	buttons strip buttons 5 L 154mm W 31mm		

			
1			
Part No.	402528	Ref. No.	7397
description	buttons strip buttons 5 L 154mm W 31mm		

			
1			
Part No.	402526	Ref. No.	7395
description	buttons strip buttons 5 L 156mm W 31mm		

			
1			
Part No.	402525	Ref. No.	5498
description	buttons strip buttons 5 L 88mm W 64mm		

			
1			
Part No.	347334	Ref. No.	6297
description	push button external size 28x40mm black		

solenoid valves

solenoid valves (water)

TP

solenoid valves with reducers

			
1			
Part No.	370427	Ref. No.	3345
description	solenoid valve single angled 230VAC inlet 3/4" outlet 11.5mm input/ min output 1.2l/min DN10 t.max. 90°C TP plastic flow regulating valve outlet dark brown		

metal

ASCO

spare parts and accessories

O-rings

			
1			
Part No.	371095	Ref. No.	625
description	O-ring Viton thickness 1.78mm ID ø 6.07mm Qty 1 pcs		

LUCIFER

3-way

131F series







			
1			
Part No.	370053	Ref. No.	628
description	solenoid valve 3-ways 230VAC DN 2.5mm slide-on receptacle DIN -10 up to 140°C type series 131F coil type DZ06S6 membranes FKM (water/steam) p max 10bar flange 32x32mm		
spare parts for	370053		
	Part No.	370061	Ref. No. 626
	solenoid valve body LUCIFER-PARKER 3-ways outer cone		
	Part No.	371031	Ref. No. —
	solenoid coil LUCIFER-PARKER 230VAC 9VA coil type DZ06S6 seat ø 15mm		
accessories for	370053		
	Part No.	371090	Ref. No. —
	power socket plug type DIN 43650A screw		
	Part No.	371095	Ref. No. 625
	O-ring Viton thickness 1.78mm ID ø 6.07mm Qty 1 pcs		

Table continues overleaf



accessories for	370053			
	Part No.	371100	Ref. No.	—
	O-ring silicone thickness 1.78mm ID ø 6.07mm Qty 1 pcs			

spare parts and accessories

valve bodies

	1		
Part No.	370061	Ref. No.	626
description	solenoid valve body LUCIFER-PARKER 3-ways outer cone		

ODE

solenoid valves steam (water)

21A series

	1		
Part No.	370582	Ref. No.	4843
description	solenoid valve brass 2-ways 24VAC inlet 1/4" outlet 1/4" connection 1/4" L 40mm DN 5.5mm -10 up to 140°C ODE coil type BDA membranes FKM (water/steam) p max 3bar 50/60Hz		

31A1 series

	1		
Part No.	370583	Ref. No.	1379
description	solenoid valve brass 3-ways 24VAC DN 1.5mm -10 up to 140°C ODE type series 31A1 coil type BDA membranes ruby p max 15bar p min 0bar flange 32x32mm 24V voltage AC		



PARKER

2-way

7121 series

	1		
Part No.	370584	Ref. No.	907
description	solenoid valve SS 230VAC inlet 1/8" outlet 1/8" connection 1/8" DN 1.5mm coil type BDA p max 15bar 50Hz inlet 1/8"mm		

E-146 series

	1			
Part No.	370067	Ref. No.	6478	
description	solenoid valve 2-ways 230VAC connection 1/4" L 40mm DN 3mm slide-on receptacle DIN -20° up to 130°C PARKER type series VE-146 coil type ZB09 membranes FKM (water) p max 7bar			
spare parts for	370067			
	Part No.	371029	Ref. No.	—
	solenoid coil PARKER 230VAC 9VA coil type ZB09 seat ø 14mm H 33mm W 34mm D 43mm			
accessories for	370067			
	Part No.	371090	Ref. No.	—
	power socket plug type DIN 43650A screw			

Solenoid valve - accessories

	1		
Part No.	371095	Ref. No.	625
description	O-ring Viton thickness 1.78mm ID ø 6.07mm Qty 1 pcs		

electrodes

	1		
Part No.	402554	Ref. No.	6357
description	level electrode 1/4" total length 105mm probe L 87mm insulated probe length 74mm connection curved ø 3mm		

	1		
Part No.	402555	Ref. No.	7852
description	level electrode 1/4" total length 130mm probe L 110mm insulated probe length 105mm connection curved ø 3mm		

	1		
Part No.	400020	Ref. No.	911
description	level electrode 1/4" total length 150mm probe L 124mm insulated probe length 26mm connection male faston 6.3mm stainless steel ø 2.5mm		



			
1			
Part No.	402553	Ref. No.	911
description	level electrode 1/4" total length 155mm probe L 136mm insulated probe length 124mm connection curved \varnothing 3mm		

			
1			
Part No.	402556	Ref. No.	6368
description	level electrode total length 303mm connection curved SS \varnothing 3mm		

flow meters and flow sensors

flow meters



miscellaneous

			
1			
Part No.	402542	Ref. No.	2498
description	flow meter thread 1/4" SS		

			
1			
Part No.	402550	Ref. No.	3418
description	Hall sensor L 16mm W 16mm H 10mm for flow meter		

pumps

pumps for ice machines

			
1			
Part No.	500161	Ref. No.	2980
description	pump REBO type NR40 55W 230V 50Hz outlet \varnothing 17mm L 110mm rotation direction left for ice-cube maker		
spare parts for	500161		
	Part No.	500970	Ref. No. —
	pump motor 55W 230V 50Hz REBO L 205mm type outlet \varnothing mm suitable for for ice maker		

fuses

fine fuses

			
1			
Part No.	358605	Ref. No.	6249
description	fine fuse size \varnothing 5x20mm 3.15A slow-acting rated 250V Qty 10 pcs		

equipment-specific units

for bar blender

blenders

jar components

blades

blades with adaptor (complete)

			
1			
Part No.	696742	Ref. No.	C0007F305
description	slicing unit \varnothing 52mm P100/P102/P103/P105		



for ice-cube maker

drain systems

overflow pipes

			
1			
Part No.	695083	Ref. No.	6120
description	overflow pipe ID ø 22mm D1 ø 27mm D2 ø 19mm L 144mm		

for espresso machines

fascias

			
1			
Part No.	692672	Ref. No.	01591
description	side panel L 180mm H 67mm D 30 mounting pos. left Super 3000		

			
1			
Part No.	692673	Ref. No.	01592
description	side panel L 180mm H 67mm D 30 mounting pos. right Super 3000		



filter holders



filter holders standard

filter holder without spout

			
1			
Part No.	525986	Ref. No.	N/A
description	filter holder suitable for SPAZIALE without outlet mounting ø 76mm outlet 3/8" ID ø 56mm wedge hight 12mm wedge position horizontal number of wedges 2 lever straight		

filter holders short

			
1			
Part No.	525165	Ref. No.	2891
description	filter holder mounting ø 76mm outlet 3/8" ID ø 56mm handle M12x1.25 wedge hight 12mm wedge position horizontal number of wedges 2 lever straight chrome-plated brass		
accessories for	525165		
	Part No.	Ref. No.	
	525127	4962	
	 handle ø 25mm thread M12x1.25 thread L 12mm L 122mm black thermoplastic		

			
1			
Part No.	529060	Ref. No.	N/A
description	filter holder mounting ø 76mm outlet 3/8" ID ø 56mm handle M12x1.75 wedge hight 12mm wedge position horizontal number of wedges 2 lever straight chrome-plated brass		
accessories for	529060		
	Part No.	Ref. No.	
	529045	—	
	 handle ø 35mm thread M12x1.75 thread L 15mm L 125mm black		

handles

with external thread

			
1			
Part No.	525127	Ref. No.	4962
description	handle ø 25mm thread M12x1.25 thread L 12mm L 122mm black thermoplastic		

sleeves

			
1			
Part No.	525139	Ref. No.	4961 9924
description	sleeve ø 36mm L 38mm black		

filters

for 1 cup

			
1			
Part No.	525156	Ref. No.	1945
description	coffee filter ø 65mm mounting ø 55mm H 23.3mm cups 1 amount of coffee 6g		

			
1			
Part No.	529029	Ref. No.	646
description	coffee filter ø 65mm mounting ø 55mm H 25mm cups 1 amount of coffee 7g		



for 2 cups



1			
Part No.	525155	Ref. No.	1943
description	coffee filter ø 65mm mounting ø 55mm H 25.7mm cups 2 amount of coffee 12g		



1			
Part No.	529030	Ref. No.	645
description	coffee filter ø 65mm mounting ø 55mm H 27.5mm cups 2 amount of coffee 14g		

blind filters



1			
Part No.	529064	Ref. No.	647
description	blind filter ø 65mm mounting ø 55mm H 25mm		

filter holder springs



1			
Part No.	529065	Ref. No.	649 7051
description	filter holder spring L 70mm W 60mm wire gauge ø 1.1mm for espresso filter holder		

brewing units

shower screens

2-piece



1			
Part No.	529090	Ref. No.	2908+2909
description	shower screen ø 51.6/49.1mm H 3.6/2.3mm hole ø 5.5mm 2-piece		

filter holder gaskets

flat

standard



1			
Part No.	528086	Ref. No.	1939
description	filter holder gasket D1 ø 64.5mm D2 ø 52.5mm H 6.3mm Qty 1 pcs		



1			
Part No.	528041	Ref. No.	1968
description	filter holder gasket D1 ø 64.5mm D2 ø 52.5mm H 6.65mm		

brewing units manual

components

levers

accessories



1			
Part No.	525151	Ref. No.	618
description	bolt with ball ø 6mm L 12mm		

magnets



1			
Part No.	525122	Ref. No.	614
description	magnet thread M5 for solenoid valve H 23mm ED ø 49mm ID ø 15mm		



components

nozzles

without thread

			
1			
Part No.	525121	Ref. No.	276
description	nozzle bore \varnothing 0.57mm \varnothing 5mm D1 \varnothing 6.5mm L 10mm		

			
1			
Part No.	528888	Ref. No.	276
description	nozzle bore \varnothing 0.65mm \varnothing 5mm D1 \varnothing 6.5mm L 10mm		

gaskets

			
1			
Part No.	529190	Ref. No.	1631
description	O-ring Viton thickness 2.62mm ID \varnothing 31.42mm Qty 1 pcs		

safety valves

safety valves

1/2"

			
1			
Part No.	525125	Ref. No.	1932
description	safety valve connection 1/2" triggering pressure 1.7bar approval CE 0036 sealed		

3/8"

			
1			
Part No.	529312	Ref. No.	381
description	safety valve connection 3/8" triggering pressure 1.8bar		

expansion valves

with hose connection

			
1			
Part No.	525123	Ref. No.	288
description	expansion valve T1: 1/4" ET hose \varnothing 6.5mm total length 78mm		

			
1			
Part No.	525124	Ref. No.	1626
description	expansion valve T1: 1/4" ET hose \varnothing 9mm total length 78mm		

compression springs

			
1			
Part No.	525118	Ref. No.	292
description	compression spring \varnothing 14.3mm L 30.5mm wire gauge \varnothing 2mm		

drain pans

			
1			
Part No.	525157	Ref. No.	1590
description	drain pan L 100mm W 72mm H 75mm hose \varnothing 10/16mm hose length 20/25mm		

aerators and air bleeders

			
1			
Part No.	527981	Ref. No.	508
description	aerator and air bleeder connection 1/4"		

steam/water taps

			
1			
Part No.	525126	Ref. No.	217
description	steam/water tap inlet 1/4" outlet 3/8" shaft 5x7 shaft L 6mm brass		

1 mechanical components, equipment accessories



			
1			
Part No.	529610	Ref. No.	216
description	steam/water tap inlet 3/8" outlet 3/8" shaft 5x7 shaft L 6mm brass		

steam taps
miscellaneous

			
1			
Part No.	525154	Ref. No.	233
description	disc ø 8mm thickness 1mm		

steam/water pipes
steam pipes

			
1			
Part No.	529613	Ref. No.	1838
description	steam pipe mounting pos. left		

			
1			
Part No.	525133	Ref. No.	7546
description	steam pipe mounting pos. left thread 3/8" H 160mm tube ø 8mm chrome-plated brass		

			
1			
Part No.	525132	Ref. No.	4832
description	steam pipe mounting pos. left thread 3/8" H 180mm tube ø 8mm chrome-plated brass		

			
1			
Part No.	525116	Ref. No.	1838
description	steam pipe mounting pos. left thread 3/8" H 210mm tube ø 8mm chrome-plated brass		

			
1			
Part No.	525131	Ref. No.	4831
description	steam pipe mounting pos. right thread 3/8" H 180mm tube ø 8mm chrome-plated brass		

			
1			
Part No.	525117	Ref. No.	1839
description	steam pipe mounting pos. right thread 3/8" H 210mm tube ø 8mm chrome-plated brass		

			
1			
Part No.	529612	Ref. No.	1839
description	steam pipe mounting pos. right thread 3/8" H 210mm tube ø 8mm chrome-plated brass		

			
1			
Part No.	525159	Ref. No.	7832
description	steam pipe thread 3/8" H 160mm tube ø 10mm SS		

			
1			
Part No.	525158	Ref. No.	6591
description	steam pipe thread 3/8" H 170mm tube ø 10mm SS		

			
1			
Part No.	525130	Ref. No.	4473
description	steam pipe thread 3/8" H 180mm tube ø 10mm SS		

1

Part No.	525129	Ref. No.	825
description	steam pipe thread 3/8" H 210mm tube ø 8mm chrome-plated brass		

water pipes



1

Part No.	525128	Ref. No.	2686
description	water pipe thread 3/8" ø 25mm L 87mm tube ø 12mm WS 20 chrome-plated brass		

accessories

bushes



1

Part No.	529705	Ref. No.	7579
description	bush D1 ø 8.3mm D2 ø 12mm H 6mm brass ID ø 7mm		

gaskets



1

Part No.	528402	Ref. No.	807
description	O-ring Viton thickness 2.62mm ID ø 10.78mm Qty 1 pcs		

springs



1

Part No.	525162	Ref. No.	5327
description	compression spring ø 11.5mm L 19mm wire gauge ø 1.7mm stainless steel		



1

Part No.	529704	Ref. No.	7568
description	compression spring ø 11.8mm L 16mm wire gauge ø 1.6mm steel		

miscellaneous



1

Part No.	528898	Ref. No.	523
description	plain washer ID ø 11.2mm ED ø 14.8mm thickness 1mm SS		

union nuts



1

Part No.	528899	Ref. No.	524
description	union nut thread 3/8" L 22mm hole ø 12mm brass		

fine filters

fine filters



1

Part No.	525161	Ref. No.	2284
description	fine filter flat fabric ø 8mm H 1.5mm		



1

Part No.	528889	Ref. No.	275
description	fine filter flat with rim ø 7mm		

intake valves

accessories

levers



1

Part No.	111343	Ref. No.	1837
description	lever thread M8 ø 18/22mm plastic		



level glasses

level glasses

gaskets



Part No.	529427	Ref. No.	266
description	gasket D1 ø 13mm D2 ø 17.5mm ID ø 11mm H 9mm rubber water level glass suitable for PAVONI		



Part No.	525164	Ref. No.	265
description	gasket D1 ø 14mm D2 ø 17mm ID ø 10.78mm H 9mm silicone		



Part No.	525163	Ref. No.	266
description	gasket D1 ø 14mm D2 ø 17mm ID ø 10.8mm H 9mm Viton		

level glass pipes



Part No.	529404	Ref. No.	267 268
description	water level tube ø 11mm H 150mm ID ø 8mm		



Part No.	529405	Ref. No.	267 268
description	water level tube ø 11mm H 150mm ID ø 8mm		

non-return valves

gaskets



Part No.	528425	Ref. No.	290
description	gasket D1 ø 14.9mm D2 ø 6mm total length 8.9mm L1 4mm L2 4.9mm		

compression springs



Part No.	525119	Ref. No.	279
description	compression spring ø 8mm L 28mm wire gauge ø 0.4mm		

pistons



Part No.	528886	Ref. No.	280
description	valve triangular ø 12mm L 22mm		

for coffee grinders

grinding burrs

grinding burrs conical



Part No.	527705	Ref. No.	8785 C0004M122B
description	grinding burrs pair turn direction right D1 ø 63mm D2 ø 40mm H 23.5mm shaft ø 13mm		

knobs

steam/water taps

steam/water taps



Part No.	525134	Ref. No.	249
description	turning handle ø 33mm shaft ø 6.5x8mm black		





			
1			
Part No.	525136	Ref. No.	1558
description	turning handle ø 46mm shaft ø 6.5x8mm black		

			
1			
Part No.	525137	Ref. No.	4963
description	turning handle ø 47mm shaft ø 6.5x8mm black		

			
1			
Part No.	525135	Ref. No.	6037
description	turning handle steam ø 52mm black		

knob dial plates

			
1			
Part No.	525141	Ref. No.	6039
description	clamping ring for handle ø 22.4mm L 11mm black		

			
1			
Part No.	525140	Ref. No.	5124
description	ring for tap ø 38mm L 13mm black		

			
1			
Part No.	525138	Ref. No.	4959
description	sleeve ø 53mm L 25mm black		

			
1			
Part No.	525144	Ref. No.	3063
description	symbol level ø 40mm L 16.5mm		

			
1			
Part No.	525115	Ref. No.	244
description	symbol steam ø 19mm		

			
1			
Part No.	525142	Ref. No.	3061
description	symbol steam ø 40mm L 16.5mm black/gold		

			
1			
Part No.	525145	Ref. No.	4960
description	symbol steam ø 47mm L 26.5mm black/gold		

			
1			
Part No.	525143	Ref. No.	3062
description	symbol water ø 40mm L 16.5mm		

handles and hand wheels

cylindrical handles

fixed

			
1			
Part No.	525160	Ref. No.	4916
description	cylindrical handle thread M6 bore ø conical 12mm ø 18mm L 40mm thermoplastic		

levers

with handle

			
1			
Part No.	111343	Ref. No.	1837
description	lever thread M8 ø 18/22mm plastic		

lever handles

			
1			
Part No.	525160	Ref. No.	4916
description	cylindrical handle thread M6 bore ø conical 12mm ø 18mm L 40mm thermoplastic		



gaskets

O-rings

EPDM



Part No. 529545 **Ref. No.** 5328

description O-ring EPDM thickness 1.78mm ID ø 10.82mm Qty 1 pcs

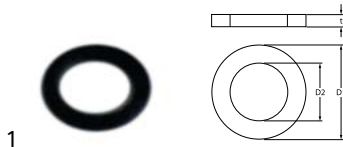

Part No. 528485 **Ref. No.** 586

description O-ring EPDM thickness 1.78mm ID ø 6.07mm Qty 1 pcs

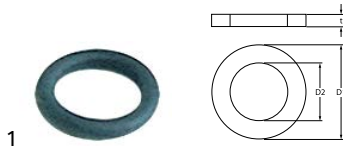

Part No. 529412 **Ref. No.** 1472

description O-ring EPDM thickness 2.62mm ID ø 10.78mm Qty 1 pcs



Part No. 525608 **Ref. No.** 7580

description O-ring EPDM thickness 2.7mm ID ø 12.1mm

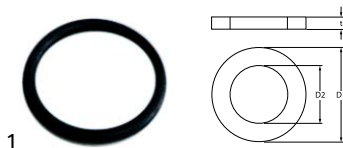

Part No. 361080 **Ref. No.** 08289

description O-ring EPDM thickness 2mm ID ø 16mm Qty 1 pcs



Part No. 361085 **Ref. No.** 281

description O-ring EPDM thickness 2mm ID ø 8mm Qty 1 pcs

silicone

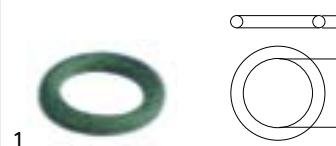

Part No. 528222 **Ref. No.** 1470

description O-ring silicone thickness 2.62mm ID ø 10.78mm Qty 1 pcs

Viton

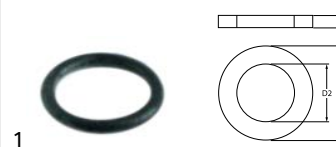

Part No. 528833 **Ref. No.** 1470

description O-ring Viton thickness 1.78mm ID ø 11.11mm Qty 1 pcs



Part No. 528687 **Ref. No.** 219

description O-ring Viton thickness 1.78mm ID ø 3.69mm Qty 1 pcs

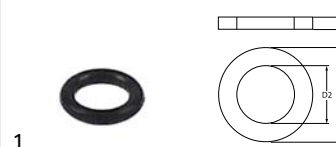

Part No. 371095 **Ref. No.** 625

description O-ring Viton thickness 1.78mm ID ø 6.07mm Qty 1 pcs



Part No. 528282 **Ref. No.** 281

description O-ring Viton thickness 1.78mm ID ø 7.66mm Qty 1 pcs



Part No. 528246 **Ref. No.** 1469

description O-ring Viton thickness 1.78mm ID ø 8.73mm Qty 1 pcs

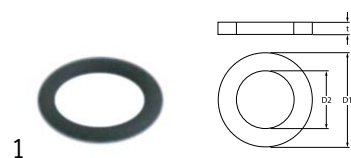
Part No.	528402	Ref. No.	807
description	O-ring Viton thickness 2.62mm ID ø 10.78mm Qty 1 pcs		

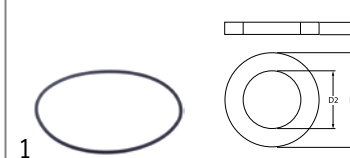

Part No.	525147	Ref. No.	4553
description	O-ring Viton thickness 3.53mm ID ø 142.5mm Qty 1 pcs		

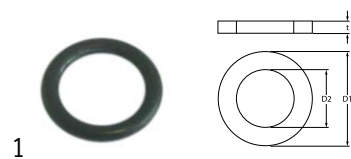

Part No.	528291	Ref. No.	1472
description	O-ring Viton thickness 2.62mm ID ø 11.91mm Qty 1 pcs		

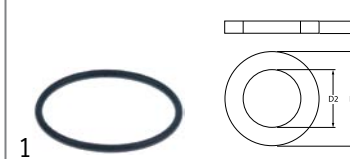

Part No.	510243	Ref. No.	02418
description	O-ring Viton thickness 3.53mm ID ø 55.56mm Qty 1 pcs		

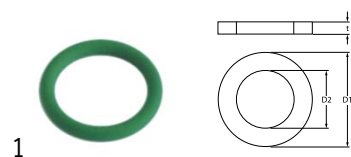

Part No.	528647	Ref. No.	1468
description	O-ring Viton thickness 2.62mm ID ø 15.08mm Qty 1 pcs		

miscellaneous



Part No.	525608	Ref. No.	7580
description	O-ring EPDM thickness 2.7mm ID ø 12.1mm		

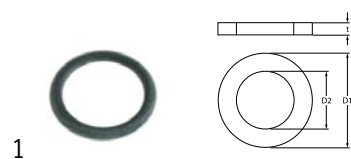

Part No.	528293	Ref. No.	1471
description	O-ring Viton thickness 2.62mm ID ø 15.88mm Qty 1 pcs		

sealing washers

fibre gaskets

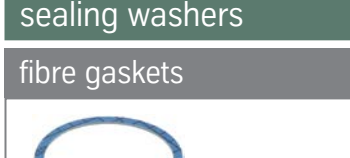

Part No.	525149	Ref. No.	899
description	flat gasket fibre ED ø 93mm ID ø 81mm thickness 2mm for boiler Qty 1 pcs		

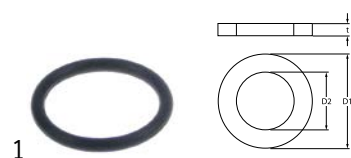

Part No.	532560	Ref. No.	225
description	O-ring Viton thickness 2.62mm ID ø 20.63mm Qty 1 pcs		

graphite gaskets



Part No.	528016	Ref. No.	N/A
description	flat gasket graphite ED ø 62mm ID ø 50mm thickness 2mm Qty 1 pcs		

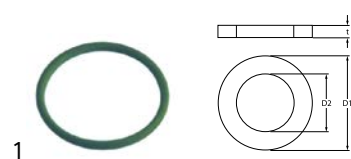

Part No.	529190	Ref. No.	1631
description	O-ring Viton thickness 2.62mm ID ø 31.42mm Qty 1 pcs		

PTFE gaskets



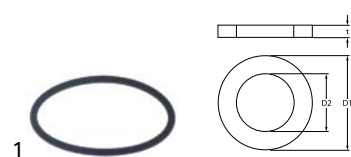

Part No.	528885	Ref. No.	424
description	flat gasket PTFE ED ø 26mm ID ø 17mm thickness 2mm Qty 1 pcs suitable for SPAZIALE		



Part No.	525146	Ref. No.	7418
description	O-ring Viton thickness 2.62mm ID ø 42.52mm Qty 1 pcs		



			
1			
Part No.	528683	Ref. No.	225
description	flat gasket PTFE ED ø 26mm ID ø 21mm thickness 2mm Qty 1 pcs suitable for GAGGIA, SPAZIALE		

			
1			
Part No.	528131	Ref. No.	405
description	flat gasket PTFE ED ø 52mm ID ø 40mm thickness 2mm Qty 1 pcs		

			
1			
Part No.	528149	Ref. No.	405
description	flat gasket PTFE ED ø 85mm ID ø 72mm thickness 2mm Qty 1 pcs suitable for SPAZIALE		

Viton gaskets

			
1			
Part No.	528686	Ref. No.	00221
description	gasket Viton ED ø 15mm ID ø 6mm thickness 3.5mm Qty 1 pcs		

special gaskets

group gaskets

			
1			
Part No.	528147	Ref. No.	N/A
description	group gasket		

			
1			
Part No.	525148	Ref. No.	485
description	gasket ED ø 34mm ID ø 18mm H 6.3mm		

springs

compression springs

			
1			
Part No.	525162	Ref. No.	5327
description	compression spring ø 11.5mm L 19mm wire gauge ø 1.7mm stainless steel		

			
1			
Part No.	529704	Ref. No.	7568
description	compression spring ø 11.8mm L 16mm wire gauge ø 1.6mm steel		

			
1			
Part No.	525118	Ref. No.	292
description	compression spring ø 14.3mm L 30.5mm wire gauge ø 2mm		

			
1			
Part No.	525120	Ref. No.	223
description	compression spring ø 14.4mm L 26mm wire gauge ø 1.8mm		

			
1			
Part No.	528684	Ref. No.	223
description	compression spring ø 14.5mm L 33mm wire gauge ø 2.1mm		

			
1			
Part No.	528475	Ref. No.	292
description	compression spring ø 14.7mm L 33mm wire gauge ø 2mm		



			
1			
Part No.	528257	Ref. No.	522
description	compression spring ø 15mm L 17mm wire gauge ø 1.8mm		

			
1			
Part No.	528894	Ref. No.	1624
description	compression spring ø 21.7mm L 40mm wire gauge ø 1.3mm		

			
1			
Part No.	528887	Ref. No.	1625
description	compression spring ø 6.5mm L 13mm wire gauge ø 0.9mm		

			
1			
Part No.	525119	Ref. No.	279
description	compression spring ø 8mm L 28mm wire gauge ø 0.4mm		

			
1			
Part No.	528392	Ref. No.	279
description	compression spring ø 8mm L 29mm wire gauge ø 0.5mm		

manometers

			
1			
Part No.	541735	Ref. No.	1481
description	manometer double scale ø 58mm pressure range 0-2.5 / 0-15bar connection on the backside thread 1/8"		

			
1			
Part No.	541737	Ref. No.	5044
description	manometer double scale ø 58mm pressure range 0-2.5 / 0-15bar connection on the backside thread 1/8"		

			
1			
Part No.	541233	Ref. No.	N/A
description	manometer double scale ø 60mm pressure range 0-2.5 / 0-15bar connection on the backside thread 1/8"		

			
1			
Part No.	541287	Ref. No.	N/A
description	manometer double scale ø 60mm pressure range 0-2.5 / 0-15bar connection on the backside thread 1/8"		

			
1			
Part No.	541410	Ref. No.	N/A
description	manometer double scale ø 60mm pressure range 0-2.5 / 0-15bar connection on the backside thread 1/8"		

			
1			
Part No.	541222	Ref. No.	N/A
description	manometer double scale ø 60mm pressure range 0-2.5 / 0-16bar connection on the backside thread 1/8"		

			
1			
Part No.	541226	Ref. No.	N/A
description	manometer double scale ø 60mm pressure range 0-2.5 / 0-16bar connection on the backside thread 1/8"		

			
1			
Part No.	541227	Ref. No.	N/A
description	manometer double scale ø 60mm pressure range 0-2.5 / 0-16bar connection on the backside thread 1/8"		

1

Part No.	541224	Ref. No.	N/A
description	manometer double scale ø 63mm pressure range 0-2.5 / 0-15bar connection on the backside thread 1/8"		



1

Part No.	541740	Ref. No.	6738
description	manometer ø 42mm pressure range 0-16bar thread 1/8" connection on the backside		



1

Part No.	541739	Ref. No.	6237
description	manometer ø 42mm pressure range 0-2.5bar thread 1/8" connection on the backside		



1

Part No.	541741	Ref. No.	6737
description	manometer ø 43mm pressure range 0-2.5bar thread 1/8" connection on the backside		



1

Part No.	541738	Ref. No.	2047
description	manometer ø 58mm pressure range 0-2.5bar connection on the backside marking 1.35-2.5 thread 1/4"		

fastening material

screws

hexagonal screws



1

Part No.	560274	Ref. No.	643
description	hexagonal screw thread M5 thread L 25mm SS WS 8 without pole Qty 20 pcs DIN 933 / ISO 4017		

cylinder head bolts

DIN 912/ISO 4762



1

Part No.	560025	Ref. No.	669
description	cylinder head bolt thread M4 thread L 10mm WS 3 SS Qty 20 pcs DIN 912/ISO 4762		

nuts

wing nuts



1

Part No.	560147	Ref. No.	4939
description	wing nuts thread M6 SS DIN/ISO DIN 315 Qty 20 pcs		

hexagonal nuts

hexagonal nuts inch thread



1

Part No.	503045	Ref. No.	07063
description	nut thread 1/4" H 4.5mm brass WS 17 Qty 1 pcs		

washers

washers

DIN 125A





1

Part No.	560113	Ref. No.	1746 624
description	plain washer ID ø 6.4mm ED ø 12mm thickness 1.6mm SS Qty 20 pcs DIN 125A for thread M6		



miscellaneous			
			
1			
Part No.	528898	Ref. No.	523
description	plain washer ID \varnothing 11.2mm ED \varnothing 14.8mm thickness 1mm SS		



			
1			
Part No.	560413	Ref. No.	241
description	plain washer ID \varnothing 17mm ED \varnothing 25mm thickness 0.8mm SS		

			
1			
Part No.	560412	Ref. No.	1131
description	plain washer ID \varnothing 5mm ED \varnothing 8mm thickness 1mm brass		

fasteners

retaining rings

DIN 472			
			
1			
Part No.	525153	Ref. No.	487
description	retaining ring bore \varnothing 32mm thickness 1.1mm DIN 472		

DIN 6799			
 			
1			
Part No.	518557	Ref. No.	634
description	retaining ring E D1 \varnothing 5mm D2 \varnothing 11mm SS DIN 6799 thickness 0.7mm		

consumables

fuses

fine fuses

			
1			
Part No.	358605	Ref. No.	6249
description	fine fuse size \varnothing 5x20mm 3.15A slow-acting rated 250V Qty 10 pcs		

GASTROPARTS.COM

