



GASTROPARTS

La-Scala

- [EN]** Equipment
- [DE]** Geräte
- [ES]** Aparatos
- [FR]** Équipement
- [IT]** Attrezzature
- [PL]** Urządzenia
- [RU]** Оборудование

✉ gastroparts@gastroparts.com

☎ +48 56 657 00 66

📘 fb.com/gastroparts.global

GASTROPARTS.COM







heating elements

heating elements for coffee machine

			
1			
Part No.	417241	Ref. No.	C-0353
description	heating element 2200W 230V heating circuits 3 mounting \varnothing 40mm hole distance 58mm L 140mm W 32mm H 60mm L1 45mm L2 60mm L3 40mm H1 34mm H2 26mm hole \varnothing 10mm tube \varnothing 8mm thermostat sleeves \varnothing 4.5mm length thermostat sleeves 126mm thermostat sleeve eccentric, non clinging number of thermostat sleeves 1 connection M3 immersion heater 3 hole flange		

			
1			
Part No.	417360	Ref. No.	C-0527
description	heating element 2500W 230V heating circuits 3 mounting \varnothing 40mm hole distance 58mm L 180mm W 32mm H 60mm L1 45mm L2 60mm L3 75mm H1 34mm H2 26mm hole \varnothing 10mm tube \varnothing 8mm thermostat sleeves \varnothing 4.5mm length thermostat sleeves 130mm thermostat sleeve eccentric, non clinging number of thermostat sleeves 1 connection M3 immersion heater 3 hole flange		

			
1			
Part No.	417242	Ref. No.	C-0356
description	heating element 3500W 230V heating circuits 3 mounting \varnothing 39mm hole distance 58mm L 340mm W 35mm H 58mm L1 46mm L2 64mm L3 230mm H1 33mm H2 25mm windings 3 hole \varnothing 10mm tube \varnothing 8mm thermostat sleeves \varnothing 5mm length thermostat sleeves 144mm thermostat sleeve eccentric, non clinging number of thermostat sleeves 1 connection M3 immersion heater 3 hole flange		

			
1			
Part No.	417243	Ref. No.	C-0358
description	heating element 4500W 230V heating circuits 3 mounting \varnothing 39mm hole distance 58mm L 550mm W 34mm H 60mm L1 50mm L2 50mm L3 450mm H1 35mm H2 25mm windings 3 hole \varnothing 10mm tube \varnothing 8mm thermostat sleeves \varnothing 5mm length thermostat sleeves 142mm thermostat sleeve eccentric, non clinging number of thermostat sleeves 1 connection M3 immersion heater 2 hole flange		

accessories

flange gaskets

			
1			
Part No.	528740	Ref. No.	C-0361
description	gasket ID \varnothing 44mm PTFE thickness 3.5mm hole \varnothing 9.5mm hole distance 58mm suitable for ITALCREM, VISACREM for heating element coffee machine parts		

thermostats



control and safety thermostats

EGO			
safety thermostats			
55.32_ series			
			
1			
Part No.	375502	Ref. No.	C-0457
description	safety thermostat switch-off temp. 177°C 3-pole 20A probe \varnothing 4mm probe L 130mm capillary pipe 1500mm capillary pipe isolated 420mm gland nut starting temperature 159°C probe		

switches and momentary switches

rocker/momentary rocker switches

30x22mm			
			
1			
Part No.	347813	Ref. No.	C-0474
description	rocker switch mounting measurements 30x22mm orange 2CO 250V 16A illuminated connection male faston 6.3mm ambient temperature max. 125/55°C protection IP40		

				
1				
Part No.	301188	Ref. No.	C-0479	
description	rocker switch mounting measurements 30x22mm black 2NO/2NO 250V 16A I O II connection male faston 6.3mm ambient temperature max. 125/55°C protection IP40			
accessories for	301188			
	Part No.	301036	Ref. No.	—
		protective cover internal size 30x22mm for rocker switch mounting measurementsmm		

			
1			
Part No.	346110	Ref. No.	C-0418
description	rocker switch mounting measurements 30x22mm red 2NO 250V 16A illuminated coffee connection male faston 6.3mm ambient temperature max. 125/55°C protection IP40		



accessories

blank elements



1

Part No.	347281	Ref. No.	C-0470
-----------------	--------	-----------------	--------

description	blank external size 30x30mm black		
--------------------	-----------------------------------	--	--

microswitches

pin-plunger actuated

M12



1

Part No.	345350	Ref. No.	C-0465
-----------------	--------	-----------------	--------

description	microswitch with plunger mounting distance 22mm thread M12x0.75 thread L 16mm 250V 16A 1CO connection male faston 6.3mm stroke 4mm ambient temperature max. 125°C type EF83161.3 actuating force: 66g		
--------------------	---	--	--

accessories for	345350		
------------------------	--------	--	--



Part No.	345351	Ref. No.	—
-----------------	--------	-----------------	---

description	nut thread M12x0.75 H 1.6mm WS 14 chrome-plated brass Qty 1 pcs		
--------------------	---	--	--

system switches (ROLD)

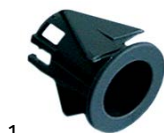

1

Part No.	345536	Ref. No.	C-0486
-----------------	--------	-----------------	--------

description	element holder mounting ø 16mm flat black		
--------------------	---	--	--



1

Part No.	345538	Ref. No.	C-0481
-----------------	--------	-----------------	--------

description	push button ø 11.9mm black		
--------------------	----------------------------	--	--



1

Part No.	345720	Ref. No.	C-0485
-----------------	--------	-----------------	--------

description	switch 2NO 250V 16A connection male faston 6.3mm		
--------------------	--	--	--

key lock switches



1

Part No.	400297	Ref. No.	C-0135
-----------------	--------	-----------------	--------

description	key lock switch 1 group thread M12x1 1NO mounting ø 12mm cable length 300mm		
--------------------	---	--	--

rotary switches

BREMAS

A3200 series



1

Part No.	345114	Ref. No.	C-0121
-----------------	--------	-----------------	--------

description	rotary switch 3 1-0-2 sets of contacts 5 type CS0325832 600V 32A shaft ø 5x5mm shaft L 23mm shaft square connection screw		
--------------------	---	--	--

A4000 series



1

Part No.	347712	Ref. No.	— C-0154
-----------------	--------	-----------------	-------------

description	rotary switch 3 1-0-2 sets of contacts 5 690V 40A shaft ø 5x5mm shaft L 21mm shaft square with knob connection screw		
--------------------	--	--	--

accessories



1

Part No.	527259	Ref. No.	C-0130
-----------------	--------	-----------------	--------

description	knob push-in ø 34/60mm shaft ø 5x5mm black H 21.4mm L 49mm		
--------------------	--	--	--

lamps

indicator lights

indicator light lenses

ø10mm (type SRZ-3)



1

Part No.	359123	Ref. No.	C-0254
-----------------	--------	-----------------	--------

description	indicator light housings mounting measurements ø10mm green round Qty 1 pcs		
--------------------	--	--	--

accessories for	359123		
------------------------	--------	--	--





Part No.	359132	Ref. No.	C-0262
-----------------	--------	-----------------	--------

description	indicator lamp green 250V connection male faston 6.3mm protection IP54 ambient temperature max. 85°C		
--------------------	--	--	--



			
1			
Part No.	359125	Ref. No.	C-0253
description	indicator light housings mounting measurements ø10mm red round Qty 1 pcs		

indicator lamps for socket type SRZ / SDK / SDY / SFK			
			
1			
Part No.	359130	Ref. No.	C-0263
description	indicator lamp 230V clear connection male faston 6.3mm ø 8mm		

			
1			
Part No.	359132	Ref. No.	C-0262
description	indicator lamp green 250V connection male faston 6.3mm protection IP54 ambient temperature max. 85°C		

relays

level relays

GICAR			
			
1			
Part No.	402103	Ref. No.	C-0069
description	level controller 230/240V voltage AC 50/60Hz connection F6.3 type NRL30/1E-2C/F		

electronics

PCBs

			
1			
Part No.	402422	Ref. No.	C-0133
description	display L 117mm W 42mm		

central units

			
1			
Part No.	402501	Ref. No.	C-0147
description	central unit 240V 50/60Hz type DOS RL2 3GR+3THE+RL/ON-OFF/C voltage AC		

			
1			
Part No.	402500	Ref. No.	C-0148
description	central unit 240V 50/60Hz type DOS RL2 3GR+RL+THE/C voltage AC		

dosing electronics

GICAR			
			
1			
Part No.	401066	Ref. No.	C-0015/24N
description	level relay 230V voltage AC 50/60Hz connection F6.3 type Dosatura Manuale DELUXE F		



keypads

front foils



1

Part No.	526422	Ref. No.	C-0141
description	keypad foil black/silver L 75mm W 70mm buttons 2		



1

Part No.	526423	Ref. No.	C-0140
description	keypad foil black/silver L 75mm W 70mm buttons 8		

keypad units



1

Part No.	402722	Ref. No.	C-0603
description	keypad unit coffee machine BUTTERFLY/MARINA buttons 5 black/white/silver type 1d5e GRCZ NKP S10 „Tank Probe“ 230V		



1

Part No.	402502	Ref. No.	C-0462
description	keypad unit coffee machine CARMEN buttons 2 black/silver L 88mm W 83mm		



1

Part No.	402503	Ref. No.	C-0461
description	keypad unit coffee machine CARMEN buttons 8 black/silver L 88mm W 83mm		



1

Part No.	531188	Ref. No.	C-0586 C-0602
description	keypad unit coffee machine parts buttons 5 black type 9.9.07.03G L 116mm W 44mm		

solenoid valves

solenoid valves (water)

metal

ODE

solenoid valves steam (water)

21A series



1

Part No.	370703	Ref. No.	C-0207
description	solenoid valve brass 2-ways 230VAC inlet 1/4" IT outlet 1/4" IT connection 1/4" L 40mm DN 2.5mm t.max. 140°C -10 up to 140°C ODE type series 21A coil type BDA membranes FKM (water/steam) p max 14bar p min 0bar 50/60Hz		

21A1 series



1

Part No.	370093	Ref. No.	C-0403	
description	solenoid valve 2/2-ways 230VAC body 25-F39 DN 2.5mm slide-on receptacle DIN -10 up to 140°C ODE type series 21A1 coil type BDA membranes FKM p max 14bar 50/60Hz silicone flange 32x32mm			
spare parts for	370093			
	Part No.	371150	Ref. No.	—
	solenoid coil ODE 230VAC 16VA coil type BDV seat ø 13.5mm 7500hm			
accessories for	370093			
	Part No.	371090	Ref. No.	—
	power socket plug type DIN 43650A screw			



21J series



1

Part No.	370232	Ref. No.	C-0302
description	solenoid valve brass 2-ways 230VAC connection 1/8" L 30mm DN 2.3mm -10 up to 140°C membranes FKM p max 18bar		

pressure switches

for coffee machines

ø 38mm



1

Part No.	541158	Ref. No.	C-0522
description	pressure control ø 38mm pressure range 1-2.5bar pressure connection vertical 16A 250V coffee machine parts connection 1/4" pressure connection 1/4"		

electrodes



1

Part No.	400790	Ref. No.	C-0351
description	level electrode 1/4" total length 125mm probe L 98mm insulated probe length 26mm connection male faston 6.3mm stainless steel ø 3mm rubber		

flow meters and flow sensors

flow meters

GICAR



1

Part No.	530368	Ref. No.	C-0215B
description	flow meter thread 1/4" IT nickel-plated brass approval NSF		

pumps

booster pumps II

pump heads

FLUID-O-TECH



1

Part No.	500064	Ref. No.	C-0521
description	pump head PO204 FLUID-O-TECH L 82mm 200l/h connection 3/8" GAS with bypass brass clip connection for coffee machine shaft ø 4.8x11mm		
accessories for	500064		
	Part No.	520126	Ref. No.
			—
	clamp for pump/motor		

electric accessories

cables

ribbon cables

group 3



1

Part No.	402429	Ref. No.	C-0134
description	ribbon cable 4-pole L 1000mm plug type 1-row plug; number of poles 4/6 Qty 1m		

equipment-specific units

for espresso machines

filter holders

filter holders standard

filter holders (complete)



1

Part No.	526453	Ref. No.	C-0532N
description	filter holder double complete ID ø 61.7mm outlet distance 47.6mm mounting ø 82.6		



filter holders short



1

Part No.	529058	Ref. No.	N/A
description	filter holder mounting \varnothing 83mm outlet 3/8" ID \varnothing 61.5mm handle M12x1.75 wedge height 10mm wedge position horizontal number of wedges 2 lever inclined chrome-plated, polished		

filters

for 1 cup



1

Part No.	526479	Ref. No.	C-0499
description	coffee filter \varnothing 69.5mm mounting \varnothing 60mm H 24mm cups 1 amount of coffee 7g perforation \varnothing 0.3mm		



1

Part No.	526261	Ref. No.	C-0498
description	coffee filter \varnothing 70mm mounting \varnothing 60.5mm H 20.5mm cups 1 amount of coffee 6.5g		

for 2 cups



1

Part No.	529014	Ref. No.	C-0500
description	coffee filter \varnothing 70mm mounting \varnothing 60mm H 21mm cups 2 amount of coffee 12g perforation \varnothing 0.3mm round		



1

Part No.	529197	Ref. No.	C-0501
description	coffee filter \varnothing 70mm mounting \varnothing 60mm H 24.5mm cups 2 amount of coffee 14g		

blind filters



1

Part No.	529023	Ref. No.	C-0495
description	blind filter \varnothing 70mm mounting \varnothing 60mm H 18mm		

brewing units

shower screens

with upstand



1

Part No.	529080	Ref. No.	C-0322
description	shower screen \varnothing 58mm H 20mm		

filter holder gaskets

flat

standard



1

Part No.	526445	Ref. No.	C-0321
description	filter holder gasket D1 \varnothing 73mm D2 \varnothing 57mm H 8mm Qty 1 pcs		

components

drain units

drain valves



1

Part No.	526438	Ref. No.	C-0308
description	drain fitting \varnothing 24.5mm L 54mm brass D1 \varnothing 7.5mm D2 \varnothing 20mm		





nozzles			
with thread			
 <p>1</p>			
Part No.	526441	Ref. No.	C-0314
description	nozzle bore \varnothing 0.5mm thread M6x0.75 L 9mm		

springs			
 <p>1</p>			
Part No.	526442	Ref. No.	C-0311
description	compression spring \varnothing 10.8mm L 57.2mm wire gauge \varnothing 1mm		



gaskets			
 <p>1</p>			
Part No.	526429	Ref. No.	C-0301
description	gasket L 76mm fibre H 2mm W 70mm		

water dispersions			
water dispersions			
group 2			
 <p>1</p>			
Part No.	529081	Ref. No.	C-0318
description	water distributor \varnothing 30mm hole \varnothing 1.5mm H 15mm ET M10x1 grooves 6 2.5mm brass		

expansion valves			
with hose connection			
 <p>1</p>			
Part No.	526452	Ref. No.	C-0379
description	expansion valve T1: 1/4" ET hose \varnothing 9.5mm BL 42mm		

drain pans			
drain pans			
 <p>1</p>			
Part No.	526440	Ref. No.	C-0011
description	drain pan L 102mm W 70mm H 48mm hose \varnothing 8mm		

boilers			
heat exchangers			
injector tubes			
 <p>1</p>			
Part No.	527952	Ref. No.	R4
description	injector pipe tube \varnothing 8mm pipe length 140mm T1: 1/4" T2: 1/4"		

steam/water taps			
steam/water taps			
steam/water taps			
 <p>1</p>			
Part No.	526074	Ref. No.	C-0271
description	steam/water tap inlet 1/4" outlet 3/8" brass		
accessories for	526074		
	Part No.	111318	Ref. No. C-0280
	Part No.	361184	Ref. No. —
			nut thread 1/2" H 6mm nickel-plated brass WS 24 Qty 1 pcs



components

gaskets



1

Part No.	527961	Ref. No.	C-0430
description	flat gasket copper ED \varnothing 21mm ID \varnothing 17.2mm thickness 1.5mm		

springs



1

Part No.	526443	Ref. No.	C-0273
description	compression spring \varnothing 12mm L 15.5mm wire gauge \varnothing 1.5mm		

washers



1

Part No.	526436	Ref. No.	C-0270
description	plain washer D1 \varnothing 14mm D2 \varnothing 7.1mm thickness 0.5mm brass		

steam/water pipes

steam pipes



1

Part No.	526432	Ref. No.	C-0278
description	steam pipe thread 1/2" H 160mm \varnothing 14.5mm tube \varnothing 10mm		

nozzles for water pipes

tap aerators



1

Part No.	526424	Ref. No.	C-0467
description	tap aerator D1 \varnothing 23.5mm H 30mm thread M10x1		

water pipes



1

Part No.	526426	Ref. No.	C-0026
description	water pipe thread 1/2" \varnothing 23.5mm L 45mm WS 7.5		



1

Part No.	526425	Ref. No.	C-0459
description	water pipe thread 1/4" \varnothing 23.5mm L 78mm tube \varnothing 10mm		

accessories

bushes



1

Part No.	526437	Ref. No.	C-0274
description	bush D1 \varnothing 14.3mm D2 \varnothing 11.5mm H 6mm PTFE steam ID \varnothing 7.1mm		

fine filters

fine filters



1

Part No.	529979	Ref. No.	C-0315
description	fine filter \varnothing 8.8mm H 22mm		

intake valves

intake valves



1

Part No.	526451	Ref. No.	C-0414N
description	intake valve brass		

accessories

bushes



1

Part No.	526501	Ref. No.	C-0432
description	bush for lever D1 \varnothing 12mm D2 \varnothing 14.6mm int. \varnothing 1.7mm H 6.7mm brass		

gaskets



1

Part No.	526439	Ref. No.	C-0424
description	gasket ED \varnothing 13mm ID \varnothing 4mm H 4mm for filling valve		



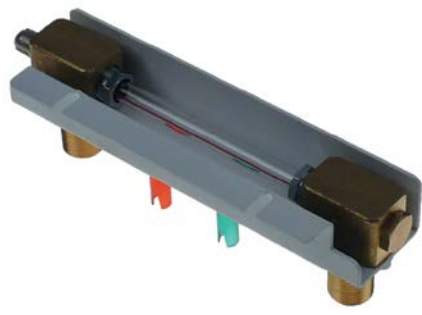

springs			
			
1			
Part No.	526444	Ref. No.	C-0421
description	compression spring ø 12.5mm L 30.5mm wire gauge ø 1.7mm		

level glasses			
level glasses			
pressure rings			
			
1			
Part No.	526434	Ref. No.	C-0258
description	press ring D1 ø 14.7mm D2 ø 11.6mm thickness 3.7mm conical		

level glasses (complete)			
			
1			
Part No.	526428	Ref. No.	C-0261
description	level glass with socket element		

level glass pipes			
			
1			
Part No.	526427	Ref. No.	C-0260
description	water level tube ø 11mm H 155mm ID ø 8mm marking red		

knobs			
steam/water taps			
			
1			
Part No.	111318	Ref. No.	C-0280
description	knob ø 50mm thread Tr18x2 black		

knob dial plates			
			
1			
Part No.	111320	Ref. No.	C-0283
description	knob dial plate steam ø 28mm black		

			
1			
Part No.	111319	Ref. No.	C-0295
description	knob dial plate water ø 28mm black		

accessories			
			
1			
Part No.	111273	Ref. No.	C-0282
description	cotter pin ø 1.3mm L 25mm		

miscellaneous			
			
1			
Part No.	527259	Ref. No.	C-0130
description	knob push-in ø 34/60mm shaft ø 5x5mm black H 21.4mm L 49mm		

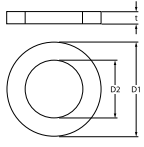
gaskets			
O-rings			
EPDM			
 			
1			
Part No.	504574	Ref. No.	C-0427
description	O-ring EPDM thickness 1.78mm ID ø 9.25mm Qty 1 pcs		

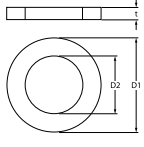
Viton			
 			
1			
Part No.	528833	Ref. No.	C-0289
description	O-ring Viton thickness 1.78mm ID ø 11.11mm Qty 1 pcs		

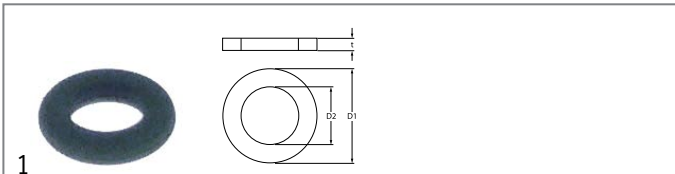
1

Part No.	532571	Ref. No.	C-0425
description	O-ring Viton thickness 1.78mm ID ø 3.85mm Qty 1 pcs		

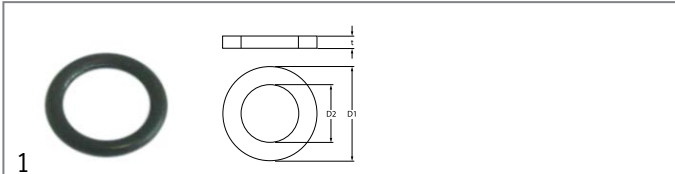

1

Part No.	528291	Ref. No.	C-0257
description	O-ring Viton thickness 2.62mm ID ø 11.91mm Qty 1 pcs		

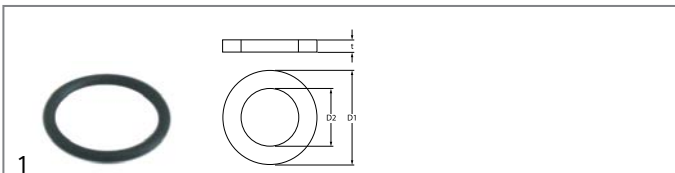

1

Part No.	532504	Ref. No.	C-0309
description	O-ring Viton thickness 2.62mm ID ø 20.24mm Qty 1 pcs		

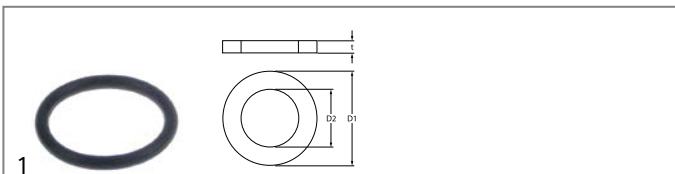

1

Part No.	532560	Ref. No.	C-0324
description	O-ring Viton thickness 2.62mm ID ø 20.63mm Qty 1 pcs		

sealing washers

fibre gaskets

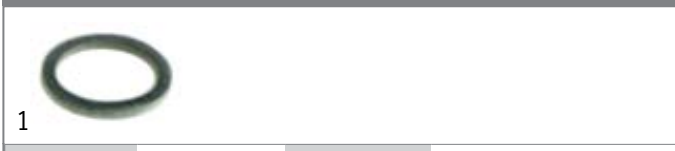

1

Part No.	528210	Ref. No.	C-0272
description	flat gasket FIBER ED ø 21mm ID ø 16.5mm thickness 2mm Qty 1 pcs		

copper gaskets

DIN-7603-A

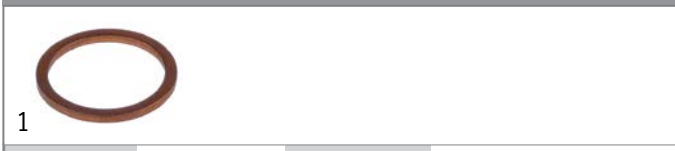

1

Part No.	527961	Ref. No.	C-0430
description	flat gasket copper ED ø 21mm ID ø 17.2mm thickness 1.5mm		



1

Part No.	527994	Ref. No.	C-0419
description	flat gasket copper ED ø 25mm ID ø 19.3mm thickness 1.5mm		

DIN-7603-C



1

Part No.	526433	Ref. No.	C-0256
description	gasket copper ED ø 18mm ID ø 14mm thickness 2mm		

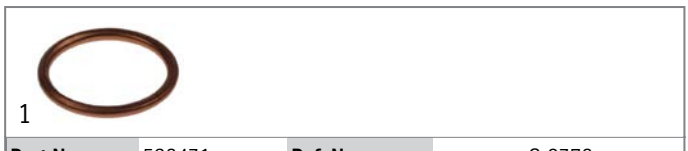

1

Part No.	526431	Ref. No.	C-0376
description	gasket copper ED ø 26mm ID ø 21.5mm thickness 2.2mm for thread 1/2" Qty 1 pcs		

PTFE gaskets



1

Part No.	526679	Ref. No.	C-0426
description	flat gasket PTFE ED ø 18mm ID ø 13mm thickness 2mm Qty 1 pcs		



1

Part No.	526014	Ref. No.	C-0310
description	flat gasket PTFE ED ø 35mm ID ø 30mm thickness 2mm Qty 1 pcs		



1

Part No.	526435	Ref. No.	C-0316
description	gasket PTFE ED ø 22mm ID ø 17mm thickness 2mm Qty 1 pcs		

springs

compression springs



1

Part No.	526444	Ref. No.	C-0421
description	compression spring ø 12.5mm L 30.5mm wire gauge ø 1.7mm		



1

Part No.	526443	Ref. No.	C-0273
description	compression spring ø 12mm L 15.5mm wire gauge ø 1.5mm		



1

Part No.	527992	Ref. No.	C-0429
description	compression spring ø 8mm L 32mm wire gauge ø 0.5mm		

manometers



1

Part No.	541721	Ref. No.	C-0150
description	manometer double scale ø 63mm pressure range 0-2.5 / 0-16bar connection on the backside thread 1/8"		

valves and tank inlets

ball valves

universal

mini ball valves



1

Part No.	520722	Ref. No.	C-0401
description	ball valve connection 1/4" IT - 1/4" ET DN8 total length 39mm chrome-plated brass		

fastening material

screws

hexagonal screws



1

Part No.	560081	Ref. No.	C-0021M
description	hexagonal screw thread M4 thread L 10mm SS WS 7 Qty 20 pcs DIN 933 / ISO 4017		

fasteners

cotter pins



1

Part No.	111273	Ref. No.	C-0282
description	cotter pin ø 1.3mm L 25mm		

GASTROPARTS.COM

