



GASTROPARTS

La San Marco

[EN] Equipment

[DE] Geräte

[ES] Aparatos

[FR] Équipement

[IT] Attrezzature

[PL] Urządzenia

[RU] Оборудование

✉ gastroparts@gastroparts.com

☎ +48 56 657 00 66

📘 fb.com/gastroparts.global









GASTROPARTS.COM







heating elements

heating elements for coffee machine

 <p>1</p>			
Part No.	417026	Ref. No.	N/A
description	heating element 1000W 230V heating circuits 1 L 205mm W 50mm H 18mm L1 30mm L2 35mm L3 140mm mounting distance 28mm thread M10x1 connection M3 tube ø 8.5mm 2 hole fixing immersion heater windings 2		
accessories for	417026		
	Part No.	510416	Ref. No. —
	flat gasket fibre ED ø 19mm ID ø 10.5mm thickness 1.5mm for thread M10 Qty 1 pcs		
	Part No.	510893	Ref. No. —
	O-ring EPDM thickness 2.62mm ID ø 9.92mm Qty 1 pcs		
	Part No.	520231	Ref. No. —
	nut thread M10x1 H 6mm WS 14 zinc-coated steel Qty 1 pcs		
	Part No.	521129	Ref. No. —
	nut thread M10 H 6mm SS WS 17 Qty 1 pcs DIN/ISO DIN 439		
	Part No.	527169	Ref. No. —
	hexagonal nut thread M3 H 2.8mm WS 5.5 brass Qty 1 pcs		
	Part No.	560110	Ref. No. —
	plain washer ID ø 3.2mm ED ø 7mm thickness 0.5mm SS Qty 20 pcs DIN 125A for thread M3		
	Part No.	560130	Ref. No. —
	hexagonal nut thread M3 H 2.4mm WS 5.5 SS DIN/ISO DIN 934 / ISO 4032/8673 Qty 20 pcs		

 <p>1</p>			
Part No.	417027	Ref. No.	N/A
description	heating element 1250W 220V heating circuits 1 L 370mm H 70mm L1 32mm L2 58mm L3 280mm mounting distance 25mm thread M10x1 connection M3x0.6 2 hole fixing immersion heater		

 <p>1</p>			
Part No.	417023	Ref. No.	0794/F 108245
description	heating element 1750W 230V heating circuits 1 mounting ø 46mm hole distance 60mm L 123mm ø 41mm hole ø 11mm connection M3x0.6 immersion heater suitable for SAN MARCO W 41mm H 41mm		

 <p>1</p>			
Part No.	417351	Ref. No.	108245
description	heating element 1750W 230V heating circuits 1 mounting ø 46mm hole distance 60mm L 135mm ø 41mm hole ø 11mm tube ø 8mm connection M3 immersion heater 3 hole flange copper W 41mm H 64mm		

 <p>1</p>			
Part No.	417142	Ref. No.	N/A
description	heating element 1850W 230V heating circuits 1 L 525mm H 62mm L1 40mm L2 45mm L3 440mm mounting distance 25mm thread M10x1 connection M4 connection length 25mm tube ø 8mm 2 hole fixing immersion heater		
accessories for	417142		
	Part No.	510416	Ref. No. —
	flat gasket fibre ED ø 19mm ID ø 10.5mm thickness 1.5mm for thread M10 Qty 1 pcs		
	Part No.	510893	Ref. No. —
	O-ring EPDM thickness 2.62mm ID ø 9.92mm Qty 1 pcs		
	Part No.	520231	Ref. No. —
	nut thread M10x1 H 6mm WS 14 zinc-coated steel Qty 1 pcs		
	Part No.	521129	Ref. No. —
	nut thread M10 H 6mm SS WS 17 Qty 1 pcs DIN/ISO DIN 439		

 <p>1</p>			
Part No.	417185	Ref. No.	108414 108414B 108459
description	heating element 2000W 230V heating circuits 1 mounting ø 40mm L 183mm W 28mm H 38mm hole distance 58mm hole ø 9mm length thermost sleeves 145mm thermostat sleeves ø 5mm number of thermostat sleeves 1 thermostat sleeve lateral, not adjacent windings 3 tube ø 8mm connection 1/8" immersion heater 2 hole flange suitable for SAN MARCO		





 <p>1</p>			
Part No.	417024	Ref. No.	OMM14138
description	heating element 2600W 230V heating circuits 2 mounting ø 46mm hole distance 60mm L 375mm W 30mm H 56mm L1 28mm L2 62mm L3 285mm H1 25mm H2 31mm hole ø 10mm tube ø 8.5mm connection M3 immersion heater 3 hole flange suitable for SAN MARCO		
accessories for	417024		
	Part No.	527169	Ref. No. —
	hexagonal nut thread M3 H 2.8mm WS 5.5 brass Qty 1 pcs		
	Part No.	528010	Ref. No. 803F
	flat gasket PTFE ED ø 56mm ID ø 46.5mm thickness 3mm Qty 1 pcs suitable for SAN MARCO		



Table continues overleaf



accessories for		417024	
	Part No.	560110	Ref. No. —
plain washer ID \varnothing 3.2mm ED \varnothing 7mm thickness 0.5mm SS Qty 20 pcs DIN 125A for thread M3			
	Part No.	560130	Ref. No. —
hexagonal nut thread M3 H 2.4mm WS 5.5 SS DIN/ISO DIN 934 / ISO 4032/8673 Qty 20 pcs			





Part No.	417025	Ref. No.	108143
description	heating element 2600W 230V heating circuits 3 mounting \varnothing 46mm hole distance 62mm L 380mm W 35mm H 58mm L1 30mm L2 60mm L3 290mm H1 32mm H2 28mm hole \varnothing 11mm tube \varnothing 8.5mm thermostat sleeves \varnothing 7mm length thermostat sleeves 208mm thermostat sleeve not clinging number of thermostat sleeves 1 connection M3 immersion heater 3 hole flange suitable for SAN MARCO		

accessories for		417025	
	Part No.	527169	Ref. No. —
hexagonal nut thread M3 H 2.8mm WS 5.5 brass Qty 1 pcs			
	Part No.	560110	Ref. No. —
plain washer ID \varnothing 3.2mm ED \varnothing 7mm thickness 0.5mm SS Qty 20 pcs DIN 125A for thread M3			
	Part No.	560130	Ref. No. —
hexagonal nut thread M3 H 2.4mm WS 5.5 SS DIN/ISO DIN 934 / ISO 4032/8673 Qty 20 pcs			



Part No.	417029	Ref. No.	108350 108350B 108460 3299
description	heating element 3000W 230V heating circuits 2 mounting \varnothing 40mm L 325mm W 33mm H 28mm hole distance 58mm hole \varnothing 9mm length thermostat sleeves 125mm thermostat sleeves \varnothing 5mm number of thermostat sleeves 1 thermostat sleeve centre not clinging windings 2 tube \varnothing 8mm connection M3 immersion heater 2 hole flange suitable for SAN MARCO		

accessories for		417029	
	Part No.	527169	Ref. No. —
hexagonal nut thread M3 H 2.8mm WS 5.5 brass Qty 1 pcs			
	Part No.	560110	Ref. No. —
plain washer ID \varnothing 3.2mm ED \varnothing 7mm thickness 0.5mm SS Qty 20 pcs DIN 125A for thread M3			
	Part No.	560130	Ref. No. —
hexagonal nut thread M3 H 2.4mm WS 5.5 SS DIN/ISO DIN 934 / ISO 4032/8673 Qty 20 pcs			



Part No.	417028	Ref. No.	0796FS
description	heating element 3000W 230V heating circuits 3 mounting \varnothing 46mm hole distance 62mm L 341mm W 33mm H 46mm L1 20mm L2 30mm L3 291mm H1 31mm H2 15mm hole \varnothing 10mm tube \varnothing 8.5mm thermostat sleeves \varnothing 7mm length thermostat sleeves 186mm thermostat sleeve centre number of thermostat sleeves 1 connection M4 immersion heater 3 hole flange suitable for SAN MARCO		

Part No.	417297	Ref. No.	108630
description	heating element 3500W 230V heating circuits 3 mounting \varnothing 46mm hole distance 61mm L 370mm W 38mm H 62mm L1 12mm L2 78mm L3 280mm H1 35mm H2 26mm hole \varnothing 11mm tube \varnothing 8mm thermostat sleeves \varnothing 5mm length thermostat sleeves 140mm thermostat sleeve eccentric, non clinging number of thermostat sleeves 1 connection M3 immersion heater 3 hole flange copper		





Part No.	417140	Ref. No.	N/A
description	heating element 4000W 220V heating circuits 2 mounting \varnothing 46mm hole distance 61mm L 555mm W 26mm H 59mm L1 25mm L2 60mm L3 470mm H1 25mm H2 34mm hole \varnothing 11mm tube \varnothing 8mm connection 1/8" immersion heater 3 hole flange suitable for SAN MARCO		



Part No.	417337	Ref. No.	108351
description	heating element 4500W 230V heating circuits 3 mounting \varnothing 40mm L 330mm W 32mm H 28mm hole distance 58mm hole \varnothing 9mm length thermostat sleeves 140mm thermostat sleeves \varnothing 5mm number of thermostat sleeves 1 thermostat sleeve centre not clinging tube \varnothing 8mm connection M3 immersion heater copper		



Part No.	417141	Ref. No.	108141
description	heating element 4500W 230V heating circuits 3 mounting \varnothing 46mm hole distance 60mm L 553mm W 34mm H 62mm L1 30mm L2 70mm L3 453mm H1 31mm H2 31mm hole \varnothing 11mm tube \varnothing 8mm thermostat sleeves \varnothing 7mm length thermostat sleeves 200mm thermostat sleeve centre not clinging connection M3 immersion heater 3 hole flange suitable for SAN MARCO		

accessories for		417141	
	Part No.	527169	Ref. No. —
hexagonal nut thread M3 H 2.8mm WS 5.5 brass Qty 1 pcs			
	Part No.	560110	Ref. No. —
plain washer ID \varnothing 3.2mm ED \varnothing 7mm thickness 0.5mm SS Qty 20 pcs DIN 125A for thread M3			
	Part No.	560130	Ref. No. —
hexagonal nut thread M3 H 2.4mm WS 5.5 SS DIN/ISO DIN 934 / ISO 4032/8673 Qty 20 pcs			



Part No.	417296	Ref. No.	108632
description	heating element 5500W 230V heating circuits 3 mounting \varnothing 46mm hole distance 60mm L 545mm W 39mm H 61mm L1 12mm L2 78mm L3 455mm H1 35mm H2 26mm hole \varnothing 11mm tube \varnothing 8mm thermostat sleeves \varnothing 5mm length thermostat sleeves 140mm thermostat sleeve eccentric, non clinging number of thermostat sleeves 1 connection M3 immersion heater 3 hole flange copper		



accessories

sealing washers

fibre gaskets

Part No.	510459	Ref. No.	109100
description	flat gasket fibre ED \varnothing 50mm ID \varnothing 40mm thickness 3mm Qty 1 pcs		

Part No.	528304	Ref. No.	109081
description	flat gasket fibre ED \varnothing 58mm ID \varnothing 46mm thickness 2mm Qty 1 pcs		

PTFE gaskets

Part No.	528011	Ref. No.	N/A
description	flat gasket PTFE ED \varnothing 14.5mm ID \varnothing 10mm thickness 2mm Qty 1 pcs suitable for SAN MARCO		

Part No.	528857	Ref. No.	N/A
description	flat gasket PTFE ED \varnothing 50mm ID \varnothing 40mm thickness 3.2mm Qty 1 pcs suitable for SAN MARCO		

Part No.	528010	Ref. No.	803F
description	flat gasket PTFE ED \varnothing 56mm ID \varnothing 46.5mm thickness 3mm Qty 1 pcs suitable for SAN MARCO		

thermostats

control and safety thermostats

EGO

safety thermostats

55.32_ series

Part No.	390324	Ref. No.	108463
description	safety thermostat switch-off temp. 169°C 3-pole 3NC 20A probe \varnothing 4mm probe L 128mm capillary pipe 890mm capillary pipe isolated 210/210mm gland nut probe SS		

switches and momentary switches

rocker/momentary rocker switches

30x22mm

Part No.	301003	Ref. No.	108108V	
description	rocker switch mounting measurements 30x22mm green 2NO 250V 16A illuminated 0-I connection male faston 6.3mm ambient temperature max. 125/55°C protection IP65			
accessories for	301003			
	Part No.	301036	Ref. No.	106070 106308
	protective cover internal size 30x22mm for rocker switch mounting measurementsmm			

Part No.	301062	Ref. No.	108602	
description	rocker switch mounting measurements 30x22mm green 2NO 250V 16A illuminated connection male faston 6.3mm ambient temperature max. 100/55°C protection IP40			
accessories for	301062			
	Part No.	301036	Ref. No.	106070 106308
	protective cover internal size 30x22mm for rocker switch mounting measurementsmm			



 1			
Part No.	301060	Ref. No.	108539
description	rocker switch mounting measurements 30x22mm red 2NO 250V 16A illuminated connection male faston 6.3mm ambient temperature max. 125/55°C protection IP40		

 1			
Part No.	301036	Ref. No.	106070 106308
description	protective cover internal size 30x22mm for rocker switch mounting measurementsmm		

push/momentary push switches

30x22mm

 1			
Part No.	301036	Ref. No.	106070 106308
description	protective cover internal size 30x22mm for rocker switch mounting measurementsmm		

microswitches

lever actuated

 1			
Part No.	345103	Ref. No.	108034
description	microswitch with lever 380V 20A 1CO connection screw clamp ambient temperature max. 120°C type X01-H2 SAIA		

roller-lever actuated

microswitches

 1			
Part No.	347272	Ref. No.	108231
description	microswitch with handle with a switch 250V 16A 1CO connection male faston ambient temperature max. 85°C mounting distance 22.2mm white lever length 20mm		

pin-plunger actuated

 1			
Part No.	347273	Ref. No.	108230
description	microswitch with plunger 250V 8A 1CO connection soldering connection ambient temperature max. 85°C mounting distance 22mm		

rotary switches

BREMAS

A3200 series

 1			
Part No.	345114	Ref. No.	1008/B 108136B
description	rotary switch 3 1-0-2 sets of contacts 5 type CS0325832 600V 32A shaft ϕ 5x5mm shaft L 23mm shaft square connection screw		

accessories

knobs

 1			
Part No.	112613	Ref. No.	106108
description	knob ϕ 42mm H 22mm black shaft diameter 5x5mm		

lamps

indicator lights

indicator lights (complete)

 ϕ 9mm

 1			
Part No.	359566	Ref. No.	108747ETL
description	indicator light ϕ 9mm 24V red cable length 500mm		

 ϕ 10mm

with plug-in socket

 1			
Part No.	359565	Ref. No.	108015
description	indicator light ϕ 10mm 250V red connection male faston 6.3mm cable length 500mm temp.-resist. 90°C		





timers

mechanical timers



1

Part No.	350176	Ref. No.	108268
description	timer C20 2-pole operation time 5min 2NO at 250V 16A permanent position no shaft ø 6x4.6mm shaft 6x4.6mm shaft L 20mm mounting distance 28mm		
accessories for	350176		
	Part No.	110366	Ref. No. —
	knob switch zero mark t.max.°C ø 44mm shaft ø 6x4.6mm shaft flat upper black		
	Part No.	112138	Ref. No. —
	dial plate graduation 5min permanent position no rotation 0-290° ø 60mm		



1

Part No.	350122 ¹	Ref. No.	108268
description	timer G 2-pole operation time 5min 2NO at 250V 16A shaft ø 3.5x3.5mm shaft L 14mm mounting distance 28mm		

¹incl. knob



1

Part No.	350121	Ref. No.	108924
description	timer MI5 2-pole operation time 5min impulse mechanical 2NO at 250V 16A permanent position no shaft ø 3.5x3.5mm shaft L 17mm mounting distance 28mm mounting thread M8		
spare parts for	350121		
	Part No.	350179	Ref. No. —
	timer G 2-pole operation time 5min impulse mechanical 2NO at 250V 16A permanent position no shaft ø 3.5x3.5mm shaft 3.5 x 3.5mm shaft L 17mm mounting distance 28mm connection lateral		

relays

level relays

MICRONOVA



1

Part No.	402414	Ref. No.	108456
description	level controller 220V		



1

Part No.	402416	Ref. No.	108055 108455
description	level controller 220V connection male faston 6.3mm type C020		

probes

sensors



1

Part No.	526941	Ref. No.	108270
description	temperature probe probe L 64mm probe ø 3mm cable length 400mm		



1

Part No.	379475	Ref. No.	108774
description	temperature probe Pt1000 coffee machine parts probe L 102mm probe ø 3mm 2-pole cable length 1000mm cable material silicone		

electronics

PCBs

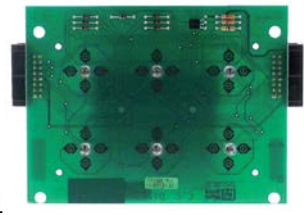



1

Part No.	402419	Ref. No.	108762
description	control PCB L 117mm W 90mm buttons 6		



1 			
Part No.	402423	Ref. No.	108793
description	control PCB L 117mm W 90mm with button buttons 1		

1 			
Part No.	402421	Ref. No.	108792
description	control PCB L 117mm W 90mm with keys buttons 6		

1 			
Part No.	402426	Ref. No.	108760
description	control PCB L 360mm W 90mm buttons 15		

1 			
Part No.	402425	Ref. No.	108761 108791 108812
description	control PCB L 360mm W 90mm with display buttons 15		

1 			
Part No.	402424	Ref. No.	108790
description	control PCB L 360mm W 90mm with keys buttons 15		

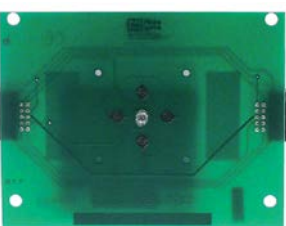
1 			
Part No.	402420	Ref. No.	108763
description	control PCB L 90mm W 117mm buttons 1		

1 			
Part No.	400494	Ref. No.	108406 5192
description	display PCB coffee machine		

1 			
Part No.	400491	Ref. No.	108286
description	keypad PCB 1-group mounting pos. left		

1 			
Part No.	400490	Ref. No.	108274
description	keypad PCB coffee machine mounting pos. right		

1 			
Part No.	401924	Ref. No.	108407
description	keypad PCB tea L 47mm W 40mm buttons 4		

1 			
Part No.	400498	Ref. No.	108407
description	keypad PCB tea L 47mm W 40mm with display buttons 4		

1 			
Part No.	400496	Ref. No.	108408
description	keypad PCB water		





			
1			
Part No.	401923	Ref. No.	108604
description	PCB coffee grinder L 62mm W 44mm 230V		

			
1			
Part No.	401922	Ref. No.	108604C
description	PCB for coffee grinder L 84mm W 62mm 230V 400V		

central units

			
1			
Part No.	400757	Ref. No.	16499 5207
description	central unit		

			
1			
Part No.	526951	Ref. No.	108756
description	control box 1-group for coffee machine 230V		

			
1			
Part No.	402909	Ref. No.	108541 108541_5
description	control box 2-group 230V L 188mm W 110mm suitable for SAN MARCO H 72mm		

			
1			
Part No.	402848	Ref. No.	108410
description	control box 3-group for coffee machine 230V		

			
1			
Part No.	526949	Ref. No.	108783
description	control box 4-group for coffee machine		

			
1			
Part No.	526952	Ref. No.	108755
description	control box 4-group for coffee machine 230V		

			
1			
Part No.	526948	Ref. No.	108754
description	control box for coffee machine		

			
1			
Part No.	526950	Ref. No.	108285
description	control box for coffee machine		

			
1			
Part No.	402417	Ref. No.	108412
description	control box for coffee machine 230V		



			
1			
Part No.	402418	Ref. No.	108409 5206
description	control box for coffee machine 230V		
For models:	SAN MARCO 95		



keypads





membrane keypads

			
1			
Part No.	400343	Ref. No.	108296
description	keypad foil espresso machine Serie 85		

keypad units

			
1			
Part No.	400488	Ref. No.	608066
description	keypad unit espresso machine Serie 85 edition 1-group		
accessories for	400488		
	Part No.	400343	Ref. No. 108296
description	keypad foil espresso machine Serie 85		
	Part No.	400491	Ref. No. 108286
description	keypad PCB 1-group mounting pos. left		
	Part No.	401438	Ref. No. —
description	keypad housing		
	Part No.	401439	Ref. No. —
description	bezel for keypad		
	Part No.	550695	Ref. No. —
description	gasket for keypad housing		

			
1			
Part No.	400489	Ref. No.	608067
description	keypad unit espresso machine Serie 85 edition 2-4-group		
accessories for	400489		
	Part No.	400343	Ref. No. 108296
description	keypad foil espresso machine Serie 85		

accessories for	400489		
	Part No.	400490	Ref. No. 108274
description	keypad PCB coffee machine mounting pos. right		
	Part No.	401438	Ref. No. —
description	keypad housing		
	Part No.	401439	Ref. No. —
description	bezel for keypad		
	Part No.	550695	Ref. No. —
description	gasket for keypad housing		

control panel

			
1			
Part No.	526933	Ref. No.	106128
description	control panel coffee machine		

			
1			
Part No.	526936	Ref. No.	106119
description	control panel coffee machine coffee/STOP		

			
1			
Part No.	526937	Ref. No.	106117 5195
description	control panel coffee machine for steam/water pipes		



			
1			
Part No.	526938	Ref. No.	106118 5194
description	control panel coffee machine for steam/water pipes		

			
1			
Part No.	526934	Ref. No.	106129
description	control panel coffee machine for switch		

			
1			
Part No.	526935	Ref. No.	106120 5191
description	control panel coffee machine L 110mm H 100mm coffee buttons 7		

			
1			
Part No.	526974	Ref. No.	106059
description	control panel L 140mm W 38mm black plastic buttons 5		

accessories

			
1			
Part No.	526973	Ref. No.	106487
description	button ø 30mm L 43mm W 43mm brown coffee		

			
1			
Part No.	526972	Ref. No.	106486
description	buttons strip L 97mm W 31mm brown buttons 3 hot water		

			
1			
Part No.	526970	Ref. No.	106485
description	keyset L 97mm W 66mm brown buttons 6		

			
1			
Part No.	526971	Ref. No.	106491
description	keyset L 97mm W 66mm brown buttons 6 cappuccino		

			
1			
Part No.	400497	Ref. No.	106130 5185
description	push button set 4-piece water		

			
1			
Part No.	400495	Ref. No.	106133 5190
description	push button set 7-piece coffee		

solenoid valves

solenoid valves (water)

























TP			
			
1			
Part No.	370021	Ref. No.	D15098 P125
description	solenoid valve double straight 230VAC inlet 3/4" outlet 11.5mm DN10 TP flow regulating valve inlet white		
spare parts for	370021		
		Part No.	371013 Ref. No. —
	solenoid coil TP 230VAC 50/60Hz		
accessories for	370021		
		Part No.	371220 Ref. No. —
	reducer TP flow rate 3l/min red tolerance ±15%		

Table continues overleaf



accessories for		370021	
Part No.	371221	Ref. No.	—
	reducer TP flow rate 5.5l/min yellow tolerance ±15%		
	reducer TP flow rate 6l/min grey tolerance ±15%		
	reducer TP flow rate 10l/min white tolerance ±15%		
	reducer TP flow rate 12l/min bronze tolerance ±15%		
	reducer TP flow rate 16l/min light brown tolerance ±15%		
	reducer TP flow rate 20l/min red tolerance ±15%		
	reducer TP flow rate 0.25l/min red tolerance ±25%		
	reducer TP flow rate 0.35l/min violet tolerance ±25%		
	reducer TP flow rate 0.5l/min orange tolerance ±25%		
	reducer TP flow rate 0.8l/min white tolerance ±25%		
	reducer TP flow rate 1l/min light blue tolerance ±25%		
	reducer TP flow rate 1.2l/min brown tolerance ±25%		
	reducer TP flow rate 1.5l/min light brown tolerance ±25%		
	reducer TP flow rate 2.5l/min yellow tolerance ±25%		
	reducer TP flow rate 3.4l/min dark green tolerance ±25%		
	reducer TP flow rate 5l/min black tolerance ±25%		
	reducer TP flow rate 8l/min blue tolerance ±20%		

metal			
ASCO			
spare parts and accessories			
O-rings			
	1		
Part No.	371095	Ref. No.	1025
description	O-ring Viton thickness 1.78mm ID ø 6.07mm Qty 1 pcs		

PARKER				
2-way				
E-146 series				
	1			
Part No.	370206	Ref. No.	1096	
description	solenoid valve 2-ways 230VAC connection 1/8" L 40mm DN 2.5mm slide-on receptacle DIN -20° up to 130°C PARKER type series VE-146 coil type ZB09 membranes FKM (water) p max 15bar p min 0bar			
spare parts for	370206			
	Part No.	371029	Ref. No.	—
	solenoid coil PARKER 230VAC 9VA coil type ZB09 seat ø 14mm H 33mm W 34mm D 43mm			
accessories for	370206			
	Part No.	371090	Ref. No.	—
	power socket plug type DIN 43650A screw			











3-way				
VE-128 series				
	1			
Part No.	370057	Ref. No.	1027 108063	
description	solenoid valve 3-ways 230VAC body outer cone DN 1.2mm slide-on receptacle DIN -20° up to 140°C PARKER type series VE-128 coil type ZB09 membranes ruby p max 10bar brass flange 32x32mm			
spare parts for	370057			
	Part No.	370062	Ref. No.	—
	solenoid valve body PARKER 3-ways outer cone			
	Part No.	371029	Ref. No.	—
	solenoid coil PARKER 230VAC 9VA coil type ZB09 seat ø 14mm H 33mm W 34mm D 43mm			

Table continues overleaf

accessories for	370057			
	Part No.	371090	Ref. No.	—
	power socket plug type DIN 43650A screw			
	Part No.	371095	Ref. No.	1025
	O-ring Viton thickness 1.78mm ID ø 6.07mm Qty 1 pcs			
	Part No.	371100	Ref. No.	—
	O-ring silicone thickness 1.78mm ID ø 6.07mm Qty 1 pcs			

SIRAI				
solenoid valves steam (water)				
2-way				
L121 series				
	1			
Part No.	370084	Ref. No.	108035	
description	solenoid valve 2-ways 230VAC connection 1/4" L 42mm DN 3.2mm slide-on receptacle DIN -10 up to 140°C SIRAI type series L121 coil type ZA34A membranes EPDM p max 8bar p min 0.1bar			
spare parts for	370084			
	Part No.	371176	Ref. No.	—
	solenoid coil 230VAC 14VA SIRAI coil type ZA34A seat ø 14mm			

Solenoid valve - accessories			
	1		
Part No.	371095	Ref. No.	1025
description	O-ring Viton thickness 1.78mm ID ø 6.07mm Qty 1 pcs		

electrodes			
	1		
Part No.	401925	Ref. No.	202237
description	level electrode thread 1/4"		

flow meters and flow sensors

flow meters

GICAR



Part No.	400004	Ref. No.	2209.006	
description	flow meter thread 1/4" stainless steel with LED plug connection approval NSF			
accessories for	400004			
	Part No.	400256	Ref. No.	—
	plug GICAR for flow meter			

pumps

booster pumps II

pump heads

FLUID-O-TECH



Part No.	504364	Ref. No.	202001
description	pump head PA1504Z FLUID-O-TECH L 82mm 150l/h connection 3/8" NPT with bypass brass clip connection for coffee machine shaft ø 4.8x11mm		



Part No.	500064	Ref. No.	0805 N/A	
description	pump head PO204 FLUID-O-TECH L 82mm 200l/h connection 3/8" GAS with bypass brass clip connection for coffee machine shaft ø 4.8x11mm			
accessories for	500064			
	Part No.	520126	Ref. No.	—
	clamp for pump/motor			



fuses

fine fuses



1

Part No.	358687	Ref. No.	1248
description	fine fuse size ø5x20mm 0.5A medium lag rated 250V Qty 10 pcs		

equipment-specific units

for display coolers

housing and bezels



1

Part No.	526939	Ref. No.	106116
description	cover cap for keypad L 50mm W 42mm		



1

Part No.	526940	Ref. No.	106109
description	cover cap for keypad L 85mm W 66mm		



1

Part No.	526942	Ref. No.	106127 5196
description	front panel for switching unit		



1

Part No.	526943	Ref. No.	106111
description	switch panel for gas appliance		

for espresso machines

filter holders

filter holders standard

filter holder without spout



1

Part No.	525993	Ref. No.	N/A
description	filter holder suitable for SAN MARCO without outlet mounting ø 82mm outlet 3/8" ID ø 57.8mm wedge height 13.2mm number of wedges 3 lever straight chrome-plated brass		

filter holders short



1

Part No.	529057	Ref. No.	1664 502034 502750
description	filter holder mounting ø 82mm outlet 3/8" ID ø 57.8mm handle M10x1.5 wedge height 13.2mm number of wedges 3 lever straight chrome-plated brass		

handles

with external thread



1

Part No.	529053	Ref. No.	1665
description	handle ø 35mm thread M10x1.5 thread L 15mm L 125mm black		



spouts			
with thread 3/8"			
			
1			
Part No.	529004	Ref. No.	205494
description	filter holder spout thread 3/8" 1-way curved/long outlet distance		

			
1			
Part No.	529007	Ref. No.	205495
description	filter holder spout thread 3/8" 2-way curved/short outlet distance 45mm		

filters			
for 1 cup			
			
1			
Part No.	525952	Ref. No.	202108
description	coffee filter ø 66mm mounting ø 57mm H 22mm cups 1 amount of coffee 6g stainless steel		

			
1			
Part No.	525958	Ref. No.	202116
description	coffee filter ø 66mm mounting ø 57mm H 22mm cups 1 amount of coffee 7g SS		

			
1			
Part No.	525950	Ref. No.	202110
description	coffee filter ø 66mm mounting ø 57mm H 22mm cups 1 amount of coffee 8g stainless steel		

			
1			
Part No.	529026	Ref. No.	0238 202116 202119
description	coffee filter ø 66mm mounting ø 57mm H 25mm cups 1 amount of coffee 9g		

			
1			
Part No.	529098	Ref. No.	N/A
description	coffee filter ø 70mm mounting ø 60.3mm H 22mm cups 1 amount of coffee 7g		

for 2 cups			
			
1			
Part No.	525953	Ref. No.	202112
description	coffee filter ø 66mm mounting ø 57mm H 24mm cups 2 amount of coffee 12g		

			
1			
Part No.	525957	Ref. No.	202117
description	coffee filter ø 66mm mounting ø 57mm H 25mm cups 2 amount of coffee 14g		

			
1			
Part No.	529027	Ref. No.	0237 202121
description	coffee filter ø 66mm mounting ø 57mm H 26.4mm cups 2 amount of coffee 18g		

			
1			
Part No.	525951	Ref. No.	202114
description	coffee filter ø 66mm mounting ø 57mm H 26mm cups 2 amount of coffee 16g		



blind filters



1

Part No.	529028	Ref. No.	1159 202115
description	blind filter ø 65.5mm mounting ø 56mm H 21.5mm		

filter holder springs



1

Part No.	525956	Ref. No.	200056
description	filter holder spring L 70mm W 60mm wire gauge ø 1.2mm for espresso filter holder		



1

Part No.	529079	Ref. No.	1830 200056
description	filter holder spring L 70mm W 60mm wire gauge ø 1.3mm for espresso filter holder		



1

Part No.	531243	Ref. No.	N/A
description	filter holder spring L 70mm W 60mm wire gauge ø 1.3mm for espresso filter holder Qty 20 pcs		

brewing units

shower screens

flat



1

Part No.	529088	Ref. No.	202011
description	shower screen ø 48mm hole ø 5.5mm flat		



1

Part No.	525954	Ref. No.	202271
description	shower screen ø 48mm hole ø 5mm flat		

filter holder gaskets

flat

standard



1

Part No.	528038	Ref. No.	1019 109011
description	filter holder gasket D1 ø 64mm D2 ø 52.5mm H 5.5mm Qty 1 pcs		



1

Part No.	528081	Ref. No.	N/A
description	filter holder gasket D1 ø 64mm D2 ø 52.5mm H 6.5mm Qty 1 pcs		

brewing units with solenoid valve

components



1

Part No.	526947	Ref. No.	206272
description	infusor 1/4" L 50mm ø 39mm SS		

components

nozzles

with thread



1

Part No.	525943	Ref. No.	205408
description	nozzle bore ø 0.55mm thread M6 L 23mm for brewing unit		





1

Part No.	525942	Ref. No.	205037
description	nozzle bore ø 1mm thread M5 L 15mm for brewing unit		





injector tubes			
			
1			
Part No.	526998	Ref. No.	1016/E 205308
description	injector pipe for brewing unit copper ø 6mm M6 L 80mm		

			
1			
Part No.	526996	Ref. No.	602000
description	injector pipe for brewing unit L 90mm ø 6mm		

			
1			
Part No.	526999	Ref. No.	205331
description	injector pipe for brewing unit ø 6mm L 57mm copper thread M5		

			
1			
Part No.	526997	Ref. No.	206199
description	injector pipe ø 6mm L 86mm PTFE		

screws			
			
1			
Part No.	560373	Ref. No.	204074
description	cylinder head bolt thread M4 thread L 12mm WS 3 SS Qty 1 pcs intake internal hexagon DIN 912/ISO 4762		

miscellaneous			
			
1			
Part No.	526994	Ref. No.	109117
description	bush PTFE ø 12mm H 10mm		

water dispersions			
water dispersions			
group 3			
			
1			
Part No.	525955	Ref. No.	206823
description	water distributor ø 54mm H 12mm 4 holes hole ø 2.5mm mounting ø 5mm brass		

safety valves			
safety valves			
metric thread			
			
1			
Part No.	529309	Ref. No.	N/A
description	safety valve connection M18x1.5 triggering pressure 1.8bar		

gaskets			
			
1			
Part No.	526991	Ref. No.	109096
description	flat gasket copper ED ø 23mm ID ø 17mm thickness 1.5mm		

expansion valves			
gaskets			
			
1			
Part No.	525969	Ref. No.	109069
description	sealing disc ED ø 13mm H 3.4mm without hole		

compression springs			
			
1			
Part No.	525968	Ref. No.	200049
description	compression spring ø 10.3mm L 28mm wire gauge ø 1.5mm for expansion valve		



with non-return valve



1

Part No.	529554	Ref. No.	400029 400029A
description	expansion valve with non-return valve 3/8"-1/4" nominal-ø 6mm		



1

Part No.	529561	Ref. No.	400029A
description	expansion valve with non-return valve 3/8"-1/8" nominal-ø 5mm		

drain pans

drain pans



1

Part No.	526975	Ref. No.	106490
description	drain pan L 75mm W 85mm H 56mm hose ø 15mm		



1

Part No.	529751	Ref. No.	106056
description	drain pan L 80mm W 70mm H 55mm hose ø 14mm		

aerators and air bleeders



1

Part No.	529303	Ref. No.	3041
-----------------	--------	-----------------	------

description aerator and air bleeder connection 1/4" only steam

spare parts for 529303



Part No.	528687	Ref. No.	—
-----------------	--------	-----------------	---

O-ring Viton thickness 1.78mm ID ø 3.69mm Qty 1 pcs

boilers

gaskets

unperforated



1

Part No.	528133	Ref. No.	109073
-----------------	--------	-----------------	--------

description boiler gasket D1 ø 165mm D2 ø 150mm thickness 3mm PTFE suitable for SAN MARCO



1

Part No.	525963	Ref. No.	109099
-----------------	--------	-----------------	--------

description gasket fibre ED ø 132mm ID ø 123mm thickness 3mm Qty 1 pcs



1

Part No.	525962	Ref. No.	109073
-----------------	--------	-----------------	--------

description gasket fibre ED ø 163mm ID ø 150mm thickness 3mm Qty 1 pcs

heat exchangers

injector tubes



1

Part No.	527456	Ref. No.	3312 400071 400071B
-----------------	--------	-----------------	---------------------------

description injector pipe ø 6mm L 175mm thread 1/4"



1			
Part No.	526962	Ref. No.	400070 400070B
description	injector pipe T-piece tube ø 6mm pipe length 175mm T1: 1/4" T2: 1/4" brass		

1			
Part No.	526961	Ref. No.	400071A
description	injector pipe tube ø 6mm pipe length 175mm T1: 1/8" T2: 1/8"		

1			
Part No.	526960	Ref. No.	400115A
description	injector pipe tube ø 6mm pipe length 86mm T1: 1/4" T2: 1/4"		

steam/water taps

steam/water taps

steam taps

steam taps (complete)

1			
Part No.	526944	Ref. No.	400150
description	steam tap complete		

1			
Part No.	526953	Ref. No.	400300
description	steam tap complete beige		

1			
Part No.	526955	Ref. No.	400086
description	steam tap mounting pos. left/right complete		

components

shafts

1			
Part No.	526979	Ref. No.	205094
description	shaft for steam-/water-tap ø 7mm L 70mm stainless steel		

bushes

1			
Part No.	526984	Ref. No.	205009
description	bush D1 ø 17mm D2 ø 7mm H 8mm brass		

1			
Part No.	528867	Ref. No.	109049
description	bush PTFE		

gaskets

1			
Part No.	528303	Ref. No.	109049
description	gasket D1 ø 12.5mm D2 ø 7mm thickness 5.5mm PTFE steam/water tap conical		

1			
Part No.	528302	Ref. No.	109024
description	gasket D1 ø 15mm D2 ø 5.3mm thickness 4.3mm rubber for steam-/water-tap		



			
1			
Part No.	525971	Ref. No.	109024
description	gasket D1 ø 15mm D2 ø 5.4mm thickness 4.2mm for steam-/water-tap		

			
1			
Part No.	526986	Ref. No.	109023
description	gasket D1 ø 17mm D2 ø 6mm thickness 4mm rubber		

			
1			
Part No.	525970	Ref. No.	109079
description	gasket D1 ø 23mm D2 ø 18.5mm thickness 1mm fibre		

gasket supports

			
1			
Part No.	526981	Ref. No.	205003
description	piston for steam-/water-tap ø 19mm brass		

springs

			
1			
Part No.	525965	Ref. No.	200033
description	compression spring ø 16mm L 20mm wire gauge ø 1.7mm for steam-/water-tap		

			
1			
Part No.	525964	Ref. No.	200026
description	compression spring ø 16mm L 20mm wire gauge ø 1.8mm for steam-/water-tap		

tap bodies

			
1			
Part No.	526967	Ref. No.	502050
description	tap body L 94mm		

levers

			
1			
Part No.	526965	Ref. No.	502004
description	lever L 68mm		

nuts

			
1			
Part No.	526982	Ref. No.	205123
description	hexagonal nut thread M18x1.5 H 6mm WS 26 Qty 1 pcs		

			
1			
Part No.	526983	Ref. No.	205007
description	hexagonal nut thread M25 H 6mm WS 27 brass Qty 1 pcs		

union nuts

			
1			
Part No.	526966	Ref. No.	0.526966 205008
description	union nut ID ø 15mm L 22mm WS 27		



screw connections



1

Part No.	526980	Ref. No.	205310
description	screw connection for steam-/water-tap WS 27 brass		

miscellaneous



1

Part No.	525948	Ref. No.	202235
description	ball for steam-/water-tap stainless steel ø 6.3mm		



1

Part No.	526987	Ref. No.	205585
description	cap for steam-/water-tap ø 18mm H 6mm		



1

Part No.	525949	Ref. No.	206949
description	pin for steam-/water-tap stainless steel ø 3mm L 52mm		



1

Part No.	526985	Ref. No.	205534
description	reducing washer for water tap brass ø 14.3mm ID ø 2mm thickness 2mm		



1

Part No.	526988	Ref. No.	205583
description	rosette for water tap stainless steel ø 23mm ID ø 15mm H 2mm		

water taps

water taps



1

Part No.	526945	Ref. No.	400087
description	water tap complete		



1

Part No.	526954	Ref. No.	400301
description	water tap complete beige		

steam/water pipes

steam pipes



1

Part No.	529299	Ref. No.	507131
description	steam pipe L 170mm tube ø 8mm chrome-plated Serie 85 M10x0.75		



1

Part No.	526946	Ref. No.	206224
description	steam pipe L 190mm		



			
1			
Part No.	526957	Ref. No.	206903
description	steam pipe L 190mm tube ø 10mm		

			
1			
Part No.	529836	Ref. No.	507131
description	steam pipe ø 10mm SS		

			
1			
Part No.	526964	Ref. No.	206903C
description	steam pipe short L 180mm tube ø 10mm stainless steel		

water pipes

			
1			
Part No.	529555	Ref. No.	507132
description	water pipe ø 10mm L 127mm suitable for Serie 85 bore ø 5mm WS 22		

			
1			
Part No.	525959	Ref. No.	507132
description	water pipe thread 3/8" L 85mm tube ø 11mm WS 22 nozzle ø 16mm		

accessories

bushes

			
1			
Part No.	528208	Ref. No.	109091
description	gasket D1 ø 14.5mm D2 ø 10.5mm H 4.5mm PTFE for steam/water pipes		

springs			
			
1			
Part No.	525966	Ref. No.	200051 200150
description	compression spring ø 11.8mm L 15mm wire gauge ø 2.2mm		

miscellaneous

			
1			
Part No.	528306	Ref. No.	205525
description	disc for steam/water pipes brass D1 ø 14.3mm D2 ø 7.5mm thickness 2mm		

gaskets

flat gaskets			
PTFE gaskets			
			
1			
Part No.	526993	Ref. No.	109078
description	flat gasket PTFE ED ø 34mm ID ø 26.5mm thickness 2mm Qty 1 pcs for thread 3/4"		

intake valves

accessories			
springs			
			
1			
Part No.	525967	Ref. No.	200150
description	compression spring ø 14.5mm L 20mm wire gauge ø 1.8mm for filling valve		

			
1			
Part No.	528866	Ref. No.	200034
description	compression spring ø 15mm L 20mm wire gauge ø 2.2mm for filling valve		

levers

			
1			
Part No.	528864	Ref. No.	502067
description	lever for filling valve		



level glasses

level glasses

gaskets

1 

Part No.	525944	Ref. No.	109150
description	gasket D1 ø 20mm D2 ø 14mm H 10mm for water level tube		

1 

Part No.	529392	Ref. No.	0701
description	gasket D1 ø 6.8mm D2 ø 17mm thickness 1mm water level glass suitable for SAN MARCO		

balls

1 

Part No.	525945	Ref. No.	106480
description	ball ø 10mm plastic for water level tube red		

level glass pipes

1 

Part No.	526978	Ref. No.	206910
description	water level tube ø 15mm H 115mm		

1 

Part No.	529390	Ref. No.	104002
description	water level tube ø 30mm H 110mm		

pipes

pipes

1 

Part No.	527457	Ref. No.	205290 3363
description	connecting fitting ø 26mm L 39mm T1: 1/4" T2: 3/4"		

accessories

1 

Part No.	526969	Ref. No.	106151
description	gasket ø 10mm L 6mm PTFE hole ø 4mm		

non-return valves

complete

1 

Part No.	525960	Ref. No.	202201
description	non-return valve inlet 3/8" outlet 3/8" L 62mm		

1 

Part No.	528790	Ref. No.	202201
description	non-return valve T1: 3/8" T2: 3/8" L 42.5mm total length 67mm		

miscellaneous

1 

Part No.	526958	Ref. No.	400166
description	heat exchanger T1: 1/2" T2: 1/2" ø 60mm L 198mm copper		



			
1			
Part No.	526959	Ref. No.	1034/A 507320
description	heat exchanger T1: 3/4" T2: 3/4" ø 50mm L 195mm for nickel-plated copper		

			
1			
Part No.	526956	Ref. No.	507430
description	heat exchanger thread 1/2" IT		

			
1			
Part No.	525947	Ref. No.	205175
description	roller ø 15mm W 10mm brass hole ø 7mm		

			
1			
Part No.	526968	Ref. No.	0700 400062
description	tie bar for level glass T3: M6 L 167mm WS 16		

screw connections

double nipples

			
1			
Part No.	526989	Ref. No.	206213
description	screw connection T1: 1/2" T2: 3/8" int. ø 1 11mm int. ø 2 10mm L 37mm brass Qty 1 pcs for flow heaters		

			
1			
Part No.	526990	Ref. No.	206214
description	screw connection T1: 3/4" T2: 1/2" int. ø 1 19.5mm int. ø 2 11.5mm L 32mm brass Qty 1 pcs for flow heaters		

for coffee grinders

grinding burrs

grinding burrs straight

standard

			
1			
Part No.	526931	Ref. No.	202174
description	grinding burrs pair turn direction right D1 ø 64mm ID ø 37mm H 8.5mm tooth spacing 4mm hole ø 6.3mm bore ø 8.5mm mounting ø 49		

			
1			
Part No.	527246	Ref. No.	N/A
description	grinding burrs pair turn direction right D1 ø 64mm ID ø 38mm H 8.6mm tooth spacing 3mm hole ø 6mm bore ø 8.5mm mounting ø 48 straight suitable for SAN MARCO		

			
1			
Part No.	527247	Ref. No.	202213 202254
description	grinding burrs pair turn direction right D1 ø 83.5mm ID ø 45mm H 9mm tooth spacing 4mm hole ø 6mm bore ø 10mm mounting ø 66 straight suitable for GAGGIA, ARISTARCO, SAN MARCO mounting distance 56mm		

grinding burrs conical

			
1			
Part No.	526932	Ref. No.	202251
description	grinding burrs pair turn direction right D1 ø 68mm D2 ø 49mm H 25mm shaft ø 13mm with flute suitable for SAN MARCO		



grinding burrs straight/conical



1

Part No.	526930	Ref. No.	202250
description	grinding burr set turn direction right D1 ø 84mm D2 ø 45mm shaft ø 13mm H 9mm 3-piece suitable for SAN MARCO		

screws



1

Part No.	526921	Ref. No.	204116
description	cylinder head bolt thread M4 thread L 10mm head ø 7mm zinc-coated steel Qty 1 pcs intake slotted head thickness 2.5mm		



1

Part No.	526922	Ref. No.	204061
description	flat-headed bolt thread M5 thread L 10mm steel Qty 1 pcs intake slotted head ø 8mm head thickness 3mm		

spillage trays



1

Part No.	526917	Ref. No.	106554
description	drain tray L 133mm W 166mm black		



1

Part No.	526918	Ref. No.	106258
description	drain tray L 220mm W 110mm		

miscellaneous



1

Part No.	530534	Ref. No.	106054+106145
description	equipment foot rectangular L 30mm plastic for coffee grinder		

dosing containers

dosing container lids



1

Part No.	526908	Ref. No.	106044
description	lid for dosing container ø 120mm		



1

Part No.	526910	Ref. No.	106551
description	lid for dosing container ø 120mm		



1

Part No.	526909	Ref. No.	106260
description	lid for dosing container ø 120mm grey		

springs

group 1



1

Part No.	526923	Ref. No.	300284
description	compression spring ø 4.6mm L 33mm wire gauge ø 0.4mm for ratchet		



1

Part No.	526925	Ref. No.	300281SX
description	torsion spring ø 26.5mm wire gauge ø 2mm L1 23mm L2 29mm left		



1

Part No.	526926	Ref. No.	300306
description	torsion spring ø 26.5mm wire gauge ø 2mm L1 27mm L2 27mm right		



glass cylinders



1

Part No.	526907	Ref. No.	106036
description	cylinder for dosing container ø 123mm H 100mm		

levers

levers



1

Part No.	531099	Ref. No.	300355SX
description	lever left hole ø 16mm L 140mm grey		



1

Part No.	526915	Ref. No.	300355
description	lever right hole ø 16mm L 140mm grey		



1

Part No.	526916	Ref. No.	300285
description	lever right hole ø 16mm L 140mm plastic black		

coffee presses

components

pressers



1

Part No.	526912	Ref. No.	106084
description	coffee press ø 53.7mm H 26mm thread M8 black		



1

Part No.	526911	Ref. No.	106263
description	coffee press ø 53.7mm thread M8 grey		



1

Part No.	526914	Ref. No.	106264
description	coffee press ø 56.5mm H 25mm thread M8 grey		



1

Part No.	526913	Ref. No.	106085
description	coffee press ø 56.5mm H 27mm thread M8 black		

ratches

springs



1

Part No.	526928	Ref. No.	300265
description	compression spring ø 3.5mm L 20mm wire gauge ø 0.4mm for ratchet		



1

Part No.	526923	Ref. No.	300284
description	compression spring ø 4.6mm L 33mm wire gauge ø 0.4mm for ratchet		

pins



1

Part No.	526929	Ref. No.	300277
description	pressure pin ø 4mm L 15.5mm		



1

Part No.	526924	Ref. No.	300282
description	pressure pin ø 5mm L 16mm		

adjustment mechanism

lockable adjustment





1

Part No.	526920	Ref. No.	106171
description	push button for coffee grinder shaft ø 6mm shaft length 36mm black		



 <p>1</p>			
Part No.	526919	Ref. No.	106262
description	push button for coffee grinder shaft ø 6mm shaft length 36mm grey		

springs			
 <p>1</p>			
Part No.	526927	Ref. No.	200061
description	compression spring ø 5.5mm L 3.2mm wire gauge ø 0.5mm		

coffee beans containers			
container lids			
 <p>1</p>			
Part No.	526906	Ref. No.	106550
description	lid for coffee beans container ø 170mm		

 <p>1</p>			
Part No.	526901	Ref. No.	106051
description	lid for coffee beans container ø 175mm		

 <p>1</p>			
Part No.	527327	Ref. No.	N/A
description	lid for coffee beans container ø 210mm		

 <p>1</p>			
Part No.	526904	Ref. No.	106250
description	lid for coffee beans container ø 220mm grey		

coffee beans containers			
 <p>1</p>			
Part No.	526900	Ref. No.	106166
description	coffee beans container ø 175mm H 220mm seat ø 68mm		

 <p>1</p>			
Part No.	526903	Ref. No.	106202
description	coffee beans container ø 221mm H 231mm seat ø 68mm		



1

Part No.	531179	Ref. No.	N/A
description	coffee beans container without lid ø 207mm H 245mm universal		
accessories for	531179		
	Part No.	527327	Ref. No. N/A
	lid for coffee beans container ø 210mm		

supports



1

Part No.	531171	Ref. No.	N/A
description	support for coffee beans container intake conical seat ø 67-66mm suitable for SAN MARCO		

locks

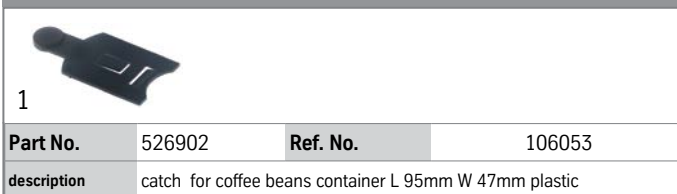

1

Part No.	526902	Ref. No.	106053
description	catch for coffee beans container L 95mm W 47mm plastic		



1

Part No.	526905	Ref. No.	106203
description	catch for coffee beans container L 95mm W 47mm plastic		

knobs

steam/water taps

steam/water taps



1

Part No.	526976	Ref. No.	106414
description	knob ø 61mm shaft ø 7x7mm beige steam/water		



1

Part No.	526977	Ref. No.	106413
description	turning handle 2-0-1 ø 51mm shaft ø 5x5mm beige		

handles and hand wheels

cylindrical handles

fixed



1

Part No.	111037	Ref. No.	106026
description	cylindrical handle thread M10 bore ø 13.6mm ø 24mm L 80mm plastic		

cone handles



1

Part No.	112614	Ref. No.	106020
description	cone handle thread M10 ø 20mm L 40mm plastic black		

lever handles



1

Part No.	111010	Ref. No.	106107 5102
description	lever handle plastic black L 95mm W 60mm		



miscellaneous

1 

Part No.	111051	Ref. No.	106072
description	handle L 45mm W 46mm ø 26mm for filling valve plastic black		

gaskets

O-rings

EPDM

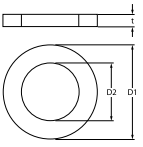
1  

Part No.	510177	Ref. No.	109017
description	O-ring EPDM thickness 1.78mm ID ø 7.66mm Qty 1 pcs		

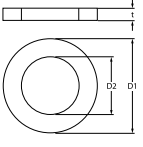
1  

Part No.	529251	Ref. No.	109046
description	O-ring EPDM thickness 2.62mm ID ø 15.08mm Qty 1 pcs		

silicone

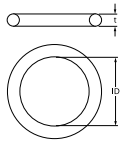
1  

Part No.	532520	Ref. No.	109046
description	O-ring silicone thickness 2.62mm ID ø 15.08mm Qty 1 pcs		

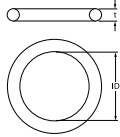
1  

Part No.	532568	Ref. No.	109113
description	O-ring silicone thickness 2.62mm ID ø 21.89mm Qty 1 pcs		

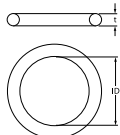
1  

Part No.	532569	Ref. No.	109045
description	O-ring silicone thickness 5.34mm ID ø 75.57mm Qty 1 pcs		

Viton

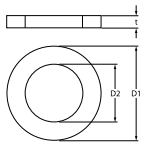
1  

Part No.	371095	Ref. No.	1025
description	O-ring Viton thickness 1.78mm ID ø 6.07mm Qty 1 pcs		

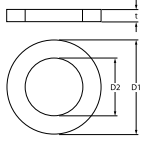
1  

Part No.	528282	Ref. No.	109017
description	O-ring Viton thickness 1.78mm ID ø 7.66mm Qty 1 pcs		

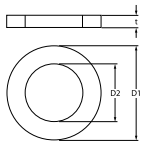
1  

Part No.	532567	Ref. No.	109114
description	O-ring Viton thickness 2.62mm ID ø 13.1mm Qty 1 pcs		

sealing washers

fibre gaskets

1 

Part No.	526995	Ref. No.	109061
description	flat gasket FIBER ED ø 28mm ID ø 22mm thickness 1mm Qty 1 pcs		

1 

Part No.	528134	Ref. No.	3362
description	flat gasket fibre ED ø 34mm ID ø 27mm thickness 2mm for thread 3/4" Qty 1 pcs		

1 

Part No.	510459	Ref. No.	109100
description	flat gasket fibre ED ø 50mm ID ø 40mm thickness 3mm Qty 1 pcs		



			
1			
Part No.	528304	Ref. No.	109081
description	flat gasket fibre ED ø 58mm ID ø 46mm thickness 2mm Qty 1 pcs		

			
1			
Part No.	525963	Ref. No.	109099
description	gasket fibre ED ø 132mm ID ø 123mm thickness 3mm Qty 1 pcs		

			
1			
Part No.	525962	Ref. No.	109073
description	gasket fibre ED ø 163mm ID ø 150mm thickness 3mm Qty 1 pcs		

rubber gaskets

			
1			
Part No.	528859	Ref. No.	109051 109069
description	flat gasket rubber ED ø 14mm ID ø 4mm thickness 4mm Qty 1 pcs		

copper gaskets

DIN-7603-A

			
1			
Part No.	526991	Ref. No.	109096
description	flat gasket copper ED ø 23mm ID ø 17mm thickness 1.5mm		

PTFE gaskets

			
1			
Part No.	528858	Ref. No.	109099
description	flat gasket PTFE ED ø 132mm ID ø 123mm thickness 3.2mm Qty 1 pcs suitable for SAN MARCO		

			
1			
Part No.	528011	Ref. No.	N/A
description	flat gasket PTFE ED ø 14.5mm ID ø 10mm thickness 2mm Qty 1 pcs suitable for SAN MARCO		

			
1			
Part No.	528865	Ref. No.	109079
description	flat gasket PTFE ED ø 22mm ID ø 19.5mm thickness 1mm Qty 1 pcs suitable for SAN MARCO		

			
1			
Part No.	526992	Ref. No.	109106
description	flat gasket PTFE ED ø 27mm ID ø 21mm thickness 2mm Qty 1 pcs		

			
1			
Part No.	526993	Ref. No.	109078
description	flat gasket PTFE ED ø 34mm ID ø 26.5mm thickness 2mm Qty 1 pcs for thread 3/4"		

			
1			
Part No.	528418 ¹	Ref. No.	1033
description	flat gasket PTFE ED ø 34mm ID ø 27mm thickness 2mm Qty 2 pcs		

¹Qty 2 pieces

			
1			
Part No.	528857	Ref. No.	N/A
description	flat gasket PTFE ED ø 50mm ID ø 40mm thickness 3.2mm Qty 1 pcs suitable for SAN MARCO		

			
1			
Part No.	528010	Ref. No.	803F
description	flat gasket PTFE ED ø 56mm ID ø 46.5mm thickness 3mm Qty 1 pcs suitable for SAN MARCO		

silicone gaskets

			
1			
Part No.	529391	Ref. No.	0705 109015
description	flat gasket silicone ED ø 31mm ID ø 19mm thickness 3mm Qty 1 pcs		



special gaskets

group gaskets



Part No.	528877	Ref. No.	109070
description	gasket L 94mm W 45mm thickness 2.2mm hole distance 74mm suitable for SAN MARCO		

Part No.	528135	Ref. No.	N/A
description	group gasket L 95mm W 45mm		

springs

torsion springs



Part No.	525946	Ref. No.	200003
description	torsion spring ϕ 14.3mm L2 13mm wire gauge ϕ 1.3mm L1 8mm L3 6.5mm Qty 1 pcs		

compression springs



Part No.	525966	Ref. No.	200051 200150
description	compression spring ϕ 11.8mm L 15mm wire gauge ϕ 2.2mm		



Part No.	528307	Ref. No.	200051 200150
description	compression spring ϕ 11.8mm L 17mm wire gauge ϕ 2.2mm		



Part No.	528866	Ref. No.	200034
description	compression spring ϕ 15mm L 20mm wire gauge ϕ 2.2mm for filling valve		



Part No.	528869	Ref. No.	200026
description	compression spring ϕ 16.4mm L 21mm wire gauge ϕ 2mm		



Part No.	528868	Ref. No.	200033
description	compression spring ϕ 16.6mm L 20mm wire gauge ϕ 2.1mm		



Part No.	525965	Ref. No.	200033
description	compression spring ϕ 16mm L 20mm wire gauge ϕ 1.7mm for steam-/water-tap		



Part No.	525964	Ref. No.	200026
description	compression spring ϕ 16mm L 20mm wire gauge ϕ 1.8mm for steam-/water-tap		



Part No.	526928	Ref. No.	300265
description	compression spring ϕ 3.5mm L 20mm wire gauge ϕ 0.4mm for ratchet		

1 

Part No.	526923	Ref. No.	300284
description	compression spring ø 4.6mm L 33mm wire gauge ø 0.4mm for ratchet		

1 

Part No.	526927	Ref. No.	200061
description	compression spring ø 5.5mm L 3.2mm wire gauge ø 0.5mm		

1 

Part No.	528860	Ref. No.	200049
description	compression spring ø 9.8mm L 27mm wire gauge ø 1.7mm		

manometers

1 

Part No.	541220	Ref. No.	1174 202102
description	manometer double scale ø 63mm pressure range 0-3 / 0-15bar connection on the backside thread 1/8"		

1 

Part No.	541720	Ref. No.	202270
description	manometer double scale ø 63mm pressure range 0-3 / 0-15bar connection on the backside thread 1/8"		

1 

Part No.	541221	Ref. No.	14-065
description	manometer ø 50mm pressure range 0 up to 3bar thread 1/4" marking 1-1.25 connection on the backside		

hoses

industrial hoses

hoses wire reinforced

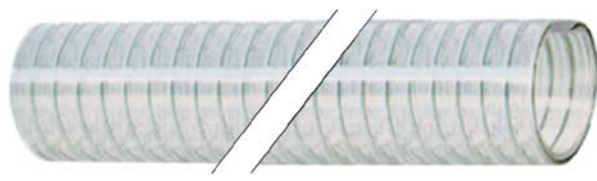

1 

Part No.	520035	Ref. No.	1676
description	drain hose ID ø 14mm ED ø 20mm L 30m wire reinforced		

water softeners

manual softener

1 

Part No.	520130	Ref. No.	800015	
description	lid type DVA BP complete for softener			
spare parts for	520130			
	Part No.	520131	Ref. No.	—
	O-ring ID ø 77mm thickness 6.5mm suitable for type LT/BP			
	Part No.	530803	Ref. No.	—
	lid handle			

fastening material

screws

flat-headed bolts

1 

Part No.	526922	Ref. No.	204061
description	flat-headed bolt thread M5 thread L 10mm steel Qty 1 pcs intake slotted head ø 8mm head thickness 3mm		

hexagonal screws

1 

Part No.	560408	Ref. No.	204083
description	hexagonal screw thread M5 thread L 22mm SS WS 8 Qty 1 pcs head thickness 3.5mm DIN 933 / ISO 4017		





cylinder head bolts			
DIN 912/ISO 4762			
1			
Part No.	560373	Ref. No.	204074
description	cylinder head bolt thread M4 thread L 12mm WS 3 SS Qty 1 pcs intake internal hexagon DIN 912/ISO 4762		

1			
Part No.	560026	Ref. No.	23560
description	cylinder head bolt thread M4 thread L 16mm WS 3 SS Qty 20 pcs DIN 912/ISO 4762		

1			
Part No.	560315	Ref. No.	204056
description	cylinder head bolt thread M5 thread L 12mm WS 4 SS Qty 20 pcs DIN 912/ISO 4762		



miscellaneous			
1			
Part No.	526921	Ref. No.	204116
description	cylinder head bolt thread M4 thread L 10mm head ø 7mm zinc-coated steel Qty 1 pcs intake slotted head thickness 2.5mm		



grub screws			
DIN 913/ISO 4026			
1			
Part No.	560407	Ref. No.	204315
description	grub screw thread M4 L 10mm stainless steel DIN 913 WS 2 Qty 1 pcs		



nuts			
hexagonal nuts			
hexagonal nuts metric (without norm)			
1			
Part No.	526982	Ref. No.	205123
description	hexagonal nut thread M18x1.5 H 6mm WS 26 Qty 1 pcs		

1			
Part No.	526983	Ref. No.	205007
description	hexagonal nut thread M25 H 6mm WS 27 brass Qty 1 pcs		

washers			
tooth lock washers			
DIN 6798A			
1			
Part No.	560126	Ref. No.	204032
description	tooth lock washer ID ø 5.2mm ED ø 10mm SS DIN/ISO DIN 6798A Qty 20 pcs for thread M5		

fasteners			
retaining rings			
DIN 6799			
1			
Part No.	529724	Ref. No.	204320
description	retaining ring E D1 ø 4mm D2 ø 9mm SS DIN 6799 thickness 0.7mm for shaft ø 4-5mm		

1			
Part No.	528709	Ref. No.	204017
description	retaining ring E D1 ø 4mm D2 ø 9mm steel DIN 6799 thickness 0.7mm for shaft ø 5-7mm		

1			
Part No.	691470	Ref. No.	204316
description	retaining ring E D1 ø 8mm D2 ø 16mm SS DIN 6799 thickness 1mm for shaft ø 9-12mm		



consumables

fuses

fine fuses



1

Part No.	358687	Ref. No.	1248
description	fine fuse size ø5x20mm 0.5A medium lag rated 250V Qty 10 pcs		

GASTROPARTS.COM

