



GASTROPARTS

La Cimbali

- [EN]** Equipment
- [DE]** Geräte
- [ES]** Aparatos
- [FR]** Équipement
- [IT]** Attrezzature
- [PL]** Urządzenia
- [RU]** Оборудование

✉ gastroparts@gastroparts.com

☎ +48 56 657 00 66

📘 fb.com/gastroparts.global



GASTROPARTS.COM











heating elements

heating elements for coffee machine



 <p>1</p>			
Part No.	417014	Ref. No.	442-501-005 442-766-000
description	heating element 1300W 230V heating circuits 1 hole distance 59mm L 185mm W 40mm H 18mm hole ø 9mm tube ø 8.5mm connection male faston 6.3mm immersion heater 3 hole flange suitable for CIMBALI		
accessories for	417014		
	Part No.	529484	Ref. No. 401-194-010
	 flat gasket fibre ED ø 58mm ID ø 50mm thickness 2mm Qty 1 pcs		

 <p>1</p>			
Part No.	417011	Ref. No.	421-601-010 421601020 421-610-000 537-011-400 537-011-500 537-013-700
description	heating element 1800W 230V heating circuits 3 hole distance 59mm L 170mm W 34mm H 35mm hole ø 9.7mm thermostat sleeves ø 7mm length thermostat sleeves 170mm number of thermostat sleeves 1 thermostat sleeve eccentric, non clinging tube ø 8.5mm connection male faston 6.3mm immersion heater 3 hole flange suitable for CIMBALI		
accessories for	417011		
	Part No.	528002	Ref. No. —
	 flat gasket PTFE ED ø 57mm ID ø 42mm thickness 3mm Qty 1 pcs equiv. no. 12001/W10470 suitable for		
	Part No.	528488	Ref. No. —
	 flat gasket fibre ED ø 57mm ID ø 42mm thickness 3mm Qty 1 pcs		

 <p>1</p>			
Part No.	417015	Ref. No.	N/A
description	heating element 2700W 230V heating circuits 1 mounting ø 54mm hole distance 55mm L 232mm W 35mm H 43mm hole ø 9mm thermostat sleeves ø 7mm length thermostat sleeves 230/240mm number of thermostat sleeves 2 thermostat sleeve not clinging tube ø 8.5mm connection M6x1 immersion heater 4 hole flange suitable for CIMBALI		
accessories for	417015		
	Part No.	529496	Ref. No. N/A
	 gasket fibre D1 ø 54mm D2 ø 98mm thickness 3mm hole ø 6.7mm hole distance 55mm for heating element suitable for CIMBALI M15		

 <p>1</p>			
Part No.	417013	Ref. No.	489-533-020 489-553-010 489-553-020 537-013-000 537-013-100
description	heating element 2850W 230/400V heating circuits 3 hole distance 59mm L 320mm W 27mm H 35mm hole ø 9mm tube ø 8.5mm connection male faston 6.3mm immersion heater 3 hole flange suitable for CIMBALI		



 <p>1</p>			
Part No.	419158	Ref. No.	476-513-030
description	heating element 3750-4500W 220-240V heating circuits 3 hole distance 59mm L 380mm W 36mm H 37mm hole ø 9mm thermostat sleeves ø 6mm length thermostat sleeves 150mm number of thermostat sleeves 1 tube ø 8.4mm connection male faston 6.3mm immersion heater 3 hole flange suitable for CIMBALI		
accessories for	419158		
	Part No.	529484	Ref. No. 401-194-010
	 flat gasket fibre ED ø 58mm ID ø 50mm thickness 2mm Qty 1 pcs		



 <p>1</p>			
Part No.	417012	Ref. No.	476-513-020 537-011-600 537-012-100
description	heating element 3750W 220V heating circuits 3 hole distance 59mm L 315mm W 35mm H 41mm hole ø 9mm tube ø 8.1mm connection male faston 6.3mm immersion heater 3 hole flange suitable for CIMBALI		
accessories for	417012		
	Part No.	528002	Ref. No. —
	 flat gasket PTFE ED ø 57mm ID ø 42mm thickness 3mm Qty 1 pcs equiv. no. 12001/W10470 suitable for		
	Part No.	528488	Ref. No. —
	 flat gasket fibre ED ø 57mm ID ø 42mm thickness 3mm Qty 1 pcs		

 <p>1</p>			
Part No.	420337	Ref. No.	802140217 984142000
description	heating element 3990W 230V heating circuits 3 mounting ø 40mm hole distance 59mm L 300mm W 31mm H 25mm hole ø 11mm length thermostat sleeves 210mm thermostat sleeves ø 7mm number of thermostat sleeves 1 thermostat sleeve eccentric, clinging tube ø 6.3mm connection male faston 6.3mm immersion heater 3 hole flange		

1 electric components





			
1			
Part No.	417202	Ref. No.	911544000 911544010
description	heating element 4000W 230V heating circuits 3 mounting ϕ 42mm hole distance 74mm L 295mm W 34mm H 63mm L1 30mm L2 70mm L3 190mm H1 31mm H2 32mm hole ϕ 9mm tube ϕ 8.5mm thermostat sleeves ϕ 6.5mm length thermostat sleeves 199mm thermostat sleeve not clinging number of thermostat sleeves 1 connection male faston 6.3mm immersion heater 2 hole flange		
accessories for	417202		
	Part No.	528022	Ref. No. —
	flat gasket PTFE ED ϕ 52mm ID ϕ 41mm thickness 2mm size 1 1/4" Qty 1 pcs suitable for CARIMALI, FAEMA, MARZOCCO, PAVONI		
	Part No.	528488	Ref. No. —
	flat gasket fibre ED ϕ 57mm ID ϕ 42mm thickness 3mm Qty 1 pcs		

			
1			
Part No.	417098	Ref. No.	N/A
description	heating element 5000W 220/380V heating circuits 3 hole distance 55mm L 355mm W 33mm H 33mm hole ϕ 9mm thermostat sleeves ϕ 6.5mm length thermostat sleeves 230/240mm number of thermostat sleeves 1 connection M6x1 immersion heater 4 hole fixing		
accessories for	417098		
	Part No.	528005	Ref. No. —
	gasket fibre D1 ϕ 96mm D2 ϕ 56mm thickness 3.5mm hole ϕ 9mm hole distance 54mm		
	Part No.	529496	Ref. No. N/A
	gasket fibre D1 ϕ 54mm D2 ϕ 98mm thickness 3mm hole ϕ 6.7mm hole distance 55mm for heating element suitable for CIMBALI M15		

			
1			
Part No.	417099	Ref. No.	423504020 477-512-020 477512030 537-011-700 537-012-500
description	heating element 5790W 230V heating circuits 3 hole distance 59mm L 577mm W 35mm H 34mm hole ϕ 9.7mm thermostat sleeves ϕ 7mm length thermostat sleeves 170mm number of thermostat sleeves 1 thermostat sleeve not clinging tube ϕ 8mm connection male faston 6.3mm immersion heater 3 hole flange suitable for CIMBALI		

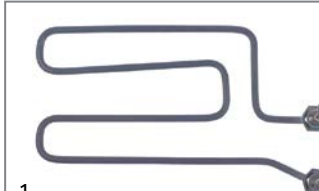
immersion heating elements

			
1			
Part No.	418881	Ref. No.	802041007 984-087-000
description	heating element 2000W 230V heating circuits 1 L 245mm W 120mm H 25mm thread M12x1 mounting distance 45mm tube ϕ 6.3mm connection male faston 6.3mm 2 hole fixing connection length 25mm immersion heater tank		
accessories for	418881		
	Part No.	504512	Ref. No. —
	O-ring EPDM thickness 1.78mm ID ϕ 14mm Qty 1 pcs		

accessories

sealing washers

fibre gaskets

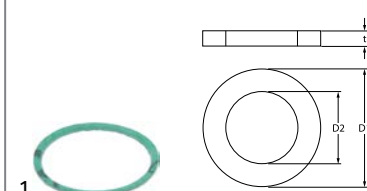
			
1			
Part No.	529484	Ref. No.	401-194-010
description	flat gasket fibre ED ϕ 58mm ID ϕ 50mm thickness 2mm Qty 1 pcs		

PTFE gaskets

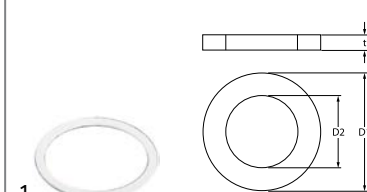
			
1			
Part No.	528004	Ref. No.	N/A
description	flat gasket PTFE ED ϕ 58mm ID ϕ 50mm thickness 2mm Qty 1 pcs suitable for CIMBALI		

O-rings

			
1			
Part No.	550496	Ref. No.	401-178-002 401-178-012 402-226-000
description	O-ring Viton thickness 3.53mm ID ϕ 50.39mm Qty 1 pcs		



1

Part No.	510245	Ref. No.	401-178-002
description	O-ring Viton thickness 3.53mm ID ø 50.8mm Qty 1 pcs		

flange gaskets

1

Part No.	529496	Ref. No.	N/A
description	gasket fibre D1 ø 54mm D2 ø 98mm thickness 3mm hole ø 6.7mm hole distance 55mm for heating element suitable for CIMBALI M15		

thermostats

bi-metal thermostats

bi-metal thermostats

1

Part No.	390503	Ref. No.	531101700
description	bi-metal thermostat hole distance 23.5mm switch-off temp. 135°C 1NC 1-pole 10A connection F6.3 2 hole fixing		

control and safety thermostats

EGO

safety thermostats

55.32_ series

1

Part No.	390324	Ref. No.	531-193-100
description	safety thermostat switch-off temp. 169°C 3-pole 3NC 20A probe ø 4mm probe L 128mm capillary pipe 890mm capillary pipe isolated 210/210mm gland nut probe SS		

switches and momentary switches

microswitches

roller-lever actuated

with mounting components

1

Part No.	346876	Ref. No.	819-410-208
description	microswitch with handle with a switch 250V 16A 1CO connection male faston L 35mm L1 28mm ambient temperature max. 125°C mounting distance 22mm type V-166-1CR5 actuating force: 86g		

pin-plunger actuated

1

Part No.	344000	Ref. No.	532020000
description	microswitch with plunger 250V 15A 1CO connection male faston 6.3mm ambient temperature max. 105°C mounting distance 22mm actuating force: 340g white		

non-standard

1

Part No.	347165	Ref. No.	802-041-002 802-131-735
description	microswitch complete incl. holder mounting distance 49mm 250V 16A 1NO connection male faston 6.3mm ambient temperature max. 125°C with plunger door contact switch actuating force: 140g 1-pole		

rotary switches

BREMAS

A1700 series

1

Part No.	345149	Ref. No.	VG617500
description	rotary switch 3 0-1-2 sets of contacts 8 type CS0177121 400V 20A shaft ø 5x5mm shaft L 20mm shaft square connection screw		

			
1			
Part No.	347879	Ref. No.	532005800
description	rotary switch 4 0-1-2-3 sets of contacts 4 type CS0176874 400V 16A shaft ø 5x5mm shaft L 21mm shaft square connection screw		



miscellaneous			
			
1			
Part No.	346184	Ref. No.	532-004-300
description	rotary switch 0-1 type 80947-3 690V 16A shaft ø 5x5mm shaft L 22mm shaft square connection male faston 6.3mm 2 operating positions		

touch sensitive light switches			
			
1			
Part No.	401950	Ref. No.	537035208
description	touch sensitive light switch		

lamps			
indicator lights			
indicator light lenses			
ø12mm (type SDY-3)			
			
1			
Part No.	359261	Ref. No.	530-106-200 530-106-400
description	indicator light housings mounting measurements ø12mm red round Qty 1 pcs		

timers			
programme timers			
			
1			
Part No.	360706	Ref. No.	802-140-010
description	timer CDC 4804M1 engines 1 chambers 4 operation time 120s 230V shaft ømm shaft Lmm manuf. no. 4804M10ADE000.1000		

relays			
power relays			
with bracket mounting			
			
1			
Part No.	380403	Ref. No.	3442-133-670 537-020-300
description	power relays FINDER 230VAC 16A 3CO connection F6.3 bracket mounting manuf. no. 62.83.8.230.0500		

electronics			
PCBs			
			
1			
Part No.	403440	Ref. No.	952846010
description	PCB coffee machine		
			
1			
Part No.	401299	Ref. No.	918910008
description	PCB FAEMA series E97, E98 NA32		



keypads

membrane keypads

1 

Part No.	401657	Ref. No.	445005000
description	membrane keypad buttons 5		

1 

Part No.	403252	Ref. No.	422292000
description	membrane keypad espresso machine buttons 5 black suitable for M22 L 132mm W 32mm		

solenoid valves

solenoid valves (water)



metal

LUCIFER

2-way

7121ZBG series

1 

Part No.	370594 ¹	Ref. No.	533-798-310	
description	solenoid valve 2-ways 230VAC connection 1/8" L 30mm DN 2.5mm slide-on receptacle DIN -10 up to 140°C PARKER type series 7121ZBG coil type 483510S6 XS03XS6 F membranes FKM (water/steam) p max 10bar p min 0bar nickel-plated brass			
spare parts for	370594			
	Part No.	371031	Ref. No.	—
	solenoid coil LUCIFER-PARKER 230VAC 9VA coil type DZ06S6 seat ø 15mm			
accessories for	370594			
	Part No.	371090	Ref. No.	—
	power socket plug type DIN 43650A screw			

¹nickel-plated





3-way

131F series





1 

Part No.	370053	Ref. No.	533-795-610 533795610R	
description	solenoid valve 3-ways 230VAC DN 2.5mm slide-on receptacle DIN -10 up to 140°C type series 131F coil type DZ06S6 membranes FKM (water/steam) p max 10bar flange 32x32mm			
spare parts for	370053			
	Part No.	370061	Ref. No.	CI0101
	solenoid valve body LUCIFER-PARKER 3-ways outer cone			

spare parts for 370053

	Part No.	371031	Ref. No.	—
	solenoid coil LUCIFER-PARKER 230VAC 9VA coil type DZ06S6 seat ø 15mm			
accessories for	370053			
	Part No.	371090	Ref. No.	—
	power socket plug type DIN 43650A screw			
	Part No.	371095	Ref. No.	—
	O-ring Viton thickness 1.78mm ID ø 6.07mm Qty 1 pcs			
	Part No.	371100	Ref. No.	—
	O-ring silicone thickness 1.78mm ID ø 6.07mm Qty 1 pcs			

1 

Part No.	370054	Ref. No.	484074000	
description	solenoid valve 3-ways 24VAC DN 2.5mm slide-on receptacle DIN -10 up to 140°C type series 131F coil type DZ06P0 membranes FKM (water/steam) p max 10bar flange 32x32mm			
spare parts for	370054			
	Part No.	370061	Ref. No.	CI0101
	solenoid valve body LUCIFER-PARKER 3-ways outer cone			
	Part No.	371032	Ref. No.	—
	solenoid coil LUCIFER-PARKER 24VAC 9VA 50/60Hz coil type DZ06P0 seat ø 15mm			
accessories for	370054			
	Part No.	371090	Ref. No.	—
	power socket plug type DIN 43650A screw			
	Part No.	371095	Ref. No.	—
	O-ring Viton thickness 1.78mm ID ø 6.07mm Qty 1 pcs			
	Part No.	371100	Ref. No.	—
	O-ring silicone thickness 1.78mm ID ø 6.07mm Qty 1 pcs			

131K series

1 



Part No.	370223	Ref. No.	533895400 533895400R	
description	solenoid valve 3-ways 230VAC connection 1/4" DN 2.5mm slide-on receptacle DIN -10 up to 140°C LUCIFER-PARKER type series 131K coil type DZ06S6 membranes ruby p max 10bar 50/60Hz			
spare parts for	370223			
	Part No.	371031	Ref. No.	—
	solenoid coil LUCIFER-PARKER 230VAC 9VA coil type DZ06S6 seat ø 15mm			

Table continues overleaf



accessories for	370223			
	Part No.	371090	Ref. No.	—
	power socket plug type DIN 43650A screw			

spare parts and accessories





valve bodies

	1		
Part No.	370061	Ref. No.	CI0101
description	solenoid valve body LUCIFER-PARKER 3-ways outer cone		

PARKER

spare parts and accessories

valve bodies



	1			
Part No.	370062	Ref. No.	CI0101	
description	solenoid valve body PARKER 3-ways outer cone			
accessories for	370062			
	Part No.	371029	Ref. No.	—
	solenoid coil PARKER 230VAC 9VA coil type ZB09 seat ø 14mm H 33mm W 34mm D 43mm			
	Part No.	371030	Ref. No.	—
	solenoid coil 24VDC 12VA coil type ZB12 seat ø 14mm			
	Part No.	371033	Ref. No.	—
	solenoid coil PARKER 230VAC 9VA coil type YB09 with cable seat ø 14mm			
	Part No.	371036	Ref. No.	—
	solenoid coil 24VAC 9VA coil type ZB09 seat ø 14mm			
	Part No.	371095	Ref. No.	—
	O-ring Viton thickness 1.78mm ID ø 6.07mm Qty 1 pcs			
	Part No.	371100	Ref. No.	—
	O-ring silicone thickness 1.78mm ID ø 6.07mm Qty 1 pcs			

pressure switches

for coffee machines

miscellaneous

	1		
Part No.	541157	Ref. No.	537030700
description	pressure control		

	1			
Part No.	541021	Ref. No.	CI0701	
description	pressure control pressure range adjustable 0.5-1.4bar connection 1/4" 30A 3-pole type P302 coffee machine parts SIRAI			
accessories for	541021			
	Part No.	550262	Ref. No.	—
	flat gasket copper ED ø 20mm ID ø 14mm thickness 2mm			
	Part No.	890100	Ref. No.	—
	PTFE tape reel L 12m W 12mm -200 up to +260°C approval DINDVGW, KTW temperature-resistant, elastic for fine thread thickness 0.1mm			

electrodes

	1		
Part No.	401952	Ref. No.	537024900
description	level electrode M10 total length 125mm		



flow meters and flow sensors

flow meters

GICAR



1

Part No.	403410	Ref. No.	534391800 534392300 534393100
description	flow controller thread 1/4" stainless steel coded approval NSF		

DIGMESA



1

Part No.	402989	Ref. No.	534391020 534392400
description	flow controller thread 1/4" brass male faston 2.8mm approval NSF reducer ø 1mm		

motors

gear motors

for automatic coffee machines



1

Part No.	500935	Ref. No.	484603000 537046100
description	gear motor CROUZET type 82861080 24V 5000rpm shaft ø 4mm L 65mm W 51mm H 61mm for outlet		

1

Part No.	601607	Ref. No.	084518 819440059 N/A
description	motor 8W 230V voltage AC 50/60Hz 50/60rpm shaft ø 4mm L 70mm W 60mm H 110mm		

pumps

booster pumps II

pump motors

clip connection



1

Part No.	500442	Ref. No.	530-290-800 530291000 530296900
description	motor RPM type 11002708 165W 230V 50/60Hz connection clip capacitor 10µF shaft ø 13mm		

pump heads

FLUID-O-TECH





1

Part No.	501499	Ref. No.	537048400 537048500
description	pump head FLUID-O-TECH 180l/h connection 3/8" GAS		





			
1			
Part No.	500177	Ref. No.	533180100 533-196-900
description	pump head PA204X FLUID-O-TECH L 82mm 200l/h connection 3/8\" GAS with filter an bypass brass clip connection for coffee machine shaft ø 4.8x11mm		

			
1			
Part No.	500064	Ref. No.	533-197-300
description	pump head PO204 FLUID-O-TECH L 82mm 200l/h connection 3/8\" GAS with bypass brass clip connection for coffee machine shaft ø 4.8x11mm		
accessories for	500064		
	Part No.	520126	Ref. No. —
clamp for pump/motor			





PROCON

			
1			
Part No.	500934	Ref. No.	533197100
description	pump PROCON L 82mm 100l/h connection 3/8\" NPT with filter brass clip connection for coffee machine shaft ø 4.8x11mm NSF		

			
1			
Part No.	500293	Ref. No.	N/A
description	pump head T1039 PROCON L 82mm 180l/h connection 3/8\" NPT with bypass brass 3 hole flange for coffee machine shaft ø 3.5x7.5mm		

			
1			
Part No.	500290	Ref. No.	M31 Bistro
description	pump head V3797 PROCON L 82mm 100l/h connection 3/8\" NPT with bypass brass clip connection for coffee machine shaft ø 4.8x11mm		

vibration pumps

			
1			
Part No.	500123	Ref. No.	442-544-002
description	vibration pump type 1106PAALM1N 230V 50Hz 70W inlet ø 1/8\" IT outlet ø 1/8\" IT outlet conical L 129mm FLUID-O-TECH		
accessories for	500123		
	Part No.	371090	Ref. No. —
power socket plug type DIN 43650A screw			
	Part No.	371120	Ref. No. —
diode type IN5408			
	Part No.	390698	Ref. No. —
thermal fuse switch-off temp. 110°C suitable for ULKA pump			

pumps for milk foamers

pumps

			
1			
Part No.	500933	Ref. No.	533198600
description	pump		



electric accessories

cables

accessories

cable glands

cable glands

			
1			
Part No.	550310	Ref. No.	532-123-500
description	cable gland ID ø 5mm mounting ø 7mm ED ø 11mm Neoprene -30 up to +90°C Qty 10 pcs		



equipment-specific units





for espresso machines

filter holders



filter holders standard

filter holders (complete)

			
1			
Part No.	529243	Ref. No.	N/A
description	filter holder 1-way suitable for without spring and filter ID ø 61mm outlet distance 6mm		
accessories for	529243		
	Part No.	529017	Ref. No. N/A
	coffee filter ø 68mm mounting ø 59.5mm H 22mm cups 1 amount of coffee 7g		
	Part No.	529018	Ref. No. N/A
	coffee filter ø 68mm mounting ø 60mm H 18mm cups 1 amount of coffee 6g		
	Part No.	529265	Ref. No. —
	filter holder spring L 70mm W 62mm wire gauge ø 1.2mm for espresso filter holder		
	Part No.	529266	Ref. No. —
	filter holder spring L 70mm W 62mm wire gauge ø 1.1mm for espresso filter holder		

			
1			
Part No.	529244	Ref. No.	N/A
description	filter holder 2-way suitable for without spring and filter ID ø 61mm outlet distance 45mm		
accessories for	529244		
	Part No.	529019	Ref. No. N/A
	coffee filter ø 68mm mounting ø 60mm H 25mm cups 2 amount of coffee 14g		
	Part No.	529020	Ref. No. N/A
	coffee filter ø 68mm mounting ø 60mm H 22mm cups 2 amount of coffee 12g		
	Part No.	529265	Ref. No. —
	filter holder spring L 70mm W 62mm wire gauge ø 1.2mm for espresso filter holder		
	Part No.	529266	Ref. No. —
	filter holder spring L 70mm W 62mm wire gauge ø 1.1mm for espresso filter holder		

filter holder without spout

			
1			
Part No.	525980	Ref. No.	N/A
description	filter holder suitable for CIMBALI without outlet mounting ø 81.4mm hole ø 7mm ID ø 61.5mm wedge height 13mm wedge position horizontal number of wedges 2 lever inclined		
			
1			
Part No.	525981	Ref. No.	N/A
description	filter holder suitable for CIMBALI without outlet mounting ø 81mm outlet 3/8" ID ø 61mm wedge height 12mm wedge position horizontal number of wedges 2 lever inclined		



filter holders short



1

Part No.	529155	Ref. No.	N/A
-----------------	--------	-----------------	-----

description	filter holder
--------------------	---------------



1

Part No.	529245	Ref. No.	N/A
-----------------	--------	-----------------	-----

description	filter holder mounting \varnothing 81.2mm outlet M16x1 ID \varnothing 60.5mm handle M10x1.5 wedge height 12.5mm wedge position horizontal number of wedges 2 lever inclined chrome-plated brass
--------------------	---



1

Part No.	529051	Ref. No.	458-159-007
-----------------	--------	-----------------	-------------

description	filter holder mounting \varnothing 81.4mm hole \varnothing 7mm outlet ID \varnothing 61.5mm handle M10x1.5 wedge height 13mm wedge position horizontal number of wedges 2 lever inclined
--------------------	--



1

Part No.	530470	Ref. No.	458189007 537027420
-----------------	--------	-----------------	------------------------

description	filter holder mounting \varnothing 81mm hole \varnothing 7mm outlet ID \varnothing 58mm wedge height 7mm wedge position horizontal number of wedges 2 lever inclined chrome-plated brass
--------------------	--



1

Part No.	530471	Ref. No.	457-239-007 458-159-027
-----------------	--------	-----------------	----------------------------

description	filter holder mounting \varnothing 81mm hole \varnothing 7mm outlet ID \varnothing 58mm wedge height 7mm wedge position horizontal number of wedges 2 lever inclined chrome-plated brass
--------------------	--



1

Part No.	529052	Ref. No.	457-305-007
-----------------	--------	-----------------	-------------

description	filter holder mounting \varnothing 81mm outlet 3/8" ID \varnothing 61mm handle M10x1.5 wedge height 12mm wedge position horizontal number of wedges 2 lever inclined chrome-plated brass
--------------------	--



1

Part No.	529154	Ref. No.	406-10-000
-----------------	--------	-----------------	------------

description	filter holder mounting \varnothing 82mm hole \varnothing 7mm ID \varnothing 61mm handle M10x1.5 wedge height 12.5mm wedge position diagonal number of wedges 2 lever straight chrome-plated brass
--------------------	---

handles

with external thread



1

Part No.	529248	Ref. No.	537-021-900
-----------------	--------	-----------------	-------------

description	handle \varnothing 37mm thread M10x1.5 thread L 11mm L 127mm black
--------------------	--

spouts

with thread 3/8"



1

Part No.	529003	Ref. No.	N/A
-----------------	--------	-----------------	-----

description	filter holder spout thread 3/8" 1-way curved/long outlet distance thread L 5mm
--------------------	--



1

Part No.	529007	Ref. No.	N/A
-----------------	--------	-----------------	-----

description	filter holder spout thread 3/8" 2-way curved/short outlet distance 45mm
--------------------	---

with thread M16x1





1

Part No.	529246	Ref. No.	N/A
-----------------	--------	-----------------	-----

description	filter holder spout thread M16x1 1-way curved/long outlet distance
--------------------	--



			
1			
Part No.	529247	Ref. No.	N/A
description	filter holder spout thread M16x1 2-way curved/short outlet distance 45mm		

without thread			
			
1			
Part No.	529009	Ref. No.	N/A
description	filter holder spout 1-way outlet distance 45mm		

			
1			
Part No.	529010	Ref. No.	N/A
description	filter holder spout 2-way outlet distance 40mm cups 2		

filters			
for 1 cup			
			
1			
Part No.	529017	Ref. No.	N/A
description	coffee filter ø 68mm mounting ø 59.5mm H 22mm cups 1 amount of coffee 7g		

			
1			
Part No.	529018	Ref. No.	N/A
description	coffee filter ø 68mm mounting ø 60mm H 18mm cups 1 amount of coffee 6g		

			
1			
Part No.	531277	Ref. No.	457-232-000
description	coffee filter ø 69mm mounting ø 60mm H 18mm cups 1 amount of coffee 6g stainless steel		

for 2 cups			
			
1			
Part No.	529020	Ref. No.	N/A
description	coffee filter ø 68mm mounting ø 60mm H 22mm cups 2 amount of coffee 12g		

			
1			
Part No.	531278	Ref. No.	457-164-000 458-171-000
description	coffee filter ø 68mm mounting ø 60mm H 25.5mm cups 2 amount of coffee 14g		

			
1			
Part No.	529019	Ref. No.	N/A
description	coffee filter ø 68mm mounting ø 60mm H 25mm cups 2 amount of coffee 14g		

			
1			
Part No.	531279	Ref. No.	457-233-000
description	coffee filter ø 69mm mounting ø 60mm H 22mm cups 2 amount of coffee 12g		

brewing units			
shower screens			
flat			
			
1			
Part No.	529084	Ref. No.	457504000
description	shower screen ø 52mm hole ø 6.4mm		



with upstand



1

Part No.	531275	Ref. No.	457560000
description	shower screen ø 58mm H 19mm		

screws



1

Part No.	560375	Ref. No.	503-705-200
description	countersunk screw thread M5 L 12mm SS DIN 963/ISO 2009 Qty 1 pcs intake slotted head ø 9mm old edition		

filter holder gaskets

flat

standard



1

Part No.	528035	Ref. No.	400-181-010
description	filter holder gasket D1 ø 71mm D2 ø 56.5mm H 8.5mm Qty 1 pcs		

with cone



1

Part No.	528036	Ref. No.	401-261-000 401-261-010
description	filter holder gasket with cone D1 ø 70.5mm D2 ø 56mm H1 8.9mm H2 5.8mm Qty 1 pcs		

components

nozzles

without thread



1

Part No.	527570	Ref. No.	931720000
description	nozzle bore ø 1.5mm L 33mm		

safety valves

safety valves

1/4"



1

Part No.	529307	Ref. No.	N/A
description	safety valve connection 1/4" triggering pressure 1.8bar		

drain valves



1

Part No.	530463	Ref. No.	419077000
description	drain fitting perforation ø 5mm		

aerators and air bleeders



1

Part No.	525329	Ref. No.	418911010 418941000 418941010 537-040-300
description	aerator and air bleeder connection 1/4" for boiler suitable for CIMBALI, FAEMA		



1

Part No.	529304	Ref. No.	418-911-002
description	aerator and air bleeder screw connection 1/4"		

boilers

heat exchangers

heat exchangers



1

Part No.	525635	Ref. No.	457-177-002 457-177-008
description	heat exchanger ø 42mm L 150mm for CIMBALI		



1



Part No.	525636	Ref. No.	457177005 457-177-006
description	heat exchanger ø 42mm L 210mm for CIMBALI		

steam/water taps

steam/water taps

steam taps

bodies

1



Part No.	530906	Ref. No.	485605000 485605010
description	tap body for M39 steam T1: 1/4" T2: 3/8" L 100mm		

components

gaskets

1



Part No.	529546	Ref. No.	400-274 010 400-274 020
description	gasket D1 ø 12mm D2 ø 4mm thickness 4mm Viton Qty 1 pcs		

1



Part No.	529539	Ref. No.	N/A
description	gasket D1 ø 15mm D2 ø 7mm thickness 4mm coffee machine		

tap bodies

1



Part No.	530547	Ref. No.	958572000 958572010
description	tap body T1: 1/4" T2: 3/8" L 99mm		

screws

1



Part No.	525350	Ref. No.	590791010
description	screw for water tap thread M4		

valve bodies

1



Part No.	525363	Ref. No.	485751000 485751010 485910010
description	valve body for steam-/water-tap		

steam/water pipes

steam pipes

1



Part No.	529887	Ref. No.	485-524-000 485612000 485612010
description	steam pipe		

1



Part No.	529885	Ref. No.	485949020 485949030 485949040 485949050
description	steam pipe IT 3/8"		



nozzles for water pipes

tap aerators



1

Part No.	529886	Ref. No.	4771134699 532305000
description	tap aerator D1 ø 19mm H 13mm		

level glasses

level glasses

gaskets



1

Part No.	529427	Ref. No.	400-275-000 400275010
description	gasket D1 ø 13mm D2 ø 17.5mm ID ø 11mm H 9mm rubber water level glass suitable for PAVONI		

pressure rings



1

Part No.	529547	Ref. No.	419-072-000
description	press ring ID ø 9/11mm H 3.5mm thickness 1.3mm		

housings



1

Part No.	525779	Ref. No.	4831132157
description	tray for water level tube plastic suitable for FAEMA		

level glasses



1

Part No.	529365	Ref. No.	4831130683
description	level glass L 89mm W 30mm thickness 3.5mm for water level tube polycarbonate		

pipes

pipes



1

Part No.	531142	Ref. No.	496937010
description	drain pipe ø 6mm L 170mm T1: 1/8" for espresso machine		

miscellaneous



1

Part No.	690738	Ref. No.	534193400
description	catch		



1

Part No.	530548	Ref. No.	533.001.200
description	level electrode ø 2.5mm L 154mm		

for coffee grinders

grinding burrs

grinding burrs straight

standard



1

Part No.	527223	Ref. No.	4801-116 730
description	grinding burrs pair turn direction right D1 ø 54mm ID ø 31mm H 8mm tooth spacing 3.5mm hole ø 4.5mm bore ø 6.5mm mounting ø 45 straight suitable for FAEMA (MP,MPN)		





			
1			
Part No.	527218	Ref. No.	N/A
description	grinding burrs pair turn direction right D1 ø 54mm ID ø 32mm H 9mm tooth spacing 3.5mm hole ø 6mm bore ø 8.5mm mounting ø 41 straight suitable for CIMBALI		

			
1			
Part No.	527219	Ref. No.	535-100-200
description	grinding burrs pair turn direction right D1 ø 64mm ID ø 37mm H 8.5mm tooth spacing 3mm hole ø 5.5mm bore ø 8.5mm mounting ø 50 straight suitable for DRM, CIMBALI		



			
1			
Part No.	527220	Ref. No.	803-130-050
description	grinding burrs pair turn direction right D1 ø 68mm ID ø 43mm H 8mm tooth spacing 5mm hole ø 5mm bore ø 8mm mounting ø 54 straight suitable for DRM, CIMBALI		



spillage trays			
			
1			
Part No.	531195	Ref. No.	4529-134-772
description	drain tray L 157mm W 159mm suitable for CIMBALI		

dosing containers			
automatic grinding			
automatic grinding			
			
1			
Part No.	698757	Ref. No.	4529-133-522
description	housing for microswitch H 26mm L 102mm		
accessories for	698757		
			
Part No.	698756	Ref. No.	4529133521 800-133-521
description	lid for microswitch H 20mm		

			
1			
Part No.	698756	Ref. No.	4529133521 800-133-521
description	lid for microswitch H 20mm		

for cup coffee machines

coffee spouts			
coffee spouts			
			
1			
Part No.	527568	Ref. No.	431320020 431320030
description	coffee spout suitable for CIMBALI		
accessories for	527568		
			
Part No.	527569	Ref. No.	431321000 931764000
description	lid set for outlet		

			
1			
Part No.	527569	Ref. No.	431321000 931764000
description	lid set for outlet		
accessories for	527569		
			
Part No.	527568	Ref. No.	431320020 431320030
description	coffee spout suitable for CIMBALI		



for dishwashers

washing and rinsing systems



1

Part No.	510194	Ref. No.	984219000
description	swirl		

knobs

producer-specific knobs

CIMBALI



1

Part No.	112005	Ref. No.	421-920-002
description	knob switch zero mark t.max.°C°C ø 45mm shaft ø 5x5mm shaft flat black		
accessories for	112005		
	Part No.	112006	Ref. No. 544-400-230
	knob spring L 8.8mm W 5mm H 7.7mm		

accessories

button springs



1

Part No.	111062	Ref. No.	544-400-270
description	knob spring L 20mm W 10mm H 11.5mm		



1

Part No.	112006	Ref. No.	544-400-230
description	knob spring L 8.8mm W 5mm H 7.7mm		

handles and hand wheels

lever handles



1

Part No.	112859	Ref. No.	911564000SX 911564010
description	slide mounting pos. left		



1

Part No.	111450	Ref. No.	911563000DX
description	slide mounting pos. right		

gaskets

O-rings

EPDM



1

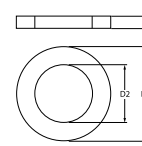

Part No.	510177	Ref. No.	402-223-000
description	O-ring EPDM thickness 1.78mm ID ø 7.66mm Qty 1 pcs		



1

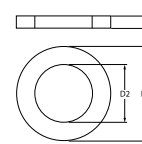

Part No.	529412	Ref. No.	400-279 000
description	O-ring EPDM thickness 2.62mm ID ø 10.78mm Qty 1 pcs		

Viton



1

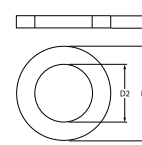

Part No.	532414	Ref. No.	402-209-000
description	O-ring Viton thickness 1.78mm ID ø 10.82mm Qty 10 pcs		

1

Part No.	528687	Ref. No.	402250000
description	O-ring Viton thickness 1.78mm ID ø 3.69mm Qty 1 pcs		

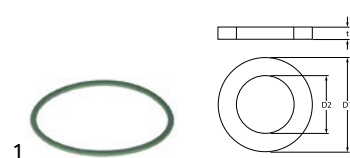

1

Part No.	532524	Ref. No.	402241000
description	O-ring Viton thickness 1.78mm ID ø 35mm Qty 1 pcs		



1

Part No.	532408	Ref. No.	402249000
description	O-ring Viton thickness 1.78mm ID ø 5.28mm Qty 10 pcs		



1

Part No.	532426	Ref. No.	402197000
description	O-ring Viton thickness 2.62mm ID ø 9.13mm Qty 10 pcs		



1

Part No.	550496	Ref. No.	401-178-002 401-178-012 402-226-000
description	O-ring Viton thickness 3.53mm ID ø 50.39mm Qty 1 pcs		



1

Part No.	510245	Ref. No.	401-178-002
description	O-ring Viton thickness 3.53mm ID ø 50.8mm Qty 1 pcs		

sealing washers

fibre gaskets



1

Part No.	529484	Ref. No.	401-194-010
description	flat gasket fibre ED ø 58mm ID ø 50mm thickness 2mm Qty 1 pcs		

rubber gaskets

1

Part No.	698758	Ref. No.	400-182-000
description	flat gasket EPDM ED ø 60.5mm ID ø 48.5mm thickness 5mm		



1

Part No.	520390	Ref. No.	4701134698
description	flat gasket rubber ED ø 21mm ID ø 16mm thickness 2mm Qty 1 pcs		

PTFE gaskets



1

Part No.	525304	Ref. No.	401183000 401183010
description	flat gasket PTFE ED ø 22mm ID ø 17mm thickness 1.5mm Qty 1 pcs		



1

Part No.	528004	Ref. No.	N/A
description	flat gasket PTFE ED ø 58mm ID ø 50mm thickness 2mm Qty 1 pcs suitable for CIMBALI		

special gaskets

group gaskets



1

Part No.	528126	Ref. No.	N/A
description	group gasket D1 ø 94mm thickness 2mm		



miscellaneous



1			
Part No.	528092	Ref. No.	401-247-000
description	piston gasket ED ø 53mm ID ø 46mm		

springs

compression springs



1			
Part No.	530358	Ref. No.	430013010
description	compression spring ø 6.1mm L 15mm wire gauge ø 1.1mm		

manometers



1			
Part No.	541210	Ref. No.	N/A
description	manometer double scale ø 63mm pressure range 0-2.5 / 0-15bar connection on the backside thread 1/8"		



1			
Part No.	541211	Ref. No.	421-127-000
description	manometer double scale ø 63mm pressure range 0-2.5 / 0-15bar connection on the backside thread 1/8"		



1			
Part No.	541206	Ref. No.	3781-133-399
description	manometer ø 42mm pressure range 0 up to 16bar thread 1/8" marking 12 connection on the backside		



1			
Part No.	541213	Ref. No.	496-246-000
description	manometer ø 57mm pressure range 0 up to 15bar thread 1/8" marking 8-10 connection on the backside		



1			
Part No.	541212	Ref. No.	450-009-000 450-524-000 475-094-010 475-137-010
description	manometer ø 57mm pressure range 0 up to 2.5bar thread 1/8" connection on the backside		



1			
Part No.	541275	Ref. No.	N/A
description	manometer ø 57mm pressure range 0 up to 2.5bar thread 1/8" marking 1.6 connection on the backside		



1			
Part No.	541276	Ref. No.	N/A
description	manometer ø 57mm pressure range 0 up to 2.5bar thread 1/8" marking 1.6 connection on the backside		



1			
Part No.	525645	Ref. No.	445-029-000
description	manometer ø 57mm pressure range 0-16bar CARIMALI connection 1/8"		



 <p>1</p>			
Part No.	525644	Ref. No.	445-028-000
description	manometer ø 57mm pressure range 0-2.5bar without glass connection 1/8"		

dosing pumps

membrane dosing pumps

self-priming

various

 <p>1</p>			
Part No.	361015	Ref. No.	802-191-002 984125000
description	dosing pump membrane dosing pump rinse aid inlet 6x8mm outlet 4x6mm pressure connection ø 4x6mm suction connection ø 6x8mm		
spare parts for	361015		
	Part No.	Ref. No.	—
	361132		
	membrane dosing pump		
	Part No.	Ref. No.	—
	510298		
	lip valve dosing pump suitable for DB2/DS5		

hoses

supply hoses

stainless steel flexi hoses

universal hoses

 <p>1</p>			
Part No.	520611	Ref. No.	532302000
description	flex hose SS braid straight-straight DN6 connections 1/8" L 600mm approval DVGW operating p. 10bar test pressure 32bar burst p. 95bar		

industrial hoses

PTFE hoses

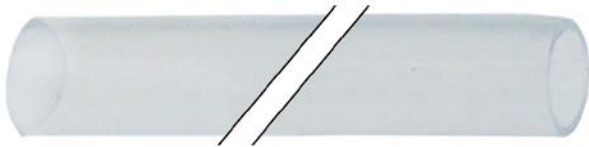
 <p>1</p>			
Part No.	520389	Ref. No.	220000021
description	PTFE hose ø 2x4mm L 2000mm		

silicone hoses

without fabric

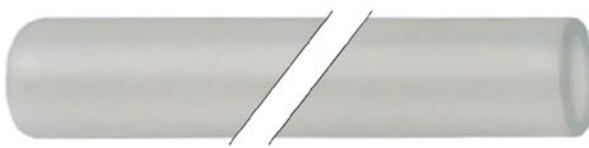
 <p>1</p>			
Part No.	520388	Ref. No.	484391000
description	silicone hose ID ø 5mm ED ø 8mm L 1m thickness 1.5mm operating pressure without pressure burst pressure non defined t.max. 200°C		

fittings, hose and pipe connectors

hose connectors

miscellaneous

 <p>1</p>			
Part No.	527571	Ref. No.	532652000
description	tube connector angled connection 4mm		

fastening material

screws

countersunk screws

 <p>1</p>			
Part No.	560375	Ref. No.	503-705-200
description	countersunk screw thread M5 L 12mm SS DIN 963/ISO 2009 Qty 1 pcs intake slotted head ø 9mm old edition		

flat-headed bolts

 <p>1</p>			
Part No.	560276	Ref. No.	503-405-140
description	flat-headed bolt thread M5 thread L 12mm SS DIN 84/ISO 1207 Qty 20 pcs intake slotted		



cylinder head bolts

DIN 912/ISO 4762

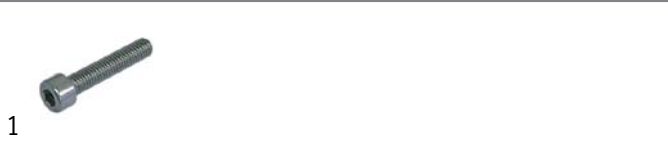

Part No.	560025	Ref. No.	4001051934 511804120
description	cylinder head bolt thread M4 thread L 10mm WS 3 SS Qty 20 pcs DIN 912/ISO 4762		

washers

washers

miscellaneous



Part No.	525307	Ref. No.	590715000
description	plain washer ID \varnothing 13mm ED \varnothing 22mm thickness 1.2mm SS Qty 1 pcs		

fasteners

retaining rings

DIN 472



Part No.	528518	Ref. No.	568-101 000
description	retaining ring bore \varnothing 22mm thickness 1.2mm steel DIN 472		

DIN 6799



Part No.	528709	Ref. No.	568204051
description	retaining ring E D1 \varnothing 4mm D2 \varnothing 9mm steel DIN 6799 thickness 0.7mm for shaft \varnothing 5-7mm		

GASTROPARTS.COM

