



GASTROPARTS

KSF

- [EN]** Equipment
- [DE]** Geräte
- [ES]** Aparatos
- [FR]** Équipement
- [IT]** Attrezzature
- [PL]** Urządzenia
- [RU]** Оборудование

✉ gastroparts@gastroparts.com

☎ +48 56 657 00 66

📘 fb.com/gastroparts.global



GASTROPARTS.COM



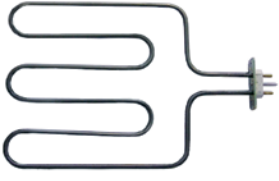

heating elements

heating elements for ovens

 <p>1</p>			
Part No.	415315	Ref. No.	4.013.03.06
description	heating element 2000W 230V heating circuits 1 L 327mm W 228mm L1 85mm L2 244mm W1 98mm W2 31mm flange length 71mm flange width 23mm hole distance 56mm hole ø M4mm tube ø 6.3mm connection plug-in connection windings 3 rectangular flange grill setting oven		
accessories for	415315		
		Part No.	550404 Ref. No. —
		power socket I-II phase 240V max. 16A countries I with screw connection for heating element	
		Part No.	550405 Ref. No. —
		power socket male faston 6.3mm for heating element 2-pole + earthing	

heating elements for griddles

 <p>1</p>			
Part No.	416491	Ref. No.	4.013.03.05
description	heating element 1500W 220V heating circuits 1 L 406mm W 70mm Hmm tube ø 8.5mm connection M4 connection distance 62mm dry heating element		

heating elements for chicken rotisseries

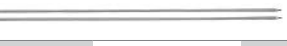
 <p>1</p>			
Part No.	416492	Ref. No.	4.013.03.02
description	heating element 1700W 230V L 780mm W 34mm heating circuits 1 connection M4 dry heating element tube ø 8.5mm connection length 21mm		
 <p>1</p>			
Part No.	418066	Ref. No.	4.013.03.01
description	heating element 2000W 230V L 980mm W 30mm dry heating element tube ø 8.5mm chicken rotisserie		

energy regulators

accessories

knobs

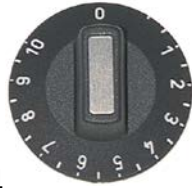
 <p>1</p>			
Part No.	110238	Ref. No.	4.013.02.06
description	knob energy regulator 1-10 t.max.°C°C ø 50mm shaft ø 6x4.6mm shaft flat upper black		

thermostats

control and safety thermostats

EGO

safety thermostats

55.13_ series

 <p>1</p>			
Part No.	375616	Ref. No.	4.011.03.03
description	safety thermostat capillary pipe isolatedmm gland nut probe		

 <p>1</p>			
Part No.	375619	Ref. No.	4.011.03.03
description	safety thermostat switch-off temp. 220°C 1-pole 1NO 16A probe ø 6mm probe L 77mm capillary pipe 830mm capillary pipe isolatedmm gland nut M9x1 probe		



55.32_ series



Part No.	375393	Ref. No.	4.011.03.03
description	safety thermostat switch-off temp. 235°C 3-pole 1CO/2NC 20A probe ø 6mm probe L 87mm capillary pipe 1790mm capillary pipe isolated 1710mm gland nut M9x1 probe SS		

switches and momentary switches

cam switches

4-position



Part No.	300023	Ref. No.	4.013.02.03
description	cam switch 4 operating positions 1NO/2CO sequence 0-1-2-3 16A shaft ø 6x4.6mm shaft L 23mm connection screw 4-position ceramic		

rotary switches

SONTHEIMER



Part No.	345388	Ref. No.	4.013.02.01
description	rotary switch 2 0-1 sets of contacts 2 600V 16A shaft ø 6x6mm shaft L 24mm type A2/12E/Z3/BG/X70S connection screw shaft square		



Part No.	345393	Ref. No.	4.013.02.02
description	rotary switch 3 0-1-2 sets of contacts 4 600V 16A shaft ø 6x6mm shaft L 23.5mm type GR22/12E/Z3/BG/X70S connection screw shaft square		

lamps

linear lamps

halogen lamps



Part No.	359620	Ref. No.	4.013.04.03
description	halogen lamp socket R7s L 117.6mm 230V 300W unjacketed IMPORT CE		

infrared lamps

with base type X lug



Part No.	359617	Ref. No.	4.013.04.01
description	infrared lamp 1000W 220V L 365mm lens L 340mm total length 480mm with mounting strap		

with base type Z ceramic



Part No.	359625	Ref. No.	4.013.04.02
description	infrared lamp socket Z-ceramic L 226mm 220-250V 500W cable length 195mm IMPORT		

sockets for linear lamps

R7s



Part No.	359648	Ref. No.	4.013.04.06
description	lamp socket socket R7s 250V ø 20mm H 32mm connection cable 320mm mounting distance 24/33mm holder length 42mm Qty 1 pcs		

X lug



Part No.	359710	Ref. No.	4.013.04.04
description	lamp socket L 70mm W 70mm H 49mm mounting distance 50mm bracket mounting		



Z ceramic



1

Part No.	359658	Ref. No.	4.013.04.07
description	lamp socket socket Z for length of lamp 218mm L 220mm W 47mm H 62mm mounting distance 120mm mounting thread M4 Qty 1 pcs		

condensators & interference suppression filters

operating capacitors

plastic



1

Part No.	365030	Ref. No.	12040MK 4.013.01.06
description	operating capacitor capacity 12µF 400V tolerance 5% 50/60Hz ambient temperature max. 40/85/21°C ø 35mm L 95mm M8 plastic connection male faston 6.3mm		

metal



1

Part No.	365002	Ref. No.	4.013.01.08
description	operating capacitor capacity 4µF 400V tolerance 5% 50/60Hz ambient temperature max. -25 to +85°C ø 30mm L 75mm with cable M8 aluminium connection cable 300mm MKP protection IP65		



1

Part No.	365004	Ref. No.	4.013.01.07
description	operating capacitor capacity 8µF 400V tolerance 5% 50/60Hz ambient temperature max. -25 to +85°C ø 30mm L 94mm M8 aluminium connection cable 300mm protection IP65		

gas taps

MADEC (MP)

with nozzle outlet



1

Part No.	101193	Ref. No.	4.011.02.02 4.011.02.03
description	gas tap MADEC with nozzle outlet (without nozzle) gas inlet M12x1 (tube ø 8mm) external nozzle ømm internal nozzle ømm bypass nozzle ø 0.35mm mixing pipe connection M17x1 thermocouple connection M8x1 front fixing M12x1 shaft ø 8x5mm shaft L 23/13.5mm shaft flat left		
spare parts for	101193		
	Part No.	100360	Ref. No. —
	bypass nozzle MADEC bore ø 0.35mm thread M4.5x0.6 total length 13mm		
	Part No.	101051	Ref. No. —
	magnet unit L 27mm D1 ø 12.5mm D2 ø 8.5mm suitable for JUNKERS/EGA/MADEC/SABAF standard		
	Part No.	101234	Ref. No. —
	union nut T1: M8x1 T2: M15		
accessories for	101193		
	Part No.	100936	Ref. No. —
	gas tap spindle shaft ø 5x8mm MADEC		
	Part No.	101277	Ref. No. —
	olive ID ø 8mm Qty 1 pcs		
	Part No.	101296	Ref. No. —
	union nut thread M12x1 for pipe ø 8mm		
	Part No.	101299	Ref. No. —
	nut thread M12x1		
	Part No.	101400	Ref. No. —
	air mixing tube thread M17x1 suitable for L350, L700		
	Part No.	110150	Ref. No. —
	knob gas tap without ignition flame t.max.°C ø 50mm shaft ø 8x5.5mm shaft flat right white		



with pipe outlet



1

Part No.	101072	Ref. No.	4.011.02.01
description	gas tap MADEC with pipe outlet gas inlet M12x1 (tube ø 8mm) bypass nozzle ø 0.35mm gas outlet M12x1 (tube ø 8mm) thermocouple connection M8x1 front fixing M12x1 shaft ø 8x5mm shaft L 29.5/13.5mm shaft flat left internal nozzle ø 0mm		
spare parts for	101072		
	Part No.	100360	Ref. No. —
	bypass nozzle MADEC bore ø 0.35mm thread M4.5x0.6 total length 13mm		
	Part No.	101051	Ref. No. —
	magnet unit L 27mm D1 ø 12.5mm D2 ø 8.5mm suitable for JUNKERS/EGA/MADEC/SABAF standard		
	Part No.	101234	Ref. No. —
	union nut T1: M8x1 T2: M15		
accessories for	101072		
	Part No.	100936	Ref. No. —
	gas tap spindle shaft ø 5x8mm MADEC		
	Part No.	101277	Ref. No. —
	olive ID ø 8mm Qty 1 pcs		
	Part No.	101296	Ref. No. —
	union nut thread M12x1 for pipe ø 8mm		
	Part No.	101299	Ref. No. —
	nut thread M12x1		
	Part No.	110149	Ref. No. —
	knob gas tap without ignition flame t.max.°C temperature range°C ø 50mm shaft ø 6x4.6mm shaft flat right black		
	Part No.	110153	Ref. No. —
	knob gas tap without ignition flame ø 50mm shaft ø 6x4.6mm shaft flat left white		

gas thermostats

SIT

710 Minisit series

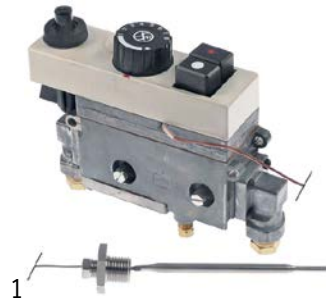

1

















Part No.	101385	Ref. No.	4.011.02.15
description	gas thermostat SIT type MINISIT 710 t.max. 200°C 60-200°C gas inlet 3/8" gas outlet 3/8" thermocouple connection M10x1 pilot connection M10x1 probe ø 5mm probe L 95mm capillary pipe 1050mm probe type type D2 pressure controller no pressure regulator mbar gland nut M14x1.5 ignition gas 4mm		
spare parts for	101385		
	Part No.	100809	Ref. No. —
	O-ring EPDM thickness 2mm ID ø 21mm Qty 1 pcs		
	Part No.	100904	Ref. No. —
	locking screw M10x1 for pipe ø 4mm Qty 1 pcs		
	Part No.	101054	Ref. No. —
	magnet unit T1: M10x1 T2: M24x1 L 45mm ø 17mm suitable for Minisit		
	Part No.	101136	Ref. No. —
	piezoelectric igniter suitable for Minisit with cover cap ømm connection F6.3x0.8		
	Part No.	101268	Ref. No. —
	gas connection thread 3/8" angled with O-ring MINISIT 710		
	Part No.	101273	Ref. No. —
	olive for pipe ø 12mm L 9.5mm brass Qty 1 pcs suitable for universal		
	Part No.	101276	Ref. No. —
	union screw thread 3/8" tube ø 12mm Qty 1 pcs		
	Part No.	102844	Ref. No. —
	probe 60-200°C probe ø 5mm probe L 98mm capillary pipe 1050mm t.max. 200°C fryer probe type type D2 suitable for MINISIT 710 gland nut M14x1.5		
accessories for	101385		
	Part No.	100905	Ref. No. —
	locking screw M10x1 for pipe ø 6mm Qty 1 pcs		
	Part No.	101054	Ref. No. —
	magnet unit T1: M10x1 T2: M24x1 L 45mm ø 17mm suitable for Minisit		
	Part No.	101137	Ref. No. —
	cover cap without piezoelectric igniter		
	Part No.	101267	Ref. No. —
	reducer IT 3/8" ET 1/2" L 21mm		

Table continues overleaf



accessories for		101385		
Part No.		101269	Ref. No.	—
	gas connection	thread 1/2" angled with O-ring	MINISIT 710	
Part No.		101270	Ref. No.	—
	screw connection	IT 3/8" ET 3/8" L 28mm		
Part No.		101272	Ref. No.	—
	screw connection	IT 1/2" ET 3/8" L 57mm		
Part No.		101274	Ref. No.	—
	olive	for pipe ø 16mm	Qty 1 pcs	
Part No.		101275	Ref. No.	—
	union screw	thread 1/2" for pipe ø 16mm	Qty 1 pcs	

ignition parts

pilot burners

SIT

160 series

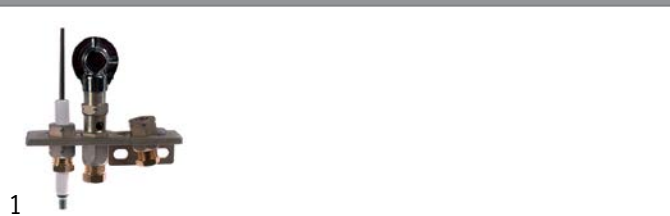

1	Part No.	106270	Ref. No.	N/A
	description	pilot burner SIT type 160 series 2 flames LPG nozzle ø 0.3mm gas connection 4mm code 30		



1	Part No.	106279	Ref. No.	4.011.03.42
	description	pilot burner SIT type 160 series 2 flames nozzle ø 0.3mm gas connection 4mm		



1	Part No.	106269	Ref. No.	4.011.03.02
	description	pilot burner SIT type 160 series 3 flames LPG nozzle ø 0.3mm gas connection 4mm code 30		

piezoelectric igniters

mounting diameter 22mm



1	Part No.	100008	Ref. No.	4.011.03.01
	description	piezoelectric igniter body plastic blowing mounting ø 22mm connection ø2mm cable lengthmm		

thermocouples

threaded thermocouples

threaded thermocouples standard

with socket with thread M8x1

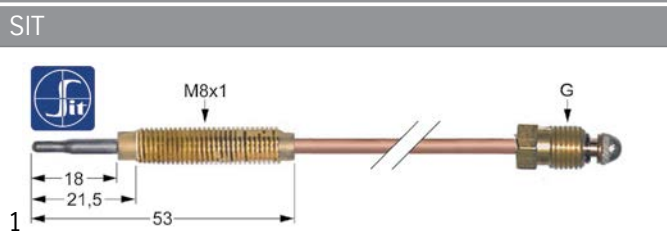

1	Part No.	107627	Ref. No.	4.011.03.04
	description	thermocouple SIT M8x1 L 220mm M8x1		

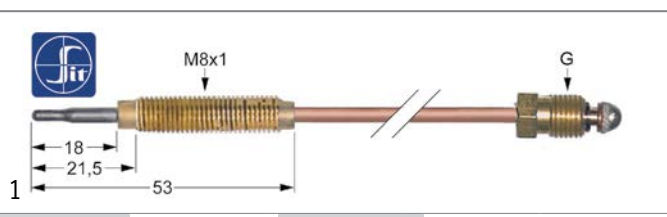

1	Part No.	107629	Ref. No.	4.011.03.05
	description	thermocouple SIT M8x1 L 450mm M8x1		

	accessories for	107629		
	Part No.	102067	Ref. No.	—
		nut thread M8x1 H 3mm brass Qty 1 pcs type SEF 1		

gas burners

ceramic burners

accessories

burner grids

1	Part No.	105897	Ref. No.	3.011.01.35
	description	burner grid L 900mm W 70mm for chicken rotisserie		
	For models:	MÜNCHEN		



ceramic plates

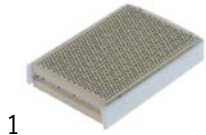

1

Part No.	105895	Ref. No.	3.011.01.42
description	ceramic plate L 69mm W 49mm H 13mm with 3-sided sealing strip		



1

Part No.	105896	Ref. No.	3.011.01.42
description	ceramic plate L 69mm W 49mm H 13mm with sealing strip lateral		
For models:	MÜNCHEN		

ring burners



1

Part No.	105246	Ref. No.	3.011.01.45
description	ring burner L 355mm W 150mm		



1

Part No.	105245	Ref. No.	3.011.01.44
description	ring burner L 505mm W 115mm		

knobs

universal knobs

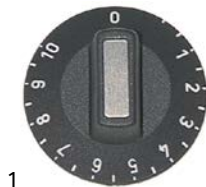

1

Part No.	110238	Ref. No.	4.013.02.06
description	knob energy regulator 1-10 t.max.°C ø 50mm shaft ø 6x4.6mm shaft flat upper black		

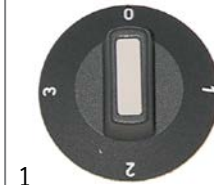

1

Part No.	110232	Ref. No.	4.013.02.04
description	knob switch 4-position t.max.°C ø 50mm shaft ø 6x4.6mm shaft flat upper black		

producer-specific knobs

KSF

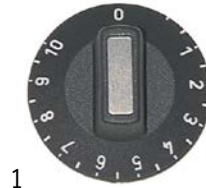

1

Part No.	110238	Ref. No.	4.013.02.06
description	knob energy regulator 1-10 t.max.°C ø 50mm shaft ø 6x4.6mm shaft flat upper black		



1

Part No.	110152	Ref. No.	4.011.02.06
description	knob gas tap without ignition flame ø 50mm shaft ø 8x5mm shaft flat left		



1

Part No.	110737	Ref. No.	3.011.02.14
description	knob gas tap without ignition flame t.max.°C ø 53mm shaft ø 8x5.5mm black		

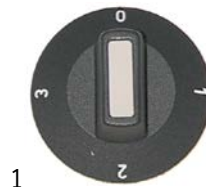

1

Part No.	110232	Ref. No.	4.013.02.04
description	knob switch 4-position t.max.°C ø 50mm shaft ø 6x4.6mm shaft flat upper black		

GASTROPARTS.COM

